



U.S. Department
of Transportation

**Federal Aviation
Administration**

Office of Systems
Engineering Management
Washington, D.C. 20591

The AERA Concept

DISTRIBUTION STATEMENT A
Approved for Public Release
Distribution Unlimited

19990701 102

March 1981

Report No. FAA-EM-81-3

This document is available to the
U.S. public through the
National Technical Information Service,
Springfield, Virginia 22161

Lawrence Goldmuntz
John T. Kefaliotis
Louis A. Kleiman
Richard A. Rucker
Leonard Schuchman
Delbert Weathers

1. Report No. FAA-EM-81-3		2. Government Accession No.		3. Recipient's Catalog No.	
4. Title and Subtitle Automated En-Route Air Traffic Control (AERA) Concept				5. Report Date March 24, 1981	
				6. Performing Organization Code AEM-200	
7. Author(s) Lawrence Goldmuntz, John T. Kefaliotis, D. Weathers, Louis A. Kleiman, Richard A. Rucker, Leonard Schuchman				8. Performing Organization Report No. FAA-EM-81-3	
9. Performing Organization Name and Address Office of Systems Engineering Management Department of Transportation Federal Aviation Administration 800 Independence Ave., Washington, D.C. 20591				10. Work Unit No. (TRAIS)	
				11. Contract or Grant No.	
12. Sponsoring Agency Name and Address Same as #11 above				13. Type of Report and Period Covered	
				14. Sponsoring Agency Code AEM	
15. Supplementary Notes					
16. Abstract An Air Traffic Control (ATC) system can be developed to provide fuel-efficient routings routinely, to increase controller productivity, and to reduce system errors. The following concept document describes a system called AERA, that is an evolutionary extrapolation of the many techniques that FAA has pioneered during the past decade, such as conflict alert, en route metering, Automatic Traffic Advisory and Resolution Service (ATARS), Discrete Address Beacon System (DABS), trajectory modeling and planning algorithms, and electronic tabular displays (ETABS). This concept document was prepared by a team of ATC experts to review prior work, the on-going AERA program, and to define a total AERA concept. The review team has concluded that the concept is feasible, the degree of automation implied can be achieved with state of the art equipment, that the system can be designed so that no aircraft would be placed in hazard by system failures, and finally, that AERA has benefits that are substantially larger than its costs.					
17. Key Words Automation, Air Traffic Control, Automated Decision Making, En-Route Traffic Control, Automated En-Route Air Traffic Control, Artificial Intelligence			18. Distribution Statement Document is available to the U. S. public through the National Technical Information Service, Springfield, VA 22161		
19. Security Classif. (of this report) UNCLASSIFIED		20. Security Classif. (of this page) UNCLASSIFIED		21. No. of Pages	22. Price

TABLE OF CONTENTS

	<u>Page</u>
1.0 Introduction	1
2.0 The Need for AERA	9
3.0 AERA System Description	16
3.1 The Air Traffic Control System, Now and in AERA	18
3.1.1 Pre-Flight and In-Flight Planning	19
3.1.2 Traffic Flow Management	22
3.1.3 Traffic Separation and Advisory Services	29
3.2 AERA System Elements, Boundaries and Data Exchanges	32
3.2.1 Air Traffic Control Centers, AERA Computer Systems and Inter-Facility Interfaces	32
3.2.2 IFR Clearances	36
3.2.3 Pilots, Controllers and Man-Machine Interfaces	37
3.2.4 AERA Planning Regions	42
3.2.5 AERA Control Regions	43
3.2.6 AERA Control Sectors	43
3.2.7 Flight Data and Control Coordination Across Boundaries	44
3.3 ATC Functions That Involve AERA	44
3.3.1 Inputs to AERA	46
3.3.1.1 Air-to-Ground Communications	46
3.3.1.2 Other On-Line Data Inputs	47
3.3.2 AERA Functions	49
3.3.2.1 Surveillance Data Inputs Processing	49
3.3.2.2 Flight Data Inputs Processing	51
3.3.2.3 Flight Trajectories Modeling	51
3.3.2.4 Association Checking	55
3.3.2.5 Conflicts and Delays Prediction	60
3.3.2.6 Strategic Planning of Conflict Resolutions and Delay Absorptions	63
3.3.2.7 Tactical Execution of Plan	67
3.3.2.8 Separation Assurance and Obstacle Avoidance Monitoring	69

TABLE OF CONTENTS

(Continued)

	<u>Page</u>
3.3.3 AERA Outputs	70
3.3.3.1 Ground-to-Air Communications	70
3.3.3.2 Other On-Line Data Outputs	71
3.3.3.3 Capacity, Demand and Performance Monitoring	72
4.0 AERA System Integrity	74
4.1 General Model of AERA Recovery Process	76
4.2 Approaches to Achieving Reliability Within AERA	78
4.2.1 Appropriate Design Concepts	78
4.3 Perturbation or Failure Modes and Recovery Concepts	81
4.3.1 Total Loss of an ARTCC	81
4.3.2 Loss of AERA Capability at the ARTCC	88
4.3.3 Loss of Communications/Surveillance at an AERA Equipped ARTCC	92
4.3.4 Loss of Some AERA Functions	93
4.3.5 Single Aircraft Perturbations to AERA Planning	94
4.3.5.1 In-Flight Failures and Emergencies	94
4.3.5.2 Excessive Deviations from Planned Profiles	95
4.3.6 Gross Perturbations to AERA Planning	96
4.3.6.1 Severe Weather Avoidance	98
4.3.6.2 Airport Closures and Other Flow Restrictions	99
5.0 AERA and Airspace	101
6.0 The Controller and AERA	110
6.1 General Controller Responsibilities	111

TABLE OF CONTENTS

(Continued)

	<u>Page</u>
6.2 Controller Requirements Within AERA Assigned Airspace	112
6.2.1 Communications	112
6.2.2 Finding Efficient Solutions	113
6.2.3 Non-Routine Operations	113
6.2.4 Unresolved Conflicts	114
6.2.5 Weather	114
6.2.6 Holding	116
6.2.7 AERA Supervisory Functions	116
6.3 Controller Interaction	116
6.3.1 Levels of Interaction	117
6.3.2 AERA Displays	118
7.0 AERA and Aircrew	121
8.0 Telecommunication Requirements for AERA	123
8.1 AERA Ground-Ground Communication Requirements	124
8.2 Ground-Air-Ground Requirements	126

TABLE OF CONTENTS

(Continued)

	<u>Page</u>
<u>APPENDICES</u>	
APPENDIX 1	
"An Incremental Approach to AERA Implementation"	129
APPENDIX 2	
"ARTCC/TRACON Interactions in the Current ATC System"	132
APPENDIX 3	
"Fuel Efficiency Considerations in Absorbing Landing Delays"	135
APPENDIX 4	
"Strategic Conflict Prediction in AERA"	144
APPENDIX 5	
"Strategic Delay Prediction in AERA"	152
APPENDIX 6	
"AERA Computer System Reliability"	161
APPENDIX 7	
"Additional Computing Resources Required to Handle Gross Perturbations"	165

TABLE OF CONTENTS

(Continued)

Page

FIGURES

1-1	Major AERA Function	4
2-1	Reducing Operating Costs for Airspace Users	10
2-2	IFR Aircraft Handled by FAA Air Route Traffic Control Centers	12
2-3	The Potential Costs of Doing Nothing More Which Increases En Route Controller Productivity	14
3-1	Traffic Flow Management Illustrated	24
3-2	Major Traffic Flow Management Functions and Interface	27
3-3	En Route Low Altitude ARTCC Boundaries	33
3-4	Assumed Inter-Facility Interfaces in AERA	35
3-5	Man-Machine and Air-Ground Communications Assumed in AERA	38
3-6	Flight Data and Control Coordination Across Boundaries	45
3-7	Major AERA Functions and Interfaces	50
3-8	Horizontal Profile	53
3-9	Vertical Profile	54
3-10	Association Checking	56
3-11	AERA Strategic Planning Functions and Interfaces	57
3-12	Automated Tactical Execution and Separation Assurance	68
4-1	Generalized AERA Planning Region State Cycle	77
4-2	Options of ATC En Route Service for Backup Operations	89
4-3	Options for Several Levels of Backup Protection	90

TABLE OF CONTENTS

(Continued)

	<u>Page</u>
5-1 Desired Versus Available Altitudes for La Guardia to National Flights	103
5-2 Conflict Probe Concept	104
A3-1 Fuel Consumption Per Mile in Cruise at Different Altitudes	136
A3-2 Fuel Consumption per Minute in Cruise at Different Altitudes	137
A3-3 Standard Airspeed Schedules Versus Altitude and Indicated Airspeed	138
A3-4 Speed Controllability in Seconds per Mile at Different Altitudes	140
A3-5 Fuel Consumption at Maximum Endurance and Different Altitudes	142
A4-1 Conflict Prediction in AERA	146
A4-2 Generalized Conflict Box	150
A5-1 Increase in Time Delay (Above Average Delays) Due to a Loss in Runway Throughput as a Function of Demand	157

TABLES

2-1 Frequencies of Probable Causes	15
3-1 Possible ATC Data Message Generation and Delivery Techniques	39
3-2 Possible ATC Data Message Class/Type	41

PREFACE

An Air Traffic Control (ATC) system can be developed to provide fuel-efficient routings routinely, to increase controller productivity and to reduce system errors. This system, called AERA, is described in this document. The concept document describes a system that is an evolutionary extrapolation of the many techniques that FAA has pioneered during the past decade, such as conflict alert, en route metering, Automatic Traffic Advisory and Resolution Service (ATARS), Discrete Address Beacon System (DABS), trajectory modeling and planning algorithms, and electronic tabular displays (ETABS).

This concept document was prepared by a team of ATC experts to review prior work, the on-going AERA program and to define a total AERA concept. The review team has concluded that the concept is feasible, the degree of automation implied can be achieved with state of the art equipment, that the system can be designed so that no aircraft would be placed in hazard by system failures, and finally, that AERA has benefits that are substantially larger than its costs.

The team of experts that authored this document have been reassembled to assist in developing a plan and associated evolution strategy for the AERA program.

AERA CONCEPT DESCRIPTION

1.0 Introduction

This document is a concept description of AERA,* an advanced air traffic control system, currently under development, that reduces controller workload by automatically performing routine aircraft separation, traffic flow, and clearance generation, delivery and acknowledgment functions. Reductions in controller workload and the capability of a computer to detect and resolve multi-dimensional potential conflicts permit a substantial relaxation in procedural limitations to the use of airspace. This, in turn, permits the widespread use of fuel efficient profiles and direct routings while substantially decreasing controller workload. System errors will probably be reduced when controllers are relieved of routine functions. Thus, AERA should improve productivity and safety for both the users and operators of the system.

AERA should limit procedural restraints on the use of airspace to isolated traffic "hot spots" incapable of reliable algorithmic conflict resolution. The freer movement of traffic should not burden the controller, because AERA plans and monitors the three dimensional flow of traffic automatically over a planning region that incorporates a number of sectors, and in a conflict-free and metered manner. It is, therefore, not necessary for the controller to visualize an entire complex traffic flow, and then plan, implement and monitor efficient conflict resolutions. The controller's productivity is increased because routine functions, such as the transmission and acknowledgement of clearances, are mechanized. Furthermore, AERA reduces the number of sectors required so that the number of transfers of control responsibility will decrease.

*AERA was historically an acronym for Automated En Route Air Traffic Control, but its productivity and safety advantages are more important attributes than its degree of automation; and furthermore, AERA is applicable to some portions of terminal airspace. Therefore, AERA is used as a noun rather than an acronym in this concept description.

However, the controller can intervene and evaluate the quality of service at any point in the ATC process, reviewing planned traffic flows, metering, conflict resolution, clearance generation or individual aircraft performance. The controller is the manager of AERA, evaluating situations best resolved by human judgment and utilizing AERA's algorithms to accomplish routine tasks. Despite the use of DABS data link and Voice Response Systems (VRS) to transmit and acknowledge clearances whenever possible, controllers will be available at all times to negotiate clearances with aircrews needing or desiring service.

FAA has developed a great variety of computer-driven aids for the controller over the past two decades. Some significant examples are flight plan processing, automatic altitude reporting and display, minimum safe altitude warning and conflict alert. Algorithms are now being developed for DABS/ATARS, as well as for NAS Stage A and ARTS, to provide controllers and aircrews with conflict resolution advisories. AERA accomplishes its goals by applying and extending these currently available computer aids.

AERA will accept, in most instances, an aircrew's requested flight profile, the altitude/speed trajectory that is usually selected to minimize fuel burn. Alternatively, AERA's algorithms have been developed to accept user-filed "horizontal" flight plans, and to associate a trajectory with that flight plan, taking into account aircraft type, gross weight and winds aloft. Computer projections of flight plans over 10 to 30 minutes, can reveal potential separation violations. Conflict resolution algorithms are being developed to resolve potential separation violations. These conflict resolutions are generated in such a way as to minimize deviation from the desired flight plan. Flow control limitations on delivery rates to adjoining regions or airports can be provided by apportioning delays to aircraft in the AERA planning region and, when necessary, by limiting incoming flow to the planning region. Algorithms can be developed to translate the flow control limitations into flight plan revisions and instructions to neighboring regions in order

to limit flows as required. The conflict resolution algorithms and delay apportionment algorithms can be developed in such a way as to mutually satisfy each requirement. The simultaneous and interactive solution of the conflict resolution and delay apportionment algorithms can be accomplished using available computer technology and in a time much less than aircraft transit time through the planning region. An AERA functional block diagram is shown in Figure 1-1.

A single aircraft's deviation from expected performance, may require changes to the flight clearances of other aircraft in the planning region. These can be calculated and transmitted, if necessary. Gross perturbations to the planned flow, due to changes in airport capacity, severe weather or navigation equipment outage will be processed to modify the flight plans of all affected aircraft in such a way as to cause minimum deviation and fuel consumption and so that all potential conflicts remain resolved and all needed delays are incorporated in the modified flight plans.

AERA relieves the controller and air crew from routine tasks that lead, however infrequently, to system errors. But the mechanization of these tasks cannot extend to complex situations that are difficult to handle algorithmically and are best left to man's judgment. Furthermore, neither the aircrew nor controller can be put into a situation beyond their capability, even in the case of massive system failures. In case of a partial or total center failure, traffic flow will be caused to diminish automatically to rates and densities such that separation can be assured by controllers aided by whatever resources remain. This could be accomplished by continuously generating and then transmitting and storing backup clearances in neighboring centers, DABS sites, RCAGs and TRACONS as appropriate, for transmission to aircraft should a center fail. Traffic in this reduced mode could be handled from adjoining centers, or TRACONS and towers, if this should be necessary. In fact, there will probably be better protection against system failure in AERA than at present, because it is dealt with as an integral part of the system design.

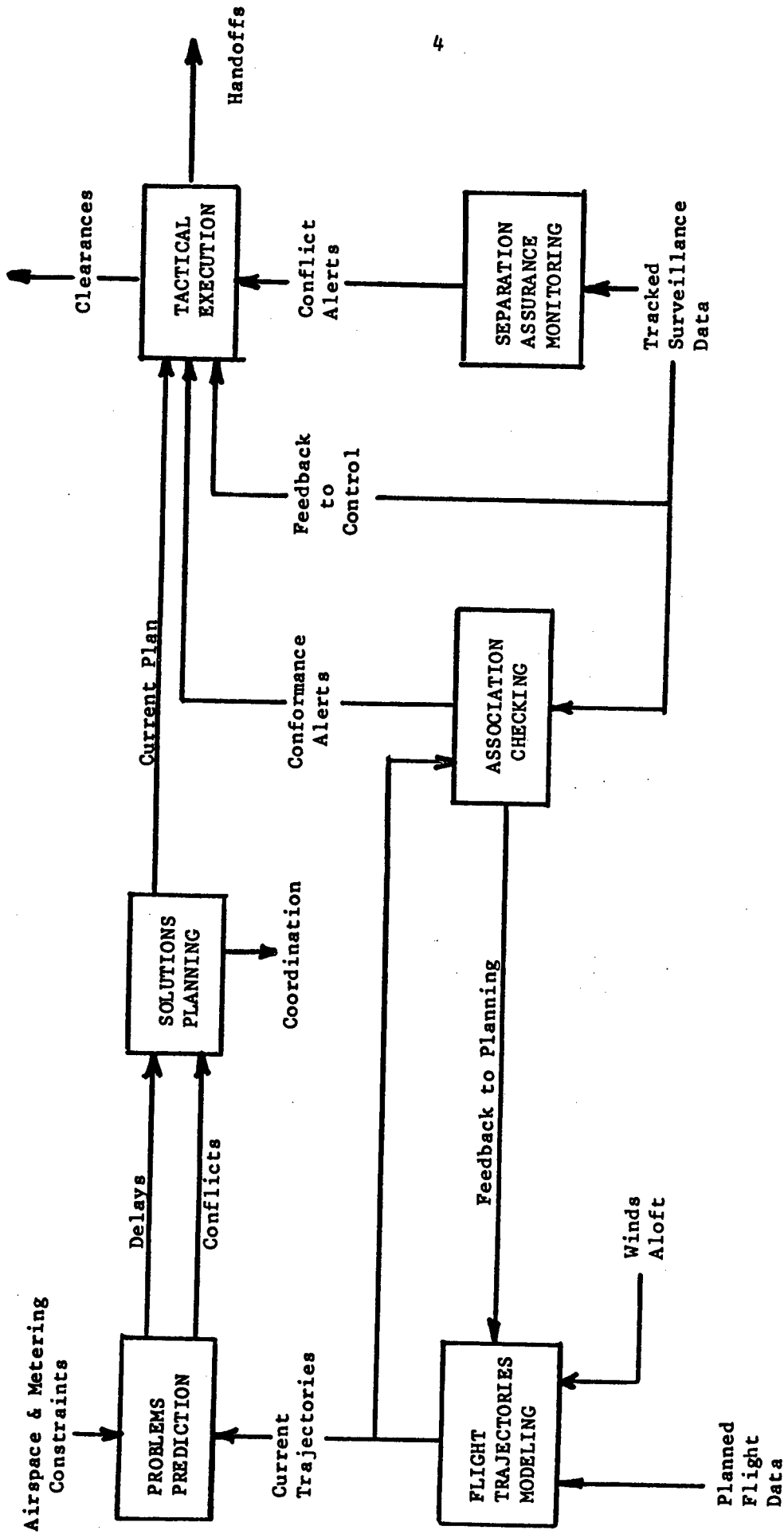

Figure 1-1
Major AERA Functions

Both the users and operators of the air traffic control system would benefit from these improvements. The users would obtain fuel conservative direct routings and profiles. The operators would be able to provide improved services and accommodate additional traffic without any increase in manpower. These improvements in productivity and service level should be attainable with an improvement in safety.

The AERA control process should be applicable to en route and portions of terminal airspace. It requires no special avionics equipment, although AERA productivity and the quality of service it can provide, would be dramatically improved as aircraft become equipped with the Discrete Address Beacon System (DABS), Area Navigation (RNAV) capability, and a Flight Management System.

The development of AERA requires major efforts in system design and software and man-machine interface development. The testing of AERA in a simulator and in a real traffic environment are also considerable efforts. The needed hardware is within the state of the art. Special configurations of current production hardware are needed to meet reliability and failure mode requirements. The 9020R program, to replace current en route computers, should be designed to accept the AERA system, with only minor augmentations. AERA imposes no special requirements on the nature of ATC communication, surveillance and navigation systems and can be designed to interface with those systems currently implemented or which are now being procured.

Full AERA involves flight plan optimization over a number of sectors using wind, weather and aircraft data with little need for procedural restrictions; it can accept flow control directives to meter traffic in a fuel-conservative way; it can generate and transmit flow control requirements to contiguous control facilities or the national flow control system; it can detect potential conflicts and resolve them without major disturbance of desirable flight plans; it can automatically generate,

transmit and accept acknowledgement of conflict-free clearances; it can automatically monitor flight performance to assess the need for revised clearances; it can provide interfaces for controllers at the planning, clearance generation or individual aircraft monitoring levels of ATC; it can be so designed that, in case of failure, it can be recovered by controllers, even under substantial traffic flows. The implementation of full AERA is predicated on the replacement of current en route computers since they do not have the capacity to handle all these functions. But significant elements of AERA would be useful in the current NAS system and could be mechanized in augmentation processors attached to the current NAS system.

For example, in today's ATC system, there are procedural restrictions that keep aircraft at inefficient low altitudes or on circuitous routings. These procedures are prearranged among ATC facilities to ensure that potentially conflicting traffic flows will always be separated, either laterally or vertically, after allowing for a range of individual deviations. Since the flows are separated, limited deviations need not be dealt with and individual clearances need not be coordinated with other ATC sectors or facilities. Since the limiting factor which leads to the imposition of procedural restrictions is the controller's capacity to coordinate clearances -- and not airspace saturation with aircraft -- a more automated process for coordinating individual flight clearances should greatly reduce the need for rigid flow restrictions.

For example, in the case of a specific procedurally restricted altitude on an airway in the Northeast, a potential conflict with higher altitude overflights, if there were unrestricted flows between the two streams of traffic, would occur only one percent of the time (see Chapter 5 for details). The conflict detection and resolution algorithms of AERA might well provide useful coordination information to the controllers in these sectors to enable them to safely handle the interactions between these two streams of traffic. Many features of AERA are not needed for

this limited capability, features such as metering, automatic generation and transmission of clearances and full failure mode attributes. The few needed features of full AERA might be incorporated in an augmentation processor to NAS Stage A.

Another early application of AERA attributes might be to provide some NAS Stage A sector controllers with a partial AERA system that would incorporate optimum flight profile generation, conflict prediction and resolution, delay absorption and clearance generation, but that would not include automatic clearance transmission and acknowledgement nor the failure modes required in the full AERA. The controller would still have final authority to issue clearances, but he would have a substantial planning and control aid provided by AERA. The purpose of such an application would be to provide certain incremental controller productivity improvements and fuel efficiency for users.

There are other possibilities for interim "products" to spin-off from the full AERA program. The development of AERA interim "products" is appropriate, not only because of the useful service they can provide before the en route computers can be replaced, but also because they provide feedback to the design of the full AERA, and they provide for the evolutionary incorporation of AERA features into the ATC system. The development and implementation of AERA interim "products" should not compromise the development of full AERA. An expanded discussion of interim AERA products is contained in Appendix 1, "An Incremental Approach to AERA Implementation."

This concept document describes the need for AERA, the AERA features that satisfy these needs, AERA's impact on the utilization of airspace and its organization, the interaction between AERA and the controller and the air crew, the impact of AERA on communications, the failure mode requirements on AERA and the techniques for meeting these requirements.

REFERENCES

- 1/ Controller Productivity in the Upgraded Third Generation ATC System:
Part I: Automation in the Pre-Data Link Era, July 1976 (MTR-7212);
Part II: Automation in the Data Link Era, August 1976 (MTR-7319)
Fesial S. Keblawi, The MITRE Corporation, McLean, Virginia.
- 2/ Controller Productivity Study, R. A. Rucker, R. D. Porlow, P. R. Sterfels, D. S. Meyer, The MITRE Corporation, McLean, Virginia, November 1971, (MTR 6110).

2.0 The Need for AERA

The requirement for AERA flows from the following needs:

- To reduce operating costs to airspace users by permitting direct, fuel-efficient profiles.
- To reduce operating costs to the U.S. government by increasing ATC specialist productivity.
- To accommodate the growing number of IFR flights with minimum additional cost.
- To increase flight safety by reducing system errors through an improved ATC system.

Even seemingly minor reductions in fuel consumption due to direct fuel-efficient profiles have major impacts on airline profitability as can be seen from Figure 2-1, where it is shown that a 3 percent saving in fuel consumption is reflected into a potential 30 percent improvement in airline profitability.

It is shown in Section 5 of this document, that AERA techniques can be used to aid in removing a procedural limitation to the use of fuel conservative altitudes in a portion of the New York ARTCC. Aircraft, until recently, were limited to 16,000-17,000 feet on the New York to Washington route, as compared to the desired altitudes of 24,000-26,000 feet. This caused a fuel penalty of 7 to 8 percent. A recent procedural change, permitting these aircraft to attain 20,000-21,000 feet, reduces the penalty to approximately 3 percent. But procedural separation still requires La Guardia to Washington traffic to be delivered to the Ensee fix north of National and requires Kennedy to Washington traffic to be

REDUCING OPERATING COSTS FOR AIRSPACE USERS

Fuel Costs Dominate Direct Operating Costs:

Using 3rd Quarter 1979 Direct Operating Costs Data for Wide-Bodied Aircraft and a Typical Carrier's Per Cent Indirect Operating Costs and Per Cent Profit Margin:

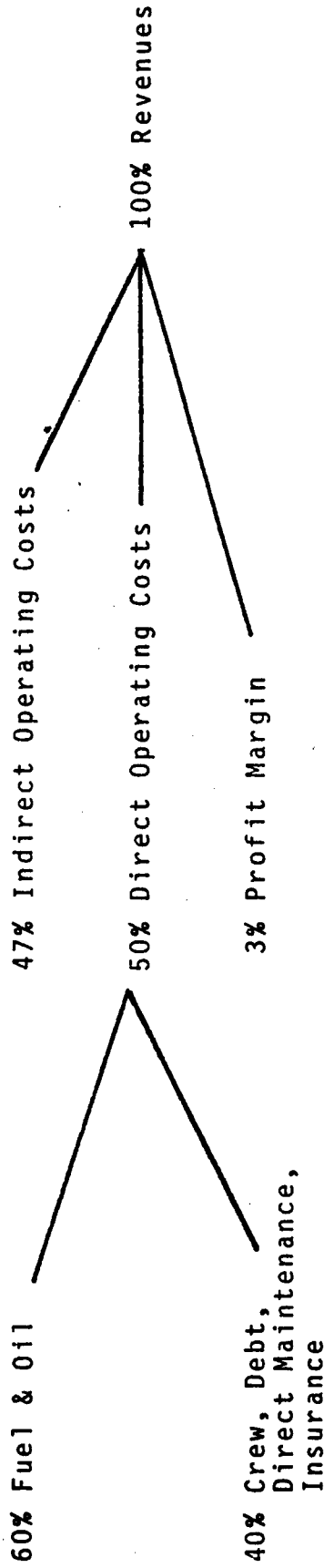

Assume a 3% Savings in Fuel, Then:

$$3\% \times 60\% \times 50\% = 0.9\% \text{ Savings in Revenues}$$

$$0.9\% \text{ Savings Added to Profits} = \frac{0.9\%}{3\%} = 30\% \text{ Increase in Profits}$$

Figure 2-1

delivered to Nottingham south of National, whether the airport is operating to the north or south. Due to this, and other factors, during off-peak hours on weekends the New York to Washington flight takes approximately 45 minutes due to fairly direct routing, while normally it takes 60 minutes in the absence of runway queuing.

Thus, altitude and route procedural limitations can cause substantial fuel penalties compared to optimum routings particularly on short stage lengths. Using optimum routings during periods of light traffic, flight times that are achieved are frequently significantly better than the published schedules. Of course, schedules are based on procedurally restricted routings that are used during periods of "normal" traffic and adverse wind conditions.

This phenomena occurs in many hub areas. Based on an understanding of the amount of traffic serving major hubs, on the specific procedural factors identified above, 3 percent seems a reasonable estimate of the national fuel savings that might be achieved using AERA techniques. This is obviously an estimate that needs refining.

The domestic airline fuel bill was approximately \$6 billion in 1979. It is expected to be 35 percent greater in 1980. Assuming a 3 percent saving in fuel due to AERA, there would be a \$250 million saving in 1980. The present value of such a saving is approximately \$2.75 billion at a 10 percent discount rate.*

IFR traffic is expected to grow over the next decade by 62 percent, with the greatest growth concentrated in general aviation and air taxis as shown in Figure 2-2. Without any changes in the way traffic is handled, this would imply about a 60 percent increase in work force, since it does not seem that additional NAS Stage A productivity improvements are available.

*In this concept paper, present values are determined on the assumption that there is an instantaneous step function implementation and that the discounted stream of benefits persists into the future. Thus, the present value is the annual benefit times the factor $(1 + i)/i$ where i is the discount rate. Obviously implementation rates extend over a period of time and the resulting benefits build up gradually. It would be highly conjectural to predict an implementation schedule and the schedule of resulting benefits at this time. Reasonable assumptions on implementation schedules do not change significantly the present value benefit/cost ratios resulting from a step function implementation and benefit schedule.

IFR Aircraft Handled by FAA Air Route Traffic Control Centers, Fiscal Years 1973 - 1990

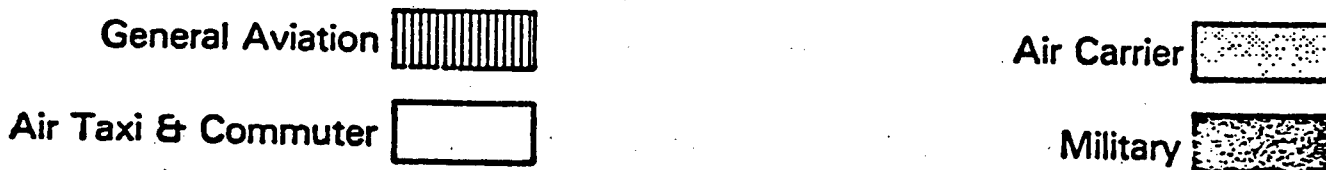
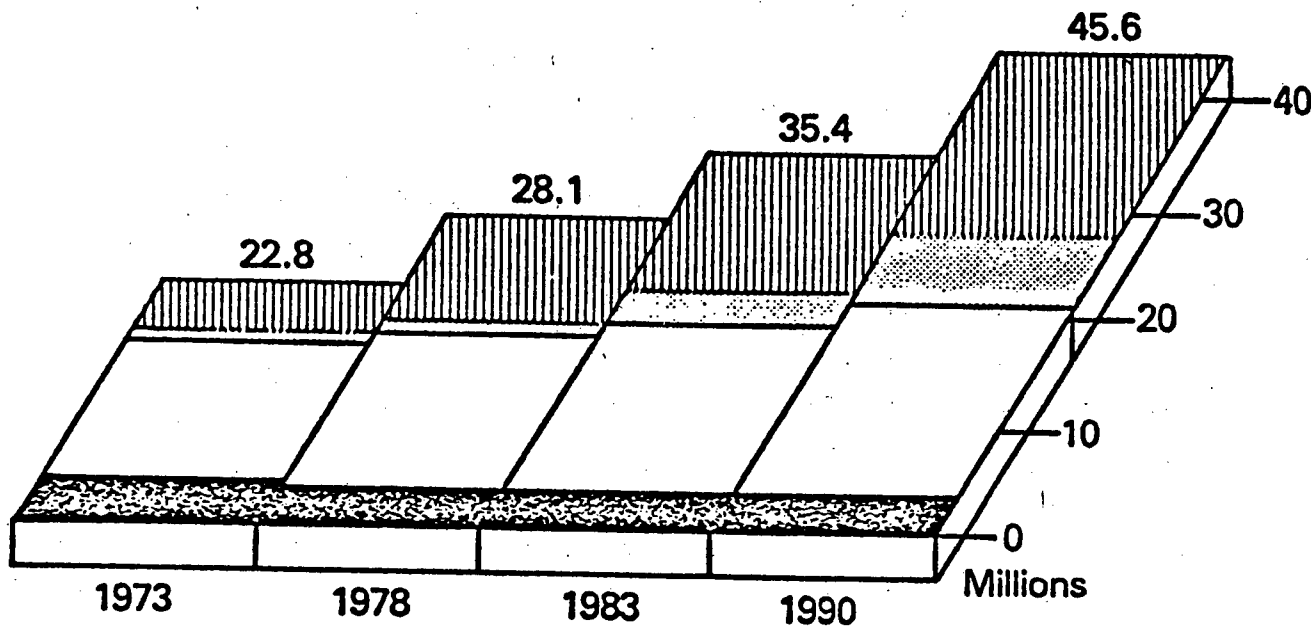

	FY 1978 Status (Growth)	FY 1978 — 90 Forecast (Total Growth)
General Aviation	19%	120%
Air Taxi	19%	205%
Air Carrier	5%	28%
Military	0%	0%
Total	8%	62%

**Source: Detailed forecast of "IFR Aircraft Handled"
(Report No: FAA-AVP 79-1)**

Figure 2-2

During the last decade, controller productivity improved by approximately 30 percent, according to Figure 2-3, due presumably to the relatively minor computer aids provided by NAS Stage A. Based on various analyses^{1, 2/} one would expect at least a 100 percent improvement in controller productivity from full AERA, beyond the improvements provided by NAS Stage A. Thus the productivity improvement of AERA should more than offset the additional workload due to forecasted traffic growth. The annual value of the AERA productivity improvement, including handling the forecasted traffic growth, is approximately \$300 million at 1979 costs. This benefit is derived by increasing the \$375 million annual expense (1979) to operate 25 ARTCCS (See Figure 2-3) by 1.6, to account for the increase in traffic, and taking 50 percent of this as the benefit due to AERA productivity. The present value of such a saving is approximately \$3.3 billion at a 10 percent discount rate. Therefore, the present value of the fuel saving and control productivity improvement due to AERA is estimated to be \$6 billion.

Verified Air Traffic Control System errors have been occurring at an average rate of 1.5 per day. A system error is a violation of separation standards caused by an ATC mistake. Over 50 percent of these errors fall into four categories: coordination, inattention, communication and poor judgment, as can be seen from Table 2-1. Coordination includes the failure to coordinate an action with the next controller before handoff or use of another controller's airspace. Poor judgment includes the inability to predict conflicts between converging aircraft of different speeds, under or over estimating climb performance, inability to predict high speed military aircraft turn performance. Approximately one-half of these system errors occur in en route airspace and two-thirds in en route and TRACON airspace. These system errors are precisely the kind of mistake that AERA is designed to overcome and they are occurring in the airspace AERA is designed to serve. There is no reliable way to estimate the monetary value of the improved safety that AERA should provide.

Thus, AERA should help improve safety and save substantial costs to the operators and users of the ATC system.

THE POTENTIAL COSTS OF DOING NOTHING MORE WHICH INCREASES EN ROUTE CONTROLLER PRODUCTIVITY

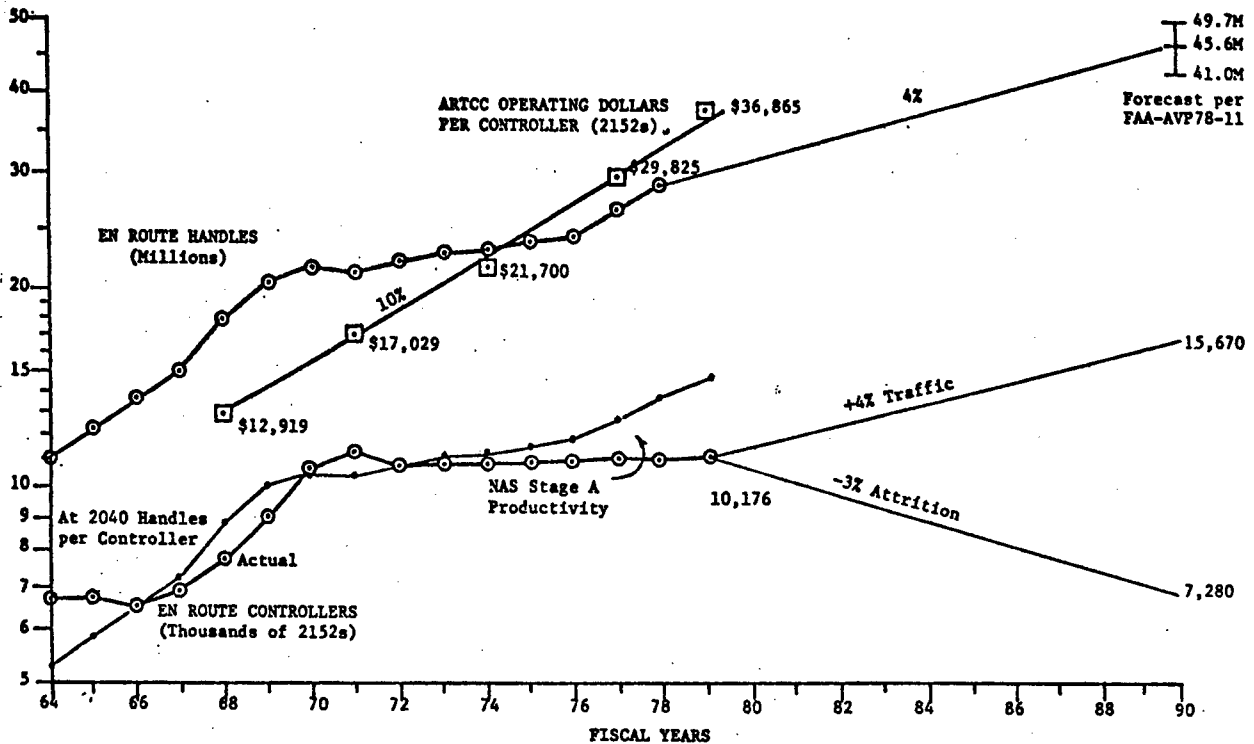

EST. FY79 BUDGET TO OPERATE 25 ARTCCs = \$375,139,000
 10,176 AIR TRAFFIC CONTROL SPECIALISTS (2152s) = \$36,865

5473 (54%) Full Performance Controllers
 2597 (25%) Developmental
 112 (1%) Trainees
 1994 (20%) Supervisors, DSS, EPDS, Area, Military Liaison
 10,176 as of Aug. 79

Includes Salary + Benefits:
 • Premium Pay Differentials
 • Gov't Matching of Contributions (Ins, Retire)
 • Change of Station Allowances
 • Some FICA + Employee Awards

Figure 2-3

Table 2-1

Frequencies of Probable Causes
Number of SE's with Causes Given 297

<u>Category</u>	<u>Frequency</u>	<u>Percent of Causes</u>	<u>Category Name</u>
1	55	18.52%	Coordination
2	30	10.10%	Inattention
3	39	13.13%	Communication
4	15	5.05%	Lack of ATC instructions
5	16	5.39%	Delayed ATC instructions
6	14	4.71%	Insufficient ATC instructions
7	39	13.13%	Judgment
8	17	5.72%	Forgetting
9	7	2.36%	Flight strip data
10	7	2.36%	Handoff
11	8	2.69%	Workload
12	4	1.35%	Transponder
13	1	0.34%	Speed restriction
14	12	4.04%	System hardware
15	8	2.69%	Pilot deviation
16	4	1.35%	Relief briefing
17	1	0.34%	Clearance to wrong aircraft
18	5	1.68%	Bad entry to computer
19	9	3.03%	Aircraft identification confused
20	1	0.34%	Controller didn't recognize emergency
21	3	1.01%	Inadvertant data information given
22	1	0.34%	Oceanic miscalculation
23	1	0.34%	Training
24	0	0.00%	Track coasting
25	0	0.00%	Military facility deviation

Source: FAA Aircraft Separation Assurance Studies and Briefings, 1978.

3.0 AERA System Description

The purpose of this section is to describe the concepts and overall functional design of the AERA system. It points out where the system design has roots in ideas proven by current ATC system design and procedures, or where it goes beyond tested and proven concepts.

The AERA system can provide most of the ATC services of an Air Route Traffic Control Center (ARTCC) in a safer and more productive manner than the current system. The design concepts are being applied initially to positively controlled en route and transition airspace environments. Extensions to controlled aircraft in mixed low altitude environments and to portions of terminal area airspace are possible.

This AERA system description is organized as follows:

First, the processes involved in the handling of controlled flights by the current ATC system are presented, along with the factors that are influencing changes. The best of current ATC practices and the needed changes are integrated into several design postulates for the AERA system.

Second, the distributed nature of the planning and execution of air traffic control functions is described. The major system elements and their communication and coordination needs are discussed. Key organizational concepts in the AERA design are defined.

Third, the major functions to be performed in AERA are described in some detail, along with their input/output relationships with each other. External data inputs and outputs are described for both man-machine communications and for data communications with remote facilities.

The description presented in this section presumes:

1. A filed flight plan on every controlled flight against which ATC clearances are generated.
2. Tracked surveillance data on the position and altitude information on every controlled flight.
3. Communications, data or voice, with every controlled flight.

Not treated in this section are such subjects as:

1. Failure modes and perturbations, both internal or external, and backup provisions for the AERA system (see Section 4).
2. The potentials for extending AERA to other airspaces and to achieve greater expedition and freedom of flight (see Section 5).
3. The expected roles and responsibilities of the human operators of the AERA system (see Section 6).
4. The levels of service provided to the various users of the AERA system as a function of aircraft equipment and other factors (see Section 7).

3.1 The Air Traffic Control System, Now and in AERA

The ATC system in the United States is charged with the safe and expeditious movement of flight, in particular controlled flights. In this sense, a controlled flight is one whose operator has requested permission to proceed according to a flight plan filed with the system, and who has received in return an ATC clearance to proceed, with or without restrictions relative to that flight plan. Clearances are formulated and issued to ensure that (1) aggregate traffic demand does not exceed known airport or ATC facility capacity limits, and (2) individual flight movements do not conflict with each other. In this process, three distinct functions can be identified: Pre-flight and In-flight Planning; Traffic Flow Management (part of ATC); and Traffic Separation and Advisory Services (part of ATC). The relationships between AERA and these three functions are described in the subsections below.

A fourth function, a separate Collision Avoidance capability, is related to the Traffic Separation and Advisory Service in the sense that it is also dedicated to preserving air safety, but it stands outside the ATC system in that it operates independently of the flight planning, clearance planning, and traffic control process. Such collision avoidance systems as the Air Traffic Advisory and Resolution Service (ATARS) and the Beacon Collision Avoidance System (BCAS) will back up the ATC system whether the latter is equipped with AERA or not. As in the current system, ATARS and BCAS are being designed as additional back-up safety services to provide last minute traffic advisories or avoidance maneuvers in the event that ATC separation methods have failed (IFR-IFR encounters) or do not apply (IFR-VFR and VFR-VFR encounters).

3.1.1 Pre-flight and In-flight Planning

In the current ATC system, each operator of a flight decides the objective of his flight and the means to meet that objective most efficiently. The flight plan as currently filed with the ATC system is a partial statement of the operator's full intent. It is basically a request of the ATC system for a clearance to proceed along the user's filed route and at an altitude requested by the user. However, the preferred climb profile, speed schedule, etc., are not filed with the ATC system and are left to the pilot's discretion, except when restricted by ATC for traffic or procedural reasons.*

A change to an existing flight plan clearance can be requested at any time by the pilot. Typical reasons include: a more favorable altitude, a more direct route, avoidance of severe weather or turbulence, etc. ATC will grant such requests whenever feasible.

It is now possible to refine flight plans prior to departure or to revise plans in flight so as to minimize fuel consumption or flight time. Accurate knowledge of aircraft performance characteristics, the flight's operating environment, winds aloft, and significant weather is made possible through modern sensor, computer and communications technologies so that flight plans can be optimized. For those users who do not have access to their own preflight planning systems, commercial services are available. The FAA's Flight Service Station Automation program is directed towards providing users with improved terminal and en route forecasts, winds aloft data, and other flight planning aids.

For in-flight planning, performance advisory computers are available which advise the pilot as to the thrust and pitch settings needed to achieve the altitude profile and speeds which best minimize user costs, fuel consumption, or flight time. Flight management computers are available which can be coupled to flight control

*The flight plan form does ask that the pilot make an estimate of the flight's true airspeed (TAS) for the purpose of estimating fix arrival times. But the data in the TAS field is not interpreted as a request for an ATC assignment as are the data in the requested route and altitude fields.

systems via auto-pilots and auto-throttles. Such systems ensure that the computed best pitch and thrust settings are translated into the proper flight control instructions. A flight management computer integrated with an area navigation system automatically provides optimum speed and altitude profiles over any desired route.

While the current ATC system tries to satisfy each user's request for a particular route or altitude, restrictions are imposed as needed to ensure separation and expeditious traffic flow. As the controller's workload increases, procedural route and altitude restrictions are often imposed between potentially conflicting traffic flows so as to limit this workload. Since routine imposition of altitude or routing restrictions segregate potential, but not necessarily actual traffic, the result is that aircraft are frequently denied the use of empty airspace. This is commonly referred to as "separating aircraft from airspace," rather than separating aircraft from other aircraft. The consequences are circuitous routing and undesirable altitudes leading to higher operating costs, fuel burns, or flight times than would have otherwise been necessary.

Rising fuel costs and improved avionics lead the users to need and request optimum direct routes, and unrestricted altitude profiles and speed schedules. It is becoming increasingly important that the ATC system accommodate these user requests.

In the AERA system concept, flight planning is accomplished as follows:

1. The airspace users will continue to be responsible for establishing their own mission objectives and whatever flight plans are needed for achieving them most efficiently. However, with the introduction of airborne computers to make such flight planning optimal and data links, it now becomes possible to transmit this more detailed knowledge of

flight intent to the ATC system for use in planning conflict-free and metered clearances. While the traditional flight plan format may be adequate for making initial flight clearance requests, it is inadequate for communicating desired climb and descent profiles, speed schedules and other supplemental data to the ATC system. Regardless of aircraft equipment, AERA, as explained in Section 3.3.2, will monitor aircraft performance, interject control as required to ensure conflict-free metered flow, establish flow patterns to avoid saturation, and reroute aircraft around severe weather.

2. The ATC system will continue to be responsible for clearing all flight movements, subject to aircraft separation and flow constraints. However, to the extent that the users are willing and able to keep the ATC system informed of their current intents (planned altitude profiles, speed schedules, and the degree of conformance to be expected), the system should be able to apply this knowledge in a manner which reduces the need for many routinely-applied procedural restrictions.
3. To the extent that users are unwilling or unequipped to provide more detailed flight plan data, the AERA system will be designed to estimate an aircraft's flight profile, based on pre-stored data of aircraft type, winds aloft and other factors. Since it is only a guess, the residual uncertainty as to what will actually occur must be compensated for by increasing the size the airspace protected for that aircraft. Increasing the volume of protected airspace increases the likelihood that an aircraft's clearance will conflict with another's clearance, resulting in a less desirable clearance for at least one of the aircraft involved. Thus, the opportunities for less restricted clearances increase as users equip themselves with flight management computers and DABS data link which can communicate the planned aircraft trajectories to the AERA system.

However, AERA could operate satisfactorily in the absence of such aircraft equipment. While the initial probability of control actions increases for substantial look ahead times, greater than 20 to 30 minutes, because of uncertainties with respect to flight profile and calculated times of arrival, the AERA planner makes dynamic adjustments when needed to avoid conflicts as flights progress. It is only necessary to ensure -- as explained in Section 3.3.2 -- that the density of aircraft projected at a given point in time and space does not burden AERA and aircraft with overly complex future clearances.

3.1.2 Traffic Flow Management

Airports have capacity limits on aircraft operations which vary as a function of weather, runway configuration, traffic mix, and other factors. ATC facilities have flight handling capacities which vary as a function of current staffing, on-line computer resources and air-ground communication channels. To provide expeditious and fuel-efficient flight movements, the ATC system is becoming increasingly organized and automated to improve its ability to (1) match variable ATC resources to anticipated traffic demands; and to (2) regulate actual demands to match limited ATC and airport capacities. This process conceptually extends from the arrival airport to its TRACONS and through ARTCCs back towards the departure airports. The process is physically implemented within a distributed nationwide network of ATC facilities.

In the current system, the distributed network consists of three types of ATC facilities:

- 1 Central Flow Control Facility (CFCF)
- 23 Domestic Air Route Traffic Control Centers (ARTCCs)
- 150 Terminal Radar Approach Controls (TRACONS)

plus non-radar approach control facilities and traffic control towers at controlled airports. For additional background on ARTCC/TRACON interactions see Appendix 2.

The operation of the current ATC system is depicted in Figure 3-1. A major airport is shown to be feeding traffic operating under instrument flight rules (IFR) to a distant major airport. This traffic merges with other traffic, both IFR and VFR (visual flight rules). As long as demand remains within the capacity of the airport and is within the capacity of the arrival TRACON to form the arrival sequence with little or no delay, the arrival ARTCC feeds aircraft to the arrival TRACON without delay.* When landing delays are anticipated which are beyond the capability of the TRACON to absorb efficiently, the TRACON imposes flow restrictions on arrivals. Such restrictions maintain those aircraft that are certain to be delayed, at higher altitudes, thereby conserving fuel. See Appendix 3 for a description of landing delay absorption in a fuel efficient manner.

The role of each facility, shown in Figure 3-1, in the management of traffic flow is discussed now.

The arrival ARTCC merges arrivals en route to feeder fixes for the terminal area. The in-trail spacing is chosen to ensure safety and to meet any flow rate restrictions that may be required at the feeder fixes by the TRACON. Speed reductions or path-stretching vectors are typically employed to insert any needed modest delays. To absorb larger delays holding patterns may be required. When sudden losses in runway capacity are experienced, impromptu holding procedures may be employed, such as present position holds and off-course circular vectoring patterns.

Tier ARTCCs and intermediate ARTCCs may be employed to absorb some of the delay when the arrival ARTCC's capacity for absorbing landing delays is

*VFR arrivals check in locally with the TRACON for sequencing and spacing to the proper runway.

Figure 3-1
TRAFFIC FLOW MANAGEMENT ILLUSTRATED

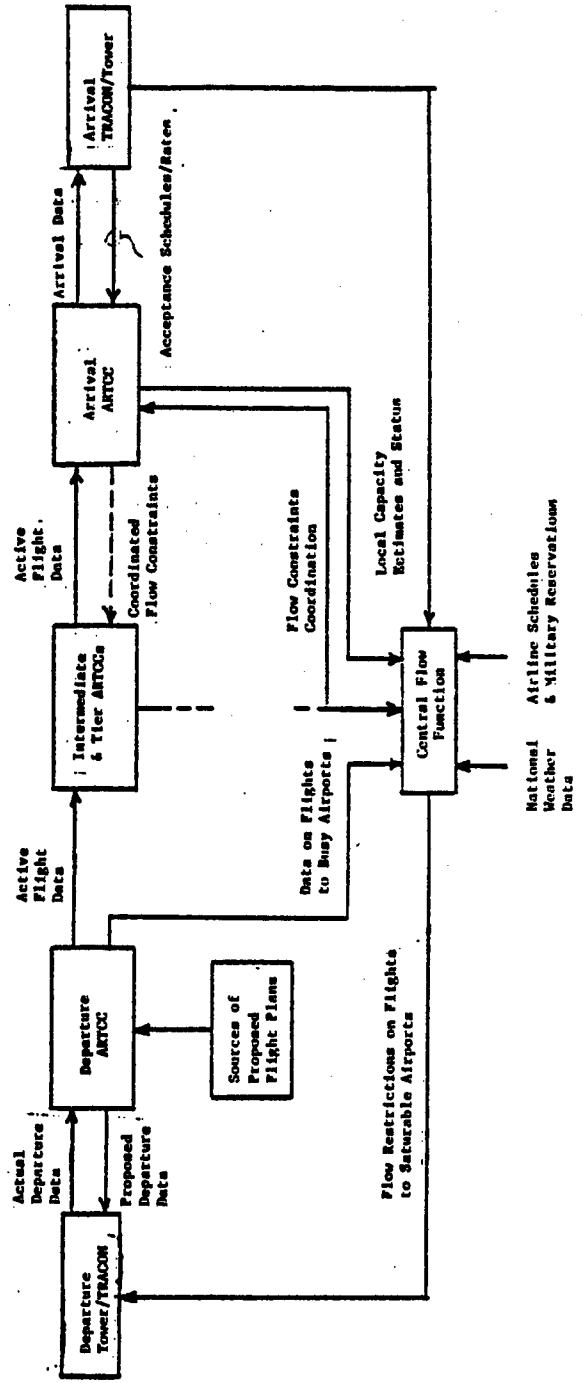
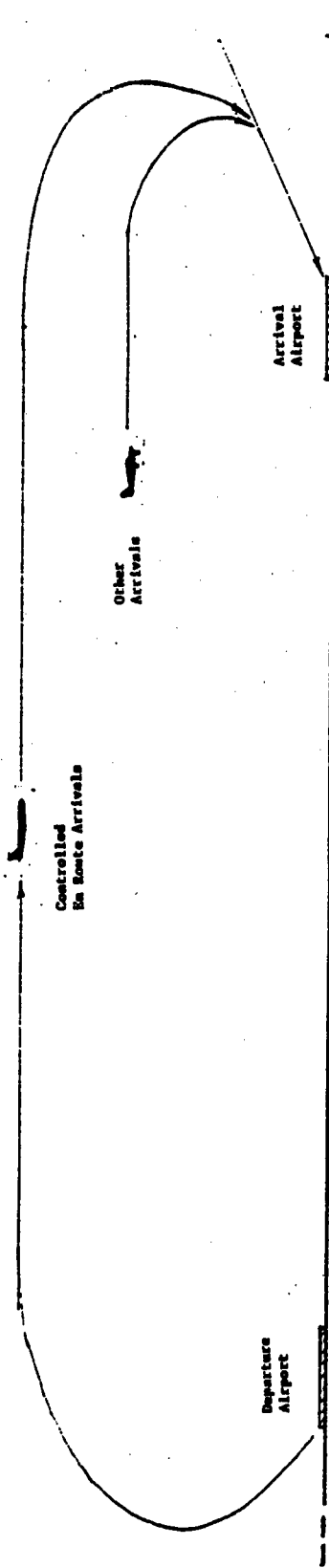

expected to be taxed for a substantial time period. A tier center is one adjacent to the arrival center that feeds the latter a significant number of arrivals. An intermediate center is any center which lies between the departure center and the tier center on any major route for arrival traffic. For example, for traffic moving from Los Angeles to the New York metropolitan area, Los Angeles is the departure center, New York is the arrival center, and either the Cleveland or the Washington Center is the tier center, depending upon whether a northern or southern route to New York is chosen. If a northern route to New York is chosen, the intermediate centers are Denver and Chicago.

When large and persistent delays can be forecasted well in advance, or are detected to be trending so as to severely impact operations, the Central Flow Control Facility (CFCF) will intervene to effect timely and efficient coordination of any needed flow restrictions which transcend center boundaries. These may include changes to bypass constricted routes.

The CFCF is the focal point and communications center for implementing the traffic flow management function at the national level. All major airports, users, and ATC facilities maintain direct voice or data communications with the CFCF. TRACONs and ARTCCs keep the CFCF informed of local conditions and capacities, both current and expected. Data on planned flights to saturable airports or via saturable routes are forwarded from all over the nation to the CFCF. There the aggregate demand for these saturable airports and routes is forecasted. The forecasted demand on these facilities is compared with the acceptance rates estimated to be available when that demand materializes. When overloads are judged to be likely, contingency plans can be put into effect. These bypass en route constrictions or diminish traffic flow. The CFCF also is a clearing house for flow constraints that other ATC facilities initiate on inbounds to their airspaces. The CFCF either approves the constraint and helps coordinate its implementation, or it may suggest alternatives which would accomplish the facility's objective with less impact on overall system performance.

The departure Tower/TRACON obtains clearance planning data on proposed IFR departures from the departure ARTCC. It later forwards actual departure times and other flight-specific data to the departure ARTCC when these flights depart. If a flight is destined for an airport with Fuel-Advisory Departure (FAD) procedures in effect, its departure may be postponed so as to take its assigned delay on the ground, rather than in the air. To the extent practical, the decision as to where to take the assigned delay is left to the individual operator, with the understanding that all of the assigned delay must be taken before his flight enters the arrival ARTCC's airspace. A record is maintained of the amount of delay assigned and the amount absorbed. This record is forwarded with the other clearance planning data for the flight as the aircraft moves towards its destination.

Traffic Flow Management is accomplished by this distributed system of facilities and the information paths needed for coordinating the plans of the various facilities. This system is illustrated in Figure 3-2.

In the current system, these functions are performed by a mix of automated and manual procedures, and data exchanges are made using a mix of voice and digital communications. In the future, the topology shown in Figure 3-2 is not expected to change, but it is expected that the functions will become more fully automated (performed by computers managed by facility personnel) and that communication facilities will become more reliant on digital data messages exchanged between computers.

The three major planning and control functions (Central, En Route, and Terminal) are discrete but cooperating entities in a nationwide network of distributed and increasingly automated ATC facilities. A fourth functional level of ATC planning and control, Terminal Configuration Planning and Selection, shown in Figure 3-2, involves the management of runways at a given airport. This function determines the appropriate runway configuration for various wind, weather, noise

FIGURE 3-2
MAJOR TRAFFIC FLOW MANAGEMENT FUNCTIONS & INTERFACES

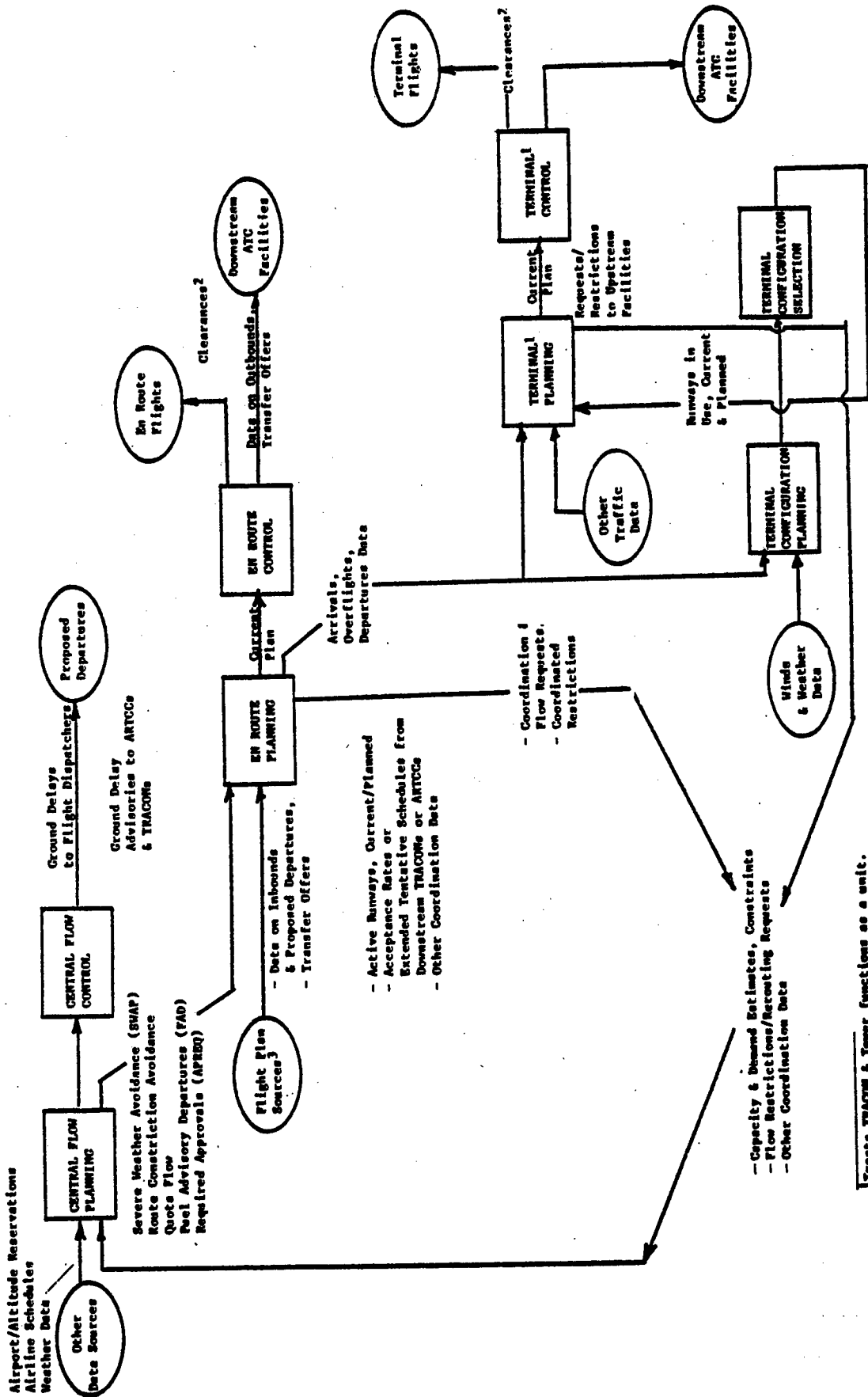

and flow considerations. It determines the runway capacity that is, or will be, available for a given airport and the appropriate arrival and departure fixes.

The AERA system concept manages traffic flow as follows:

1. The four functional components of traffic flow management are maintained: Central Flow Control; En Route Flow Control; TRACON/Tower Flow Control; and Terminal Configuration Planning and Selection. AERA will accommodate to their outputs.
2. Flight clearance planning and traffic control will continue to be distributed across ARTCCs and TRACON/Towers. Any flow constraints or delay maneuvers are planned and imposed independent of jurisdictional boundaries so as to minimize delays and fuel consumption.
3. The CFCF will continue to be the focal point for predicting gross delays and for coordinating flow constraints which cannot be predicted or coordinated as efficiently by the affected ARTCCs or TRACON/Towers themselves.
4. Each ARTCC or TRACON has to know only that portion of the overall delay which is to be absorbed within its jurisdiction. The needed delay is made known to a facility by downstream ATC facilities or the CFCF. The plan needed to absorb delay within a facility's jurisdiction is generated by the facility itself.
5. The location of arrival feeder fixes can be defined, assigned, or changed depending upon which runways are active, the direction of arrival, and the TRACON's ability to handle traffic flow merges with the terminal area. Even if arrival feeder fixes do remain as static locations (for

reasons external to the design of AERA), the crossing altitudes can still be allowed to float as a function of the best altitude profiles for the descending aircraft.

The remainder of the AERA flow management description concentrates on the traffic flow management functions housed within the ARTCCs. Any functions unique to the CFCF or to TRACON/Tower system, such as terminal area flow management and airport configuration optimization will not be developed further in this document. However, the interaction of the ARTCC flow management with that of the CFCF or TRACON/Tower is described.

3.1.3 Traffic Separation and Advisory Services

The current ATC system gives first priority to the separation of controlled flights and to the issuance of safety advisories.* Second priority goes to other services that are required but do not involve the separation of aircraft (e.g., altimeter settings). Third priority is given to additional services to the extent that workload and other factors permit (e.g., distributing pilot reports of weather).

The current ATC system provides separation between controlled flights. Separation in either the horizontal or the vertical dimension is sufficient to assure safety. In the horizontal plane, clearances to flights along routes which are laterally separated are sufficient. Where lateral separation falls below some acceptable minimum (near route intersections or for closely spaced routes), and the flights involved are seen and identified using tracked surveillance data, a minimum range standard is used. Where surveillance coverage is insufficient, pilot reports of position are used and a minimum time or DME distance separation standard is used.

Alternatively in the current ATC system, flights can be separated vertically from each other, thus eliminating any concern about the possible loss of horizontal

*Safety advisories are to be issued whenever any air traffic controller becomes aware that a flight (identified and in contact with ATC) is in an unsafe proximity to terrain, an obstruction, or another aircraft. These control priorities are defined in ATC Handbook 7110.65.

separation. When applying the vertical separation standard to flights that are undergoing a transition from one assigned altitude to another, all altitudes not yet reported as vacated must be protected up to, and including, the new assigned altitude.

Controllers plan and execute control instructions to ensure that at least one of the established separation standards will always be satisfied for every flight under his active control.

With regard to traffic separation and advisory services, the AERA design concept is as follows:

1. The ATC system will continue to give first priority to the separation of controlled flights and any other flights that are granted separation or safety advisory services. Should a conflict arise between these services and satisfying a traffic flow management constraint, safety has priority.
2. The AERA system's ability to plan conflict-free clearances should be greatly enhanced over that of the current ATC system, given better data on the actual winds aloft, expected aircraft performance, the planned altitude profiles and speed schedules, and the ability to compute the projected missed distance of flight trajectories in the horizontal and vertical dimensions, whether or not these trajectories are on airways. Therefore, it should be possible to relax many of the procedurally imposed ATC restrictions on routes, altitude profiles, and speeds without any loss of safety.
3. Given the capability to automatically monitor the progress of every controlled flight (a) relative to its own current clearance; and (b)

relative to the progress of other flights, in both the horizontal and vertical dimensions, the AERA system does not need to be overly conservative in providing separation between converging flights. This should lead to greater expedition of flight than is permissible in the current system. Coupled with the capability to automatically compute clearances on a tactical basis to ensure that separation standards are satisfied, the amount of conservatism practiced in clearing flights today, even in the absence of procedurally imposed restrictions, should be reducible without any loss in safety.

4. A goal of the AERA concept is to relieve the human controllers from all routine monitoring of aircraft tracks. Controllers now routinely monitor tracks in order to assure that at least one of the minimum separation standards will be met. This function can be performed more consistently and accurately using computers, given reliable surveillance data provided by ATCRBS or DABS.
5. Given that the tactical resolution of any residual conflicts can also be automated, human controllers can eventually be relieved of the duty of making any time-critical decisions regarding flight safety.
6. Controllers are required to be on duty to respond to any special requests or situations brought to their attention for non-time-critical resolution. There must always be enough controllers on duty to handle the voice communication peak load, which is likely to occur during episodes of severe weather or when airports are changing runway directions or have curtailed acceptance rates. Controllers are required to assess the capacity of the portion of the system, under their responsibility, the status of alternative routes and backup capabilities, and the present and predicted demand as provided by CFCF and

adjoining facilities. Controllers are to be provided with special AERA tools to make these assessments and thus utilize ATC's resources in a manner which continuously maintains the most expeditious traffic flow without compromising safety. For further discussion of the role of the controller in AERA, see Section 6 entitled "AERA and the Controller".

3.2 AERA System Elements, Boundaries and Data Exchanges

The following paragraphs define the network of ATC facilities within which the AERA system is physically housed. The airspace boundaries important to the AERA concept are defined. Finally the data exchanges needed in advance of flight movements across these boundaries are defined.

3.2.1 Air Traffic Control Centers, AERA Systems and Inter-Facility Interfaces

As shown in Figure 3-3, there are currently twenty Air Route Traffic Control Centers (ARTCCs) which service IFR traffic over the continental United States. Each ARTCC accepts flight plans on proposed departures from airports within its boundary and on active inbound planning either to overfly its interior or to land at airports within its boundary. It uses these flight plans and surveillance data to plan, coordinate and control these flight movements so that they remain conflict-free and metered relative to any flow rate constraints.

For the purpose of clarity, this system description starts with a few basic assumptions. Some of these assumptions can later be relaxed as various options are discussed, such as center-center consolidation, center-terminal consolidation, boundary realignments, and subdividing a center so that different areas of specialization are served by separate computer systems.

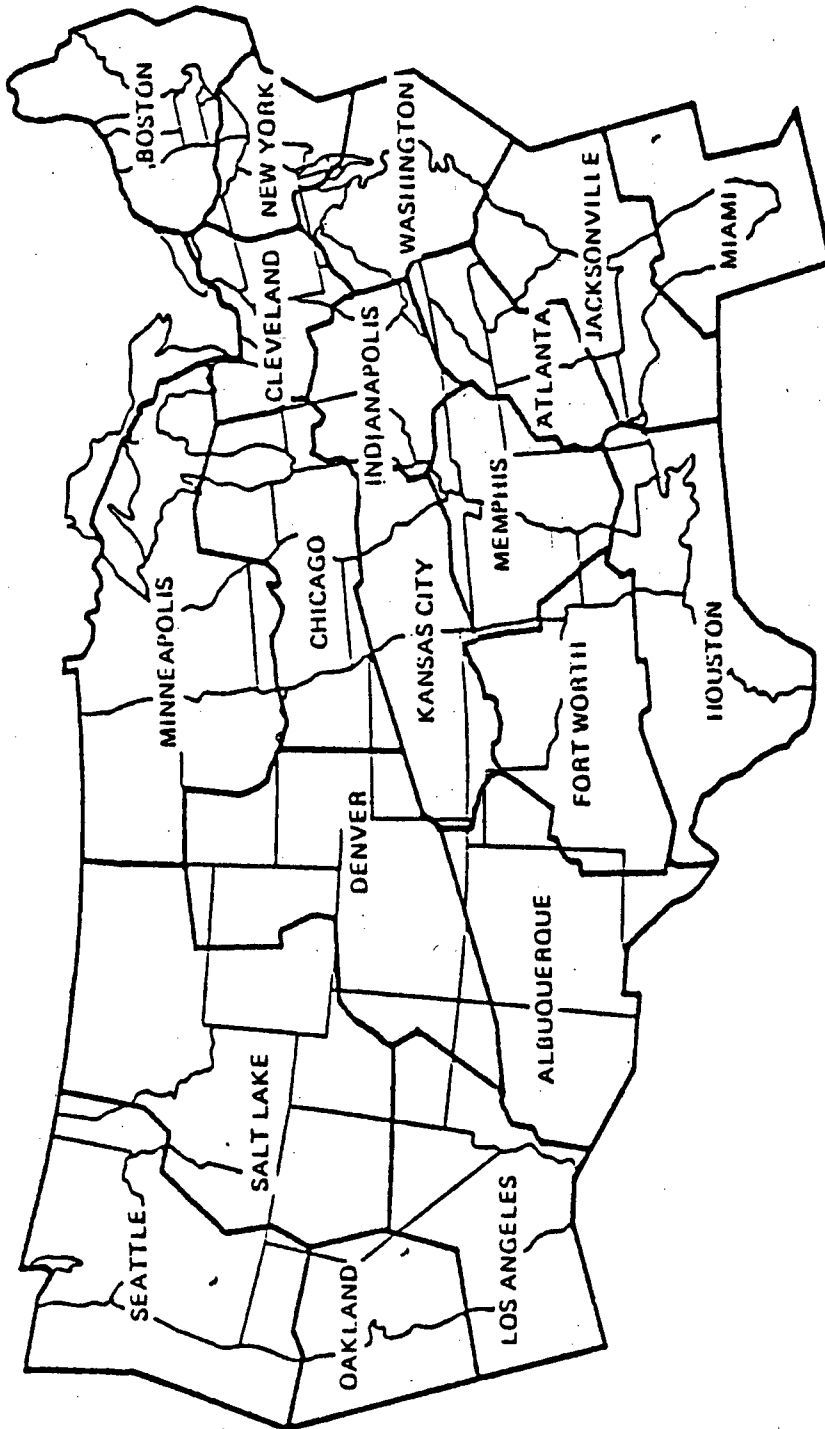

Figure 3-3
En Route Low Altitude ARTCC Boundaries

It is assumed that there is one AERA system per ARTCC facility. Each AERA system has data communication interfaces with its neighbor AERA systems, as well as with the computer systems in the TRACONS and Towers it serves, CFCF, and the Flight Service Stations (FSS) and other on-line sources of proposed flight plans within its service area. Voice communication links between operating personnel in ARTCCs, TRACON/Towers, CFCF, and FSS facilities are also assumed to exist. In addition, the remote voice communications, air-ground (RCAG) sites and surveillance and data link communication sites (DABS) which provide coverage of each center's primary airspace service volume, plus any secondary backup service volumes, are assumed netted to the ARTCC voice or AERA systems (see Figure 3-4).

It is also assumed that the nationwide network of ARTCC computers will continue to provide the backbone for storing and forwarding flight plan data to all ATC facilities. Each proposed flight plan is filed with the ARTCC which serves the departure airport. The departure ARTCC performs acceptance checking on the flight plan and handles the editing of any errors or necessary revisions. If the flight plan is for a destination of interest to the CFCF*, then the ARTCC computer forwards the necessary data to the CFCF at the proper time. Sometime prior to the proposed departure time, the proposed flight plan is processed to permit the departure clearance to be formulated. If the departure is from an airport served by a TRACON** or Tower, the ARTCC computer forwards the necessary flight data to the TRACON/Tower at the proper time.

When the flight actually departs, the departure time is forwarded by the Tower or TRACON to the ARTCC computer. Consequently, its flight plan is activated and flight progress monitoring for store and forwarding purposes begins. Sometime prior to exiting the departure ARTCC, the active flight plan data are forwarded to the next ARTCC or TRACON down the route of flight.

*CFCF only concerns itself with saturable major airports and other possible bottlenecks to major traffic flows (e.g., routes affected by severe weather or ATC facility outages).

**TRACON-served towers are assumed to receive the necessary departure data via the TRACON.

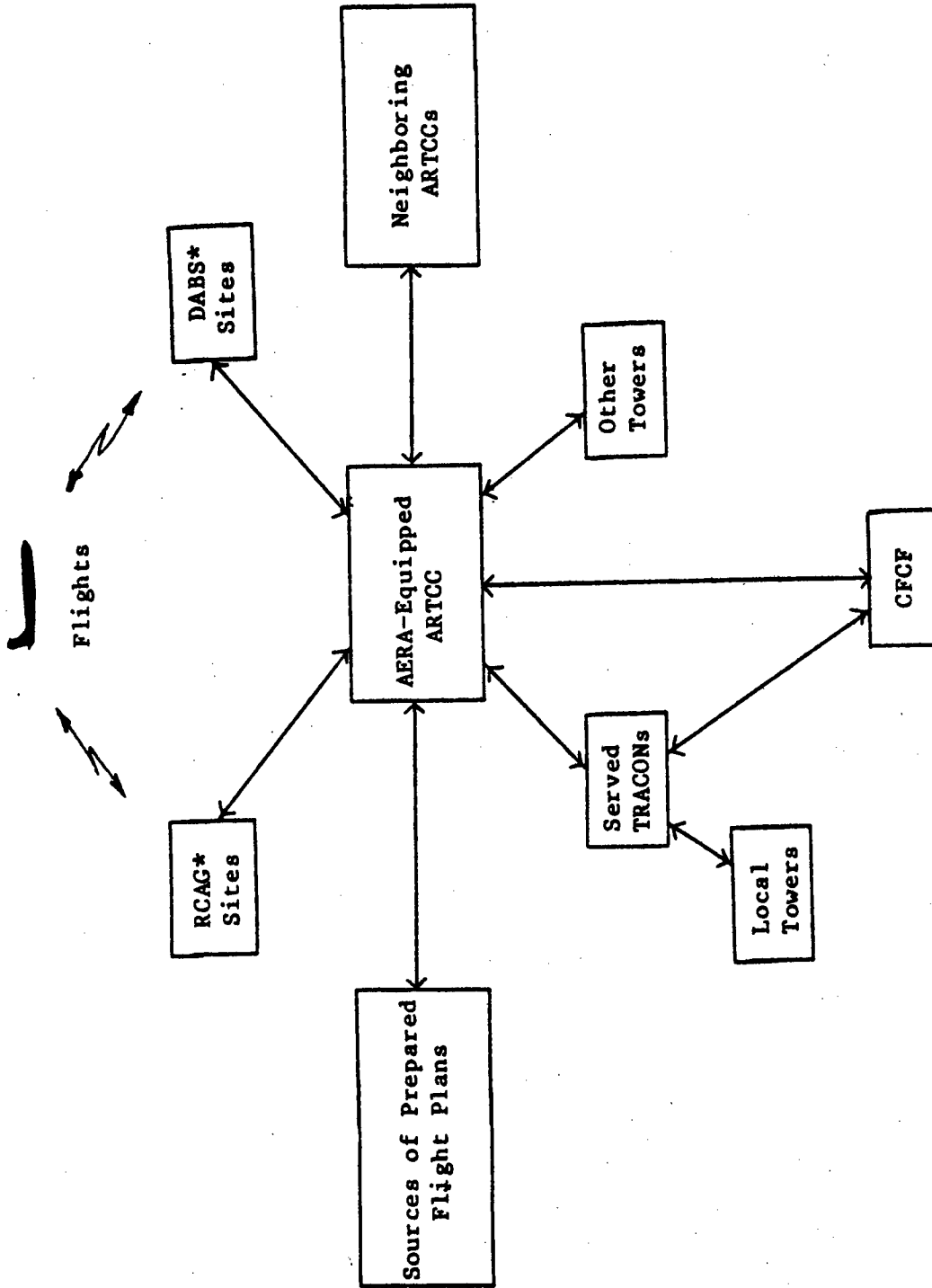

Figure 3-4

Assumed Inter-Facility Interfaces in AERA

*Sufficient to cover the ARTCC's primary service volume, plus any secondary backup service volumes.

If the flight does not enter ARTCC airspace but continues under "tower en route" procedures through adjacent TRACON or tower airspaces, flight plan forwarding may be handled either by the ARTCC or the TRACON or Tower computers, depending upon the capabilities of the latter.

In the current NAS Stage A and Automated Radar Terminal System (ARTS) systems, all flight plan forwarding is handled by the ARTCC computers. If the ARTCC-to-ARTCC link is maintained as the path for forwarding all flight plans, then the arrival ARTCC has all the data necessary to perform tentative scheduling for the en route metering function. If some flight plan data are forwarded by a new TRACON-to-TRACON link, then the arrival ARTCC and arrival TRACON will both have flight data required by the tentative scheduling function. (See Section 3.3.2.5, "Delays Prediction".)

3.2.2 IFR Clearances

The concept of planned "IFR clearances" is essential to the planning function of air traffic control. In its simplest form, the clearance provides the pilot with an authorization to proceed along his filed route at an ATC-assigned altitude. Whenever possible, the ATC-assigned altitude is equal to the pilot's requested altitude. The clearance may be revised whenever requested by the pilot or whenever required by the contingencies of air traffic control (e.g., competing aircraft movements, hazardous weather, airport closures, etc.). Revisions may include pilot-requested or controller-negotiated re-routes, new altitude assignments or altitude crossing restrictions, speed restrictions, tactical heading or course assignments, clearance limits and holding instructions, or any other instruction authorized by ATC procedures. If for any clearance "at pilot discretion" is stated or is procedurally implicit, the pilot has the option to initiate the terms of the clearance whenever, and however, he wishes. Otherwise, the pilot is expected to execute its provisions without delay after acceptance. It should be

remembered that a clearance transmitted to a flight cannot be considered operative until pilot acceptance has been received by the issuing ATC facility.

3.2.3 Pilots, Controllers and Man-Machine Interfaces

Even though flight planning, navigation and flight control have become highly automated functions in many aircraft, the pilot-in-command has final responsibility for the safe conduct of his flight. However automated ATC flight clearance planning, execution and tactical control eventually become, the controller-in-charge will have final responsibility for safe and expeditious operations in his sector, within the bounds of his assigned role (see Section 6, "AFRA and the Controller"). In order to meet these responsibilities, the pilot and controller must have the ability to communicate with each other, as well as with the computer systems which serve them. In turn, the computer systems which serve them should also have the ability to exchange specific types of data. Figure 3-5 illustrates this communication requirement. Table 3-1 summarizes the possible sources for messages delivered by the air-ground data link.

Figure 3-5

MAN-MACHINE AND AIR-GROUND COMMUNICATIONS ASSUMED IN AERA

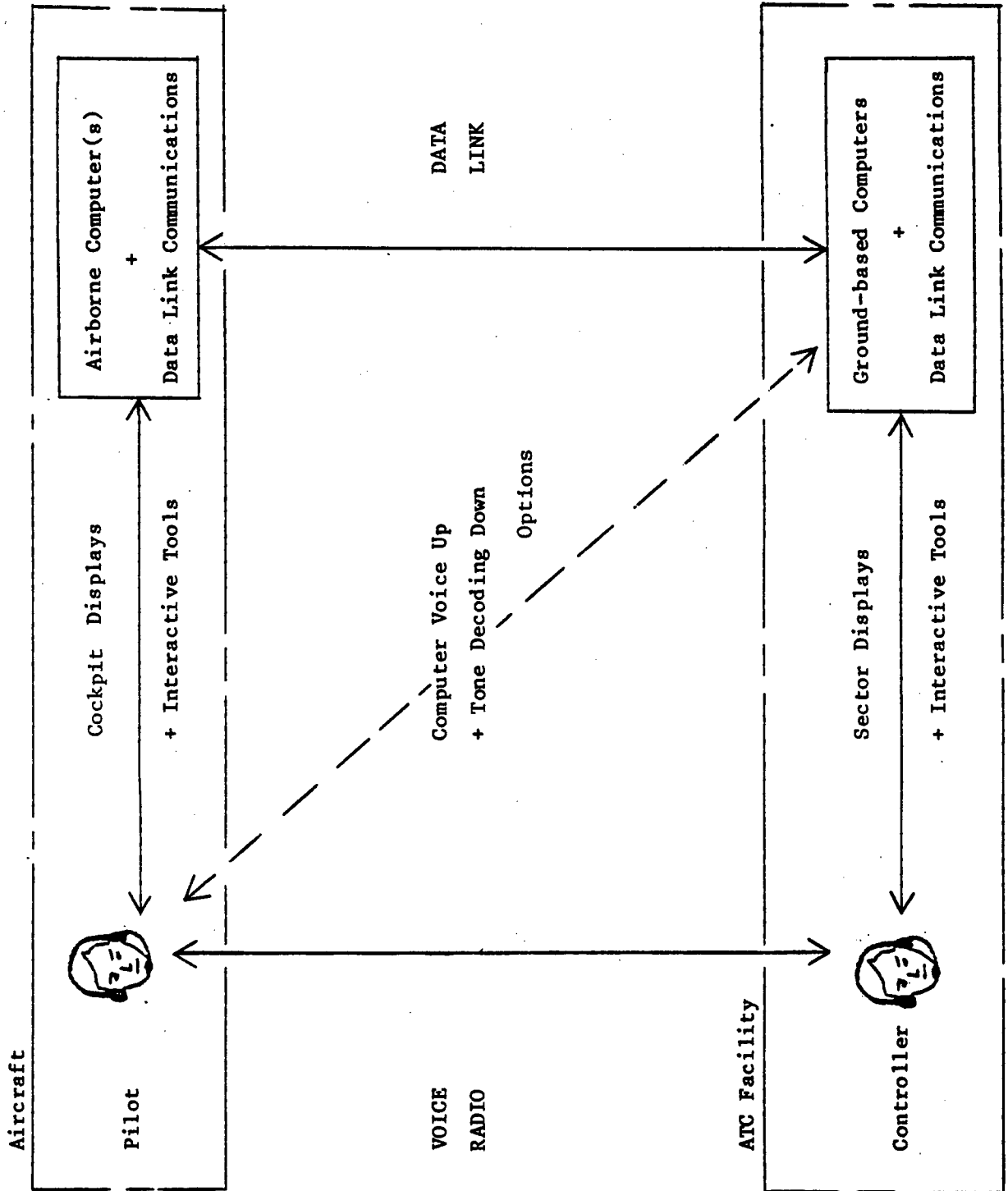

Table 3-1

Possible ATC Data Message Generation and Delivery TechniquesDown-Link MessagesOn-Board Computer-to-Down-Link:

Direct with pilot review/approval

Via pilot for review/approval or revision

On-Board Computer-to-Pilot for:

Pilot-to-controller negotiated decision or data

Pilot relay via voice radio (backup)

Pilot-to-on-Board Computer for:

Relay via down-link (primary or voice backup)

Processing run/stops which may generate additional down-link messages

Up-Link MessagesGround-based Computer-to-Up-Link:

Direct without controller review/approval (or revision)

Via controller for review/approval (or revision)

Ground-based Computer-to-Controller for:

Controller-to-pilot negotiated decision or data

Controller relay via voice radio (backup)

Controller-to-Ground-based Computer for:

Relay via up-link (primary or voice backup)

Processing run/stops which may generate additional up-link messages

The airborne computer(s) of interest here include those used for planning the best speed and altitude profiles from the aircraft's present position to a specified destination (flight management or performance advisory computers), for navigating a selected route (area navigation computers with or without autopilot coupling), and for conforming to a selected altitude profile and speed schedule (a flight management computer with auto-pilot and auto-throttle coupling). While such computers are not necessary for the implementation of AERA, the service provided would be improved for aircraft carrying this equipment.

The down-link is expected to become the primary channel for pilot acknowledgement of up-link delivered messages, for making pilot requests using flight planning data stored in his own computer and for reporting winds aloft and other air mass data (see Table 3-2).

Table 3-2

Possible ATC Data Message Class/TypeDown-Link Messages

1. Flight Plans (proposed, active inbounds, airfiles,...)
2. Flight Profile Data (gradients, speed schedules, Estimated Time of Arrival (ETA)...))
3. Air Mass Data (winds aloft, Clear Air Turbulence (CAT), cloud tops...)
4. Clearance Requests (present position directs, route amendments, Preferential Departure Route (PDR)/Preferential Arrival Route (PAR) assignments, runway assignments...)
5. Discretionary Requests (lateral route deviations, vertical profile deviations...)
6. Information Requests (down-route winds aloft, significant weather, Automatic Terminal Information Service (ATIS), Cockpit Display of Information (CDTI),...)
7. Up-link Messages Replies (WILCOs, Unables,...)

Up-Link Messages

1. Clearances (route, heading, speed, altitude, voice frequency changes,...)
2. Advisories (traffic, terrain, Significant Meteorological Data (SIGMETS), Notice to Airmen (NOTAMS),...)
3. Information Replies (down-route winds aloft,..., CDTI updates,...)
4. Other Down-Link Message Replies (accepts, rejects,...)

The up-link is expected to become over time the primary channel for all messages generated by the ground system's computers. Voice radio must be retained to transmit messages to aircraft not equipped with data-link and to facilitate communications not made easier, or possible, by the computer and as a backup to data link failures. For those aircraft not equipped for data link communications, computer-generated up-link messages might be delivered via the controller's voice channel using computer voice generation. Limited down-link messages, like acknowledgements, derived from pilot keyboard entry, might be relayed as audio tones on the voice channel.

The only experience that civil ATC has had with air-ground data communications is in the automatic reporting of altitudes and assigned beacon codes via the ATCRBS system. This idea has proved to be highly successful, and it is now being expanded into a full-fledged data link in the upgraded Beacon system (DABS).

3.2.4 AERA Planning Regions

To avoid discontinuities in the planning and control process, each AERA system begins full trajectory modeling and tracking of an inbound aircraft's progress before it enters the control region. Nominally, the full planning process for each aircraft begins thirty minutes prior to inbound handoff. Conceptually then, the planning region for each AERA system is larger than the control region by nominally thirty minutes flying time. Thus, AERA techniques extend beyond the AERA control regions into the AERA planning region, but a given AERA system has responsibility for separation assurance and metering only within its control region.

3.2.5 AERA Control Regions

In each AERA system, the volume of airspace within which the computer will regulate flight movements by issuing clearances to pilots is known as its "control region". The lateral boundary of such a region will in most cases be coincident with the ARTCC boundary. Vertical boundaries will, at least initially, exclude terminal areas and some low altitude airspace areas. Control regions can be defined in other ways, so long as they are mutually exclusive and collectively exhaustive of the airspace to be covered.

3.2.6 AERA Control Sectors

Each AERA control region is subdivided into "control sectors" for the purpose of assigning teams of human controllers to manage airspace jurisdictions which are smaller than the whole AERA control region. Sectorization is provided as one mechanism to distribute anticipated human workloads among several control teams. Any configuration of sectors is supportable so long as they are mutually exclusive and collectively exhaustive of the parent AERA control region. Sectors can be (1) combined as workload decreases, releasing personnel from sector management and control responsibilities when they are no longer needed, and (2) decombined as workload increases, in order to keep active team personnel within a range of productive but nonsaturating workload levels.

While not critical to the concept, it is generally assumed that AERA control sectors will likely be staffed by one or two controllers and that the airspace subsumed would be several times the size of current day NAS sectors.

As in the present system, each AERA sector will maintain VHF/UHF radio communications with each flight under its control. Assuming that it will take several RCAG sites to provide continuous coverage over each AERA sector, the

AERA system would automatically instruct each flight to contact the center on a new voice frequency as it moves from the coverage volume of one RCAG to the next (assuming that non-interfering frequencies are required between adjacent RCAGs). Properly equipped aircraft could have voice frequencies changed automatically from the ground. AERA may require fewer voice frequency changes because of increased sector sizing and lower message traffic.

3.2.7 Flight Data and Control Coordination Across Boundaries

Figure 3-6 illustrates the sequential process of flight data acquisition and initial clearance planning, track data acquisition and full clearance planning, and inbound transfer-of-control, all of which must be successfully completed before an inbound may enter the AERA control region.* Within the control region, flight trajectory planning is conducted as though control sector boundaries were not there, with one exception. AERA provides the option to adapt sector shelves and to dynamically activate them during periods of high demand to segregate traffic flows. While the use of such shelves is expected to decline with the implementation of AERA, this feature does provide a means of transition from the current system and a mechanism to protect against unusual demand overloads.

3.3 ATC Functions That Involve AERA

The functions that provide inputs to AERA are discussed first. Then the functions to be performed within the AERA system are defined. Flight trajectory modeling and association checking are described to show how the planning of clearances can be based on flight trajectory models and to show that real-time surveillance of actual aircraft progress is used to update flight trajectory models. The prediction of potential problems between competing flight trajectories is discussed next in terms of predicted "conflicts" and "delays". The planning of cross-tell messages to the next ATC facility down each route of flight is also

*All of these ideas are derived from current ATC practices and computer system operations.

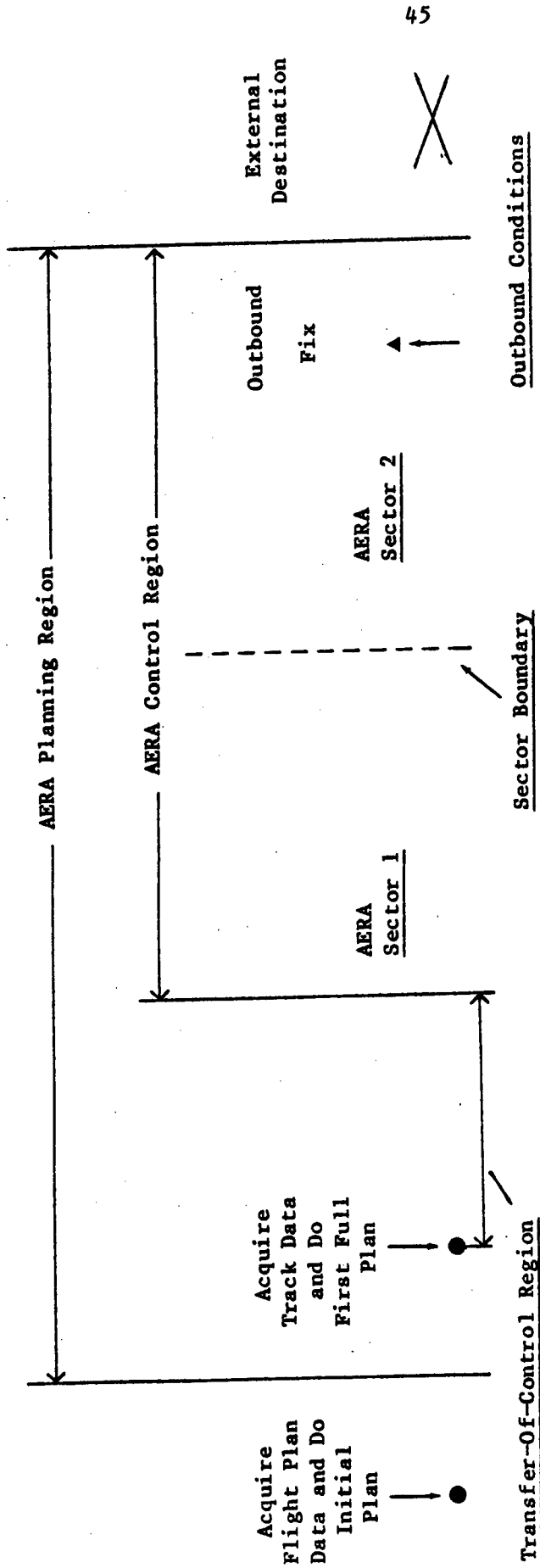

- Offer control whenever exit is conflict-free
 - AERA or receiving sector accepts or rejects offer
 - Pilot instructed to change voice frequency if offer is accepted
- Transfer-Of-Control Region
- Where shelves are adapted and have been dynamically activated
- Sector Boundary
- Transparent for trajectory planning except:
- Where shelves are adapted and have been dynamically activated
- Outbound Conditions
- Restrictions imposed by external destination, if any, are reflected back to outbound fix.

Figure 3-6
Flight Data and Control Coordination Across Boundaries

discussed. Next, the use of predefined strategies for solving the catalogue of potential problems is discussed. This generates a plan of subsequent actions to be taken by AERA. The interpretation and execution of the planned actions to meet explicit tactical objectives are discussed next. At this point specific messages needed to convey clearances or other data are generated.

AERA outputs to either the uplink or cross-tell links are then discussed. The system supervisory functions, monitoring capacity, demand and performance are discussed last.

The ATC functions are described from the viewpoint of an observer watching the inner workings of AERA, and the information flows to and from the man-machine interface are identified, but any details of display and data entry are beyond the scope of this concept description.

3.3.1 Inputs to AERA

The inputs required for AERA consist of various air-to-ground communications, other on-line data inputs from ATC facilities and "Radar" data inputs.

3.3.1.1 Air-to-Ground Communications

Air-to-Ground Communications will be used to the extent that served flights are equipped to down-link flight plans ("airfiles"), other ATC service requests, flight planning data (crew-planned altitude profiles and speed schedules), and sensed air mass data (winds aloft, outside air temperature, turbulence, etc.) Acknowledgement of up-linked clearances, instructions and advisories ("will comply", "unable", "understood", etc.) will also be down-linked.

Down-link messages are either routed to the AERA system ("on-line data inputs") or to the cognizant sector controller ("Man-Machine Interface"), as message addressing dictates.

Down-link messages can be transmitted via the DABS data link or via tone-encoded messages derived from pilot keyboard entry, and transmitted over the sector voice frequency.

To the extent that aircraft are not equipped to down-link such data, VHF/UHF voice radio communications will be used and the controller must enter the appropriate data in AERA.

3.3.1.2 Other On-Line Data Inputs

Other on-line data inputs to the AERA system come from local sources (e.g., Man-Machine Interfaces), and external facilities (e.g., neighboring ARTCCs, served TRACONS and Towers, CFCF, center area FSS, ATCRBS and DABS sites providing ARTCC coverage, etc.) Messages from adjacent ATC facilities include proposed and active flight plans, flow restrictions, handoff offers and acceptances, and many others. All inputs are checked for source acceptability and content errors before being used to update AERA data bases.

In particular, the Man-Machine Interface function provides the input tools necessary for facility supervisors and air traffic controllers to make on-line inputs into the AERA system. Such inputs might be made in response to a request received by the controller from a served flight or from some other ATC position, or in response to a prompt or a query generated by the AERA system itself, or to obtain a computer response to a question formulated or to a decision made by the supervisor or controller. These inputs -- which could be made using some mix of tactile devices, touch displays, or speech recognition systems -- are automatically

error-checked and transformed for AERA consumption by the Man-Machine Interface function. The results can be thought of as additions or changes to those AERA data structures which either control or feed AERA functions.

Weather data sources are needed to support the following functions:

Winds Aloft Modeling: Ground speed estimates for each flight must be derived from its expected airspeed schedule and other data. To obtain along-course wind data, a model of the winds aloft will be maintained for use by the Trajectory Modeling function. The source data for initializing and updating the model could range from currently available NOAA winds aloft reports/forecasts to real-time winds aloft reports, the latter downlinked by equipped aircraft. Ground derivation of winds aloft can be computed using selected aircraft tracks.

Severe Weather Avoidance: Severe weather data must be made available to support the planning of clearances to safely avoid it. The minimum requirement is to define and display the airspace volumes which are potentially dangerous or which are to be avoided. The pilot can request and the controller can initiate the necessary processing to obtain a clearance which either authorizes the pilot greater lateral/vertical discretion about his cleared route centerline or which provides him with a revised route clearance.

Other ATC Services to Pilots: The following are currently provided as en route ATC services to pilots or are used in ATC clearance planning:

- Altimeter Setting
- Minimum Assignable Flight Level (MAFL)
- Airport Ceiling, Visibility, Runways In Use
- En Route Weather Reports/Forecasts

This information will continue to be made available to controllers and pilots by AERA even though the methods of delivery and display may become more automated.

For a discussion of the output side of the Man-Machine Interface function, refer to Section 3.3.3.2 entitled "Other On-Line Data Outputs."

3.3.2 AERA Functions

The seven major functions within AERA and their logical interfaces with the outside world are illustrated in Figure 3-7. The particular function of Strategic Planning is later sub-divided into its problem prediction functions (delays, conflicts) and its solution planning functions (absorption, resolution and solution checking). This further breakdown is illustrated in Figure 3-11.

3.3.2.1 Surveillance Data Inputs Processing

Surveillance Data Inputs Processing converts the incoming stream of surveillance data and other current event reports (e.g., inbound handoff offers) into forms suitable for subsequent computation. For example, surveillance data not previously tracked is smoothed into current estimates of aircraft position and speed ("tracks"). The parameters used by AERA in association checking, conflict prediction and resolution will reflect the quality of the tracks. Current track data and track control status (offered or accepted) are made available to such functions as Association Checking, Tactical Execution, Separation Assurance Monitoring and the Man-Machine Interface.

This function is essentially the Radar Data Processing (RDP) function in NAS Stage A.

Figure 3-7

MAJOR AERA FUNCTIONS & INTERFACES

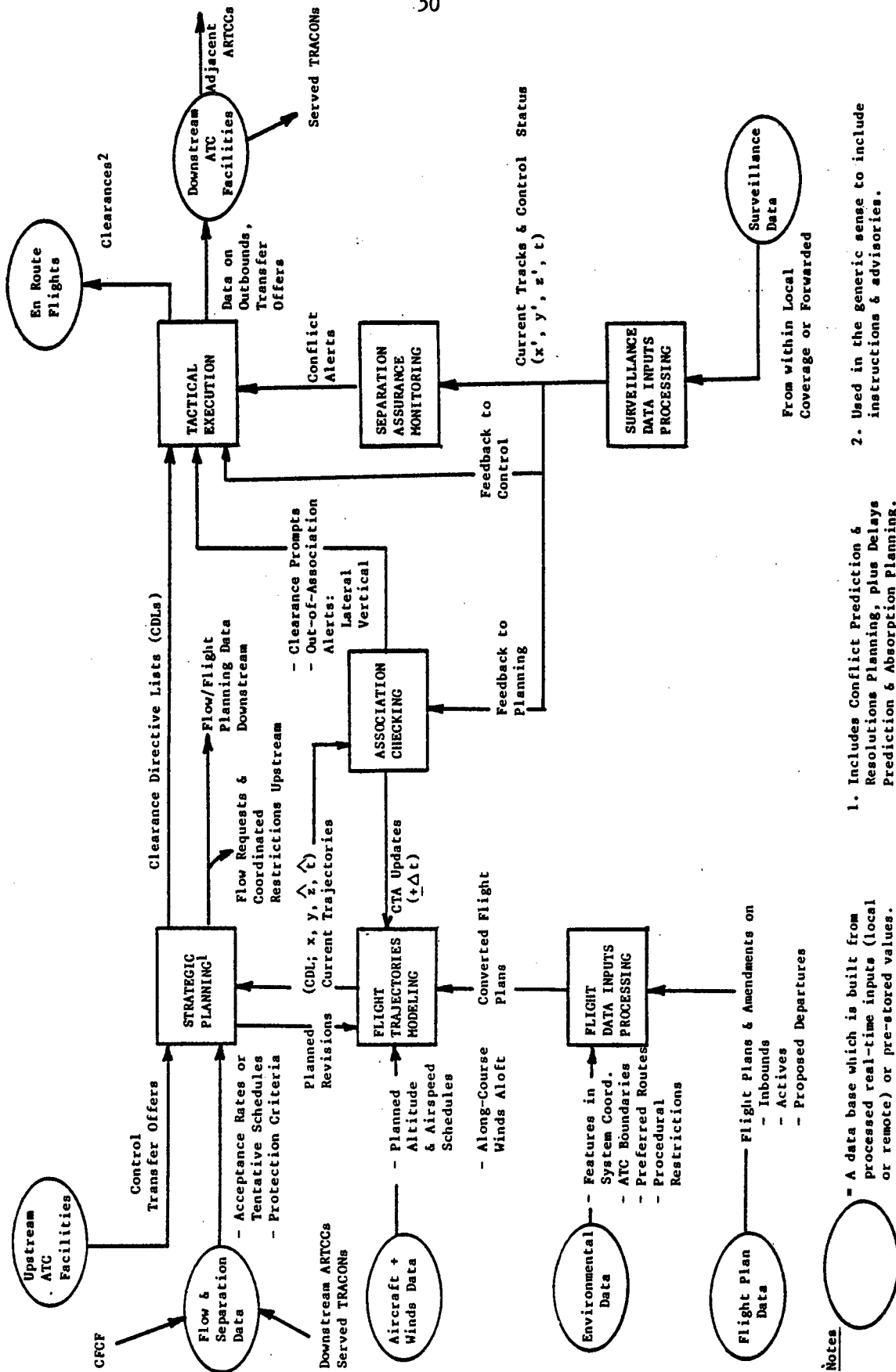

1. Includes Conflict Prediction & Resolutions Planning, plus Delays Prediction & Absorption Planning.
2. Used in the generic sense to include instructions & advisories.
3. The Man-Machine Interfaces are not explicitly shown.

3.3.2.2 Flight Data Inputs Processing

Flight Data Inputs Processing converts incoming messages, such as each new flight plan or subsequent revision which is received, into an internal form suitable for subsequent computation. For example, the alpha-numeric route field must be converted into a set of (x, y) points referenced to the ARTCC's coordinate system.

Procedural restrictions may be locally adapted and dynamically activated as the need exists. Any procedural restrictions appropriate to a particular flight plan are also noted relative to its converted route for subsequent processing. The flight planning data base is made available to the Flight Trajectories Modeling and the Man-Machine Interface functions.

This function is essentially the front-end of the current Flight Data Processing (FDP) function in NAS Stage A.

3.3.2.3 Flight Trajectories Modeling

Flight Trajectories Modeling takes each converted horizontal route from planning inputs processing and, using the best available data on expected aircraft performance (climb and descent speed schedules, altitude profile gradients, etc. transmitted by the flight or obtained from prestored tables) and on expected winds aloft (along course winds at profile altitudes), computes a best estimate of the flight's expected trajectory through the AERA planning region. That trajectory is constructed to satisfy known boundary constraints (i.e., where and when the aircraft is expected to enter and leave the planning region), as well as any interior planning region constraints (e.g., procedurally imposed crossing altitude restrictions).

The trajectory can be thought of as an ordered sequence of 4-dimensional point (x, y, z, t), where each

x, y= a flight plan fix or a fix defining one end of a flight plan airway segment, or a point where the flight plan route crosses an internally stored boundary (e.g., sector, restricted area, weather cell, metering),

or a point where a change in course, altitude gradient or speed is expected to take place.

z = the currently expected altitude when crossing the point "x, y".

t = the currently expected time of arrival at (or departure of) the point "x, y".

Stored with each point are all the relevant data associated with the flight at that point. Pairs of such points define "state segments". State segments are connected end-to-end to make a trajectory for each flight which traverses the planning region.

Figure 3-8 illustrates the printout of the horizontal profile of such a trajectory. When submitted for horizontal route conversion, this horizontal path was described as "CHS.J165.RIC..EPICS..DCA". Figure 3-9 illustrates the printout of the corresponding vertical profile for that trajectory.

Associated with each trajectory is a list of Clearance Directives which represents traffic control actions planned for subsequent execution at specific points along the trajectory. Each Clearance Directive states an explicit tactical objective to be met by this flight. When initially created, the Clearance Directive List contains only an outbound handoff Clearance Directive and any procedurally

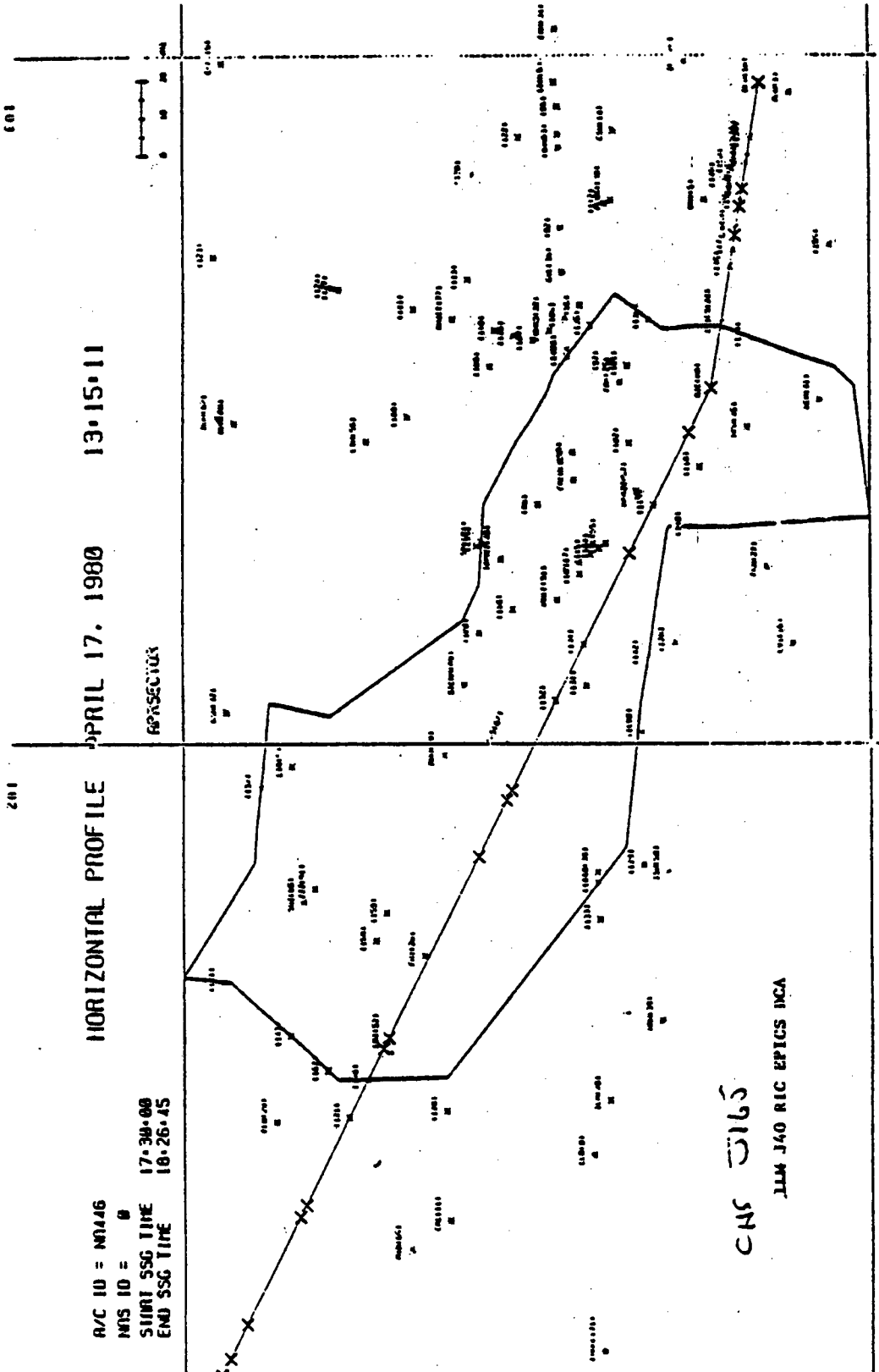

3-38

Figure 3-8

VERTICAL PROFILE APRIL 17, 1980 13:20:40

IVC ID = N0446

IVS ID = 0

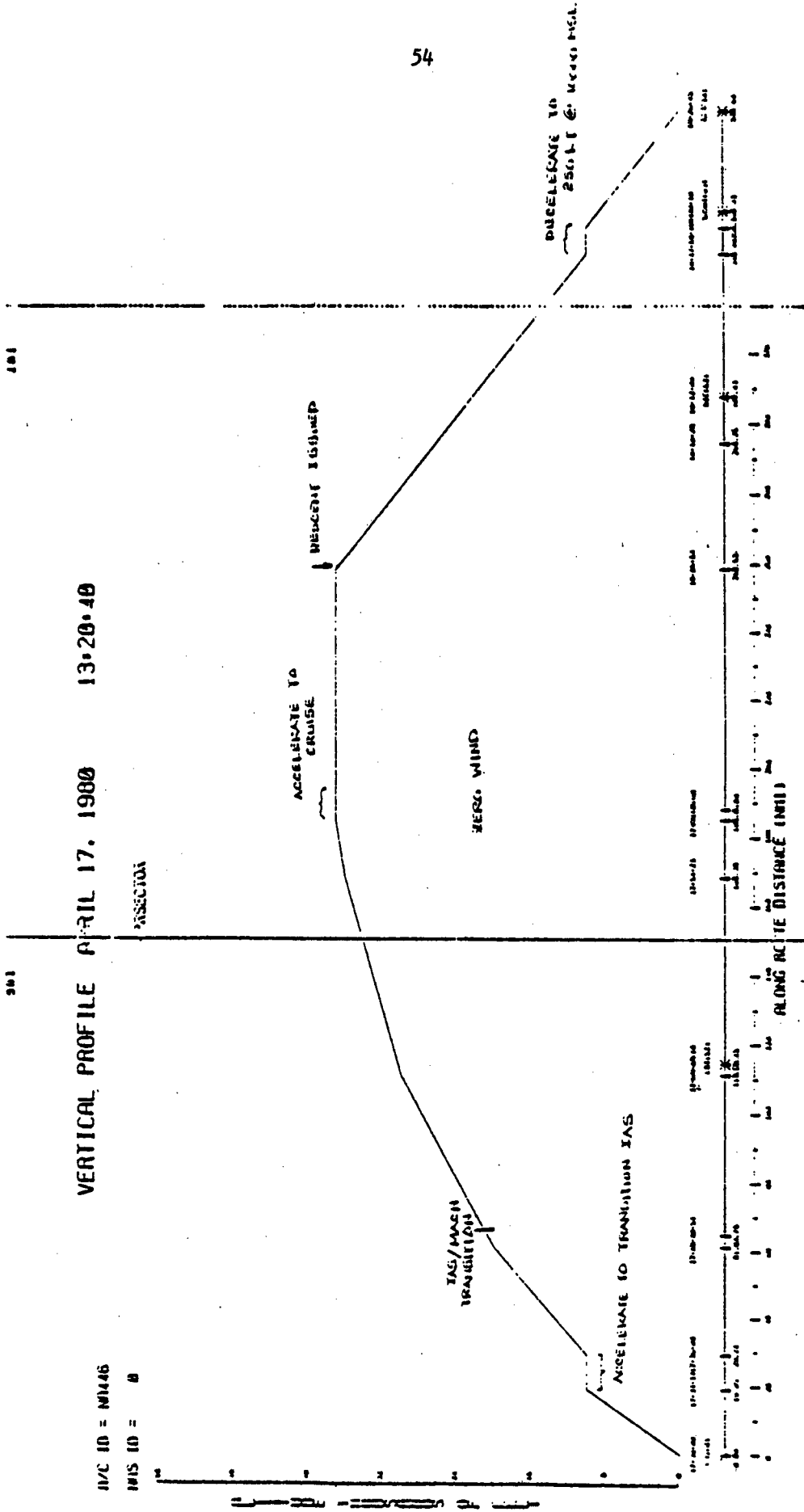

Figure 3-9

adapted Clearance Directives which apply (ideally none are required). Other Clearance Directives may need to be added after the flight trajectory has been processed for delays prediction and absorption planning, as well as conflicts prediction and resolution planning, in the Conflict, Delays Prediction function shown in Figure 3-11.

Each Clearance Directive has an activation point marked as an along-route distance measured from the local trajectory origin. As described later in more detail, a clearance prompt is generated by the Association Checking function when the flight's track crosses the activation point.

In NAS Stage A, horizontal profiles are built, but vertical profiles are not. Crude ground speed profiles are built for fix times calculation, but are based on very limited knowledge of what the pilot is actually planning to do and current winds aloft. In AERA, a significant improvement is expected in the ability to predict where an aircraft will be in space and time. This will permit significant reduction in the size of the prediction and protection error buffers that would otherwise be required. Since these uncertainty buffers limit how efficiently the airspace can be utilized, there is considerable benefit to be gained in minimizing their sizes.

Beyond NAS Stage A, the concepts of Clearance Directive, activation point and clearance prompt are not incorporated in the NAS Stage A design.

3.3.2.4 Association Checking

As illustrated more explicitly in Figure 3-10, Association Checking is that function which compares the observed aircraft tracks with the projected flight trajectories. Significant deviations are dealt with as follows:

Figure 3-10

ASSOCIATION CHECKING

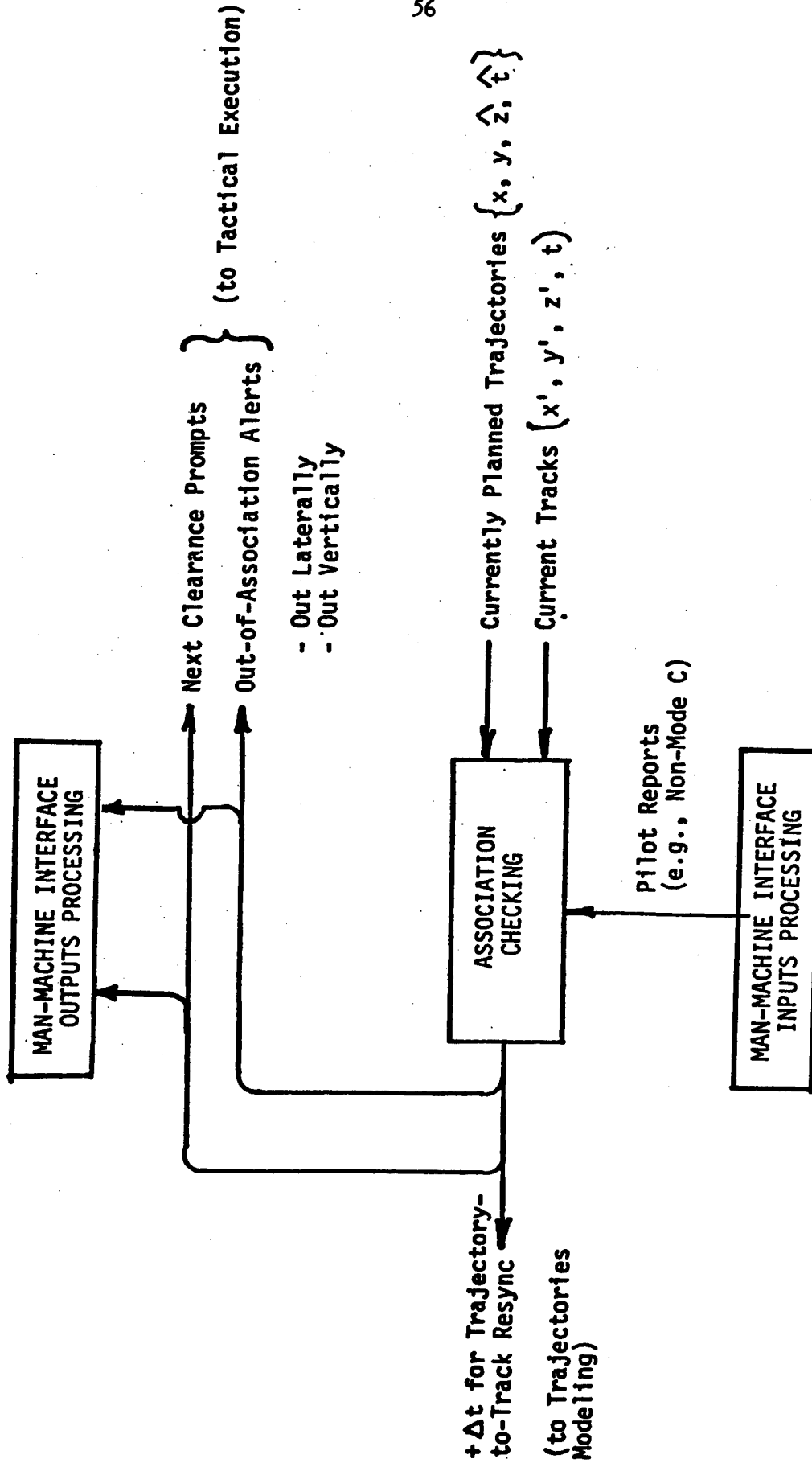

AERA STRATEGIC PLANNING FUNCTIONS & INTERFACES

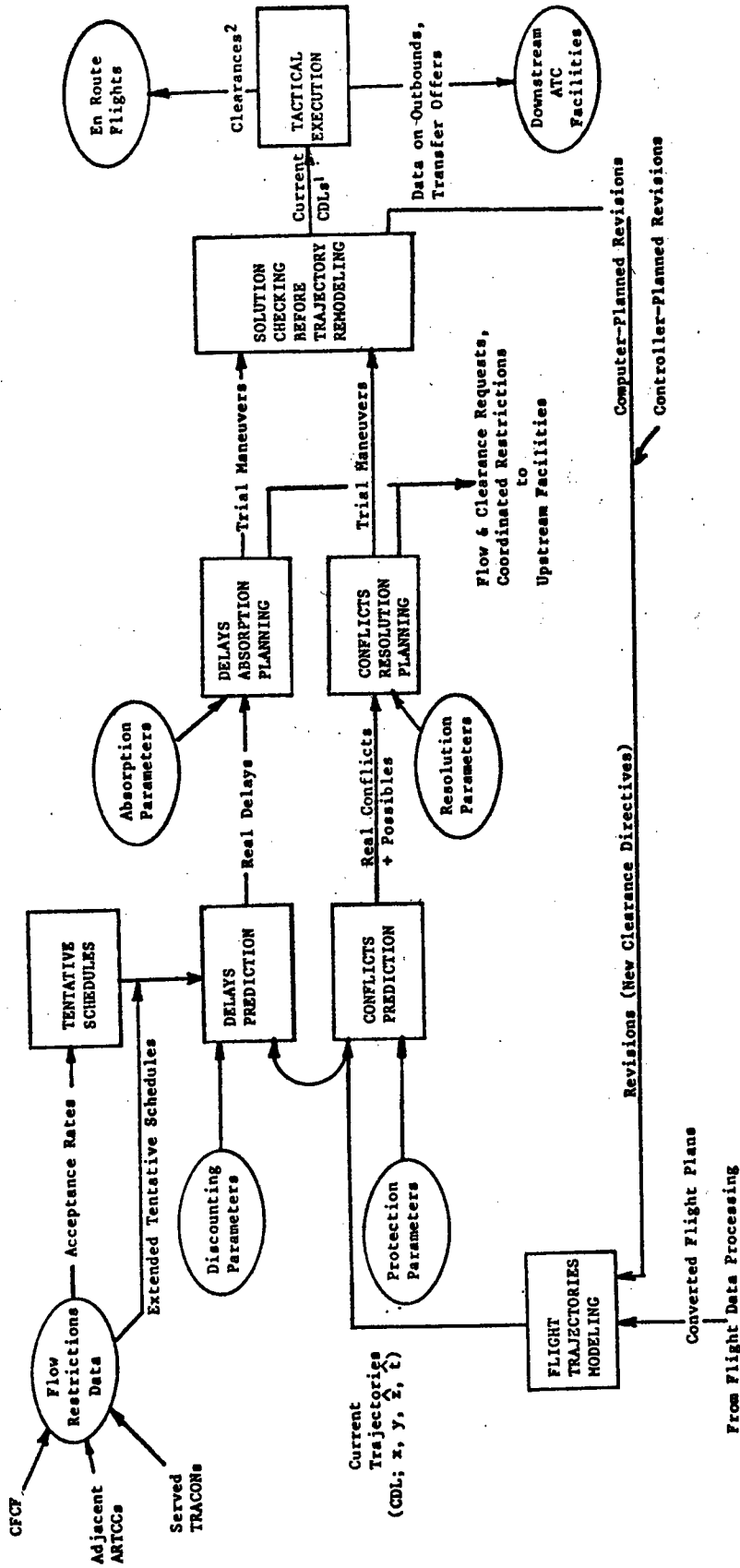

Notes

- 1 CDL = Clearance Directives List
- 2 Used in generic sense to include instructions & advisories.

Figure-3-11

Longitudinal deviations greater than a specified error threshold result in computed-time-of-arrival (CTA) updates being projected along the trajectory. Since progress other than predicted along the trajectory can upset strategic planning, such deviations may trigger replanning depending on their magnitude and their impact on other trajectories.

Lateral deviations sometime result from navigation errors following a planned courseline.* Nominal deviations are factored into the protection criteria used by the AERA algorithms. However, excessive unplanned deviations (blunders) are possible. They must be detected and processed. If a deviation is detected which exceeds that protected about the cleared route centerline, an "out laterally" alert is generated. "Out laterally" alerts are transformed into appropriate messages by the Tactical Execution function (for the pilot and any external ATC facility which might be affected). They are also made available to the Man-Machine Interface function for possible output to the controller(s) affected that are local to this facility as shown in Figure 3-10. See the discussion in Section 3.4.6 "Excessive Deviations from Planned Profiles".

Blunder prediction is also possible and might be a desirable enhancement. Such predictions would take into account current track speed and heading, given a deviation which is not yet a violation.

Vertical deviations from the planned trajectory can also occur. When a flight is level at its assigned altitude, conformance to within a few hundred feet is expected. When undergoing a transition to a new altitude assignment, the deviations relative to the trajectory's nominal vertical profile may be considerable, depending upon:

- a. The degree of pilot discretion permitted regarding pitch change points and climb or descent gradients, as well as

*Wide deviations may also be expected for weather cell avoidance and are discussed under the section devoted to "Severe Weather Avoidance".

- b. The tolerance given to flight technical error in navigating a prearranged profile.

However relaxed the criterion for vertical deviations from the nominal profile, unacceptable vertical deviations must be detected and protected against. An aircraft is considered out-of-association vertically if it exceeds the profile protection limits used by the strategic planning function in planning conflict-free clearances. If an excessive deviation is detected, an "out vertically" alert is generated. "Out vertically" alerts are transformed into appropriate messages for the Tactical Execution and Man-Machine Interface functions.

For an aircraft just beginning a transition along an agreed-to profile, profile deviation prediction might be possible.

Clearances which are yet to be issued to a given flight are triggered by activation points for Clearance Directives (which are defined subsequently). When the current track of an aircraft is detected to have reached an activation point along the flight trajectory, a "clearance prompt" is generated. This prompts the tactical execution of the associated Clearance Directive for automatically generated and delivered messages. It may also prompt the controller regarding any tasks for which he is responsible. Also prompted by Association Checking are voice frequency changes, flight data transfers and transfer-of-control responsibility offers.

While it is expected that all, or nearly all, aircraft served by AERA will be equipped with altitude-reporting transponders, provision is made for manual entry of pilot-reported altitude and identity by controllers so that track association may be maintained during the transition period and in those rare cases when the airborne equipment has failed.

In NAS Stage A, automatic association checking, exclusive of vertical association during climb and descent, is performed, but with less accurate trajectory and surveillance data than are expected to be available in AERA. The controller has to respond to all "out-of-association" alerts. NAS Stage A automatically generates handoff prompts where adapted but, since it knows nothing of planned clearances, it cannot generate clearance prompts.

3.3.2.5 Conflicts and Delays Prediction

For any flight with a newly planned or revised trajectory, it is necessary to find all conflicts and any flight delays produced by competition with the other currently planned trajectories. This function is performed by Conflicts, Delays Prediction shown in Figure 3-11. Since the plan at any point in time is vulnerable to prediction errors and subsequent events, periodic updating is required.

The flight whose trajectory is being submitted for conflicts and delays prediction is the "subject". The flights whose trajectories potentially compete with the subject are the "objects". Since only a minority of all the currently planned trajectories will possibly compete with the subject, logic filters, defined below, are used to reduce the set of objects to a relevant subset.

Conflict Prediction: Object trajectories which do not come close to intersecting are filtered out. Object trajectories which come close to intersecting, but whose passage of the intersection is widely separated in time, are filtered out. Only those pairs of flights which are not filtered out on these gross criteria are subjected to conflict prediction's "fine filter".

The fine filter checks to see whether horizontal separation will be lost with high probability. If so, it then checks to see whether vertical separation will be lost with high probability. If separation will be lost, the conflict is declared "real"

and posted for resolution planning. If separation might be lost, but if there will be subsequent opportunities to check again before committing to a final plan, no conflict is declared on this interaction. But if the time remaining to closest approach requires resolution planning before the next interaction and if there is any chance that the separation standard might be violated, a conflict is declared "real". This technique leads to a design for a variably selective fine filter which takes into account the conflict geometry, the estimated speeds of the two aircraft and the probable error in those estimates, the amount of deviation allowed in following their planned trajectories and the time remaining to closest approach. See Appendix 4 entitled "Strategic Conflict Prediction in AERA".

AERA reliably predicts conflicts as much as twenty minutes ahead of the estimated time of closest approach and identifies every potential conflict before the time to closest approach is less than five minutes.

Delays Prediction: Flights which are converging towards a common destination may exceed the traffic handling capacity of that destination, be it an airport or downstream ATC facility. Such saturable facilities may directly, or indirectly through a flow control authority, impose acceptance rate restrictions in any of several forms (so many flights per hour, at least x miles in trail, or as tentative arrival schedules relative to specified fixes or boundaries). Such externally imposed flow rate constraints are converted by AERA into time-ordered arrival queues relative to those facilities. At the outbound handoff fix for each affected flight, the difference between its desired arrival time and its projected arrival time due to traffic is its estimated delay. Because of the uncertainties of prediction, this estimate is discounted so as to avoid making arrivals unnecessarily late. Early arrivals are acceptable so long as they are within the range of downstream delay absorption tools. The resulting discounted delay for each affected aircraft is posted for delay absorption planning. See Appendix 5 entitled "Strategic Delay Prediction in AERA."

Whenever a flow rate restriction is established for a particular destination, queue formulation is begun. Flights are added to the queue when their flight plans are first received. Any change in that restriction will result in queue schedule changes, thus triggering recomputation of predicted delays.

Other Planned Actions: All flights, whether they have conflicts and delays or not, are generally transferred to a downstream ATC facility (ARTCC or TRACON). At some time prior to the calculated outbound boundary crossing time, the stored flight data must be transmitted to the next facility. Preliminary data may be sent to support initial planning by the downstream facility. More complete and accurate data may be sent later to support full planning by the downstream facility. The subsequent offer to transfer control responsibility must be made well before the flight actually crosses the boundary. In addition, before the flight crosses the coverage boundary between two RCAGs, or the control boundaries between two sectors, with different frequencies, a change-voice-frequency action must be taken. Each of these actions is planned in advance and is encoded as another kind of activation point in that flight's Clearance Directive list.

In NAS Stage A, an early version of the delays prediction function has been specified as part of the "en route metering" function now under development. Early versions of en route metering have been implemented at the Denver and Fort Worth ARTCCs. A "flight plan probe" function has been specified as a possible NAS enhancement, but no development of experimental NAS software has begun.

In both NAS Stage A and ARTS, automatic data transfer and offers to transfer control responsibilities are made to downstream sectors (ARTCC or TRACON), but controller action is always required for acceptance of track control responsibility. Change-voice-frequency instructions are not automated.

3.3.2.6 Strategic Planning of Conflict Resolutions and Delay Absorptions

Strategic Planning involves two primary functions: the prediction of conflicts and delays to be dealt with by AERA, and the planning resolution and absorption maneuvers to be employed if these problems persist. The result of this planning process is a set of currently planned trajectories which are conflict-free and metered. Another kind of planning function, discussed later, is the prediction of sector and facility workloads and a predictor of expected traffic densities. The supervisory position would be automatically notified of any projected saturations and would be provided with an appropriate range of flow control actions from which the proper action and its activation time could be selected.

As shown in Figure 3-11, the strategic planning function has the set of currently planned flight trajectories for its input and produces lists of planned Clearance Directives as its output, one list for each planned trajectory. The Clearance Directive List for each flight trajectory is a distance-ordered list of Clearance Directives. The distance to each Clearance Directive is computed by summing state segment lengths from the trajectory's local origin to the location of the Clearance Directive's planned activation point. Association Checking periodically notes the forward progress of each track in terms of its along-route distance and compares that to the distance of the activation point for the next Clearance Directive. When reached, a clearance prompt is sent to the Tactical Execution function.

The set of Clearance Directive Lists constitutes the current clearance plan for all flights in the system. The Tactical Execution function subsequently converts these planned Clearance Directives into the streams of uplink and crosstell messages required to execute that plan. If there is a need for a new Clearance Directive, it is fed back for trajectory remodeling and for checking to ensure that the replanned trajectory is in fact conflict-free and metered. As the planned flights progress through the system, trajectories are updated and conflicts and delays are periodically repredicted. Significant changes trigger a reexamination of the Clearance Directives planned for the affected flights.

The Clearance Directives in each list are particular applications of a family of ATC procedures. These procedures collectively represent all of the tools in the kit of good ATC practices. Such tools range from generic tools of broad applicability to very specific tools for special applications (possibly tailored to each facility). Each is designed to achieve a specific kind of tactical objective. A few examples are:

- A vector, either a dogleg or a parallel offset, to pass behind or by conflicting traffic (one or more aircraft are designated as traffic to be avoided by the maneuvering aircraft).
- A new altitude assignment, with or without pilot discretion, as to when pitch change is to be initiated. Crossing restrictions may be appended to ensure that the new altitude is achieved by a specified location, or that the altitudes protected for crossing aircraft at particular locations are avoided during the transition.
- A speed reduction to achieve a specified delay before reaching a point on the trajectory.
- A vector sequence, either a doglog or an S turn, computed to achieve a specified delay before reaching a point of the trajectory.

Clearance Directives can be adapted for use with aircraft that are RNAV equipped. The flight plans of such aircraft would indicate the proper equipment qualifier.

Clearance Directives would also be used to plan and effect the transfers of flight data and flight control to a downstream sector or facility. The transfer-of-control directive transmits an offer to transfer traffic control responsibility, and if

the offer is accepted, transmits a message to the transferred flight, instructing it to "contact ATC" on the next sector's voice frequency (ARTCC or TRACON). In a DABS environment, this process may be automated so that pilot and controller may not have to be involved in the process of changing frequencies, but the establishment of communication on the new frequency must be verified. If the next facility is an airport traffic control tower, the flight is instructed to contact the tower on the tower's voice frequency and AERA level service is terminated.

Conflict resolution is a function within the Resolution and Absorption Planning (Figure 3-11). It starts with two (or more) flights predicted to be in potential conflict with each other after all filtering processes described earlier. Conflict resolution must decide:

- Which aircraft is to be treated as "privileged", therefore possessing the right-of-way, and which is to be treated as "burdened", therefore having to yield the right-of-way.
- Which resolution is to be preferred in resolving the conflict. This can depend on whether the burdened aircraft is currently at its desired altitude or not, or whether the burdened aircraft is coming up on a change in course or altitude as part of its planned trajectory.
- If the preferred resolution does not solve the problem, the next best resolution is tried in the adapted hierarchy of alternatives until a workable one is found.

The tactic selected to resolve the conflict is expressed in terms of a particular Clearance Directive, with the parameter values of that directive computed from specific information concerning the capability and tracks of the aircraft involved in the potential conflict.

Delay resolution starts with the delay predicted for the subject aircraft, discounted so that the likelihood of over-estimation of delay is small. The most fuel efficient method (speed reduction) is tried first; the least fuel efficient method (holding) is employed only when the range or more efficient tools are inadequate to absorb the discounted delay. Fuel-absorbing vectors are usually reserved for absorption of any residual delays shortly before the outbound handoff point or clearance limit is reached.

The delay absorption strategy selected is expressed in terms of one or more delay absorption tactics, one Clearance Directive for each tactic, with the parameter values of each directive computed from the amount of delay to be absorbed and the airspace available for its absorption.

Exceptions to any predefined strategic planning logic, however sophisticated, are to be expected. For example, pilots will ask for special treatment, especially in emergencies. If an exceptional request* is made to the AERA system, the computer would refer such a request to the cognizant sector controller. Whether the request is referred to the controller by the computer, or whether it is made directly to the controller via voice radio or the down-link, the controller has the task of responding to the request. Controllers need to have access to all the displays and tools necessary to deal with these requests, such as ability to review, interactively modify or override computer-planned solutions.

In NAS Stage A, clearance planning and its execution in terms of instructions to pilots and coordination with other controllers is done manually by the flight data (D) and radar (R) controllers at the various sector positions. It is in the automated strategic planning and coordination of clearances, and in the automated tactical execution of that plan, that the AERA concept goes beyond any capability found in the NAS Stage A computer system.

*An exceptional request is one which is outside the bounds of normal handling rules, is unintelligible to the program, or which requests emergency handling.

3.3.2.7 Tactical Execution of Plan

The lists of currently planned Clearance Directives for all flights are presented to the Tactical Execution function as shown in Figure 3-11. They represent an agenda of control and coordination messages to be generated as illustrated in Figure 3-12. As each flight track reaches the next activation point, the association checking function issues a clearance prompt for tactical execution to begin. Tactical Execution begins monitoring the relative progress of the specific aircraft tracks involved and generates the necessary control actions. As the encounter situation develops, computations are made for the type, content and timing of the messages to be issued. These messages may be directed to one or more of the flights involved or to a downstream ATC sector or facility. The cognizant local sector is kept advised of all activities and is prompted when any local action is required.

Each Clearance Directive states an explicit tactical objective to be met by this flight. The tactical solution must satisfy any constraints established by conflict resolution planning, delay absorption planning, or an AERA sector controller who has interactively modified a trajectory. Each Clearance Directive can lead to no message or can result in the delivery of several messages. If the problem found and solved by the planning function has disappeared by the time the tactical execution function compares the tracks of the aircraft involved against the stated tactical objective, no message is generated. If, for example, the Clearance Directive is to pass the burdened aircraft safely behind specified privileged traffic, several clearances may be generated. The first clearance generated might call for a shallow left turn; subsequent clearances issued after the aircraft are seen to have safely passed each other might call for course modifications to resume a normal trajectory.

AUTOMATED TACTICAL EXECUTION AND SEPARATION ASSURANCE

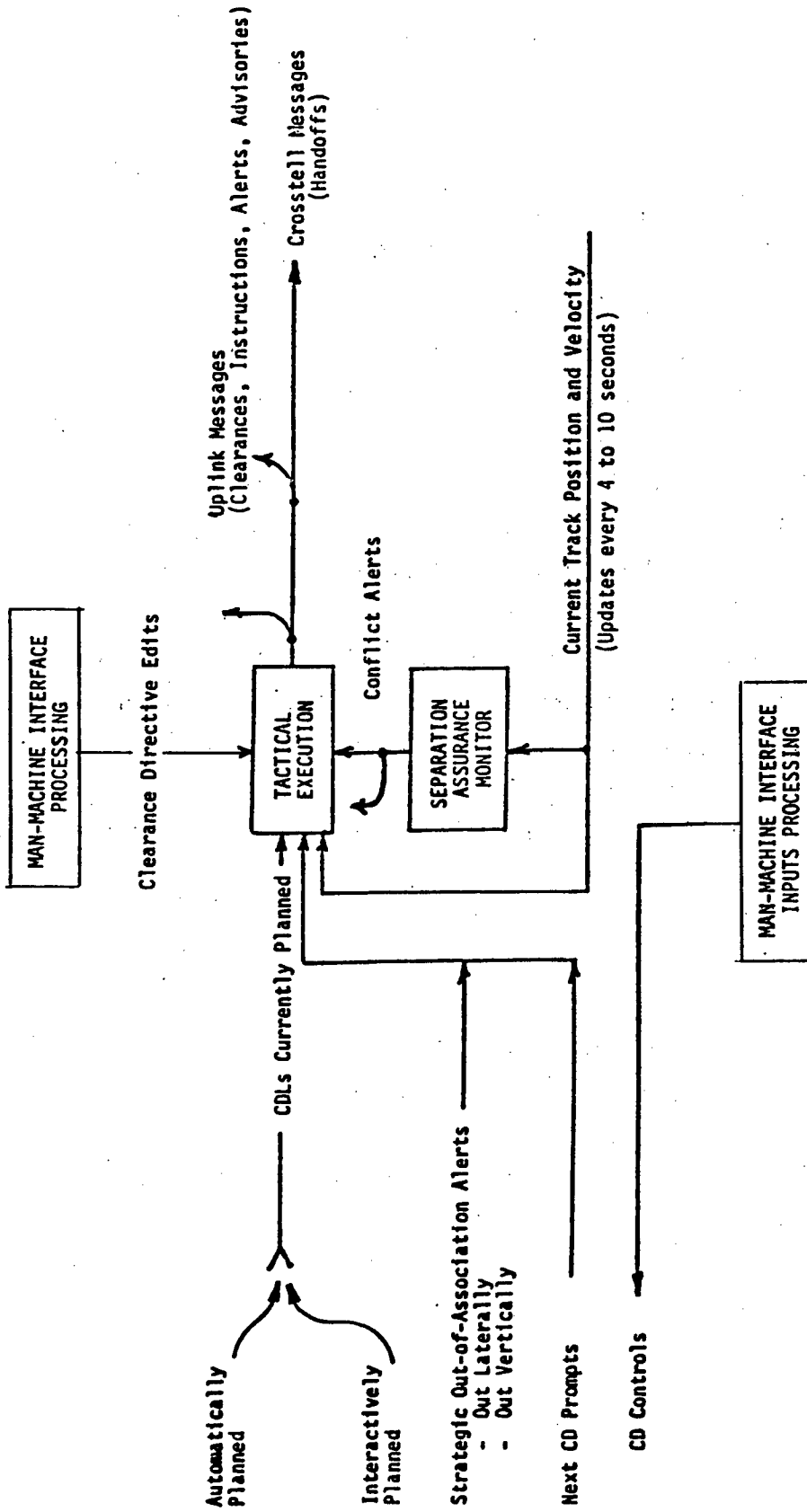

Figure 3-12

Tactical Execution is concerned with transforming the lists of outstanding Clearance Directives into up-link and crosstell messages. However, an occasional aircraft may be found to be deviating significantly from its planned trajectory, or two (or more) aircraft may be found converging on a potential separation violation, and the resulting "out-of-association alert" or "conflict alerts" must be dealt with immediately. Tactical Execution recognizes the relative priority of each type of input and deals with it accordingly. Out-of-association alerts are generated by the Association Checking function, while conflict alerts are generated by the Separation Assurance Monitoring function, discussed later.

Beyond NAS Stage A: There is no automated equivalent of this function in NAS Stage A. In NAS, the "Radar" or "R" controller must mentally perform the functions of clearance planning and tactical execution. He performs these functions based on his knowledge of flight intent (derived from posted flight strip data and from clearances previously issued) and of relative flight progress (derived from watching the scan-by-scan progress of tracked aircraft under his control). He executes his plan by coordinating planned clearances with other affected sector controllers by voice, as necessary, and by issuing those clearances by voice to the affected pilots at the proper time. In most cases AERA performs all these functions automatically.

3.3.2.8 Separation Assurance and Obstacle Avoidance Monitoring

Separation Assurance Monitoring is performed on a scan-by-scan basis and on all aircraft tracks, whether controlled or not. The objective is to see that (a) all tracked and controlled aircraft pass each other safely; and that (b) any uncontrolled tracks are safely avoided. Priority alerts are generated to the Tactical Execution function, and for the cognizant sector controller, whenever a potentially unsafe encounter is detected. Ideally, this function should operate independently of the Strategic Planning and Tactical Execution functions, so as not to mix what is planned to happen with what is happening.

In NAS Stage A, conflict alerts are generated by the computer as a means of backing up controller detection and resolution of conflicts. In NAS and AERA, the effectiveness of this function is expected to be enhanced through the use of DABS-derived tracks. The use of the Tactical Execution function to generate instructions to solve the problem identified by the separation assurance monitor does automatically what the controller must accomplish manually in NAS in a time-critical manner.

3.3.3 AERA Outputs

3.3.3.1 Ground-to-Air Communications

Ground-to-air data linked communications can be used to the extent that flights are equipped to receive data linked clearances, including real-time control instructions, traffic advisories and other information messages. Controller initiated messages can also be issued via the data link.

Several additional ground-based services become available for those aircraft equipped with data link and airborne computers. For example, an airborne computer might be used to query the AERA computer regarding down-route winds aloft, NOTAMS or other data valuable to in-flight planning. If Cockpit Displays of Traffic Information (CDTI) are installed as an optional cockpit feature, or as a supplemental tool for air traffic control, the AERA computer can be a major source of the data displayed.

To the extent that aircraft are not equipped to receive up-linked data, voice radio will continue to be used. Either computer voice or controller voice can be employed to transmit computer-generated messages over the sector voice frequency.

3.3.3.2 Other On-Line Data Outputs

Other on-line data outputs by the AERA system are directed to local consumers (e.g., Man-Machine Interfaces) and external facilities (e.g., neighboring ARTCCs, served TRACONs and Towers, CFCF, center area FSS and DABS sites providing uplink data coverage). Messages to upstream ATC facilities (CFCF and feeding ATC facilities) include flow restriction requests, coordinated restrictions, acknowledgements of forwarded flight plan or track data and acceptances of transfer-of-control offers. Messages to downstream facilities will include responses to flow restriction requests, acknowledgements of coordinated restrictions received, forwarded flight plan or track data, and offers to transfer control responsibility for specific flights.

The Man-Machine Interface function provides the output tools necessary for supervisors and air traffic controllers to keep current relative to their assigned responsibilities; to make planning, control or data entries; and to receive messages directed to them by (or via) the AERA computer system. Outputs to help these specialists keep current include displays of the current airspace situation (traffic, weather, etc.) and the state of the system; also selected predicted future flight trajectories and their possible interactions, based on current data. Other planning aids would include predicted states of the system regarding projected demands, resource availability and possible saturation conditions. Outputs to support planning, control and data entries include linked menus of possible inputs, input message preview areas and message editing tools, and quick responses to errored or illegal entries.

Messages directed to controllers from (or via) the AERA system include prompts or alerts requested by the controller, requests for a specific data item or decision, data on exceptional situations which are to be brought to the controller's attention, and data messages addressed from some other service to the controller's or supervisor's attention.

3.3.3.3 Capacity, Demand and Performance Monitoring

There are basically two ways of dealing with pending overloads within the ARTCC: (a) decombining sectors (adding sector teams) and putting additional computing power on-line; and (b) imposing flow, route or altitude restrictions in route, altitude or flow rate. To the extent that such problems can be predicted in advance, based on the loads implied by known trajectories, pending flight plans or flight schedules, resource allocation can be tuned to the projected demand. To the extent that unpredictable demands (perturbations) must be handled, extra capacity must be provided or traffic demand must be diverted. Such demands may show temporary peaks. For example, the passage of a weather front might cause a reduction in airport acceptance rates and thus holding or diversions to alternate airports, while at the same time there is an influx of airfiles from flights converting from visual to instrument flight rules.

AERA will make en route sector load demand and capacity predictions, prepare reports of current system status and provide the necessary displays and interactive tools for facility supervisors and sector controllers to handle these perturbations to normal demands.

REFERENCES

- 1/ Automated En Route ATC (AERA): Operational Concepts, Package 1 Description, and Issues, R. A. Rucker, The MITRE Corporation, McLean, Virginia, May 1979, MTR-79W00167.
- 2/ Automated En Route ATC (AERA): Briefing Charts on Proposed Goals & R&D Approach, R. A. Rucker, The MITRE Corporation, McLean, Virginia, May 1980, WP-80W00392.
- 3/ AERA Package 1 Test Bed Software Description - Build 1, Volumes I & II, L. Fellman, F. X. Maginnis, L. K. Borysiewicz, Eds, The MITRE Corporation, McLean, Virginia, October 1980, WP-80W00828.
- 4/ An Overview Description of Vertical Profile Modeling in the AERA Test Bed (Build 2), R. S. Conker, The MITRE Corporation, McLean, Virginia, September 1980, WP-80W00702.
- 5/ AERA: Conflict Prediction Performance Sensitivity to Speed and Route Center Line Deviation Uncertainty - Simulation Description and Sample Results, K. M. Levin and L. S. Oei, The MITRE Corporation, McLean, Virginia, May 1980, WP-80W00340.
- 6/ Automated En Route ATC (AERA): Preliminary Analysis of Metering Delay Controllability in the Package 1 Environment, R. S. Conker, The MITRE Corporation, McLean, Virginia, December 1979, WP-79W00800.
- 7/ Basic Horizontal Resolution Equations for AERA, J. A. Kingsbury, The MITRE Corporation, McLean, Virginia, June 1980, WP-80W00473.
- 8/ Effects of Winds on Angles for Horizontal Conflict Resolution in AERA, J. A. Kingsbury, The MITRE Corporation, McLean, Virginia, June 1980, WP-80W00411.

4.0 AERA System Integrity

The AERA system concept takes into account both those internal failures and external occurrences which disrupt AERA's ability to provide its services. These events, whether internal or external, are referred to as system perturbations.

There is a wide spectrum of potential internal and external system perturbations due to a great variety of causes. This requires a broad strategy to counteract the consequences of all identifiable perturbations, and great care to assure that all possible perturbations are identified. However, the strategy selected to provide reliability, does maintain safety even if the cause of a perturbation had not been previously identified. Finally, AERA is designed so that ATC will survive even catastrophic failures, for example, a complete center outage.

The required robustness of ATC, despite perturbations, places some general functional requirements on the design for AERA system integrity:

1. No AERA failure can put an aircraft at hazard.
2. No AERA failure can place a pilot or controller in a position where he cannot fulfill his responsibilities.
3. AERA's inherent total failure rate must be minimized. (Representative objectives are that less than one outage of an ARTCC per 20 years should be achievable and this outage should not last longer than one hour.) (Backup modes of operation during failure are discussed in Section 4.3.)

4. AERA must be able to recognize service failures before hazards to controlled aircraft can develop.
5. The AERA concept does provide for recovery from failures by automatically or semi-automatically reconfiguring with spare capacity.
6. AERA's restoration to full capability after a failure must be preplanned and expeditious.

Fortunately, these requirements on AERA can be satisfied despite the fact that failures may limit the flow of traffic.

The AERA concept is designed to accommodate specific kinds of failures, for example:

- a. Tower, TRACON or Center total or partial failure
- b. DABS/ATCRBS site
- c. VHF communication facility
- d. VOR/DME site
- e. Aircraft DABS/ATCRBS, VHF, or navigation systems

However, the AERA concept is not designed to accommodate multiple failures of contiguous FAA facilities, for example, two adjoining Centers. The probability of the simultaneous failure of two major adjoining facilities is considered to be so small, and the cost of designing a system that would be proof against such simultaneous failures so large, that it is not practical to have the AERA concept deal with this case.

Section 4.1 presents a general model of the AERA recovery process which is a useful framework for describing various options. The approaches for achieving reliability within AERA are described in Section 4.2. Finally, Section 4.3 describes the more obvious AERA perturbations and failure modes and various options to recover from these perturbations.

4.1 General Model of AERA Recovery Process

There is a general model of the AERA system's response to perturbations as depicted in Figure 4-1. The model postulates a number of illustrative AERA states and recovery processes which may be invoked after a failure. AERA operation, as described in Section 3, is considered the nominal state. An example of a perturbation to the nominal state is a failure in a single processor which places AERA in a disturbed state. The detection of the failure and its automatic replacement with a redundant processor is the stabilizing process. AERA is in a stabilized state when the redundant processor is on-line and the failed processor is off-line. The normalizing process, in this case, involves the replacement of the failed off-line processor with a working processor, so that AERA would have its normal complement of redundant processors and, therefore, be restored to its nominal state. This simple example of a failure did not impact, as it must not, safety of aircraft, or the traffic handling capacity of AERA. However, more substantial failures, such as total computer system failure or a catastrophe to an ARTCC, would require a stabilizing process that would assure the safety of aircraft under the jurisdiction of that ARTCC, and undoubtedly a limitation of traffic flow into the jurisdiction of the ARTCC commensurate with its or the ATC system's surviving capabilities. The value of the model shown in Figure 4-1 is that it makes explicit the various recovery processes and capabilities of AERA from first detection of a failure to complete restoration of the original capabilities of AERA.

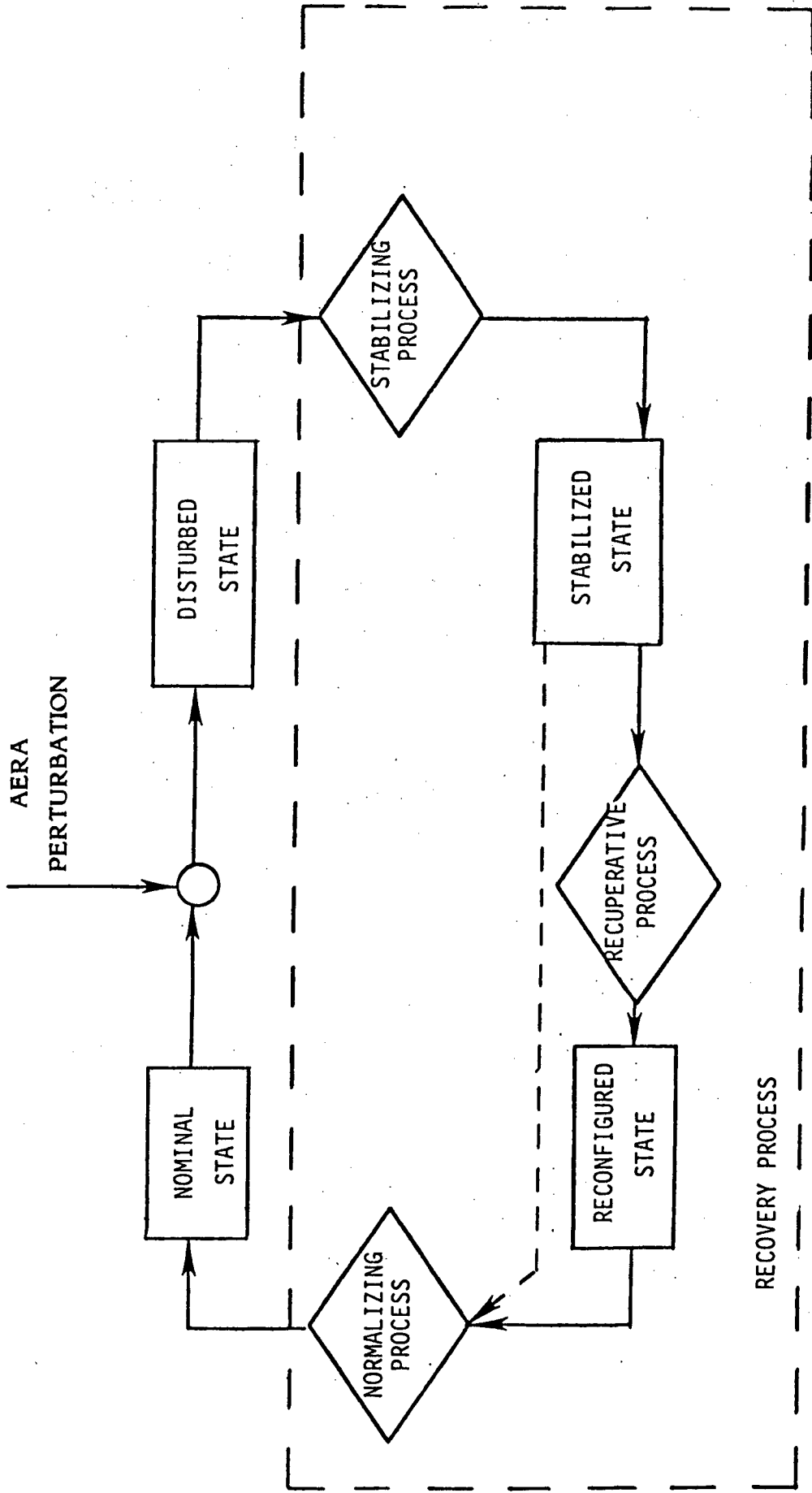

FIGURE 4-1

GENERALIZED AERA PLANNING REGION STATE CYCLE

4.2 Approaches to Achieving Reliability Within AERA

Many levels of redundancy and contingency planning are needed in order to meet the reliability requirements defined in Section 4.0, both within AERA and the ATC system, in which AERA is imbedded. This section discusses approaches to improving the integrity of AERA itself. The strategies for dealing with the great variety of possible internal and external perturbations are described in Section 4.3.

4.2.1 Appropriate Design Concepts

The following design concepts enhance AERA integrity.

- Modularize Functions: Use multiple computers, each supporting one or at most a few AERA processing functions. In effect, any failures are modularized, so they cannot violate the functional partitions. This modularization process should include:
 - Use of Small Partitions: Implementing fewer functions per computer leads to reducing the impact on the center of any given computer outage. It also provides quicker recovery and less complicated checking and testing procedures.
 - Provision of Functional Independence: Unrelated programs should not be grouped together in the same computer hardware. For example, a failure in a flight plan processor should not affect a radar target/track processor, and vice versa.
- Provide Modular Redundancy: All processors supporting AERA critical functions should be backed up by redundant processors. The number of redundant processors for each on-line unit should range from a fraction

(perhaps one backup per three operational processors) for less important tasks, to several for the more critical functions. Since any given processor will be supplying data to certain other processors at a higher level of data integration, its failure will degrade, if not destroy, the functions performed by other processors. Failure of a processor must be recognized and backup processors activated rapidly. This modular redundancy should entail:

- Use of Parallel Processing for Key Functions: Real-time validity checking by parallel processing can significantly reduce the effects of AERA system failures by providing an immediate system and subsystem backup.

- Implement Hardware and Software Performance Monitors: Performance monitors, alarms and automatic redeployment of assets should be provided. Performance monitors can take the form of hardware devices which measure CPU activity or the inclusion of software structures which record internal computer clock time at the start and end procedure. They can take the more specific form of test problems that broadly evaluate the performance of each processor periodically.

- Use High Reliability System Control Techniques: At some point any decision process converges to a single point. The design should be such that this convergent point uses highly reliable technology. The present NAS-9020 computer system and most other multi-processor installations are designed with a software executive to provide coherent operational control. For AERA, techniques should be selected that do not allow failure of the executive to cause complete system outages.

- Use High Reliability Software Techniques: State of the art source language, coding techniques, and general software design procedures should be employed to ensure reliable software implementation. The techniques include:
 - Screening Incoming Data for Consistency, Content and Range: Each software function should include program segments which validate the incoming data within known limits or values. This will limit output errors.
 - Minimizing Single Point Dependencies: Use diverse routes for the flow of data and system control codes through the system, and non-singular functional dependencies, such that no single-point failure can cause the system to fail.
 - Using Computational Checking Techniques: This can be accomplished, for example, by multiple independent algorithms, by simultaneous computation in different processors, or by a combination of these techniques. Voting on widely discrepant results or averaging of similar results can then be used to reach a final solution.
- Include Error Detection and Self-Test Hardware and Software: The AERA computers should be equipped with error detection capabilities for memory or peripheral read/write transactions, and self-test hardware and diagnostic software. These features often make it possible to trap failing computers and transfer them off-line before they have actually failed to perform the specified functions.

- Provide Real-Time Validity Checking: For critical AERA functions, the validity of output results should be checked continuously for reasonableness, either manually or automatically.
- Incorporate Independent Checks of AERA Outputs: For example, ATARS track files could be compared periodically with those used to predict conflicts within AERA.

Appendix 6 describes a computer architecture that meets the integrity requirements defined in Section 4.0 and fits the AERA concept.

4.3 Perturbation or Failure Modes and Recovery Concepts

There is a great variety of perturbation or failure modes that AERA is designed to resist. There is also a great variety of recovery options designed to handle each perturbation. The minimum recovery option for each perturbation is one that maintains a satisfactory level of aircraft safety. More elaborate recovery options can provide improved levels of aircraft safety during recovery, or can provide increased traffic flow before total recovery to the nominal state of AERA. These more elaborate recovery options are more expensive, but they also provide more capability. Cost-effectiveness issues will ultimately determine the extent to which the more elaborate recovery options are implemented. However, it is essential to implement the minimum recovery concept, that maintains safety during the period of any perturbation and the recovery period.

4.3.1 Total Loss of an ARTCC

The most drastic failure that could beset AERA would be the total loss of an ARTCC and its AERA capability with no surviving communication, surveillance or flight plan processing capability at the affected center. Current FAA directives

provide that individual facilities shall develop and maintain operational plans to provide continuity of service in the event of such emergencies. These plans are developed on a local level and, in the case of en route facilities, will generally provide for redelegation of facility airspace to adjacent en route facilities and underlying terminals in the event the parent facility is lost.

Although reasonable in concept, the current approach to backup has flaws. Primary among these is that the parent facility is not continuously sharing flight plan information and clearance information with backup facilities on all flights in the parent facility's airspace, and that backup facilities, in some cases, do not have surveillance and/or communications coverage for all of the redelegated airspace. Lack of backup facility controller knowledge of airspace areas to be assumed is another problem. Inasmuch as the total loss of an en route facility is a very low probability event, these flaws have been tolerated. Major failures of facilities, however, have occurred and, according to observers, the initial stabilization of the traffic situation was chaotic and reinstatement of reasonable levels of air traffic service was problematic. Some of these deficiencies could be partially alleviated in the current NAS system, however nothing as robust as the backup clearance concept of AERA is possible because of the required global planning capability.

Minimum Recovery Concept: In developing a concept for recovery from such a catastrophic failure, a guiding principle is that the system must be stabilized automatically and without dependency on controller intervention. The period of stabilization is one which is most chaotic for the affected and adjacent centers. Controllers could not be expected to organize a stabilizing process in time to assure safety. Furthermore, since the controller, in this minimum recovery option, performs the control function in the reconfigured state, the stabilizing process must automatically reduce traffic densities and flows to a level that can be controlled manually. In many control facilities there are overlapping communication and surveillance coverages with neighboring facilities and the exchange of

flight plan information, as well as supporting automation and display capabilities. In such cases, the controller in the backup facility does not have to rely on procedural techniques, and uses the tools available to him. However, the minimum recovery concept works even when the only tools he has are a list of backup clearances and communication with the aircraft responding to these clearances.

To accomplish the objectives of this minimum recovery option, AERA is designed to plan and update "backup" clearances. These clearances are transmitted to DABS and communication sites, stored there in buffers, and are sent automatically to those aircraft that were under the jurisdiction of the ARTCC when that center is judged to have failed. This judgment may be manual or automatic, depending on the level of diagnostics in AERA and the details of this failure mode. Alternatively, the backup clearances could be continuously transmitted to buffers located at the backup facilities, to be automatically transmitted to aircraft in case of center failure.

The functional form of the backup clearance varies for each aircraft:

- a. If an aircraft can safely proceed to an adjacent nonfailed airspace region under its current clearance, it is cleared to do so. Note that no AERA automatic clearance can be delivered along the remainder of its route.
- b. Aircraft that might conflict in future time along their current route receive a backup clearance to essentially hold-in-place, if it is possible to safely execute such a clearance. The clearance must not result in a holding pattern which overlaps that of another aircraft.
- c. If hold-in-place is not possible, special logic is used to layout an appropriate, more complicated clearance ("Proceed direct XXX, Hold").

The traffic holding in the failed airspace is then "drained" using, for each aircraft, procedural control from the designated emergency facility. Since the airspace situation was stabilized and there are fairly large time buffers available (e.g., minimum IFR holding reserves of 45 minutes), the controllers are not presented with an unmanageable workload peak.

One or more backup facilities have to be designated, whether they are adjacent centers or underlying TRACONS. These facilities have to have surviving links with the communication facilities that served the jurisdiction of the failed ARTCC or alternate communication coverage, and have to have the list of the backup clearances that have been issued. Each must have the list of backup clearances appropriate for its region and a surviving communication capability for aircraft in its assigned region. With this information and communication capability, the designated backup facilities can exercise control over the aircraft that remain. Radar control and flight plan processing would obviously be utilized in these backup facilities that have the needed surveillance coverage and processors.

If the center is not totally destroyed and if communications with the affected aircraft can be maintained or reestablished from the ARTCC, then the backup responsibility might remain at the failed ARTCC, a subject discussed more fully in Section 4.3.2. It would also be necessary that a record of the transmitted backup clearances survive at the ARTCC. Maintaining the emergency facility at the failed ARTCC has the advantage of utilizing controllers who are familiar with the situation when draining the airspace.

While there has been only a preliminary analysis of the backup clearance concept*, it seems that no more than 5 percent to 12 percent of the aircraft will need a clearance requiring extensive flying to an available holding area. Thus, the need for backup clearances should not place an unreasonable additional load on the computational capability of AERA. Furthermore, when one segregates traffic into

*"Feasibility of the AERA Backup Clearance Concept," MITRE WP-80W00588, July 1980.

categories, such as overflight or transitioning to arrival or from departure airspace, it seems that approximately 50 percent of the traffic can be drained by safely proceeding to nonfailed airspace regions controlled by neighboring ARTCCs or underlying TRACONS -- particularly if these regions can extend their responsibility to the limits of their surveillance and communication coverage as part of the stabilizing process. The surveillance and communication coverage of ARTCCs and TRACONS extends beyond their control region. The remaining aircraft should be capable of being safely conducted from the affected airspace by procedural control exerted from the emergency facility.

Whenever backup clearances are released, departure and hand-off restrictions are transmitted automatically to all control regions adjoining the affected region. Subsequent to the stabilization of the affected region, the level of traffic is limited by the surviving communication, surveillance and control facilities serving the region.

While this minimum recovery option and AERA itself does not depend on the implementation of DABS/ATARS, BCAS and CDTI, the recovery process could be enhanced if DABS were implemented and aircraft were equipped with BCAS and CDTI. For example, DABS sites may be instructed to provide an expanded type of ATARS service giving early warning of potential conflicts and appropriate resolution advisories, as a part of the Minimum Recovery Concept.

Higher Investment Recovery Options

In all options to be discussed, the stabilizing process utilizes the backup clearance stabilization concept, as described in the previous section. As will be shown, the major differences among the options are the nature of the recuperative process, the time to reconfigure and the level of service obtained in the affected AERA planning region in the reconfigured state.

Option 1: Both communication and surveillance sites are dual-connected to the designated emergency facilities, as well as to the ARTCC that they normally serve. Remoted communication and surveillance would then be provided to the appropriate boundary sectors. The communication and surveillance information could be provided to spare displays, such as exist in training labs. This would allow the opening of sectors dedicated to the assumed area in the event that the outage became lengthy. However, only procedural control, augmented with surveillance, could be exerted initially. The controllers would have to poll aircraft in their sectors to gather flight plan information before they could provide the most effective service. This increases the duration of the recuperative process as compared to more elaborate recovery options.

Option 2: In addition to the emergency facilities' responsibilities and capabilities, as described in Option 1, current flight data and clearance plans for aircraft in the AERA control region, would be continuously transmitted to each appropriate emergency facility and would be automatically provided to the proper emergency control positions. Assuming that sufficient controller personnel are available at the emergency facilities and that they are adequately familiarized with the sectors for which they are assuming responsibility, a level of service should be obtained that is comparable to that provided by NAS Stage A. Recuperation from the stabilized state would be facilitated since the emergency controllers would have flight plan information.

Option 3: As in Option 1, communication and surveillance sites would be dual-connected and flight data and clearance plans would be transmitted continuously from AERA in the ARTCC to AERA-type processing equipment in the appropriate emergency facilities. In this way, when called upon, the emergency facilities would be capable of providing full AERA capability in

the region formerly under the jurisdiction of the failed ARTCC. The number of controllers needed to provide this service from the emergency facilities would be less than the number required in Option 2, since AERA is more productive than NAS Stage A. The flow and density of traffic could be larger than in Option 2 because AERA capability is maintained from emergency facilities despite the failure of the ARTCC. However, there is a need to transmit data continuously from each ARTCC to emergency facilities, to maintain the AERA system and software in the emergency facilities and to maintain the proficiency of personnel in the emergency facilities to operate AERA type control equipment for their designated coverages.

Comparison of Options

Only detailed studies can determine the relative cost-effectiveness of Options 1, 2 and 3 as compared to the minimum recovery concept.

The availability of surveillance information in Option 1, as compared to the minimum recovery concept, closes the control loop. Such a system has the advantage of providing faster recuperation and significantly increased reconfigured state capacity over that of the minimum recovery option.

Lack of flight plan and clearance information at emergency facilities in Option 1 complicates the recuperative process. The lack of flight information problem is, however, mitigated by the existence of high quality surveillance data and good communication facilities. Given enough time, safe reconfiguration can be accomplished with these facilities.

The availability of flight plan information in Option 2 facilitates a rapid recuperation of the system to a NAS Stage A capacity level, assuming trained controllers can be made available. The AERA processing capability of Option 3,

permits rapid recuperation to the previous capacity with a minimum complement of controllers.

There is some question as to whether backup clearances should be issued under Option 3. If one can have confidence that AERA is operative in the emergency facilities and that the few controllers needed to operate it can be made available quickly in case of an emergency, then issuing backup clearances may be more confusing than continuing to operate in the AERA mode. The possibility of avoiding backup clearances under Option 3 has to be studied more carefully as the AERA program develops.

The relative capability of the minimum recovery concept and the three options is shown in Figure 4-2. It can be seen that traffic flow can be restored to higher levels as more elaborate options are implemented, and also the time to recover to a reconfigured state is likely to decrease as higher investment recovery options are implemented.

Figure 4-3 illustrates the connectivity and equipment requirements for the various options to enhance the capability of the minimum recovery concept.

4.3.2 Loss of AERA Capability at the ARTCC

Let us assume, despite the efforts described in Section 4.2, that AERA processing fails in an ARTCC, but that surveillance and communication capabilities survive. The minimum recovery concept consists of automatic transmittal of backup clearances to all aircraft in the affected control region, automatic transmission of messages to adjacent control regions shutting off inbound flow, and automatic alerting of supervisory and controller positions at the affected facility. If displays are still capable of displaying surveillance information at the affected center, radar control procedures will be used to clear the impacted airspace. If the

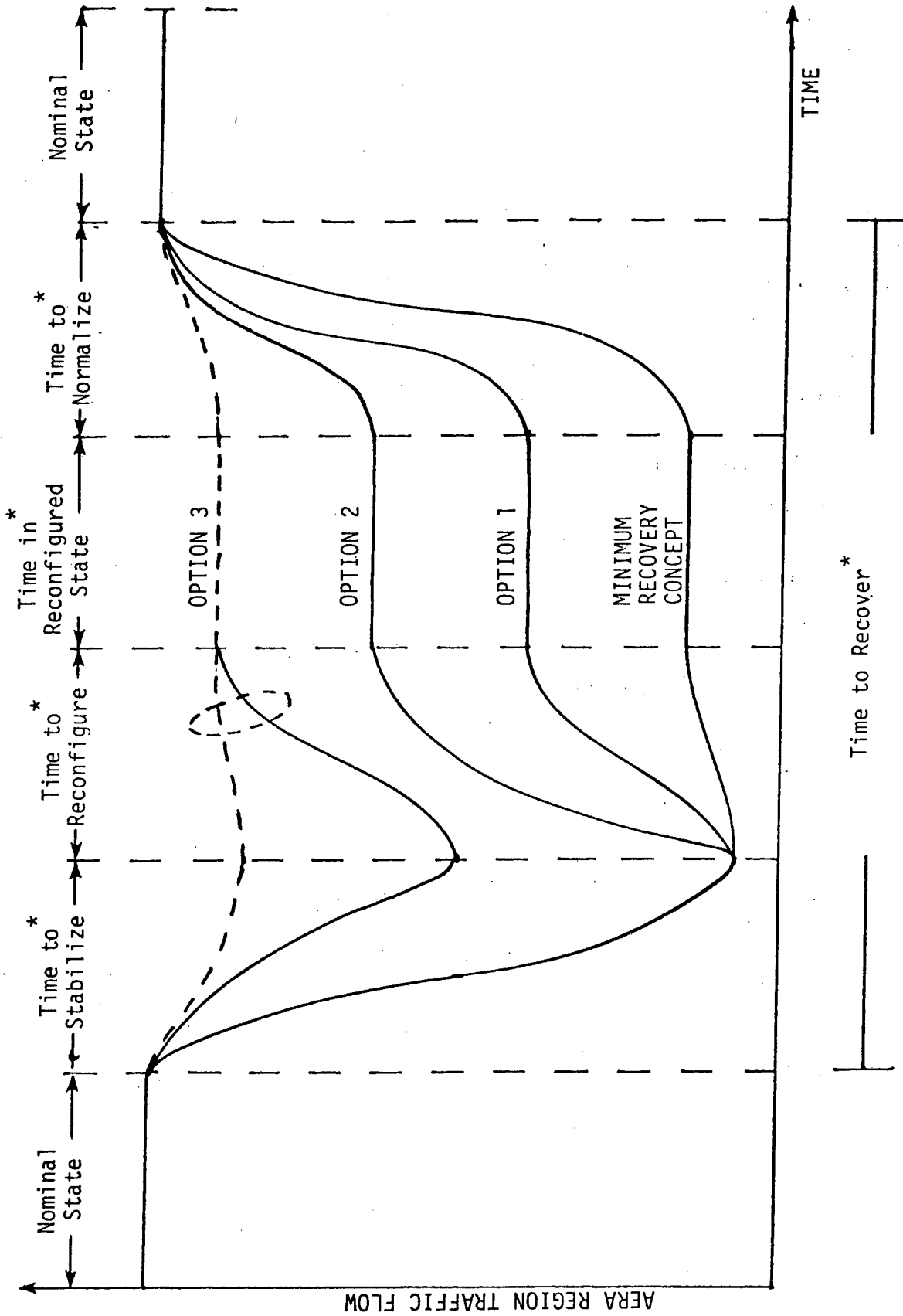

Figure 4-2 : OPTIONS OF ATC EN ROUTE SERVICE FOR BACKUP OPERATIONS

* In reality key time parameters will vary as a function of option.

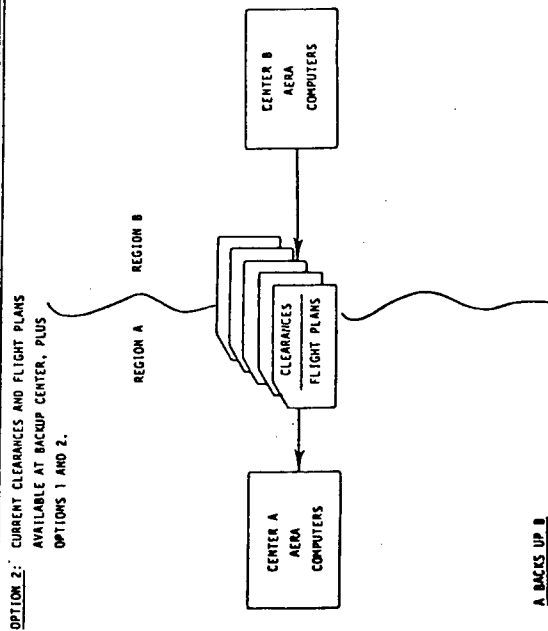
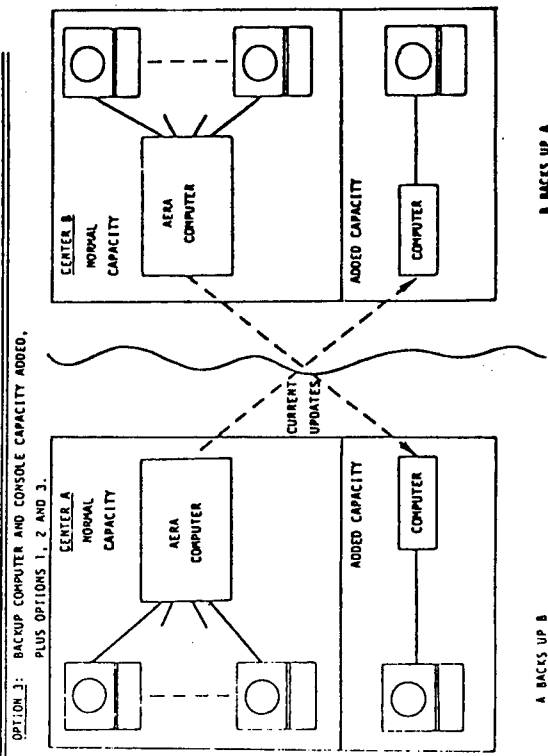
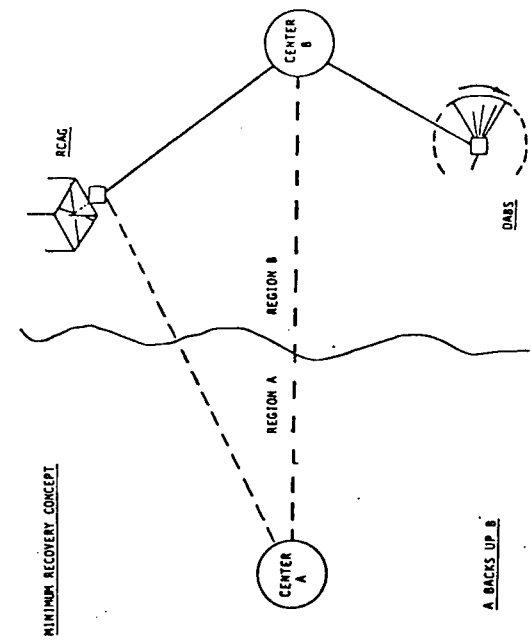
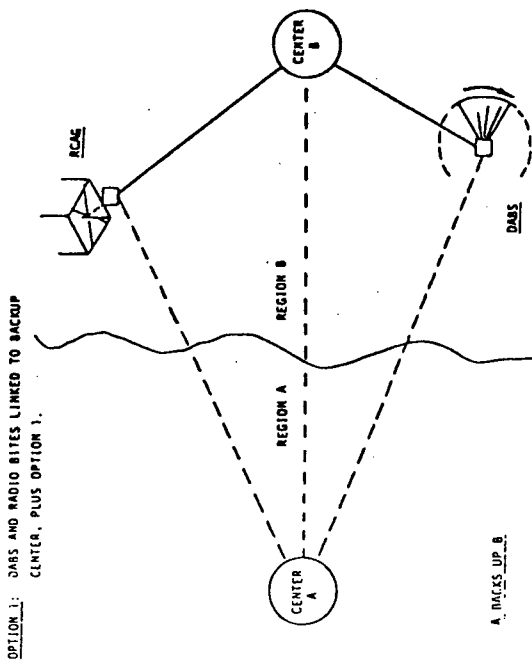

Figure 4-3 : OPTIONS FOR SEVERAL LEVELS OF BACKUP PROTECTION

displays have failed, along with AERA, despite the availability of surveillance data at the center, then open loop procedural control must be used. For this and other reasons, an ARTCC's displays should survive AERA failures.

If surveillance is available at the emergency facilities and not at the failed ARTCC, it is probably desirable for them to assume control from the affected ARTCC. While it is desirable to have the emergency facilities extend their responsibility to the limits of their surveillance and communication coverage, it is not desirable to have them take responsibility for procedural control beyond their coverage, since their controllers are not as familiar with the airspace as the controllers in the failed ARTCC.

From this stabilized state, reconfiguration to a NAS-Stage A equivalent operation can begin. Controllers in the affected center will survey traffic flight plan data and the backup clearances that have been issued. Responsibility shifts gradually to the controller as he begins to take control action, since he is responsible for those actions which he initiates. Boundary sectors begin to route traffic into adjacent control regions and as able begin accepting traffic from internal sectors. Through a steady process, the system moves toward taking all aircraft out of backup clearance status and placing them under active sector control. Once this condition is reached, the system is in the reconfigured state. Normal ATC system operation at reduced flow rates then continues until AERA is once again operative. The reduced flow rate is due to two factors, aircraft are under a NAS-Stage A type control rather than AERA control and the ARTCC is manned and scaled to AERA productivities rather than NAS-Stage A capability.

If higher investment recovery options were implemented, more expeditious traffic flows could be maintained. For example, if AERA processing capability has been installed at the emergency facilities and has been maintained and continuously updated from the center whose AERA has failed, the emergency facilities

can receive communications and surveillance data from the failed center and can ship processed data to the failed center to be displayed and transmitted as appropriate. Again this uses the controllers at the damaged facility to manage the airspace. They are most familiar with the airspace and traffic situation. In this option AERA utilizes surviving communication and surveillance resources with augmented computational resources at emergency facilities to generate AERA outputs which are then relayed back to the affected center. This option assumes that the Center design can:

- Ensure that AERA failures are independent of surveillance and communication failures.
- Ensure that relayed AERA outputs have a survivable interface with affected AERA controller display hardware despite the failure of the local AERA.

The AERA integrity concept does not contemplate the simultaneous failure of AERA processing and an adjoining communication or surveillance site, since as discussed in Section 4.0, the cost of protection against this most unlikely type of failure is likely to be very high.

4.3.3 Loss of Communications/Surveillance at an AERA Equipped ARTCC

A loss of communication capability is a disaster, whether an ARTCC is equipped with AERA or NAS Stage A processing. It is for this reason that FAA has provided the Backup Emergency Communications system (BUEC) which is designed to maintain a communication service that survives a wide range of failures. It is also for this reason that FAA has implemented redundant communication coverage over most airspace. However, in the unlikely event that communication fails in an ARTCC for a portion of the airspace, it is necessary to assure that the backup

clearances be automatically transmitted to aircraft in that airspace. The automatic release of backup clearances generated by AERA, in case of a communication failure, does provide a time buffer for establishment of an emergency communications capability. Such a buffer is not available with NAS Stage A.

In case of a loss of surveillance in a portion of airspace controlled by AERA and if multiple coverage is not available, it is necessary to transmit backup clearances to aircraft in the affected airspace and to shut-off flow into that airspace. Procedural control has to be used by AERA controllers to clear the affected region. Until surveillance is restored, only the limited traffic under procedural control can be permitted by AERA controllers in the region.

4.3.4 Loss of Some AERA Functions

It is more likely that AERA would fail partially rather than totally, and it is possible in the case of some of these failures to maintain traffic flow safely. For example, if -- despite all precautions -- the tactical executor and its backup fail -- AERA can be designed to display to an AERA controller the tactical decisions that have to be made. As long as the traffic was sufficiently light, so that a controller could make these tactical decisions and input them to the surviving AERA, the system could operate normally. As another example, if the metering function in AERA fails, but the metering requirement is displayed to the controller, he could input to the strategic planner a metering strategy -- "maintain aircraft 20 miles in-trail along route XX" -- and AERA could operate with a degree of normality.

A detailed schedule of failures within AERA that are not catastrophic, but that can be handled using manual inputs, has to be developed. Specific strategies and requirements have to be designed to handle each such partial failure.

4.3.5 Single Aircraft Perturbations to AERA Planning

Whenever an inbound or departing aircraft enters the AERA planning region, a full CD plan is generated. Replanning is required whenever a fully-planned flight accumulates sufficient longitudinal deviation from its expected forward progress. Replanning is needed whenever AERA or a controller revises a trajectory, perhaps because of a pilot request for a different route or altitude. In any of these cases, the planning begins with a proposed new trajectory being submitted for (a) delay prediction and absorption planning; and for (b) conflict prediction and resolution planning. The result is either (a) approval of the expected trajectory as submitted; or (b) proposed changes to this or some other flight's CDL.

If changes are proposed, each affected trajectory is edited appropriately and rechecked to ensure that it is conflict-free and metered. A key design requirement is that this process be stable and convergent to an acceptable solution in a time short compared to the flying time of the aircraft involved to the next activation point.

4.3.5.1 In-Flight Failures and Emergencies

Airborne equipment sometimes fails (e.g., voice radios, transponders, navigation equipment, data link communications, etc.) and occasionally an aircraft runs low on fuel, or suffers depressurization at high altitude, or for some other reason declares an emergency. The AERA system is designed to handle such problems.

The DABS data link can provide an alternative communication path in case of voice radio failure and vice versa. Prestored message formats with data menu selection or key pack entry for variable data can be used as a way of quickly generating the messages. For flights unequipped with data link, lost communication procedures would still apply. For example, the pilot would follow his last

clearance and other prescribed rules which permit him to reach his destination. ATC will separate other traffic from him, assuming that that will be his strategy.

Voice radio provides an alternative means for communicating altitude and position reports to the controller in case of transponder failure. The controller, at his discretion, can use these reports to manually update the flight's trajectory.

Tracked surveillance data can be used to locate and guide an aircraft relative to his planned flight trajectory in case of navigation equipment failure.

Voice radio provides an alternative communications path between the flight crew or the flight's computer and the controller or the AERA computer in case of DABS failure. Pilot/crew voice relay of down-link messages for controller data entry/action, and controller voice or computer voice relay of up-link messages for pilot/crew data entry/action, are the basic mechanisms.

In case of declared in-flight emergencies, the AERA system permits the controller to freeze an appropriate flight trajectory for the aircraft experiencing the emergency and to force AERA to plan all flights around it, thus giving priority to the flight that has declared an emergency. The trajectory to be frozen can be different from that planned prior to the emergency, or it can have enlarged protection dimensions built around it, depending on the nature of the emergency and the controller's judgment on how the flight should be handled. All the trajectory modification and protection parameter tools necessary are provided by the Man-Machine Interface function.

4.3.5.2 Excessive Deviations from Planned Profiles

Reasonable track association with the currently planned flight trajectory is one prerequisite for believing that any Clearance Directives planned relative to

that flight trajectory are valid. A track declared to be now out of association, or predicted to go out of association in a short time, is cause for an "out-of-association alert". Any of the following responses could be programmed:

1. Issue an out-of-association alert to the flight as a high priority data link message. Follow up with additional navigational assistance to regain association or ask the pilot to declare his intentions immediately.
2. Provide enlarged protection parameters about the trajectory until the out-of-association condition is cleared. Replan any flight which comes in conflict with the enlarged protected airspace.
3. Post an out-of-association alert to the Man-Machine Interface. If display of the alert has not been inhibited, the controller is informed of the situation.

4.3.6 Gross Perturbations to AERA Planning

External events, such as runway reconfiguration, airport closures, weather fronts or cells, navaid or neighboring ATC facility outages, can suddenly invalidate the current clearance directive plans for a number of flights simultaneously. All affected flights must be replanned in a manner which meets relevant safety and flow constraints. Further replanning must be completed and the plan executed (in terms of issued and acknowledged instructions) before each aircraft affected reaches its first revised activation point. Such replanning places additional demands on three kinds of ARTCC resources: computer, personnel and communications.

With regard to computer resources, the analysis of a particular case in Appendix 7 suggests that the excess capacity needed to handle such peak demands

is not a big increment over that needed to handle the peak period steady state demand. In the case analyzed, an airport accepting sixty aircraft an hour suddenly closes. It is assumed that the average replanning and reexecution time for all affected aircraft is five minutes. Given the assumption that the system is already handling an average load of 300 flights in the AERA control region plus 150 inbound flights in the AERA planning region, the incremental increase in computer capacity needed to redo the affected flights is approximately 11 percent. The implied limit on the number of computer operations that can be executed per second, given today's computer speeds, poses no real constraint on the sophistication of the AERA planning and control logic needed to meet such computational burdens.

With regard to personnel resources, AERA is designed to respond automatically to any gross perturbation. If a perturbation occurs, to which AERA cannot respond, it automatically relies on prestored and preprogrammed procedures that lower traffic flow rates and densities to levels that can be processed by the available personnel. Therefore, the need for controller involvement in the initial stages of the response to a perturbation is minimized. While a controller's decision may be required to initiate or approve a replanning cycle, the need for a fast response to stabilize the situation with safety legislates against significant controller involvement in the stabilization process. After the initial replanning is done and the time-critical messages have been transmitted, then controllers may become more involved to reestablish normal flows.

During the initial stabilization period, the demand for communication channels to execute the details of the revised plan puts a lower limit on the number of voice frequencies required, assuming computer voice is used for aircraft that are not DABS equipped.

4.3.6.1 Severe Weather Avoidance

To avoid severe weather, the pilot typically has two choices:

1. Request wider discretion laterally about his currently cleared route centerline, or vertically about his current altitude assignment, to avoid storm cells or to cope with turbulence.
2. Request a specific new altitude assignment or amended route clearance to overfly or bypass the disturbance.

If the need for rerouting is recognized by the ATC system, it typically has two choices:

1. Impose routing restrictions and clear affected flights via an alternate route selected to bypass severe weather, assuming the pilot accepts the alternate.
2. Advise each affected flight of the weather situation ahead and ask the pilot for his intentions.

In AERA, pilot-initiated requests for route amendments and different altitudes will be handled in routine fashion. If the pilot asks for greater lateral or vertical discretion (e.g., "Request fifteen miles left of route for the next eighty miles for weather cell avoidance"), the protection parameters used by AERA for protecting that flight's trajectory can be increased by the controller.

To support ATC planning of severe weather avoidance restrictions and rerouting alternatives, AERA provides a number of aids to facilitate the man-machine interface. Severe weather can be contoured and enclosed with airspace protection volumes. Such boxes might be defined and updated by the trained meteorologists at the Central Weather Service Unit (CWSU) position, using

computer-supported interactive graphics superimposed on color weather radar displays. Alternate routes around these weather enclosures might be defined by an appropriate ATC position on-line to AERA.

Restrictions and alternate routings can be read up automatically to all affected flights via data link or voice, along with a brief explanation of the cause. Pilots understanding the restriction, but desiring another alternative, could down-link their requests for AERA processing as in the case of any other flight plan amendment. Those desiring controller assistance may obtain it via voice radio or data link.

4.3.6.2 Airport Closures and Other Flow Restrictions

Any number of external events can slow or block the flow of traffic along one or more routes: temporary airport closures, sudden changes in airport acceptance rates, other bottlenecks. The net effect is that forward progress to the destination of one or more flights is, or will be, temporarily blocked beyond a certain point on each flight's trajectory. When such a condition is imposed, a clearance limit restriction is imposed on each flight along with an estimated Expect Further Clearance time. If the Expect Further Clearance time exceeds the pilot's desire to wait, then he may elect to be recleared to an alternate destination. If not, then forward progress will be delayed until the restriction is satisfied. If the affected flights are not to be rerouted, it is necessary that AERA handle the bulk of the workload associated with absorbing the necessary delays in a safe and efficient manner. This process is handled by the delay prediction and absorption tools previously described.

Strategically, AERA would identify the flights inbound to the clearance limit. It would form a queue of those flights with an Expected Further Clearance time appended to each. The difference between the Expected Further Clearance time

and the current Calculated Time of Arrival* at the clearance limit is the currently estimated delay. Discounting for prediction errors may be suspended since delay absorption tools beyond the clearance limit cannot now be counted upon.

The delay is allocated, if possible, to along-course speed reductions or to path-stretching vectors, if lead-time permits. If not, holding at the next available holding fix is required. This fix may be along the cleared route (including a "present position hold"), or off the cleared route, given controller approval for reclearance to the latter.

The availability of holding airspace, as compared to demand, will be monitored by AERA and posted for supervisory and controller utilization. Should holding airspace availability become a problem, the cognizant supervisor would coordinate the necessary restrictions to limit flow bound for the affected airspace.

Tactically, AERA would clear each aircraft into a holding pattern with Expected Further Clearance time advisories, issue the necessary speed reduction, or issue the necessary path-stretching vectors (dog-legs or S-turns relative to the cleared route). If present position holds are needed by the aircraft nearest the clearance limit, this would be dealt with first. Those aircraft being held would be cleared out of the hold as the terms of the restriction are satisfied. AERA would manage any altitude transitions necessary while aircraft are being held.

*The Calculated Time of Arrival is the computer's estimate of a flight's arrival time. It may not coincide with the pilot's Estimated Time of Arrival (ETA), although the two times should generally agree.

5.0 AERA and Airspace

The airspace structure is defined by a variety of air routes, bounded volumes of airspace and procedural agreements among ARTCCs, TRACONs and towers. Some of the elements of the airspace, such as Jet Routes, Standard Arrival Routes (STARs), and Standard Instrument Departures (SIDs), are applicable only to IFR aircraft, while other elements, including Victor Airways, sectors, control zones, prohibited and restricted areas, TCAs, TRSAs, involve aircraft operating under VFR as well. The airspace structure and traffic handling procedures has evolved in a way that permits as expeditious a flow of traffic as is consistent with the controllers' and pilots' ability to handle aircraft safely, given the various tools available to them. For controlled airspace, these tools include knowledge of intent obtained through flight plan processing and through the routing of traffic on fixed airways, confirmation of intent by tracking data, and a situation display. These available tools have constrained the horizontal and vertical separation of traffic to be accomplished primarily by in-trail spacing or merge sequencing with a minimum of crossing traffic within a sector. Furthermore, most of the transition airspace above an aircraft that is climbing or below one that is descending must be clear.

Limitations on the number of aircraft that can be separated in this manner by a single human controller have caused the airspace to be divided into many sectors, each the responsibility of a control team, and to constrain flight principally to airways traversing many sectors. The historical ATC process requires handoffs from controller to controller and subsequent VHF voice radio frequency changes. At times transponder code changes are also required as the aircraft proceed from sector to sector.

A computer, given aircraft flight plans and surveillance data, can readily track aircraft and search for potential conflicts in four dimensions, despite

numerous instances of crossing flight paths and complex conflict resolution geometries. These are the kinds of trajectories that would result from the use of many direct routings, profile descents and fuel-efficient climb-outs. A controller cannot predict potential conflicts with this unstructured traffic as expeditiously as a computer. The extensive data base and high-speed processing ability of AERA afford the opportunity for changing the control practices used to ensure compliance with separation standards, and possibly for some changes in the standards themselves.

As an example, consider the procedural cruise altitude restriction illustration in Figure 5-1. Until recently, short haul flights from LaGuardia (LGA) to Washington National Airport (DCA) were routinely restricted to a cruise altitude of 16,000 feet. This restriction was recently raised to 20,000 feet southbound. The reasons for this restriction, as reported in Reference 1, included the possibility of a crossing conflict with one or more JFK departures climbing out on westbound routes and crossing the LGA...DCA route at altitudes above 20,000 feet. Also, it was desired to keep the southbound traffic out of the overlying high altitude sectors to limit controller workload. The fuel penalty to the short haul aircraft was, however, significant: seven to eight percent for a B727 in standard atmospheric conditions. With the restriction now at 20,000 feet, that penalty has been cut at least in half. Similar restrictions are encountered by most short haul turbojets flying between Washington, D.C. and New York airports.

One possible solution to such procedural altitude restrictions is illustrated in Figure 5-2. The figure shows how the "conflict box" (see Appendix 4) concept in AERA might be used to eliminate the need for any fixed cruise altitude restriction. The illustration shows two departures out of JFK, one climbing to high altitude via Robbinsville and J64, and the other climbing to high altitude via the Freehold 7 standard instrument departure to Robbinsville to join J80. Potentially conflicting with them is a departure out of LGA bound for DCA.

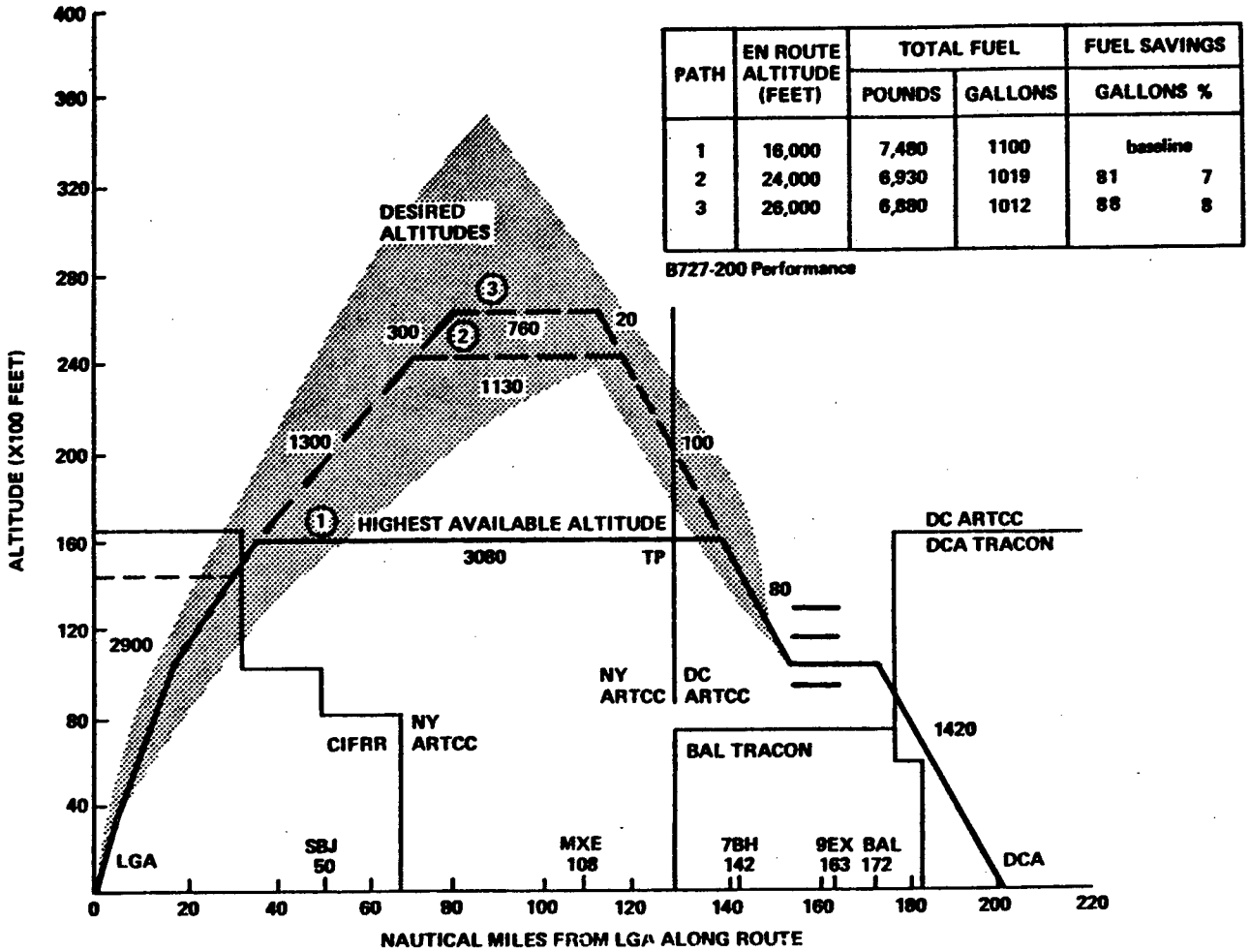

Figure 5-1
Desired Versus Available Altitudes for La Guardia to National Flights

Source: Reference 1/

Privileged Aircraft: JFK Medium & Long Hauls
 Burdened Aircraft: LGA Short Hauls
 Initial Clearance: "Climb & maintain 160, Expect higher before reaching 160"
 Probe-based Clearance: "Climb & Maintain 200"

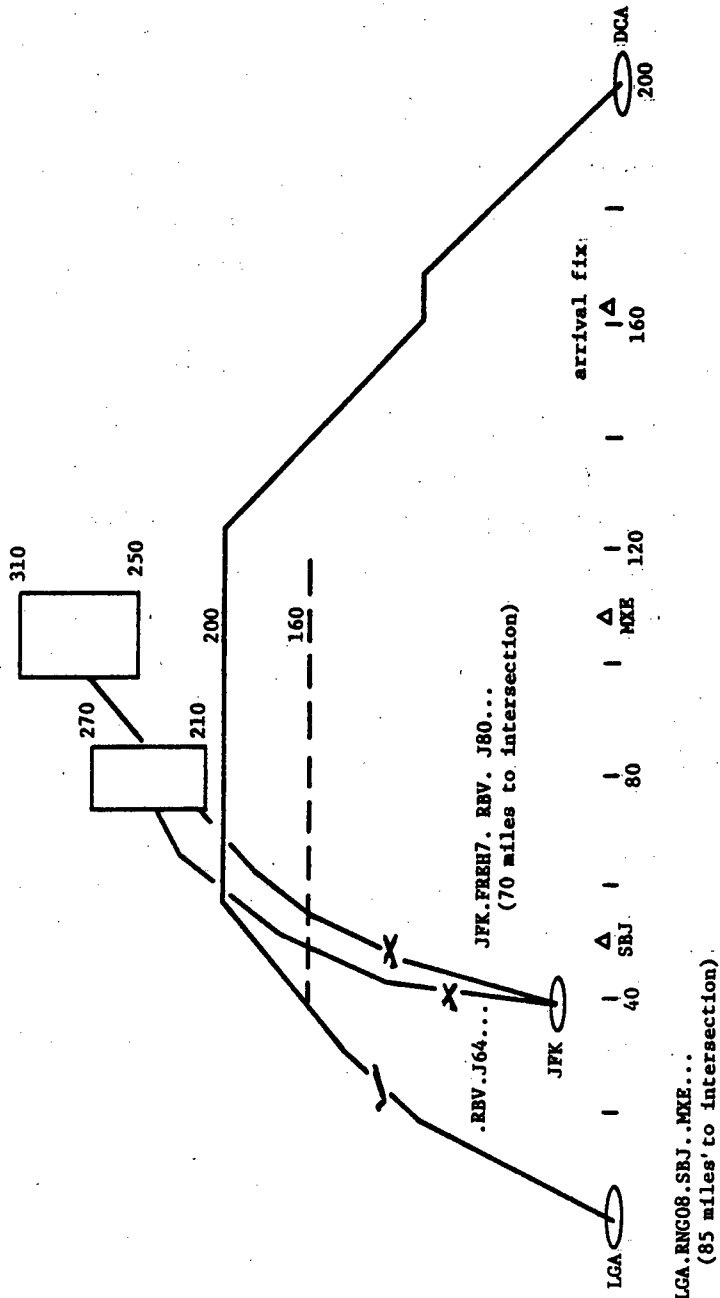

FIGURE 5-2

CONFLICT PROBE CONCEPT

In the Context of the New York Short Haul Problem

In this particular case, the computer has found that the highest available southbound altitude for the short haul flight is, in fact, 20,000 feet MSL. However, actual traffic statistics for these routes have shown that such encounters are relatively rare, approximately one percent of the time on the average and three percent during periods of peak traffic. This implies that in most cases, the altitude profile desired by the short haul flight would be found to be without conflicts and that the altitude restriction would not be necessary.

In summary, AERA would automatically predict whether the flight's requested profile is conflict-free or not, establish the assigned altitude as either the flight's requested altitude or the highest available altitude for a given conflict situation. This information would be utilized by AERA to generate clearances in the manner described in Section 3.

This example illustrates the kind of procedural restrictions that are often imposed on controlled flights operating in the airspaces surrounding the busier hub areas. Several efforts are underway in the context of the NAS Stage A system to see if such restrictions can be relaxed in the interest of fuel efficiency, but such efforts cannot sacrifice the requirements to maintain system safety under all traffic loads and to maintain controller productivity levels. Given these requirements and the constraints of current ATC system capabilities, it is proving difficult to remove or relax many of these restrictions.

However, highly automated ATC systems may themselves cause some types of restraints on airspace utilization. To some degree, the system failure and recovery modes that must be integrated with any automated system design restrict the extent to which more conservative guidelines can be relaxed. If any such failure occurs, the system design should allow rapid and effective system stabilization in a way that does not place the controller in an untenable situation. See Section 4.3.1. This requirement does impact airspace design and loading. In every

case, AERA's clearances will attempt to guarantee at least ten minutes of conflict-free flight, hence system stabilization has available, in general, that much time before backup systems need to be operational.

Using AERA, airspace procedures and structures are likely to vary significantly with time. Just as sectors are currently combined for handling by one control team during night time operations or other periods of low traffic density, sector boundaries within AERA planning regions can assume any one of several configurations to match the volume of traffic flow. Separation parameters and control practices would also be flexible, becoming functions of such parameters as wake vortex generating capacity of an aircraft, surveillance accuracy and update rate, avionics (including data link), and system load. The ability of an automated data processing system in which many parameters are resident to compile and maintain files of information on each aircraft in the system, enables AERA to use such information to prevent unnecessarily conservative separation procedures from being applied. This extensive use of available data will allow AERA to increase the productivity and capacity of air traffic control, while maintaining or increasing the current level of safety.

AERA's impact on airspace structure may lead to a reduction in the number of required radio frequency changes as aircraft proceed along their flight paths. Furthermore, while the controller will become responsible for communication with a larger number of aircraft than he currently handles, increased data communications should reduce the voice traffic over a single link during routine operations. During emergencies the recovery options proposed in Section 4 provide sufficient time for controllers to contact aircraft needing service.

AERA can be applied in most airspace. In positively controlled airspace the flight plans and surveillance data available to AERA allow it to provide conflict-free clearances with greater freedom of choice for the aircraft involved and with a

higher level of safety. In mixed airspace, AERA also may provide automatic traffic advisories because of its ability to predict conflicts involving VFR aircraft for which surveillance data are sufficient to establish reliable tracks. Such data may span the spectrum from only primary radar, if available, to the highest quality DABS information. Although AERA's tasks are simplified and the quality of its service improved in that high-density airspace where DABS transponders with altitude encoders may ultimately be required, AERA's success is not dependent on universal implementation of DABS.

VFR aircraft are able to take advantage of some of the features of AERA by requesting traffic advisories just as they do today. Even aircraft without transponders may be able to receive advisory services when the quality of primary radar data available to AERA affords reliable tracking. Such services could be conveyed by computer-generated voice over VHF voice radio, once the track was initiated and the aircraft identity established. A much higher quality service would be provided, of course, to transponder-equipped aircraft. The provision of a VFR flight plan would help AERA perform its functions in a mixed airspace, but would not be mandatory.

The flexible nature of AERA allows its features to be used up to some terminal boundary, approach fix or landing system marker to allow for subsequent fine spacing of terminal traffic. This terminal boundary or transition region also varies with time and traffic density to allow safe and expeditious flow of traffic to and from the ground. Thus, AERA is applicable to some transition airspace controlled by TRACONS, as well as to en route airspace.

The simultaneous use of both conventional air routes and direct RNAV flight paths in the same airspace is facilitated by AERA.

Airborne data gathering and transmission (weather, in-flight performance measurement and other data) are essential to the compilation of a complete data base that allows AERA to predict each participating aircraft's trajectory and, if necessary, provide conflict-avoidance maneuvers in the most effective manner possible. Although a DABS transponder with altitude encoder and data link provide a fast, reliable communication link that would make AERA more productive in high-density airspace, adopting a transponder IDENT procedure or providing a pilot with a simple touchpad used in conjunction with a standard VHF transmitter aboard smaller aircraft, allows AERA's productivity improvements to be rendered to a very broad segment of the aviation community. A full discussion of this is contained in Section 8.

Although AERA is basically a surveillance-oriented system, it is conceivable that procedural versions of the system could be developed and implemented for some airspace where non-radar procedures are currently employed. Oceanic regions and terminal island facilities like Honolulu and San Juan, for example, may be able to provide AERA services beyond radar coverage as long as safe separation procedures can be based on aircraft navigation and radio contact can be maintained. Within radar coverage, of course, oceanic and terminal island facilities can provide services in the same manner as continental centers.

REFERENCES

- 1/ ATC Accommodation of Fuel-Conservative Turbojet Operations, S. C. Mohleji, R. A. Rucker, B. M. Horowitz, N. O. Eaddy, The MITRE Corporation, McLean, Virginia, May 1978, MTR-7849.

6.0 The Controller and AERA

Controllers have had the responsibility for separation assurance and metering of traffic, whether procedural techniques, radar control using shrimp boats or NAS Stage A were employed. This responsibility can be delegated to pilots with their concurrence under appropriate conditions. In AERA, the controller has the responsibility for the system that provides separation and metering, but unless he is alerted by a pilot or AERA to an unusual situation, he is not responsible for routine separation and metering. AERA is designed to warn the controller of unusual situations and at that point the controller becomes responsible. Also, AERA is designed so that a pilot can request that the controller take command at any time. However, AERA is also designed so that a controller is never placed in an untenable situation. A conflict alert, generated by AERA's backup system, is provided in sufficient time for a controller to review and evaluate a potentially dangerous situation. The solutions proposed by AERA are transmitted to aircraft, unless the controller intervenes. In case of a massive AERA failure, backup clearances, as described in Section 4.3.1, stabilize the traffic until manual or automatic control can be instituted from adjoining backup facilities.

The controller is in the loop in today's system. The controller is not in the loop in AERA with respect to aircraft control, neither is he required to monitor clearances. AERA or a pilot might ask the controller to monitor or handle certain situations, but this is control by exception. The controller is the manager of AERA and traffic flow, but normally does not control individual aircraft. He is provided with system status, weather, traffic demand and capacity displays to perform his managerial responsibilities, as described below.

In this manner, the controller is relieved of routine, which should minimize errors, and has the more rewarding responsibility of creatively using ATC and AERA assets to satisfy traffic demand.

6.1 General Controller Responsibilities

In today's ATC system, the responsibility for the provision of separation and other ATC services is unambiguously assigned by the establishment of sectors. AERA does not eliminate the need for the unambiguous definition of responsibility. It requires that responsibility not only be clearly defined between individuals, but between individuals and machine as well.

In an AERA environment, responsibility would continue to be assigned by precisely defined boundaries. AERA sectors, significantly larger than today's sectors, are defined to assign controllers to specific airspace areas. AERA airspace areas are differentiated from airspace areas where conventional ATC techniques are employed. Within AERA airspace areas, AERA assumes the responsibility for the separation and metering of aircraft with the controller managing the assets of the AERA system and assuming control only by exception. Outside AERA airspace areas, the controller continues to assume full responsibility for the separation and metering of aircraft. During transition there may be airspace operated conventionally but with AERA tools available.

A major concern with control-by-exception concepts is: "Can an individual serve as an effective monitor or controller of a process in which he or she is not intimately involved?" This should not be a major problem in that the controller will continue to be involved in ATC processes even with the advent of AERA. The controller may be called on to resolve isolated potential conflicts, but he does not resolve every potential conflict. He is called on to review traffic flows, but not to meter aircraft. Furthermore, AERA is designed to fail in such a way that the controller cannot be overloaded, as discussed in Section 4.3.

At an AERA boundary, the neighboring controller managing aircraft conventionally, is given the tools for interacting with AERA so that aircraft can be

handed into and out of the AERA system. For aircraft entering AERA assigned airspace, the conventional controller is required to ensure that an AERA clearance is issued and acknowledged by the pilot before boundary crossing is allowed. For aircraft exiting AERA airspace, the neighboring conventional controller is required to verify that the existing AERA clearance provides separation from all known aircraft prior to allowing boundary crossing outbound. At the boundary the controller's role within the AERA assigned airspace is to respond to an AERA alert indicating that an aircraft is either entering or leaving AERA controlled airspace without the needed coordination and approvals.

6.2 Controller Requirements Within AERA Assigned Airspace

Within AERA assigned airspace, the controller is required to provide a variety of services. These services are discussed below under the categories of communications, finding efficient solutions, non-routine operations, unresolved conflicts, weather, holding and supervisory functions. While these categories are probably not exhaustive of controller functions using AERA, they represent a substantial portion of his responsibility.

6.2.1 Communications

In AERA assigned airspace, routine communication tasks are handled automatically. Aircraft which are DABS equipped communicate with ATC via data link. For non-data link equipped aircraft, routine transmission of clearances and information is accomplished by computer generated voice. Acknowledgement of clearances could be accomplished by a low-cost touch-tone panel adapted to the VHF/UHF link, or possibly by utilization of the transponder identification feature. A range of communication tasks are, however, left for the controller.

For non-data link equipped aircraft, the controller is required to handle all information received from the air that cannot be handled routinely by the methods described above. For data link equipped aircraft, the controller is required to handle communications not easily, or readily, formatted for data link. The negotiation process that takes place between the ATC system and a pilot when a clearance does not meet a pilot's desires or requirements is one example of this type of communication. The controller also becomes involved when clarification of a clearance is required and when emergency or unusual situations are encountered.

6.2.2 Finding Efficient Solutions

AERA software may include a routine which looks at the restrictiveness of planned clearances or the complexity of the plan controlling an individual flight. If, when compared to the diagnostic criteria, clearances are found to be excessively restrictive or complex, the controller would be alerted by the computer to the excessive complexity of the proposed clearance. The controller would intervene if a more appropriate solution than the one embedded in the AERA algorithms can be developed manually.

6.2.3 Non-Routine Operations

There exist in today's ATC environment a variety of flight operations which occur frequently but require services other than separation from other aircraft and metering to the destination. It is not envisioned that AERA software can be developed to handle each and every type of operation that can be expected. Controller involvement can be anticipated in such operations as aerial refueling, formation flight join up and breakup, fuel dumping, and parachute jumping.

There also exists a large number of types of unusual operations which require priority handling. In some cases the call sign in use will identify the need or type

of priority required; in other cases the controller is required to provide this information to the computer (system). In any case, it is envisioned that for these types of operations the controller is required to remain cognizant of, and in some cases, assume responsibility to ensure that the service provided is consistent with the needs of the flight. Examples of the types of operations which require priority handling are emergencies, lifeguard flights, SAFI flights, Navy "Special Call Sign" operations, and so on.

6.2.4 Unresolved Conflicts

While AERA software must be thoroughly tested, the possibility exists that the AERA algorithms will fail to resolve an aircraft conflict. As a backup to normal AERA conflict resolution, an independent separation assurance monitoring function is planned. In the event that this conflict alert is triggered, this backup AERA function alerts the controller to its planned resolution and is prepared automatically to issue avoidance instructions, if the controller does not intervene. The conflict alert function would not normally be triggered, and the controller should be made aware only of abnormal events. However, the controller is not made responsible for a time-critical decision, as AERA will be prepared to resolve the conflict. The controller may also be required to issue instructions to reestablish the aircraft involved on its flight plan, although it is conceivable that AERA software could accomplish this.

6.2.5 Weather

AERA would continue to utilize the same approach to severe weather avoidance as today's system. Specifically, those aircraft with the ability to detect areas of severe weather will be allowed the freedom to navigate so as to avoid these areas as long as the limits to pilot discretion are defined. Aircraft without the ability to detect severe weather will be advised of the weather information

available and will be provided avoidance assistance if it is requested. (Flow control actions as methods of coping with large areas of severe weather are discussed in Section 6.2.7)

The pilot of an equipped aircraft requests authority to deviate within given bounds for the purpose of weather avoidance. The AERA system expands the protection volume for the aircraft consistent with the request if there are no potential conflicts and then approves the requested deviation, as described in Section 4.3.6.1. It is possible that the request and approval can occur without controller involvement assuming appropriate aircraft equipment. If, however, the request for deviation results in a conflict and AERA's proposed resolution of the conflict is unacceptable to the pilot, then a negotiation process has to be undertaken to arrive at an acceptable solution. This negotiation process may result in an alternate avoidance action on the part of the affected aircraft or in a restriction on the traffic interfering with the proposed conflict resolution. In any event, this negotiation process might require the controller to devise alternatives acceptable to the aircrew.

Some aircraft may become equipped with cockpit displays on which appropriate weather data could be shown. It is planned to transmit weather data appropriately filtered to aircraft by means of the DABS data link. Aircraft not equipped with DABS or displays have to receive this data verbally from the controller. Controller involvement with those aircraft that are not equipped with weather sensing equipment or DABS and cockpit displays, is likely to be substantial. If significant weather came in single, well defined, easily described areas, this would not be the case. Areas of significant weather, however, often are scattered over wide areas in difficult to describe patterns. Providing the pilot with sufficient information upon which he or she may base a request for assistance often requires a detailed description of what is being observed and transmission of information as to what other aircraft have experienced.

6.2.6 Holding

Implementation of DABS and a high level of DABS transponder equipment would permit surveillance to be maintained for aircraft in holding stacks. With this surveillance, the successful development of efficient holding pattern management algorithms is likely. Without DABS, and the resultant ungarbled surveillance of holding patterns, however, AERA management of holding patterns requires continuous input of altitude updates by either the controller or pilot. Additionally, non-surveillance based management would likely result in inefficient flow from holding-patterns. Given these problems, without ungarbled surveillance, a large part of the burden of managing holding patterns falls on the controller.

6.2.7 AERA Supervisory Functions

An AERA supervisory position from which functions equivalent to those currently performed by the flow controller is incorporated in AERA. The individuals staffing this position will use information on airport acceptance rates, system perturbations, and weather information in conjunction with sector workload and traffic complexity diagnostics to determine the need for such actions as flow control, resectorization and traffic flow rerouting.

6.3 Controller Interaction

As discussed in the preceding section, it is anticipated that although AERA significantly reduces controller workload by taking over routine functions, controller involvement in ATC processes continues to be required. In the following two subsections there is a brief discussion of the levels of controller interaction and the displays which allows this interaction.

6.3.1 Levels of Interaction

Two fundamental levels of controller interaction with AERA processes are anticipated. These are open loop interaction and closed loop interaction.

Although certainly an exception, it is anticipated that a controller may wish to take over control of an aircraft and for the sake of expediency may not for a time wish to input all clearance items to the computer. In this event it is envisioned that a computer entry by call sign will disable routine AERA conflict resolution for the identified aircraft. The controller then assumes full responsibility for separating this aircraft from all other traffic. It is anticipated that the controller can call up AERA conflict predictions based on known information for the aircraft and that conflict alert processing is not disabled. Metering processing would also continue and would provide the controller with information as to necessary delay and possible actions to absorb this delay.

The category of closed loop interaction involves the full range of activities in which the controller imposes, for whatever reason, his wishes on the system, but allows the system to retain control of the aircraft involved. This category represents the normal manner in which the controller works with AERA. Examples of this type of interaction are as follows:

1. The computer proposes an altitude restriction for the resolution of a conflict, that the controller for special reasons is monitoring, but the controller believes the assignment of a heading would be more appropriate. The controller instructs the system to use heading assignment for resolution and advises the system which aircraft is to be turned. The calculation of the appropriate vector and the issuance of the clearance is left to the computer. The computer advises the controller if it finds any faults with the controller's plan. The controller may recognize that the computer found a problem overlooked by him, or he may choose to ignore the computer's reply and impose his own plan via an override.

2. The controller is informed that a particular aircraft must cross a fix at an altitude for a purpose not known to the system. The controller inputs the restriction to the computer. The computer formulates an efficient clearance plan based on this restriction.
3. The controller designates a flight as requiring priority handling. The computer bases all resolutions on providing this aircraft priority.

It is envisioned that AERA displays provide planning tools to allow the controller to fully assess the impact of his actions. A control instruction imposed by the controller in closed loop mode is therefore taken as a system constraint. If this control instruction creates conflicts with other aircraft and resolutions for these conflicts are not specified, AERA takes appropriate action to resolve these conflicts within the latitude allowed by the specified instruction.

6.3.2 AERA Displays

AERA displays are an outgrowth of those in use in today's en route environment.

Current sector data displays consist of a plan view display, two computer readout devices, and flight progress strips. While information can be called up on the computer readout devices, these devices serve primarily as preview areas with most actively used data displayed either on the plan view display or on the flight progress strips.

The plan view display displays aircraft radar targets with histories to provide an indication of velocity and turn rate. Associated with each target is a data block providing information as to call sign, assigned altitude, actual altitude and ground speed. This display provides the information necessary for the controller to quickly assess the immediate traffic picture.

The supplemental information necessary to allow more long term projection and fuller understanding of the traffic flow is provided by the flight progress strips. The flight progress strip provides information as to aircraft type and route of flight and currently serves as a location to keep a record of clearances issued.

This presentation of traffic information has proved effective when the controller is in the loop, responsible for traffic flow and safety. A trained controller can look at a plan view display and obtain an immediate assessment of the situation. In a heavily proceduralized environment, the plan view display alone can provide almost a complete traffic picture. The information provided on the flight progress strips acts to complete the traffic picture and becomes more important as the number of non-standard operations increase.

In AERA, a plan view display continues to provide the traffic situation which is displayed today and electronic displays present the supplemental information, currently provided by flight progress strips. However, additional plan view display requirements exist.

In the initial stages of AERA implementation, sectors may be the same size as today's. As controller workload begins to decrease due to familiarity with the system and increased aircraft equipment, sector size can increase. This increase in sector size necessitates that either a portion of the plan view display be allotted or a second display be provided to allow isolating portions of the airspace for detailed observation.

The section or display provided for close observation can also serve as a clearance planning or flow display. Some examples of the kinds of information that might be called up on the planning display are:

1. A plan view display of an airspace area around a selected center point with a selected radius.
2. A projection of an aircraft's flight profile to a boundary for a selected distance or time. Two subsets of this display type are likely.
 - a. A projection taking into account only already issued clearances and displaying the point of closest approach for each aircraft projected to conflict with the subject aircraft.
 - b. A projection taking into account the effects of planned clearance directives.
3. A pair-wise display called up by call signs displaying unresolved point of closest approach.

It is envisioned that both the plan view display and flight data display area are flexibly designed to allow quick identification of and call up of desired information and ease of entry of inputs.

The appropriate displays for the additional information which will be needed by supervisors to support integrated flow management, severe weather avoidance and the other functions outlined in Section 6.2.7 has not yet been defined. More information will be needed than that currently displayed to the flow controller, and more work is required to define the Man-Machine Interface.

7.0 AERA and Aircrew

The aircrew would not experience any radical change in procedures when ATC utilizes AERA techniques. If an aircraft were DABS equipped, clearances would normally be provided by data link, with or without AERA. Aircraft could still be provided with VHF computer-generated broadcast clearances to preserve the information provided by the voice party line. Aircrews would hopefully acknowledge clearances digitally if DABS equipped. If equipped only with VHF communications, it is hoped aircrews would acknowledge computer-voice clearances digitally utilizing the ATCRBS SPI pulse or a touch-tone adapter to the VHF microphone.

The aircrew should have greater flexibility, once AERA is implemented, in selecting and being allowed to fly their preferred routes and altitude profiles with a minimum of procedural deviations. Flight plan requests based on flight management computers are likely to be honored since AERA trajectory profiles are based on down-linked or nearly equivalent data. Furthermore, AERA can safely monitor and control crossing and transitioning flights without clearing major airspaces below or above the aircraft and with reasonable time buffers on shared airspace, so that direct routings at optimum altitudes are routinely available unless traffic density is exceptionally high.

The aircrew should experience fewer holds when the AERA system is being used. They may, however, experience more en route speed adjustments in order to avoid downstream holds or S turns. AERA's superior planning capability, which reaches into TRACON airspace, provides this improved metering capability.

AERA, in conjunction with the 9020 replacement system, is able to provide the aircrew with many services depending on the equipment in the aircraft.

We assume that no aircraft can operate within the AERA control region without a minimum set of equipment: a transponder, VOR or VOR-DME navigation, and a VHF transceiver. The set of AERA services provided to these minimally equipped users is different than that received by those fully equipped. For example, if the transponder is not altitude-encoded, then the aircrew must provide the controller with altitude read-outs, adding to the work load of both aircrew and controller. The minimum-equipped users can receive only limited weather data over the radio as compared to complete weather displays transmitted by data link. Proximate traffic can only be provided verbally rather than in cockpit displays formatted by AERA and transmitted by data link. They receive clearances via radio instead of over the the data link. In short, the minimum-equipped users limit the productivity of AERA, increase their own workload and generally lower the level of services that can be provided. But AERA can accommodate them.

DABS data link cures most of these problems by providing a communications channel across which clearance, traffic, weather, and other kinds of information may be transmitted. Pilots can request information and have it delivered to suit their operational needs. A most positive feature of data link is the unambiguous transmission and acknowledgement of clearances; a time consuming and error-prone activity in today's system.

In addition of a flight management computer, which may be coupled to the aircraft's control surfaces and fuel management system, when used with the area navigation capability, allows the acceptance and use of extremely well-defined flight profiles. This allows the aircraft to fly whatever routes are desired in a precise manner. This allows the pilot to optimize the aircraft's profile while in-flight, changing strategies as the situation warrants.

AERA would lead to a noticeable increase in the quantity and quality of data exchanged between the aircrew and the ground control system.

8.0 Telecommunication Requirements for AERA

FAA is currently engaged in the development of an evolutionary new NAS Telecommunications System which will include a number of enhancements to the current system. The present FAA voice and data communications system has evolved over several decades. While it is generally considered to be adequate for today's manual and limited semiautomatic environment, it is costly to maintain and will not meet the projected requirements of the 1985, and beyond, operational environment, including new requirements such as may evolve from the AERA program.

The telecommunications system includes voice and data circuits for ground-air-ground and ground-ground communications between aircraft, centers, terminals, remote radio and surveillance sites, Flight Service Stations and various FAA national centers, such as for weather.

Studies of future communication requirements have identified an integrated concept for evolutionary development of subsystems to get the best benefits and capabilities of shared facilities, networks and switching. In conjunction with other ATC improvement programs, such as NAS 9020 replacement (9020R), FSS automation, DABS data link and AERA, FAA is developing and implementing several major communications upgrades.

One of these is the Voice Switching and Control System (VSCS), which will include upgraded versions of the present Radio Communications Subsystem (RCS) and the Voice Communications Subsystem (VCS). The VSCS will meet the future ground-air-ground and ground-ground voice control requirements for ARTCCs and FSSs while being supplemented by the DABS data communication system. Further enhancements may be required for non-voice control communications (e.g., VHF

tone encoding option), automated surveillance and other AERA requirements for communications.

Many data networks currently used in FAA are being replaced by the new NADIN. The NADIN will initially be centered on two interconnected switches, located at Atlanta and Salt Lake City, and will provide data concentrators at all twenty ARTCC centers. The NADIN enhancement program will extend this so that eventually the centers will become more fully interconnected and each concentrator will become a switch. Thus, before the AERA time frame the capability will exist for full direct center-to-center transfer of data traffic and alternate routing in case of node failure.

It is expected that VSCS and NADIN will form the backbone of the FAA integrated NAS telecommunications system.

8.1 AERA Ground-Ground Communication Requirements

In order for the AERA system to perform its functions it must receive surveillance and communication inputs from DABS, ATCRBS and the RCAG sites. As discussed these en route data input requirements are and will be met by the FAA independent of AERA since the en route center requires this information to carry out its functions.

AERA, however, has additional communication requirements which are caused by backup requirements for non-recoverable AERA hardware or software failures, as well as for catastrophic failures.

As discussed in Section 4 catastrophic failure will require as a minimum:

- Transmission of backup clearances from the RCAG and the DABS sites to affected aircraft.
- Transmission of backup clearance plans from each center to its backup locations.
- Communication capability at backup facilities to support the stabilizing process.

The center-to-center communications capability can be realized by utilizing planned NADIN center-to-center communication linkages. However, the buffering of backup clearances at DABS and RCAG sites, together with the logic for knowing when to transmit the backup clearance plans, is a new FAA communication requirement.

The requirement that RCAG sites be connected to adjacent centers or TRACONS, in case of catastrophic failure, is a new requirement for FAA communications if there is no overlapping coverage.

If any of the three options beyond the minimum recovery concept, presented in Section 4.3.1, are exercised to support a catastrophic failure, multipoint linkage of existing ATRBS and the newer DABS sites to primary centers and their backups become a requirement. Since several of the existing sites support two existing centers, it is not clear how costly or how many additional surveillance sites have to have multiple destinations in order to satisfy this backup surveillance option.

In case of non-recoverable AERA hardware or software failure, there is an option in design which utilizes adjacent center computers to perform tasks for the affected center and communicate this data between centers so that control

remains with the control managers of the affected center. In this case, surveillance data can be relayed together with other digital input data to the adjacent centers where such data can be processed and tactical plans relayed back to the affected center for evaluation and release. This option, if exercised, will not generate any new communication hardware requirement on FAA if the planned NADIN system is implemented.

8.2 Ground-Air-Ground Requirements

It is anticipated that the presently planned communications capabilities will meet AERA requirements for DABS data link equipped aircraft. However, for non-DABS data link equipped aircraft some additional communications capability would improve AERA productivity and is desirable, but not necessary.

As an aircraft flies through an AERA Planning Region, it moves from sector to sector, and concurrently its line-of-sight communications zone moves from ground radio to ground radio site. At appropriate times, the center instructs the aircraft to change its frequency so as to communicate via different ground radio sites.

For a DABS data link equipped aircraft, the ATC instruction to change frequency and the aircraft acknowledgement can be accomplished automatically (AERA knows aircraft position and frequency change boundaries) via data link without controller or pilot intervention. Communications planning can support all requirements for this case.

For a non-DABS data-link equipped aircraft, the ATC instruction must reach the pilot's ears and he must acknowledge overtly. If controller productivity is to be maintained in AERA, it is clear, as the above example illustrates, that a VHF radio tone encoding option would be helpful. Technology can provide a computer-

generated voice command capability that FAA can utilize to meet the uplink requirement in the AERA time frame without controller intervention. When an automated computer-generated voice command capability is utilized on the ground-air link, a means for automatic acknowledgement becomes desirable. A pilot-actuated device which generates specific signals easily demodulated and decoded on the ground is a possible approach.*

There are two options for digital pilot-activated devices. The first utilizes ATCRBS, while the second requires the purchase of a discrete tone keying device adaptable to the pilot's microphone and analogous to the miniaturized telephone tone key adapters now on the market for modifying a dial telephone to touch tone operation. The touch tone adapter could be designed to incorporate a digital transmission of aircraft identity, as well as acknowledgement.

The use of the special position identification (SPI) button on ATCRBS is attractive since there is no additional cost for the transponder equipped aircraft. This button places an additional pulse into a Mode A or C reply at 4.35 μ second following the last framing pulse. Once the button is set it will stay set for at least 15 seconds and as much as 30 seconds. Thus, the SPI pulse is guaranteed to be transmitted on each reply of the set of interrogations received by the transponder on en route interrogation scan. This technique is simple but provides only an acknowledgement of a received message, but no verification of the message content. In order to improve the reliability of the link a procedure could be employed whereby the ground computer voice transmission is repeated twice and where the SPI button is set only if both transmissions, as received, are identical.

*Voice recognition machines on the ground would be desirable since the pilot need not invest in any additional equipment and, by repeating back the uplink message in his acknowledgment, the link can be made extremely reliable. These machines are under development for many applications and, in particular, are of interest to the banking industry. Thus, large dollar investments are being made in this technology and it is expected that such machines with limited capability, such as recognizing 16 commands, will be commercially available in the 1990s. However, such machines normally have to go through a learning cycle with each individual user; and given a cockpit noise background, it would be very optimistic and somewhat unrealistic to design an FAA data link acknowledgment system based on a voice recognition machine requirement.

Tone keying devices have been successfully applied to other applications and because of their relative low cost (i.e., \$25 to \$30) are attractive for this application. The technique is sufficiently attractive that FAA should explore this technology to explore human factor problems and various techniques to provide aircraft identity.

The use of computer-generated voice commands at VHF does not eliminate controller-pilot voice communications, but rather reduces the controller voice communication workload. Thus a controller is responsible for larger numbers of aircraft in larger regions of airspace than in the existing ATC system. Assuming that the VHF frequency allocations do not change, the AERA design concept is constrained in the following ways:

- Computer-generated voice commands and controller voice communications must share a common frequency channel without conflict.
- A controller may have to communicate with aircraft on several different frequency channels.

These design requirements can be met as described below:

With respect to the sharing of the channel, it is noted that computer-generated voice commands originate as digital signals which can be easily buffered. Therefore, the AERA controller can resolve conflicts by pressing a button to preempt the channel and buffer digital messages so that they are not lost. When there are no conflicts, then either the controller or the computer can access the channel.

APPENDIX 1*

An Incremental Approach to AERA Implementation

Motivations for an Incremental Approach: Evolution to a system like AERA will be guided and paced by several factors, including the following:

1. The Desire to Obtain Operational Benefits Before AERA is Fully Developed: The system envisioned by the AERA concept will take many years of intensive development and experimentation before it is fully realized in practice. Some functional capabilities will take longer to achieve than others. In order to make functional improvements to the existing ATC system before full AERA is developed, it would be desirable to partition the AERA functional design into operationally useful increments, to develop them in some desirable sequence, and to package them for evolutionary deployment.

With some foresight, good overall system design, and well-defined interfaces between increments, it should prove practical to do this in a manner which satisfies certain technological constraints, ATC operational needs, and reasonable budgetary constraints. Actual deployment decisions would be keyed to FAA's confidence in each incremental product as it emerges from the development and experimental evaluation process for AERA.

2. The Need to Maintain Continuity of ATC Services: Civil ATC in the United States is a 24 hour-a-day, 7 days-a-week, operation. ATC services as seen by the users of the airspace must remain available and

*The AERA concept team has not reviewed as a group the contents of this appendix.

be highly reliable. The system upgrading process will have to be carefully planned and conducted to avoid disruptions to service.

Proven backup systems and procedures, including the possibility of having to revert to the current NAS Stage A system during the transition, will have to be in place and working to ensure safety at all times. The incremental approach may ease the problems of assuring adequate backups by (a) reducing the rate of exposure to unfamiliar systems and procedures; and by (b) making reversion back to familiar systems and procedures in the initial stages easier.

3. The Need to Train Personnel and to Make Changes: About 10,000 air traffic specialists and several thousand system maintenance specialists are currently employed to operate and maintain the en route portion of the ATC system.

Before new systems and procedures can be introduced, key personnel will have to be trained in their use. These key personnel will undoubtedly uncover problems that lead to design or procedural changes. They will also have to carry out the planning for the conversion of their individual facilities, and they will have to train others so that the cadre of skilled staff can continue to grow. Sufficient time must be allowed for these things to be worked out in an orderly fashion. The incremental approach promises to make this process more understandable, more manageable, and therefore, less risky.

4. The Needs of the Airspace Users versus Budgetary Constraints: The needs of those who buy, equip, and upgrade the aircraft that operate within the ATC system are subject to benefits versus cost arguments

and budgetary limits. Aircraft equipment is therefore related to the economic well-being and priorities of the operators. Aircraft equipment also influences the direction and pace of ATC facility upgrading. Fleet equipment with, say, DABS data link and airborne systems to use it may either lead or lag the ATC system's ability to exchange data with aircraft. But since equipment, except for safety requirements, will likely remain voluntary for years to come, the level of equipment will not be uniform among those who continue to receive ATC services. The incremental approach to AERA could reflect this evolutionary nature of fleet equipment.

Given these factors, it is prudent to plan for incremental implementation of an ATC system with AERA-like features.

APPENDIX 2

ARTCC/TRACON Interactions in the Current ATC System

In the current ATC system, the authority for planning and controlling instrument flight movements between airports is vested primarily in the ATC facilities known as Air Route Traffic Control Centers (ARTCCs or "centers" for short). However, in the vicinity of busy airports, there are unique problems to be solved in merging and properly spacing arrivals to a common final approach course, and in interleaving departures with those arrivals, getting them out of the immediate area, and safely established on the proper outbound heading. Because of the specialized nature of these problems, each center typically delegates its control authority for handling the approaches to potentially busy airports to specialized "approach control facilities." Each approach control facility also handles the approaches to all secondary airports within the vicinity of the primary airport.

To delegate this control responsibility, center representatives meet with approach control facility representatives to jointly agree upon a common airspace boundary and set of procedures between the two facilities. That boundary, and the procedures for coordinating flight movements across that boundary under a variety of conditions, is formalized in a Letter-of-Agreement. The degree to which that agreement imposes constraints on how flights may cross the boundary depends, in part, on the amount of traffic potentially involved. It also depends on the uncertainties and workload associated with planning and coordinating clearances in advance across that boundary.

Those approach control facilities which have their own fast-scan beacon/radar surveillance systems (Airport Surveillance Radars, or "ASRs" for short) are referred to in this document as Terminal Radar Approach Control (TRACON) facilities. These TRACONs, and the airport towers which control the air traffic local to and on the surface of the airport, are collectively referred to as "terminal facilities" or "TRACON/Towers." One TRACON may serve several airports, either controlled (the airport has an ATC tower) or uncontrolled (the airport has no ATC tower). Similarly, a non-radar approach control facility may be delegated airspace within which to organize instrument flights to/from one or more airports using non-radar procedures.

FAA now operates all approach control facilities that serve civil airports, joint-use military bases and airfields in the United States. Various names are used operationally which reflect both the facility's primary mission and whether or not ASR-based ("radar") services are provided. For airports with radar approach control services provided by a special facility:

<u>Main Mission</u>	<u>Name (Acronym)</u>
Civil	Terminal Radar Approach Control (TRACON)
Air Force	Radar Approach Control (RAPCON)
Navy	Radar Air Traffic Control Facility (RATCF)

For airports without the coverage of a fast-scanning (4 seconds) Airport Surveillance Radar (ASR), IFR approach control services (if provided at all) may be procedurally provided by non-radar approach control positions in some convenient facility, typically an airport ATC tower. Alternatively, radar approach services can be provided by a radar controller in the overlying ARTCC. Since the surveillance approach control may be limited by the relatively slow scan (10 to 12 seconds) of the ARTCC's Air Route Surveillance Radar/ARSR systems and by the

remoteness of that long range radar relative to the airport, the quality of the radar services to such airports can also be limited. Typically, such operations reflect a mix of radar and non-radar procedures.

To get a better sense of what it means for an ARTCC to delegate airspace to several approach control facilities within the center boundary, consider the following two examples:

1. The New York center delegates airspace to the "New York Common IFR Room" (or "NYCIFRR", soon to be re-opened and re-organized as the "New York TRACON") and 13 other approach control facilities within the center's boundary. The delegated airspace to the NYCIFRR encloses the approaches to the three major airports (Kennedy, LaGuardia, and Newark) and their satellites. Vertically, it extends to altitudes as high as 17,000 feet MSL. Only a very small fraction of the airspace below 7,000 feet within the center's boundary has not been delegated to the NYCIFRR, or to one of the other approach control facilities.

The extent of the horizontal area involved can be appreciated by realizing that the following approach control facilities are within the New York Center's area:

Elmira, New York
Dover, Delaware
Harrisonburg, Pennsylvania

2. The Denver center delegates airspace to seven approach control facilities. Of these, three provide "radar services" (Denver TRACON, Colorado Springs TRACON, and the Ellsworth AFB RAPCON).

APPENDIX 3

Fuel Efficiency Considerations in Absorbing Landing Delays

The fuel burn characteristics of a typical B727-200 are illustrated in Figures A3-1 and A3-2 for three different kinds of airspeed schedules: constant Mach (.80, .82, .84), Long Range Cruise (LRC), and Maximum Endurance Speed (MES). In particular:

1. Long Range Cruise (LRC) Speed is that operationally useful speed which minimizes fuel consumption in terms of pounds of fuel burned per mile (Figure A3-1). Implication: Use this speed schedule when delays are not expected.
2. Maximum Endurance Speed (MES) is that operationally useful speed which minimizes fuel consumption in terms of pounds of fuel burned per minute (Figure A3-2). Implication: Use this speed schedule when being held to absorb landing delays.

The values of these speed schedules in terms indicated airspeed (IAS) as a function of altitude are illustrated in Figure A3-3.

Thus, if no landing delays are expected, the LRC speed schedule is (by definition) the most fuel-efficient to fly at any altitude. However, note that fuel consumption per mile at LRC speed goes through a definite minimum in the vicinity of FL350 for a 160,000 pound B727-200 under standard (ISA) atmospheric conditions. The optimal altitude for a heavier B727-200 is lower. For example:

175,000 pounds, FL330

200,000 pounds, FL290

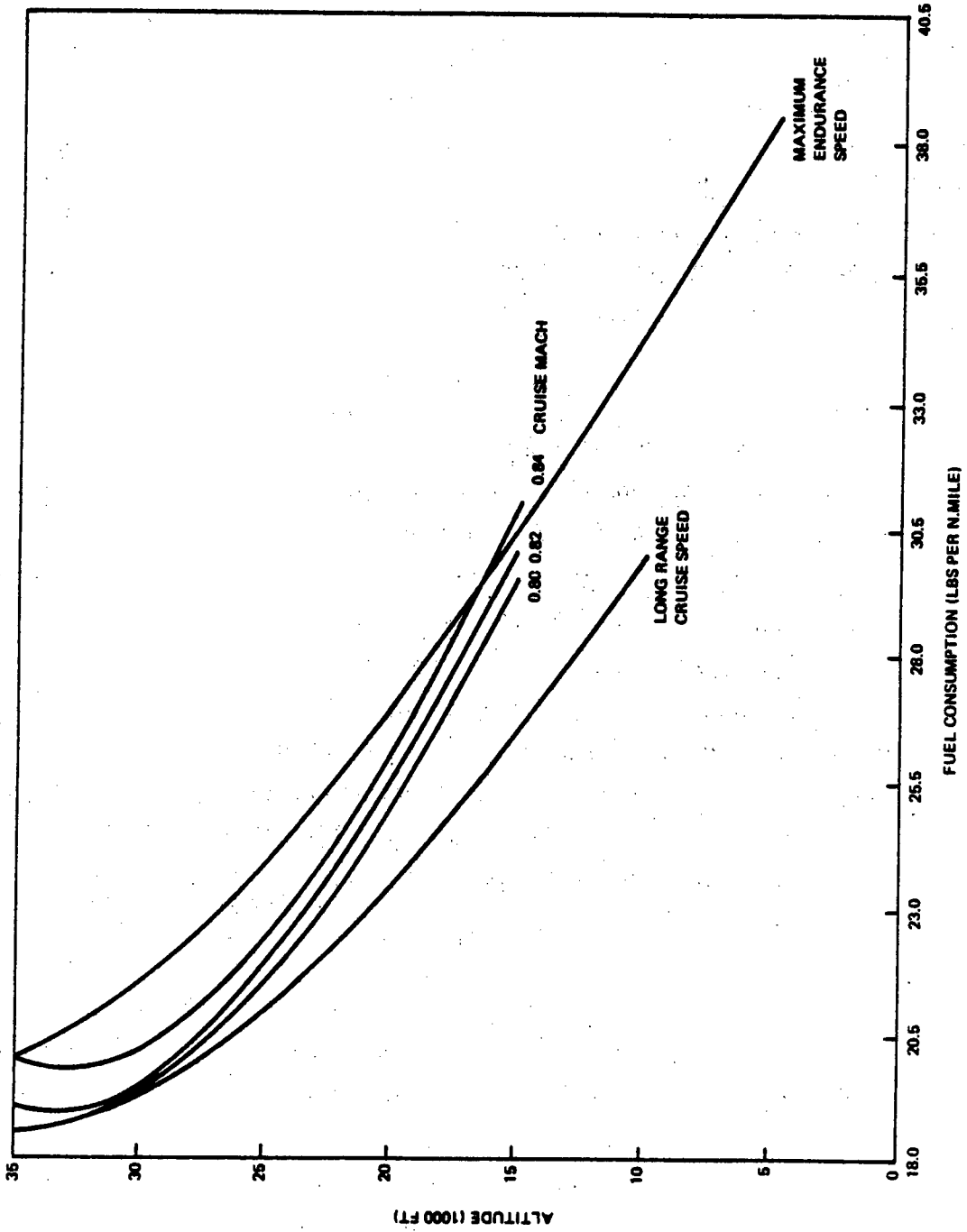

FUEL CONSUMPTION PER MILE IN CRUISE AT DIFFERENT ALTITUDES
(FOR A B727-200 @ 160,000 LBS & ZERO WIND, ISA)

Figure A3-1

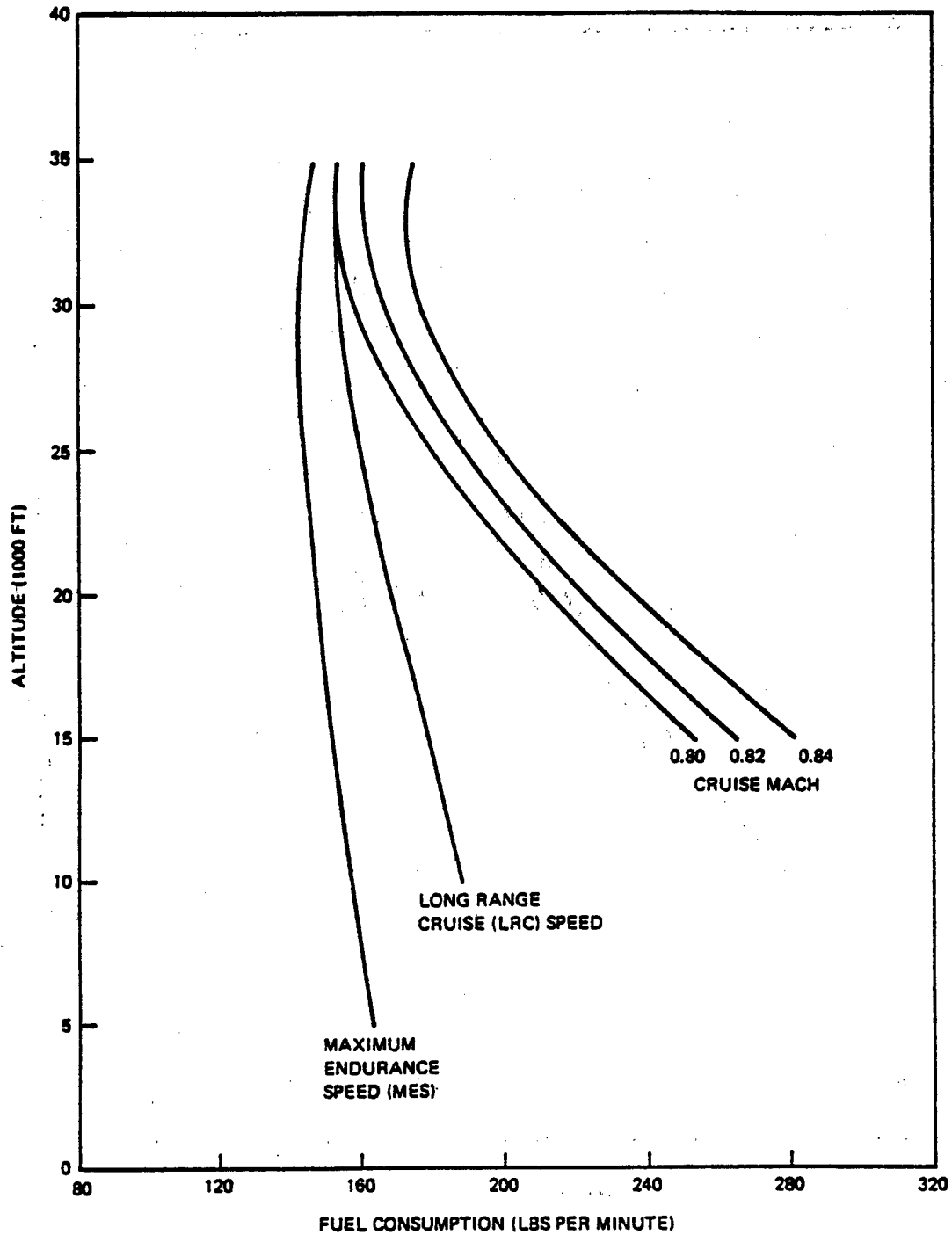

Figure A3-2

FUEL CONSUMPTION PER MINUTE IN CRUISE AT DIFFERENT ALTITUDES
 (FOR A B727-200 @ 160,000 LBS AND ZERO WIND, ISA)

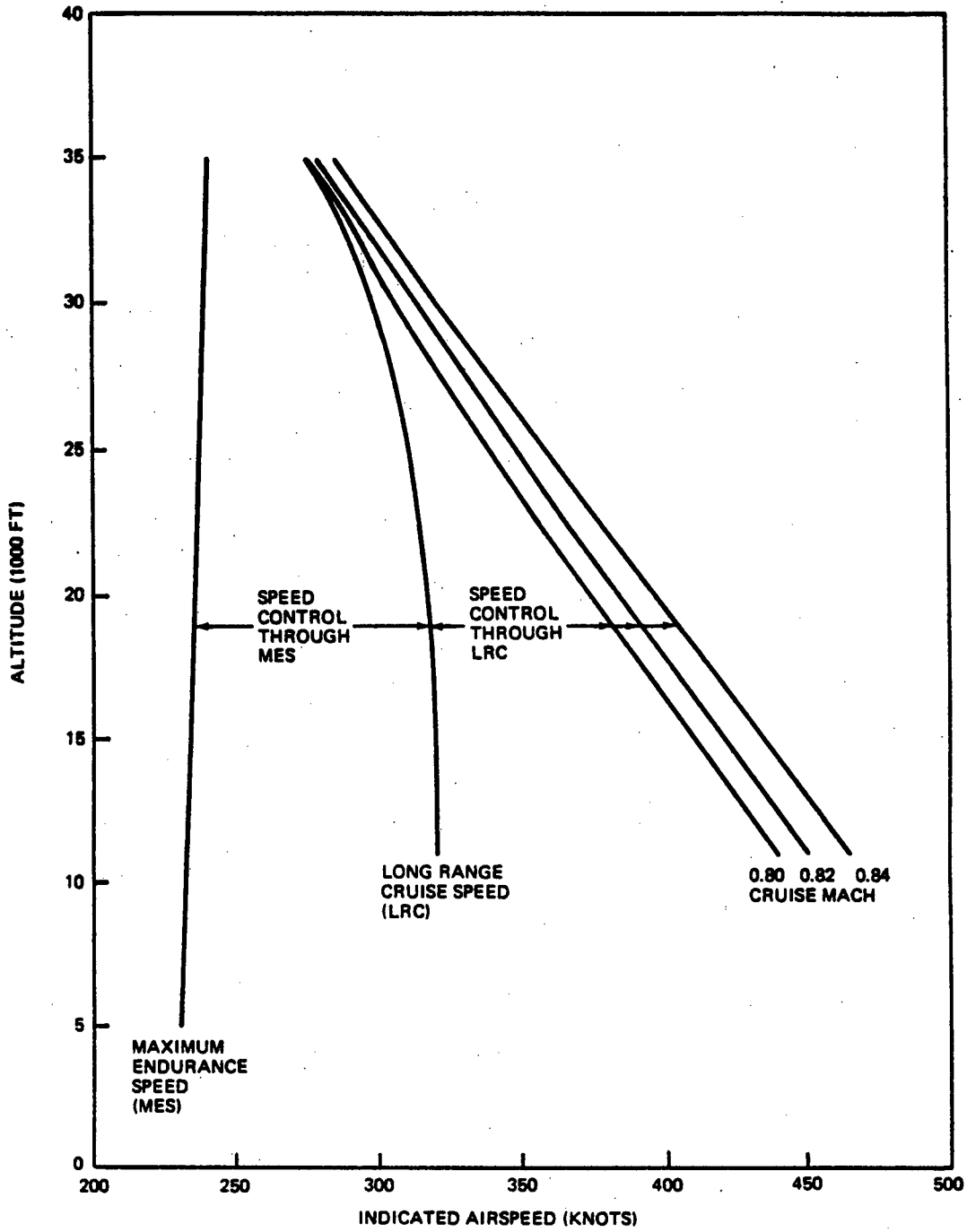

Figure A3-3

**STANDARD AIRSPEED SCHEDULES VERSUS ALTITUDE AND INDICATED AIRSPEED
(FOR A B727-200 @ 160,000 LBS AND ZERO WIND, ISA)**

Fuel consumption at 10,500 pounds of fuel per hour means that the pilot of a 200,000 pound B727 might initially request an assigned altitude of FL290, but two hours later request a higher assignment to FL330 to remain nearer his fuel-optimal altitude.

However, if a landing delay must be absorbed, then the most fuel-efficient choice is to slow the aircraft down, if practical at the current cruising altitude, and to add whatever miles are necessary to absorb the delay. If the delay is predicted early enough, slowing down to a speed at/above MES may be sufficient. If not, path-stretching or holding procedures must be included to add the necessary miles for delay absorption.

As illustrated in Figure A3-2 for a 160,000 pound B727, there is about 30 knots (IAS) difference between the LRC and MES speeds at FL350, as compared to about 100 knots difference at 10,000 feet MSL or below. Thus, the delay absorption capability available through speed reduction decreases as altitude increases.

Figure A3-4 illustrates the delay absorption capability that exists through speed control as a function of altitude for a 160,000 pound B727 under ISA conditions and zero wind. To determine the amount of delay which can be absorbed when reducing from LRC speed to MES using Figure A3-4, take the difference between the two families of curves shown for any constant Mach. For example, the difference between "From .80 to MES" and "From .80 to LRC" at FL330 is about one second per nautical mile. Thus, about two minutes of delay is absorbable over a 120 mile leg (zero wind), if that leg is flown at MES instead of LRC.

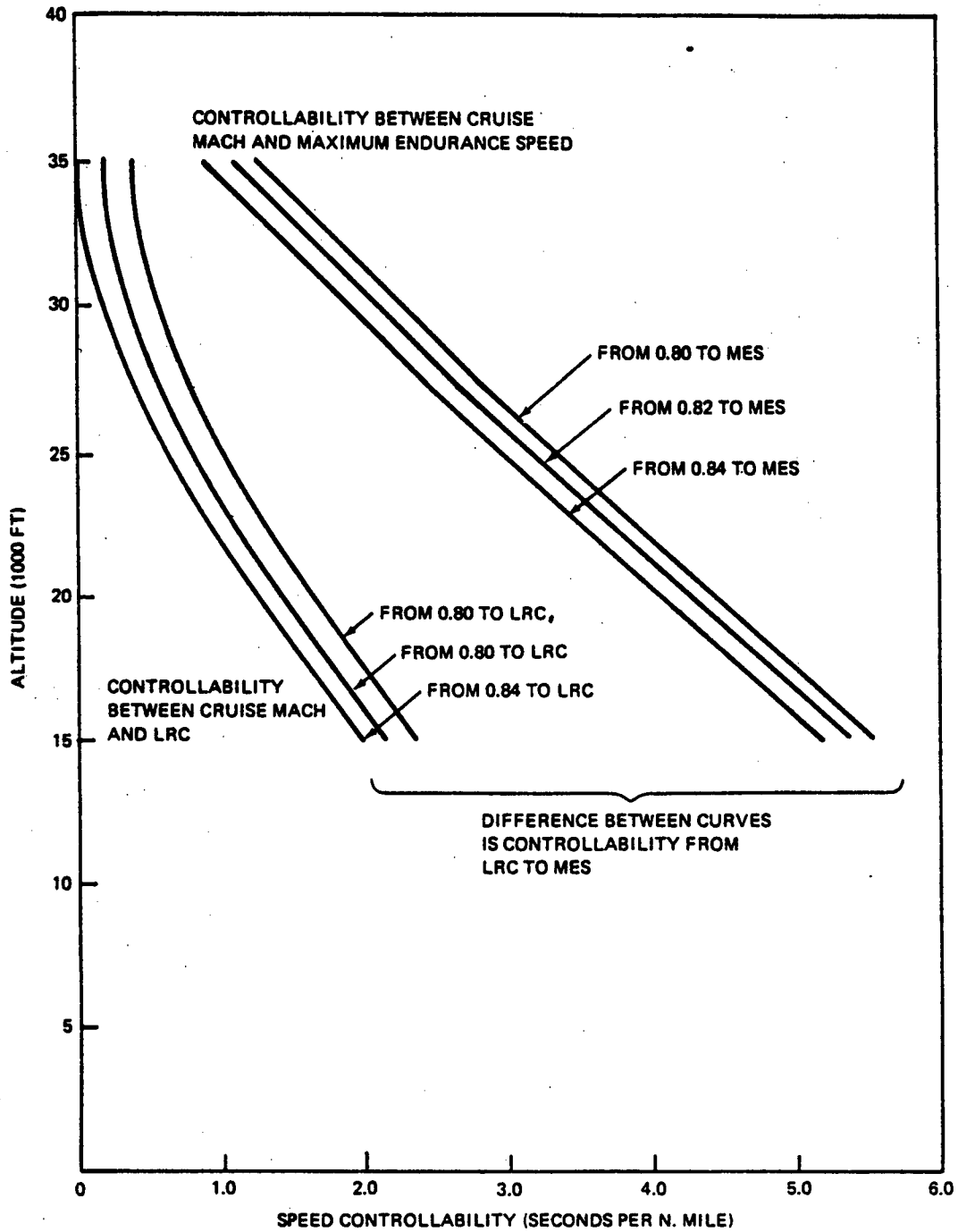

Figure A3-4

**SPEED CONTROLLABILITY IN SECONDS PER MILE AT DIFFERENT ALTITUDES
(FOR A B-727-200 @ 160,000 LBS & ZERO WIND, ISA)**

It should also be noted that of the three speed schedules, the MES fuel burn is the least sensitive to altitude variation. That is, while fuel consumption is always minimized when the optimum altitude is flown, the fact that a delay is taken at a lower non-optimum altitude does not greatly increase fuel consumption, given that the aircraft is flown at MES.

For example, if a B727-200 were flown at 10,000 feet pressure altitude at LRC speed, when its optimal altitude is 33,000 feet, then the penalty would be about 67 percent increase in fuel consumption per mile. However, if the aircraft were held at 10,000 feet at MES to absorb an assigned delay, the penalty would be only about ten percent in fuel consumption per minute, relative to taking that same delay at FL330. See Figure A3-5.

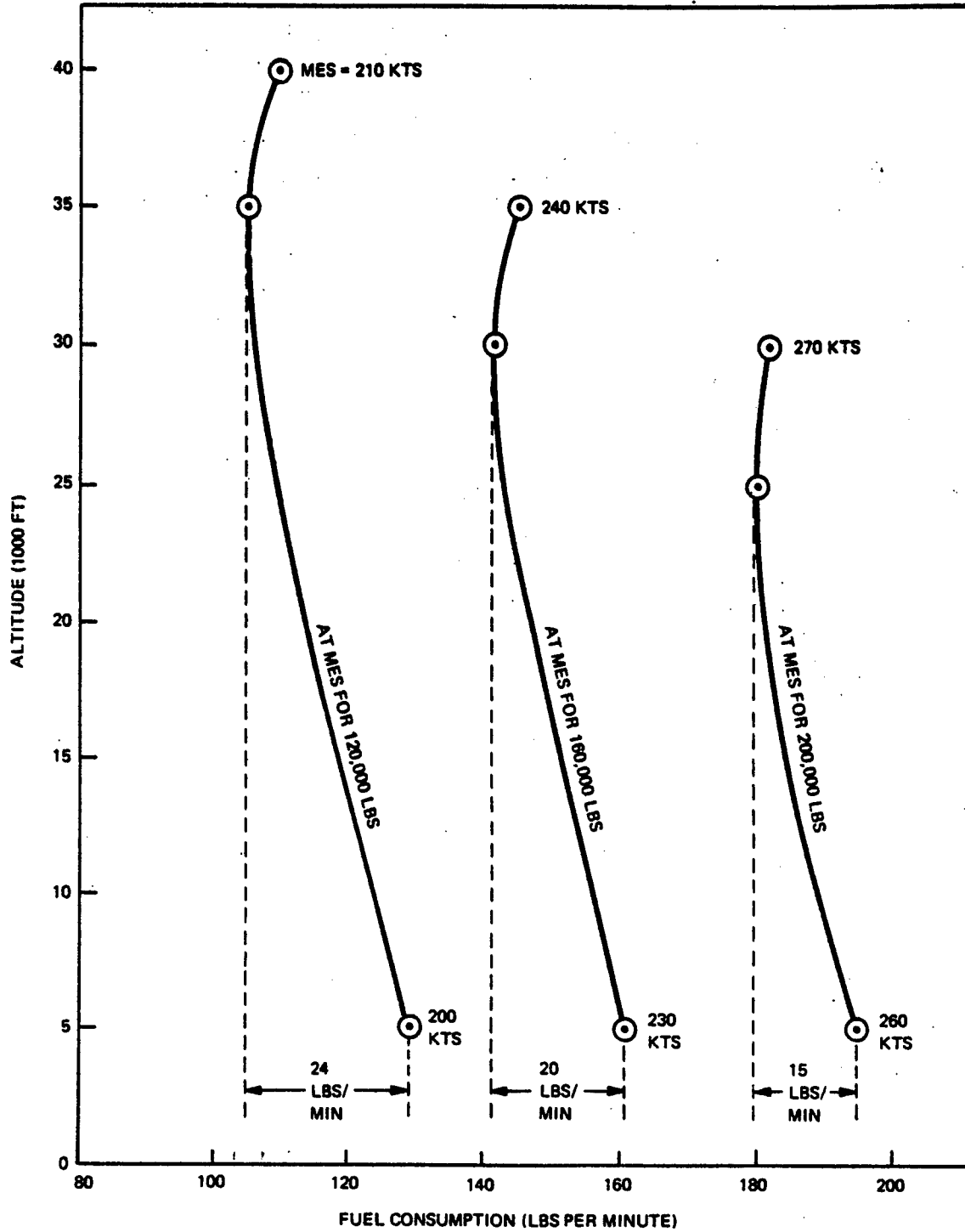

Figure A3-5

FUEL CONSUMPTION AT MAXIMUM ENDURANCE AND DIFFERENT ALTITUDES
(FOR A B-727-200 & ZERO WIND, ISA)

REFERENCES

- 1/ ATC Accommodation of Fuel-Conservative Turbojet Operations, S. C. Mohleji, R. A. Rucker, B. M. Horowitz, N. O. Eaddy, The MITRE Corporation, McLean, Virginia, May 1978, FAA-EM-78-14.

APPENDIX 4

Strategic Conflict Prediction in AERA

In the section entitled "AERA System Description", the strategic planning function of "conflict prediction" was briefly described. The purpose of this appendix is to explain certain aspects of this function in more detail and, in particular, to explain the output of the prediction function called "conflict boxes." These boxes are data structures designed primarily for consumption by the conflict resolution function. The function of conflict resolution is performed either automatically by the AERA system itself or semi-automatically by an air traffic specialist working with an interactive AERA planning display.

Overview: The function of the strategic conflict predictor is to find and identify those places where planned flight trajectories potentially interfere with one another, or with some other obstacle (e.g., a severe weather cell or a denied Military Operating Area). It does this by taking a subject trajectory and running down its length in search of other trajectories, or other obstacles, which are not naturally segregated from the subject by at least one of the following: obvious lateral (route) differences, altitude differences, or time differences. Those object trajectories not obviously separated from the subject trajectory are potential conflicts which may require resolution planning to ensure separation.

The predictor's gross filter is the function which discards all of the trajectories, or other obstacles, which are obviously not in conflict with the subject's trajectory, either as given or as it might be modified by the conflict resolution function. One design goal is to find very efficient gross filtering techniques so that the performance of the AERA system is not affected by workloads involving, say, 500 to 1,000 planned trajectories.

The predictor's fine filter is the function which decides whether any remaining potential conflict found for a given subject will occur with high enough probability, or near enough in the future, to warrant declaring it "possible" or "real" for the purposes of conflict resolution planning. A "possible conflict" is one for which it is predicted that horizontal separation will be lost over some interval. A "real conflict" is one for which it is predicted that both horizontal separation and vertical separation will be lost over some interval. Such conflicts are the outputs of the conflict prediction function.

The predictor's outputs are stored for use by the resolution planning function in a data structure called conflict box. Conflict box is a linked list of individual boxes which contain the data characterizing the conflicts which deserve the attention of the conflict resolution function immediately.

Conflict Boxes Illustrated: Figure A4-1 illustrates the concept. The planned trajectories for an eastbound arrival (solid lines) and a northeast bound overflight (dotted lines) are shown in both horizontal profile (the "plan view") and in vertical profile (the "vertical view"). Successive predicted positions for the "subject" arrival are marked with an "S", and the corresponding predicted positions for the "object" overflight are marked with an "O". The "conflict box" for the object aircraft, relative to the subject aircraft's vertical profile, is the rectangle with the horizontal dimension marked "vertical separation required" and with the vertical dimension marked " $\pm 1,000$ feet".

The box exists because the currently predicted minimum miss distance in the horizontal plane (d_m) is less than the current value of the minimum separation (SEPM) function. In this particular illustration, its horizontal dimension is determined by where the predicted violations of SEPM first and last occur. Its vertical dimension is determined by the altitude profile of the object aircraft and the minimum separation function applicable to that profile in the vertical domain

(SEPZ). In this case, it is assumed that the value of SEPZ is "1,000 feet" above and below the object's vertical profile.

The conflict is defined as "real" if the subject's profile penetrates the conflict box of the object aircraft. The conflict is defined as "possible" if the box exists (i.e., SEPM is violated), but the vertical profile for the subject bypasses the box above or below. In the case illustrated, below the box means that the pilot plans to, or will be cleared to, begin the descent early enough so that vertical separation is regained before horizontal separation is predicted to be lost. Passage above the box means that the pilot will be cleared to begin the descent only after the two aircraft have actually passed through the intersection and their track data indicates that horizontal separation has been restored. In the early descent case, an altitude crossing restriction would be appended to the descent clearance, in order to ensure that the top-of-descent point and rate of descent are sufficient avoid penetrating the box.

In this particular illustration, it is assumed the subject aircraft will also be the aircraft selected to yield the right-of-way, consequently, it is also referred to as the "burdened aircraft". The object aircraft would therefore be granted the right-of-way and is therefore referred to as the "privileged aircraft". In general, the term "subject" identifies which flight's trajectory is being examined for conflicts, and the term "burdened" identifies which flight's trajectory will be replanned to resolve any conflicts found. Any combination is possible; i.e., the "subject" of a conflict probe may be picked as the "privileged" flight in a particular conflict. This means that the resolution planner would select the other flight (the "burdened" one) as its subject for replanning, and the privileged flight would now become the object to be avoided by the former's replanned trajectory.

The Minimum Separation Function: This function is used to compute the value of the parameter SEPM. If the predicted minimum miss distance is less than

SEPM, then a conflict in the horizontal plane is declared. If it is equal to or greater than SEPM, then the trajectories are declared to be safely separated. The parameter SEPM is made a variable in order to tune the performance of the fine filter with regard to the tradeoff between falsely predicting conflicts (which leads to unnecessary replanning) and missing the opportunity to predict real conflicts (which can result in insufficient lead time for replanning).

The function is primarily dependent upon the estimated time to closest approach for a given conflict:

For near conflicts (e.g., within an estimated ten minutes of closest approach), SEPM is chosen to be larger than the official separation standard by an amount sufficient to account for the uncertainties of prediction. That is, if the predicted miss distance is greater than SEPM, then the probability that the actual miss distance will be less than the separation standard is practically zero.

For conflicts farther out (e.g., greater than an estimated ten minutes to closest approach), SEPM is chosen so as to satisfy some criteria that the probability of a false conflict prediction should be less than some established threshold. Far enough out and the value of SEPM drops to zero, meaning that any prediction of conflict that far away is unreliable.

Each trajectory is submitted for re-prediction whenever significant deviations from predicted flight progress are detected, whenever planning is required, or periodically (every 5 minutes, on the average) in the absence of progress deviations or replanning events. Thus the conflict-free horizon for each flight is incrementally pushed ahead as the flight progresses through the system. A design objective is to maintain 10 to 20 minutes of conflict-free airspace in front of each controlled flight's current position.

Generalizing the Conflict Box Concept: In the previous illustration, the horizontal dimension of the conflict box was set by the predicted locations of the first and last violations of SEPM in a given conflict. This suffices as an explanation of why the conflict box currently exists and of how severe the violation of SEPM is (whether near collision or near safe passage). But for other purposes, this definition may be extended.

In general, the dimensions of the box depend upon the purpose to which the box is put. For example, if it were used to:

1. Explain why the box exists, then the dimensions are set by SEPM and SEPZ.
2. Define the airspace between the expected first and last violation of official separation standards, then the dimensions are set by those separation standards (e.g., five miles and 1,000 feet).
3. Define the airspace between the first and last violations of some other definitions of protected airspace to be avoided, then the dimensions of the box would be set by those definitions. Figure A4-2 illustrates some alternatives:

"t" minutes to violation of "d" miles

"t" minutes to predicted closest approach

"d" miles and closing

"d" miles and opening

These are trivial additions to the definition of the conflict box data structure, as explained next.

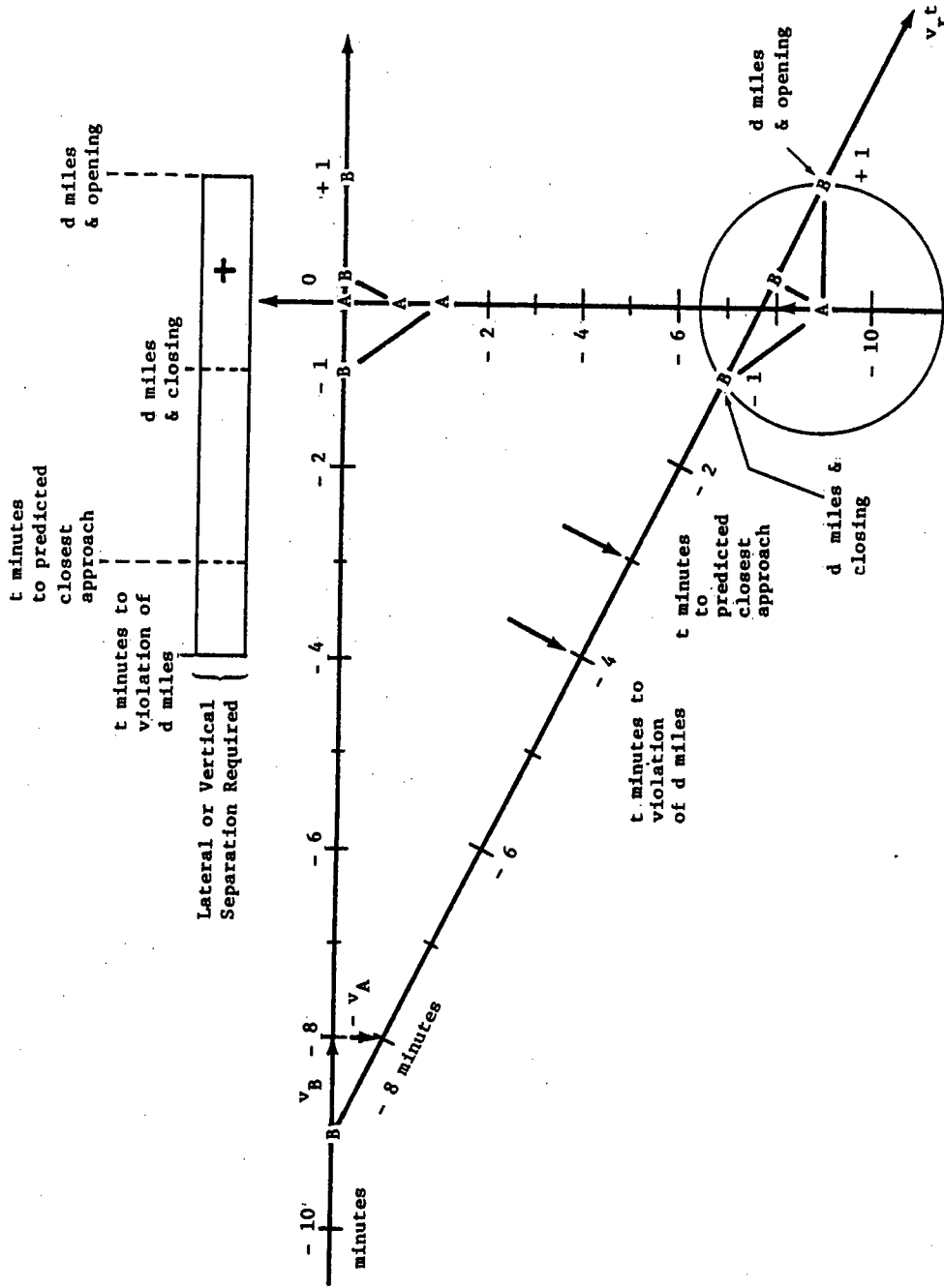

Generalized Conflict Box

Figure A4-2

Conflict Boxes as Data Structures: The conflict box(es) for any single encounter includes, but is not limited to, the following kinds of data:

General Conflict Descriptors:

- The cause of the conflict, for example:
 1. Another aircraft's planned trajectory
 2. A denied sector boundary
 3. A denied shelf boundary
 4. A denied restricted area boundary
 5. A denied holding pattern boundary
- The identities of the flight(s) involved.
- The value of SEPM used in declaring the conflict.
- The currently predicted minimum miss distance.

REFERENCES

- 1/ AERA Package 1 Test Bed Software Description - Build 1, Section 5.16, Volume II, L. Fellman, F. X. Maginnis, L. K. Borysiewicz, Eds., The MITRE Corporation, McLean, Virginia, October 1980, WP-80W00828.
- 2/ AERA: Conflict Prediction Performance Sensitivity to Speed and Route Center Line Deviation Uncertainty - Simulation Description and Sample Results, K. M. Levin and L. S. Oei, The MITRE Corporation, McLean, Virginia, May 1980, WP-80W00340.

APPENDIX 5

Strategic Delay Prediction in AERA

In the section entitled "AERA System Description", the strategic planning function of delay prediction was briefly described. The purpose of this appendix is to explore certain aspects of this function and its interfaces with the outside world in more detail, specifically:

1. Alternative methods for computing a flow rate restriction to a saturable airport with one or more active arrival runways.
2. Delay discounting to ensure that the delay assigned to any en route arrival is not excessive because of inherent errors in the delay prediction process.

Three Alternative Methods for Computing an En Route Metering Restriction:

The three methods have been referred to elsewhere (Reference 1) as:

In-Trail Spacing (ITS)

Arrival Rate Metering (ARM)

Time of Arrival (TOA)

The relative performance of each of these methods has been a subject of study for several years, using data from both computer simulations and from observations of actual traffic at selected field sites (see References 1 through 5). Though a review of the results of these studies is beyond the scope of this appendix, their results seem to indicate that:

1. In terms of relative ease of implementation in the context of the current NAS Stage A en route system, the order is:

ITS (currently in use in most ARTCCs)

ARM (early prototype systems are currently in use at least in the Denver and Fort Worth ARTCCs)

TOA (not planned for use in any facility yet)

The basic reason for this is that computer-based scheduling aids are required to implement ARM and TOA, and except for two early prototypes, these are still under development.

2. In terms of the expected relative level of performance, the order is:

TOA (most fuel efficient)

ARM

ITS (least fuel efficient)

The reasons for this will be apparent after each is conceptually described and compared below.

Because of this fluid situation where probably the best has not yet been developed and proven, the AERA system concept has been designed to accept any of the three flow restriction methods. While TOA is preferred, the option for using ARM or ITS is retained. A summary of each technique follows:

In-Trail Spacing (ITS): In the current ATC system, the arrival capacity (or acceptance limit) of a saturable airport is usually stated in the form of "so many arrivals per hour." This hourly limit is typically sub-divided among three or four

established feeder fixes, one fix for each major direction of inbound flow. Whenever demand is expected to exceed capacity, the TRACON which serves the airport is responsible for establishing the values of the feeder fix acceptance limits. It is also responsible for merging these several feeder fix flows into a properly spaced landing sequence, one for each active runway. At many locations, the limit for each feeder fix, is translated into a "so many miles in-trail" restriction, based on an assumed average ground speed for all aircraft in the flow.

For example, an airport operating independent approaches to two parallel runways might allocate 60 landings per hour to the arrival center which feeds it, reserving any remaining runway capacity for departures and for local VFR arrivals. If the expected demand via each of the four en route feeder fixes were evenly distributed, then this would imply a 15 arrivals per hour restriction for each feeder fix, or one arrival over the fix no more than every four minutes on the average. At 300 knots average ground speed in the vicinity of the fix, the minimum spacing between successive arrivals should be 5 miles/minute times 4 minutes equals 20 miles in-trail.

There is typically one funnel-shaped arrival sector for each feeder fix. The radar controller at each arrival sector is responsible for merging the arriving aircraft for handoff to the arrival TRACON. The merge operation sequences and spaces these arrivals into a single in-trail stream over the feeder fix and descends them to the proper altitude for handoff. When an in-trail restriction is in effect, each arrival sector controller has the responsibility for assuring sufficient in-trail spacing to meet that restriction (e.g., >20 miles in-trail). When no restriction is in effect, the spacing between successive arrivals need only be sufficient for safety (e.g., >5 miles in trail).

Arrival Rate Metering (ARM): In the preceding example, the airport was assumed capable of accepting 60 arrivals per hour from the ARTCC, or 30 arrivals

per hour per runway, assuming IFR arrival loads are balanced on the two runways. This implies that the inter-arrival interval to a given runway should be 120 seconds between aircraft, on the average. An alternative method of en route metering is to develop a tentative landing schedule for each runway, based on that average interval. At the Fort Worth and Denver ARTCCs, the 9020 computer is used to compute a tentative landing schedule using the TRACON's estimate of the runway IFR acceptance rate converted to a time interval (e.g., 120 seconds). Those flights known by the ARTCC to be inbound to the airport and planning to arrive at the runway during the next half hour or so are time-ordered by their calculated time-of-arrivals at the runway. That sequence of expected arrivals is then separated by at least the pre-established inter-arrival spacing interval to achieve a possible landing schedule.

This possible landing schedule is sub-divided into several schedules, one for each feeder fix, and the tentatively scheduled arrival times at the runway are reduced by the expected average flying time to the runway from each feeder fix. The result is a desired fix crossing time for each arrival expecting to use that feeder fix. The difference between that desired crossing time and the currently calculated arrival time yields the currently estimated landing delay for each aircraft.

As in the preceding case, one sector controller merges all arrivals to a given feeder fix so as to meet the feeder fix restriction, which in this case is posted as a sequence of desired feeder fix crossing times.

This method has the advantages of automatically compensating for load imbalances between feeder fixes and of synchronizing somewhat the appearances of arrivals from the several feeder fixes for merging into a common final approach sequence.

Time-of-Arrival (TOA) Metering: The estimated time-of-arrival at the runway is calculated for each flight and a time-ordered sequence is formed as in the ARM method. However, the sequence is spaced according to the required interval between expected successive aircraft (e.g., three miles between successive small, large, or heavy aircraft; four miles if a large aircraft follows a heavy aircraft; five miles if a small aircraft follows a heavy aircraft). Thus, the number of aircraft which are expected to land during any hour is dependent upon the actual mix of aircraft types expected to use the runway. In all other respects, TOA metering resembles ARM metering.

Comparison of Expected Performance between Methods: In both the ITS and ARM methods, the expected throughput of the runway was based on a guessed-at landing capacity (e.g., thirty IFR arrivals per hour). Performance analysis has shown that a small error in this guess, relative to what actually might have been accomplished, can result in some rather severe penalties whenever demand for the runway is close to or exceeds capacity. A landing rate set a few landings per hour too low will result in excessive landing delays, as is graphically illustrated in Figure A5-1. A landing rate set too high results in an excessive number of aircraft being held at low altitudes within the terminal area.

Though never yet used in a field experiment, the TOA method has been shown to provide superior performance relative to the other two methods in comparative computer simulations. This occurs because the planned inter-arrival spacings are computed dynamically as a function of the actual traffic mix. Only non-flight-planned flights would have to be accounted for statistically.

TOA Method as Applied to Terminal Area Sequencing and Spacing: For the terminal area, computer aids to help controller sequence and space arrivals to the final approach course have been developed. Using data on expected arrivals fed to the TRACON by the arrival ARTCC, the TRACON computes a possible landing

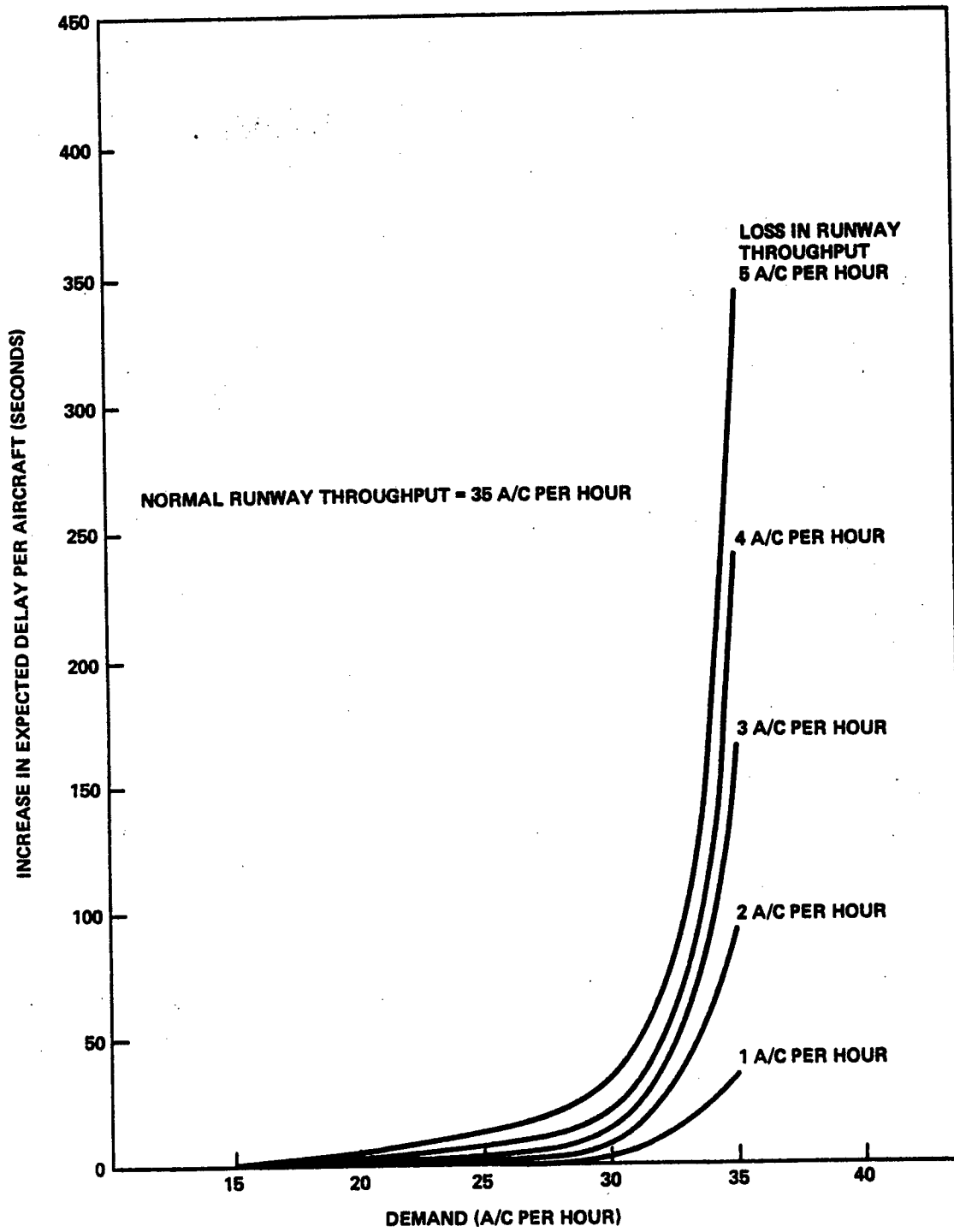

**INCREASE IN TIME DELAY (ABOVE AVERAGE DELAYS)
DUE TO A LOSS IN RUNWAY THROUGHPUT AS A
FUNCTION OF DEMAND
(FOR ARRIVALS ONLY)**

Figure A5-1

sequence for each active runway. Aircraft in this landing sequence are properly spaced to account for such things as separation from heavy aircraft for wake turbulence avoidance, significant speed differentials, and runway occupancy time. The result, converted into a time schedule, is a tentative landing schedule for each active runway which is computed in terms of the flights which will be landing during, say, the next 15 minutes. The computer also provides suggested speed adjustments and heading instructions at the proper time to meet the schedule. As the aircraft near the final approach course, further schedule adjustments (e.g., sequence swaps) are not practical, and the schedule for those aircraft is made firm. Once the aircraft are turned onto the final approach course and have passed the final spacing control point, the aircraft are dropped from the schedule. If the approach is aborted, go-around re-scheduling is required.

Delay discounting is important since any over-estimation of the delay results in an unnecessary waste of time or fuel for the arrival involved and for any other arrival sequenced behind it. The operational rule is: at the time a plan to delay a flight is to be translated into a specific control maneuver (speed reduction, path-stretching vectors, or a hold), that maneuver should attempt to absorb only that portion of the estimated delay that is certain to be needed. However, under-estimation of the certain delay is permissible so long as the efficient delay absorption capacities of downstream control points are not exceeded. The uncertain portion should be deferred to subsequent delay absorption opportunities when better data will be available. In particular, the TRACON's airspace is configured so as to permit, approximately, two landing slots' worth of delay absorption capability in the final sequencing and spacing area. This capability permits the TRACON to work early arrivals into a properly spaced landing sequence. Clearly, the amount of optimism built into the extended tentative landing schedule and the delay discounting rules should not exceed the delay absorption capability within the terminal area (as computed for vectoring or speed reduction in a relatively clean configuration). For the sake of fuel conservation and safety, holding in the terminal area should be avoided except in emergencies.

When gross delays* are certain to occur, flow constraints can be initiated by the arrival TRACON or arrival ARTCC, coordinated through the CFCF, and imposed on the sources of arrivals to the saturating airport or terminal area. These sources include ARTCCs controlling departures to the saturating location, users' flight dispatch offices, and the Flight Service Station (FSS) which provide many users with flight planning information.

TOA Method as Applied to the En Route Metering Function: The concept of a tentative landing schedule can be extended to those arrivals known to the arrival ARTCC, but too early to be included in the TRACON's tentative landing schedule. This extended tentative landing schedule, created for the purpose of en route metering, can be computed by either the arrival TRACON (if IFR arrival data is fed into it sufficiently in advance) or by the arrival ARTCC, based on IFR arrival flight data known to it.

If VFR pop-ups are allowed to arrive unannounced and use the busy runway during periods when en route metering is in effect, such pop-ups would have to be worked into the actual sequence later by the TRACON. For this and other reasons, the extended landing schedule is intentionally somewhat optimistic since the accommodation of pop-ups causes delays. If the extended schedule is created by the TRACON, it is fed back to the arrival ARTCC as the flow rate restriction imposed by the TRACON. The schedule itself may be made relative to the runway threshold or relative to any other point along each arrival's expected route to the runway.

Implications for the AERA System Concept: As illustrated in Section 3 in Figure 3-4 entitled "AERA Strategic Planning Functions and Interfaces", flow restrictions from served TRACONs (or other ATC facilities) can be accepted in any form. Any flow rate restriction which is not in the form of a tentative schedule will be converted into the latter form for use by the Delays Prediction function. This tentative schedule is discounted for delay prediction errors.

*Gross delays are those large enough and persistent enough to make imposition of flow restrictions on flights that have not yet reached the arrival center advisable. Two objectives are to take these delays in a more fuel-efficient manner (e.g., delayed departures), and to avoid saturating the holding capacity of the arrival center.

REFERENCES

- 1/ Performance of En Route Metering Methods, B. G. Sakkappa and J. G. Steinbacher, The MITRE Corporation, McLean, Virginia, June 1977, MTR-7575.
- 2/ Performance of En Route Metering and Profile Descents, B. G. Sakkappa and N. J. Zech, The MITRE Corporation, McLean, Virginia, December 1977, MTR-7698.
- 3/ ATC Accommodation of Fuel-Conservative Turbojet Operations, S. C. Mohleji, R. A. Rucker, B. M. Horowitz, N. O. Eaddy, The MITRE Corporation, McLean, Virginia, May 1978, MTR-7849.
- 4/ En Route Metering Performance Sensitivity Analysis, A. E. Hunt, F. K. Kling, K. M. Levin, The MITRE Corporation, McLean, Virginia, April 1979, MTR-79W00109.
- 5/ A Study of Potentially Correctable Landing Delays at Atlanta, B. P. Collins, The MITRE Corporation, McLean, Virginia, November 1979, MTR-79W00415.

APPENDIX 6

AERA Computer System Reliability

The AERA system as a whole will be entrusted with life critical responsibility. Because of the redundancies described in the concept document, the AERA system ensures that no single software or hardware failure, regardless of how subtle or catastrophic, could ever place human life in jeopardy. Despite the redundancy, the viability of AERA depends on an ability to implement both the hardware and software of AERA with sufficient reliability that the redundancy will almost never be needed.

The Software Implemented Fault Tolerant (SIFT) (WEN (78); WEI (78); GOL (74)) effort supported by NASA, using off-the-shelf commercial computers, claims and has shown strong evidence of a hardware failure rate of 10^{-9} per 10 hours. The designers of that system have done years of research to provide closed form rigorous mathematical demonstration that their operating system software is correct, and that failure of a critical function to be performed is sufficiently low to use in life critical applications. SIFT then, without any of the additional redundancies described in the AERA document, could provide a hardware compute capability meeting the objective of no more than one ARTCC outage (of no more than one hour) in 20 years. The redundancies of AERA then would multiplicatively improve this hardware reliability beyond this requirement. (FAA's reliability requirement of any critical airframe component -- 10^{-9} failures for a flight of ten hour duration -- corresponds to SIFT's capability.) There is no implication that AERA will be hosted on a SIFT-like system (SIFT is a much smaller scale system), but rather SIFT is strong evidence that AERA reliability requirements can be implemented with state of the arts systems. In addition to SIFT, there are a

number of other notable ultra-reliable hardware systems which provide additional demonstration of the feasibility of implementing sufficiently reliable systems. The references to this appendix survey system examples, such as ESS 1 (CLE(74)), ESS 2 (KEN (72), TOY(71)), FTMP (HOP(75)), and STAR (AVI(75) and other approaches to fault tolerance (BER(77), COO(77), HSI(75), Zel(76)).

Determining the reliability of the application software which comprises AERA is more difficult than estimating the hardware reliability, but is equally important and must meet equally high standards. Several references are listed below showing that many techniques are now available for proving that critical portions of software correctly implement their specifications (BOY(78), MAN(78)). Some of these techniques may be used in AERA. Several other references present techniques for preventing deadlock (ISL(80)), and for encapsulating software functions so that errors cannot affect other functions (MOR(77)).

When AERA is complete and installed, there will be a period during which controllers will use portions of AERA as tools, but will have no more traffic to handle than today, and will still be responsible for ensuring aircraft separation. After this period sufficient trust in AERA should develop to permit AERA to assume responsibility for the separation of aircraft.

Beyond the hardware and software reliability issues, catastrophic events such as fires, earthquakes, saboteurs, etc., could, of course, cause AERA system failure in an ARTCC. It is for this reason that the backup clearance has been invoked.

REFERENCES

- 1/ The STAR (Self-Testing and Repairing) Computer: An Investigation of the Theory and Practice of Fault-Tolerant Computer Design, A. Avizienis, et al, 1975.
- 2/ The Concurrency Control Mechanism for SDD-1; A System for Distributed Databases, Bernstein, et al, Computer Corporation of America, Technical Report CCA-77-09, December 1977.
- 3/ Check Schemes for Integrated Microprogrammed Control and Data Transfer Circuitry, Toy Beuscher, IEEE Transactions on Computers, December 1970.
- 4/ Computational Logic, R. S. Boyer and J. S. Moore, II, Stanford Research Institute, International, February 1978.
- 5/ Recovery from Faults in the Number One-A Processor, G. F. Clement and R. D. Royer, International Symposium on Fault Tolerant Computing, 1974.
- 6/ Design of a Self-Checking Microprogram Control, R. W. Cook, et al, IEEE Transactions on Computers, March 1977.
- 7/ An Organization for a Highly Survivable Memory, J. Goldberg, K. N. Levitt, J. H. Wenseley, IEEE Transactions on Computers, July 1974.
- 8/ The Archectural Elements of a Symmetric Fault-Tolerant Multiprocessor, A. L. Hopkins, T. B. Smith, IEEE Transaction on Computers, May 1975.

- 9/ Orthogonal Latin Square Configuration for LSI Memory Yield and Reliability Enhancement, M. Y. Hsiao, O. C. Bossen, IEEE Transactions on Computers, May 1975.
- 10/ The Deadlock Problem: An Overview, S. S. Isloor, T. A. Marsland, COMPUTER, September 1980.
- 11/ Recovery Strategies in the Number Two Electronic Switching System, P. J. Kennedy, T. M. Quinn, International Symposium on Fault-Tolerant Computing, 1972.
- 12/ The Logic of Computer Programming, Z. Manna and R. Waldinger, Stanford Artificial Intelligence Laboratory, AIM-298, 1978.
- 13/ A Survey of Methods for Improving Computer Network Reliability and Availability, E. E. Morgan, D. J. Taylor, COMPUTER, November 1977.
- 14/ Reconfiguration Strategies for the SIFT Fault-Tolerant Computer, C. B. Weinstock, M. W. Green, IEEE, CH 1038-3/78, 1978.
- 15/ SIFT - Design and Analysis of a Fault-Tolerant Computer for Aircraft Control, J. Wensley, Computer Science Laboratory, SRI International (NASA Langley Research Center, Contract 13792), 1978.
- 16/ A Damage and Fault-Tolerant Input/Output Network, T. B. Smith, IEEE Transactions on Computers, May 1975.
- 17/ Error Switch of Duplicated Processor in the Number Two Electronic Switching System, W. N. Toy, International Symposium on Fault-Tolerant Computing, 1971.
- 18/ Computer Architecture for Advanced Air Traffic Control Applications, A. Zellweger, Proceedings of the 1976 International Conference on Parallel Processing.

APPENDIX 7

Additional Computing Resources Required to Handle Gross Perturbations

External events, such as runway reconfiguration, airport closures, weather fronts or cells, navaid or neighboring ATC facility outages, can suddenly invalidate the current Clearance Directive plans for a number of flights simultaneously. All affected flights must be replanned in a manner which meets relevant safety and flow constraints. Further planning must be completed and the plan executed (in terms of issued and acknowledged instructions) before each aircraft affected reaches its first revised activation point.

A computation follows which shows that the handling of a gross perturbation, in addition to a normal steady state AERA load, is well within the state of today's computer technology.

Given

An average workload in the steady state of:

300 active aircraft within the AERA control region,
30 minutes average flight time within region, implies
10 new flights enter the control region every minute.

For each new inbound outside the control region:

30 minutes lead time for initial planning,
15 minutes lead time for full planning.

For each fully-planned aircraft (300 actives within the control region and 150 inbounds within 15 minutes of the boundary), assume

- 3 minutes between trajectory updates
- 5 minutes between reprediction of its conflicts
- 20 minutes between replanning of its Clearance Directives.

Where the relative computational costs in CPU work units are:

- 8 for initial planning (does not include conflict prediction/resolution)
- 10 for full planning or full replanning
- 2 for trajectory updates
- 1 for conflict reprediction

Then

The steady state workload is about 800 CPU units per minute, or one unit would have to be executed every

$$\frac{1 \text{ Minute}}{800 \text{ units}} \times \frac{60 \text{ seconds}}{\text{Minute}} = .075 \text{ seconds, on the average.}$$

This sets a limit on the number of instructions which can be processed per CPU workload unit, given a machine execution rate. In Millions of Operations per Second (MOPS),

<u>Assume</u>	<u>Limit on Average Workload Unit Size</u>
1 MOPS (one fast minicomputer)	75 K operations
100 MOPS (one pipeline processor)	7.5 M operations

Since hierarchical decision-making logics do not involve a great deal of looped computation, there is no reason to believe that these kind of limits pose any constraint on AERA software, however sophisticated.

Now Given

A gross perturbation that causes a large number of plans to be invalid. For example, AERA is metering to an airport which is accepting sixty aircraft per hour from AERA, and it suddenly closes. Now if:

45 fully planned aircraft require "immediate" replanning (30 active + 15 inbounds), and

5 minutes is assumed to be turnaround time limit for replanning.

Then

The additional transient workload is:

$$\frac{45 \text{ aircraft} \times 10 \text{ CPU units/aircraft}}{5 \text{ minutes}} = 90 \text{ CPU units/minute}$$

or an 11 percent increase in CPU processing capacity would be required to accommodate such a transient.