

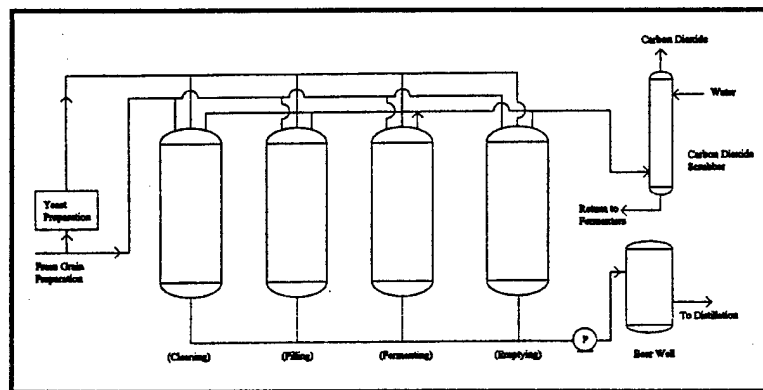

Anaerobic Digestion and Acid Hydrolysis of Nitrocellulose

Byung J. Kim, Hsin-Neng Hsieh, and Fong-Jung Tai



DTIC QUALITY INSPECTED 4

In military applications, nitrocellulose (NC) based powders are extensively used as propellant in bullets, shells, and various missiles for tube munitions. Residual NC produced during the manufacturing process is composed of insoluble fibers, or "fines" in suspension. Currently, these suspended solids are recovered and reused. However, since the Army expects to terminate the re-use of pit cotton in the near future, there is a need to develop innovative NC treatment and disposal technologies.

This study evaluated and demonstrated the potential for the use of acid hydrolysis and anaerobic digestion to treat munitions-grade nitrocellulose. As an alternative treatment, the concept of acid hydrolysis was developed and validated with bench scale tests. NC was hydrolyzed with high strength hydrochloric acid and was converted to glucose. The degradative intermediate and end products were identified and a kinetic model was validated.

19991028 047

The contents of this report are not to be used for advertising, publication, or promotional purposes. Citation of trade names does not constitute an official endorsement or approval of the use of such commercial products. The findings of this report are not to be construed as an official Department of the Army position, unless so designated by other authorized documents.

DESTROY THIS REPORT WHEN IT IS NO LONGER NEEDED

DO NOT RETURN IT TO THE ORIGINATOR

Foreword

This study was conducted for the Directorate of Research and Development, Headquarters, U.S. Army Corps of Engineers (HQUSACE), under Project 4A162720D048, "Industrial Operations Pollution Control Technology"; Work Unit TE7, "Nitrocellulose Fines Abatement." The technical monitors were Gene Fabian, SFIM-AEC-ET and James Small, DCS-AMSIO-EQC.

The work was performed by the Environmental Processes Branch (CN-E) of the Installations Division (CN), U.S. Army Construction Engineering Research Laboratory (CERL). The CERL principal investigator was Dr. Byung J. Kim. Dr. Hsien-Neng Hsieh and Dr. Fong-Jung Tai were a professor and a graduate student, respectively, at the Civil and Environmental Engineering Department, New Jersey Institute of Technology, Newark, NJ. Jerome L. Benson is Chief, CECER-CN-E and John T. Bandy is Chief, CECER-CN. The CERL technical editor was William J. Wolfe, Information Technology Laboratory.

The Director of CERL is Dr. Michael J. O'Connor.

Contents

Foreword	2
List of Figures and Tables	5
1 Introduction	9
Background	9
Objectives.....	10
Approach	11
Scope	11
Mode of Technology Transfer	11
2 Overview	12
Characteristics of NC	12
<i>Manufacturing Process of NC</i>	12
<i>Properties of Nitrocellulose</i>	14
<i>Hazards of Nitrocellulose</i>	15
<i>Waste from Nitrocellulose Manufacturing Process</i>	16
Decomposition of Nitrocellulose.....	17
<i>Mechanical Decomposition</i>	17
<i>Thermal Decomposition</i>	18
<i>Photochemical Decomposition</i>	18
<i>Alkaline Decomposition</i>	19
<i>Acid Denitration and Hydrolysis</i>	20
<i>Biological Degradation</i>	21
3 Materials and Methods	23
Anaerobic Treatment Process.....	23
Acid Hydrolysis.....	27
<i>Hydrochloric Acid Hydrolysis of Nitrocellulose</i>	27
<i>Approach To Estimate the Kinetic Constants of Acid Hydrolysis</i>	29
4 Anaerobic Treatment Process	33
Effect of Various Enzymatic Inducers.....	33
Effect of Inducer/Nitrocellulose Ratios	36
Two-Stage Batch Study.....	41
Effect of pH on Biodegradation	46

Sequencing Batch Study	50
Stage-Feed Anaerobic Study	51
Inhibition Study	53
Effects of pH and Cellulose Particle Size on NC Biodegradation	56
Effectiveness of Biodegradation	57
5 Hydrochloric Acid Hydrolysis Of Nitrocellulose.....	59
Effect of Reaction Temperatures	59
Effect of Acid/Solid Ratio on Acid Hydrolysis	63
Effect of Acid Concentration	65
Glucose Conversion	67
Change of Acid Concentration During Acid Hydrolysis	68
Nitrogen Balance	69
6 Proposed Nitrocellulose Treatment Method	75
Acid Separation and Recovery	75
<i>Hydrochloric Acid Stripper and Absorption</i>	75
<i>Electrodialysis</i>	77
Ethanol Fermentation and Purification	80
<i>Effect of Micro-organisms</i>	80
<i>Ethanol Recovery</i>	83
7 Conclusions and Recommendations	85
Anaerobic Treatment Process	85
Hydrochloric Acid Hydrolysis of Nitrocellulose	86
References.....	87
CERL DISTRIBUTION.....	92
REPORT DOCUMENTATION PAGE	93

List of Figures and Tables

Figures

1	Batch manufacturing process of nitrocellulose (Patterson 1976).....	13
2	Esterification reaction from cellulose to nitrocellulose.....	14
3	Schematic diagram of anaerobic treatment system for master culture of mixed anaerobes.	26
4	The method of residuals (Connors 1985).....	32
5	Effect of various enzymatic inducers in batch study I.....	34
6	Effect of various enzymatic inducers in batch study II (inducer/NC = 10/1, inducer concentration = 1,000 mg/L).....	36
7	Effect of various lactose/nitrocellulose ratios in batch study (lactose concentration = 1,000 mg/L).....	37
8	Effect of various cellobiose/nitrocellulose ratios in batch study (cellobiose concentration = 2,000 mg/L).....	37
9	Effect of various cellulose/nitrocellulose ratios in batch study (cellulose concentration = 2,000 mg/L).....	38
10	Results of two-stage anaerobic treatment system (2 and 4 days of acidogenesis period at pH = 6.0).....	43
11	Results of two-stage anaerobic treatment system.....	44
12	Results of biodegradation test with nitrocellulose and cellulose by sludge from two-stage anaerobic treatment system.	45
13	Gas production during biodegradation at pH = 8.0.....	46
14	Gas production during biodegradation at pH = 7.5.....	47
15	Gas production during biodegradation at pH = 7.0.....	47
16	Gas production during biodegradation at pH = 6.5.....	48
17	Gas production during biodegradation at pH = 6.0.....	48
18	Results of sequencing batch study.	50
19	Gas production in staged-feed reactors.	52
20	Gas production in two-stage staged-feed system.	52
21	Gas production in single-stage staged-feed system.....	53
22	Gas production in inhibition study without NC.....	54
23	Gas production in inhibition study with NC.....	54
24	The Lineweaver-Burk Plot in inhibition study.....	55
25	Results of acid hydrolysis (A/S = 6 mL/0.4 g) at various temperatures.....	60

26	The activated energy of nitrocellulose hydrolysis at various A/S ratios.....	61
27	The activated energy of glucose degradation at various A/S ratios.	62
28	The plot of natural logarithm of glucose concentration versus reaction time (A/S ratio = 8 mL /0.4 g, at 90 °C).....	64
29	The relationship between ln K1 and ln A/S ratio at various temperatures.....	64
30	The relationship between ln K2 and ln A/S ratio at various temperatures.....	65
31	Effect of acid concentration on nitrocellulose hydrolysis.	66
32	Effect of acid concentration on glucose degradation.....	66
33	Glucose yield in nitrocellulose hydrolysis with various A/S ratios.....	68
34	Changes of acid concentration during acid hydrolysis.	69
35a	Nitrogen recovery in nitrocellulose hydrolysis at 80 °C (A/S = 10 ml/0.4 g).....	70
35b	Nitrogen recovery in nitrocellulose hydrolysis at 80 °C (A/S = 8 ml/0.4 g).....	71
35c	Nitrogen recovery in nitrocellulose hydrolysis at 80 °C (A/S = 6 ml/0.4 g).....	71
35d	Nitrogen recovery in nitrocellulose hydrolysis at 80 °C (A/S = 4 ml/0.4 g).....	72
36a	Nitrogen recovery in nitrocellulose hydrolysis at 60 °C (A/S = 10 ml/0.4 g).....	72
36b	Nitrogen recovery in nitrocellulose hydrolysis at 60 °C (A/S = 8 ml/0.4 g).....	73
36c	Nitrogen recovery in nitrocellulose hydrolysis at 60 °C (A/S = 6 ml/0.4 g).....	73
36d	Nitrogen recovery in nitrocellulose hydrolysis at 60 °C (A/S = 4 ml / 0.4 g).....	74
37	Proposed schematic flow of acid hydrolysis of nitrocellulose.....	76
38	Experimental apparatus for electro dialysis (Urano et al. 1984).....	78
39	Processes for batch and continuous fermentation of ethanol (Brandt 1981).	82
40	Processes for distillation of various ethanol products (Brandt 1981).	84

Tables

1	Volume of Wastewater Generated from NC production (Patterson 1976).....	16
2	Characteristics of wastewater produced from NC manufacturing process (Patterson 1976).	16
3	Composition of defined media.	25
4	Comparison of net gas production and SGP (effect of various enzymatic inducers test I) (unit: mL).	35
5	Comparison of net gas production and SGP (effect of various enzymatic inducers Test II) (unit: mL).	36
6	Comparison of net gas production and SGP (effect of various L/NC ratios) (unit: mL).....	39
7	Comparison of net gas production and SGP (effect of various CB/NC ratios) (unit: mL).....	40
8	Comparison of net gas production and SGP (effect of various C/NC ratios) (unit: mL).....	41
9	Nitrocellulose removal efficiency in inducer/NC study (by solvent extraction method) (unit: mg).....	41

10	Comparison of net gas production and SGP (results of two-stage anaerobic system at pH = 6.0) (unit: mL)	43
11	Comparison of net gas production and SGP (results of two-stage anaerobic system at pH = 5.0) (unit: mL)	44
12	Comparison of net gas production and SGP (biodegradation of nitrocellulose and cellulose) (unit: mL)	46
13	Results of biodegradation at pH = 8.0 (effect of various pH on biodegradation).....	49
14	Results of biodegradation at pH = 7.5 (effect of various pH on biodegradation).....	49
15	Results of biodegradation at pH = 6.0 (effect of various pH on biodegradation).....	49
16	Results of biodegradation at pH = 6.0 (effect of various pH on biodegradation).....	49
17	Results of biodegradation at pH = 6.0 (effect of various pH on biodegradation).....	49
18	Results of inhibition study of NC.....	55
19	Kinetic constants in inhibition study.....	55
20	Results of soluble chemical oxygen demand (SCOD) in inhibition study.....	56
21	Soluble chemical oxygen demand in effects of cellulose particle size study.....	57
22	Properties of ion-exchange membranes (Urano et al., 1984).....	61
23	Rate constants of nitrocellulose hydrolysis (K_1) at various temperatures.....	61
24	Properties of ion-exchange membranes (Urano et al. 1984).....	78
25	Specifications of ion-exchange membranes (Huang and Juang 1986).....	79
26	Properties of ion-exchange membrane (Goldstein et al. 1989).....	79
27	Anaerobic metabolism of pyruvate (Brandt 1981).....	81

1 Introduction

Background

Although various inorganic esters of cellulose can be made, only nitrocellulose (NC) has achieved large commercial production. NC, more correctly called "cellulose nitrate" since it is an inorganic ester, is the oldest cellulose derivative. NC enjoys wide use in industry, and is a versatile material for studying the chemistry of cellulose. Studies of NC have yielded many advances in the understanding of the structure and properties of cellulose.

The use of NC as a propellant was the first alternative to the use of black powder, which had previously been used for centuries. The next major step in the history of NC was the development of celluloid, a thin, transparent material used principally in the film industry. NC is soluble in a wide variety of organic solvents, such as tetrahydrofuran, ether/alcohol mixtures, ethyl acetate, and acetone, and yields clear and tough films that are compatible with many plasticizers and resins. Consequently, NC products have also been used in chemical industries as varnishes, films, adhesives, artificial leather, printing materials, and pharmaceuticals. In military applications, NC-based powders are extensively used as propellant in bullets, shells, and various missiles for tube munitions. NC with high nitrogen content is a principal ingredient in propellants, smokeless powder, and some explosives.

NC is currently manufactured by either a batch or continuous nitration system, during which large quantities of waste or unusable NC are generated. This residual or waste NC is composed of insoluble fibers, referred to as NC "fines." Because NC is insoluble in water, the suspended solids from the manufacturing process wastewater are primarily NC fines, 50 percent of which are smaller than 2 microns (μ) (Patterson 1976). The Radford Army Ammunition Plant (RAAP), Radford, VA generates about 0.2 to 0.9 metric tons (500 to 2,000 lb) per day of waste NC fines in process wastewater (Kim and Park 1992). These suspended solids are removed from the wastewater using a series of settling pits, lagoons, and a centrifugation system; the resultant product is known as "pit cotton." Currently, pit cotton collected at boiling tub pits and poacher house pits is recovered and reused; it may comprise up to 10 percent of M14 propellant, M830A1 shell. However, the Army reportedly expects to terminate the reuse of pit cotton

in the near future. Therefore, development of innovative NC treatment and disposal technologies is a critical need.

Objectives

Although NC production technology research and development has a long history, there has only been limited research on NC waste treatment and disposal. This study further evaluated anaerobic treatment and acid digestion as potential alternatives for NC treatment.

Objectives of the Anaerobic Treatment studies were to:

1. Study the effects of substrate and enzymatic inducer concentrations on anaerobic biodegradation of NC. This treatability study used both serum bottle and biochemical methane potential techniques by controlling the concentrations of NC and inducers/NC ratios at neutral pH condition. Lactose, cellobiose, and cellulose were selected as enzymatic inducers in this study. The biogas, volatile acids, nitrite, nitrate, and ammonia produced were used as the parameters to evaluate the system performance.
2. Investigate the NC biodegradation with co-substrates by using two batch-type, single-stage anaerobic reactors.
3. Study the effects of pH values in enzymatic inducers. A treatability study using anaerobic biodegradation on NC was done by controlling the concentrations of NC and inducers at different pH values. The biogas, soluble chemical oxygen demand, volatile acids, nitrite, nitrate, and ammonia produced were used as the parameters to evaluate the system performance.
4. Evaluate a batch two-stage anaerobic system to enhance the biodegradation of NC by separation of acidogenesis and methanogenesis phases.
5. Evaluate a batch staged-feed anaerobic system to study the enhancement of the biodegradation of NC.
6. Investigate the inhibition caused by adding NC into an anaerobic biological system.

Objectives of the Acid Hydrolysis study were to:

1. Study the feasibility of acid hydrolysis of NC. A series of tests were conducted by controlling the concentration of acid, reaction time, and heating temperature within a moderate temperature range at ambient pressure.
2. Predict the hydrolysis reaction of NC with hydrochloric acid using the kinetic model modified from Saeman's work (1945).

3. Identify the degradative intermediate and end products in acid hydrolysis of NC, and to analyze the material balances for both carbon and nitrogen contents.
4. Study the mechanism of hydrolysis reaction and to evaluate the optimal operational condition. Glucose yield, other small molecular weight organic acids, nitrite, nitrate, and ammonia were measured.

Approach

Serum bottles and bench scale anaerobic biological treatment systems were operated using different enzymatic inducers, and their performance was evaluated. The experiments were conducted at the Civil and Environmental Engineering Research Laboratories, New Jersey Institute of Technology, Newark, NJ. A bench-scale acid hydrolysis system was operated to validate the concept of acid hydrolysis using hydrochloric acid. Chapter 3, "Materials and Methods" describes the details of these bench scale evaluation studies.

Scope

Although it appears that that full scale biological treatment system will economically treat NC under methanogenic conditions, this bench scale evaluation made no cost analyses or in-depth evaluation of the performance of full scale treatment systems.

Mode of Technology Transfer

A patent application has been submitted for acid hydrolysis. It is anticipated that acid hydrolysis will become an option when the disposal costs increase in future.

2 Overview

Characteristics of NC

Manufacturing Process of NC

NC is made by nitration of cellulose, a natural high polymer obtained from cotton linters or wood pulp with nitric acid and sulfuric acid. Figure 1 shows a typical NC batch manufacturing process used in the American Military Munitions Industry (Patterson 1976).

Pre-purified cotton linters or wood pulp are shredded and dried to remove excess moisture, and are then treated with mixed nitric and sulfuric acids in "dipping pots" fitted with agitators to esterify most of the hydroxyl groups. Since cellulose nitration is an equilibrium reaction, the extent of nitration at equilibrium is governed primarily by the composition of the mixed acid. Some researchers have found that the maximum nitrogen content that could be obtained was with sulfuric acid: nitric acid ratios between 0.25: 1 and 3: 1 (Ott et al. 1954). Enough water is required in this mixed acid solution. The extent of nitration is affected to a lesser degree by the ratio of mixed acid to cellulose (Lunge et al. 1901). The industrial mixture usually consists of 20 to 30 percent HNO_3 , 55 to 65 percent H_2SO_4 , and 8 to 20 percent water.

The nitration temperature is between 10 °C (dynamite type) and 36 °C (celluloid type). Even though the reaction is nearly completed after about 5 minutes, the mixture remains in the reactor for about 30 minutes. The temperature must remain constant (cooling), since hydrolytic degradation processes that lead to considerable losses in yield begin at a temperature as low as 40 °C. In theory, it should be possible to nitrate all of the hydroxyl groups in cellulose for a nitrogen content of 14.14 percent, but in practice, the most desirable compositions fall between 10.5 to 13.8 percent nitrogen, representing a hydroxyl degree of substitution (D.S.) within 1.8 to 2.9 per glucose anhydride unit rather than the theoretical value 3.0.

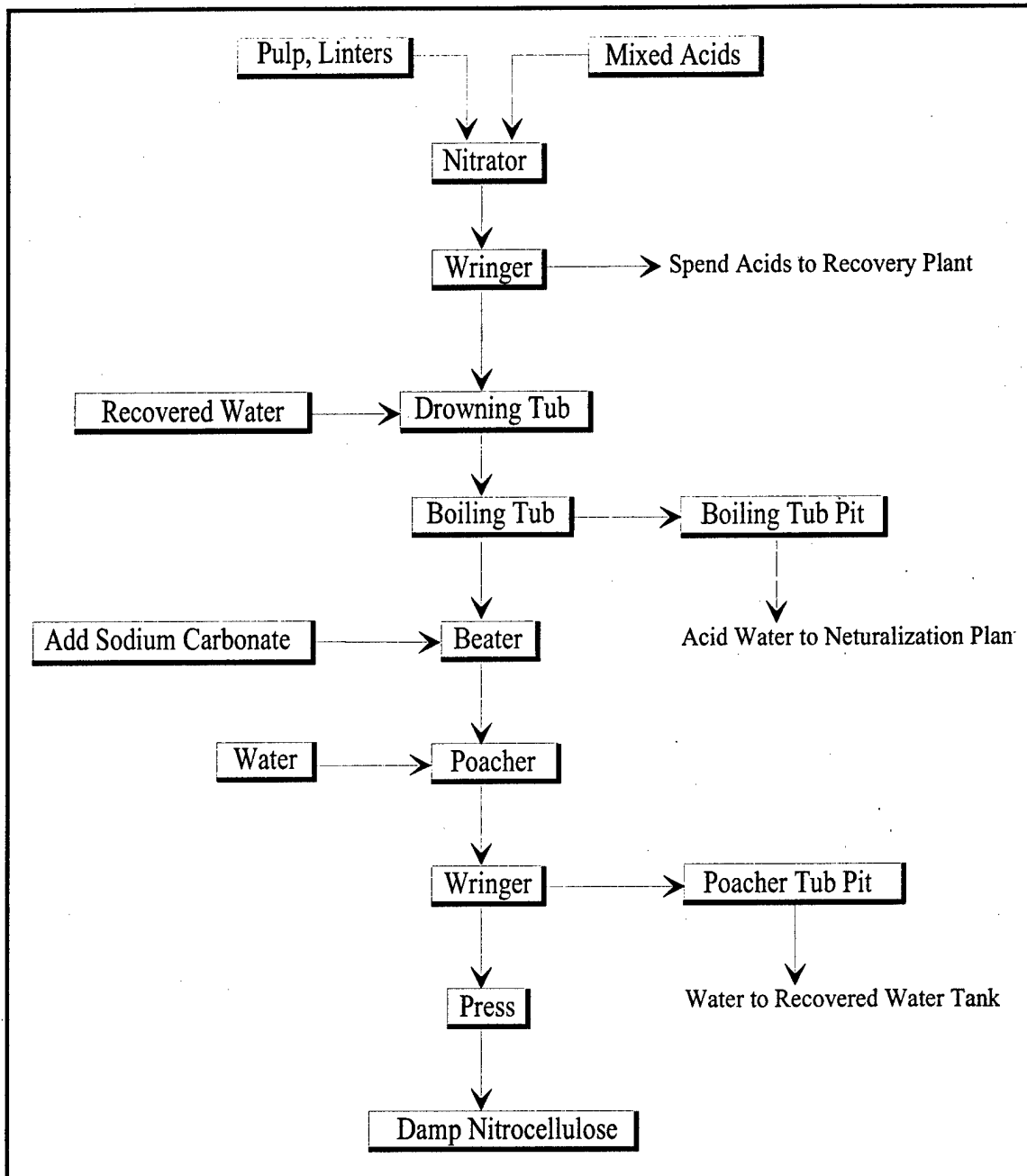

Figure 1. Batch manufacturing process of nitrocellulose (Patterson 1976).

After the nitration process, the NC/acid slurry is passed through a centrifugal wringer, which removes the bulk of the spent acids for recovery. The crude NC then is pumped as a water slurry to the purification area. The purification processes includes an elaborate series of water washes, boiling treatments (to destroy unstable sulfate esters and nitrates of partially oxidized cellulose by acid hydrolysis), neutralization (with dilute sodium carbonate solution), and heating steps to stabilize the NC. After purification, the NC is centrifuged until it has approximately a 30 percent moisture. It is then processed in accordance with the specific end-use requirements of the batch.

Properties of Nitrocellulose

NC is a yellowish-white, odorless, matted mass of filaments, with a specific gravity in the range of 1.58 to 1.65 for commercial usage, and the appearance of raw cotton. The dry density of commercially available NC is between 0.15 to 0.40 kg/L. The specific surface of NC is 1850-4700 cm²/gram, depending on the fineness of the NC. Its characteristics depend on the degree of substitution. Cellulose is a linear polymer composed of individual anhydroglucose units (also called glucopyranose units) linked at the one and four positions by glucosidic bonds with beta configuration. The alcoholic hydroxyl groups of cellulose are polar and can be substituted by nucleophilic groups in strongly acid solution. The mechanism of esterification assumes the formation of a cellulose oxonium ion followed by the nucleophilic substitution of an acid residue and the splitting off of water. Figure 2 shows the esterification reaction from cellulose to NC.

The primary hydroxyl group on the C-6 atom reacts most readily, while the neighboring hydroxyl groups on the C-2 and C-3 atoms of the anhydroglucose react considerably more slowly due to steric hindrance. Esterification is possible with all inorganic acids. Limiting factors are the type and the size of the acid residue and the varying degree of acid-catalyzed hydrolysis, which can lead to a complete cleavage of the cellulose molecule as the result of chain splitting.

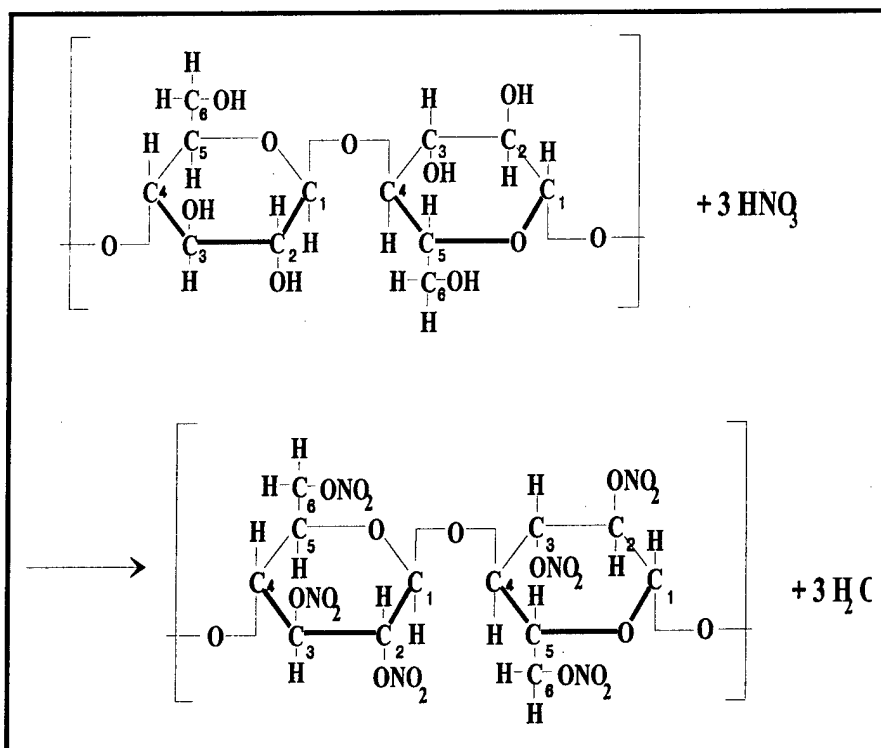

Figure 2. Esterification reaction from cellulose to nitrocellulose.

The three hydroxyl groups of cellulose can be completely or partially esterified by nitrating acid. The degree of nitration can be related to the following theoretical nitrogen contents:

Cellulose Mononitrate, $C_6H_7O_2(OH)^2(ONO_2)$	6.75% N
Cellulose Dinitrate, $C_6H_7O_2(OH)(ONO_2)^2$	11.11% N
Cellulose Trinitrate, $C_6H_7O_2(ONO_2)^3$	14.14 % N

The degree of nitration is most commonly designated by the nitrogen content expressed as percent nitrogen or, less frequently, as the number of cubic centimeters of NO (at 0 °C and 760 mm pressure) evolved from 1 g of NC. It is often convenient to designate the degree of nitration by the D.S., which is the average number of hydroxyl groups nitrated per anhydroglucose unit. NC with a nitrogen content between 11.2 and 12.2 percent is a suitable raw material for lacquers, and NC with nitrogen content 12.2 percent or higher is suitable for explosives exclusively (Conaway 1938).

Dry NC is a very powerful explosive and very sensitive to shock and spark. Its explosive strength depends on the nitrogen content. The higher the nitrogen content, the easier it is to explode. In addition, NC in dry state is a rather poor conductor of electric static charge and can develop a strong charge that can cause an accidental ignition (Quinichon and Tranchant 1989). NC mixed with at least 25 percent of water or alcohol is completely stabilized.

NC, like cellulose, is insoluble in water. This property easily allows its preparation, stabilization, and transportation by quenching with water. The solubility of NC in organic solvents varies with its nitrogen content. Usually, increasing the solubility also increases the viscosity. Carbonyl compounds, like ketones (acetone, methyl ethyl ketone, and cyclohexanone and esters), ethyl acetate, butyl, and amyl acetate are good solvents for NC in industrial use. All nitrate esters including NC have poor resistance to acid, and are more stable in basic medium. Treating NC with concentrated or slightly diluted acids or bases usually leads to denitration, even destruction (Quinichon and Tranchant 1989).

Hazards of Nitrocellulose

NC is extremely flammable and has a flash point of 12.8 °C (closed cup). The melting point and auto ignition range is from 160 to 170 °C (Kim and Park 1992). Because of its low flash point and highly explosive potential, NC is classified as a highly flammable and explosive (or reactive) hazardous material. According to the Resource Conservation and Recovery Act (RCRA), sludge from the NC manufacturing process wastewater treatment plant is also classified as a

hazardous waste by code K044 (from specific source). Data drawn from experiments feeding sheep with NC and regular food shows no negative effect based on blood analysis (Stoller 1993). Results on the health risk study from contact with NC has also shown negligible effect. In view of the nontoxic nature of NC, turbidity and palatability have been used as the guidelines for drinking water standard. NC may blanket benthic habitats and limit available oxygen in receiving water producing significant abiotic environmental effects.

Waste from Nitrocellulose Manufacturing Process

Recent data indicated that RAP generates about 0.2 to 0.9 metric tons (500 to 2,000 lb) waste NC fines from manufacturing processes every day. The volume of wastewater ranges from 16 to 100 gal for every pound of NC produced (Kim and Park 1992). Since NC is insoluble in water, the suspended solids are primarily fine NC fibers, 50 percent of which are smaller than 2 μ . Tables 1 and 2 list the detailed volume and characteristics of wastewater generated from the NC manufacturing process (Patterson 1976).

Table 1. Volume of Wastewater Generated from NC production (Patterson 1976).

Source	Volume,* gpd	Percent Use
Nitration cooling	1,000,000	29.1
Boiling tub	998,000	29.0
Beaters	400,800	11.7
Poachers	343,000	10.0
Blender	423,000	12.1
Wringer	273,800	8.0
Total	3,438,600	100.0

*Flow per manufacturing line. NC capacity per line is 120,00 – 144,000 lb./day

Table 2. Characteristics of wastewater produced from NC manufacturing process (Patterson 1976).

Source	pH	TSS, mg/L	COD, mg/L	NO ₂ +NO ₃ – N, mg/L
Boiling Tub	1.1 – 3.9	8.3 – 10.0	103.5 – 136.0	277.3 – 406.8
Beaters	7.2 – 9.1	140 – 580	31.0	0.6 – 4.0
Poachers	5.5 – 9.8	214 – 278	72 – 685	21.1 – 26.9
Blenders	6.0	463 – 495	—	30.0 – 34.0
Wringer	7.4 – 8.2	343 – 828	135	—

The two basic pollutants resulting from the NC manufacturing process are nitrating acid rinses and NC fines. Acidic rinse waters are discharged to the acid recovery plant for recovery of nitric and sulfuric acids. The recovered acidic wastes are recycled and reused for nitration. The suspended solids-laden wastewater from manufacturing processes is treated by a series of settling pits, lagoon, and centrifugation system. Waste NC such as floor sweepings are collected and treated in a pit by alkaline digestion and given to hazardous waste disposal contractors for final disposal.

Since NC is nontoxic, the measure of total suspended solids (TSS) is used as the water quality criteria. The general water quality criteria for TSS is that settleable and suspended solids should not reduce the depth of the compensation point for photosynthetic activity by more than 10 percent from the seasonally established average for aquatic life. The current TSS limitation set by the National Pollutant Discharge Elimination System (NPDES) is an average of 40 ppm for a 24-hour composite sample. RAAP currently meets these permit requirements. However, the regulation may become more stringent in the future. At that time, additional removal and treatment technologies of NC will be critically needed. Furthermore, RAAP does not presently have the capability to further remove and treat NC during mobilization (Kim and Park 1992).

Decomposition of Nitrocellulose

The susceptibility of NC to degradative processes is a reflection of both the chemical nature of the cellulose chain molecule and of the substituents along the chain. The extent to which each of these factors contributes to the total effect depends on the type and degree of substitution of the NC. Since the material is composed of macro-molecules, decomposition is caused by changes in physical properties due to the physical, chemical, or biological reactions.

Mechanical Decomposition

Grinding, milling, and cutting are common unit processes in the chemical industry and are employed to achieve both size reduction and an increase of surface area of the treated substance. These mechanical processes are applied to high polymers such as cellulose and NC. In this process, the crystal lattice of cellulosic structure is deformed and the D.P. is also reduced (Ott et al. 1954). The mechanism by which the mechanical decomposition occurs is not completely delineated, but it has been attributed to oxidation, hydrolysis, and mechanical rupture. Under the conditions of ball milling, cellulose and NC undergo a lattice

structure deformation, chain scission, increase in solubility, and increase in moisture absorbability.

Thermal Decomposition

NC is relatively stable at moderate temperatures in high purity form. Thermal decomposition becomes detectable only at temperatures above 100 °C. The initial step (rupture of the O-NO₂ bond) is followed a series of oxidation reactions. The reaction is catalyzed by the production NO₂, which is responsible for the self-ignition phenomenon in NC (Kennedy et al. 1970).

Fowler et al. (1954) tested NC (D.S. = 2.2) in an oven with air at 130 °C for various periods of heating time. Results showed that, after 17 hours, very little change occurred in the surface chemistry of NC. Vandoni et al. (1954) measured thermal decomposition of NC at 108 °C. Carbon monoxide and dioxide, nitric and nitrous oxides, methane, and nitrogen were found as products of thermal decomposition. Hydrogen cyanide was found by Muraour et al. (1954) when NC was ignited in a confined space. The propellant type of NC (>12.6 percent nitrogen) was studied by Wolfrom et al. (1955). A solid residue was formed as a result of thermal decomposition, which was characterized analytically. By analyzing homolytic bond scission, the residues were shown to be the fragmented type of oxycellulose nitrate in an extremely low degree of polymerization.

Photochemical Decomposition

Photochemical radiation is capable of cleaving C-C bonds. During photodecomposition, chain scission, crosslinking, and monomer production, including other small molecular weight fractions, could occur. Random chain scission caused by photodecomposition in ethyl acetate and methanol solution has been found for NC at high and low degrees of nitration. The quantum yields for chain scission were about 0.01 to 0.02 (Kennedy et al. 1970). NC in film form breaks down under ultraviolet irradiation. The denitration reaction produces NO₂ and HNO₃ as well as organic reducing materials. The latter compound will cause further degradation of NC and liberation of nitrogen oxides and instigate the autocatalytic process. Researchers reported that, after UV irradiation for a period of time, decomposition and certain degree of denitration took place in NC. The decomposition products included carbon monoxide, carbon dioxide, nitrogen gas, and oxides of nitrogen (Berthelot and Gaudechon 1965; Kraus 1965; Oguri et al. 1965).

Some surface degradation of NC caused by X-rays has been studied. The degradation process in the surface regions during X-ray exposure involved a decrease

in the nitrate concentration and resulted in the concomitant evolution NO_x. On extended exposure, a further nitrogen functionality became evident by the appearance of a peak centered at ~ 400 eV binding energy. After x ray degradation, a sample showed slight yellowing and conversion from a fibrous character to a powdery form (Kennedy et al. 1970).

A study of the destruction of NC by the irradiation of pulsed lasers was conducted by Yang and Ramsey (1993). The laser induced denitration of NC was investigated using an ion trap mass spectrometer for gaseous products. Results showed that shorter laser wavelengths seemed to be better for denitration of NC. Results also indicated that laser detonation was undesirable for treating NC because of a large number of by-products. Pulsed UV laser-induced denitration with an appropriate laser intensity appeared to be a technically feasible alternative for NC destruction.

Alkaline Decomposition

Previous workers have shown that the action of alkalis, especially potassium or sodium hydroxides, on aliphatic nitrates is not a simple saponification regenerating the alcohol and forming sodium nitrate, but is a profound decomposition yielding also sodium nitrite and oxidation products of the aliphatic group. The products reported by various investigators on the action of alkalis on NC included inorganic nitrate and nitrite, ammonia, oxides of nitrogen, cyanide, carbon dioxide and monoxide, organic acids (oxalic, malic, glycolic trihydroxyglutaric, dehydroxybutyric, malonic, and tartronic acids), sugars, modified celluloses and their nitrates, and partially denitrated NC (Kenyon and Gray 1936).

Kenyon and Gray (1936) studied the decomposition of NC in aqueous sodium hydroxide quantitatively. A relatively small amount of carbon dioxide was produced and a relatively large percentage of the nitrate groups was reduced to nitrite. The decomposition of NC appeared to be related to time, concentration of alkali, ratio of alkali to NC, and the temperature. The oxidative decomposition of the cellulose molecule was accompanied by reduction of the nitrate groups to nitrite groups. The time required to decompose a given weight of NC decreased with increasing temperature and alkali concentration, but appeared independent of the alkali-NC ratio at constant alkali concentration.

1. Lure et al. (1991) conducted a study for heterophase alkaline hydrolysis of cellulose nitrate in aqueous sodium hydroxide by UV spectroscopy. He concluded that degradation of cellulose nitrate was significantly slower than denitration, and that dissolution of the degradation products in the alkaline

solution proceeded with higher rate than in neutral or acid solution. The main denitration step involved elimination of HNO_2 .

2. Kim, Alleman, and Quivey (1997) comprehensively evaluated alkaline hydrolysis and subsequent biodegradation as an option to treat NC. An alkaline hydrolysis model was developed for solubilization and denitrification and mass balance during the reactions was analyzed. The results of the design model show that low caustic concentrations (~20,000 mg/L) in combination with intermediate reaction temperatures (50-70°C) will provide the most attractive treatment conditions, within the range of conditions studied. A similar study conducted by Wendt and Kaplan (1976) used a modified activated sludge process to treat NaOH-digested NC solution. Results indicated a relatively good removal of BOD (88.6 percent), but less satisfactory removal of TOC and COD (54.5 and 55.2 percent, respectively). From these two studies, obviously, the soluble form of the organics still exhibit resistance to biodegradation.

Acid Denitration and Hydrolysis

The residual acids remaining in NC from the manufacturing process can cause NC to be unstable and can accelerate the rate of decomposition (Ott et al. 1954). This decomposition results from the cleavage of the cellulosic molecule and chain splitting. Therefore, acid is a possible alternative way to treat NC due to its ability to accelerate the hydrolysis process. Acid-catalyzed hydrolysis has been used for a long time in the wood industry and in agricultural waste treatment to convert cellulose to useful products (Goldstein et al. 1985 and 1992). Additionally, since NC is a cellulose derivative, it will have a chemical and physical crystal structure similar to other cellulosic materials. Acid hydrolysis should be as effective treating NC as it is for cellulose.

Denitration of NC also takes place with treatment by acids, but the reaction is much slower than that with alkalies. Acid denitration of NC has been demonstrated by the treatment with mixed acid containing more water than the acid used to produce the NC. In this case, the esterification equilibrium shifts in the direction of lower nitrogen content. One practical aspect of this behavior is observed in the denitration of NC, which occurs while wringing out the spent acid. This denitration is caused by dilution of the spent acid with moisture from humid air.

Since the acid residue in the esterification process can cause a varying degree of acid-catalyzed hydrolysis, which can lead to decomposition or even a complete cleavage of cellulosic molecules as the result of statistical chain splitting, deni-

tration and cleavage of the cellulosic structure caused by acids and acid hydrolysis shows an attractive potential to treat the waste NC fines. Little information is available for a detailed study of acid hydrolysis to treat NC fines, but acid hydrolysis has been used for some time to convert cellulose (which has a formula structure similar to NC) to useful products.

Lure et al. (1991) conducted a study on chemical transformation of cellulose nitrate with aqueous sulfuric acid by UV spectroscopy. This study concluded that denitration occurred basically within the fibers and that the rate of denitration was faster than rate of degradation. Denitration was accompanied by a series of oxidation-reduction reactions, the form of HNO_3 reduction products (NO , N_2O , N_2) and the oxidation of organic compounds (CO and CO_2).

In theory, any mineral acid is effective, but sulfuric and hydrochloric acids are widely used in the acid hydrolysis of cellulosic material because of their lower costs. Between sulfuric and hydrochloric acids, hydrochloric is used by most industries because it is easier to recover from the process. Glucose is the major product of acid hydrolysis of cellulosic materials. Glucose yields range from 40 to almost 100 percent depending on acid concentration, heating temperature, and reaction time (Goldstein et al. 1985 and 1992). Because it has the same crystal cellulosic structure as cellulose, NC can be treated by the acid hydrolysis process to produce large amounts of glucose.

Biological Degradation

Biological degradation is chemical change in nature. However, it is not considered chemical degradation since the source of the attacking chemicals are microorganisms, such as fungi and bacteria. These chemicals are of a catalytic nature, e.g., enzymes. The susceptibility of a polymer to microbial attack generally depends on the enzyme availability for the polymer, enzyme specificity of the polymer, and presence of a coenzyme, if required.

Little work has been done for biological treatment of NC because NC was reported to be extremely bioresistant. Bokomy (1896) found that mold, e.g., *aspergillus*, grew on NC in a medium comprised of an aqueous solution of mineral salts. He suggested that NC provides the mold with essential carbon, and perhaps nitrogen. Malenkovic (1908) and Jacque (1910) concluded that only the mineral salts dissolved in water and various organic substances, such as incompletely nitrated cellulose were used by the mold. However, Hubregste (1978) conducted a feasibility study on treatment of NC lime sludge and oxidation of nitroglycerin from wastewater stream. He found that NC was only slowly degraded in landfills. Lacey (1980) reported fungal growth on gunpowder, which

caused deterioration. Some early research showed that even a very small degree of substitution in molecular structure of cellulose can render it resistant to microbial breakdown (Siu et al. 1949; Siu 1951). Since NC used by the military has a very high degree of substitution (about 2.3 to 2.9), it is believed the NC is quite resistant to microbial attack

Brodman et al. (1981) conducted a study using micro-organisms for partial denitration of NC-based small arms propellants, to gain burning rate control. He reported that *Aspergillus fumigatus* was found to grow on gunpowder suspended in a nitrogen deficient, carbon-supplemented medium, but no growth was observed under the same conditions when carbon source was absent. He concluded that nitrate was released from NC by hydrolysis of the NC nitrate ester group that was enhanced by the micro-organisms. But *Aspergillus fumigatus* did not directly attack the NC. Gallo et al. (1993) conducted an investigation using three different fungi, *Phanerochaete chrysosporium*, *Aspergillus fumagatus*, and *Actinomyces*, to evaluate the potential degradative capability of fungus. Results showed that none of the tested organisms used NC as a carbon source under the surveyed conditions. However, some NC hydrolysis did occur when it was cultured with *Aspergillus fumagatus* and *Actinomyces*.

Williams et al. (1989) also reported significant removal efficiency of NC in soil by composting. Roy F. Weston, Inc. (1993) conducted a field demonstration using static pile composting technique for NC-contaminated soils at the Badger Army Ammunition Plant (BAAP) in Baraboo, WI. In this study, the contaminated soil and sediment is mixed with organic amendments (bulking agents/carbon sources) to enhance microbial metabolism and contaminants destruction. Results showed that the removal efficiency ranged from 26 to almost 100 percent for extractable NC.

3 Materials and Methods

Pure NC was obtained from RAAP. The nitrogen content was about 13.5 percent. NC received from RAAP was mixed with a large amount of water. Deionized water was added to the NC mix, which was allowed to sit overnight to expel alcohol. Then it was dried at room temperature for 12 to 16 hours. The air-dried NC was then put into a vacuum oven (NAPCO vacuum oven model 5831, Fisher Scientific Inc.) at a pressure of 2 to 5 cm of mercury at 65 °C for 4 hours to evaporate all water. The NC was then placed in a desiccator (White 1962). After the drying process, the NC was ready to be used for all tests in this investigation. Cellulose (type 20, 20 μ average particle size), crystalline D-(+)-cellobiose, lactose (sugar milk), and other chemicals used in this study were obtained from Sigma Chemical Company, St. Louis, MO.

Anaerobic Treatment Process

Bacteria usually use two types of enzyme systems for their cellular activities and energy conversion. Biosynthetic enzyme systems provide essential amino acids and other intermediates that are essential for growth and other cellular activities. Organic compounds are converted by the second enzyme system, the catabolic enzyme system, into simpler growth substrates and energy. Biosynthetic enzymes are often produced continuously, while catabolic enzymes, on the other hand, usually require induction by the degradation products of interested compounds. These kinds of enzyme systems can be substrate specific but some are not. Sometimes compounds of similar structure, degradation products, or earlier precursors may induce these enzymes (Babcock and Stenstrom 1993).

Because its chemical structure is similar to that of NC, cellulose was used as the inducer in this study. Both cellulose and NC are linear polymers composed of individual anhydroglucose units linked at positions 1 and 4 through glucosidic bonds with beta configuration. The only difference between the two is that the hydroxyl groups of cellulose were esterified by nitro- groups in NC. As mentioned earlier, it is possible to treat NC-contaminated soil with a composting technique. In this application, contaminated soil was mixed with a bulking agent and amendment materials that contained large amounts of cellulose. Therefore, cellulose would be a good candidate for a co-substrate to enhance biodegradability in NC treatment. Cellobiose consists of two anhydroglucose units; it is the

degradation product of cellulose. To provide the degradation products for biological hydrolysis, cellobiose was chosen as another enzymatic inducer in this investigation. On hydrolysis, the molecule of lactose, or milk sugar, is split to yield a molecule of glucose and a molecule of galactose. Glucose is the major degradation product from the hydrolysis of cellulose. Therefore, lactose was considered as the third inducer in this study.

For many enzymes, the rate of catalysis, V , varies with the substrate concentration, $[S]$. V is defined as the number of moles of product formed per unit time. At a fixed concentration of enzyme, V is almost linearly proportional to $[S]$ when $[S]$ is small. At high $[S]$, V is nearly independent of $[S]$. In 1913, Leonor Michaelis and Maud Menten proposed a simple model to account for these kinetic characteristics. The critical feature in their system is that a specific ES complex is a necessary intermediate in catalysis. The simplest proposed model that accounts for the kinetic properties of many enzymes, is:

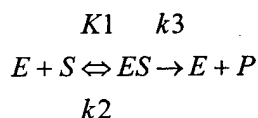

An enzyme, E , combines with S to form an ES complex, with a rate constant k_1 . The ES complex has two possible fates. It can dissociate to E and S , with a rate constant k_2 , or it can proceed to form product P , with a rate constant k_3 . After rearrangement and substitution, the Michaelis-Menten equation results:

$$V = V_{\max} \frac{[S]}{[S] + K_M} \quad \text{Eq 1}$$

where K_M is Michaelis constant and V_{\max} is the maximal rate. K_M is equal to the substrate concentration at which the reaction rate is half of its maximal value. The Michaelis constant and the maximal rate can be readily derived from rates of catalysis measured at different substrate concentrations. A plot of $1/V$ versus $1/[S]$, called a Lineweaver-Burk plot, yields a straight line with an intercept of $1/V_{\max}$ and a slope of K_M/V_{\max} :

$$\frac{1}{V} = \frac{1}{V_{\max}} + \frac{K_M}{V_{\max}} \times \frac{1}{[S]} \quad \text{Eq 2}$$

In enzyme catalysis, some specific molecules and ions can inhibit the enzymatic activity. In the presence of competitive inhibitor, the Michaelis-Menten equation is replaced by:

$$\frac{1}{V} = \frac{1}{V_{\max}} + \frac{K_M}{V_{\max}} \left(1 + \frac{[I]}{K_i} \right) \left(\frac{1}{[S]} \right) \quad \text{Eq 3}$$

in which $[I]$ is the concentration of inhibitor and K_i is the dissociation constant of the enzyme-inhibitor complex.

The master culture of mixed anaerobes was taken from an anaerobic digester at Bergen County Wastewater Treatment Plant, in Little Ferry, NJ and acclimated to a defined synthetic wastewater (Table 3). This defined media provided sufficient amounts of nitrogen and phosphate for organisms metabolism. The necessary mineral materials were also provided to ensure anaerobes' growth. The acclimation system consisted of a 4L flask reactor and gas collection devices (Figure 3). Gas produced was measured using a wet tip gas meter. The reactor was maintained at 35 °C by a constant-temperature waterbath or a temperature-controlled chamber. The pH was controlled in neutral condition by the addition of sodium bicarbonate as a buffer. Hydraulic Residence Time and Sludge Retention Time of anaerobic system were sustained at 20 days in this study.

After a period of microbial acclimation to cellulose as the sole carbon source, Biochemical Methane Potential (BMP) and the Serum-Bottle Technique were used to test the anaerobes' activity and substrate toxicity for all experiments (Owen et al. 1979). The BMP assay was conducted by introducing 80 mL of deoxygenated defined media (Table 3) into a 125 mL serum bottle. The bottle was sealed with a butyl rubber septum stopper and an aluminum seal to prevent further oxygen contamination.

Table 3. Composition of defined media.

Ingredient	Conc, mg/L	Ingredient	Conc, mg/L
Nutrients		Minerals	
KH ₂ PO ₄	500	CaCl ₂	150
Na ₂ SO ₄	150	MgCl ₂ ·6H ₂ O	200
NH ₄ Cl	530	FeCl ₂ ·4H ₂ O	20
		MnCl ₂ ·4H ₂ O	0.50
Buffer		H ₃ BO ₃	0.25
NaHCO ₃	3000	ZnCl ₂	0.25
		CuCl ₂	0.15
		Na ₂ MoO ₄ ·2H ₂ O	0.05
		CoCl ₂ ·6H ₂ O	2.50
		NiCl ₂ ·6H ₂ O	0.25

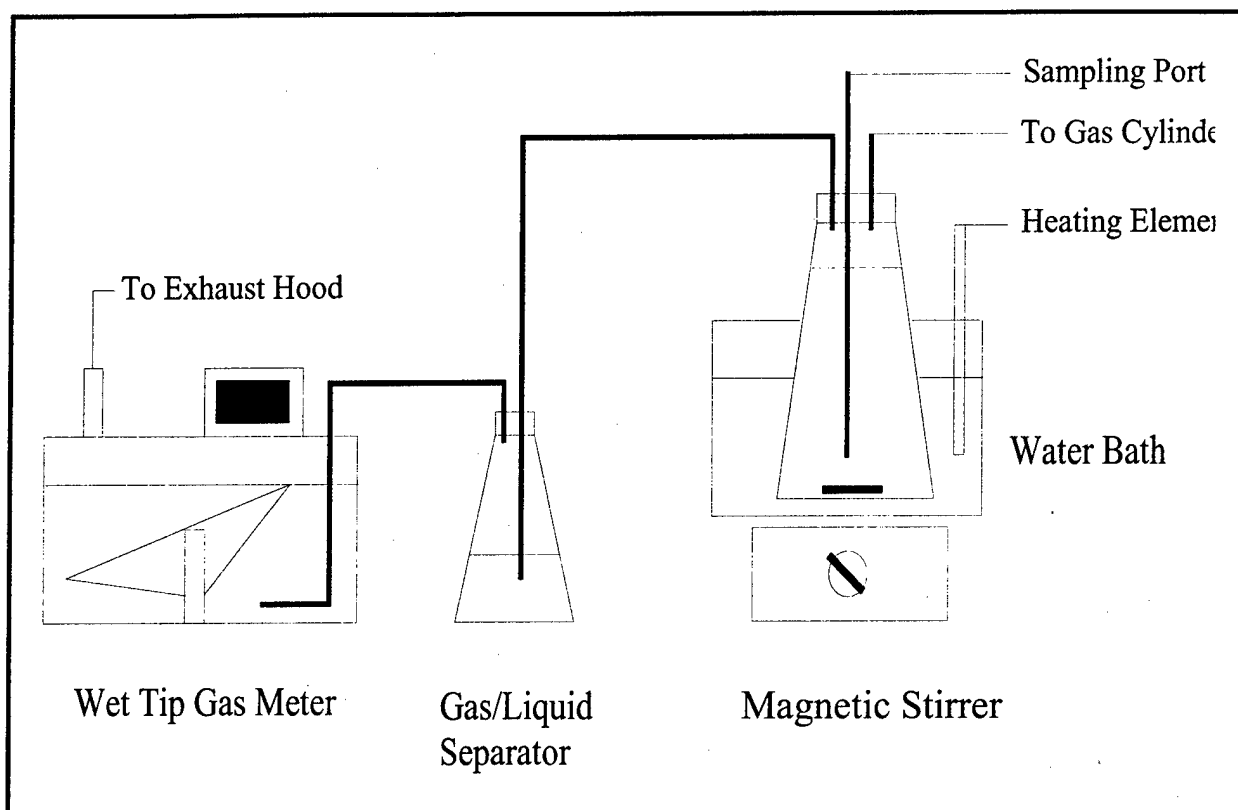

Figure 3. Schematic diagram of anaerobic treatment system for master culture of mixed anaerobes.

Then 20 mL of anaerobic sludge from the master culture was injected into the deoxygenated and negative pressure serum bottle with an airtight syringe. After 1 hour of equilibration in a 35 °C waterbath, the gas volume was “zeroed” to ambient pressure by a prelubricated syringe and the bottle was ready for further testing.

Currently, there is no “standard” analytical method to measure NC in soil, compost, and sludge. An indirect method is used to extract NC from soil, compost, and sludge. It hydrolyzes the nitro-groups in NC, separates nitrate or nitrite, and measures the liberated nitrite colorimetrically. The disadvantage of this method is that the nitrogen content or D.S. of the NC must be known. It converts the nitrite measurements to NC concentrations. Incomplete separation of nitrate/nitrite ions coextracted from the residue can lead to overestimation of NC, and incomplete extraction and/or hydrolysis of the NC can underestimate NC. Additionally, this method provides no information about the condition of NC. Griest (1993) proposed a size exclusion chromatography (SEC)-base method to analyze NC in soil, compost, or sludge. The method has the potential of providing both quantitative (e.g., concentration of NC) and qualitative (e.g., molecular weight distribution, functional groups) information. This method is still under investigation and has some technical difficulties to overcome. Because of the reasons mentioned above, indirect parameters, such as biogas production

and volatile organic acids contained in solution, were used to evaluate the biodegradability of NC by anaerobic micro-organisms in this study.

The concentration of volatile organic acids were measured by the distillation method in accordance with Standard Methods (Method 504 B). The sample was first filtered and 100 mL of filtrate was distilled with 5 mL of concentrated sulfuric acid and 100 mL of deionized water. Exactly 150 mL of distillate were then titrated with 0.1 N standard sodium hydroxide solution. Volatile organic acids were expressed as mg volatile acids as acetic acid per liter. This technique can recover acids containing up to six carbon atoms.

The biogas produced in the anaerobic reactor was collected in a gas collection tube. The retaining solution contained saturated sodium chloride and five percent sulfuric acid to prevent the biogas from dissolving in the solution. The volume of gas produced was measured as the volume of liquid displaced. The gas produced in the BMP test was determined by the pressure change in the bottle with a 35 mL pre-lubricated syringe equipped with a 20-gauge needle (Owen et al. 1979). The compositions of biogas were analyzed by a Gow-Mac Series 550P Gas Chromatograph equipped with Thermal Conductivity Detector, CTR1 Alltech Column, using helium as the carrier gas.

The amounts of nitrate and nitrite from biotransformation of NC were measured by EPA method B-1011 (EPA Test Method 300.0) using a single column Ion Chromatograph (Water Series 600E controller and pump, 715 WISP sample injector, and UV detector set at 214 μm wavelength). The sample was filtered through 0.22 μ filter disk paper, C18, and Hg-Ag pretreatment cartridges to remove organics and chloride ion. One hundred μL of pretreated sample was injected into IC for analysis. The concentration of ammonia was analyzed following the Standard Methods-Nesslerization method (Method 417). An Orion 407A pH meter was used to measure the pH.

Acid Hydrolysis

Hydrochloric Acid Hydrolysis of Nitrocellulose

Acid hydrolysis of cellulosic materials has been studied for many years. The degradation of cellulosic materials to sugar seems, at first, to be a hydrolytic cleavage of the glucosidic bonds. However, cellulosic materials behave fundamentally different from other carbohydrates in hydrolysis. The glucosidic bonds are cleaved relatively easily, but the crystalline structure is far more resistant to heterogeneous hydrolysis by dilute acids than similar, but non-crystalline, car-

bohydrates. Over a hundred years ago, it was found that highly concentrated hydrochloric acid is a very effective hydrolytic agent. A considerable amount of experimentation has been performed to study the kinetics of acid hydrolysis of pure cellulose substrates. In a cellulose study, researchers depicted the acid hydrolysis of cellulose as a pseudo-first-order sequential process (Saeman 1945). The reactions can be described as follows:

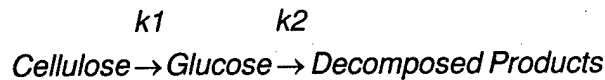

Hydrolysis of cellulosic materials and its product, glucose, play a central role in the conversion of renewable resources to foods, fuel, and chemical feedstocks. Cheap glucose would not only find demand in the food sweetener market, but could serve as a substrate for the production of fuel, alcohol, and protein. Many more organisms can grow on glucose than on other substrates. Also, glucose substrates should yield fewer problems with undesirable or toxic residues.

Little experiment has been performed on acid hydrolysis of NC. Also because of their similar chemical structure, acid hydrolysis would seem to be an attractive treatment process for NC. However, there is a drawback in this process. Since this process uses a large amount of concentrated hydrochloric acid it is not economical. Therefore, recovery of the acid and conversion of the glucose to useful final products will be the critical factors for implementing this process economically. Several technologies have been studied and developed to recover the concentrated acid from the hydrolysis process. Some of them have been proved to be successful. The research conducted by Goldstein and Easter (1992) showed potentially large savings in recovery costs by electro dialysis. Since fermentation of glucose and acid recovery have already been proven feasible, the experiments along these lines were not conducted in this investigation.

Chemical reaction rates generally increase with increased temperature. In general, variations in reaction rate as a function of temperature can be represented by the Arrhenius equation:

$$k = A_f (e^{-Ea/RT}) \quad [\text{Eq 4}]$$

or

$$\ln k = \ln A_f - Ea/RT \quad [\text{Eq 5}]$$

where:

- k = the rate constant; time⁻¹
- A_f = Arrhenius frequency factor

- E_a = activation energy; Kcal/mole
 R = universal gas constant; 1.987 g-cal / g-mole-°K
 T = absolute temperature, °K.

The energy of activation determines that fraction of the total number of molecules that can be sufficiently activated at a given temperature that will react; therefore the magnitude of activated energy is a direct determination of the rate of particular chemical reaction. The study of chemical hydrolysis involves the effect of retention time, reaction temperature, substrate/acid ratio and the concentration of hydrochloric acid.

In this experimental study, 0.4 g NC was placed in glass tubes with various amounts of concentrated hydrochloric acid (about 38 percent) with predetermined acid/solid ratios. These tubes were put into a water bath controlled at a designated temperature. Tubes were then removed from the water bath at various intervals, quenched in ice water, and analyzed for glucose content.

The concentrations of glucose were determined using a Sigma glucose diagnosis kit (enzymatic-colorimetric) with spectrophotometer at wavelength 425 μm . A standard glucose solution of 1,000 mg/L was also used to calibrate the measurements. Small molecular weight organic acids were measured by a High Performance Liquid Chromatograph (HPLC) (Water 6000A solvent delivery system, Water 410 Differential Refractometer equipped with Refractive Index Detector and carbohydrate column and Varian 4270 Integrator). Organic acids were identified by comparing them with standard organic acids in terms of retention time for each peak. Nitrite, nitrate, and ammonia were determined using essentially the same methods used in anaerobic treatment process.

Approach To Estimate the Kinetic Constants of Acid Hydrolysis

A considerable amount of study has been done on the kinetics of acid hydrolysis of pure cellulose substrates. In a cellulose study, the researchers depicted the acid hydrolysis process of cellulose as a pseudo-first-order sequential process (Saeman 1945 and Fagan et al. 1971). These theories and models were adapted and compared in this study. Since NC concentration is not easy to measure directly, the concentration of glucose was used to develop this kinetic model. The Method of Residuals were employed to estimate the reaction rate constant. The reactions and rate constants can be described by the following equations:

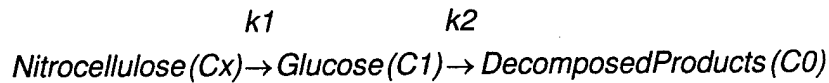

$$dCx / dt = -k_1 Cx \quad \text{[Eq 6]}$$

$$dC_1 / dt = +k_1 Cx - k_2 C_1 \quad \text{[Eq 7]}$$

$$dC_0 / dt = +k_2 C_1 \quad \text{[Eq 8]}$$

where:

k_1 = rate constant of NC hydrolyzed to glucose

k_2 = rate constant of glucose degraded to decomposed products.

In these equations:

C_x = concentration of NC (M)

C_1 = concentration of glucose (M)

C_0 = concentration of decomposed glucose products (M)

k_1 and k_2 are the rate constants for each individual reaction (time^{-1}).

The hydrolysis of NC follows a first-order rate equation, hence:

$$C_x = C_x^0 e^{-k_1 t} \quad \text{[Eq 9]}$$

To find the dependence of C_1 on time, Eq. (7) can be solved by using the integrating factor method. First write Eq. (7) as:

$$dC_1 / dt + k_2 C_1 = k_1 C_x^0 e^{-k_1 t}$$

and multiply both sides by $e^{k_2 t}$, the integrating factor, the following expression is obtained:

$$(dC_1 / dt + k_2 C_1) e^{k_2 t} = k_1 C_x^0 e^{-k_1 t} e^{-k_2 t} \quad \text{[Eq 10]}$$

Next notice that:

$$dC_1 e^{k_2 t} / dt = (dC_1 / dt + k_2 C_1) e^{k_2 t} \quad \text{[Eq 11]}$$

Comparing Eqs. (10) and (11)

$$dC_1 e^{k_2 t} / dt = k_1 C_x^0 e^{(k_2 - k_1) t}$$

which can be integrated to yield $-k_1$

$$C_1 e^{k_2 t} = k_1 C_x^0 e^{(k_2 - k_1)t} / (k_2) + \text{Constant}$$

The constant can be determined by the boundary conditions. Set $C_1 = 0$ at $t = 0$; then the constant equals to $-k_1 C_x^0 / (k_2 - k_1)$, and the integrated equation becomes:

$$C_1 = k_1 C_x^0 (e^{-k_1 t} - e^{-k_2 t}) / (k_2 - k_1) \quad [\text{Eq 12}]$$

For the initial conditions $C_1^0 = 0$ and $C_0^0 = 0$, the mass balance relationship is:

$$C_x^0 = C_x + C_1 + C_0 \quad [\text{Eq 13}]$$

Substituting Eqs. (9) and (12) into Eq. (13) and rearranging this equation:

$$C_0 = C_x^0 + C_x^0 (k_2 e^{-k_1 t} - k_1 e^{-k_2 t}) / (k_1 - k_2) \quad [\text{Eq 14}]$$

Clearly, Equations 12 and 14 are inapplicable in the special case $k_2 = k_1$. The concentration of glucose is a function of time, and the smaller rate constant, k_2 , can be estimated from a semi-logarithmic plot of C_1 at later times when C_x is negligible. This plot is extrapolated back to $t = 0$. This line is described by the equation (from Eq 12):

$$\ln C_1^{\text{ext}} = \ln [k_1 C_x^0 / (k_1 - k_2)] - k_2 t \quad [\text{Eq 15}]$$

Combining Eqs. (15) and (12):

$$\ln C_1^{\text{ext}} - C_1 = \ln [k_1 C_x^0 / (k_1 - k_2)] - k_1 t \quad [\text{Eq 16}]$$

Graphically, Eq. (16) represents the logarithm of the differences between the experimental C_1 values at early times and values extrapolated from late times (C_1^{ext}). The plots of Eqs. (15) and (16) should have the same intercepts and their slopes yield estimates of the rate constants. Figure 4 shows this technique.

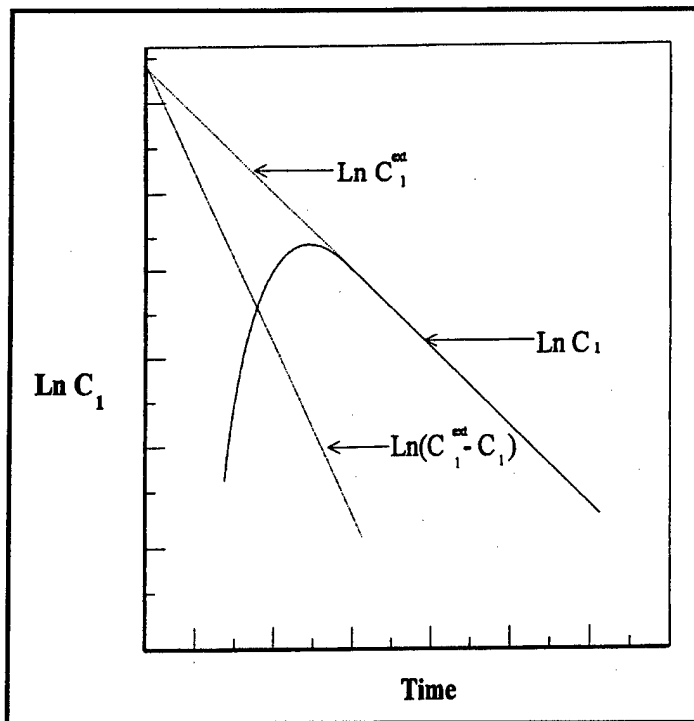

Figure 4. The method of residuals (Connors 1985).

4 Anaerobic Treatment Process

This study investigated the biodegradation of NC in anaerobic batch reactors with and without supplemental carbon sources or inducers, such as cellulose, cellobiose, and lactose, and two-stage anaerobic system. The concept of staged-feed was also conducted to investigate the possibility of biodegradation enhancement of NC.

Effect of Various Enzymatic Inducers

Grady (1985 and 1986) pointed out the important concept of testing the use of inducer compounds to maintain activity over long periods without the presence of the target compound. Babcock and Stenstrom (1993) suggested that an ideal inducer compound would maintain the degradation kinetics and growth characteristics of an enrichment culture without the presence of the enrichment substrate. Sometimes a degradative enzyme can be substrate specific, but it is often quiet nonspecific and can be induced by compounds of similar structure or by degradation products. This study tried to use this concept to induce the enzyme that can degrade NC from different inducers with similar structure, or from degradation products from the target compound.

This study used three types of enzymatic inducers: cellulose, lactose, and cellobiose. The concentrations of enzymatic inducer were all fixed at 1,000 mg/L and the inducer/NC ratio was maintained at 10/1. Ten sets of tests were conducted at the same time. Blank one (B-Media) contained only defined media. The data from this blank gave the information of gas production from media itself. Blank two (B-Culture) contained biomass and defined media. This blank indicates the biodegradation from biomass and media. Three sets of serum bottles were used in the experiment. Each bottle contained one of the following inducers, i.e., cellulose (C), lactose (L), and cellobiose (CB), respectively. The experiments were conducted in triplicate. These were used as the control groups to evaluate the biogas produced from the bottles containing inducers and NC together. Two sets of bottles contained NC only, one set had 100 mg/L of NC (NC1), and another set had 1,000 mg/L (NC2). They were also done in triplicate, and were used to provide information on the biodegradation of NC without the use of inducers (for comparison). Three other bottles contained NC and inducers: cellulose and NC

(C-NC), lactose and NC (L-NC), and cellobiose and NC (CB-NC), respectively. The inducer/NC ratio was fixed at 10/1 in this study.

Figure 5 shows the results. Some gases were produced in all bottles except in the two blanks. Figure 5 shows about 2 days of lag period for lactose and cellobiose, and 3 days for cellulose. Lactose had the highest volume (about 40 mL) of gas production and cellulose had the lowest volume (30 mL). Cellobiose produced less biogas than did lactose. Comparison of gas production indicated that the bottles with inducers alone produced more gas than these with inducer and NC. With the addition of NC, lactose and cellobiose were less affected than cellulose. This study shows that NC would affect the biodegradation of inducers and decrease the gas production. Among all three inducers, cellulose produced the least amount of gas. The measured gas productions from this study are compared to the stoichiometric calculated gas production (SGP). The stoichiometric gas production from the use of NC and cellulose was calculated by using McCarty's approach by assuming that NO_3^- was the main nitrogen source in the medium (McCarty 1972 and 1969, Duran et al. 1993). The balanced equations for the anaerobic breakdown of each of these substrates are:

$\text{C}_{12}\text{H}_{14}\text{O}_{22}\text{N}_6$ (NC):

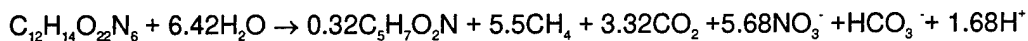

CH_2O (Cellulose):

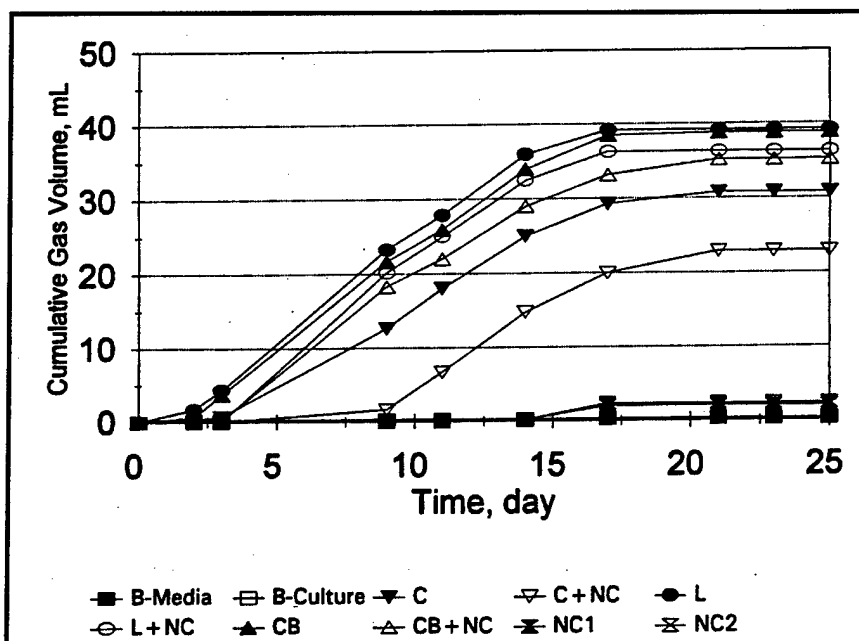
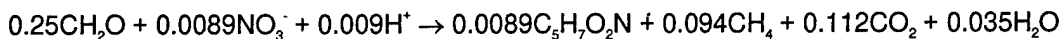

Figure 5. Effect of various enzymatic inducers in batch study I.

Table 4 lists the results, which indicate that cellobiose has the highest conversion ratio, 57 percent, and NC has only 5 percent of conversion in this study.

After 3 more months of acclimation, the same experiment was conducted again. Figure 6 shows the results. This results are very similar to the previous experiment. Lactose and cellobiose had almost the same amount of biogas production. However, the addition of NC did not significantly affect the biogas production in the presence of these two inducers. Among the three inducers, cellulose still produced the least amount of biogas. The addition of NC still affected the biogas production in bottles containing the cellulose solution. For bottles containing NC only, the samples had also produced less than 7 mL biogas, only slightly more than the blank samples. A comparison of gas production as an indicator of bio-transformation (Table 5) shows results similar to those listed in Table 4, except that the conversion of cellulose dropped from 45 to 23 percent, and the conversion of NC increased from 5 to 6 percent. Table 5 also shows that NC inhibited cellulose degradation in the second test. The percentage gas production fell from 31.4 to 13.6 percent.

Table 4. Comparison of net gas production and SGP (effect of various enzymatic inducers test I) (unit: mL).

Description	Conc. mg/L	Measured Gas Volume	SGP	Ratio, %
Cellulose	1000	30.5	68.0	44.9
C + NC	1000 + 100	22.6	72.0	31.4
Lactose	1000	38.9	72.0	54.0
L + NC	1000 + 100	36.0	76.0	47.4
Cellobiose	1000	38.5	68.0	56.6
CB + NC	1000 + 100	34.9	72.0	48.5
NC-1	100	1.7	4.0	42.5
NC-2	1000	2.0	39.5	5.1

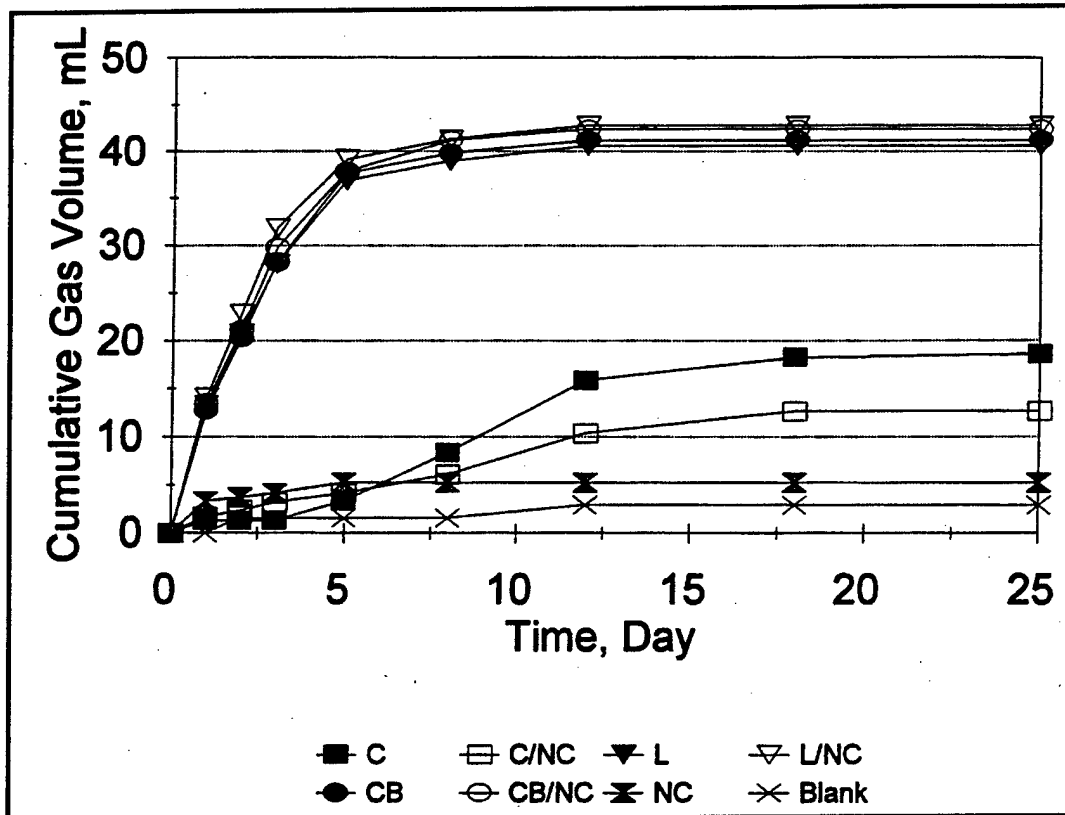

Figure 6. Effect of various enzymatic inducers in batch study II (inducer/NC = 10/1, inducer concentration = 1,000 mg/L).

Table 5. Comparison of net gas production and SGP (effect of various enzymatic inducers Test II) (unit: mL).

Description	Conc. mg/L	Measured Gas Volume	SGP	Ratio, %
Cellulose	1000	15.7	68.0	23.1
C + NC	1000 + 100	9.8	72.0	13.6
Lactose	1000	37.9	72.0	52.4
L + NC	1000 + 100	39.9	76.0	52.5
Cellobiose	1000	38.3	68.0	56.3
CB + NC	1000 + 100	39.5	72.0	54.9
NC	1000	5.3	39.5	6.1

Effect of Inducer/Nitrocellulose Ratios

To understand the effect of biodegradation caused by different inducer/ NC ratios, pre-determined inducer/NC ratios were tested. Figures 7 to 9 show the results.

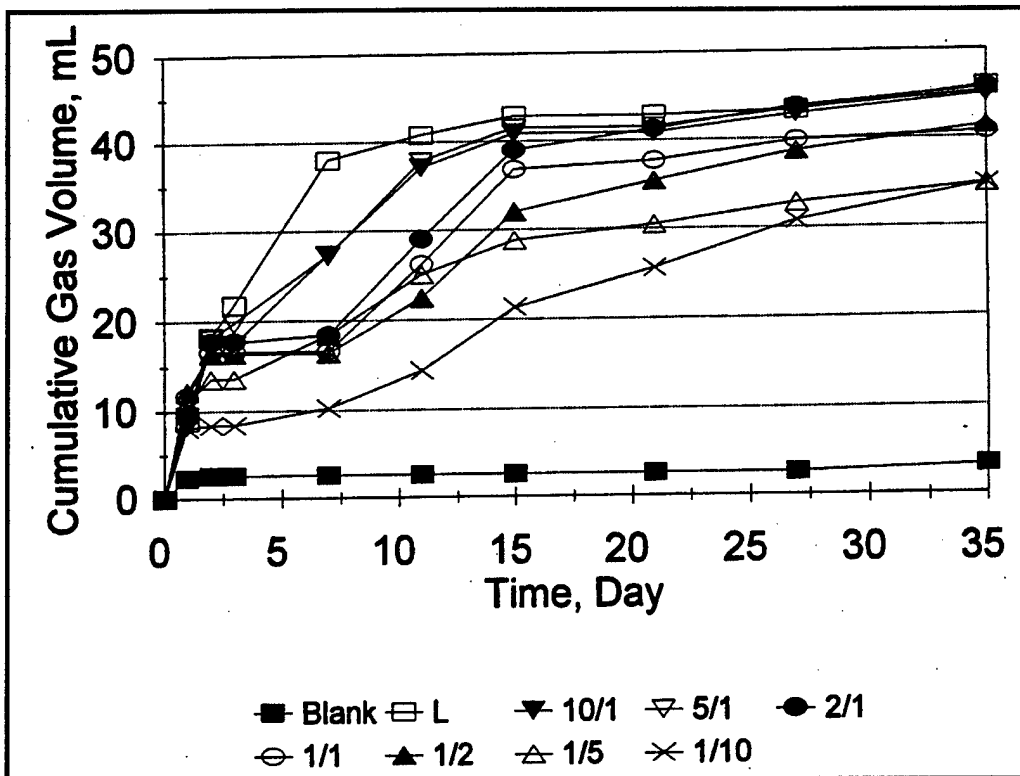

Figure 7. Effect of various lactose/nitrocellulose ratios in batch study (lactose concentration = 1,000 mg/L).

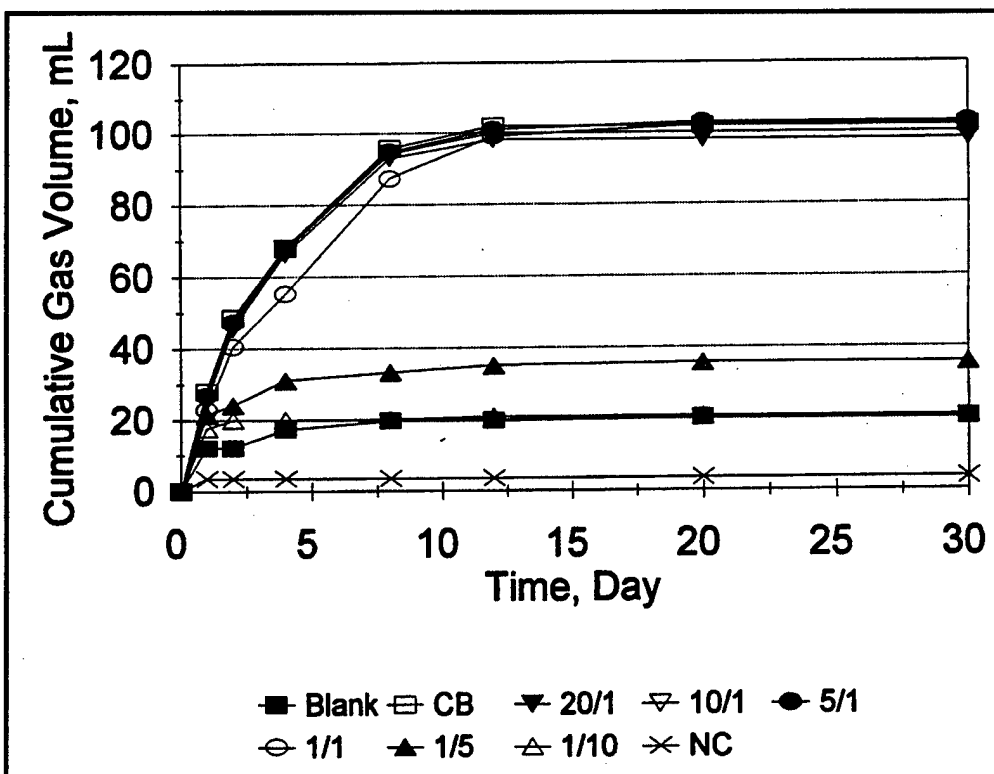

Figure 8. Effect of various cellobiose/nitrocellulose ratios in batch study (cellobiose concentration = 2,000 mg/L).

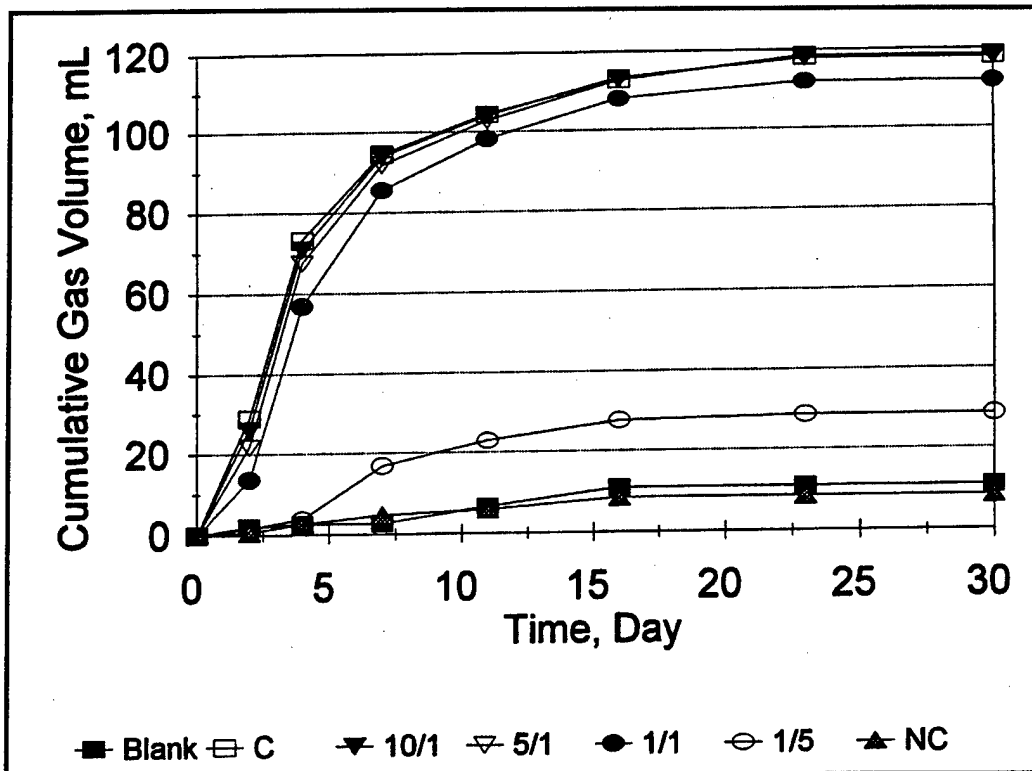

Figure 9. Effect of various cellulose/nitrocellulose ratios in batch study (cellulose concentration = 2,000 mg/L).

In the lactose/NC study, the concentration of lactose was fixed at 1,000 mg/L and the amounts of NC were changed by the pre-determined inducer/ NC ratios. Eight sets of tests were performed. The L/NC ratios were 10/0, 10/1, 5/1, 2/1, 1/1, 1/2, 1/5, and 1/10 (Figure 7). Figure 7 shows that, the lower the lactose/NC ratio, the less biogas would accumulate. After 35 days of operation, only the two with ratios of 1/5 and 1/10 had less than 40 mL of biogas accumulation. The biogas produced for other ratios ranged from 40 to 45 mL. The bottle containing lactose alone still produced more gas than all other bottles in the first 20 days. However those with L/NC ratios of 10/1, 5/1, and 2/1 produced approximately the same amount of gas as the control groups after 35 days. Table 6 shows that the amount of gas produced were in the range of 31 to 42 mL, when the L/NC ratio changed from 10/1 to 1/10 and lactose concentration remained constant.

Table 6 shows the results of a comparison of gas production and ratios of conversion. The conversion ratios dropped from about 60 to 7 percent as L/NC ratios changed from 10/0 to 1/10. However, micro-organisms were still alive and used lactose as a substrate.

Table 6. Comparison of net gas production and SGP (effect of various L/NC ratios) (unit: mL).

Description	Measured Gas Volume	SGP	Ratio, %
Lactose	42.6	72.0	59.2
L/NC = 10/1	41.7	76.0	54.9
L/NC = 5/1	42.0	78.0	52.5
L/NC = 2/1	42.4	92.0	44.2
L/NC = 1/1	37.4	112.0	32.4
L/NC = 1/2	38.1	152.0	24.4
L/NC = 1/5	31.5	272.0	11.4
L/NC = 1/10	31.5	472.0	6.3

The cellobiose/NC study used six sets of CB/NC ratios: 20/1, 10/1, 5/1, 1/1, 1/5, and 1/10. The concentration of cellobiose was fixed at 2,000 mg/L and the amounts of NC were varied by following the designated inducer/ NC ratios. Two sets of blank and control groups were maintained for comparison, and another set of bottles containing NC alone was also used in this study. Figure 8 shows that the biogas production remained the same (about 100 mL) when the CB/NC ratios were higher than 1/1. However, a CB/NC ratio of 5/1 produced only 1 mL more biogas than the control group, but that is within the error range. The bottles containing only NC produced less biogas than did the blank sample, which indicates no NC consumption.

Table 7 shows net gas production (amount of gas measured from test or blank samples) and SGP. CB/NC ratios of 20/1 and 10/1 have the highest conversion ratio, about 55 percent. The CB/NC ratio of 1/10 had almost no conversion. At a CB/NC ratio of 1/5, the concentration of volatile organic acids was only about 50 mg/L as acetic acid, as compared to 500 mg/L in the C/NC study. It seems that micro-organisms were inhibited from using cellobiose as a substrate at a high NC concentration in microbial hydrolysis. Figure 5 shows that micro-organisms can more easily use lactose as a substrate than cellobiose and cellulose because of lactose's simple structure. By acclimation, micro-organisms can use complicated compounds such as cellobiose and cellulose, as the data in Table 7 show. This table shows that, at an inducer/NC ratio of 10/1, more gas was produced in cellobiose/NC (79.7 mL) than lactose/NC (41.7mL).

Table 7. Comparison of net gas production and SGP (effect of various CB/NC ratios) (unit: mL).

Description	Measured Gas Volume	SGP	Ratio, %
Cellobiose	81.6	136.0	60.0
CB/NC = 20/1	77.7	140.0	55.5
CB/NC = 10/1	79.7	144.0	55.3
CB/NC = 5/1	82.6	176.0	46.9
CB/NC = 1/1	81.7	216.0	37.8
CB/NC = 1/5	15.4	531.0	2.9
CB/NC = 1/10	0.5	926.0	0.05
NC	—	80.0	—

The cellulose/NC study used four sets of C/NC ratios; 10/1, 5/1, 1/1, and 1/5. The concentration of cellulose was kept at 2,000 mg/L and the amount of NC were changed at pre-determined C/NC ratios. Two sets of blank and control groups were used to collect the basic information, and another set of bottles containing NC was also used in this study. Figure 9 shows results similar to those of the cellobiose study. Those with ratios of 10/1, 5/1, and 1/1 had more gas production, but none more than the control group. The only difference was that when the C/NC ratios were lower than 1/1, more biogas was produced in cellobiose study, approximately 2 mL in the case of inducer/NC = 1/5. C/NC ratios higher than 1/1 produced the same amount of gas, approximately 110 mL.

Table 8 shows the net gas production and SGP. The ratios are more than 70 percent with C/NC ratios higher than 1/1. But none produces more gas than the control bottle. However, higher concentrations of volatile organic acids, 300 to 550 mg/L as acetic acid, were found in the bottles with C/NC ratio of 1/5. Even for the bottles containing only NC, the concentration of volatile organic acids was found to be about 300 mg/L as acetic acid. This shows that some microbial enzymatic hydrolysis did occur during this test. But volatile organic acids could not be used by methane-forming bacteria, and were converted to biogas.

In the inducer/NC tests, a light green-yellow color appeared in the solution containing NC, especially in the bottles with low inducer/NC ratios (1/5 and 1/10). Denitration and enzymatic hydrolysis of NC might have occurred in these bottles. The residual sludge of these bottles was dried and extracted by tetrahydrofuran over night. The weight difference of sludge between before and after extraction was used to study the NC removal efficiency. Table 9 lists the results.

Table 8. Comparison of net gas production and SGP (effect of various C/NC ratios) (unit: mL).

Description	Measured Gas Volume	SGP	Ratio, %
Cellulose	107.5	136.0	79.0
C/NC =10/1	107.1	140.0	74.4
C/NC = 5/1	107.7	156.0	70.9
C/NC = 1/1	101.1	216.0	46.8
C/NC = 1/5	17.7	536.0	3.5
NC	—	80.0	—

Table 9. Nitrocellulose removal efficiency in inducer/NC study (by solvent extraction method) (unit: mg).

Description	Reduced Weight	Original Weight	Removal Efficiency
L/NC=1/5	339.5	1000	66 %
CB/NC=1/5	212.6	1000	79 %
C/NC=1/5	391.5	1000	61 %
NC	116.6	200	42 %
C/NC=1/1-10D	30.1	200	85 %
C/NC=1/1-15D	23.9	200	88 %
NC-10D	163.7	200	18 %
NC-15D	130	200	35 %

The data in this table show that the bottles containing NC only had about 40 percent NC removal, and bottles with an inducer/NC ratio 1/5 had higher than 60 percent removal. This indicates that NC could be converted to other intermediate compounds. But the numbers of these removal efficiency in Table 9 may be overestimated due to the incomplete separation of NC and anaerobic sludge by using the extraction of organic solvent that was mentioned in Chapter 4, "Anaerobic Treatment Process" (p 33).

Two-Stage Batch Study

Anaerobic treatment of waste can be put into three steps: hydrolysis, acidogenesis, and methanogenesis. Micro-organisms use extracellular enzyme to break

down large molecules in hydrolysis, to convert complex organic compounds into organic acids in acidogenesis, and to produce methane from acids in methanogenesis. Usually, acidogenesis and methanogenesis take place in one single reactor, and the growth conditions must be kept in good balance for both micro-organisms (acid formers and methane formers) to survive.

Some researchers have suggested that a two-phase anaerobic processes, one for the acid formation and the other for the methane formation, can enhance the degradation of organic substances. It is especially true when the hydrolysis or the organic matter is an overall rate-limiting process. Since the biodegradation of NC was not successful in the previous studies and the biodegradation was limited by hydrolysis step, a set of experiment by using two-stage anaerobic system was conducted for further study.

To simulate the two-stage anaerobic system, the defined media was controlled at a pH of 6.0 to maintain the optimal growth condition for acidogenesis. Then, after 2 or 4 days, the system was brought back to neutral condition by adding sodium hydroxide to optimize methanogenesis. Two- and 4-day periods of acidogenesis were used in this study, as mentioned above. Two blanks, a culture blank (B-C) and media blank (B-M), were used to provide the information about the biogas not produced from target compounds. For each testing acidogenesis period, three sets of tests were conducted. One was provided with 2,000 mg/L cellulose only (C-2D and C-4D), one had a cellulose/NC ratio of one to one. (Both of these first two had a concentration of 2,000 mg/L [1/1-2D and 1/1-4D]). The last one had a concentration of only 2,000 mg/L NC (NC-2D and NC-4D).

Under normal conditions, gas should be produced in the methanogenesis stage. However, it was observed in this study that some gas had already been produced in the fourth day. The study also found that much more gas was produced in 4-day acidogenesis than in 2-day acidogenesis (Figure 10). There was little difference in biogas accumulation for 2-day or 4-day acidogenesis from the media containing cellulose alone, or cellulose and NC. However, the production of gas in bottles containing both cellulose and NC did not increase. Compared with the earlier cellulose/NC study, gases produced for each condition from two-stage study were much less than single phase study. This could be due to the low pH in the first stage. Low pH will inhibit the growth of methanogenesis bacteria and also affect gas production.

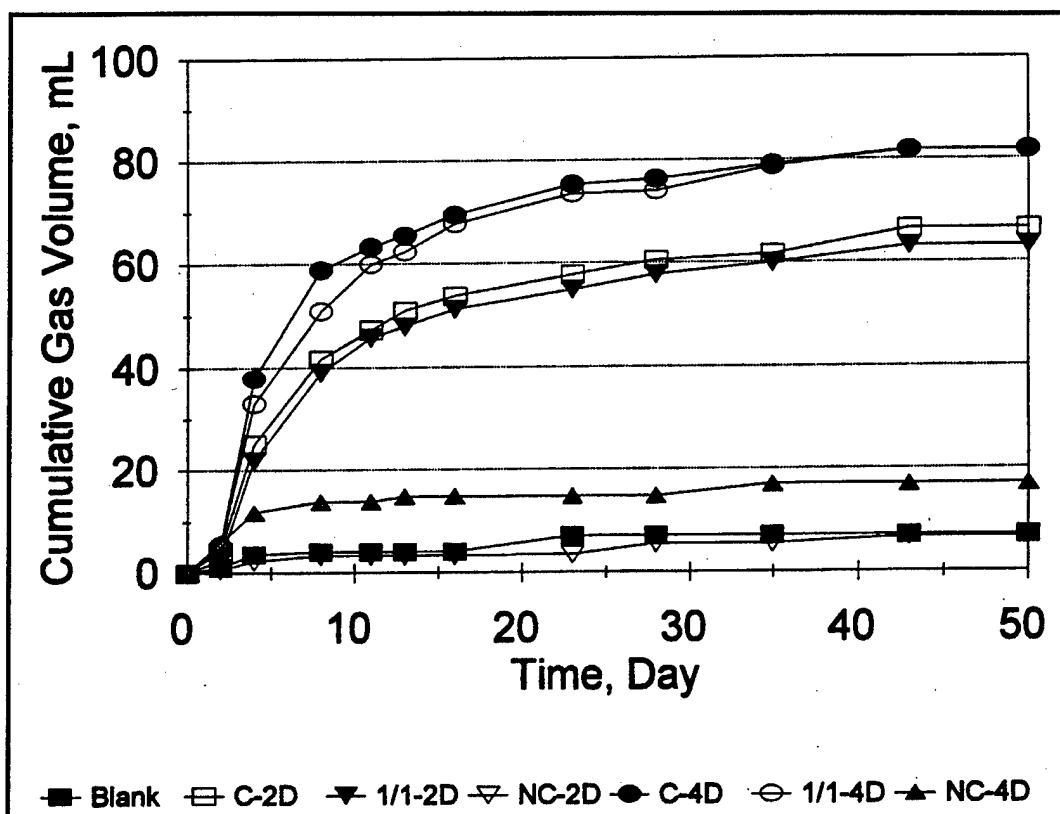

Figure 10. Results of two-stage anaerobic treatment system (2 and 4 days of acidogenesis period at pH = 6.0).

Table 10 lists data for a comparison of net gas production and SGP. Use of the two-stage anaerobic system did not improve the process; in fact, gas production fell somewhat. However, the conversion of NC only in 4-day acidogenesis period was enhanced from 6 to 12.5 percent. To obtain more information on the two-stage anaerobic system, another run was conducted under more acidic conditions and longer acidogenesis.

This test was conducted by controlling the mixed liquor at a pH of 5.0 to favor the growth of acidogenesis bacteria. This study used periods of 5, 10, and 15 days of acidogenesis. The concentrations of cellulose and NC were 1,000 mg/L. Figure 11 shows the results of this study.

Table 10. Comparison of net gas production and SGP (results of two-stage anaerobic system at pH = 6.0) (unit: mL).

Description	Measured Gas Volume	SGP	Ratio, %
Cellulose-2D	59.4	136.0	43.9
C/NC-2D	56.0	216.0	25.9
NC-2D	—	80.0	—
Cellulose-4D	74.6	136.0	54.9
C/NC-4D	74.7	216.0	34.6
NC-4D	10.0	80.0	12.5

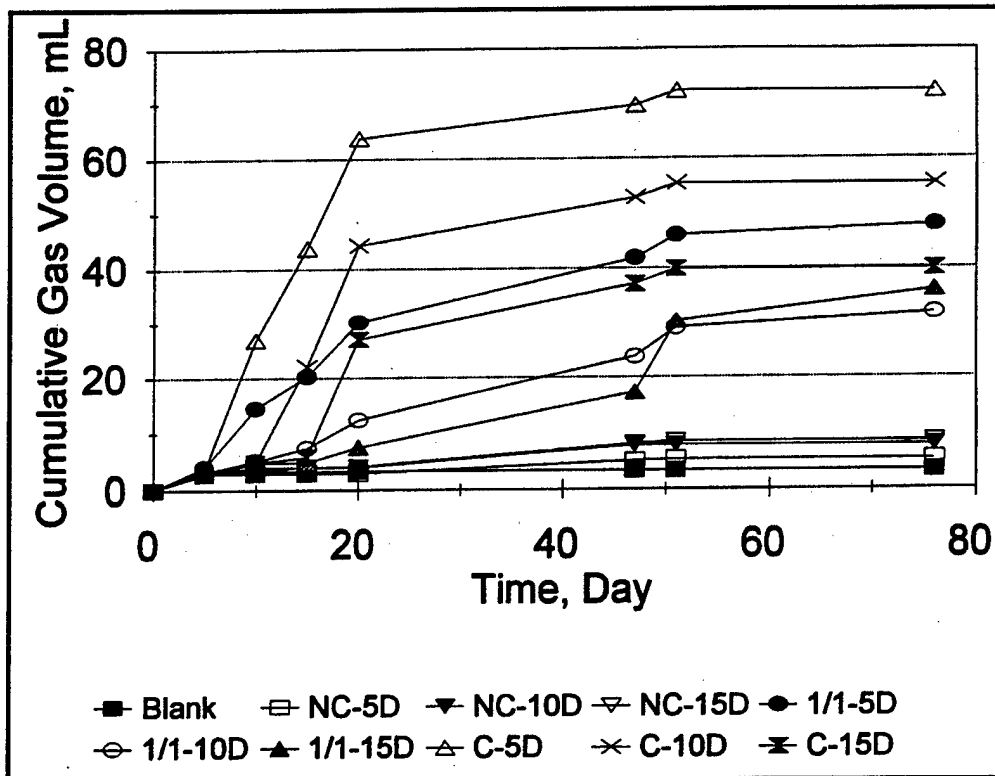

Figure 11. Results of two-stage anaerobic treatment system.

A comparison of Figures 10 and 11 shows that this experiment produced less biogas than did the previous experiment. This indicates that the methane-forming bacteria may be inhibited under acidic condition for long exposure time. However, the test also shows a higher concentration of volatile organic acids (about 550 mg/L as acetic acid) in the solution. Table 11 shows the conversion ratio between net gas production and SGP to be much smaller than in the previous experiment. This indicates that acidogenesis can be enhanced at lower pH, however, methanogenesis is affected by the low pH. A proper controlled pH and growth environment would be required.

Table 11. Comparison of net gas production and SGP (results of two-stage anaerobic system at pH = 5.0) (unit: mL).

Description	Measured Gas Volume	SGP	Ratio, %
C-5D	65.5	136.0	48.2
C/NC-5D	41.2	216.0	19.1
NC-5D	2.0	80.0	2.5
C-10D	48.8	136.0	35.9
C/NC-10D	25.3	216.0	11.7
NC-10D	1.2	80.0	1.5
C-15D	33.3	136.0	24.5
C/NC-15D	29.5	216.0	13.7
NC-15D	1.8	80.0	2.3

An interesting phenomenon was observed. Three months after the above experiment was conducted, more gas was produced in the serum bottles (about 70 to 90 mL), of which the two-stage anaerobic degradation tests was performed. Then, the micro-organisms were transferred to other BMP bottles for further experiment. One bottle contained 2,000 mg/L of cellulose and another 2,000 mg/L of NC. In two other bottles, the concentration of cellulose was fixed at 2,000 mg/L and concentrations of NC were varied by changing the C/NC ratio (Figure 12). Some differences can be seen by comparing Figures 9 and 12. More gas was produced in NC in this experiment (25 mL vs. 8 mL). Inhibitions of biodegradation of cellulose caused by the addition of NC were still observed at both cellulose/NC ratios of 1/1 and 1/5. Although this test shows some biogas generation when NC was used as the sole carbon source, the amount, however, is only 1/4 that of the cellulose. Some small molecular weight organic acids were detected and a large amount of ethanol was present in the solutions by HPLC analysis. Nitrate and trace amounts of nitrite were also detected by Ion Chromatograph in solutions (Table 12). Table 12 also shows the results of difference between SGP calculation values and net gas productions from this study. This table shows that the conversion of NC to gas was about 34.4 percent of the SGP value without any co-substrate. This is better than a single stage system. However, after transferring the residual sludge to another set of reactors, no more gas production was observed. This test shows that, under certain conditions, micro-organisms may be able to use NC as a carbon source.

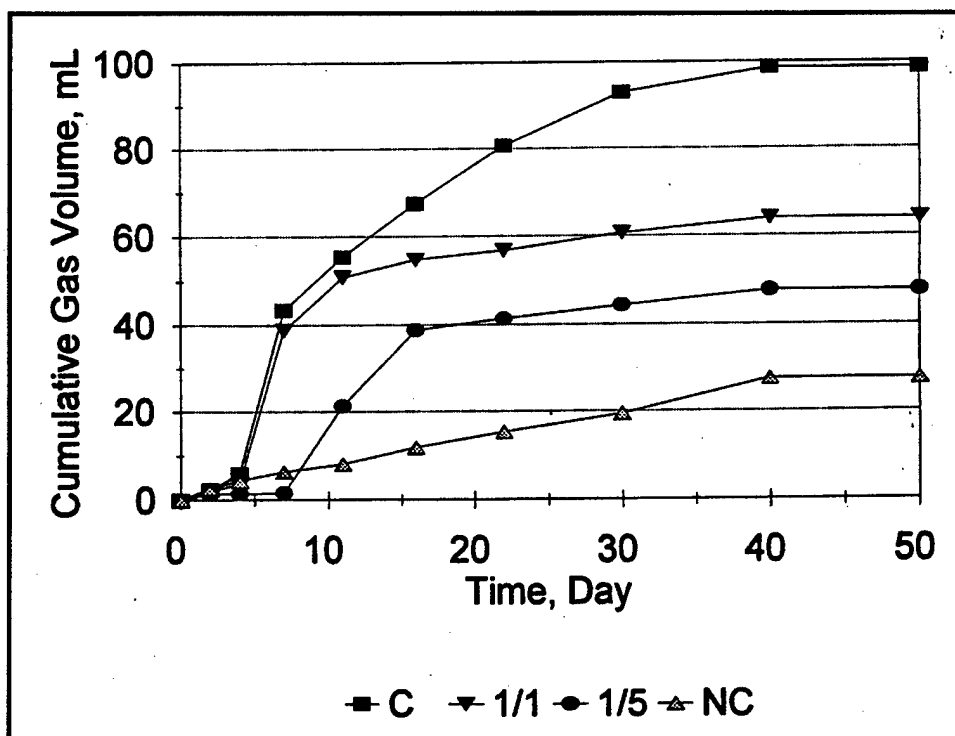

Figure 12. Results of biodegradation test with nitrocellulose and cellulose by sludge from two-stage anaerobic treatment system.

Table 12. Comparison of net gas production and SGP (biodegradation of nitrocellulose and cellulose) (unit: mL).

Description	Measured Gas Volume	SGP	Ratio	Ethanol, mg/L	Nitrate, mg/L
Cellulose	98.7	136.0	72.6	—	—
C/NC = 1/1	64.0	216.0	29.6	68.5	24.7
C/NC = 1/5	47.7	536.0	14.2	61.2	64.3
Nitrocellulose	27.5	80.0	34.4	54.2	98.2

Effect of pH on Biodegradation

The effect of pH on the biosystem was investigated in this part of the study. Five different initial pH values, 6.0, 6.5, 7.0, 7.5, and 8.0, respectively, were used during this part of the study.

Two different cellulose/NC ratios (1/1 and 5/1 by weight) and two control units (NC and cellulose only) were also used in this study. Biogas production, extractable NC concentration, nitrate, and nitrite produced were monitored to evaluate the performance of biodegradation. Figures 13 to 17 and Tables 13 to 17 give the results.

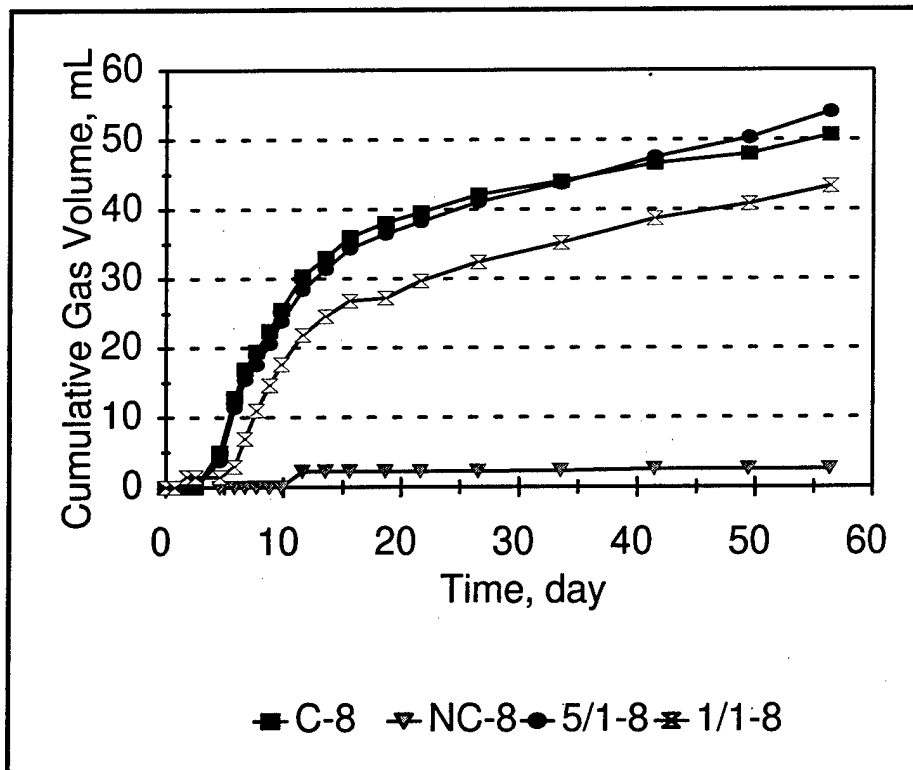

Figure 13. Gas production during biodegradation at pH = 8.0.

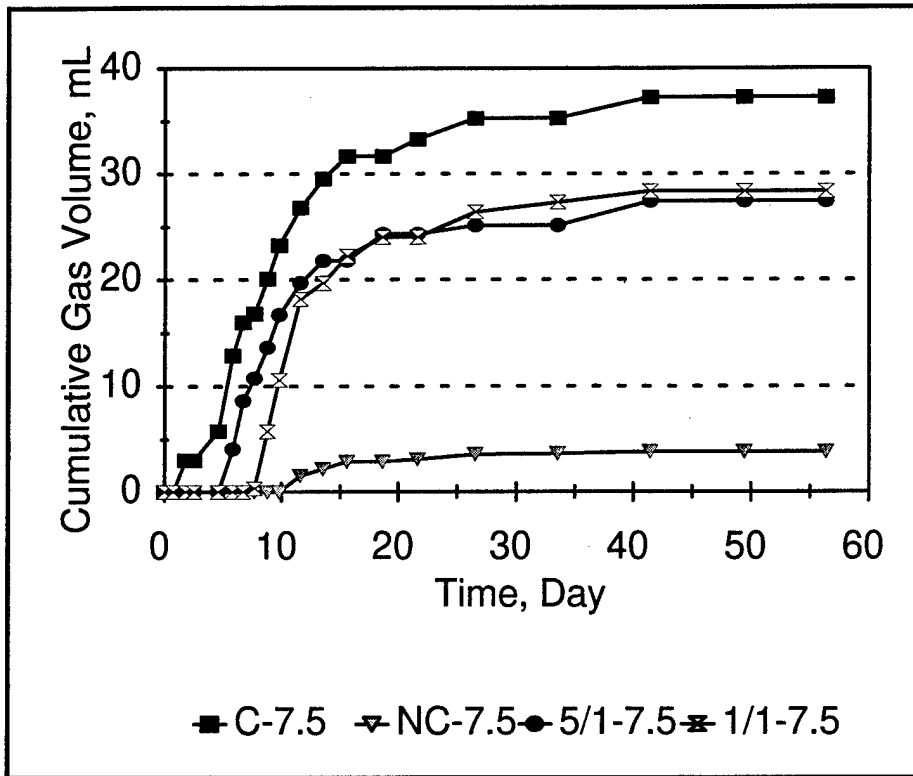

Figure 14. Gas production during biodegradation at pH = 7.5.

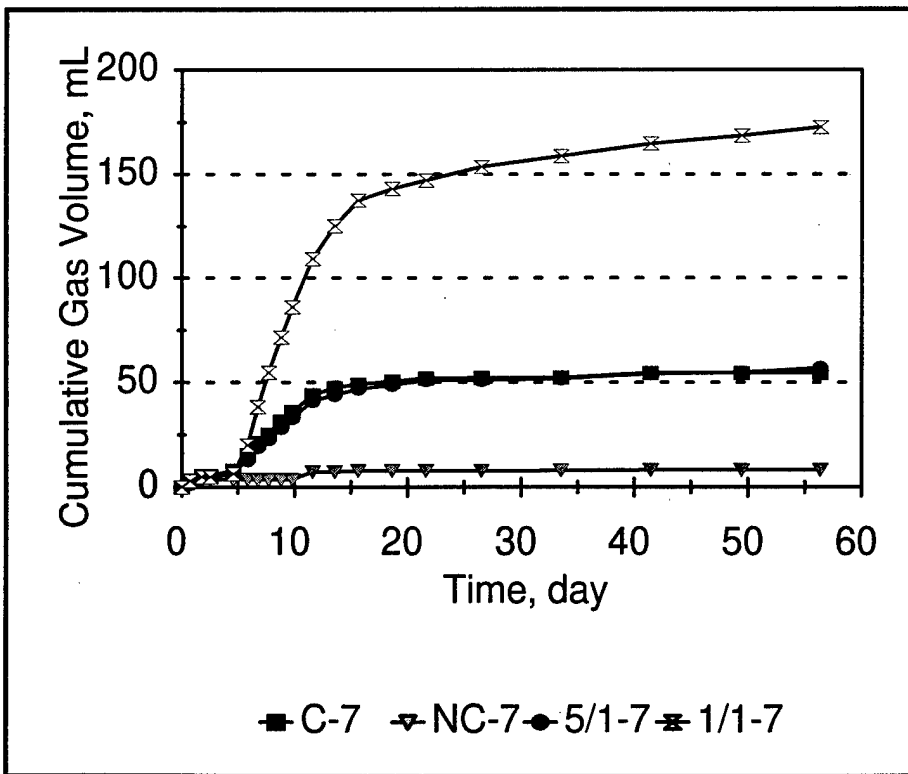

Figure 15. Gas production during biodegradation at pH = 7.0.

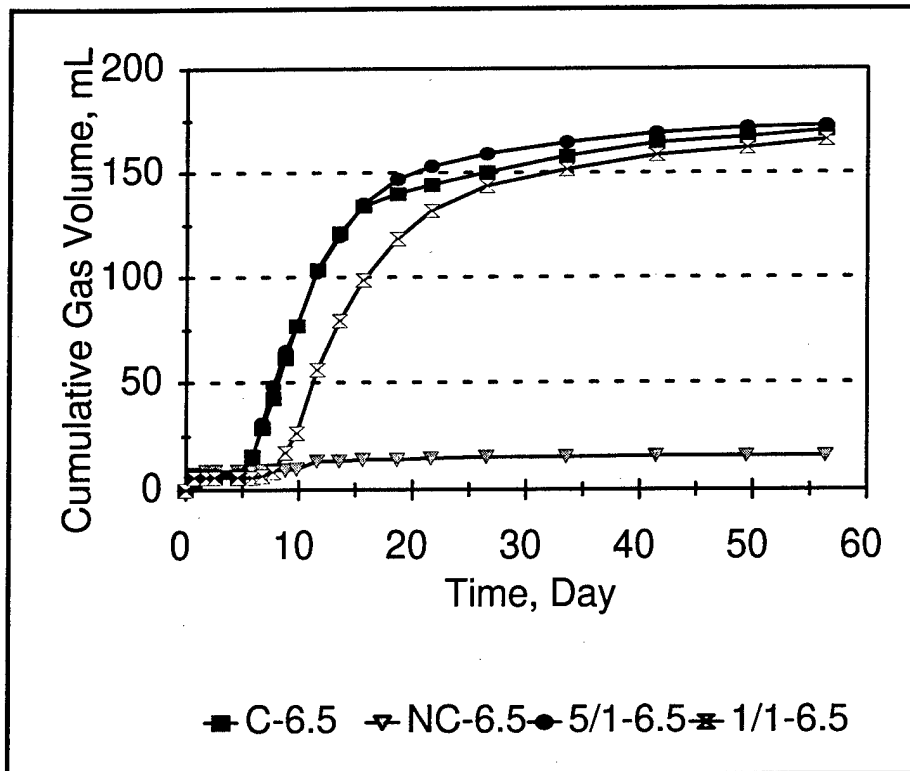

Figure 16. Gas production during biodegradation at pH = 6.5.

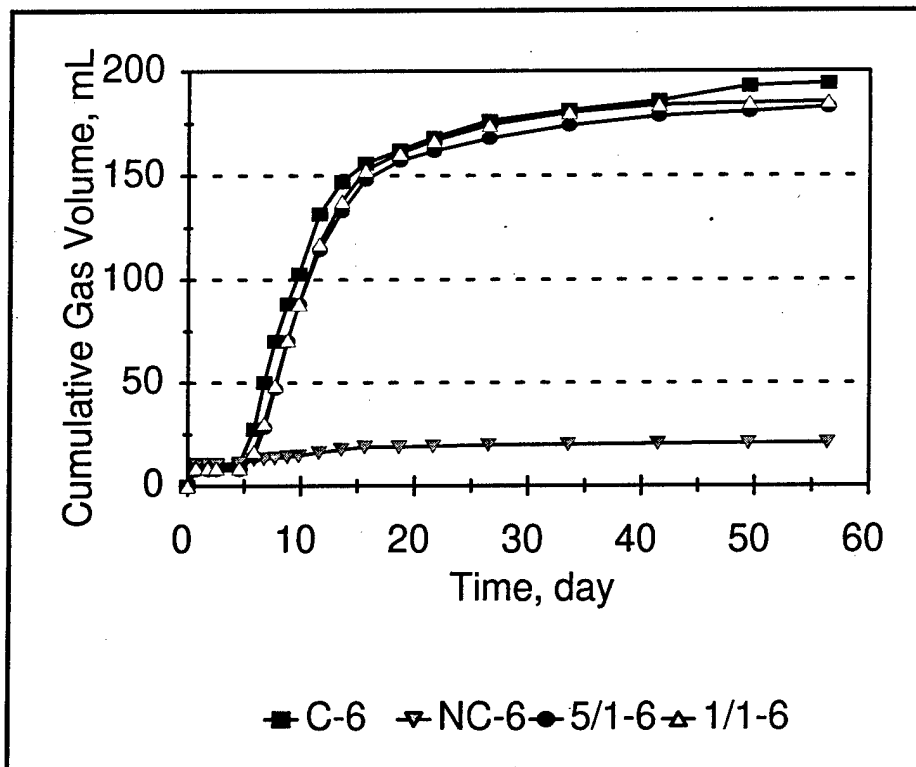

Figure 17. Gas production during biodegradation at pH = 6.0.

Table 13. Results of biodegradation at pH = 8.0 (effect of various pH on biodegradation).

Description	Gas Volume, mL	NC Removal, %	Nitrate, mg/L
C only	50.7	—	—
NC only	2.6	46.49	69.41
C/NC=5/1	54.1	32.63	NA
C/NC=1/1	43.4	42.23	73.86

Table 14. Results of biodegradation at pH = 7.5 (effect of various pH on biodegradation).

Description	Gas Volume, mL	NC Removal, %	Nitrate, mg/L
C only	37.3	—	—
NC only	3.9	41.46	110.49
C/NC=5/1	27.4	37.97	NA
C/NC=1/1	28.4	48.91	28.06

Table 15. Results of biodegradation at pH = 6.0 (effect of various pH on biodegradation).

Description	Gas Volume, mL	NC Removal, %	Nitrate, mg/L
C only	54.6	—	—
NC only	8.4	35.54	34.66
C/NC=5/1	57.1	14.96	NA
C/NC=1/1	172.6	24.19	12.25

Table 16. Results of biodegradation at pH = 6.0 (effect of various pH on biodegradation).

Description	Gas Volume, mL	NC Removal, %	Nitrate, mg/L
C only	170.5	—	—
NC only	15.8	29.22	32.72
C/NC=5/1	172.7	5.00	NA
C/NC=1/1	166.0	25.13	93.00

Table 17. Results of biodegradation at pH = 6.0 (effect of various pH on biodegradation).

Description	Gas Volume, mL	NC Removal, %	Nitrate, mg/L
C only	194.3	—	—
NC only	20.8	23.22	38.58
C/NC = 5/1	182.8	-12.26	NA
C/NC = 1/1	185.4	17.29	NA

According to the gas production data, it seems that more biogas was produced at a pH equal to or lower than 7.0. For example, the bottles with pH higher than 7.0 produced only 1/3 or less biogas than these with pH lower than 7.0. However, by considering the gas produced in the control units, the calculated NC removal points the other way; there was more conversion at higher pH values. For ex-

ample, the highest NC removal (48.91 percent) was observed at pH = 7.5 and C/NC = 1/1. No definite conclusion can be drawn from the data collected in this experiment as to how pH may affect the biodegradation. Based on the mass balance of nitrogen and the amount of nitrate and nitrite measured by ion chromatograph shown in Tables 13 to 17, the amount of nitrogen recovered was much less than the theoretical calculated value based on nitrogen content of 13.5 percent in the NC. This indicates that some nitrate groups in NC either escaped as nitrogen gas or remained attached/bound to the intermediate compounds.

Sequencing Batch Study

A 4-L flask was used as the bioreactor with a gas collection device. Two sets of identical biosystems were compared. One reactor was first fed with 10 g of cellulose only and the second reactor was introduced with 10 g of cellulose and 2 g of NC. After gas production from both reactors ceased, the mixing was stopped. After the sludge settled, the supernatant was withdrawn from the reactor. Additional substrates were added to the systems and another cycle of treatment was started. Figure 18 shows the results of gas production in sequencing the batch reactor study.

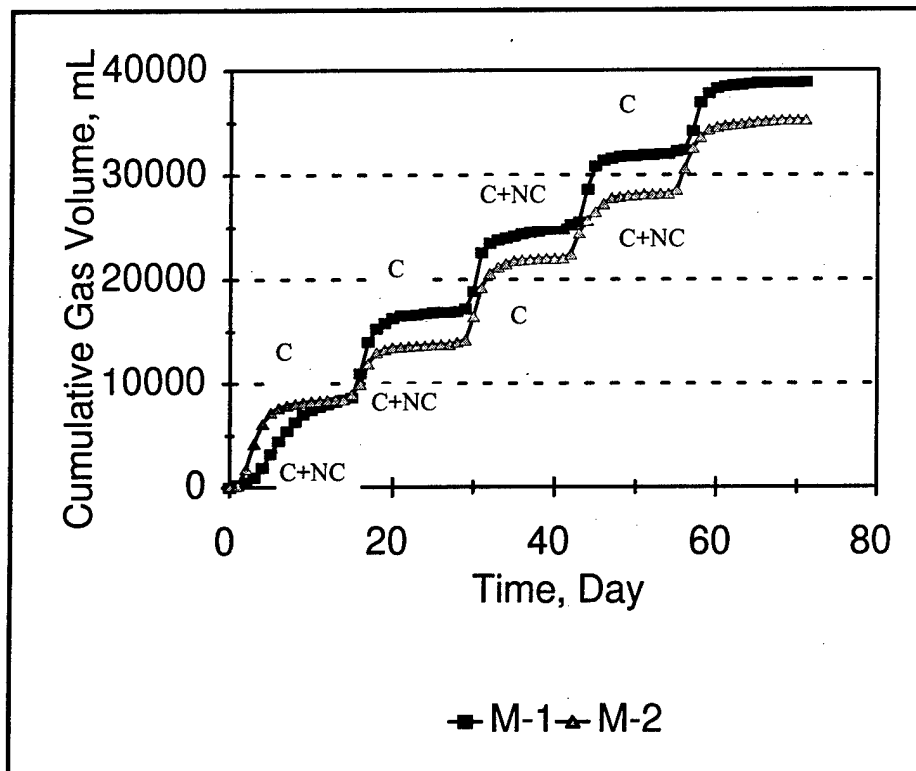

Figure 18. Results of sequencing batch study.

In the first cycle of sequencing batch studies, M-1 was fed with 10 g of cellulose and 2 g of NC and M-2 was fed with 10 g of cellulose. In the first cycle, the gas production rate (slope of the curve) of M-1 was lower than that of M-2. This means that the addition of NC did affect the gas production. In the second cycle, M-1 was fed with 10 g of cellulose alone and M-2 was fed with 10 g of cellulose and 2 g of NC. In the second cycle, M-2 showed gas production inhibition, but not for M-1. If NC was not hydrolyzed in first cycle, it should have settled and been retained in the M-1 reactor. The cellulose/NC ratio in the second cycle was the same as in the first cycle for the M-1 reactor so it should have exhibited the same inhibition as in the first cycle. But Figure 18 shows that the inhibition did not occur. This indicates that the NC could have been converted to a different compound, however, the methane-forming bacteria was not able to further decompose and use this compound.

Stage-Feed Anaerobic Study

Two single-stage, stage-feed anaerobic reactors (S-1 and S-2) and two identical, two-stage, stage-feed reactors (T-1 and T-2) were used in this part of the tests. Another reactor (H-1) using horse manure to substitute micro-organisms was also studied. The system's hydraulic retention time was controlled at 20 days. Sludge retention time was sustained at about 70 days and pH was controlled at neutral condition by adding sodium bicarbonate as a buffer. The cellulose feeding rate was kept at 6 g/L/day and NC feeding rate was maintained at 0.6 g/L/day. Figures 19 to 21 show the results from the stage-feed system.

Figure 19 shows that the stage feeding made no difference. It is not yet clear how T-2 and T-1 show such big difference. Figure 20 shows the daily gas production in the two-stage stage-feed system. This figure shows that the rate of biodegradation was not at a steady state condition, especially in the T-1 system. The microbial activities fluctuated. Most of the time, the micro-organisms remained inactive. However, after a period of time (10 to 15 days), there is a peak coming out. The consumption of a large amount of substrate and production of tremendous amount of gas occurred in a very short period of time. The concentration of volatile acid in T-1 was high (greater than 3,000 mg/L). Nitrate and nitrite were also found in the effluent. This shows that micro-organisms were still alive and that NC was converted to simpler compounds and biogas.

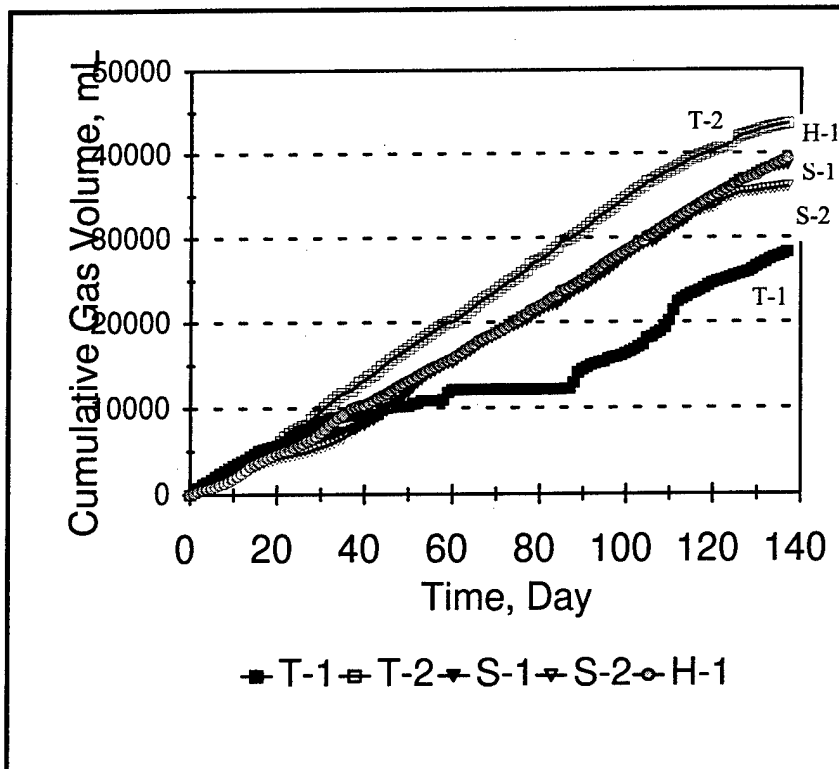

Figure 19. Gas production in staged-feed reactors.

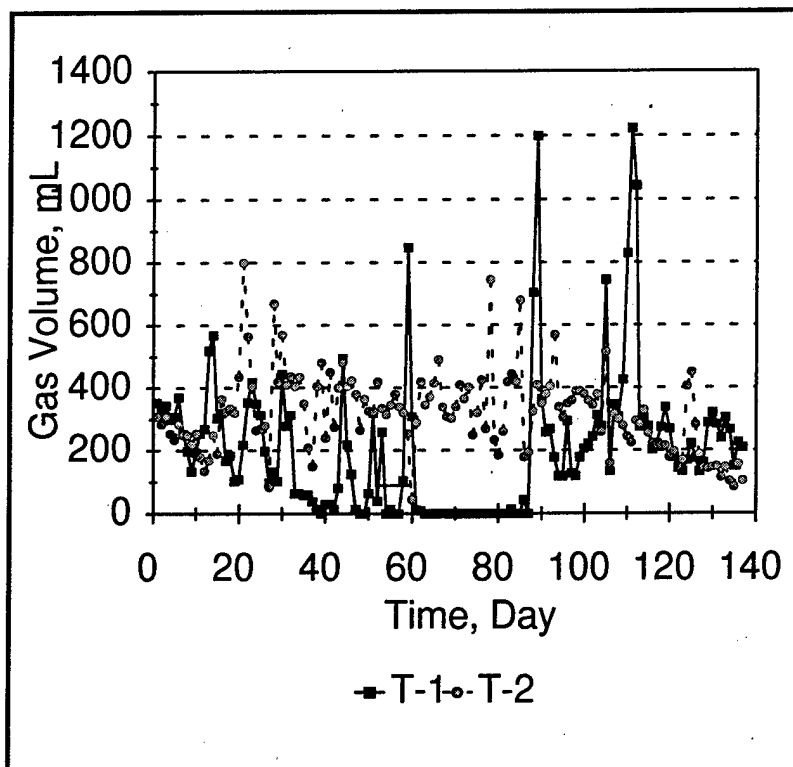

Figure 20. Gas production in two-stage staged-feed system.

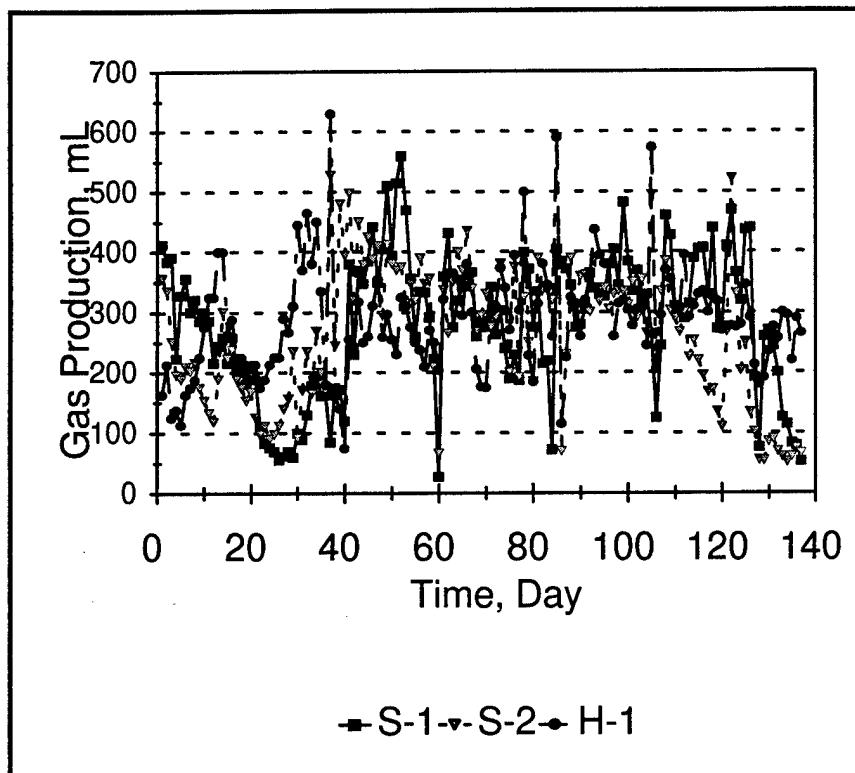

Figure 21. Gas production in single-stage staged-feed system.

Figure 21 shows the performance of the single-stage stage-feed system. This figure shows that the gas production for all three reactors was approximately the same. This figure also reflects the use of horse manure to degrade NC. This reactor did not perform better than the reactors with anaerobic digester micro-organisms. The volatile acids produced were in the range of 80 to 200 mg/L, and nitrate and nitrite were also found in the effluent. The system is more stable than the two-stage system, however, the NC conversion was lower based on the gas production. After the completion of experiments, the mixed liquor in the reactors that should contain micro-organisms and NC was removed from the reactor. It was found that none of the NC particles remained as solid particles in the sludge. It is not yet clear what causes the complete solubilization of NC.

Inhibition Study

In the inhibition study, NC was fixed at 1,500 mg/L for each serum bottle, and the concentrations of substrate (cellulose) varied from 500 to 2,500 mg/L. The biogas produced from test serum bottles were used as the rate of reaction. Figures 22 and 23 show the results of this study. Table 18 lists the concentrations of substrate [S] and rates of reaction [V] of anaerobic system with or without the addition of NC.

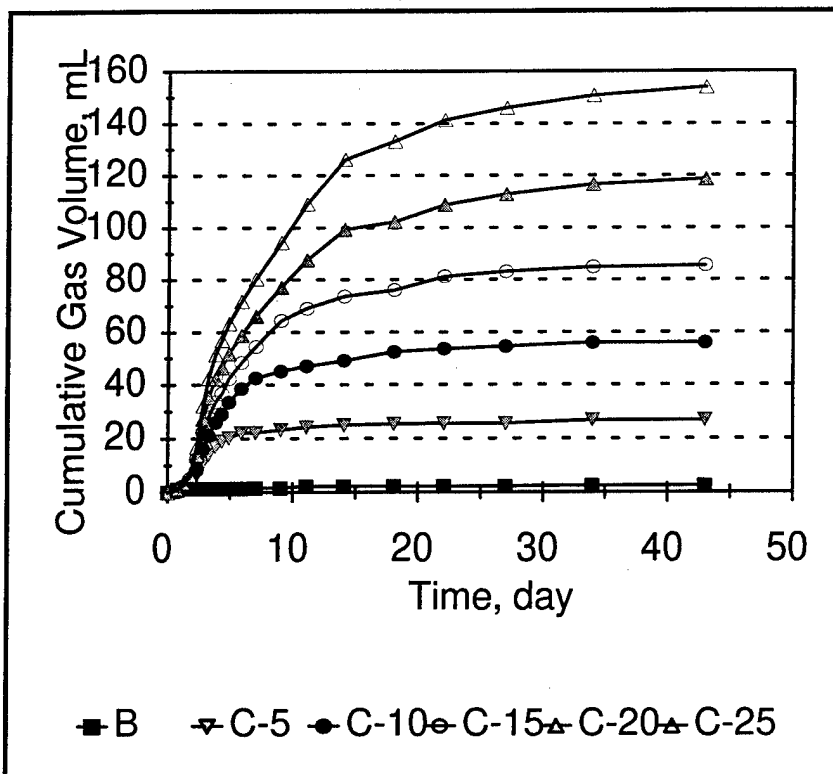

Figure 22. Gas production in inhibition study without NC.

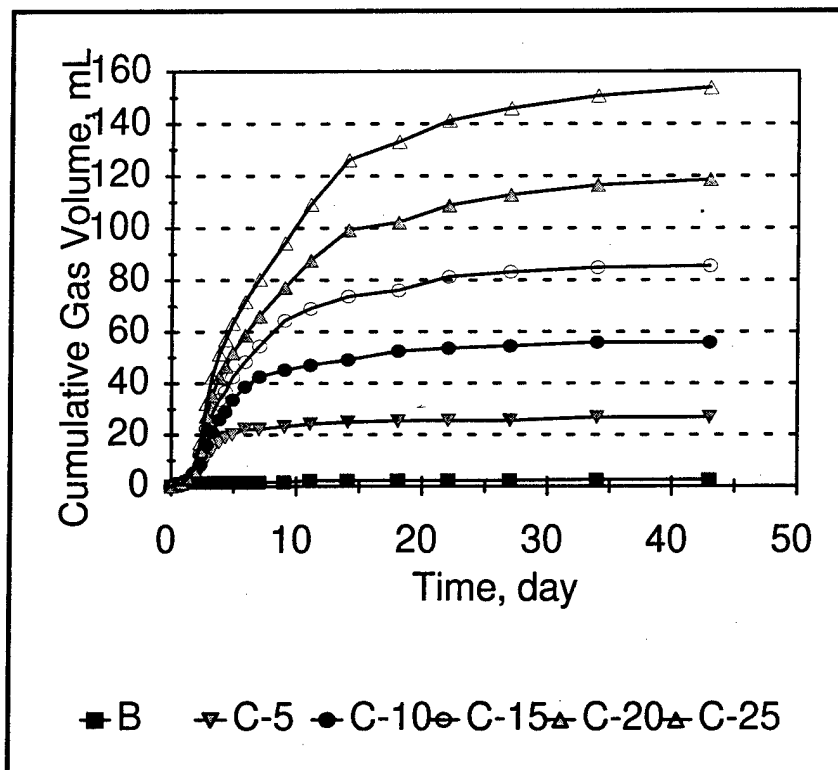

Figure 23. Gas production in inhibition study with NC.

Figure 24 shows the plot of $1/V$ versus $1/S$. The two straight lines almost intercept at $1/V$ axis, indicating that the inhibition caused by addition of NC behaves like competitive inhibition. For the competitive inhibition, the inhibitory effect can be overcome at higher substrate concentrations. In this study, at higher concentration of cellulose, NC did not affect the gas production. Table 19 lists the kinetic and inhibition constants derived from the modified Michaelis-Menten equation.

Table 18. Results of inhibition study of NC.

S, x 10 ⁻³ mole	V, day ⁻¹	V', day ⁻¹
2.78	1.3672	1.3216
5.56	2.8393	2.7454
8.33	4.2633	4.2098
11.11	5.7337	5.8310
13.89	7.5305	7.4565

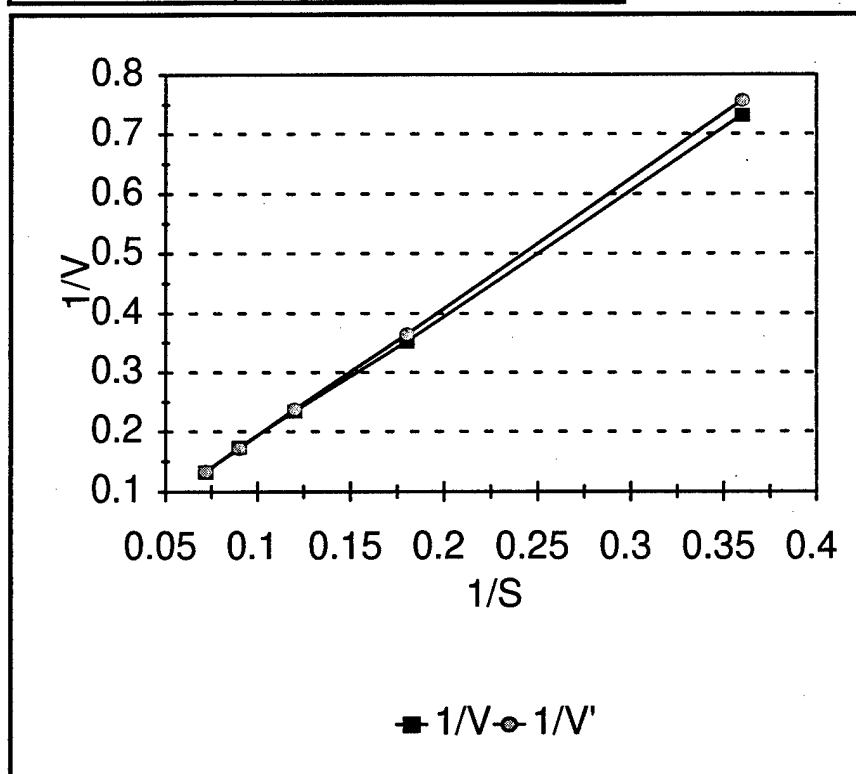

Figure 24. The Lineweaver-Burk Plot in inhibition study.

Table 19. Kinetic constants in inhibition study.

Constant	x 10 ⁻³
V_{max}	13.93 M/day
K_M	136.01 M
K_M'	94.84 M
K_i	17.32 M

At the end of this experiment, the samples in serum bottles were centrifuged and filtered through a 0.45 μm membrane filter to remove the suspended solids. The Soluble Chemical Oxygen Demand (SCOD) was used to determine the organics remaining in the filtrate since some NC will not be converted to gas during the biodegradation. Table 20 lists the results of SCOD. A comparison of the gas production in samples that contained cellulose only (C-5 to C-25) with those with NC added (CNC-5 to CNC-25), shows that approximately the same gas production was observed for each cellulose concentration. However, at higher cellulose concentration (CNC-25, 2500 mg/L), the test bottles with cellulose and NC had higher SCOD. This indicates that more soluble organic material was released in the test bottles with cellulose and NC. This may be caused by the dissociation of NC in the biological system. However, the soluble organics were not further converted to methane and carbon dioxide.

Effects of pH and Cellulose Particle Size on NC Biodegradation

Cellulose with three different particle sizes, Sigma 20 (average 20 μm), Sigma 50 (average 50 μm), and Sigma 100, were used in this part of the study. Five different pH values, 4.5, 5.0, 6.0, 7.0, and 8.0, were used before seeding to study pH effect. Gas production and SCOD were employed as monitoring parameters for the biological system. Table 21 lists the data of SCOD and pH changes. Results of this study show that the optimal final pH for gas production ranged from 6.4 to 6.3. Type 20 and 50 celluloses with NC produced higher SCOD than those with cellulose only. This indicates that NC may be co-degraded by anaerobes with these two types of cellulose.

Table 20. Results of soluble chemical oxygen demand (SCOD) in inhibition study.

Sample	pH	Gas, ml	SCOD, mg/L	Sample	pH	Gas, ml	SCOD, mg/L
Blank	7.67	2.5	65.3 \pm 8.5	NC	7.61	4.1	53.6 \pm 7.7
C-25	7.00	153.8	53.6 \pm 7.7	CNC-25	7.04	152.3	114.1 \pm 24.4
C-20	6.98	118.6	60.2 \pm 17.8	CNC-20	7.01	118.6	39.8 \pm 16.4
C-15	7.10	85.4	71.2 \pm 6.0	CNC-15	7.11	83.4	65.3 \pm 3.4
C-10	7.19	55.9	52.1 \pm 4.3	CNC-10	7.27	54.0	57.2 \pm 1.5
C-5	7.33	26.8	45.0 \pm 1.5	CNC-5	7.35	25.5	81.2 \pm 8.8

Table 21. Soluble chemical oxygen demand in effects of cellulose particle size study.

pH Changes	SCOD				
	8.0	7.0	6.0	5.0	4.5
Initial pH	8.0	7.0	6.0	5.0	4.5
			Blank		
Final pH	7.59	7.10	6.58	6.51	6.50
Gas, ml	5.2	6.4	7.0	7.1	7.3
SCOD, mg/L	136 ± 3	96 ± 19	107 ± 30	122 ± 2	126 ± 6
			C-100		
Final pH	6.88	6.83	6.40	6.35	6.31
Gas, ml	113.3	115.6	129.4	126.0	119.3
SCOD, mg/L	207 ± 6	321 ± 7	369 ± 2	432 ± 3	419 ± 2
			C-50		
Final pH	6.87	6.76	6.35	6.38	6.33
Gas, ml	119.9	119.7	133.5	132.5	130.8
SCOD, mg/L	179 ± 2	274 ± 3	282 ± 2	333 ± 13	289 ± 3
			C-20		
Final pH	6.85	6.67	6.33	6.29	6.26
Gas, ml	120.2	121.8	132.3	128.5	129
SCOD, mg/L	218 ± 18	276 ± 2	352 ± 4	322 ± 2	280 ± 13
			CNC-100		
Final pH	6.88	6.77	6.35	6.31	5.84
Gas, ml	110.6	108.5	122.4	117.4	67.8
SCOD, mg/L	234 ± 3	294 ± 2	379 ± 8	375 ± 3	1076 ± 42
			CNC-50		
Final pH	6.88	6.77	6.34	6.31	6.31
Gas, ml	116.3	118.0	129.7	120.2	129.0
SCOD, mg/L	231 ± 12	370 ± 11	389 ± 2	507 ± 2	354 ± 6
			CNC-20		
Final pH	6.97	6.83	6.35	6.24	6.21
Gas, ml	116.7	119.5	138.8	116.2	117.4
SCOD, mg/L	225 ± 6	264 ± 2	307 ± 6	538 ± 3	542 ± 16
			NC		
Final pH	7.59	7.11	6.57	6.47	6.49
Gas, ml	5.8	7.3	6.7	6.7	7.3
SCOD, mg/L	103 ± 21	114 ± 3	128 ± 9	121 ± 7	128 ± 3

Effectiveness of Biodegradation

From all the studies conducted, it is obvious that the measurement of gas production is not a good indicator for NC degradation. For high inducer/NC ratio, high gas production or high conversion ratios can be observed (Tables 6 to 9). However, once the ratio drops, it is difficult to tell if NC changes.

Low gas production does not mean that the substrate has not changed. It only means the final gas product was not formed. This is especially true for NC. It has been observed repeatedly in the batch study, stage-feed study, and sequential batch study that intermediate compounds such as organic acids and nitrates were detected. Unfortunately, some other intermediate compounds could not be identified.

Another interesting observation was found after the data collection stage. During the data analysis, two reactors were kept in the temperature control chamber with no additional substrate addition. After 4 months, gas production was not increased. The reactors were emptied and it was found that all the NC and most of the bacteria had disappeared. This is a further evidence that NC can be degraded biologically. Although this study could not pinpoint or quantify denitrification of NC, it provided a some indirect evidence that NC can be denitrated and completely destroyed in a biological system.

5 Hydrochloric Acid Hydrolysis Of Nitrocellulose

A preliminary study of the hydrolysis of NC using diluted acid was conducted and it was found that NC could be converted to glucose at high temperature and high pressure. Another experiment performed with concentrated hydrochloric acid at 70 °C for a period of 30 to 45 minutes showed that approximately 75 percent glucose conversion could be obtained in a single stage process, and about 78 percent of conversion was achieved in a two-stage process. Since the single stage hydrolysis was almost as good as the two-stage system, the single-stage hydrolysis process was selected for further study. Experiments focused on using concentrated hydrochloric acid at intermediate temperatures (50 to 90 °C) and ambient pressure to hydrolyze 0.4 g of NC. Various amounts of concentrated hydrochloric acid (with a concentration of about 38 percent) were added to the media tubes with predetermined acid/solid ratios. These tubes were put into a water bath controlled at designated temperatures (50 to 90 °C). Tubes were then removed from the water bath at various intervals, quenched in ice water, and analyzed for glucose contents.

Effect of Reaction Temperatures

Five different temperatures, 50, 60, 70, 80, and 90 °C, were used to evaluate the temperature effect on NC hydrolysis. During the experiment, it was found that the hydrolysis reaction was so slow at 50 °C, that it was impractical to calculate the activated energy at this temperature. Therefore, this temperature was removed from analysis. Figure 25 shows a typical result of NC hydrolysis at four testing temperatures with an acid/solid (A/S) ratio of 6 mL/ 0.4 g. Figure 25 shows that hydrolysis reaction does follow the Arrhenius equation, which indicates that, the higher the temperature, the faster the reaction. This figure also shows that, at 90 °C, it took about 9 minutes to convert NC to the maximally produced glucose. But at 60 °C, approximately 63 minutes were needed to reach the maximum glucose level for the same A/S ratio. Figure 25 also shows that, although different time of periods were required to reach the maximum production at different reaction temperatures, the maximum glucose production from NC hydrolysis was almost the same as long as the A/S ratio remained the same — in this case, 0.9 mmole glucose.

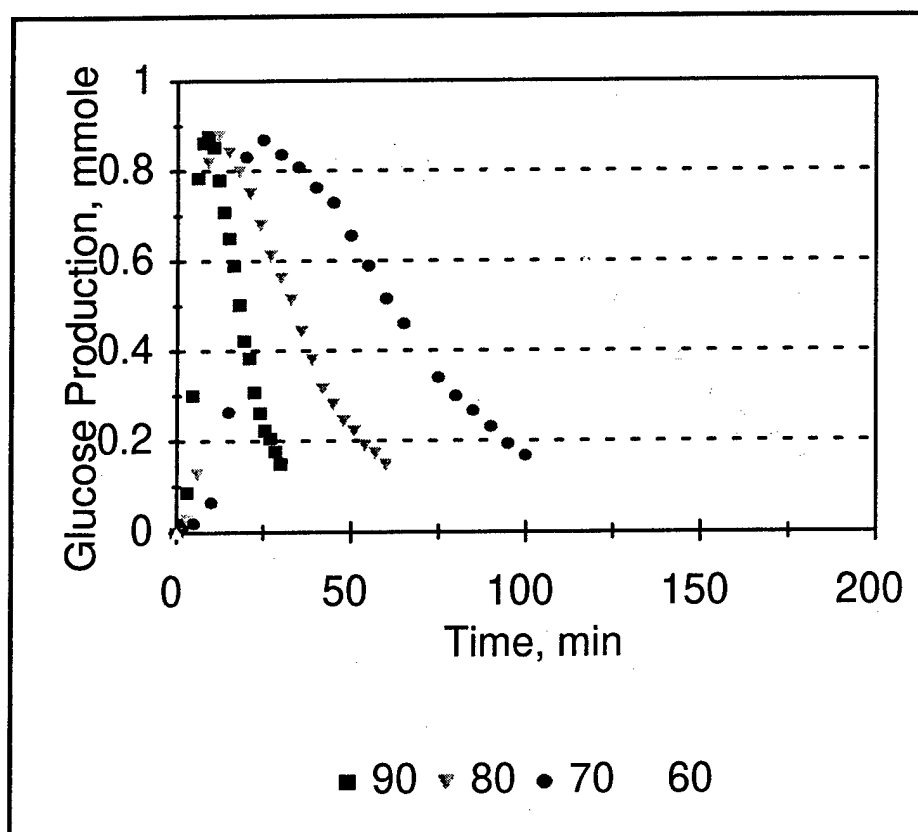

Figure 25. Results of acid hydrolysis (A/S = 6 mL/0.4 g) at various temperatures.

This experiment indicates that the maximum amount of glucose that can be produced from acid hydrolysis of NC is controlled more by the A/S ratio rather than temperature. The temperature only affects the rate of hydrolysis reaction.

Four different temperatures, 90, 80, 70, and 60 °C, and six acid/solid ratios, 2 mL/0.4 g, 4 mL/0.4 g, 6 mL/0.4 g, 8 mL/0.4 g, 10 mL/0.4 g, and 12 mL/0.4 g were used in the kinetics study. Tables 22 and 23 list the rate constants for acid hydrolysis of NC at different temperatures and A/S ratios. Based on the Arrhenius Equation (Eq. 3), a linear relationship exists between the natural logarithm of rate constants and the reciprocal of reaction temperature in °K. Therefore, the plots of $\ln K$ versus $1/T$ were used to calculate the activated energy and Arrhenium frequency factor (Figures 26 and 27). Both figures show that each line in the plot of $\ln K$ versus $1/T$ has similar slope, which means the amount of activated energy required for each part of the reaction is also similar. Therefore, an average value of the slopes of these lines (six different A/S ratios) is calculated and this average value is used to represent the activation energy of acid hydrolysis. Base on this result, the activation energies required to hydrolyze NC to glucose and then to decompose glucose to small molecular weight organic acids are 15,233 Kcal/mole and 12,568 Kcal/mole, respectively.

Table 22. Properties of ion-exchange membranes (Urano et al., 1984).

Temp, °C	K-2*	K-4*	K-6*	K-8*	K-10*	K-12*
90	0.08409	0.08765	0.09261	0.09466	0.09613	0.09716
80	0.04035	0.04184	0.04304	0.04471	0.04577	0.04679
70	0.02647	0.02798	0.02874	0.02953	0.03018	0.03089
60	0.01617	0.01723	0.01885	0.01831	0.02089	0.01881

* Number represents the amount of acid(ml) in A/S ratio.

Table 23. Rate constants of nitrocellulose hydrolysis (K_i) at various temperatures.

Temp, °C	K-2*	K-4*	K-6*	K-8*	K-10*	K-12*
90	0.74439	0.79586	0.84082	0.88874	0.91456	0.93951
80	0.39593	0.42746	0.44677	0.47495	0.48554	0.49537
70	0.22962	0.24766	0.26509	0.27411	0.28367	0.28959
60	0.10874	0.11642	0.12287	0.12796	0.12951	0.13573

* Number represents the amount of acid(ml) in A/S ratio.

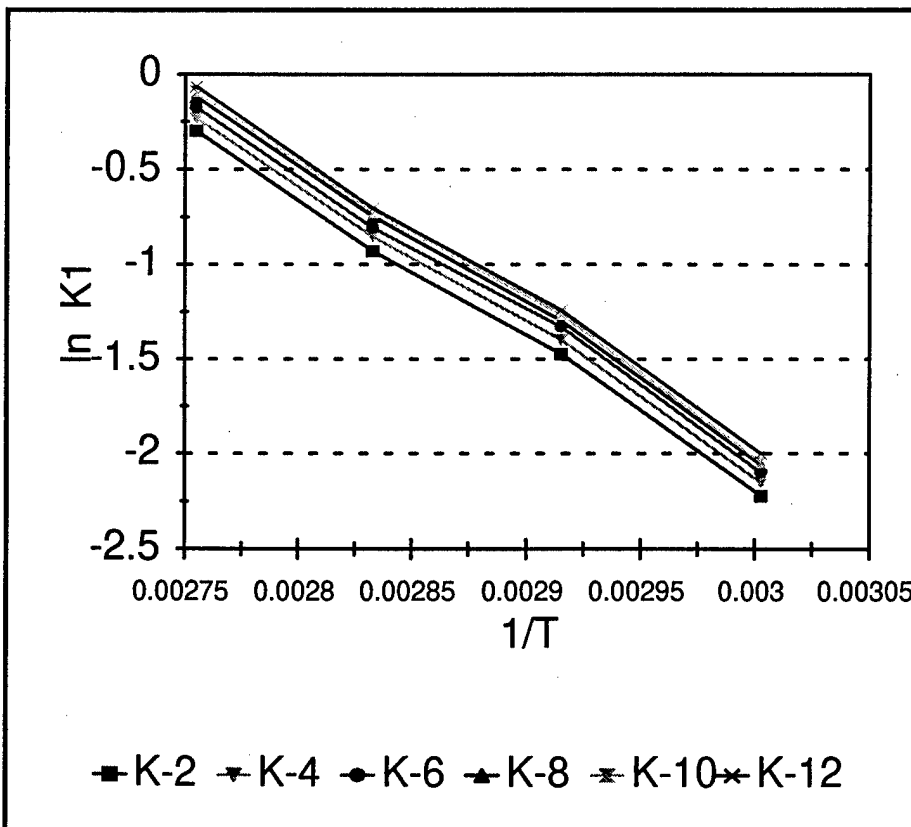

Figure 26. The activated energy of nitrocellulose hydrolysis at various A/S ratios.

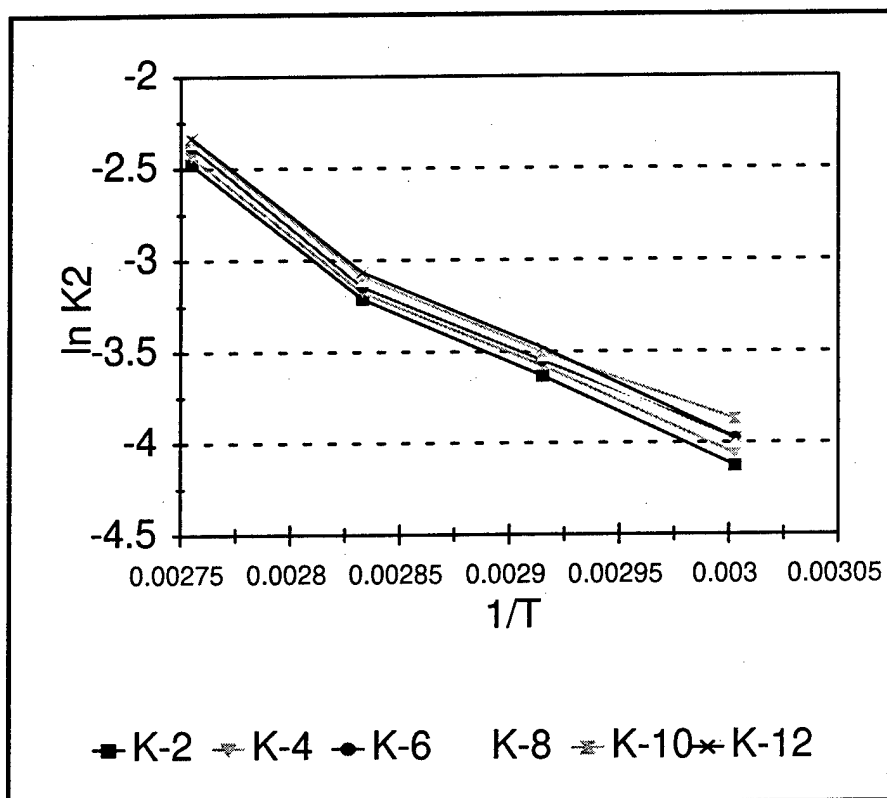

Figure 27. The activated energy of glucose degradation at various A/S ratios.

The Arrhenius frequency factor for these two reactions are 1.2650×10^9 and 2.8475×10^6 , respectively. The rate constants can be expressed by Arrhenium equation as follows:

$$K1 = 1.2650 \times 10^9 \exp(-15,233 / RT)$$

and

$$K2 = 2.8475 \times 10^6 \exp(-12,568 / RT)$$

where:

K1 = rate constant of hydrolysis of nitrocellulose, min⁻¹

K2 = rate constant of degradation of glucose, min⁻¹.

Another set of experiments was conducted at ambient temperature (about 20 °C) for a period of 5 days. From this study, it was found that hydrolysis did occur at room temperature and atmospheric pressure with concentrated hydrochloric acid. But the hydrolysis reaction was much slower than at intermediate temperatures. It took about 5 days to completely dissolve the NC and convert it to glucose. However, much less glucose was formed than was obtained at intermediate temperatures. It was thought that the rate of NC hydrolysis and glucose degradation should be of the same order of magnitude at ambient temperatures,

unlike that observed at higher temperatures, where the rate of NC hydrolysis was much faster than glucose degradation. During this experiment, all the glucose produced from NC hydrolysis was degraded into small molecular weight organic acids at almost the same rate.

Another study using diluted hydrochloric acid at room temperature was also conducted but the reaction rate for acid hydrolysis was too slow to be observed within a reasonable reaction time. This study shows that, of the two most important factors affecting acid hydrolysis, acid concentration and temperature, acid concentration has more influence.

Effect of Acid/Solid Ratio on Acid Hydrolysis

This part of the study investigated the effect of acid/solid ratios on acid hydrolysis. Six different hydrochloric acid (mL) / NC (g) ratios, 2/0.4, 4/0.4, 6/0.4, 8/0.4, 10/0.4, and 12/0.4, were studied. The experiments were used to evaluate the performance of hydrolysis and glucose degradation.

Saeman (1945) has shown that cellulose hydrolysis and glucose degradation can be modeled as first-order reactions. Figure 28 shows that the plot of the natural logarithm of glucose concentration versus reaction time curve was very similar to what Saeman observed in his work. NC hydrolysis can, therefore, be modeled as a first-order reaction. All results showed a similar pattern for the hydrolysis study. The glucose production first increased, reached a maximum value, then slowly decreased. As previously indicated, the maximum concentration of glucose produced depends on reaction temperature and A/S ratio. For the curve obtained in the first stage (Figure 28), where the glucose production increases, can be called the stage of NC hydrolysis. The second stage, where the glucose concentration decreases, can be called glucose degradation.

In Figures 29 and 30, rate constants versus A/S ratios were plotted at different scales to determine the relation between rate of NC hydrolysis and acid/solid Ratio. It was found that the natural logarithm of rate constants for NC hydrolysis and glucose degradation were linear with natural logarithm of acid/solid ratios. These two figures show that, even though each test was conducted at different temperatures, each plot had a similar slope. The average slope of NC hydrolysis is 0.1286 ± 0.0052 and the average slope of glucose degradation is 0.084 ± 0.0008 . The results indicate that, the more hydrochloric acid added to the reaction, the faster the NC would degrade and the less glucose would remain in solution. It also indicates that the acid/solid ratio will affect the reaction rate of NC hydrolysis more than the glucose degradation.

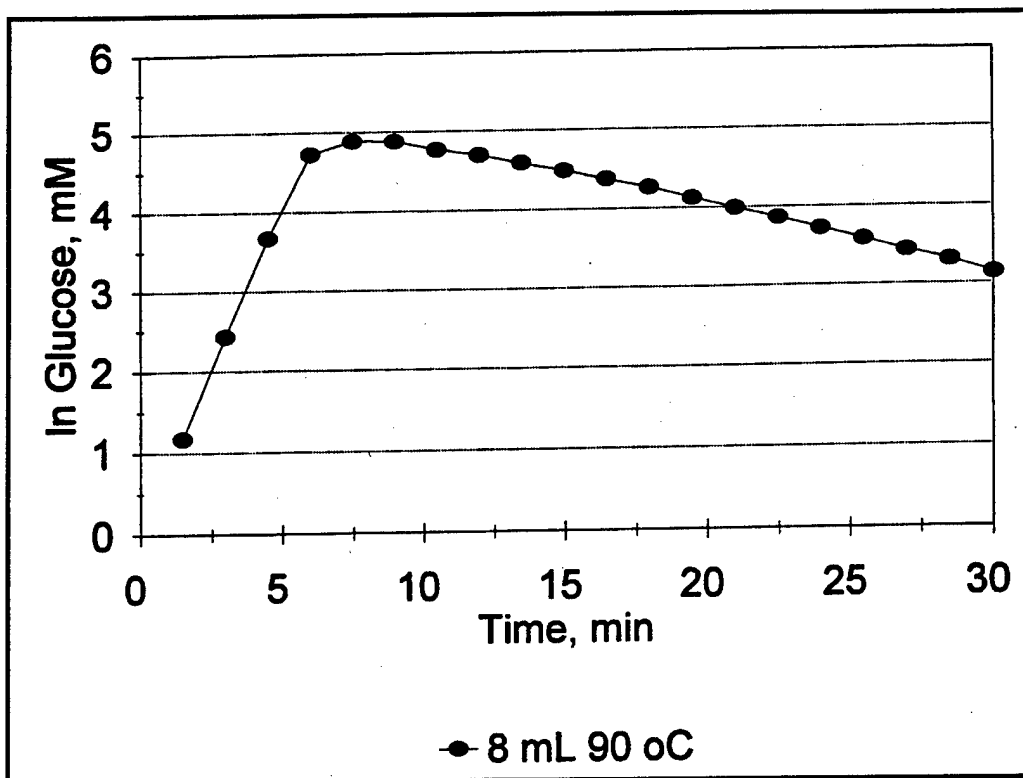

Figure 28. The plot of natural logarithm of glucose concentration versus reaction time (A/S ratio = 8 mL / 0.4 g, at 90 °C).

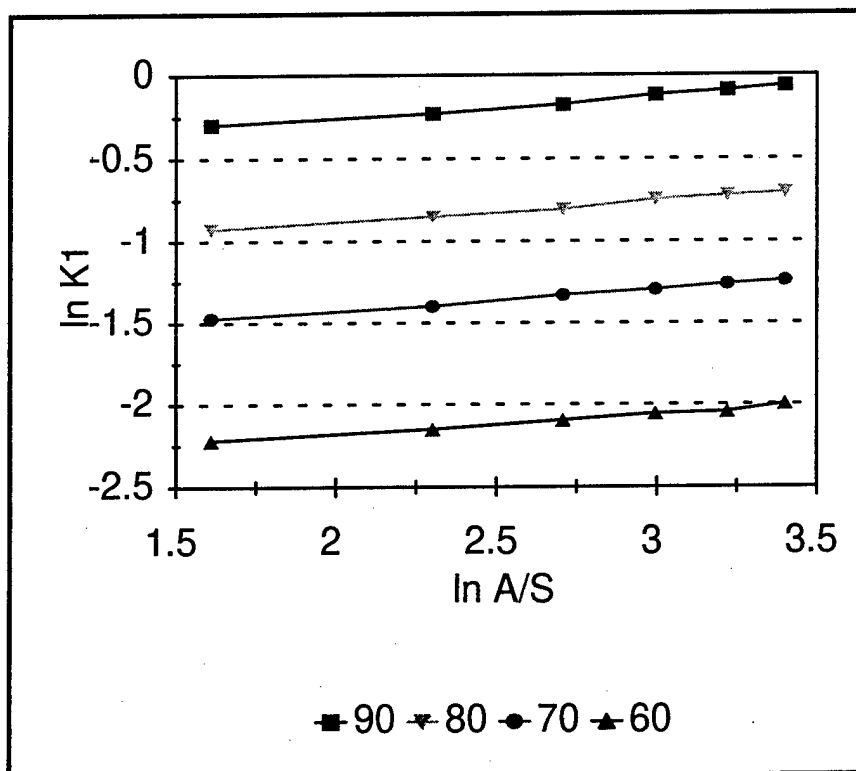

Figure 29. The relationship between ln K1 and ln A/S ratio at various temperatures.

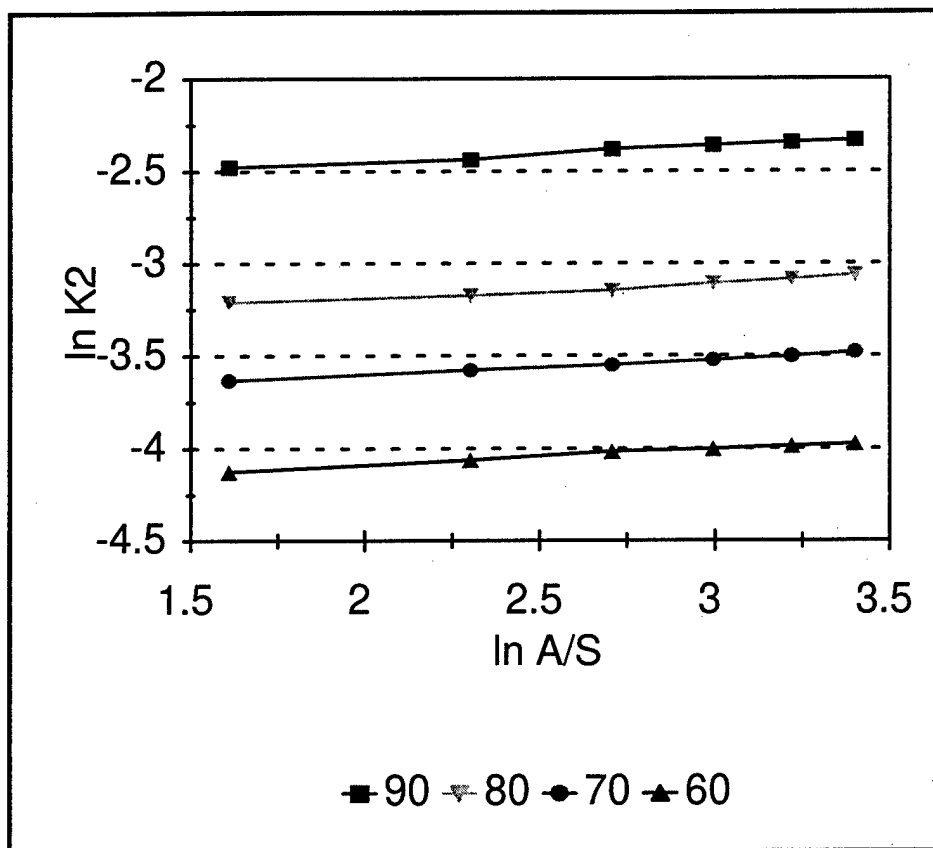

Figure 30. The relationship between $\ln K_2$ and $\ln A/S$ ratio at various temperatures.

Effect of Acid Concentration

Different hydrochloric acid concentrations (38, 30.4, 25.3, 21.7, and 19 percent) were reacted with 0.4 g NC at 80 and 90 °C. The experimental procedure was similar to the approach for the study of the effect of acid/solid ratio study. A natural logarithm plot of rate constant versus acid concentration (percent) was used to evaluate the effect of acid concentration on hydrolysis of NC and glucose degradation. Figures 31 and 32 show the results. A linear relationship exists between the natural logarithm of rate constant and acid concentration for both NC hydrolysis and glucose degradation. The slope of $\ln K_1$ versus $\ln A$ is 1.8183 ± 0.0103 and the slope of $\ln K_2$ versus $\ln A$ is 0.5436 ± 0.0093 . These tests show that the reactions are faster at higher acid concentrations. The results also indicate that acid concentration affects the reaction rate of hydrolysis process more than that of glucose degradation.

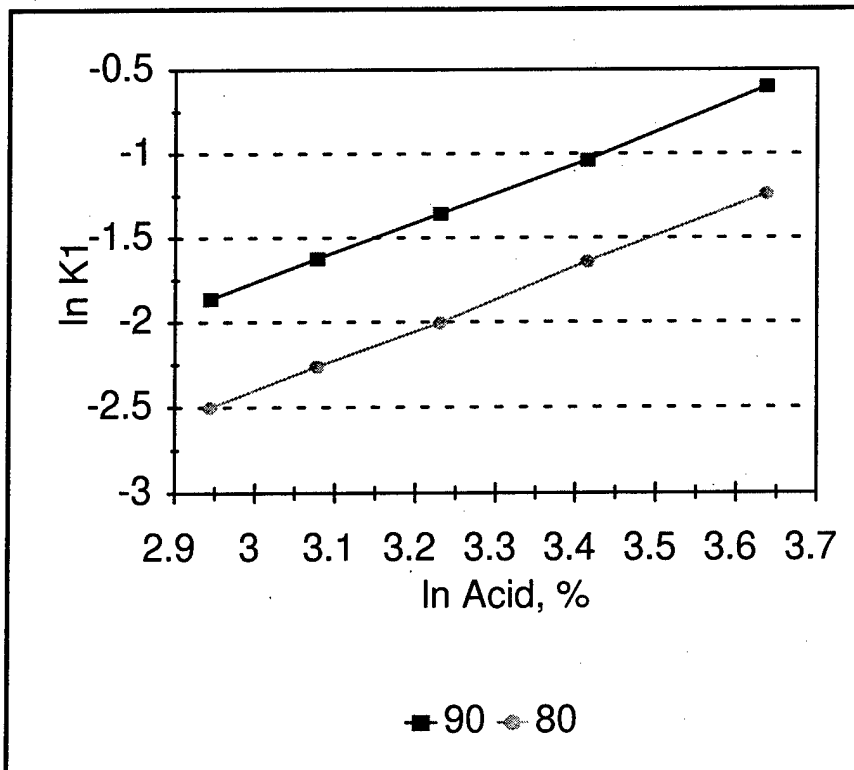

Figure 31. Effect of acid concentration on nitrocellulose hydrolysis.

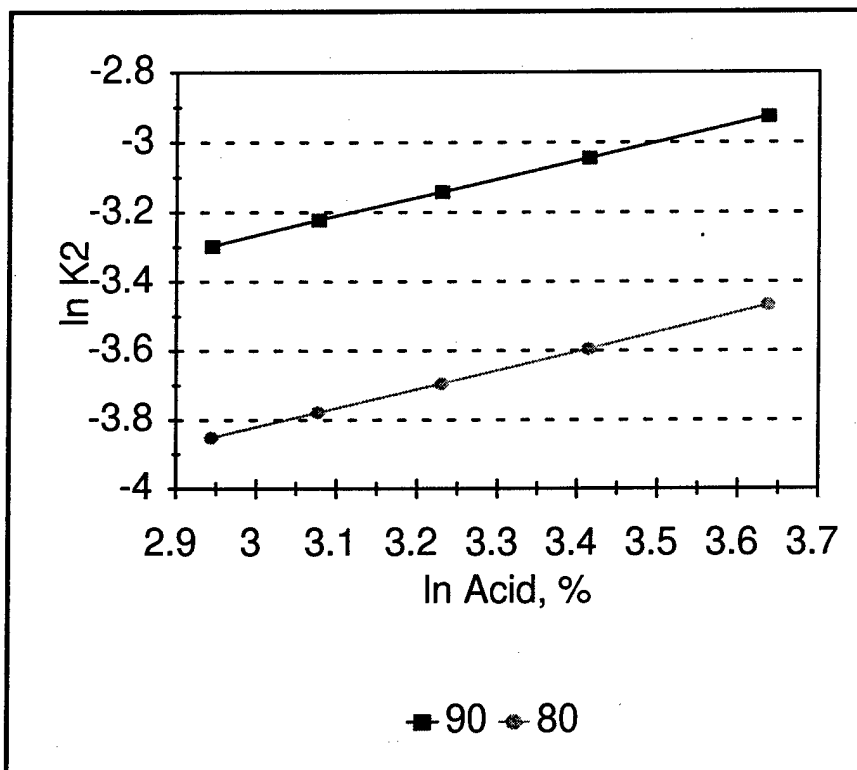

Figure 32. Effect of acid concentration on glucose degradation.

By combining all the parameters studied together, the reaction of NC hydrolysis and glucose degradation can be expressed as a function of acid concentration, acid/solid ratio, and temperature. The complete reaction of NC hydrolysis and glucose degradation can be expressed by the following kinetic models:

$$K_1 = 1.0841 \pm 0.0729 \times 10^6 (A)^{1.81831 \pm 0.0103} (A/S)^{0.1286 \pm 0.0052} \exp(-15,233 \pm 89/RT)$$

$$K_2 = 5.5082 \pm 0.2901 \times 10^5 (A)^{0.5436 \pm 0.0093} (A/S)^{0.0844 \pm 0.0008} \exp(-12,568 \pm 319/RT)$$

where:

- K_1 = rate constant of hydrolysis of NC, min^{-1}
- K_2 = rate constant of degradation of glucose, min^{-1}
- A = Acid Concentration, percent
- (A/S) = Acid/Solid Ratio, mL/g
- T = Absolute Temperature, °K, and
- R = Universal Gas Constant, 1,987 g-cal/(g-mole)(° K)

This equation shows that higher acid concentration, acid/solid ratio, and/or temperature will have faster reaction for both hydrolysis and degradation reaction. However, these two equations also indicate that these three parameters have stronger effect on the stage of NC hydrolysis than on the glucose degradation.

Glucose Conversion

Glucose is the dominant end product for acid hydrolysis of cellulosic materials. The glucose produced at various acid/solid ratios were determined. Glucose Yield, Y, is defined as:

$$Y = \text{Total Glucose Produced} / \text{Total Potential Glucose} \times 100 \text{ percent}$$

The total potential glucose is a theoretical value obtained by calculation based on a nitrogen content in NC of 13.5 percent.

The glucose yields during NC hydrolysis with different A/S ratios in 90 °C (Figure 33). Figure 33 shows that the glucose yielded from NC hydrolysis was affected by A/S ratios. The higher the A/S ratios, or the more acid is being used to hydrolyze NC, the more glucose will be produced. It was mentioned earlier that the reaction temperature does not affect the glucose yield significantly, but it does influence the rate of the reaction. The maximum glucose yields decreased from 85 percent for an A/S ratio of 12/0.4 to 38 percent for an A/S ratio of 2/0.4.

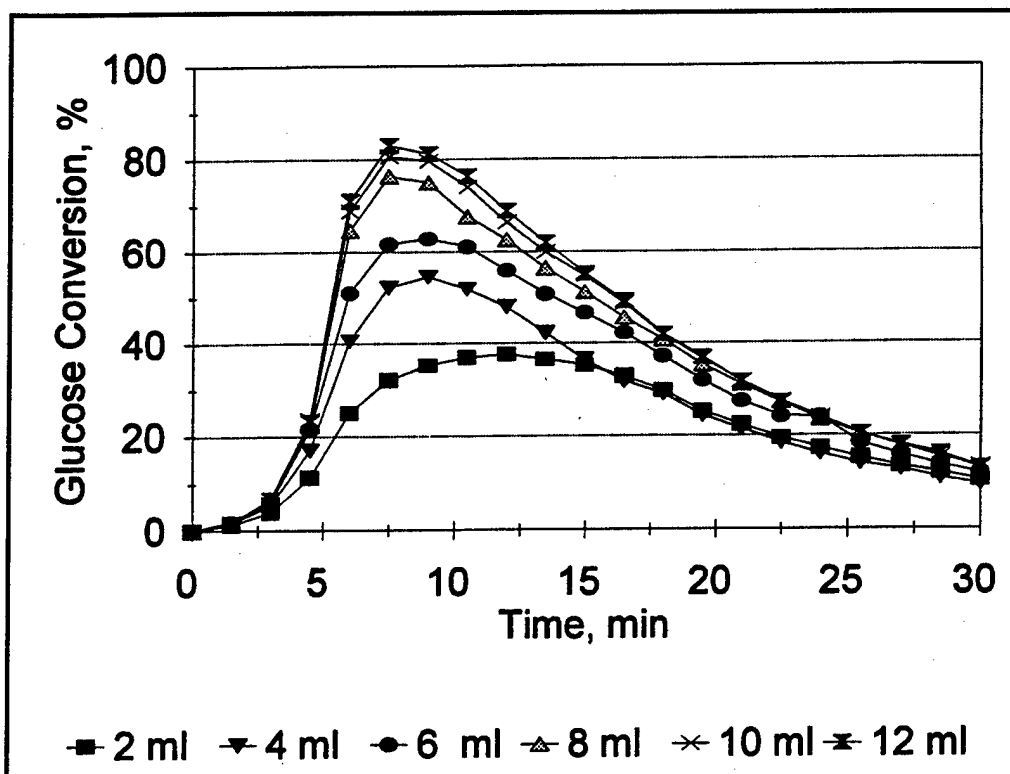

Figure 33. Glucose yield in nitrocellulose hydrolysis with various A/S ratios.

This confirms the observation stated earlier that the glucose yield is related to both reaction rate of NC hydrolysis and the glucose degradation. The higher the NC hydrolysis rate, the more glucose remained in the solution. Other than glucose, citric and formic acids constituted a major part of organic acids from the hydrolysis process of NC by using an HPLC analysis. Small amounts of oxalic, malic, pyruvic, succinic, glycolic, and adipic acids were also detected in the hydrolysate.

Change of Acid Concentration During Acid Hydrolysis

The acid concentration was measured by titration with sodium hydroxide. The test monitored the hydrogen ion change during hydrolysis process. Figure 34 shows the change of acid concentration in the aqueous phase. It shows that there is an initial decrease of acid concentration followed by an increase of concentration to its original value and then a further gradual increase. If a small amount of substrate (higher A/S ratios) was used in the test, the pH drop was small and the acid returned to its original concentration and stopped at that value. However, when a large amount of substrate (lower A/S ratios) were used, the final acid concentration would be higher than the original concentration, as in Figure 34.

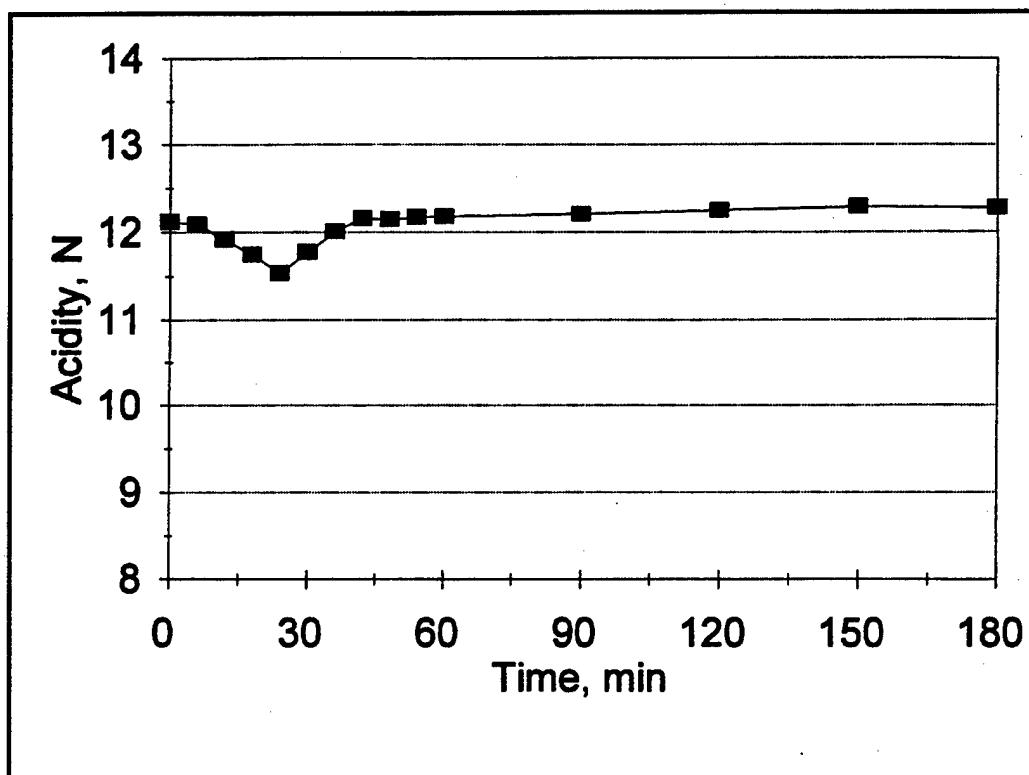

Figure 34. Changes of acid concentration during acid hydrolysis.

The decrease of acid concentration during the early stage might be due to the adsorption of acid on solids. The increase of concentration during the later stage could be due to the desorption of hydrogen ions resulting from the decreasing solids content. This observation was also reported in Ullal (1984)

Nitrogen Balance

To determine the change of nitrogen forms during acid hydrolysis, 0.4 g of NC with different amounts of hydrochloric acid was put into media tubes and sealed with a Teflon-lined airtight cap. These tubes were then put into a water bath controlled at 60 and 80 °C. Tubes were removed from the water bath at various intervals and quenched in ice water, and 10 mL of 10 N sodium hydroxide solution was injected into tubes. The tubes were shaken and the contents were analyzed for nitrate and nitrite content by Ion Chromatography. During the process of hydrolysis, first a light yellow color was observed in the tube. Then it turned to reddish brown, and at same time NC disappeared gradually. Finally, all solids were gone and the color had changed to brown or dark brown. The nitrogen dioxide is the only reddish brown gas among all different nitrogenous gases. The gas produced in hydrolysis could be the nitrogen dioxide. To confirm this, the sodium hydroxide solution was injected into the tube to react with nitrogen di-

oxide. When a caustic solution was injected into tube, the reddish brown color disappeared. Nitrogen dioxide reacts with hydroxide ion to form nitrate and nitrite. Nitrogen dioxide also can react with water to form nitrous and nitric acids. The reactions can be expressed as:

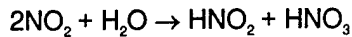
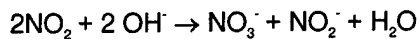

All nitrogen balance calculations of tested NC were based on a nitrogen content of approximately 13.5 percent. The nitrogen recovery results are presented in Figures 35 to 42. From the results of the nitrogen recovery study, it was found that no consistent pattern could be obtained. Generally, the concentration of nitrite increased slowly. The concentration of nitrate increased to a peak concentration, after which the nitrate concentration either dropped or remained the same in solution. In some cases, two peaks of nitrate were observed. At 60 °C, the maximum nitrogen recovery was about 85 percent at A/S ratio = 10 mL / 0.4 g, and about 50 percent nitrogen recovery was obtained at 80 °C and A/S ratio = 4 mL / 0.4 g. This experiment indicates that more nitrogen can be recovered at lower reaction temperature and higher A/S ratio based on the measurement of nitrate and nitrite by ion chromatograph in caustic solution.

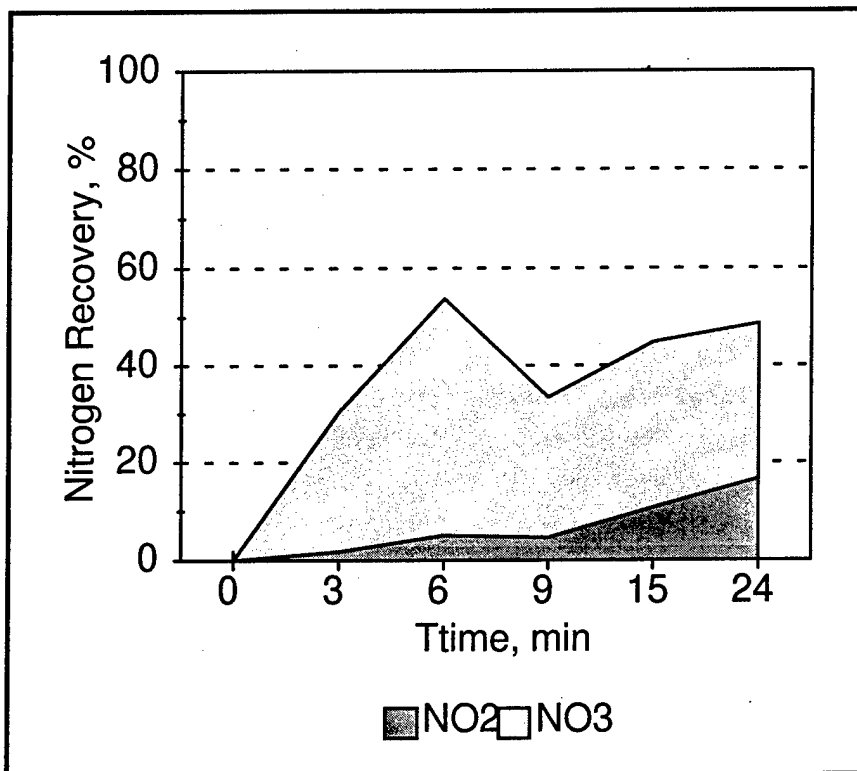

Figure 35a. Nitrogen recovery in nitrocellulose hydrolysis at 80 °C (A/S = 10 ml/0.4 g).

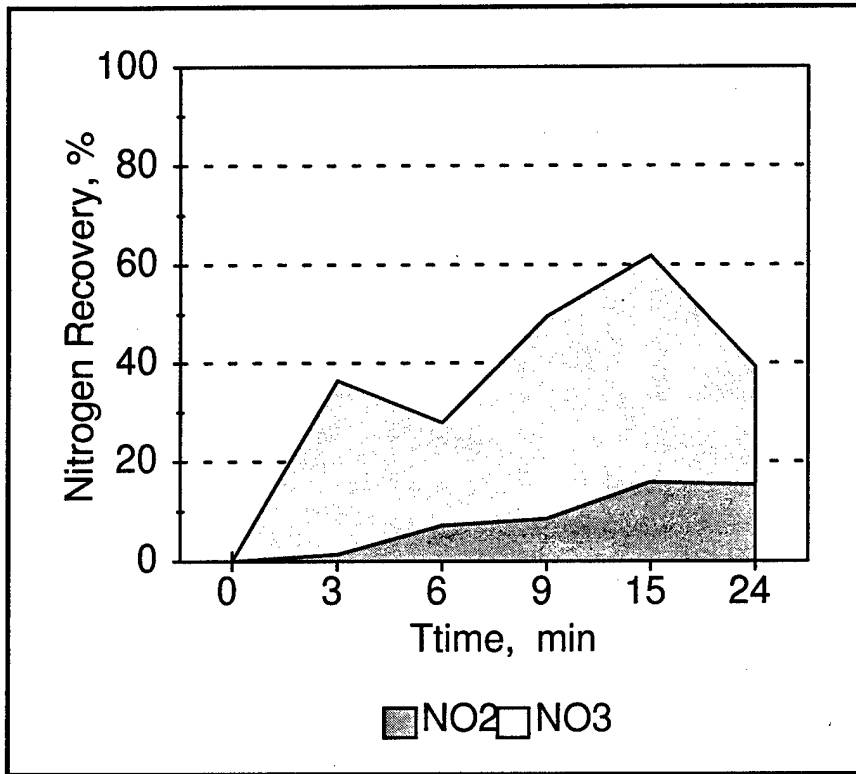

Figure 35b. Nitrogen recovery in nitrocellulose hydrolysis at 80 °C (A/S = 8 ml/0.4 g).

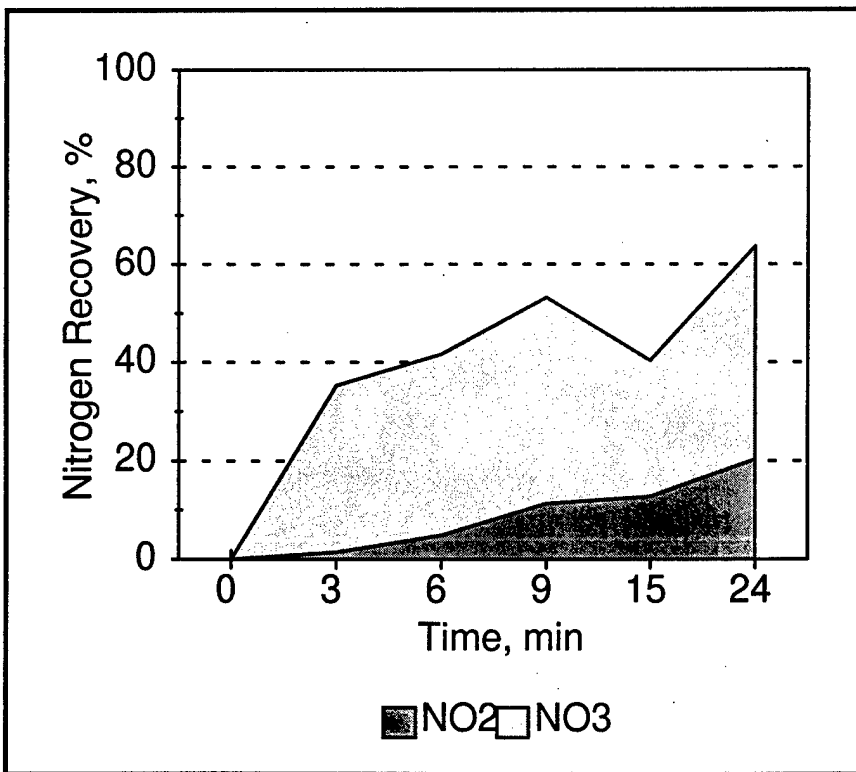

Figure 35c. Nitrogen recovery in nitrocellulose hydrolysis at 80 °C (A/S = 6 ml/0.4 g).

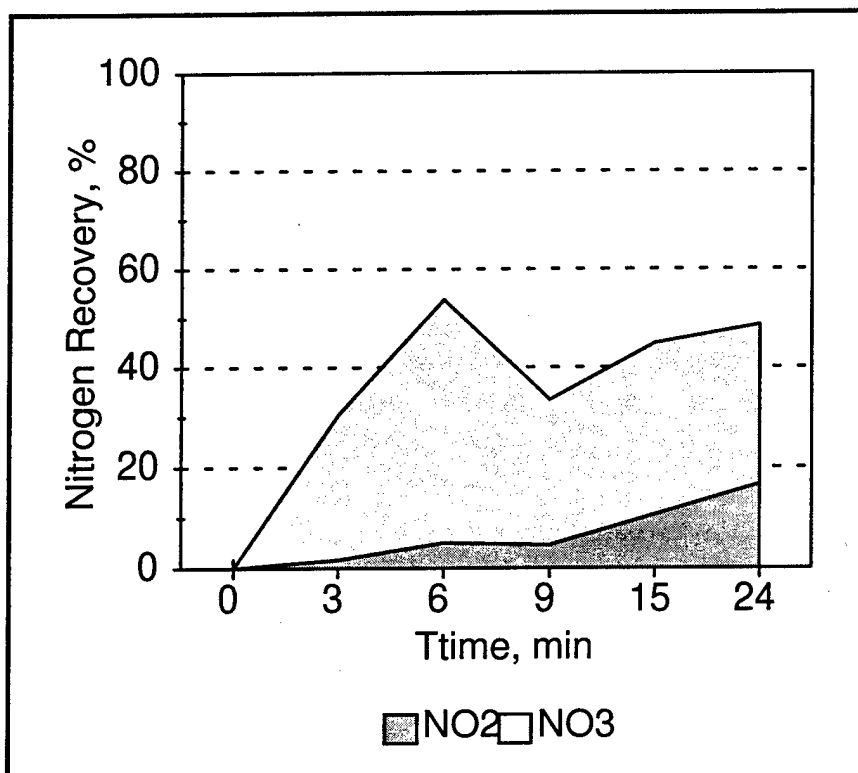

Figure 35d. Nitrogen recovery in nitrocellulose hydrolysis at 80 °C (A/S = 4 ml/0.4 g).

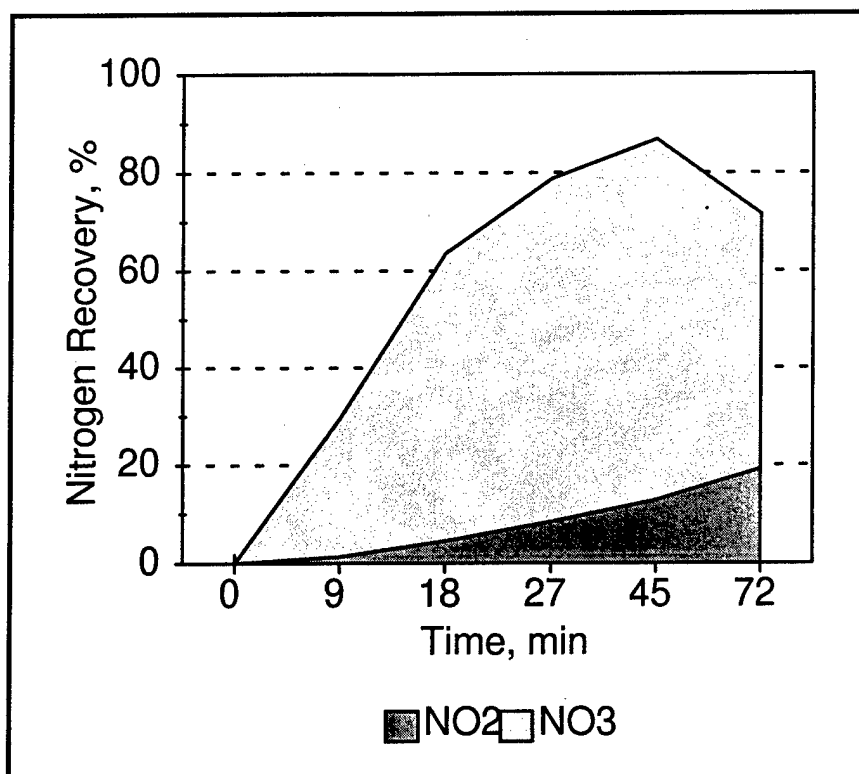

Figure 36a. Nitrogen recovery in nitrocellulose hydrolysis at 60 °C (A/S = 10 ml/0.4 g).

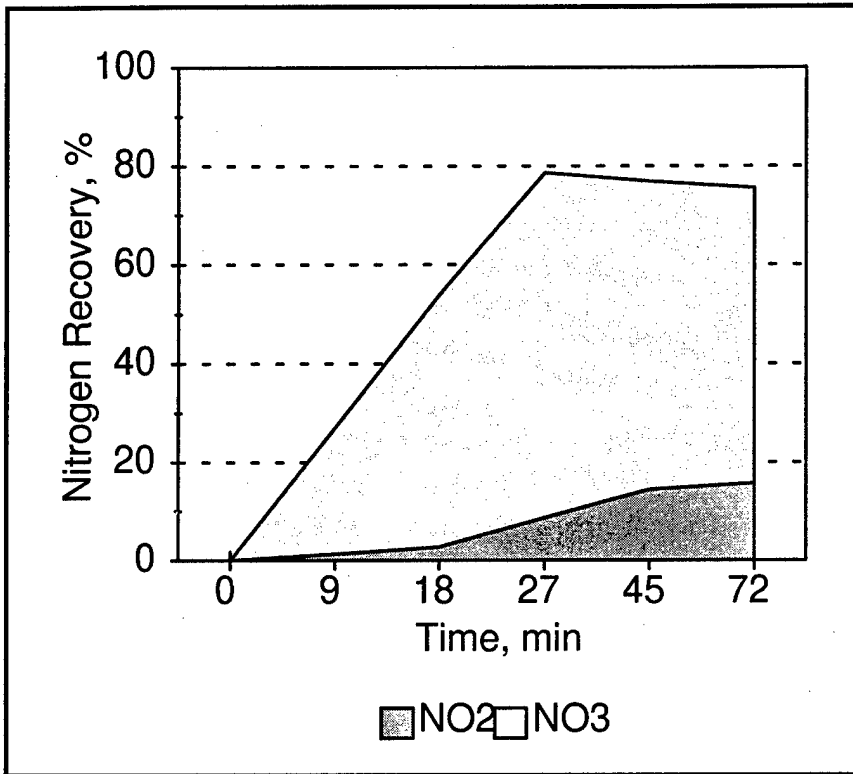

Figure 36b. Nitrogen recovery in nitrocellulose hydrolysis at 60 °C (A/S = 8 ml/0.4 g).

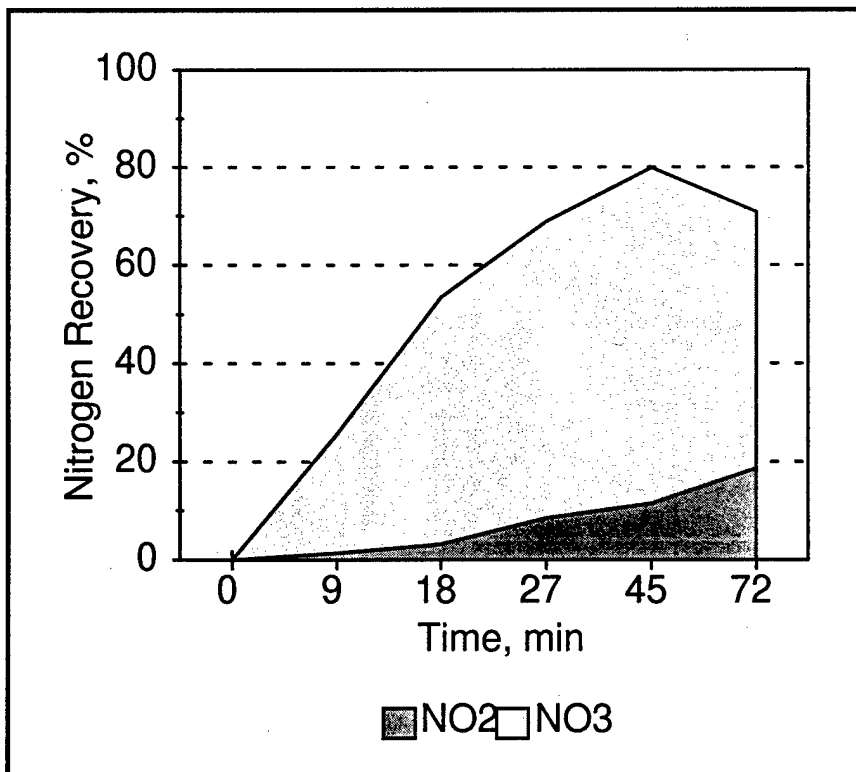

Figure 36c. Nitrogen recovery in nitrocellulose hydrolysis at 60 °C (A/S = 6 ml/0.4 g).

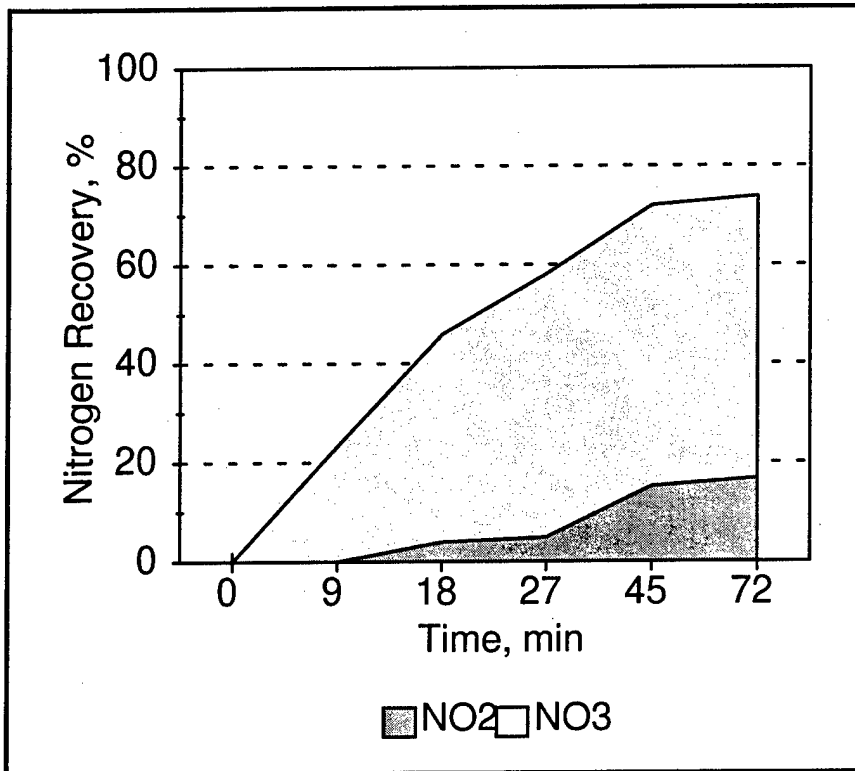
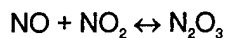
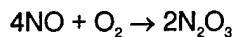

Figure 36d. Nitrogen recovery in nitrocellulose hydrolysis at 60 °C (A/S = 4 ml / 0.4 g).

Most of the nitrogen recovery in this experiment was measured in the nitrate form, and only small amount of nitrite was detected. This could be due to the unstable nature of nitrite. Ammonia was also detected from the solution, but compared to the concentration of nitrate and nitrite, only a negligible amount. When the supply of oxygen is limited, part of the nitric oxide is converted to nitrogen trioxide and the rest of nitric oxide can also react with nitrogen dioxide to form nitrogen trioxide.



This could be the reason why only 85 percent of the nitrogen was recovered in the form of nitrate and nitrite. The nitrogen that was not found in the solution might have escaped from tube during the injection of the caustic solution. Another possibility is that the HNO_3 produced from hydrolysis of NC was further reduced to NO , N_2O , and N_2 . In this situation, nitrogen cannot be detected in either nitrate or nitrite from Ion Chromatograph analysis.

6 Proposed Nitrocellulose Treatment Method

Chapter 5 showed that NC can be broken down through acid hydrolysis. However, the use of acid hydrolysis has one principal drawback — the expense of the strong acid. Fortunately, the recovery of acid is an existing technology (Goldstein and Easter 1992) that can be used for this treatment method. Therefore, a schematic flow diagram is proposed (Figure 37). The NC is first treated with strong acid and broken down to glucose by acid hydrolysis. Electrodialysis can be used to recover the acid. The glucose produced during hydrolysis will be converted to ethanol or other useful products by fermentation after neutralization. This technology is further discussed below.

Acid Separation and Recovery

Hydrochloric Acid Stripper and Absorption

The hydrolyzate solution leaving the reactor still contains all the hydrochloric acid originally added to the reactor. The acid must be separated from the sugars, not only to permit fermentation, but also to reduce processing costs by recovering and recycling the hydrochloric acid. The volatility of hydrochloric acid gas allows it to be stripped from the hydrolyzate at reduced pressure. With pure water, this product can be carried all the way to the azeotrope at 20.2 percent hydrochloric acid.

However, the hydrochloric acid also binds to the sugars in hydrolyzate as well as to water. This leads to a reduction in hydrochloric acid volatility and to an upward shift in the azeotropic composition in addition to that which occurs at the reduced pressure. Hydrochloric acid volatility *can* be compensated by increasing the temperature in the stripper, but this increase cannot exceed the temperature limit adopted for the reactor. Higher temperatures would also cause degradation of the sugars. In the stripping process, 78 percent of the original acid can be stripped as a 48.6 percent solution (Goldstein 1992).

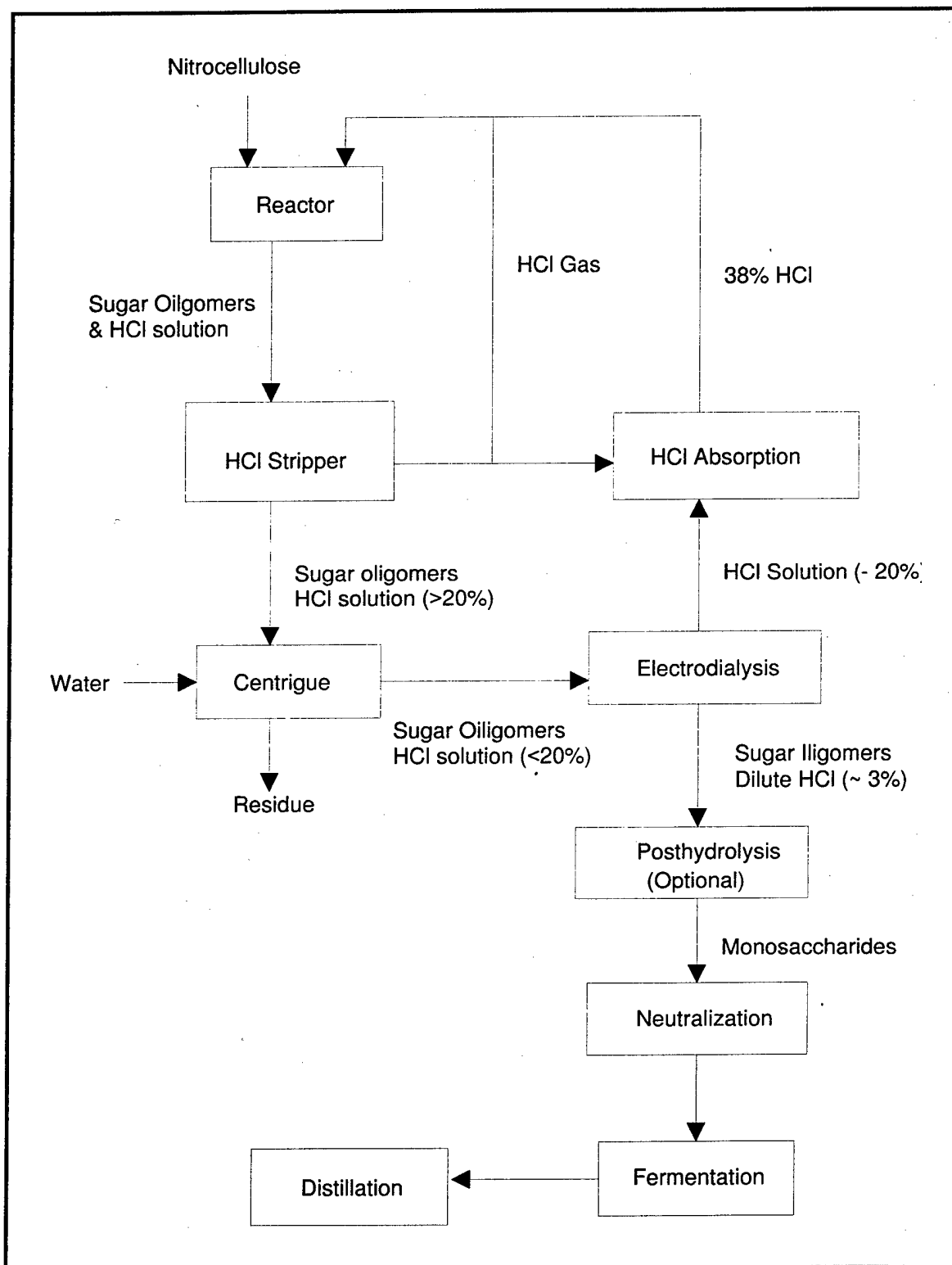

Figure 37. Proposed schematic flow of acid hydrolysis of nitrocellulose.

The hydrochloric acid stripped from the hydrolyzate would be recycled. Most of the acid recovered by the electrodialysis unit would enter an absorption system, as an approximately 20 percent hydrochloric acid solution. The remaining hy-

drochloric acid gas would be compressed sufficiently to bring the concentration of the solution that leaves the absorber up to 45 percent. This solution would be reintroduced into the reactor while maintaining this concentration at the moderate temperature in the reactor.

Electrodialysis

Hydrochloric acid and water form a maximum boiling azeotrope. Breaking this barrier can be difficult and costly. During World War II, the Germans operated concentrated wood hydrolysis plants; their experiences in hydrochloric acid recovery have been reported. The methods they used include combinations of atmospheric, vacuum, and extractive distillation, as well as evaporation using a mineral oil or steam as a heat transfer medium. Spray drying by direct contact with a stream of hot air has also been tried. Nguyen et al. (1981) designed a two-stage system where the first recovery stage uses vacuum distillation and the final stage uses extractive distillation with calcium chloride. Forster et al. obtained a U.S. patent in 1980 for an organic solvent extraction technique. This technique covers the C5-C9 alcohols, including the primary, secondary, and tertiary isomers. The first recovery step involves removing hydrochloric acid from the hydrolyzate by continuous, countercurrent extraction. In the second stage, hydrochloric acid is recovered by distillation.

Hydrochloric acid recovery from wood hydrolyzates can also be accomplished by electrodialysis using synthetic polymer membranes. An electrodialysis cell is constructed from an electrolytic cell by placing a cathodic membrane adjacent to the cathode and an anodic membrane next to the anode. When an applied electromotive force causes hydrogen ions to migrate toward the cathode and chloride ions to the anode, the interior compartment solution loses hydrochloric acid while the external compartment solutions gain hydrochloric acid. The applied electromotive force causes the migration of ionic components, while the concentration difference creates transport by diffusion and osmosis. Both the osmotic and the electromotive process transports hydrochloric acid against its concentration gradient.

Urano et al. (1984) investigated the acidic wastewater released from the iron and steel industry and demonstrated that the acids (sulfuric and hydrochloric acids) can be efficiently concentrated by electrodialysis. Figure 38 shows an apparatus for the electrodialysis used in this study. Table 24 lists the properties of ion-exchange membranes of Selemion CMV and AAV (Asahi Glass Co. Ltd.).

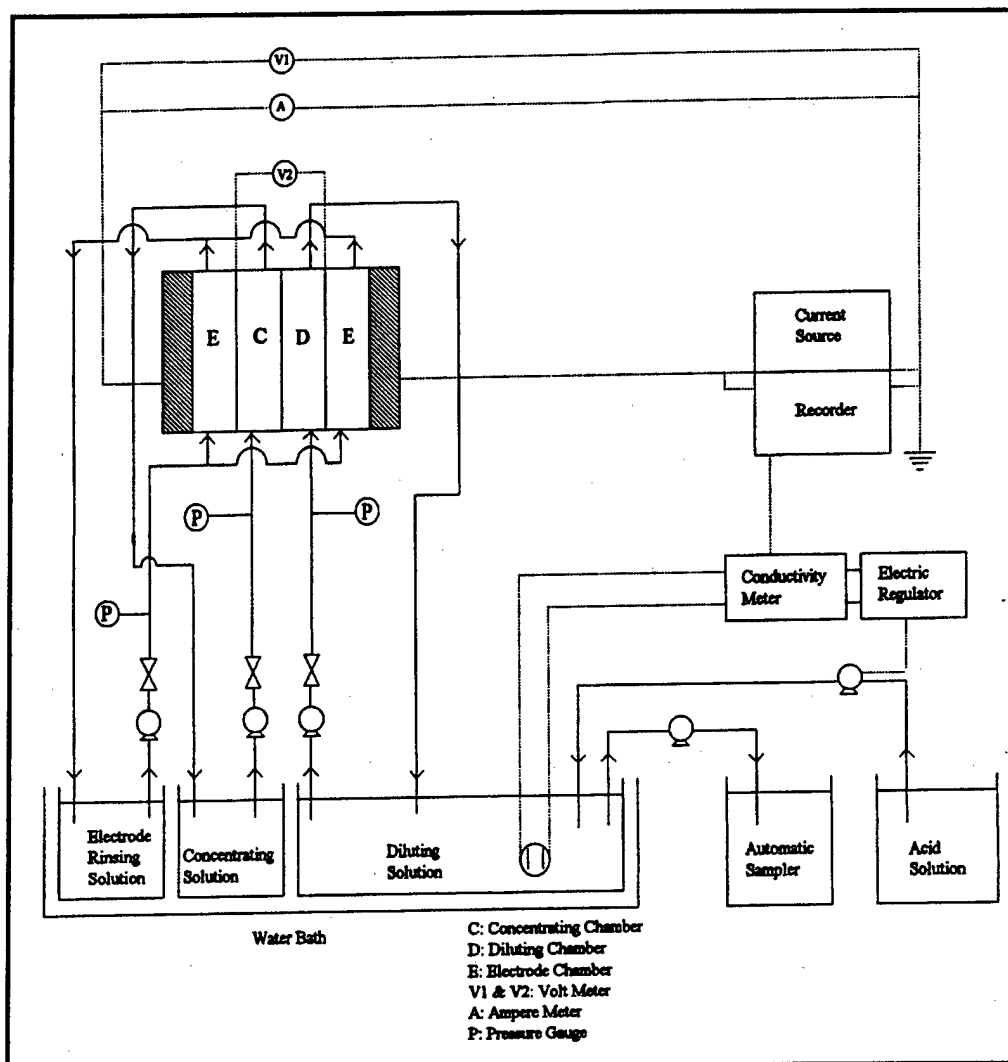

Figure 38. Experimental apparatus for electro dialysis (Urano et al. 1984).

Table 24. Properties of ion-exchange membranes (Urano et al. 1984).

	Anion-Exchange Membrane	Cation-Exchange Membrane
Commercial name	Selemion AAV	Selemion CMV
Thickness, cm	1.3×10^{-2}	1.3×10^{-2}
Ion-exchange capacity, equiv/g-dry membrane	7.7×10^{-4}	2.0×10^{-3}
Transport number	> 0.90 for Cl^-	> 0.91 for H^+
Weight of dry membrane, g/cm ² -membrane	1.3×10^{-2}	1.4×10^{-2}

Huang and Juang (1986) reported more than 40 percent current efficiencies in sulfuric acid-glucose-xylose mixture from dilute sulfuric acid hydrolysis by electro dialysis process. The ion-exchange membranes used in this study, Selemion CMV and Selemion AMV, were manufactured by Asahi Glass Co. of Japan. Table 25 lists these homogeneous membranes and their properties.

Table 25. Specifications of ion-exchange membranes (Huang and Juang 1986).

	Selecion CMV	Selecion AMV
Type	high acidic ion-exchange membrane	high basic ion-exchange membrane
Base material	Tevilon cloth (PVC)	Tevilon cloth (PVC)
Thickness, mm	0.12-0.15	0.11-0.14
Effective electrical resistance (Ω/cm^2)	190-230	280-320
Transport number	0.91-0.93	0.94-0.96
Burst strength, kg/cm^2	6-8	4-7

Table 26. Properties of ion-exchange membrane (Goldstein et al. 1989).

	Anion-Transfer Membrane	Cation-Transfer Membrane
Commercial name	103-QZL-386	61-CZL-386
Reinforcing fabric	Modacrylic	Modacrylic
Weight, mg/cm^2	15.3	14.0
Thickness, mm	0.63	0.6
Burst strength, kg/cm^2	10.8	8.0
Capacity, meq/dry gram resin	2.1	2.7

Goldstein's works (1989 and 1992) showed the technical feasibility of using membrane technology to separate hydrochloric acid from sugars in cellulose hydrolyzates. In this study, two membrane systems were chosen for their ability to withstand exposure to 20 percent hydrochloric acid and 60 percent sulfuric acid. The membraned stack, procured from Ionics Co. contained 20 type 103-QZL-386 anion-exchange membranes and 20 type 61-CZL-386 cation-exchange membrane. Table 26 lists the properties of membranes.

Huang and Juang indicated that the permeability of disaccharides was less than 1 percent of the acids permeability and acid flux in diffusion dialysis was only 6 percent of acid flux at optimum current density in electro dialysis. Ideally, the separation of hydrochloric acid from the sugar in the hydrolyzates by electro dialysis should provide a maximum yield of recovered acid at maximum concentration with minimum power consumption using minimum membrane area. Their experimental results made it obvious that these conditions cannot be met simultaneously. At the highest current efficiencies and, thus, the minimum membrane area, the final acid concentration in the concentration was too low. At the highest final acid concentrations, the percentage of acid transferred fell off, and power consumption and membrane area were high. As hydrochloric acid passed through the membranes, water was also transferred by osmotic forces. As the volume of acid and water transferred to the recovery stream increased, the volume of the hydrolyzate stream decreased. The sugars were retained in the hydrolyzate at concentrations up to 60 percent. The hydrochloric acid concentra-

tion of the hydrolyzate at the end of electro dialysis was about 3 percent, based on acid and water alone. This acid can be neutralized with base before fermentation.

Ethanol Fermentation and Purification

The microbial conversion of agricultural substrates into ethanol is an ancient practice that certainly predates the science of microbiology, the chemistry of the distillation process, and the engineering of ethanol fermentation plants. Pasteur's research with French wines in the 1860s defined the basic concepts of the fermentation process, and commercial interests in beer, wine, and hard liquor production promoted continual advances in the understanding of the biochemistry of ethanol fermentation.

Effect of Micro-organisms

When micro-organisms are grown on sugars in the presence of oxygen, they obtain cellular material and energy by oxidizing these organic compounds. As a result of this oxidation, carbon dioxide and water are produced as metabolic waste products. The excess electrons from the oxidation of sugars are carried by an electron transport system to oxygen, the final electron acceptor, and water is formed. Certain micro-organisms are able to grow on sugars in the absence of oxygen, using sugars instead of oxygen as electron acceptors. During this anaerobic growth, sugars are oxidized, excess electrons are transferred to organic acceptor molecules, and ethanol is produced as a waste product of the fermentation process instead of water. Micro-organisms responsible for ethanol production are facultative, i.e., they can grow with or without oxygen. If air is allowed to enter the fermentation process in sufficient quantities, then microbial metabolism will switch from an anaerobic, ethanol-producing process, to the more efficient aerobic process (Krebs cycle), and no further ethanol will be produced. The previously produced ethanol may actually be used (glycolytic pathway) and oxidized to carbon dioxide and cell material. Thus, microbes produce ethanol when growth conditions do not support oxidative metabolic process, thereby requiring these facultative micro-organisms to employ a less efficient pathway that produces ethanol as a metabolic waste product.

Although numerous micro-organisms can produce ethanol, not all are suitable for industrial processes. Also, no one culture is ideal for efficient conversion or high attenuation of all substrates. Yeast cultures (in particular *Saccharomyces sp.*) have been most extensively examined. Various species of *Saccharomyces* are used for ethanol production processes because they are very efficient in convert-

ing sugars into ethanol and are not as strongly inhibited by high ethanol concentrations as are other microbes. Theoretically, one mole of glucose can produce two moles of ethanol (511 kg of ethanol from 1000 kg of glucose). The yeast ethanolic fermentation is the most efficient pathway for ethanol production, but it is not the only pathway leading to ethanol accumulation. Table 27 lists the other pathways and involved micro-organisms. Recently, bacterial cultures of *Bacillus* and *Clostridium* species have been explored for high-temperature ethanol fermentation processes. *Bacillus* and *Clostridium* are able to grow as thermophilic micro-organisms and may therefore reduce the cost of the fermentation and distillation processes. However, the yield of ethanol by bacterial cultures is not as high as in yeast fermentations.

Conventional ethanol fermentations are usually conducted as batch processes where the reactor is charged with substrate, the microbial inoculum is added, and the process is allowed to run to completion, about 4 to 10 days (Munnecke 1981). The fermentation tank can be mechanically agitated by impellers to decrease diffusion limitations, or the natural agitation created by escaping carbon dioxide may be sufficient. In batch processes, the sugar is added batchwise at decreasing intervals to the growing culture, or continuously at an increasing rate as the microbial population expands. After the fermentation is complete, the cells are removed before distillation.

Table 27. Anaerobic metabolism of pyruvate (Brandt 1981).

Type of fermentation	End products	Micro-organisms
Ethanolic	Ethanol Carbon dioxide	Yeast Zymomonas
Mixed acid	Lactic, Formic, and Acetic acids Carbon dioxide Hydrogen Ethanol	Clostridium and many enteric bacteria
Butanediol	As in mixed acid plus 2,3-butanediol	Bacillus and other bacteria
Acetone/butanol	Acetic acid Butyric acid Ethanol and Butanol Acetone Isopropanol Carbon dioxide Hydrogen	Clostridium
Homolactic	Lactic acid	Lactobacillus Streptococcus

The same type of fermenter used in batch processes can also be used with slight modification for continuous-flow operation. Here, the sugar and nutrient medium are continuously added to the reactor, and the effluent, which contains ethanol and cell material is continuously treated for cell separation and product recovery. Since the concentration of sugar in the fermenter remains close to zero, there is no direct problem of high sugar concentrations adversely affecting cellular growth or ethanol production. The rate of sugar addition has to be regulated so that inhibitory levels of ethanol do not occur and cause decreased growth rate. The continuous fermenter for best efficiency should be operated near, but below, the maximal cellular growth rates. Figure 39 shows the processes for both batch and continuous fermentation of ethanol.

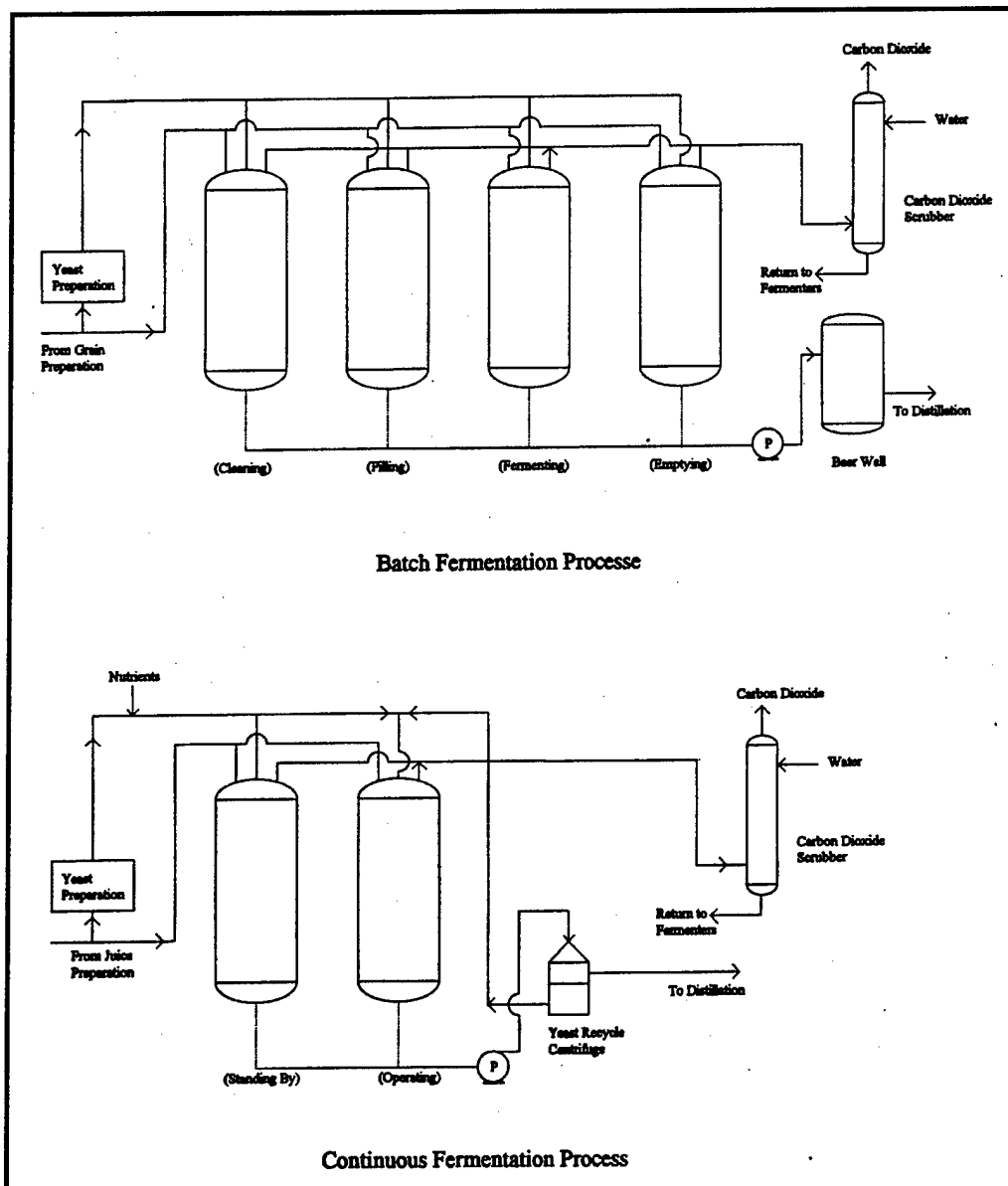

Figure 39. Processes for batch and continuous fermentation of ethanol (Brandt 1981).

A modification of the continuous fermentation process involves conducting the fermentation under a vacuum. Operating under vacuum, ethanol can be continuously removed from the broth as it is produced so that its inhibitory effects on cell growth are reduced. This modification allows for higher rates of ethanol production per liter of fermentation broth and creates a condensate containing a higher ethanol concentration for better distillation efficiency. Since ethanol production does not depend on cellular growth, nongrowing cells can be immobilized in gels and placed into the continuous-flow reactor. By maintaining nongrowth conditions, glucose conversion to ethanol can exceed 95 percent. Another advantage is that this process maintains high cell densities, even higher than with cell recycling methods, and that it does not require costly continual cell centrifugation and recycling. The efficiency of ethanol production by immobilized cells on a gram dry weight basis is reported to range upward from 80 percent in comparison to the productivity of free cell suspensions.

Ethanol Recovery

Ethanol recovery has been traditionally accomplished by distillation, which uses a train of towers operating in series, each accomplishing one or two separations of the ethanol from components of the fermentation broth. The first tower (so called "stillage separation") is designed to strip all ethanol from the broth and to increase the ethanol concentration in the overhead. The solids in the broth will be removed from the bottom of the stream. The distillation sequence after the beer still will vary with the type of ethanol product. Potable ethanol requires refining to the specifications for the product in which it is used. Industrial ethanol requires removal of impurities, including fusel oils, which are byproducts of the fermentation. In addition, anhydrous industrial ethanol requires that an entrainer be added to break the water-ethanol azeotrope in a separate tower. The ethanol and entrainer are then separated in another tower. Figure 40 shows the processes for distillation of various ethanol products (Brandt 1981). Anhydrous industrial ethanol requires at least four distillations in a standard design. A conventional distillation process consumes a great deal of energy to produce 99.5 percent fuel ethanol from the fermentation broth. New concentration and dehydration technologies such as heat pump distillation, azeotropic distillation, supercritical fluid extraction and per-vaporization methods were studied at the Research Association for Petroleum Alternatives Development (RAPAD) program (Miyakawa 1986).

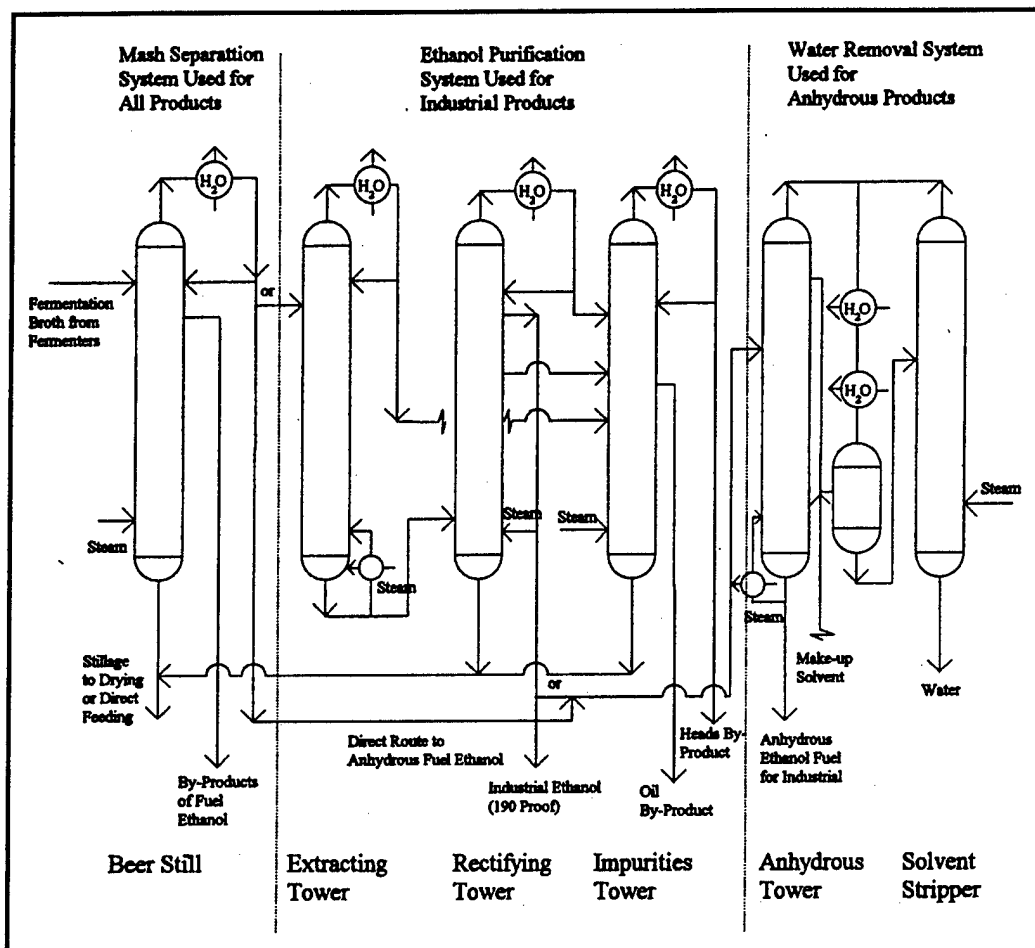

Figure 40. Processes for distillation of various ethanol products (Brandt 1981).

7 Conclusions and Recommendations

This investigation has demonstrated the potential for use of acid hydrolysis and anaerobic digestion to treat munitions-grade NC. The following conclusions and recommendations are made based on these experimental results.

Anaerobic Treatment Process

1. Biodegradation of NC through conventional anaerobic digestion is difficult, if NC is the sole carbon source in the wastewater.
2. The NC degradative enzyme could be induced by any of the three inducers added, i.e., lactose, cellobiose, and cellulose. Although gas production was low in the study, formation of the intermediate compounds, such as volatile organic acids, indicates that partial biodegradation of NC was achieved.
3. The two-stage anaerobic system was not an effective enhancement for the decomposition of NC. The stage-feed system has better conversion.
4. NC adversely affects the biodegradation of cellulose and decreases the gas production at inducer/NC ratios lower than 1/1.
5. The experiments showed that nitrate was released from NC by the hydrolysis of the NC nitrate ester group that could be enhanced by the anaerobic microorganisms.
6. Higher gas production was observed with a decrease in particle size distribution of the cellulose substrate. With the addition of Type 20 and Type 50 cellulose, a 48.9 percent of NC conversion could be obtained.
7. Competitive inhibition was observed in the anaerobic biodegradation of NC. The inhibitory effect can be overcome at higher cellulose concentrations. The kinetics and inhibition constants of NC on cellulose biodegradation are listed as follows:

$$V_{\max} = 13.93 \text{ mM/day}$$

$$K_m = 136.01 \text{ mM}$$

$$K_m' = 94.84 \text{ mM}$$

$$K_i = 17.32 \text{ mM.}$$

8. Since NC may be converted to intermediate compounds and not to the final gas product within the reasonable operation time, the development of analytical method to analyze NC and the intermediate compounds is necessary.

Hydrochloric Acid Hydrolysis of Nitrocellulose

1. Acid hydrolysis at moderate temperatures showed good promise for treatment of NC. Under optimal conditions, over 60 percent of the NC was converted to glucose in the hydrolysis process.
2. Acid hydrolysis of NC was related to acid concentration, the ratio of acid to NC, temperature, and time. At 90 °C, the hydrolysis reaction needed only about 9 minutes to reach maximum glucose yield (about 85 percent). The hydrolysis reaction took approximately 63 minutes to reach maximum glucose yield at 60 °C. Temperature affected only the rate of reaction, not the maximum glucose yield.
3. From the kinetic study of NC hydrolysis and glucose degradation, the reaction rates were found to be in the following equations, respectively:

$$K_1 = 1.0841 \times 10^6 A^{1.8183} (A/S)^{0.1286} \exp(-15,233/RT)$$

$$K_2 = 5.5082 \times 10^5 A^{0.5436} (A/S)^{0.0844} \exp(-12,568/RT)$$

4. It was found that nitrogen was released as NO and NO₂ during the hydrolysis process. However the undesirable NO and NO₂ can be easily converted into nitrate and nitrite by passing them through a caustic solution scrubber.
5. Other than glucose, citric and formic acids constituted a major part of organic acids from the hydrolysis process. Small amounts of oxalic, malic, pyruvic, succinic, glycollic, and adipic acids were also detected in the hydrolyzate.
6. Treatment of NC with an acid hydrolysis process, followed by application of a hydrochloric acid recovery system and an ethanol fermentation system is proposed as a feasible method to convert NC waste into useful end products.

References

- Anderson J., and A. Porteous, "Review of Developments in the Acid Hydrolysis of Cellulosic Wastes," *Proc. Instn. Mech. Engrs.*, vol 201, No. C2 (1987).
- Arthur D. Little, Inc., *Engineering / Cost Evaluation of Options for Removal, Disposal of NC Fines*, Final Report to U.S. Army Toxic and Hazardous Materials Agency (1987).
- APHA, AWWA, and WPCF, *Standard Methods for the Examination of Water and Wastewater*, 16th ed. (Washington, DC, 1985).
- Alleman, J.E., B.J. Kim, D.M. Quivey, and L.O. Equihua, "Alkaline Hydrolysis of Munitions-Grade NC," *Proceedings of NC Fines Separation and Treatment Workshop, Purdue University* (4-5 November 1993).
- Babcock, R.W., and M.K. Stenstrom, "Use of Inducer Compounds in the Enricher-Reactor Process for Degradation of 1-Naphthylamine Wastes," *Water Environment Research*, vol 65 (January/February 1993).
- Berthelot, D., and H. Gaudechon (as quoted by Kim), *Chemistry and Technology of Explosives*, vol 2 (Pergamon Press, London, England, 1965).
- Bokorny, T. (as quoted by Kim), *Chemistry and Technology of Explosives*, vol 2 (Pergamon Press, London, England, 1965).
- Brandt, D., "Ethanol Production by Fermentation," *Biomass Conversion Processes for Energy and Fuels*, Sofer, S.S. and O.R. Zaborsky, eds. (Plenum Press, New York, 1981).
- Brodman, B.W., and M.P. Devin, "Microbial Attack of NC," *Journal of Applied Polymer Science*, vol 26 (1981).
- Connors, Kenneth A., "Complicated Rate Equations," *Kinetic and Chemical Technology*, C.H. Bamford, C.F.H. Tippen, and R.G. Gompton, eds. (Elsevier Publishing Co., New York, 1985).
- Conaway (as quoted by Ott), *Cellulose and Cellulose Derivatives*, vol 5, 2d ed. (Interscience Publisher, New York, 1954).
- Duran, M., B.J. Kim, and R.E. Speece, "Anaerobic Biotransformation of NC," *Waste Management Journal*, vol 14, No. 6, (1994), p 481.
- Fagan, R.D., H.E. Grethlein, A.O. Converse, and A. Porteous, "Kinetics of the Acid Hydrolysis of Cellulose Found in Paper Refuse," *Environmental Science and Technology*, vol 5, No. 6 (June 1971).

- Fowler, et al. (as quoted by Ott), *Cellulose and Cellulose Derivatives*, vol 5, 2d ed. (Interscience Publisher, New York, 1954).
- Fred, B.M., T.M. Singh, and I.S. Goldstein, "Some Factors Influencing the Rate of Cellulose Hydrolysis by Concentrated Acids," *Biotechnology and Bioengineering Symp.*, No. 15 (1985).
- Gallo, B., A. Allen, R.L. Bagalawis, C. Woodbury, A. Yang, P. Austin, and D. Kaplan, "Microbial Degradation of Nitrocellulose," *Proceedings of Nitrocellulose Fines Separation and Treatment Workshop, Purdue University* (4-5 November 1993).
- Goldstein, I.S., and J.M. Easter, "An Improved Process for Converting Cellulose to Ethanol," *Tappi Journal* (August 1992).
- Goldstein, I.S., F.B. Makooi, H.S. Sabharwal, and T.M. Singh, "Acid Recovery by Electrodialysis and its Economic Implications for Concentrated Acid Hydrolysis of Wood," *Applied Biochemistry and Biotechnology*, vol 20/21 (1989).
- Goldstein, I.S., H. Pereira, J.L. Pittman, B.A. Strouse, and F.P. Scaringelli, "The Hydrolysis of Cellulose with Superconcentrated Hydrochloric Acid," *Biotechnology and Bioengineering Symp.*, No.13 (1983).
- Grady, C.P. L., Jr., "Biodegradation: Its Measurement and Microbial Basis," *Biotechnology and Bioengineering*, vol 27 (1985).
- Griest, W.H., "A Proposal for the Analysis of Nitrocellulose in Soil or Compost," *Proceedings of Nitrocellulose Fines Separation and Treatment Workshop* (Purdue University, IN, 4-5 November 1993).
- Hsieh, H.N. and F.J. Tai, "Anaerobic Digestion and Acid Hydrolysis of Nitrocellulose," *Proceedings of Nitrocellulose Fines, Separation, and Treatment Workshop* (Purdue University, IN, 4-5 November 1993).
- Hsieh, H.N., and F.J. Tai, *Biodegradation of Nitrocellulose Contained in Ammunition Wastewater by Anaerobes*, Technical Report (TR) submitted to U.S. Army Construction Engineering Research Laboratories (CERL) (January 1994).
- Hsieh, H.N., F.J. Tai, and B.Y. Kim, "Biodegradation of Nitrocellulose with Anaerobic Digestion," *Proceeding of the 26th Mid-Atlantic Industrial Waste Conference- Hazardous & Industrial Wastes, University of Delaware, Newark, Delaware* (7-10 August 1994).
- Huang, T.C., and R.S. Juang, "Recovery of Sulfuric Acid with Multicompartment Electrodialysis," *Ind. Eng. Chem. Process Des. Dev.*, vol 25, No. 2 (1986).
- Hubregste, K.R., *Feasibility Study Regarding Landfill of NC Lime Sludge and Oxidation of NG in Wastewater Stream*, TR, Contract No. DAAG-53-76-C- 0082 (1978).
- Humphrey, A.E., *The Hydrolysis of Cellulosic Materials to Useful Products: Hydrolysis of Cellulose: Mechanisms of Enzymatic and Acid Catalysis* (American Chemical Society, Washington, DC, 1979).

- Jacque, M. (as quoted by Kim), *Chemistry and Technology of Explosives*, vol 2 (Pergamon Press, London, England, 1965).
- Kennedy, J.F., G.O. Phillips, D.J. Wedlock, and P.A. Williams, *Cellulose and Its Derivatives: Chemistry, Biochemistry, and Application* (John Wiley & Sons New York, 1970).
- Kenyon, W.O., and H.L. Gray, "The Alkaline Decomposition of Cellulose Nitrate, I. Quantitative Studies," *Journal of The American Chemical Society*, vol 58 (1936).
- Kim, B.J., J. Alleman, and D. Quivey, *Alkaline Hydrolysis/Biodegradation of Nitrocellulose Fines* CERL TR 98/65/ADA359192 (CERL, August 1998).
- Kim, B.J., and J.K. Park, "Comprehensive Evaluation and Development of Treatment Technologies for Nitrocellulose Fines and Process Wastewater," *JANNAD Interagency Propulsion Committee Safety and Environmental Subcommittee Meeting* (Montgomery, CA, 1992).
- Kraus, A. (as quoted by Kim), *Chemistry and Technology of Explosives*, vol 2 (Pergamon Press, London, England, 1965).
- Lacey, J. (as quoted by Kim), "Fungal Deterioration of Gunpowder," *Trans. Br. Mycol. Soc.*, vol 74 (1980).
- Lure, B.A., Z.T. Valishina, and B.S. Svetlov, "Heterophase Alkaline Hydrolysis of Cellulose Nitrate," *Vysokomol. Soedin*, ser. B, vol 33 (1991).
- Lure, B.A., Z.T. Valishina, and B.S. Svetlov, "Kinetics and Mechanism of the Chemical Transformation of Cellulose Nitrate in Aqueous Sulfuric Acid," *Vysokomol. Soedin*, ser A, vol 33-1 (1991).
- Malenkovic, B. (as quoted by Kim), *Chemistry and Technology of Explosives*, vol 2 (Pergamon Press, London, England, 1965).
- McCarty, P. L., "Stoichiometry of Biological Reactors," *International Conference-Toward a Unified Concept of Biological Waste Treatment Design* (Atlanta, GA, 1972).
- McCarty, P.L. "Energetic and Bacterial Growth," 5th *Rudolf Research Conference, New Brunswick, NJ* (1969).
- Miyakwa, H., S. Moriyama, H. Ishibashi, N. Mizutani, H. Michiki, and T. Saida, "Fuel Ethanol Production from Cellulosic Biomass," *Biotechnology and Bioengineering Symp.*, No. 17 (1986).
- Munnecke, D.M., "Basic Principles of Ethanol Fermentation," *Biomass Conversion Processes for Energy and Fuels*, S.S. Sofer, and O.R. Zaborsky, eds. (Plenum Press, New York, 1981).
- Muraour, et al. (as quoted by Ott), *Cellulose and Cellulose Derivatives*, vol 5, 2d ed. (Interscience Publisher, New York, 1954).
- Oguri, S. (as quoted by Kim), *Chemistry and Technology of Explosives*, vol 2 (Pergamon Press, London, England, 1965).

- Ott, E., H.M. Spurlin, and W. Grafflin, *Cellulose and Cellulose Derivatives*, vol 5, 2d ed. (Interscience Publisher, New York, 1954).
- Owen, W.F., et al., "Bioassay for Monitoring Biochemical Methane Potential and Anaerobic Toxicity," *Water Research*, vol 12 (1979).
- Patterson, J.W., J. Brown, W. Dackert, J. Polson, and N.I. Sphira, *Wastewater Treatment in the Military Explosives and Propellants Production Industry*, TR EPA/600/1-76/213A-C (U.S. Environmental Protection Agency [USEPA], October 1976).
- Quinchon, J., and J. Tranchant, *Nitrocellulose: The Materials and Their Application in Propellants, Explosive and Other Industries* (John Wiley & Sons, New York, 1989).
- Roy F. Weston, Inc., "Composting of Nitrocellulose-Contaminated Soils at Badger Army Plant (BAAP)," *Proceedings of Nitrocellulose Fines Separation and Treatment Workshop* (Purdue University, IN, 4-5 November 1993).
- Saeman, J.F., "Kinetic of Wood Saccharification-Hydrolysis of Cellulose and Decomposition of Sugars in Dilute Acid at High Temperature," *Industrial Engineering Chemistry*, vol 37 (1945).
- Schnabel W., *Polymer Degradation: Principles and Practical Applications* (Hanser International Macmillan Publishing, New York, 1981).
- Siu, R.G.H., et al., "Specificity of Microbial Attack on Cellulose Derivatives," *Textile Research Journal*, vol 19 (1949).
- Siu, R.G.H., *Microbial decomposition of Cellulose with Special Reference to Cotton Textiles* (Reinhold Publishing Corp., New York, 1951).
- Sklarewitz, M.L., *An Engineering and Economic Analysis for Hydrochloric Acid Recovery by Electrodialysis in Concentrated Acid Wood Hydrolysis*, Ph.D. Thesis (North Carolina State University, 1984).
- Stoller H.M., "Reuse of Nitrocellulose-Based Gun Propellants for Agricultural Applications," *Proceedings of Nitrocellulose Fines Separation and Treatment Workshop* (Purdue University, IN, 4-5 November 1993).
- Ullal V.G., R. Mutharasan, and E.D. Grossmann, "New Insights into High Solids Acid Hydrolysis of Biomass," *Biotechnology and Bioengineering Symp.*, No. 14 (1984).
- Urano, K., T. Ase, and Y. Naito, "Recovery of Acid from Wastewater by Electrodialysis," *Desalination*, vol 51 (1984).
- Vandoni, R. et al. (as quoted by Ott), *Cellulose and Cellulose Derivatives*, vol 5, 2d ed. (Interscience Publisher, New York, 1954).
- Wendt, T.M., and A.M. Kaplan, "A Chemical-Biological Treatment Process for Cellulose Nitrate Disposal," *Journal Water Pollution Control Federation*, vol 48 (1976).

White, W., "Determine of Nitrogen Content in Nitrocellulose by Infrared Spectrometry," *Journal of Analytical Chemistry* (August 1962).

Williams, R.T., *Field Demonstration - Composting of Propellants Contaminated Sediments at the Badger Army Ammunition Plant*, Report to USATHAMA (Roy Weston, 1989).

Wolfrom, M.L., J.H. Frazer, L.P. Kuhn, E.E. Dickey, S.M. Olin, D.O. Hoffman, R.S. Bower, A. Chaney, E. Carpenter, and P. McWain, "The Controlled Thermal Decomposition of Cellulose Nitrate I.," *Journal of The American Chemical Society*, vol 77 (1955).

Yang, M. and M. Ramsey, "Destruction of Nitrocellulose by Irradiation of Pulsed Laser," *Proceedings of Nitrocellulose Fines Separation and Treatment Workshop* (Purdue University, IN, 4-5 November 1993).

CERL DISTRIBUTION

HQ IOC

ATTN: AMSIO-EQC (2)

US Army Environmental Center

ATTN: SFIM-AEC-ET (2)

Chief of Engineers

ATTN: CEHEC-IM-LH (2)

ATTN: CEHEC-IM-LP (2)

ATTN: CECC-R

ATTN: CERD-L

ATTN: CERD-M

Defense Tech Info Center 22304

ATTN: DTIC-O (2)

13
11/96

REPORT DOCUMENTATION PAGE

Form Approved
OMB No. 0704-0188

Public reporting burden for this collection of information is estimated to average 1 hour per response, including the time for reviewing instructions, searching existing data sources, gathering and maintaining the data needed, and completing and reviewing the collection of information. Send comments regarding this burden estimate or any other aspect of this collection of information, including suggestions for reducing this burden, to Washington Headquarters Services, Directorate for Information Operations and Reports, 1215 Jefferson Davis Highway, Suite 1204, Arlington, VA 22202-4302, and to the Office of Management and Budget, Paperwork Reduction Project (0704-0188), Washington, DC 20503.

1. AGENCY USE ONLY (Leave Blank)		2. REPORT DATE April 1999	3. REPORT TYPE AND DATES COVERED Final	
4. TITLE AND SUBTITLE Anaerobic Digestion and Acid Hydrolysis of Nitrocellulose			5. FUNDING NUMBERS 62720 D048 TE7	
6. AUTHOR(S) Byung J. Kim, Hsin-Neng Hsieh, and Fong-Jung Tai				
7. PERFORMING ORGANIZATION NAME(S) AND ADDRESS(ES) U.S. Army Construction Engineering Research Laboratory (CERL) P.O. Box 9005 Champaign, IL 61826-9005			8. PERFORMING ORGANIZATION REPORT NUMBER TR 99/45	
9. SPONSORING / MONITORING AGENCY NAME(S) AND ADDRESS(ES) Headquarters, U.S. Army Corps of Engineers ATTN: CERD-L 20 Massachusetts Ave., NW. Washington, DC 20314-1000			10. SPONSORING / MONITORING AGENCY REPORT NUMBER	
9. SUPPLEMENTARY NOTES Copies are available from the National Technical Information Service, 5385 Port Royal Road, Springfield, VA 22161				
12a. DISTRIBUTION / AVAILABILITY STATEMENT Approved for public release; distribution is unlimited.			12b. DISTRIBUTION CODE	
13. ABSTRACT (Maximum 200 words) In military applications, nitrocellulose (NC) based powders are extensively used as propellant in bullets, shells, and various missiles for tube munitions. Residual NC produced during the manufacturing process is composed of insoluble fibers, or "fines" in suspension. Currently, these suspended solids are recovered and reused. However, since the Army expects to terminate the re-use of pit cotton in the near future, there is a need to develop innovative NC treatment and disposal technologies. This study evaluated and demonstrated the potential for the use of acid hydrolysis and anaerobic digestion to treat munitions-grade nitrocellulose. As an alternative treatment, the concept of acid hydrolysis was developed and validated with bench scale tests. NC was hydrolyzed with high strength hydrochloric acid and was converted to glucose. The degradative intermediate and end products were identified and a kinetic model was validated.				
14. SUBJECT TERMS nitrocellulose fines hydrolysis waste management			15. NUMBER OF PAGES 96	
			16. PRICE CODE	
17. SECURITY CLASSIFICATION OF REPORT Unclassified		18. SECURITY CLASSIFICATION OF THIS PAGE Unclassified	19. SECURITY CLASSIFICATION OF ABSTRACT Unclassified	
		20. LIMITATION OF ABSTRACT SAR		