

66
5/12/52

NACA TN 2754

NATIONAL ADVISORY COMMITTEE FOR AERONAUTICS

TECHNICAL NOTE 2754

A METHOD OF SELECTING THE THICKNESS, HOLLOWNESS, AND SIZE
OF A SUPERSONIC WING FOR LEAST DRAG AND SUFFICIENT
BENDING STRENGTH AT SPECIFIED FLIGHT CONDITIONS

By James L. Amick

Langley Aeronautical Laboratory
Langley Field, Va.



Washington

July 1952

Reproduced From
Best Available Copy

20000505 077

M00-08-2232

NATIONAL ADVISORY COMMITTEE FOR AERONAUTICS

TECHNICAL NOTE 2754

A METHOD OF SELECTING THE THICKNESS, HOLLOWNESS, AND SIZE
OF A SUPERSONIC WING FOR LEAST DRAG AND SUFFICIENT
BENDING STRENGTH AT SPECIFIED FLIGHT CONDITIONS

By James L. Amick

SUMMARY

This paper considers a wing-selection problem sometimes encountered in the preliminary design of supersonic airplanes and missiles. The problem is to determine the span, section thickness ratio, and skin thickness or hollowness ratio of the wing of least drag when the plan form, section shape, wing lift requirement, and flight conditions are assumed known. The only structural requirement considered in the analysis is that of bending stress which is assumed to be carried entirely by the skin. An analytical method is presented by means of which the optimum wing dimensions can readily be obtained.

An example of the application of the method to a diamond wing at Mach number 2.0, for a range of specified flight conditions, is presented. From this example, for supersonic flight at low altitudes, steel wings appear to have appreciably less drag than aluminum wings; whereas, for high altitudes, the reverse appears to be true. It is concluded from the example that wings with thickness ratios, hollowness ratios, or chords appreciably different from those given by the present method may have considerably higher drags.

INTRODUCTION

In the analysis of research data for supersonic wings and also in the preliminary design of supersonic airplanes and missiles, a need often arises for a simple, quick method of estimating the optimum size and thickness of the wing for a specific application. The problem visualized here is one in which the thickness, hollowness, and size of the wing which will result in minimum drag are to be estimated when the plan form and section shape have been previously selected and the flight conditions and the required wing lift are specified. Of the several structural criteria which the wing may finally be required to meet, only

the bending strength requirement is considered in this problem. The purpose of this paper is to present a simple analytical method for solving this preliminary problem.

A simple criterion for selecting wing thickness has been given by Jones (reference 1). This criterion, which is based on a study of minimum spar depths of conventional aircraft, gives the maximum thickness of the wing at its root as one-fifteenth the distance from the root chord to the centroid of area of the wing panel, measured along the maximum-thickness line. Various combinations of plan form and profile shape may be evaluated by comparing their maximum lift-drag ratios, the thickness-chord ratio determined by the criterion being used in each case. (The chord is selected so that the wing will have maximum lift-drag ratio at the design conditions, and the wing weight is neglected.)

Jones' criterion is premised on the assumption that the wing is of the conventional thin-skinned construction; however, from considerations that are given in the analysis of the present paper, it appears that supersonic missiles designed for flight at low altitudes should have nearly solid wings, which require considerably less over-all thickness than do thin-skinned wings, for the same strength. Jones' criterion obviously could not be expected to apply for this type of wing.

The method presented is approximate in nature serving only as a rapid means for determining optimum wing dimensions from the drag standpoint for use in preliminary-design studies. In the final analysis, a more rigorous approach must be employed which would consider such items as wing torsional strength, flutter, and divergence.

SYMBOLS

A thickness drag factor $\left(\frac{C_{D_{C_L=0}} - C_{D_f}}{\left(\frac{t}{c}\right)^2} \right)$

A_x root cross-sectional area of solid part of wing in streamwise direction

B drag-rise factor $\left(\frac{C_D - C_{D_{C_L=0}}}{C_L^2} \right)$

c	wing root chord
C_D	wing total-drag coefficient
C_{Df}	wing skin-friction-drag coefficient
C_L	wing lift coefficient
D_w	total-drag force of both wing panels
h	wing semispan
k_1	ratio of section modulus of a solid wing section to $\left(\frac{t}{c}\right)^2 c^3$
k_2	ratio of moment of inertia about chord line to moment of inertia about neutral axis parallel to chord line, for a solid wing section
k_3	ratio of distance between x-axis and x'-axis (fig. 1) to radius of gyration of solid wing section about chord line
k_4	ratio of distance between x-axis and x'-axis to distance from neutral axis to outermost fiber, for a solid wing section
k_5	ratio of distance between x-axis and neutral axis to distance from neutral axis to outermost fiber, for a solid wing section
k_6	ratio of area of a solid wing section to $\frac{t}{c} c^2$
k_7	ratio of volume of one wing panel to $A_x h$
m	hollowness ratio (ratio of maximum thickness of hollow part of wing cross section to over-all thickness of cross section) (see fig. 1)
M	design Mach number
M_B	bending moment about wing root chord
n	normal load factor at design flight conditions
n_{max}	maximum normal load factor anticipated

- N ratio of weight of a solid wing of thickness given by equation (5) (η assumed to be zero) to weight of airplane minus wing (see equation (9))
- P ratio of thickness drag to drag due to lifting only wing weight for a solid wing of given chord (see equation (12))
- q stream dynamic pressure
- r ratio of chordwise extent of hollow part of wing cross section to the wing chord (see fig. 1)
- R ratio of skin-friction drag to drag due to lifting only wing weight for a solid wing of minimum thickness when $\eta = 0$ is assumed (see equation (20))
- S total area of both wing panels
- t maximum thickness of wing at root
- V volume of the solid material in one wing panel
- W_F weight of airplane minus wing
- W_w weight of both wing panels
- $$X = \frac{(1 - mr) \frac{dY}{dm}}{\left(r + m \frac{dr}{dm}\right) Y}$$
- Y ratio of moment of inertia about neutral axis of a solid profile to that of a hollow profile
- y_{cg} distance from root chord to spanwise center of gravity of wing panel
- y_{cp} distance from root chord to spanwise center of pressure
- Z wing-root-section modulus (moment of inertia of root section divided by greatest distance from neutral axis)
- α angle of attack
- δ density of wing material
- $$\eta = 1 - \frac{y_{cg}}{y_{cp}}$$
- σ_a maximum allowable stress

ANALYSIS

Outline of General Method

Two of the basic objectives in the preliminary design of missile wings are:

(1) The wing should produce as little drag as possible at the design Mach number, altitude, and load factor and with a given weight of airplane minus wing.

(2) The wing should have sufficient strength that the maximum allowable bending stress is not exceeded in flight at the maximum anticipated load factor.

At supersonic speeds, the drag of a wing increases rapidly with wing thickness. Also, the size of a supersonic wing is small compared with that of a low-speed wing of the same load carrying capacity if the wing is designed for flight at low or medium altitudes and at angles of attack near that for maximum lift-drag ratio. Achieving the minimum thickness ratio, therefore, is a primary consideration in designing a wing for least drag at supersonic speeds, while the wing weight is only of secondary importance (except in the case of wings designed for very high altitudes where low static pressures necessitate large wing sizes). For these reasons, the solidity of a supersonic wing is likely to be much greater than that of subsonic wings.

These considerations lead to certain simplifying assumptions that make possible a methodical selection of wing variables for the initial stage of preliminary design. Thus, for a supersonic wing of high solidity, it can be assumed that all the bending strength of the wing lies in the thick skin, that the wing weight is composed entirely of the skin, and that no useful load is carried inside the wing. These assumptions permit the use of simple expressions relating the simple beam bending stress developed in the wing, the wing weight, and the wing drag to the thickness ratio, chord, and hollowness ratio (defined in this paper as the ratio of the maximum thickness of the hollow part of the wing section to the over-all thickness of the section, fig. 1).

If the assumption is made that the fuselage contributes no lift, the lift developed by the wing at the design flight condition must equal the total airplane weight times the load factor. For a supersonic wing, since the wing is considered to carry none of the useful load internally, the total airplane weight is made up of a fixed weight (the design weight of the airplane minus wing) plus the variable wing weight.

The present paper considers the problem of selecting the thickness, hollowness, and size of a supersonic wing so that it meets the two basic

objectives. The plan form, profile shape, type of skin thickness distribution, and the material of the wing are assumed to have been previously selected, and the lift, drag, and spanwise center-of-pressure characteristics of the combination of plan form and profile shape are assumed to be known for various thickness ratios.

The problem is approached in this paper by considering how the drag varies as the thickness ratio is varied when the hollowness ratio and chord (size) are held constant. The drag of a supersonic wing of given hollowness ratio and chord can be divided into three parts: a thickness drag which increases approximately as the square of the thickness ratio, a drag due to lift which increases with thickness ratio (because of increasing wing weight), and a constant skin-friction drag. In order to satisfy the two basic objectives, therefore, the thickness ratio of the wing must be the smallest that is permitted by the second objective. By considering only the bending stresses, and by using the simple beam formula, an expression can be obtained for the minimum thickness ratio as a function of hollowness ratio and chord.

Next, by making use of linear theory and the expression for minimum thickness ratio mentioned previously, an equation can be written which gives the drag coefficient of the wing as a function of hollowness ratio and chord. A differentiation of this equation with respect to hollowness ratio permits evaluation of the hollowness ratio that satisfies the two basic objectives as a function of chord. In order to select the chord, the total wing drag calculated by using the previously obtained values of hollowness ratio and thickness ratio can be plotted against chord. By locating the least-drag point, the value of chord that satisfies the two basic objectives and the corresponding values of hollowness ratio and thickness ratio can be found. This graphical selection of the chord is relatively easy, whereas an analytical solution would be very difficult to obtain.

In case the value of chord is dictated by other considerations, the thickness and hollowness of the wing which satisfy the two basic objectives can still be determined by the foregoing procedure with the last step omitted.

Development of Method

Selection of thickness ratio for arbitrary hollowness ratio and chord. - For purposes of this analysis, a wing is considered sufficiently strong if the maximum bending stress at the root section given by the simple beam formula is at all times less than or equal to the maximum allowable stress. This assumption ignores additional stresses that are present, particularly in the case of swept wings; however, it may be possible to compensate to a certain extent for these effects by adjusting the maximum allowable stress. (Of course, additional criteria have a bearing on the structural integrity of a wing and would have to be considered in a final design.)

With this assumption, the thickness ratio satisfying the two basic objectives must be such as to give a wing-root section modulus of

$$Z = \frac{M_{B_{\max}}}{\sigma_a} \quad (1)$$

where $M_{B_{\max}}$ is the maximum bending moment anticipated, and σ_a is the maximum allowable stress.

The root-section modulus Z depends on the thickness ratio and chord of the root section and also on the hollowness of the wing. Figure 1 shows the general type of hollow wing section that is considered in this paper. The profile is of such shape that multiplication of all ordinates by a constant factor gives a new profile of the same shape but of different thickness ratio. (This condition is satisfied exactly by any profile made up of straight lines or arcs of parabolas having axes perpendicular to the chord; however, profiles made up of circular arcs approximate the condition quite well.) The hollow space has the same shape as the exterior profile but is not necessarily of the same thickness ratio. The ratio of the chordwise extent of the hollow space to the total wing chord is denoted by r , and is considered a function of the hollowness ratio m .

In order to simplify the present analysis, both m and r are held constant along the span. The spanwise variation of skin thickness, therefore, is determined by the variation of thickness ratio and chord along the span. For example, a rectangular wing of constant thickness ratio must have constant skin thickness. However, even with the restriction of constant values of m and r a rectangular wing can still be designed with equal bending stress at all spanwise stations by decreasing the thickness ratio and the skin thickness toward the tip.

For the general type of hollow wing section considered herein (fig. 1), the root-section modulus can be written

$$Z = k_1 \left(\frac{t}{c}\right)^2 c^3 Y \quad (2)$$

where

$$Y = \frac{1 + k_2(k_3^2 - 1)mr + 2(k_2 - 1)m^2r - k_2m^3r + m^4r^2}{1 - (1 - k_4 + k_5)mr + k_5m^2r}$$

k_1 , k_2 , k_3 , k_4 , and k_5 are constants depending only on the wing-section shape, t is the thickness, and c , the chord, respectively, of the root section. For profiles symmetrical about the chord, Y becomes

$$Y = 1 - m^3r$$

The bending moment about the root chord is caused partly by aerodynamic forces and partly by mass forces. The aerodynamic forces can be resolved into a normal force and a chordwise force, and the chordwise force further resolved into a drag component and a lift component. When the lift component of the chordwise force is neglected, the bending moment about the root chord is

$$M_B = \frac{y_{cp}(W_w + W_f)n}{2 \cos \alpha} - y_{cg} \frac{W_w}{2} n \cos \alpha$$

where y_{cp} and y_{cg} are the distances from the root chord to the spanwise center of pressure and center of gravity of the wing panel, respectively, W_w is the total weight of both wing panels, W_f is the weight of the airplane minus wing, n is the normal load factor, and α is the angle of attack. If y_{cp} is assumed to be independent of both the lift coefficient and the thickness ratio, and $\cos \alpha$ is assumed equal to unity, then the maximum bending moment is

$$M_{B_{max}} = \frac{1}{2} y_{cp} W_f n_{max} \left(1 + \eta \frac{W_w}{W_f} \right) \quad (3)$$

where n_{max} is the maximum load factor anticipated and $\eta = 1 - \frac{y_{cg}}{y_{cp}}$.

The value of W_w in equation (3) can be expressed in terms of the wing geometry. For wings having the general type of cross section shown in figure 1, the area of the solid part of the root cross section is

$$A_x = k_6 \frac{t}{c} c^2 (1 - mr)$$

where k_6 depends only on the profile shape. Then the volume of the solid part of one wing panel is

$$V = k_6 k_7 \frac{t}{c} \frac{h}{c} c^3 (1 - mr)$$

where k_7 is a constant depending only on the manner of variation of cross-sectional area along the span, and h is the wing semispan. The total weight of both wing panels is

$$W_w = 2k_6 k_7 \frac{h}{c} c^3 (1 - mr) \delta \frac{t}{c} \quad (4)$$

where δ is the density of the wing material.

Substituting equations (2), (3), and (4) into equation (1) and solving for t/c gives the minimum thickness ratio, in terms of chord and hollowness ratio, as

$$\frac{t}{c} = \frac{\frac{y_{cp}}{c} n_{\max} \eta k_6 k_7 \frac{h}{c} \delta c (1 - mr)}{2k_1 \sigma_a Y} + \sqrt{\left[\frac{\frac{y_{cp}}{c} n_{\max} \eta k_6 k_7 \frac{h}{c} \delta c (1 - mr)}{2k_1 \sigma_a Y} \right]^2 + \frac{\frac{y_{cp}}{c} W_f n_{\max}}{c^2 2k_1 \sigma_a Y}} \quad (5)$$

Selection of hollowness ratio for arbitrary chord. - The drag coefficient of a supersonic wing may be written, within the accuracy of the linear theory, as

$$C_D = A \left(\frac{t}{c} \right)^2 + BC_L^2 + C_{D_f} \quad (6)$$

where A and B are constants that depend only on the Mach number and the wing plan form and profile shape, and C_{D_f} is the skin-friction-drag coefficient. (Whether the linear theory gives in this same form the drag of a wing with spanwise variation of thickness ratio has not been determined.) The lift coefficient of the wing at design flight conditions is

$$C_L = \frac{n(W_w + W_f)}{qS} \quad (7)$$

where n and q are the load factor and dynamic pressure, respectively, at design flight conditions, and S is the total area of both wing panels.

Now an expression is needed for the wing weight with hollowness ratio and chord as the only variables. This expression can be obtained by combining equations (4) and (5) to give

$$W_w = \frac{N^2 W_f \eta}{2} \left[\frac{(1 - mr)^2}{Y} + \sqrt{\frac{(1 - mr)^4}{Y^2} + \frac{4(1 - mr)^2}{N^2 \eta^2 Y}} \right] \quad (8)$$

where

$$N \equiv 2k_6 k_7 \frac{h}{c} \delta c^2 \sqrt{\frac{y_{cp} n_{max}}{2k_1 \sigma_a W_f}} \quad (9)$$

If η equals zero, equation (8) becomes

$$W_w = N W_f \frac{1 - mr}{\sqrt{Y}} \quad (10)$$

Thus N is the ratio of the weight of a solid wing of thickness given by equation (5), calculated by assuming η equals zero, to the weight of the airplane minus wing. (For a solid wing Y equals unity.)

Combining equations (5) to (9) gives the drag coefficient in terms of hollowness ratio and chord as

$$C_D = \frac{B W_f^2 N^2}{\left(\frac{q}{n}\right)^2 \left(\frac{s}{c^2}\right)^2 c^4} \left\{ \frac{(1 + \eta)(1 - mr)^2}{Y} + \frac{N^2 \eta^2 (1 - mr)^4}{2Y^2} + \frac{1}{N^2} + \right. \\ \left. \frac{P N^2 \eta^2}{2} \left[\frac{(1 - mr)^2}{Y^2} + \frac{2}{N^2 \eta^2 Y} + \frac{1}{Y} \sqrt{\frac{(1 - mr)^4}{Y^2} + \frac{4(1 - mr)^2}{N^2 \eta^2 Y}} \right] + \right. \\ \left. \left[\eta + \frac{N^2 \eta^2 (1 - mr)^2}{2Y} \right] \sqrt{\frac{(1 - mr)^4}{Y^2} + \frac{4(1 - mr)^2}{N^2 \eta^2 Y}} \right\} + C_{Df} \quad (11)$$

where

$$P \equiv \frac{A}{B} \left(\frac{\frac{s}{c^2} \frac{q}{n}}{2k_6 k_7 \frac{h}{c} \delta c} \right)^2 \quad (12)$$

The quantity P can be shown to equal the ratio of the thickness drag to the drag due to lifting only the wing weight multiplied by the load factor for a solid wing of given chord.

Differentiating equation (11) with respect to m gives

$$\frac{\partial C_D}{\partial m} = - \frac{BW_f^2 N^2 \left(r + m \frac{dr}{dm} \right) Q}{\left(\frac{q}{h} \right)^2 \left(\frac{s}{c^2} \right)^2 c^4 Y \sqrt{(1 - mr)^2 + \frac{4Y}{N^2 \eta^2}}} \quad (13)$$

where

$$Q \equiv P \left\{ \left[\frac{N^2 \eta^2 (1 - mr)(X + 1)}{Y} + \frac{X}{1 - mr} \right] \sqrt{(1 - mr)^2 + \frac{4Y}{N^2 \eta^2}} + \frac{(1 - mr)^2 (X + 1) N^2 \eta^2}{Y} + 3X + 2 \right\} + (X + 2) \left\{ \left[(1 + \eta)(1 - mr) + \frac{N^2 \eta^2 (1 - mr)^3}{Y} \right] \sqrt{(1 - mr)^2 + \frac{4Y}{N^2 \eta^2}} + \frac{N^2 \eta^2 (1 - mr)^4}{Y} + \frac{2Y}{N^2 \eta} + (3 + \eta)(1 - mr)^2 \right\}$$

and

$$X \equiv \frac{(1 - mr) \frac{dY}{dm}}{\left(r + m \frac{dr}{dm} \right) Y}$$

Equation (13) gives the slope $\partial C_D / \partial m$ of the curve of C_D against m. If $\partial C_D / \partial m$ is set equal to zero, the equation defines the values of m at which slope is zero. For the simpler cases the value of m obtained by setting Q equal to zero can be shown to give the minimum point on the curve of C_D against m.

Thus for a given chord, the hollowess ratio satisfying the two basic objectives can be found, since P , N , and η have been previously determined, and Y and r are known as functions of m , from

$$PN = - \frac{(1-mr)^5 \left[\frac{1+\eta}{(1-mr)^3} + \frac{N^2\eta^2}{Y(1-mr)} \right] \sqrt{(1-mr)^2 + \frac{4Y}{N^2\eta^2} + \frac{N^2\eta^2}{Y}} + \frac{2Y}{N^2\eta(1-mr)^4} + \frac{3+\eta}{(1-mr)^2}}{\left[\frac{N\eta^2(1-mr)^2(X+1)}{Y(X+2)} + \frac{X}{N(X+2)} \right] \sqrt{(1-mr)^2 + \frac{4Y}{N^2\eta^2} + \frac{(1-mr)^3(X+1)N^2\eta^2}{Y(X+2)}} + \frac{(1-mr)(3X+2)}{X+2}} \quad (14)$$

For η equal to zero, this equation becomes

$$PN = - \frac{X+2}{X} (1-mr) (N(1-mr) + \sqrt{Y}) \quad (15)$$

Equation (14) is plotted in figure 2 for wing sections symmetrical about the chord, for $r = m$ and $\eta = 0.25$. The type of hollow construction determined by $r = m$ gives uniform skin thickness for a symmetrical double-wedge profile.

Selection of chord. - Equations (5) and (14) define the values of thickness and hollowess, that satisfy the two basic objectives, for arbitrary chord. Now in order to select the chord, the drag of wings having thickness and hollowess given by these equations can be computed and plotted as a function of chord. The minimum drag point on this plot locates the value of chord satisfying the two basic objectives.

Procedure for Use of General Method

A general procedure for selecting the thickness ratio, hollowness ratio, and chord satisfying the two basic objectives can now be outlined as follows:

(1) Select the design Mach number, altitude, maximum and design load factors, type of wing hollowness, weight of airplane minus wing, and also the wing plan form, profile shape, material, and maximum allowable bending stress. The lift-drag curves for wings of various thickness ratios and chords, having the plan form and profile shape chosen, must be known, as well as the spanwise center-of-pressure distance.

(2) Assume a value of wing chord. (Approximate methods presented subsequently can serve as a guide in the choice of chord. In case it may be desired to find only the thickness and hollowness ratios satisfying the two basic objectives for a given value of the wing chord, that value may be used here.)

(3) Calculate N and NP from equations (9) and (12).

(4) Read hollowness ratio m from figure 2, or a similar plot for the particular η and relation between Y , r , and m considered.

(5) Calculate W_w and C_L from equations (8) and (7), respectively, and t/c from

$$\frac{t}{c} = \frac{1}{c} \sqrt{\frac{y_{cp}}{c} W_F n_{max} \left(1 + \eta \frac{W_w}{W_F} \right)}{2k_1 \sigma_a Y} \quad (16)$$

which is equivalent to equation (5).

(6) Obtain the value of C_D corresponding to the calculated thickness ratio and C_L , either from linear theory, higher-order theory, or experiment, as desired.

(7) Calculate the wing drag from

$$D_w = C_{Dq} \frac{S}{c^2} c^2 \quad (17)$$

(8) Repeat steps (2) to (7) for other wing chords. Plot the values of D_w obtained against c , and determine the minimum point on the curve faired through these points. The values of thickness ratio, hollowness ratio, and chord at this point are the values satisfying the two basic objectives, for the given wing plan form, profile shape, and material.

(9) Repeat steps (1) to (8) for other plan forms, profile shapes, and materials, if desired.

Approximate Methods

In some cases it seems likely that the general method could be modified by the introduction of further simplifying assumptions, without appreciably affecting the validity of the results. In the following analysis three approximate methods are developed.

Approximate method I ($\eta = 0$).— The assumption that η equals zero brings about an appreciable simplification of the general method, as has already been seen in equations (10) and (15). By carrying out the differentiation with respect to chord, instead of hollowness ratio, a simple equation results for the drag of a wing of arbitrary hollowness ratio, with thickness ratio and chord chosen to satisfy the two basic objectives. This equation can be differentiated with respect to hollowness ratio so that the three wing variables can be determined without recourse to the trial-and-error procedure of the general method.

With the assumption that $\eta = 0$, the wing drag becomes, from equation (11),

$$D_w = \frac{Bn^2W_f^2}{q \frac{S}{c^2}} \frac{N}{c^2} \left[\frac{PN}{Y} + \frac{1}{\frac{N}{c^2}} + \frac{N}{c^2} \frac{(1 - mr)^2 c^2}{Y} + \frac{2(1 - mr)}{\sqrt{Y}} \right] + C_{D_f} q \frac{S}{c^2} c^2 \quad (18)$$

When this equation is differentiated with respect to c and the derivative set equal to zero, the value of chord satisfying the two basic objectives, for arbitrary hollowness ratio, is obtained as

$$c^2 = \frac{1}{\frac{N}{c^2} \sqrt{\frac{(1 - mr)^2}{Y} + R}} \quad (19)$$

where

$$R \equiv \frac{C_{D_f}}{B} \left(\frac{q \frac{S}{c^2}}{nW_f \frac{N}{c^2}} \right)^2 \quad (20)$$

(The quantity R is the ratio of the skin-friction drag to the drag due to lifting only the wing weight, for a solid wing of minimum thickness, when $\eta = 0$ is assumed.) Upon combining equations (18) and (19) there results

$$D_w = \frac{Bn^2 W_f^2}{q \frac{S}{c^2}} \frac{N}{c^2} \left[\frac{PN}{Y} + 2 \sqrt{\frac{(1 - mr)^2}{Y} + R} + 2 \frac{(1 - mr)}{\sqrt{Y}} \right] \quad (21)$$

Equation (21) gives the drag of a wing of arbitrary hollowness ratio, having thickness ratio and chord chosen to satisfy the two basic objectives.

Differentiation of equation (21) yields

$$\frac{\partial D_w}{\partial m} = - \frac{Bn^2 W_f^2}{q \frac{S}{c^2}} \frac{N}{c^2} \frac{r + m \frac{dr}{dm}}{Y} \left[\frac{PNX}{1 - mr} + \frac{(1 - mr)(X + 2)}{\sqrt{\frac{(1 - mr)^2}{Y} + R}} + \sqrt{Y} (X + 2) \right]$$

When $\frac{\partial D_w}{\partial m}$ is set equal to zero, there are two possible roots. However, the root obtained by setting $r + m \frac{dr}{dm}$ equal to zero merely corresponds to a local maximum at $m = 0$. Therefore, the hollowness ratio satisfying the two basic objectives may be found, since PN and R have been previously determined and Y and r are known as functions of m , from

$$PN = - \frac{X + 2}{X} (1 - mr) \left[\frac{1 - mr}{\sqrt{\frac{(1 - mr)^2}{Y} + R}} + \sqrt{Y} \right] \quad (22)$$

For the special case where $r = m$ and the wing section is symmetrical about the chord line, equation (22) becomes

$$PN = \frac{1 - m^2}{m^2} \left[\frac{1 - m^2}{\sqrt{\frac{(1 - m^2)^2}{1 - m^4} + R}} + \sqrt{1 - m^4} \right] \quad (23)$$

Equation (23) is plotted in figure 3.

The procedure for using approximate method I is summarized as follows:

(1) Calculate NP and R from equations (9), (12), and (20), with values of A , B , C_{Df} , and y_{cp}/c determined either from theory or experiment.

(2) Read hollowness ratio m from figure 3, or a similar plot of equation (22) for the particular type of wing cross section considered.

(3) Calculate the wing chord and thickness ratio from equations (19) and (16), respectively.

(4) Calculate the drag of the resulting wing with thickness ratio, hollowness ratio, and chord chosen to satisfy the two basic objectives, from equation (21).

Approximate method II ($m = 0$).— In some cases the weight of a supersonic wing would probably be only a small fraction of the total airplane weight. In such cases, the saving in drag possible through hollowing the wing would be negligible. With the assumption of zero hollowness ratio, the chord and thickness ratio that satisfy the two basic objectives become (from equations (19) and (16), with $\eta = 0$)

$$c^2 = \frac{1}{\frac{N}{c^2} \sqrt{1 + R}} \quad (24)$$

$$\frac{t}{c} = \frac{1}{c} \sqrt{\frac{y_{cp}}{c} \frac{W_f n_{max}}{2k_1 \sigma_a}} \quad (25)$$

The drag of a wing having these values of thickness and chord is, from equation (21),

$$D_w = \frac{Bn^2 W_f^2}{q \frac{S}{c^2}} \frac{N}{c^2} (PN + 2\sqrt{1 + R} + 2) \quad (26)$$

Approximate method III ($W_w = 0$).— The analysis can be further simplified by assuming that the wing weight can be neglected entirely. Then equations (6), (7), and (16) combine to give the nondimensional

wing drag parameter D_w/nW_f (which, for this approximation, is merely the inverse of the lift-drag ratio, since the wing weight is neglected) as

$$\frac{D_w}{nW_f} = \frac{C_D}{C_L} = \frac{\frac{S}{c^2} \frac{y_{cp}}{c} A}{2k_1} \frac{qn_{\max}}{\sigma_a n} + BC_L + \frac{C_{D_f}}{C_L} \quad (27)$$

Differentiating this equation with respect to C_L and setting the derivative equal to zero gives the lift coefficient at which D_w/nW_f is a minimum as

$$C_L^2 = \frac{C_{D_f}}{B} \quad (28)$$

Then the drag of wings having values of thickness ratio and chord that satisfy the two basic objectives is found by substituting equation (28) into equation (27) to give

$$\frac{D_w}{nW_f} = \frac{\frac{S}{c^2} \frac{y_{cp}}{c} A}{2k_1} \frac{qn_{\max}}{\sigma_a n} + 2\sqrt{C_{D_f} B} \quad (29)$$

Equation (29) describes the lifting efficiency at design flight conditions of the given combination of plan form and profile shape for all cases in which the weight of the wing can be neglected. With equation (29), the efficiency of wings having various combinations of plan form and profile shape can be compared as a function of the single design parameter $qn_{\max}/\sigma_a n$ and the Mach number, as long as the wing weight is negligible. Such a comparison could be of use to the designer in making a compromise between lifting efficiency and other requirements of a particular design.

It should be observed that the maximum lift-drag ratio L/D for wings of given bending strength occurs at a value of C_L (see equation (28)) smaller than that corresponding to the maximum L/D for a given t/c , which is

$$C_L^2 = \frac{A}{B} \left(\frac{t}{c}\right)^2 + \frac{C_{D_f}}{B}$$

To see the reason for this difference, consider how the strength of a wing varies with chord, for a constant value of t/c . For a wing

supporting a given load, the bending moment is proportional to the chord (when a constant plan form is assumed). The section modulus is proportional to the cube of the chord. Thus the bending stress given by the simple beam formula is inversely proportional to the square of the chord, and therefore directly proportional to the design lift coefficient C_L . Now as the design C_L is made to approach the value for maximum L/D for a given t/c , the increase in L/D associated with an incremental change in C_L approaches zero, whereas the bending stress continues to increase in proportion to C_L . Thus, the last small increment in C_L before the C_L for maximum L/D is reached gives an insignificant increase in L/D at the expense of a finite increase in the bending stress. Hence, in order to obtain maximum L/D for a given bending stress, it is better to use a design C_L smaller than that for maximum L/D at a given t/c and go to a smaller t/c , thus a finite increase in L/D along with the finite increase in bending stress is obtained. As an example, the maximum L/D at Mach number 2.0 of a 10-percent-thick diamond wing of the type described subsequently is 4.44. However, a 6.5-percent-thick diamond wing operating at a smaller C_L where the same bending stress is developed gives an L/D of 5.34. The maximum L/D of the 6.5-percent-thick wing is 6.14, but the wing is not strong enough to go to its maximum L/D without exceeding the assumed stress.

It is of interest to note that equation (29) can be written as

$$\frac{D_w}{nW_f} = \frac{\overline{AR}^2(1 + \lambda)^3 \frac{y_{cp}}{h} A}{32k_1} \frac{q_{n_{max}}}{\sigma_a n} + 2\sqrt{C_{D_f} B}$$

where \overline{AR} is the aspect ratio and λ is the taper ratio (ratio of tip chord to root chord). Now variations in \overline{AR} and λ are accompanied by relatively small changes in A , B , and y_{cp}/h as long as the leading and trailing edges are supersonic and if the tip disturbance from one wing does not influence the other. It appears, therefore, that a supersonic wing designed for least drag should have zero taper ratio and a small aspect ratio, at least for Mach numbers appreciably exceeding unity.

EXAMPLE

In order to illustrate the foregoing methods and to show the relative importance of the various factors in a typical case, the process of selecting the thickness, hollowness, and size of a diamond wing to satisfy the two basic objectives for a range of design flight conditions

at Mach number 2.0 is described. The plan form chosen for this example has an aspect ratio of 4.0 and the profile is a symmetrical double wedge. (See fig. 4.)

For the diamond wing considered, the geometric constants required for the analysis are

$$k_1 = \frac{1}{24}$$

$$k_2 = 1$$

$$k_3 = k_4 = k_5 = 0$$

$$k_6 = \frac{1}{2}$$

$$k_7 = \frac{1}{3}$$

$$\frac{h}{c} = 1$$

$$\frac{S}{c^2} = 1$$

$$\frac{y_{cg}}{c} = \frac{1}{4}$$

The relation $r = m$, which gives uniform skin thickness for the double-wedge profile, is used. (Of course, the skin thickness will decrease linearly to zero at the wing tip, since m is assumed to be constant along the span.)

The lift-drag polars of the diamond wing are given by linear theory as

$$C_D = 2.37\left(\frac{t}{c}\right)^2 + 0.445(C_L)^2 + 0.005 \quad (30)$$

where a skin-friction-drag coefficient of 0.005 has been arbitrarily assumed. (While this value cannot be correct at all the Reynolds numbers occurring in the example, it is believed that use of a skin-friction coefficient varying with Reynolds number would have little

effect on the comparisons presented here.) Linear theory gives the spanwise center-of-pressure distance as

$$\frac{y_{cp}}{c} = 0.347$$

In order to illustrate the application of the general method, consider the problem of selecting the thickness, hollowness, and size of the diamond wing described previously to satisfy the two basic objectives for the following design conditions:

$$M = 2.0$$

$$\sigma_a = 40,000 \text{ pounds per square inch}$$

$$W_f = 50,000 \text{ pounds}$$

$$\delta = 0.1 \text{ pound per cubic inch (aluminum)}$$

$$q = 18.9 \text{ pounds per square inch (approx. 20,000-ft altitude)}$$

$$n_{max} = 8$$

$$n = 1$$

An approximate value of the chord satisfying the two basic objectives can be obtained from equation (24) with N set equal to zero (which corresponds to neglecting the wing weight). Equation (24) becomes

$$c^2 = \frac{nW_f}{q \frac{S}{c^2}} \sqrt{\frac{B}{C_{Df}}}$$

and the approximate chord is found to be 158 inches. For this chord, the values of N and PN are calculated from equations (9) and (12). Thus

$$N = 0.107$$

$$PN = 7.35$$

From figure 2, the hollowness ratio for a chord of 158 inches, corresponding to $N = 0.107$ and $PN = 7.35$, is determined to be 0.372. Then substitution in equations (7), (8), and (16) gives

$$W_w = 4730 \text{ pounds}$$

$$\frac{t}{c} = 0.0414$$

$$C_L = 0.116$$

From equation (30) the wing drag coefficient is found to be 0.0151, which, when substituted into equation (17), gives a wing drag of 7100 pounds.

The foregoing procedure must be carried out for several other values of the chord in the neighborhood of 158 inches. From the resulting curve of wing drag against chord, shown to a small scale in figure 5, the optimum chord for the given conditions can be seen to be about 158 inches. Thus for the given conditions, a chord of 158 inches, a hollowness ratio of 0.372, and a thickness-chord ratio of 0.0414 satisfy the two basic design objectives.

The process of selecting thickness, hollowness, and size may be carried out in like manner for other design conditions. Figure 6 shows a plot of the drag parameter D_w/nW_F of diamond wings having values of thickness ratio, hollowness ratio, and chord chosen to satisfy the two basic objectives calculated by the general method and also by the three approximate methods, for a range of design conditions.

Figures 7, 8, and 9 present the chords, hollowness ratios, and thickness ratios, respectively, as functions of altitude. These figures show, for any altitude, the chord, the hollowness ratio, and the thickness ratio that satisfy the two basic objectives.

DISCUSSION

Figure 6 compares the drag of diamond wings at various design flight conditions calculated by the general method and also by the three approximate methods. Approximate method I, in which η is assumed equal to zero, appears to give a good approximation to the general method, even at the higher altitudes. Approximate methods II and III agree reasonably well with the general method at low design altitudes, but diverge greatly from the general method at high altitudes. The

agreement of approximate methods II and III becomes better as the airplane weight is decreased or as the ratio of allowable bending stress to maximum anticipated load factor is increased.

The difference between the values of wing drag calculated by approximate methods II and III depends on the ratio of wing weight to the weight of the rest of the airplane, W_w/W_f . The wing weight increases as the design altitude of the wing is increased, since larger wing sizes are required at the higher altitudes. Also, decreasing σ_a/n_{\max} increases the wing weight by requiring a greater thickness ratio for sufficient strength. The ratio W_w/W_f also increases with W_f . Thus, the difference between the two methods increases with altitude and is greater at the higher value of W_f and/or lower value of σ_a/n_{\max} , as shown in figure 6.

Figure 7 shows how the chord selected by the general and approximate methods increases as the design altitude is increased, so that the wing will remain at an angle of attack corresponding to the efficient part of the lift-drag polar. However, in the case of the solid wing (approximate method II) at $W_f = 50,000$ pounds, the wing weight at high altitudes is so great that the least drag is obtained by making the wing smaller than in the other cases and flying at an angle of attack beyond the range for greatest lift-drag ratio.

Values of hollowness ratio chosen to satisfy the two basic objectives are shown in figure 8 as a function of design altitude, for two values of W_f . At low altitudes the wing size is small, and the wing weight is a small fraction of total airplane weight; therefore, a high solidity, which reduces the thickness drag, can be used without greatly affecting the airplane weight. On the other hand, at high altitudes the wing weight is large and a large amount of hollowness is required. At the lower value of W_f the wing weight is a smaller fraction of W_f , and consequently the hollowness ratios are smaller.

Figure 9 shows values of the thickness ratio chosen to satisfy the two basic objectives. The increase in wing chord with increasing altitude noted in figure 7 allows the thickness ratios of solid wings (approximate methods II and III) to be decreased at the higher altitudes without exceeding the limiting stress. For wings with hollowness selected by the general method or approximate method I, the large amounts of hollowness required at high altitudes prevent the thickness ratio from being as low as for solid wings.

Figure 10 compares the drag of aluminum and steel wings calculated by the general method for the same design conditions, the maximum allowable stress for steel being assumed to be exactly twice that of aluminum.

For low and medium altitudes (where dynamic pressure and wing loading are high), steel wings appear to be superior to aluminum ones, especially if alloy steels more than twice as strong as aluminum are used; whereas, for high altitudes, the reverse appears to be true. (Steel wings also have other advantages in connection with strength at high temperatures, stiffness, and so forth.)

Figures 5, 11, 12, and 13 illustrate the effect on the drag of diamond wings of an arbitrary choice of chord, wing loading, hollowness ratio, or thickness ratio, respectively. In each of these figures one of the variables (chord (wing loading), hollowness ratio, or thickness ratio) is chosen arbitrarily, and the other two are then selected to satisfy the two basic objectives. Figure 5, showing arbitrary chord, was obtained by the general method. The other three figures were obtained by methods similar to the general method. These figures show that a considerable penalty in drag at design flight conditions may result if a value of chord, wing loading, hollowness ratio, or thickness ratio appreciably different from that given by the present method is used.

It should be noted that the present analysis does not allow for the weight of internal bracing and stiffeners that would be necessary in cases where the hollowness ratio is large. For this reason, the curve in figure 6(a) calculated by the general method probably indicates lower drag values for high altitudes than could actually be obtained.

In deriving the present method, the spanwise distance to the center of pressure y_{cp} was assumed to be constant for wings of given plan form and profile shape; however, in practice y_{cp} may vary with angle of attack. In such a case the value of y_{cp} corresponding to n_{max} would have to be used.

CONCLUSIONS

A method suitable for use in the first stage of preliminary supersonic missile wing design has been devised. The method enables the analytical selection of the thickness, hollowness, and size of a supersonic wing of given plan form and profile shape, having known aerodynamic characteristics, such that the wing will have least drag at specified flight conditions and yet retain sufficient bending strength. From an application of this method to a diamond wing at Mach number 2.0, the following conclusions can be drawn:

1. The values of thickness, hollowness, and size of a supersonic wing that give least drag at specified flight conditions depend to a marked extent on the particular flight conditions.

2. Over a certain range of specified flight conditions, the general method of selecting thickness, hollowness, and size of supersonic wings for least drag presented in this paper can be replaced by simpler approximate methods with little loss in accuracy. One of these approximate methods, which neglects wing weight, gives the best lift-drag ratio of a given combination of plan form and profile shape at a given Mach number as a function of a single design parameter.

3. For supersonic flight at low altitudes, steel wings appear to offer a reduction in drag over that of aluminum wings; whereas, for high altitudes, the reverse appears to be true.

4. Wings with thickness ratios, hollowness ratios, or chords appreciably different from those obtained by the present method may have considerably higher drags.

Langley Aeronautical Laboratory
National Advisory Committee for Aeronautics
Langley Field, Va., June 6, 1951

REFERENCE

1. Jones, Robert T.: Estimated Lift-Drag Ratios at Supersonic Speed. NACA TN 1350, 1947.

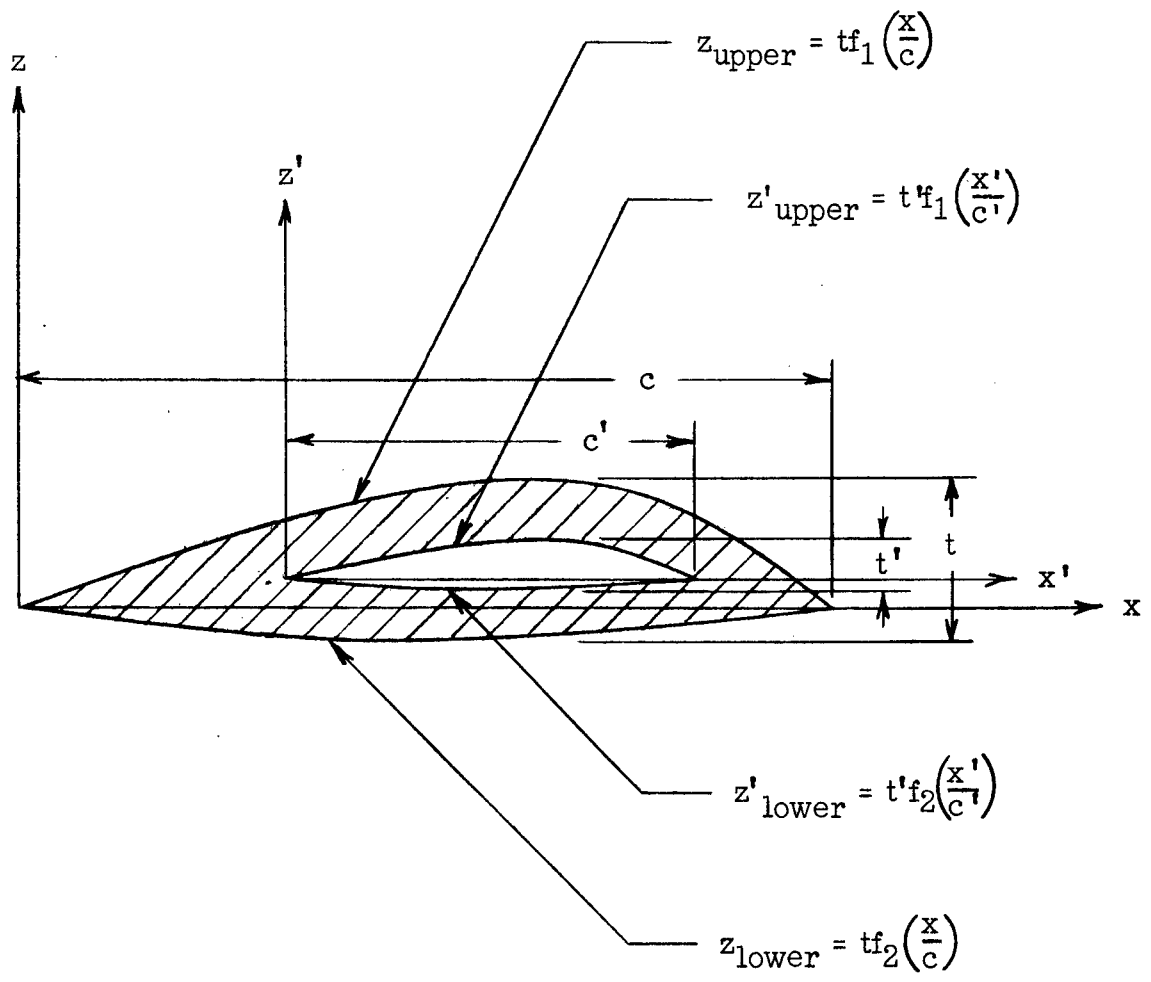

Figure 1.- General type of hollow wing section. $\frac{t'}{t} \equiv m$ (hollowness ratio);
 $\frac{c'}{c} \equiv r$.

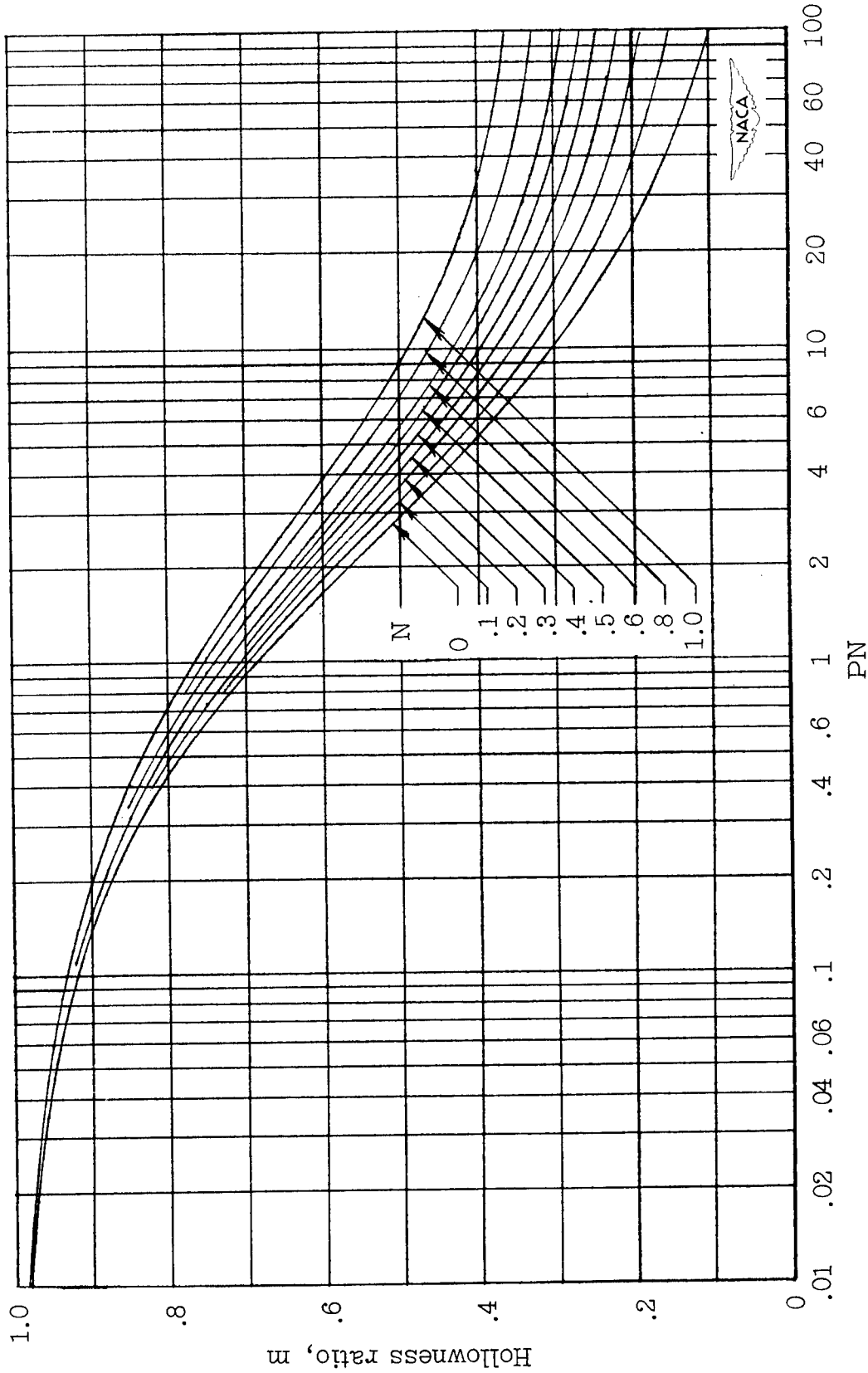

Figure 2.- Hollowness ratio determined by general method. Wing sections symmetrical about chord; $r = m$; $\eta = 0.25$. (See equation (14).)

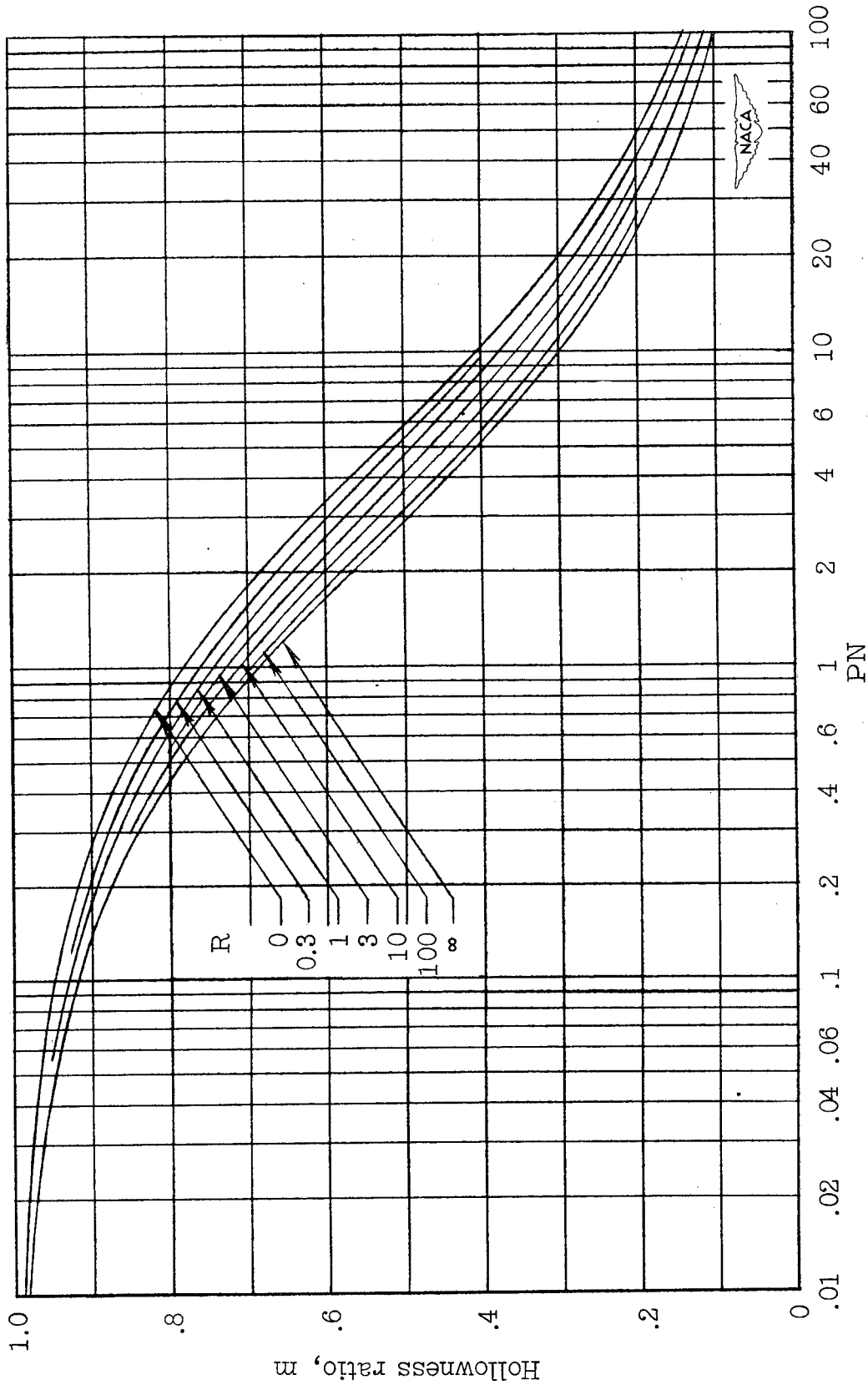

Figure 3.- Hollowness ratio determined by approximate method I ($\eta = 0$).
Wing sections symmetrical about chord; $r = m$. (See equation (23).)

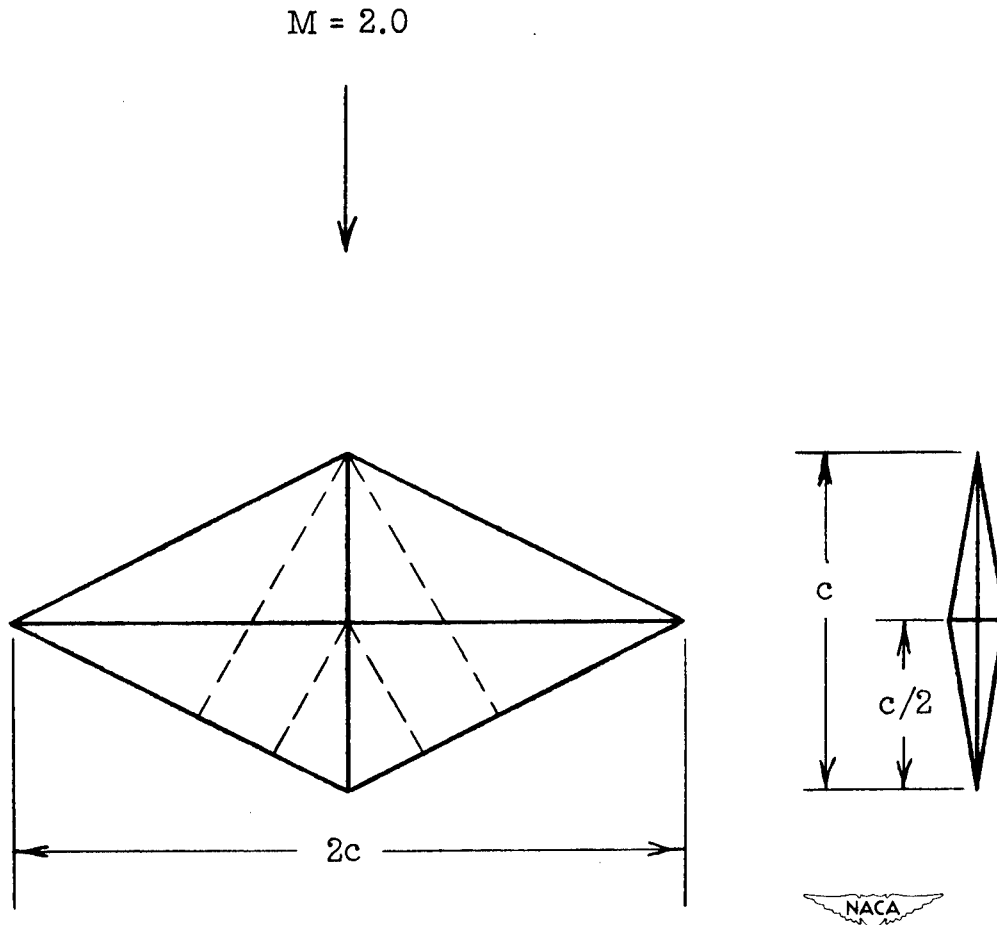

Figure 4.- Diamond wing considered in example.

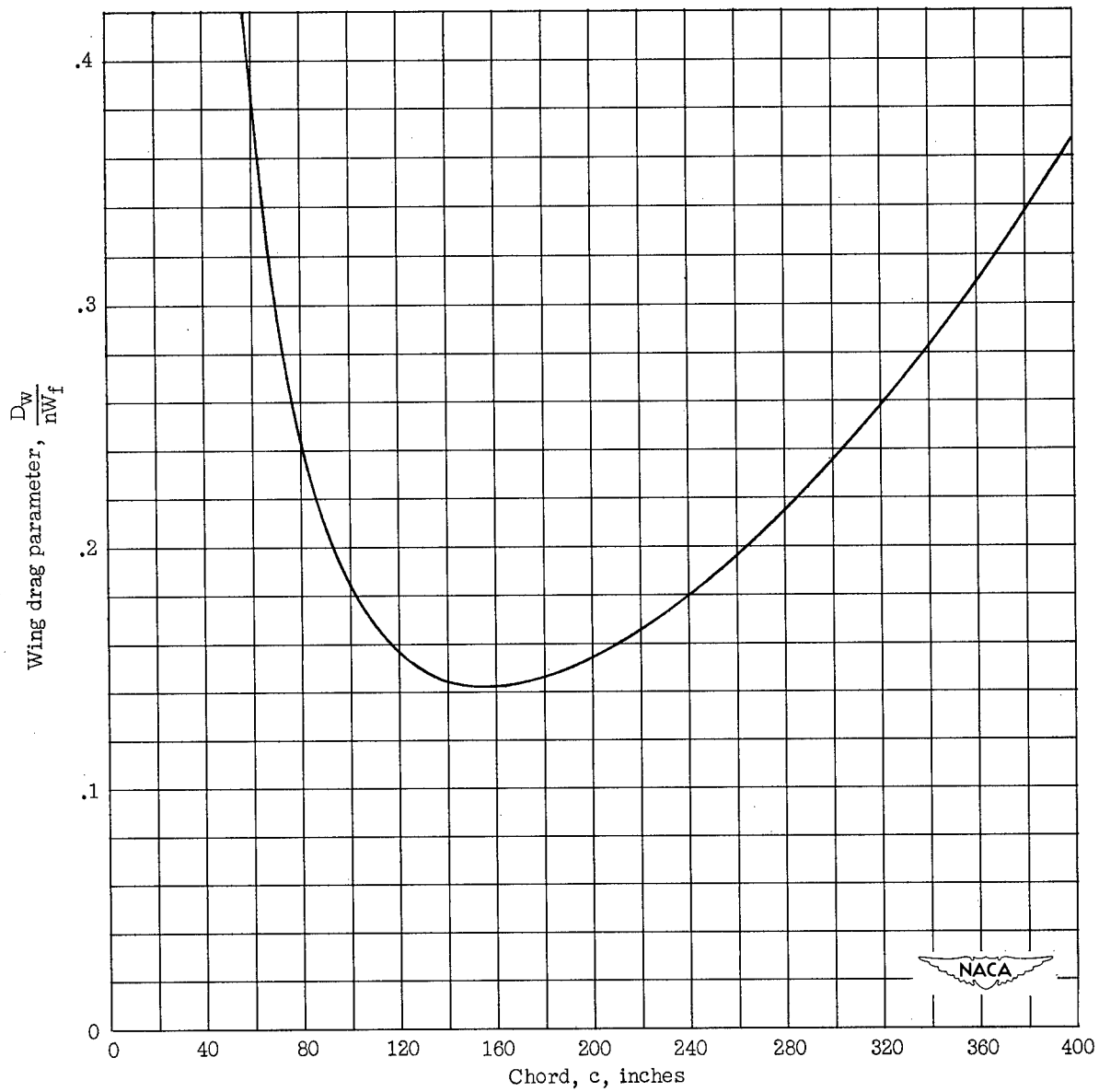
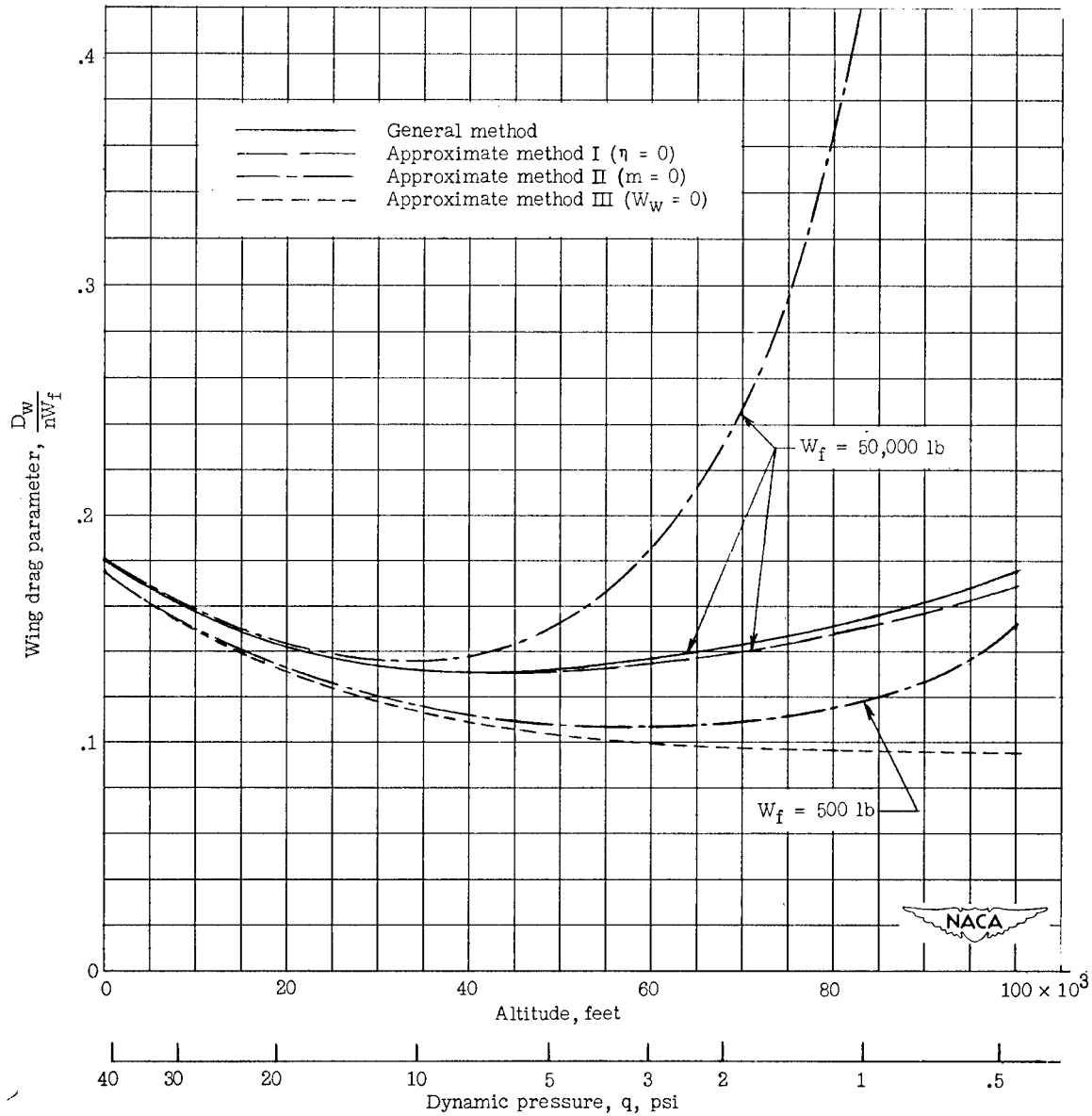
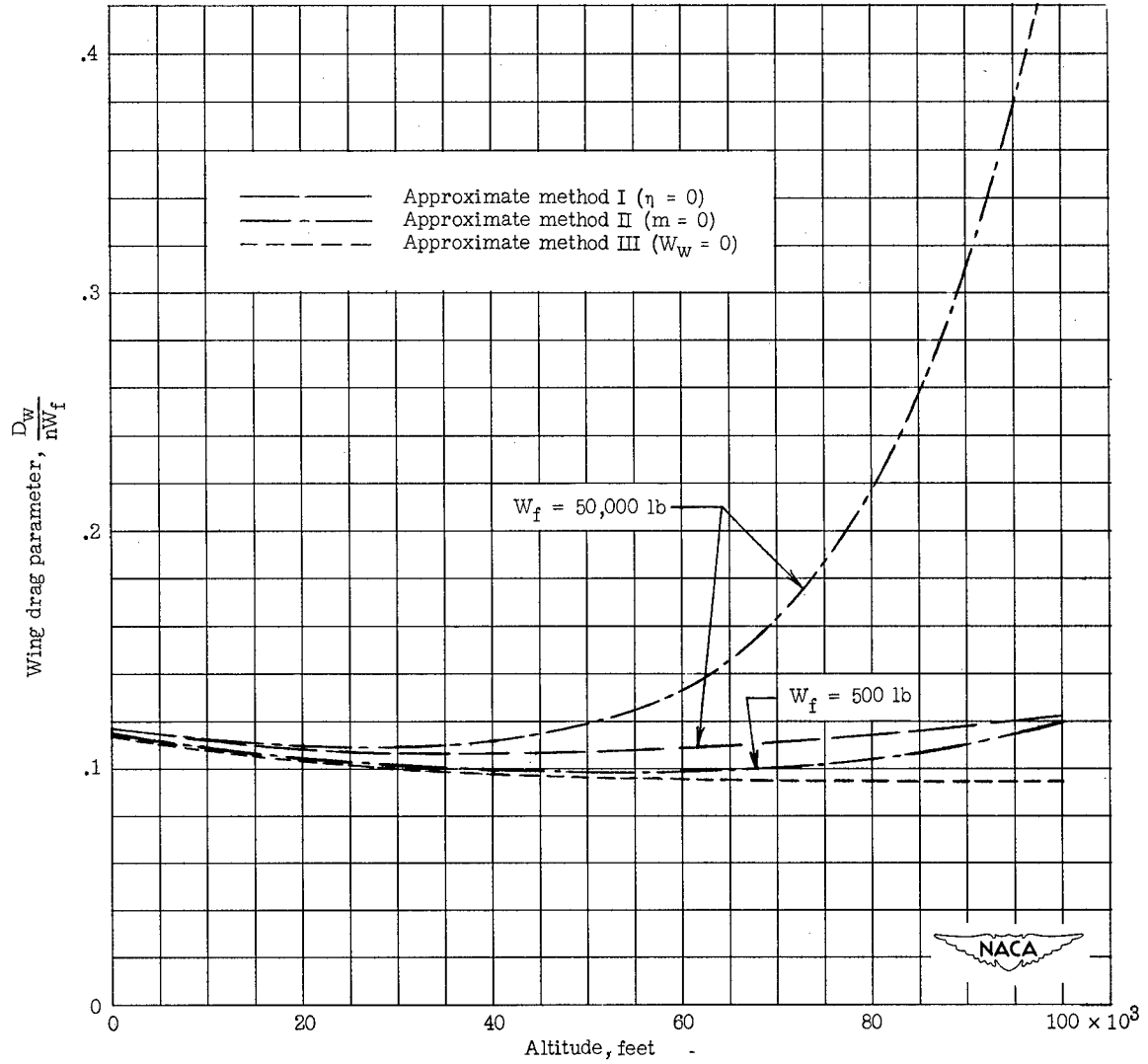

Figure 5.- Drag of diamond wings of arbitrary chord, having thickness and hollowness ratios chosen to satisfy the two basic objectives. General method. $W_f = 50,000$ pounds; $q = 18.9$ pounds per square inch (20,000 ft altitude); $\frac{\sigma_a}{n_{max}} = 5,000$ pounds per square inch. Double-wedge profile; aspect ratio, 4.0; Mach number, 2.0; aluminum wings; $r = m$; $C_{D_f} = 0.005$; $n = 1$.



(a) $\frac{\sigma_a}{n_{max}} = 5,000$ pounds per square inch.

Figure 6.- Drag of diamond wings having thickness ratios, hollowness ratios, and chords chosen to satisfy the two basic objectives. Double-wedge profile; aspect ratio, 4.0; Mach number, 2.0; aluminum wings; $r = m$; $C_{Df} = 0.005$; $n = 1$.



(b) $\frac{\sigma_a}{n_{max}} = 20,000$ pounds per square inch.

Figure 6.- Concluded.

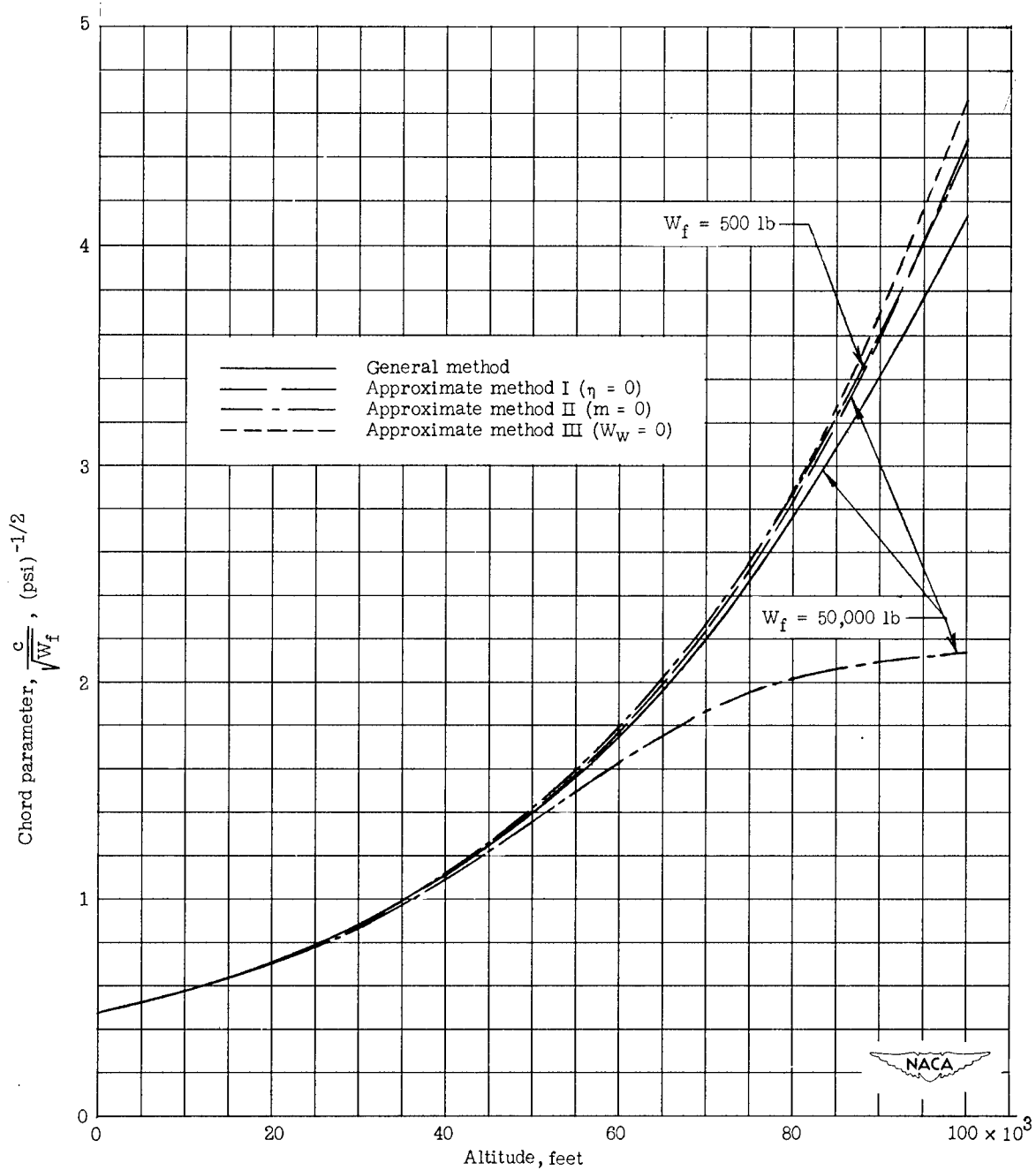

Figure 7.- Chord of diamond wings. $\frac{\sigma_a}{n_{\max}} = 5,000$ pounds per square inch; double-wedge profile; aspect ratio, 4.0; Mach number, 2.0; aluminum wings; $r = m$; $C_{D_f} = 0.005$; $n = 1$.

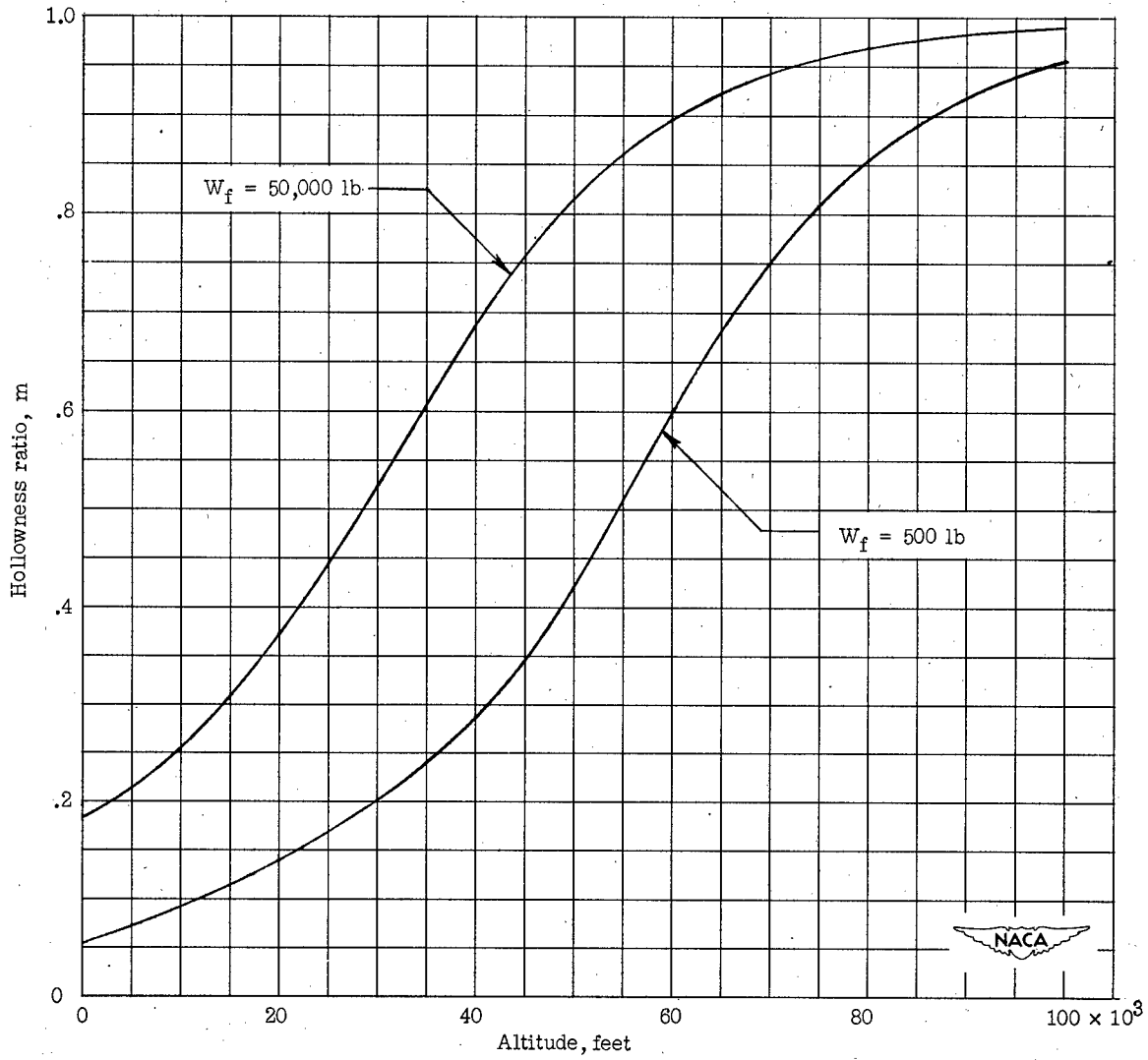

Figure 8.- Hollowness ratio of diamond wings. General method and approximate method I ($\eta = 0$). $\frac{\sigma_a}{n_{max}} = 5,000$ pounds per square inch; double-wedge profile; aspect ratio, 4.0; Mach number, 2.0; aluminum wings; $r = m$; $C_{D_f} = 0.005$; $n = 1$.

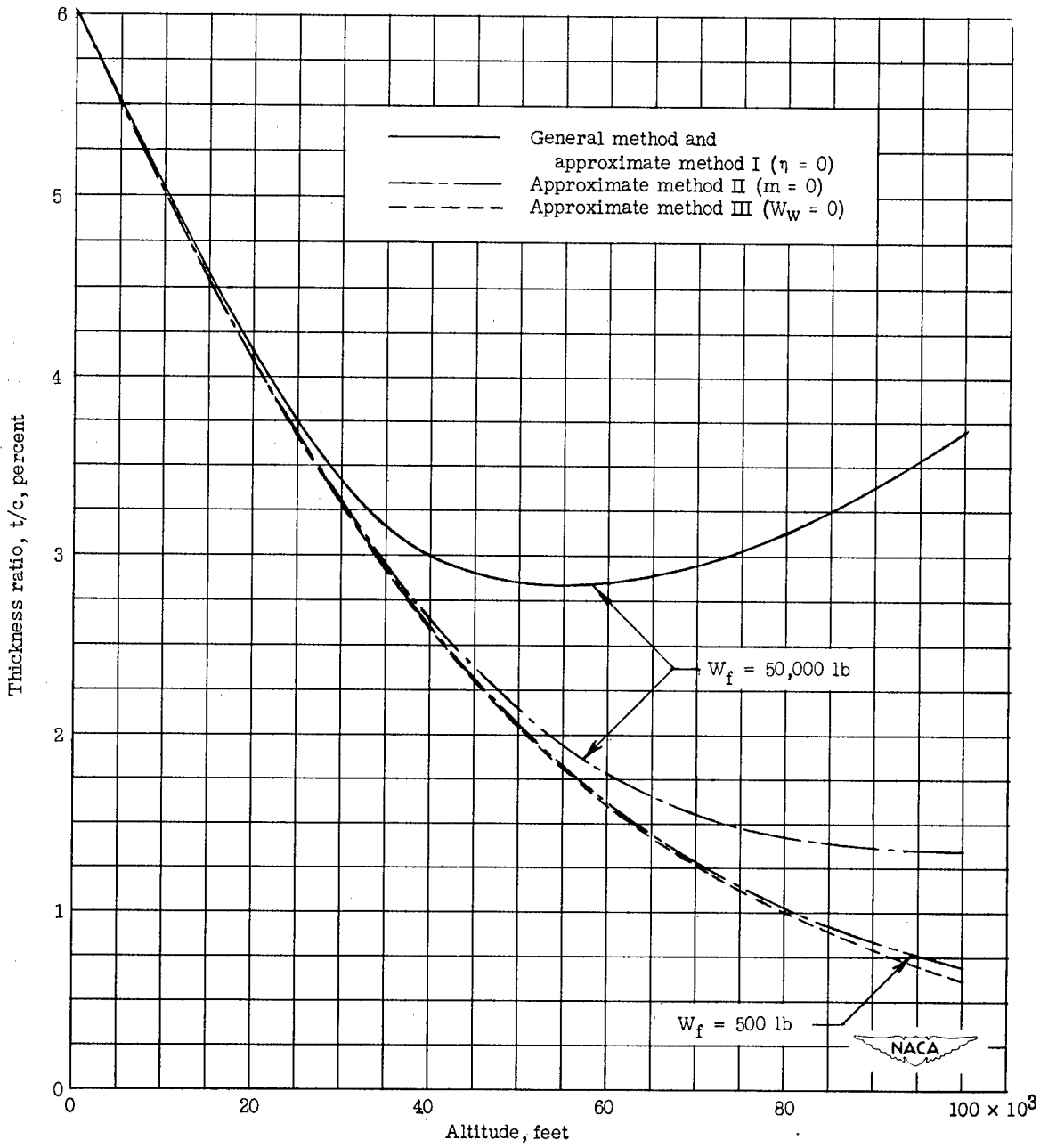

Figure 9.- Thickness ratio of diamond wings. $\frac{\sigma_a}{n_{max}} = 5,000$ pounds per square inch; double-wedge profile; aspect ratio, 4.0; Mach number, 2.0; aluminum wings; $r = m$; $C_{Df} = 0.005$; $n = 1$.

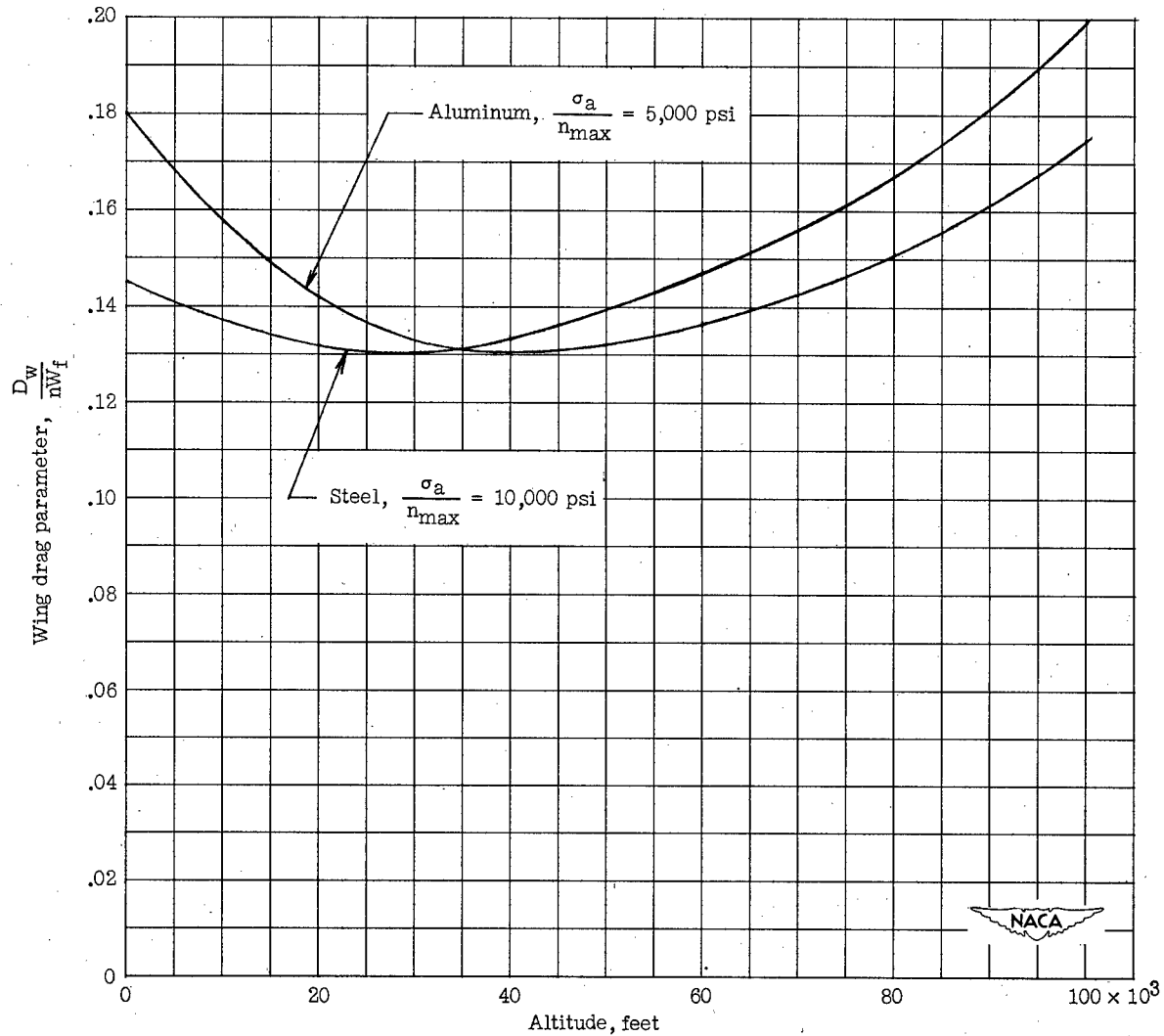

Figure 10.- Comparison of drag of diamond wings of aluminum and of steel construction, having thickness ratios, hollowness ratios, and chords chosen to satisfy the two basic objectives. General method. $W_f = 50,000$ pounds; double-wedge profile; aspect ratio, 4.0; Mach number, 2.0; $r = m$; $C_{D_f} = 0.005$; $n = 1$.

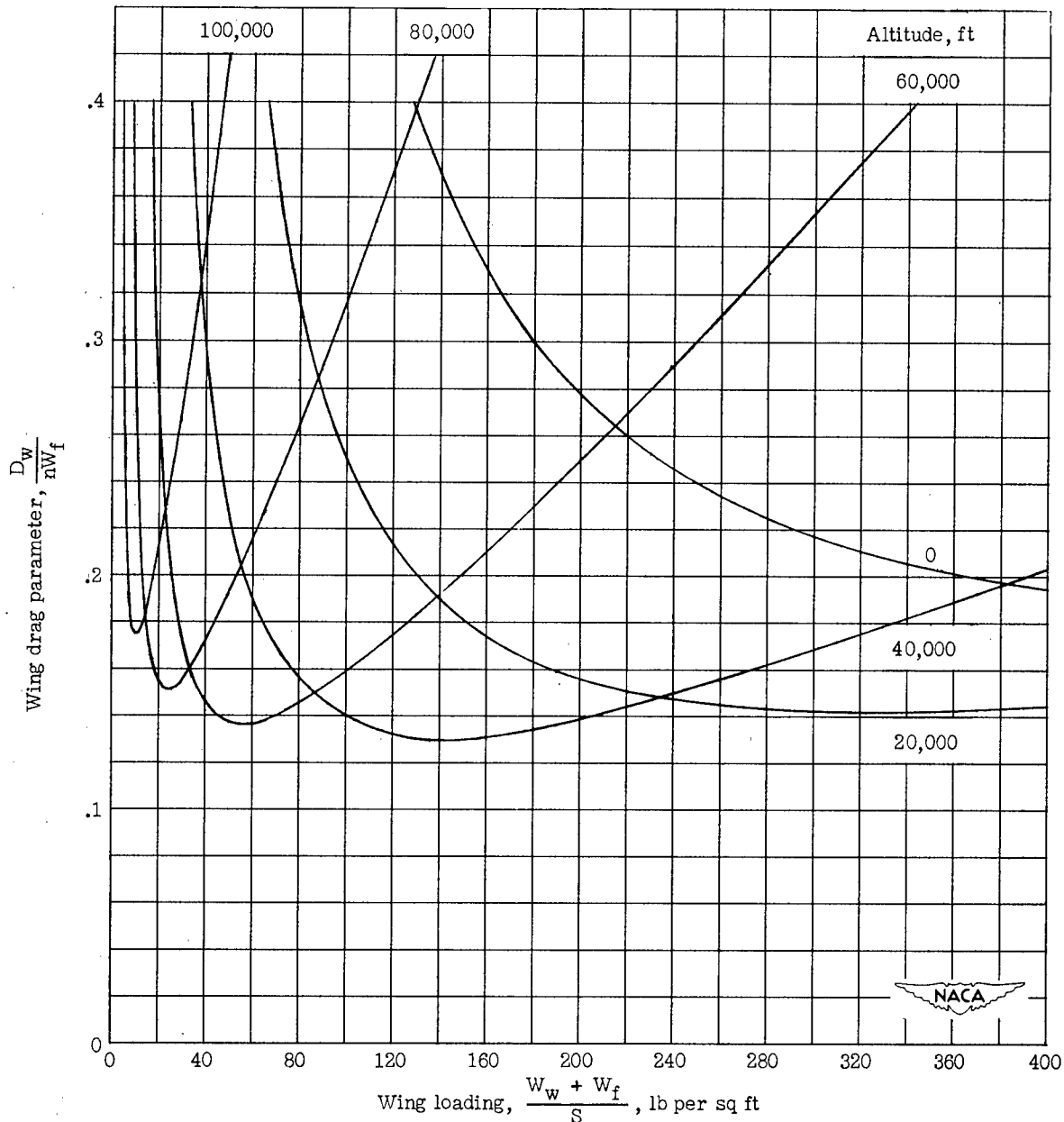

Figure 11.- Drag of diamond wings of arbitrary wing loading, having thickness and hollowness ratios chosen to satisfy the two basic objectives. $W_f = 50,000$ pounds; $\frac{\sigma_a}{n_{max}} = 5,000$ pounds per square inch; double-wedge profile; aspect ratio, 4.0; Mach number, 2.0; aluminum wings; $r = m$; $C_{D_f} = 0.005$; $n = 1$.

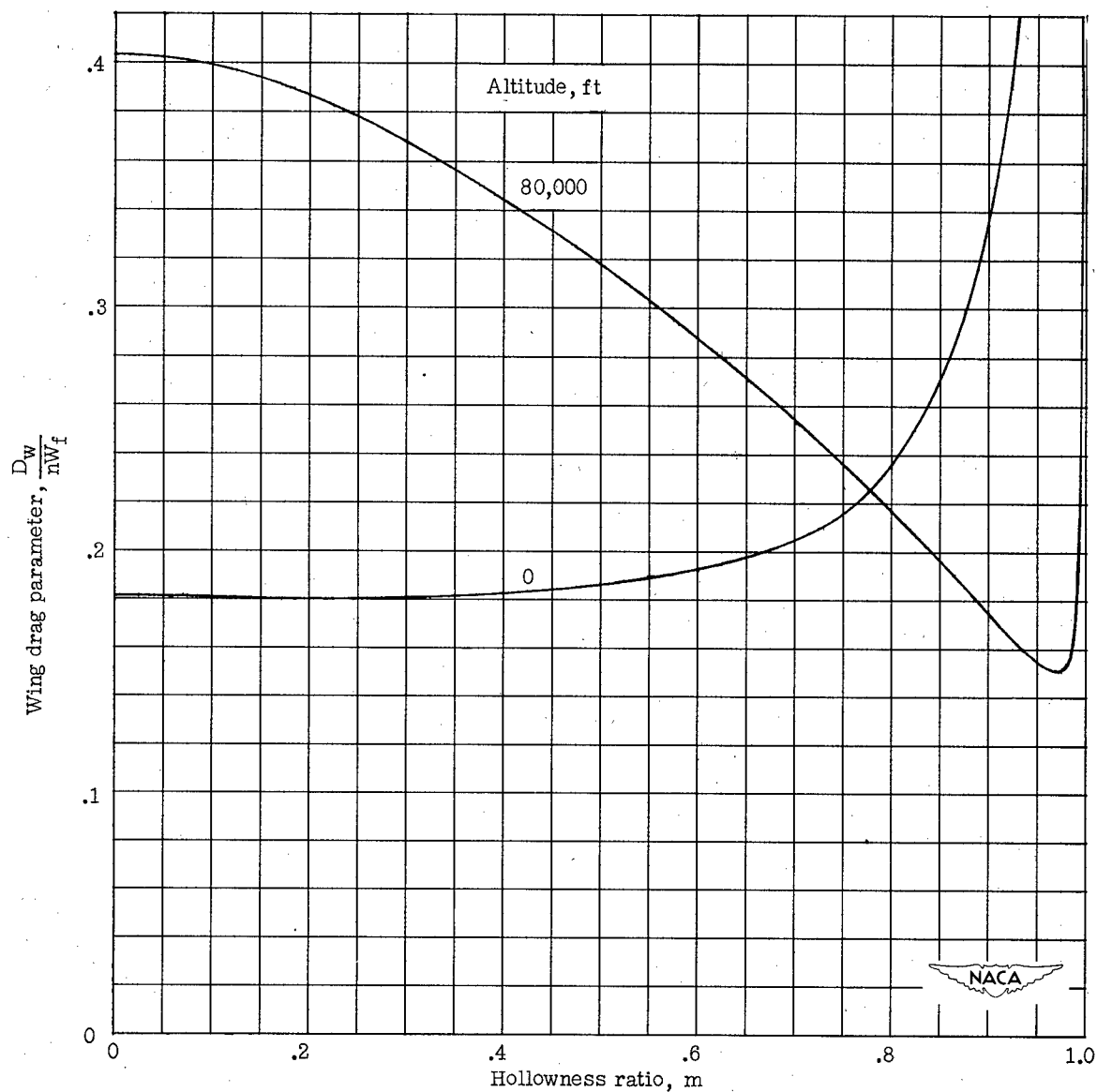

Figure 12.- Drag of diamond wings of arbitrary hollowness ratio, having thickness ratios and chords chosen to satisfy the two basic objectives.

$W_f = 50,000$ pounds; $\frac{\sigma_a}{n_{max}} = 5,000$ pounds per square inch; double-wedge profile; aspect ratio, 4.0; Mach number, 2.0; aluminum wings; $r = m$; $C_{D_f} = 0.005$; $n = 1$.

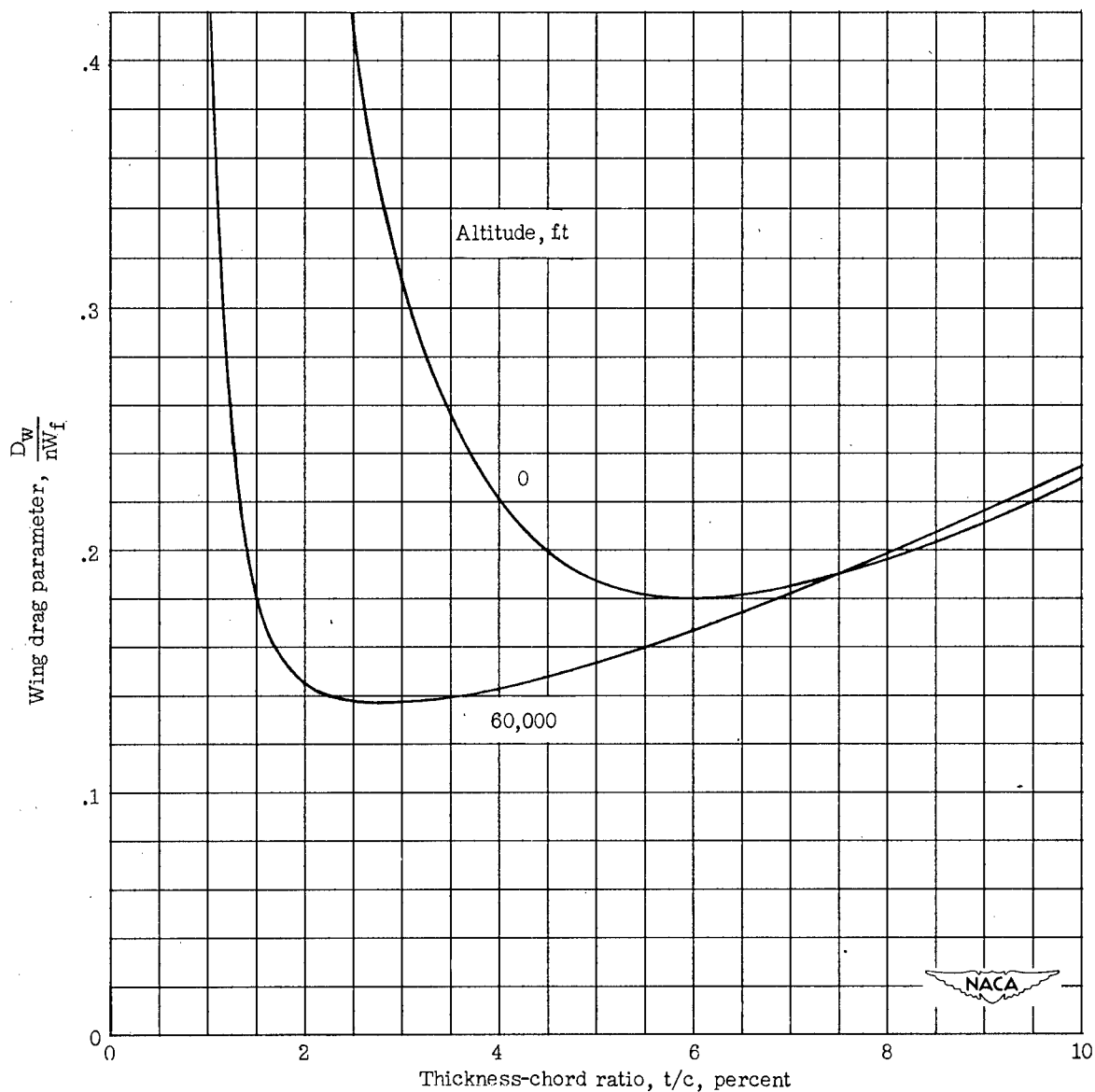

Figure 13.- Drag of diamond wings of arbitrary thickness ratio, having hollowness ratios and chords chosen to satisfy the two basic objectives.

$W_f = 50,000$ pounds; $\frac{\sigma_a}{n_{max}} = 5,000$ pounds per square inch; double-wedge profile; aspect ratio, 4.0; Mach number, 2.0; aluminum wings; $r = m$; $C_{D_f} = 0.005$; $n = 1$.

NACA TN 2754
National Advisory Committee for Aeronautics.
A METHOD OF SELECTING THE THICKNESS, HOLLOWNESS, AND SIZE OF A SUPERSONIC WING FOR LEAST DRAG AND SUFFICIENT BENDING STRENGTH AT SPECIFIED FLIGHT CONDITIONS.
James L. Amick. July 1952. 38p. diagrs. (NACA TN 2754)

The method described, which is suitable for use in preliminary missile design, is based on simple beam theory and takes into account the effects of wing weight and type of skin thickness distribution. For cases in which the wing weight is negligible, a simplification of the general method gives the best lift-drag ratio consistent with the bending strength requirement of a given combination of plan form and profile shape at a given Mach number as a function of a single design parameter. An example of the appli-

Copies obtainable from NACA, Washington (over)

1. Wings (1.2)
2. Wing Sections - Thickness (1.2.1.2.2)
3. Wings, Complete - Design Variables (1.2.2.2)
I. Amick, James L.
II. NACA TN 2754

NACA

NACA TN 2754
National Advisory Committee for Aeronautics.
A METHOD OF SELECTING THE THICKNESS, HOLLOWNESS, AND SIZE OF A SUPERSONIC WING FOR LEAST DRAG AND SUFFICIENT BENDING STRENGTH AT SPECIFIED FLIGHT CONDITIONS.
James L. Amick. July 1952. 38p. diagrs. (NACA TN 2754)

The method described, which is suitable for use in preliminary missile design, is based on simple beam theory and takes into account the effects of wing weight and type of skin thickness distribution. For cases in which the wing weight is negligible, a simplification of the general method gives the best lift-drag ratio consistent with the bending strength requirement of a given combination of plan form and profile shape at a given Mach number as a function of a single design parameter. An example of the appli-

Copies obtainable from NACA, Washington (over)

1. Wings (1.2)
2. Wing Sections - Thickness (1.2.1.2.2)
3. Wings, Complete - Design Variables (1.2.2.2)
I. Amick, James L.
II. NACA TN 2754

NACA

NACA TN 2754
National Advisory Committee for Aeronautics.
A METHOD OF SELECTING THE THICKNESS, HOLLOWNESS, AND SIZE OF A SUPERSONIC WING FOR LEAST DRAG AND SUFFICIENT BENDING STRENGTH AT SPECIFIED FLIGHT CONDITIONS.
James L. Amick. July 1952. 38p. diagrs. (NACA TN 2754)

The method described, which is suitable for use in preliminary missile design, is based on simple beam theory and takes into account the effects of wing weight and type of skin thickness distribution. For cases in which the wing weight is negligible, a simplification of the general method gives the best lift-drag ratio consistent with the bending strength requirement of a given combination of plan form and profile shape at a given Mach number as a function of a single design parameter. An example of the appli-

Copies obtainable from NACA, Washington (over)

1. Wings (1.2)
2. Wing Sections - Thickness (1.2.1.2.2)
3. Wings, Complete - Design Variables (1.2.2.2)
I. Amick, James L.
II. NACA TN 2754

NACA

NACA TN 2754
National Advisory Committee for Aeronautics.
A METHOD OF SELECTING THE THICKNESS, HOLLOWNESS, AND SIZE OF A SUPERSONIC WING FOR LEAST DRAG AND SUFFICIENT BENDING STRENGTH AT SPECIFIED FLIGHT CONDITIONS.
James L. Amick. July 1952. 38p. diagrs. (NACA TN 2754)

The method described, which is suitable for use in preliminary missile design, is based on simple beam theory and takes into account the effects of wing weight and type of skin thickness distribution. For cases in which the wing weight is negligible, a simplification of the general method gives the best lift-drag ratio consistent with the bending strength requirement of a given combination of plan form and profile shape at a given Mach number as a function of a single design parameter. An example of the appli-

Copies obtainable from NACA, Washington (over)

1. Wings (1.2)
2. Wing Sections - Thickness (1.2.1.2.2)
3. Wings, Complete - Design Variables (1.2.2.2)
I. Amick, James L.
II. NACA TN 2754

NACA

NACA TN 2754

cation of the method to a diamond wing at Mach number 2.0, for a range of specified flight conditions, is presented.

Copies obtainable from NACA, Washington

NACA TN 2754

cation of the method to a diamond wing at Mach number 2.0, for a range of specified flight conditions, is presented.

Copies obtainable from NACA, Washington

NACA TN 2754

cation of the method to a diamond wing at Mach number 2.0, for a range of specified flight conditions, is presented.

Copies obtainable from NACA, Washington

NACA TN 2754

cation of the method to a diamond wing at Mach number 2.0, for a range of specified flight conditions, is presented.

Copies obtainable from NACA, Washington

