

2/8/56
JW

NACA TN 3625

NATIONAL ADVISORY COMMITTEE FOR AERONAUTICS

TECHNICAL NOTE 3625

INVESTIGATION OF THE PROPULSIVE CHARACTERISTICS OF A
HELICOPTER-TYPE PULSE-JET ENGINE OVER A RANGE
OF MACH NUMBERS AND ANGLE OF YAW

By Paul J. Carpenter, James P. Shivers,
and Edwin E. Lee, Jr.

Langley Aeronautical Laboratory
Langley Field, Va.



Reproduced From
Best Available Copy

Washington

January 1956

DISTRIBUTION STATEMENT A
Approved for Public Release
Distribution Unlimited

20000515 168

M00-08-2318

NATIONAL ADVISORY COMMITTEE FOR AERONAUTICS

TECHNICAL NOTE 3625

INVESTIGATION OF THE PROPULSIVE CHARACTERISTICS OF A
HELICOPTER-TYPE PULSE-JET ENGINE OVER A RANGE
OF MACH NUMBERS AND ANGLE OF YAW

By Paul J. Carpenter, James P. Shivers,
and Edwin E. Lee, Jr.

SUMMARY

The nonwhirling propulsive characteristics of a helicopter-type pulse-jet engine mounted on a simulated helicopter rotor blade have been determined in the Langley 16-foot transonic tunnel. Propulsive characteristics as a function of fuel-flow rate were determined at Mach numbers of 0.25, 0.3, 0.4, 0.5, and 0.6 at yaw angles of 0° , 10° , and 20° . The results indicate that the maximum engine propulsive thrust was about 1 pound per square inch of frontal area up to a Mach number of 0.45. At Mach numbers of 0.5 and 0.6 the maximum propulsive thrust decreased to 0.94 and 0.73 pound per square inch, respectively. A minimum specific fuel consumption of 5.3 pounds of fuel per hour per horsepower occurred between Mach numbers of 0.4 and 0.5. The data indicate that the yaw angles investigated have little effect on the engine propulsive characteristics.

A comparison of the nonwhirling and whirling data obtained from NACA RM L53L15 on engines of the same design indicates that the pulse-jet engine thrust may be severely penalized as a result of centrifugal distortion of the fuel spray pattern. This effect appears at a centrifugal acceleration of about 200g.

INTRODUCTION

The pulse-jet engine is one of the family of tip-mounted jet engines considered suitable for jet propulsion of helicopter rotors. Some data on the hovering characteristics of a pulse-jet-powered rotor have been reported in reference 1; however, at that time no nonwhirling pulse-jet engine data were available to evaluate the effects of whirling on the engine propulsive characteristics. Accordingly, a test program to

determine the basic nonwhirling characteristics of an engine similar to that reported in reference 1 was initiated. Tests were conducted in the 16-foot transonic tunnel at Mach numbers from 0.25 to 0.6. In addition, the effect on the propulsive characteristics of pulse-jet engine yaw angles up to 20° , such as may be encountered at the tip of a helicopter rotor in forward flight, has been investigated. An exploratory investigation of the influence of the engine firing pulses on the pressure distribution over that portion of the airfoil support near the engine was also made.

SYMBOLS

| | |
|--------------|---|
| T_0 | absolute static temperature in tunnel test section, $^\circ R$ |
| M | test Mach number, ratio of tunnel air velocity to local velocity of sound |
| δ | ratio of tunnel static pressure to standard NACA sea-level pressure |
| θ | ratio of absolute tunnel static temperature to standard NACA sea-level absolute temperature |
| F_p | propulsive thrust of jet engine (force available to do useful work), lb |
| F_p/δ | corrected propulsive thrust, lb |
| W_f | fuel-flow rate, lb/hr |
| g | gravitational acceleration, 32.2 ft/sec^2 |
| ψ | engine yaw angle, deg |
| c | blade section chord, ft |

APPARATUS AND METHODS

The investigation was conducted in the Langley 16-foot transonic tunnel, which has a slotted test section of octagonal shape with approximately 16 feet between opposite flat sections. This large wind tunnel was chosen to minimize wall interference effects (reinforcement of engine firing pulses by reflection from the tunnel walls) on the engine propulsive characteristics.

Pulse-Jet Engine

The pulse-jet engine used for this investigation was 49.7 inches in length and had a maximum outside diameter of 9.4 inches. A sketch of the engine is shown in figure 1. It was similar to the engine used in reference 1, except for two minor modifications. The first modification consisted of replacing the rearmost 30 inches of the engine with 1/8-inch stainless steel, to avoid the possibility of burning out parts of the engine inner cone during tunnel testing. The additional thickness of tail pipe metal reduced the tail pipe flare from an exit diameter of 5.9 inches to 5.7 inches. The second modification consisted of internal reinforcing of the inlet cowl to avoid the fatigue failures previously encountered in tests at speeds above 420 feet per second.

The conventional flapper-type valve box, a photograph of which is shown in figure 2(a), was used with the engine. Figure 2(b) shows the arrangement of the moving parts of the valve box, which consisted of a sandwich of one 0.005-inch-thick phosphor bronze strip between two 0.006-inch-thick blued steel strips. These strips were 1 inch wide by 6 inches long. The spring constant of the valves used in these tests was 24 pounds per inch deflection of the valve tips.

The fuel injection system consisted of four standard commercial oil-burner-type spray nozzles and were located immediately to the rear of the valve box. The nozzles were located one to each side of the valve box and with the spray axis normal to the engine air flow. Each nozzle was rated at 15 gallons per hour at 100 pounds per square inch fuel pressure and had a 60° spray cone angle.

The ignition system consisted of a high-tension coil connected to a small spark plug in the engine combustion chamber.

Installation and Test Methods

Figure 3 shows the installation of the engine in the tunnel. The center line of the engine was located about 20 inches above the center line of the tunnel. The engine was secured through an electric strain-gage balance to the tip of a simulated rotor blade which had a chord of 2 feet and a span of about 4.5 feet. The balance was contained within the rotor blade and measured the engine force perpendicular to the span of the airfoil and in its plane. All the force data presented herein for the various engine yaw angles were obtained with the airfoil chord and engine at 0° angle of attack. The clearance between the engine shell and the simulated rotor blade section was about 1/16 inch. The rotor blade section was supported by the conventional tunnel sting mount. The angle of attack of the sting with respect to the horizontal could be varied during a test to give engine yaw angles of 0° to 20°. The sting mount is arranged so that as the angle of the sting is changed the tip of the sting remains essentially in the center of the tunnel.

Fuel (80-octane white automotive gas) was supplied to the engine through 1/4-inch copper tubing located in the sting. The rate of fuel injection was controlled by varying the output pressure of a high-pressure fuel pump located outside the tunnel. Fuel flow was measured by a rotating-vane-type flow meter.

For the series of tests conducted to establish the effect of velocity and yaw angle on the engine propulsive characteristics, the test procedure was to establish a constant tunnel speed at a given yaw angle. At this point, fuel was injected into the engine and ignited by the spark plug. All measurements were made under steady-state operating conditions. The engine chordwise force was indicated visually as well as recorded by an oscillograph. The fuel-flow rate was varied in small increments over the range at which the engine would resonate from lean flameout to rich blowout. At each Mach number a power-off drag value was also obtained at a yaw angle of 0° . The thrust and drag values thus measured include a small increment corresponding to the interference effect of the airfoil on the engine. The interference of the engine on the airfoil drag, however, was not investigated. Sufficient data to evaluate this interference effect are not yet available, but it is believed to be quite small.

The characteristics of the engine have been corrected to those which would have been obtained under standard conditions by the method outlined in reference 2.

Pressure Measurements

For the exploratory investigation of the effect of engine firing pulses on the airfoil pressure distribution, the blade-engine assembly was rotated 90° so that the rotor-blade span was horizontal, as shown in figure 4. A sketch showing the engine mount and the location of the pressure gages is given in figure 5. In this investigation the engine was kept horizontal and tests were made for blade-angle settings of 5° and 10° in order to simulate the lifting condition on the airfoil. An end plate was fastened to the end of the rotor blade to increase its effective aspect ratio.

Two rows of NACA miniature electrical pressure gages were imbedded in the rotor blade airfoil surfaces as shown in figure 5. The first and second rows of pressure gages were 6.8 and 12.1 inches, respectively, from the engine center line. Each row consisted of nine pressure gages, with four gages on each side and one at the airfoil leading edge. The airfoil pressure measuring system had a flat response to about 600 cycles per second. In addition, one highly damped pressure gage was connected to the engine combustion chamber to indicate engine firing frequency.

The tests consisted of measuring the pressures with and without the engine operating. Tests were made for rotor-blade angles of attack of 5° to 10° and various engine-power settings at Mach numbers of 0.3 and 0.4. Time histories of the airfoil pressures were obtained using a recording oscillograph.

Estimated Accuracies

The estimated accuracies of the basic quantities measured in the tests are as follows: engine thrust and drag, ± 2 pounds; engine yaw angle, $\pm 0.1^{\circ}$; tunnel Mach number, ± 0.002 ; fuel flow, ± 5 pounds per hour; airfoil surface pressures, ± 0.05 pound per square inch. The overall accuracy of the plotted data is believed to be ± 3 percent.

RESULTS AND DISCUSSION

Engine Propulsive Characteristics

Effect of Mach number.- The effect of Mach number on the propulsive characteristics of this pulse-jet engine at a yaw angle of 0° is shown in figure 6 as a plot of corrected propulsive thrust in pounds against corrected fuel-flow rate in pounds per hour for speeds corresponding to Mach numbers of 0.25, 0.3, 0.4, 0.5, and 0.6. The negative values of propulsive thrust at low fuel-flow rates indicate that the engine thrust was insufficient to overcome the drag. The maximum and minimum fuel rates shown indicate the range of stable engine operation. The power-off engine drag values obtained at the beginning and end of each test run are shown. The difference in the values is apparently due to the high vibratory loads imposed on the balance during power-on operation. The drag values obtained at the end of each run are indicated by flagged symbols.

The curves indicate only small differences in engine propulsive thrust between Mach numbers of 0.25 and 0.3. As the Mach number is increased, however, the fuel flow required to maintain constant engine thrust increases, which is characteristic of pulse-jet engines. The maximum propulsive thrust value increases slightly from Mach number 0.25 to 0.4. Beyond Mach number 0.4, especially at Mach number 0.6, the maximum thrust is considerably reduced. This decrease in propulsive thrust is largely due to the increased drag of the engine at the higher speeds. Some of the decrease in thrust shown at Mach number 0.6 could also be due to the failure of the inlet valves to close completely at the higher speeds, higher combustion chamber velocities, and reduced tail pipe charging, all of which reduce the pressure ratio in the combustion chamber.

The net force change from power-off to power-on is defined as the engine gross thrust and is indicative of the performance of the pulse-jet engine combustion cycle. An inspection of figure 6 indicates that the maximum engine gross thrust is steadily increasing with Mach number and at Mach number 0.6 has not yet reached a peak value even though the propulsive thrust is decreasing.

Effect of yaw angle.- The effect of yaw angle on the propulsive characteristics was investigated at each Mach number, and is shown in figure 7. No significant effect was noted for the angles tested at Mach numbers below 0.5. At a Mach number of 0.5 a decrease of the order of 4 pounds in propulsive thrust was experienced at yaw angles of 10° and 20° over the useful operating range of the engine as shown in figure 7(d). The slight increase in thrust generally shown at yaw angles of 10° and 20° at the lower end of the propulsive-thrust curve has no practical significance inasmuch as the thrust is negative.

The effect of yaw angle on the engine propulsive characteristics at Mach number 0.6 was quite similar to that shown for Mach number 0.5, except that the decrease in thrust was about 5 pounds as compared with the 4 pounds shown in figure 7(d). These thrust reductions represent a 6- to 8-percent decrease in maximum available propulsive thrust.

Comparison of Whirling and Nonwhirling Data

A convenient method of illustrating engine performance is provided by plotting propulsive thrust per unit frontal area and specific fuel consumption as a function of Mach number. This information at yaw angle of 0° is shown in figure 8, together with a comparison of some whirling data obtained from the pulse-jet rotor tests of reference 1.

The thrust for minimum specific fuel consumption was generally about 93 percent of the maximum thrust obtained except in the whirling case, where minimum specific fuel consumption was obtained at maximum thrust.

The nonwhirling data indicate a slight increase in propulsive thrust from 1 to 1.04 pounds per square inch of frontal area as velocity is increased from Mach numbers 0.25 to 0.4. Above the latter speed, the thrust decreases slightly at first and then quite rapidly, becoming about 0.73 pound per square inch at Mach number of 0.6. The performance of this engine at Mach number 0.6 is surprisingly good, especially in view of the fact that the propulsive thrust of most conventional pulse-jet engines (designed for high static thrust) decreases to approximately zero at this speed.

A comparison of the data for the whirling and nonwhirling thrust at minimum specific fuel consumption indicates good agreement at Mach numbers up to about 0.29. At Mach number 0.29, which corresponded to a centrifugal acceleration of about 175g (rotor of ref. 1) a small decrease in whirling thrust appears, whereas the nonwhirling thrust shows a slight increase. At Mach number 0.33, which corresponded to a centrifugal acceleration of 225g, the whirling thrust is about 10 percent less than the nonwhirling thrust. Another effect of whirling is a reduction in maximum thrust over the entire range of tests of reference 1. Previous experience with ram-jet engines (ref. 3) has indicated little or no effect of whirling on the engine propulsive characteristics below centrifugal acceleration of 400g. For this reason, the pulse-jet engine performance reported in reference 1 was believed to be free of the adverse effects associated with these higher centrifugal accelerations. It now appears that this pulse-jet engine, however, experiences a significant decrease in thrust due to whirling at centrifugal accelerations of about 200g. As in the case of the ram-jet engines, it appears that this thrust loss is due to distortion of the fuel spray pattern above a critical centrifugal acceleration.

The nonwhirling minimum-specific-fuel-consumption curve shows a steady decrease as speed is increased from Mach numbers of 0.25 to 0.4. Between Mach numbers 0.4 and 0.5 the specific fuel consumption reaches a minimum value of about 5.3 pounds of fuel per hour per horsepower. As speed is increased past Mach number of 0.5, the specific fuel consumption increases rapidly reaching a value of 7.0 pounds per hour per horsepower at Mach number of 0.6.

The whirling and nonwhirling specific-fuel-consumption data, like the previously discussed propulsive-thrust curves, are in good agreement at the lowest speed. As velocity increases, the effect of whirling the pulse jet results in higher specific fuel consumption than for the nonwhirling case. At Mach number 0.33, corresponding to a centrifugal acceleration of 225g, the results indicate a 15-percent increase in specific fuel consumption due to whirling.

There are at least two contributing factors which would have a significant influence on such reduced performance. In all probability, the type and location of the fuel spray nozzles would affect the combustion efficiency when in the influence of a centrifugal field. Another factor may be the effect of intermittent internal flow associated with pulse jets on the fuel spray distribution. Appreciable gains in thrust and specific fuel consumption therefore should be realized by decreasing the sensitivity of the pulse-jet engine to the centrifugal accelerations. One would conclude that the arrangement of fuel spray nozzles to compensate for the centrifugal forces on the fuel distribution and possible vaporization of the fuel by preheating in order to reduce the size and weight of the fuel particles should be further explored to achieve increased performance at higher tip speeds.

Effect of Engine Operation on Airfoil Surface Pressures

A study of the blade airfoil surface pressures was undertaken to determine the extent to which engine operation changed the average loading of that portion of the blade adjacent to the engine. Blade angle-of-attack settings of 5° and 10° were chosen as representative of angles of attack obtained at the blade tip in helicopter flight. The engine was mounted so that its center line was horizontal for both blade angle settings since normally in a rotor installation it would be pivoted to remain at 0° angle of attack regardless of blade pitch. A representative sample of the data obtained with the engine operating at full thrust with a blade pitch angle of attack of 5° and a tunnel Mach number of 0.3 is shown in figure 9. Figure 9(a) shows a comparison of the pressures at the leading edge of the airfoil for distances of 6.8 and 12.1 inches from the center line of the engine for engine power-off and power-on conditions. A damped signal of the engine internal pressure used in determining engine firing frequency is also shown. The two leading-edge pressure signals indicate oscillatory pressures of the same frequency as the engine firing frequency, but little or no change in the average pressure values. Blade angle of attack has no apparent effect on the oscillatory pressures.

Figure 9(b) shows additional measurements at various percent chord positions for the two rows of pressure cells. Again there is little or no shift in the mean pressure level, and the oscillatory pressures are again of the same frequency as the engine firing frequency. In general, the magnitudes of the oscillatory pressures on both rows were about equal and averaged about 0.45 pound per square inch. The pressure signals shown are at various instrument sensitivities and, therefore, the oscillatory magnitudes are not directly comparative. A check of the engine noise level in the tunnel approximately 6 feet ahead of the engine indicated maximum values of about 160 decibels. It appears that the airfoil pressure oscillations are directly a result of the noise level of the engine. The magnitude of the oscillatory pressures shown are probably considerably higher than would be experienced in free air, due to testing in an enclosed tunnel. Sound level measurements of a similar pulse-jet engine in free air indicated noise levels of 140 decibels at maximum thrust at a distance of 2 feet (ref. 1). It would be expected that the oscillatory pressures would show the same reduction. Examination of records taken at various engine power settings and tunnel speeds shows the same general pattern as shown in figures 9(a) and (b), except that the oscillatory pressure amplitude decreased as engine thrust and noise level were decreased.

CONCLUSIONS

The basic nonwhirling propulsive characteristics of a helicopter-type pulse-jet engine have been determined in the Langley 16-foot transonic tunnel. Tests were made for a range of Mach numbers from 0.25 to 0.6 and yaw angles from 0° to 20° . The more pertinent findings of this investigation are as follows:

1. Yaw angle had a negligible effect on engine propulsive thrust up to Mach number 0.4. Yaw angles of 10° or 20° reduced the propulsive thrust by 6 to 8 percent at Mach numbers 0.5 and 0.6, respectively.

2. The engine propulsive thrust at minimum specific fuel consumption was approximately 1 pound per square inch of frontal area for Mach numbers from 0.25 to 0.45. At Mach number 0.6 the propulsive thrust decreased to 0.73 pound per square inch of frontal area.

3. The minimum-specific-fuel-consumption value of 5.3 pounds of fuel per hour per horsepower was obtained between Mach numbers of 0.4 and 0.5. This value increased to 7 pounds of fuel per hour per horsepower at Mach number 0.6.

4. Comparison of the whirling and nonwhirling data indicates good agreement at low speeds. As speed and centrifugal loading are increased, the whirling data show a significant decrease in propulsive thrust and an increase in specific fuel consumption at centrifugal loadings above 200g. This phenomenon is probably mainly the result of distortion of the fuel spray pattern as the centrifugal acceleration is increased.

5. An exploratory investigation of the effect of engine operation on the blade airfoil surface pressures indicates essentially no effect of engine operation on the mean pressure level. Oscillatory pressures corresponding to the engine sound level are present.

Langley Aeronautical Laboratory,
National Advisory Committee for Aeronautics,
Langley Field, Va., July 15, 1955.

REFERENCES

1. Radin, Edward J., and Carpenter, Paul J.: Investigation of a Pulse-Jet-Powered Helicopter Rotor on the Langley Helicopter Test Tower. NACA RM L53L15, 1954.
2. Sanders, Newell D.: Performance Parameters for Jet-Propulsion Engines. NACA TN 1106, 1946.
3. Radin, Edward J., and Carpenter, Paul J.: Comparison of the Performance of a Helicopter-Type Ram-Jet Engine Under Various Centrifugal Loadings. NACA RM L53H18a, 1953.

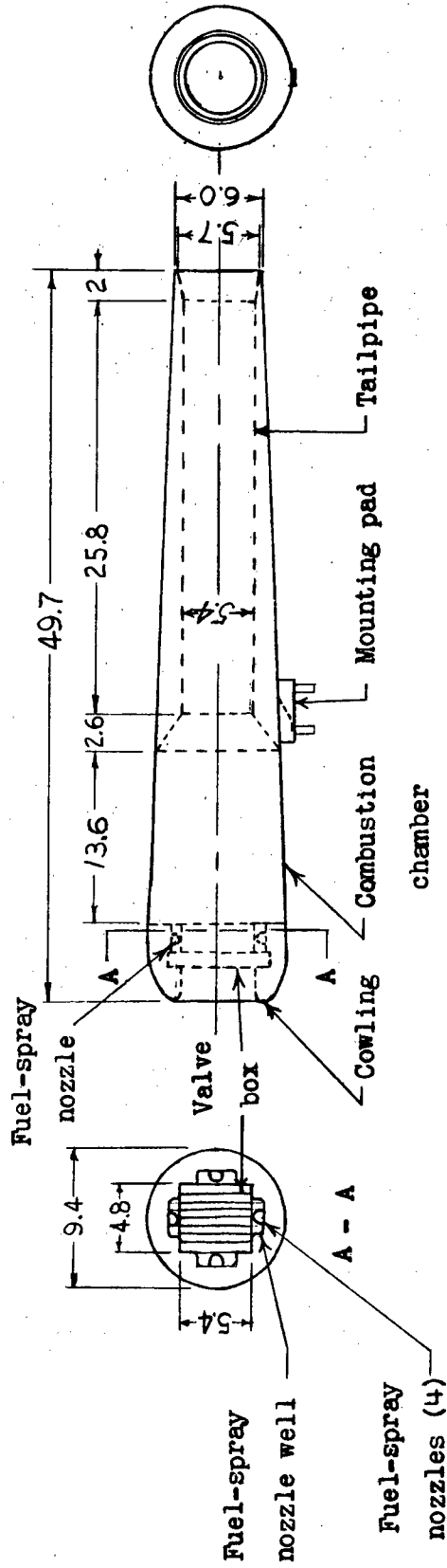

Note. Numbers inside engine indicate inside diameter dimensions.

Figure 1.- Sketch of the pulse-jet engine. All dimensions are in inches.

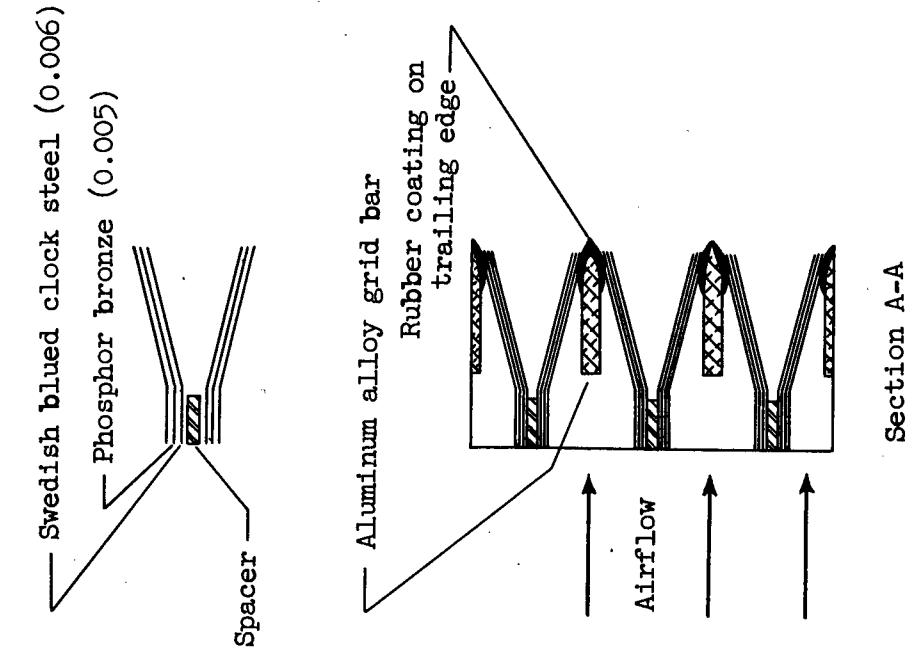

(b) Valve detail.

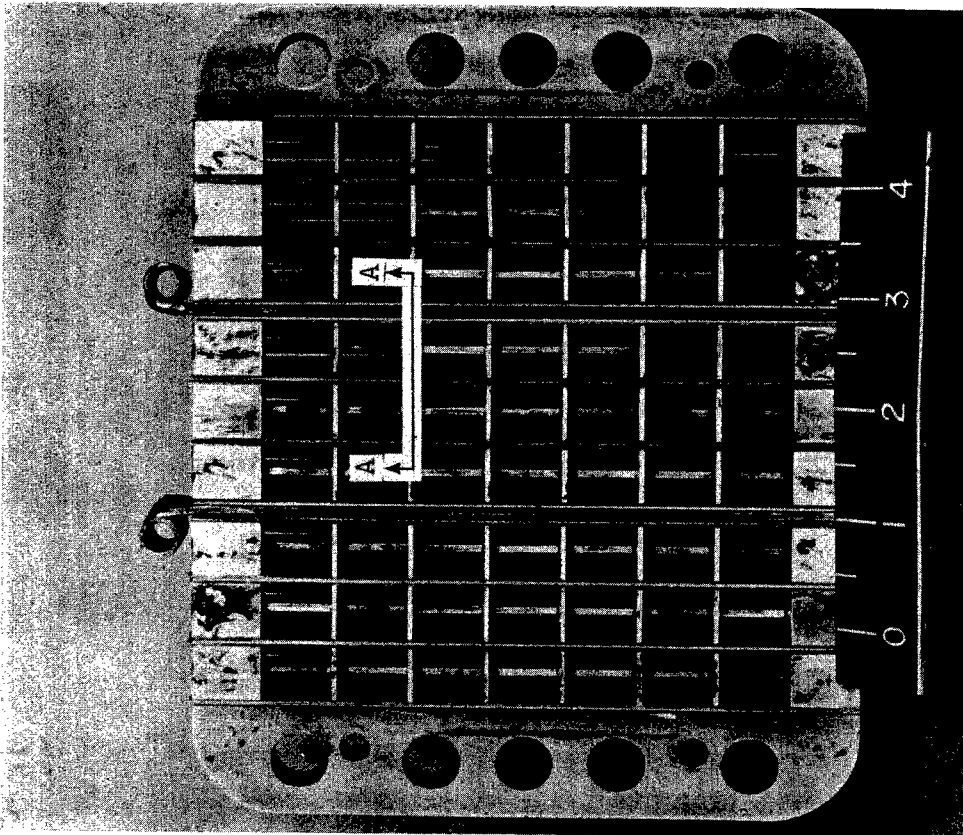

(a) Front view.
L-80325.2

Figure 2.- Pulse-jet engine flapper-type valve box.

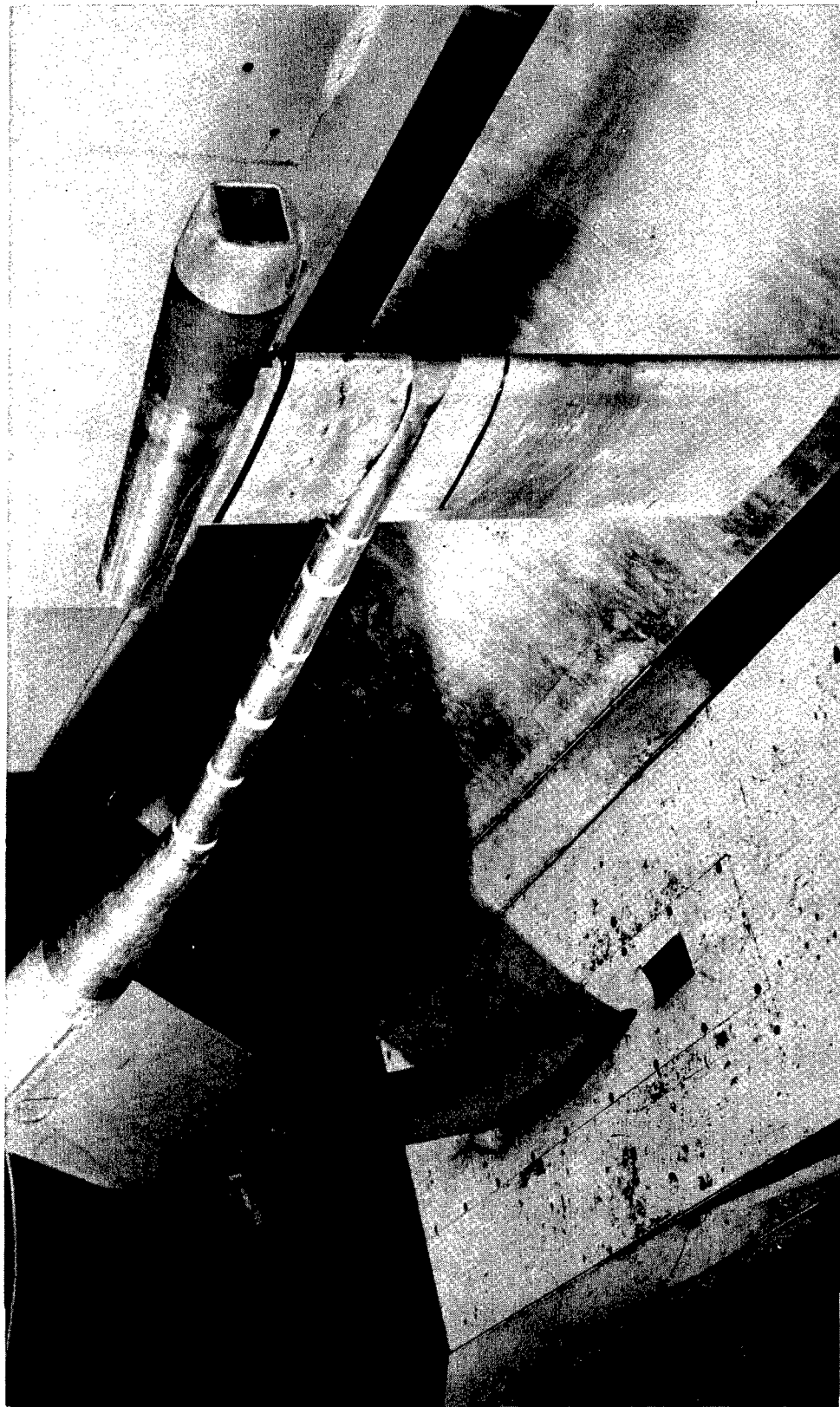

L-86901
Figure 3.- Installation of pulse-jet engine in Langley 16-foot transonic tunnel for investigation of the effects of velocity and yaw angle on propulsive characteristics.

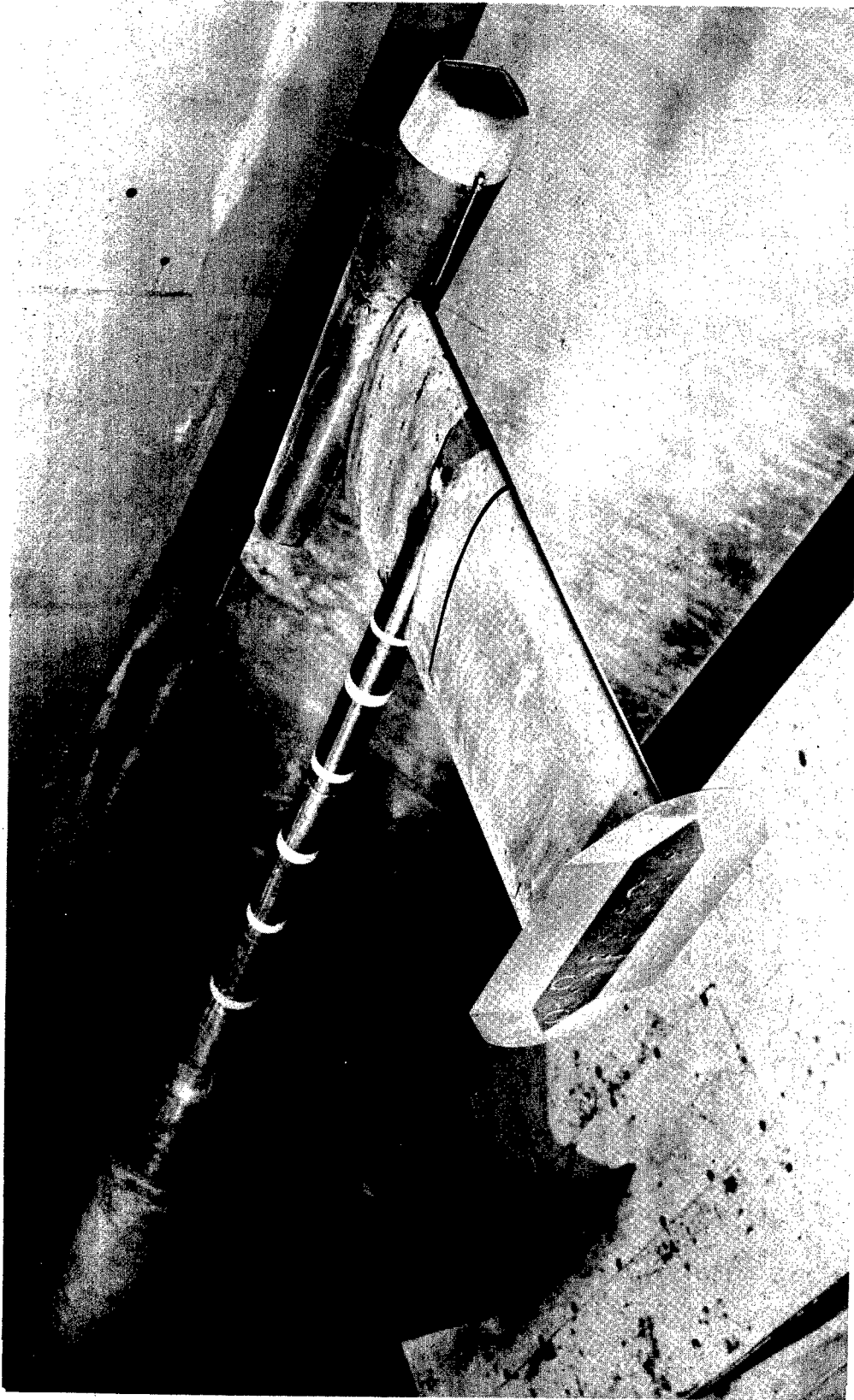

Figure 4.- Installation of pulse-jet engine in Langley 16-foot transonic tunnel for exploratory investigation of the effect of engine firing pulses on airfoil pressure distribution.

L-86899

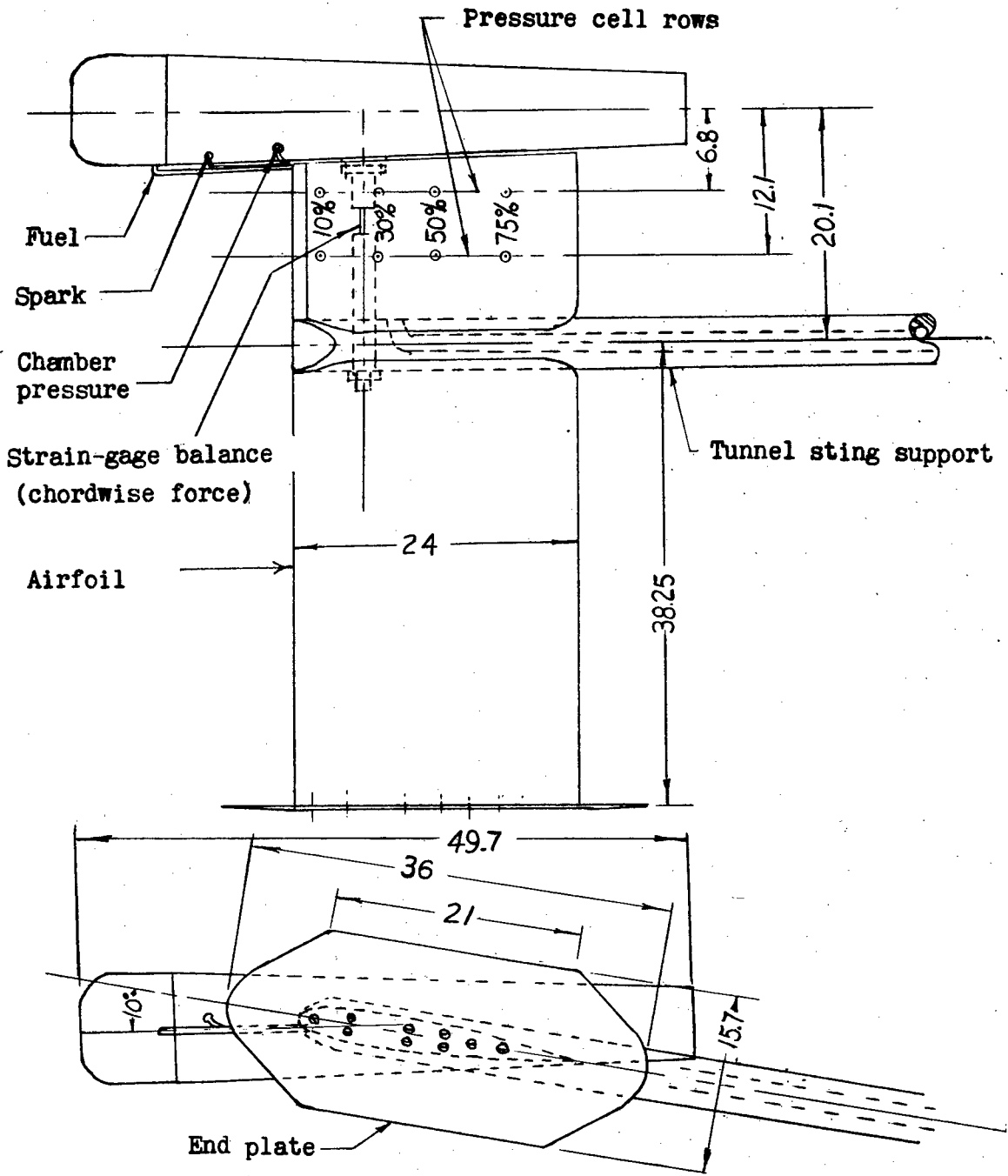

Figure 5.- Detail sketch showing pulse-jet engine mounting and location of pressure cells in simulated rotor blade for investigation of engine firing on airfoil surface pressures.

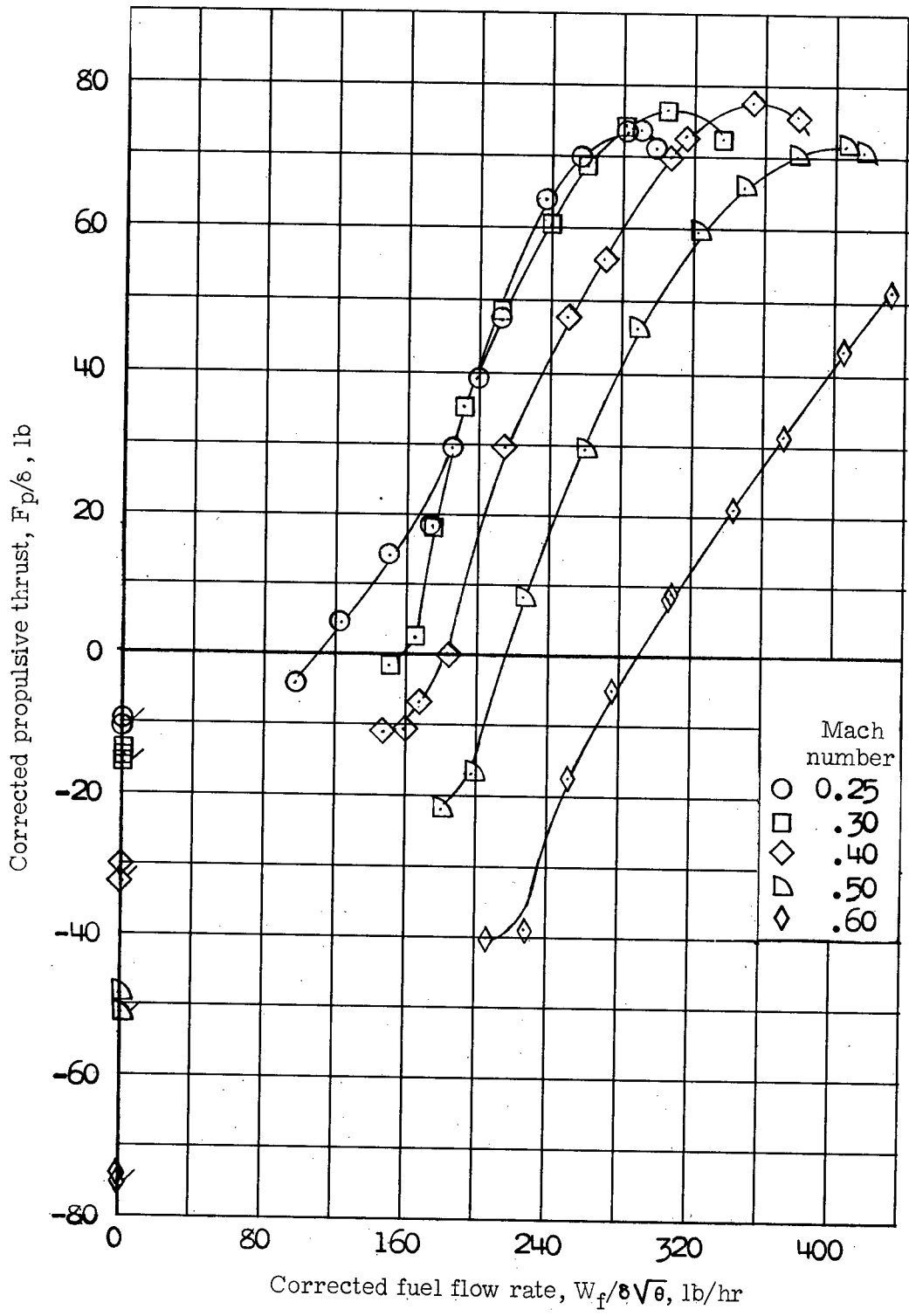
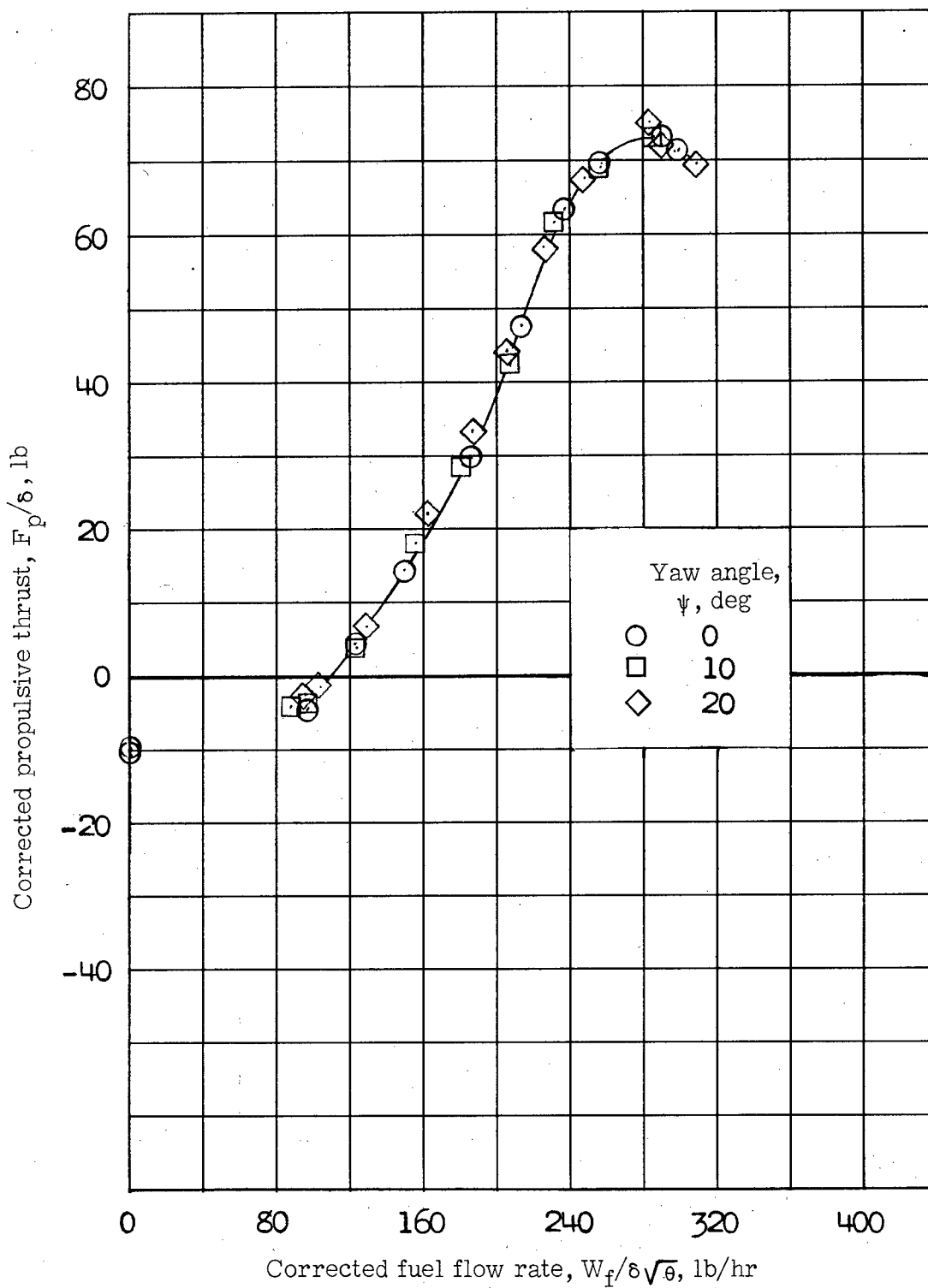
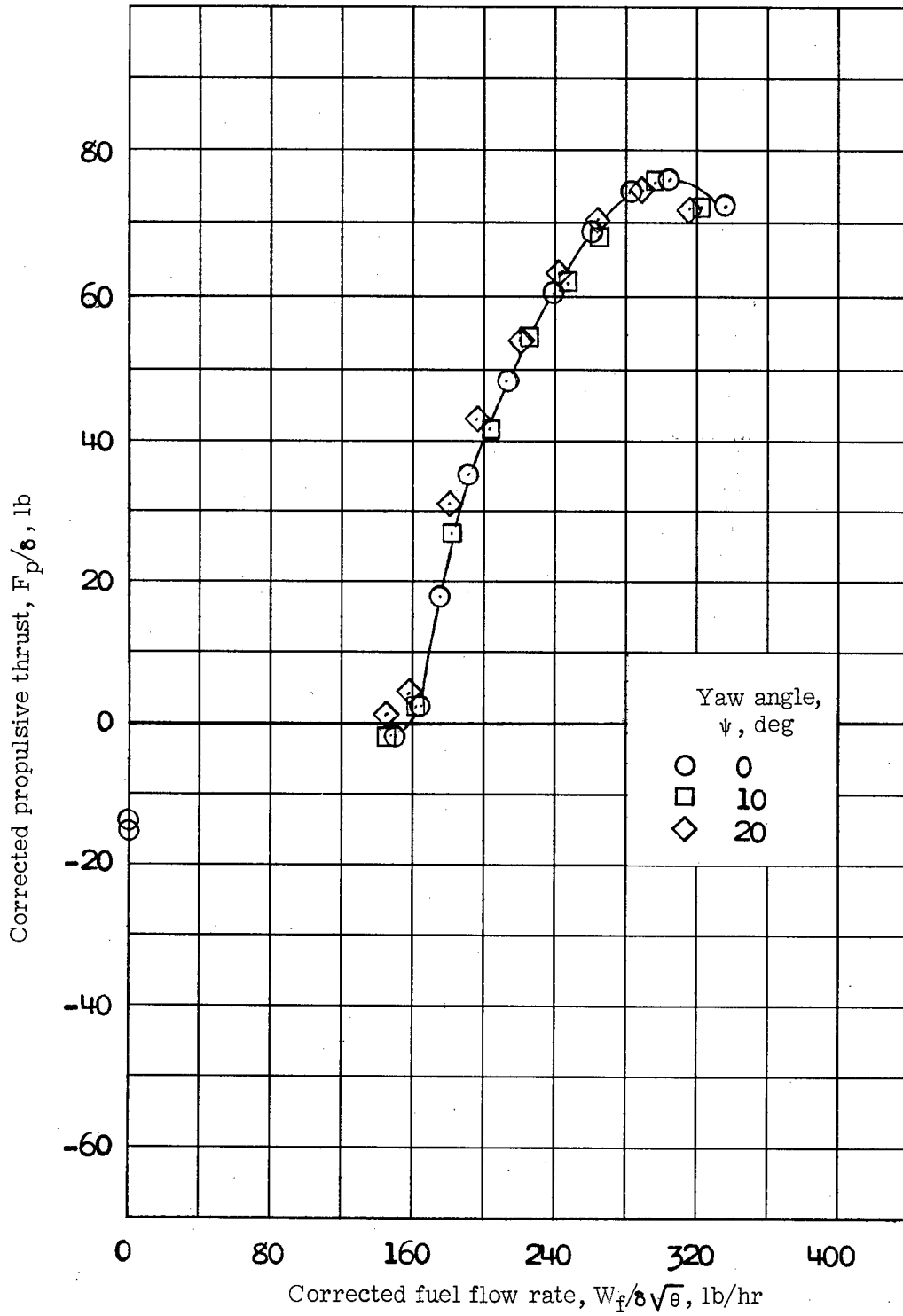

Figure 6.- Corrected pulse-jet propulsive thrust as a function of corrected fuel rate at zero degrees yaw angle for Mach numbers of 0.25, 0.3, 0.4, 0.5, and 0.6.



(a) Mach number = 0.25.

Figure 7.- Effect of yaw angle on the pulse-jet engine propulsive characteristics.



(b) Mach number = 0.30.

Figure 7.- Continued.

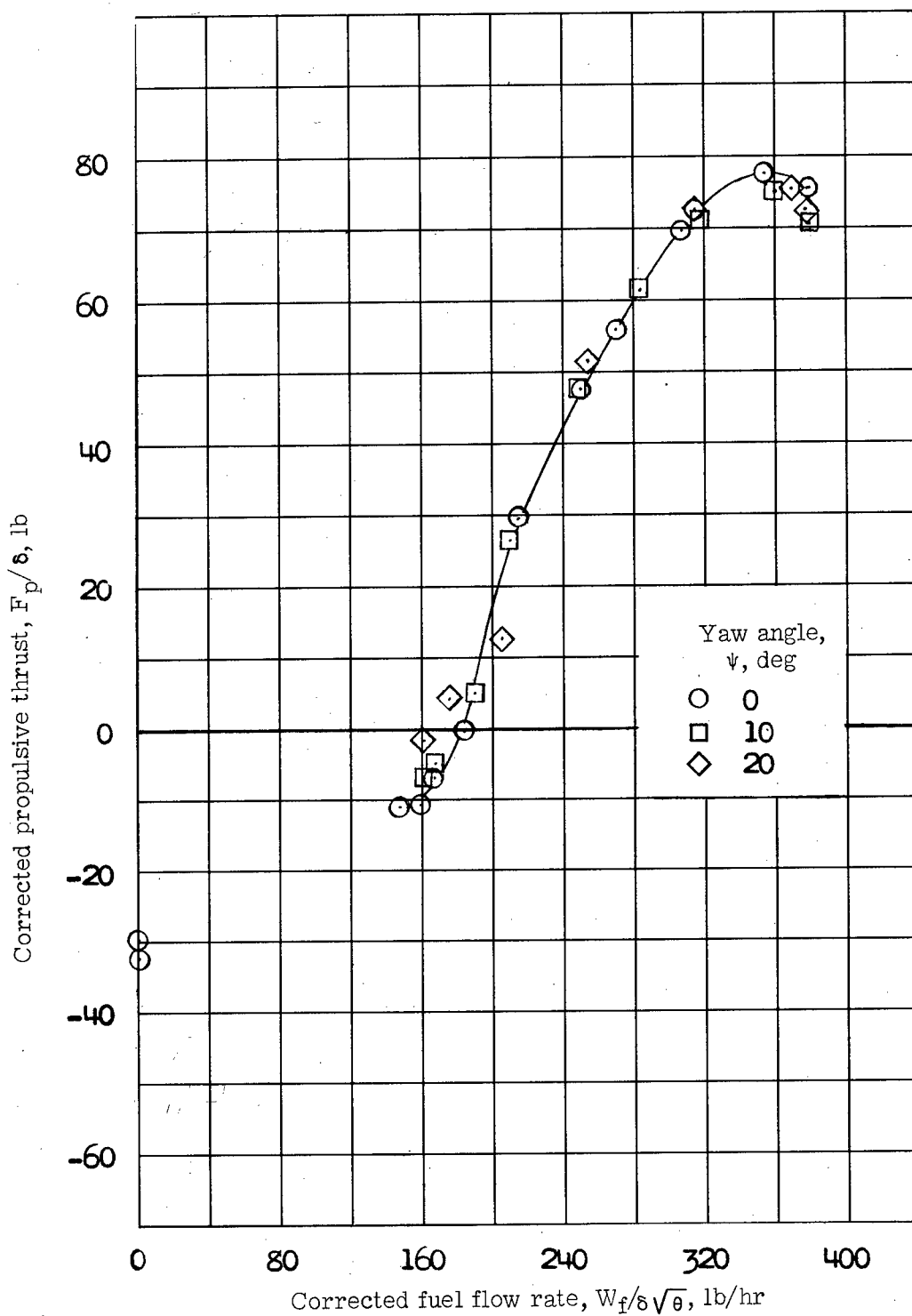

(c) Mach number = 0.40.

Figure 7.- Continued.

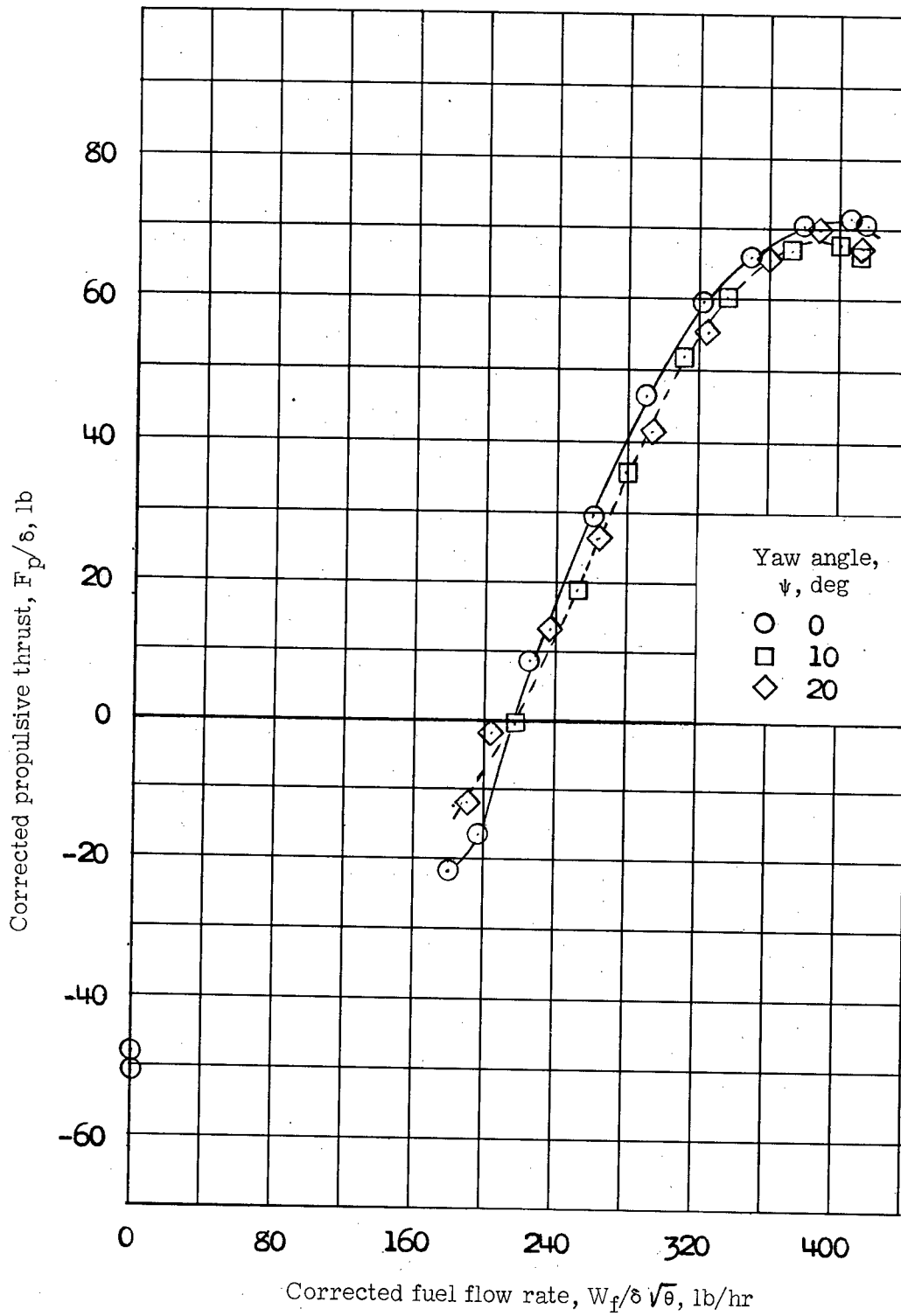

(d) Mach number = 0.50.

Figure 7.- Continued.

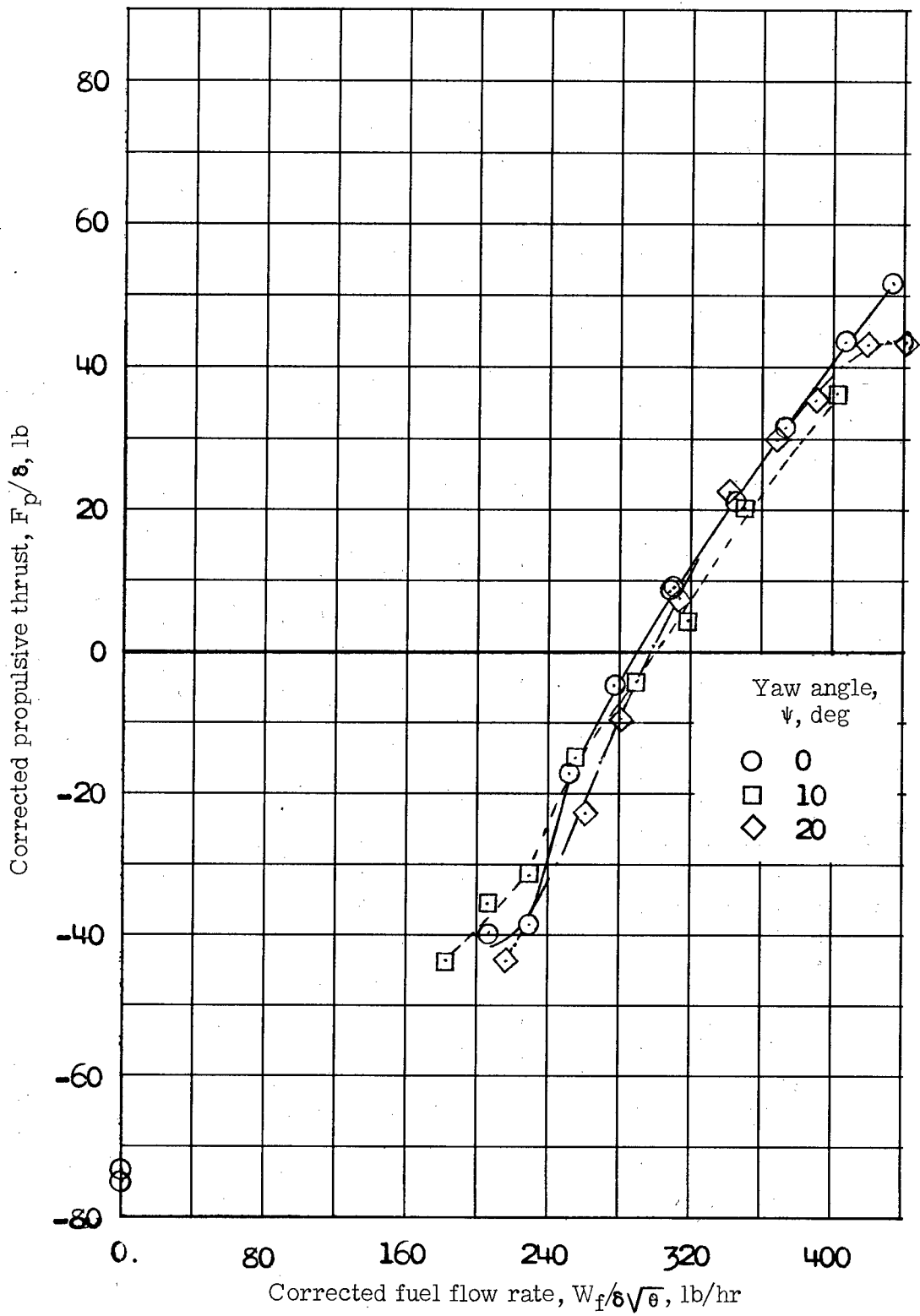

(e) Mach number = 0.60.

Figure 7.- Concluded.

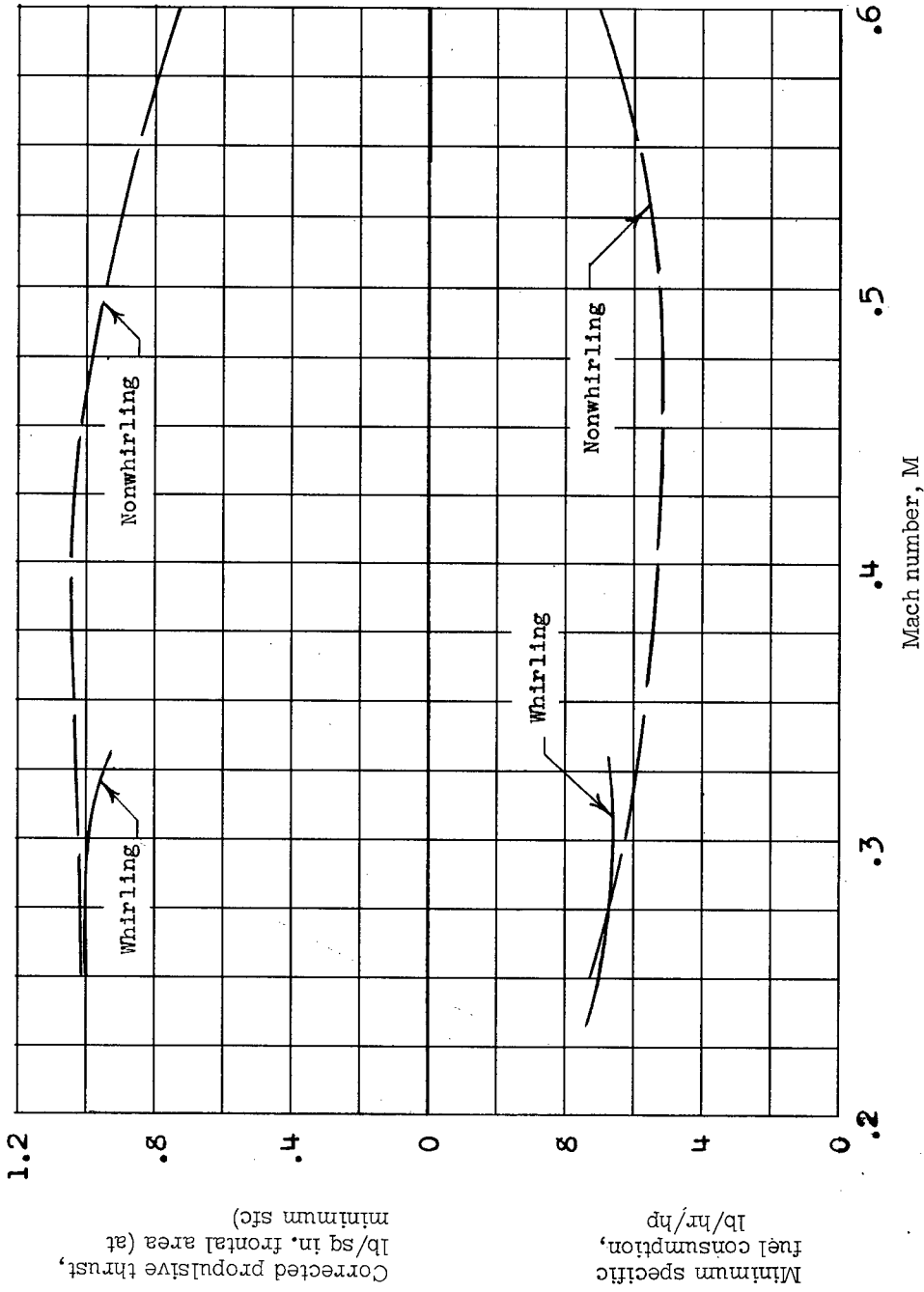
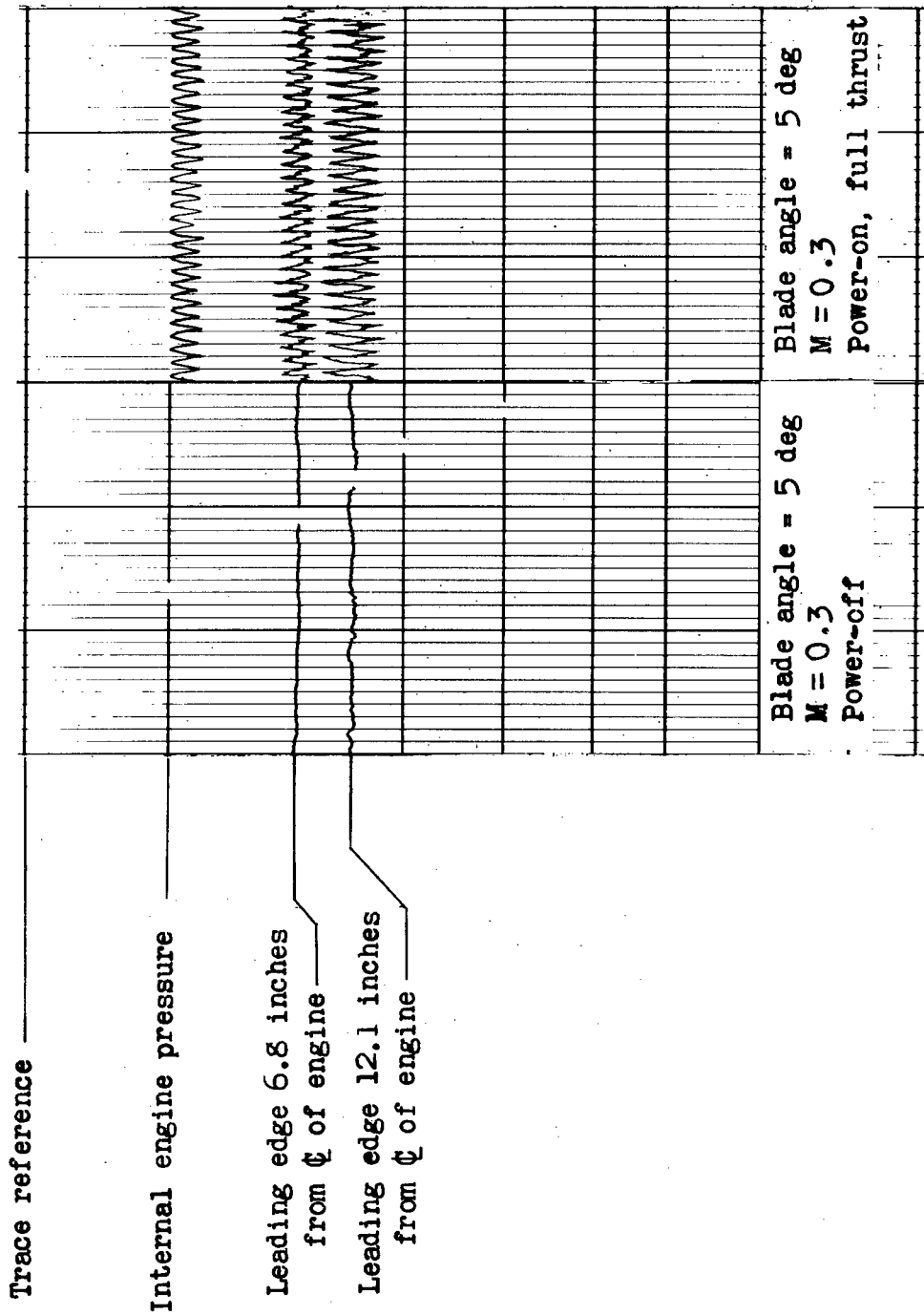
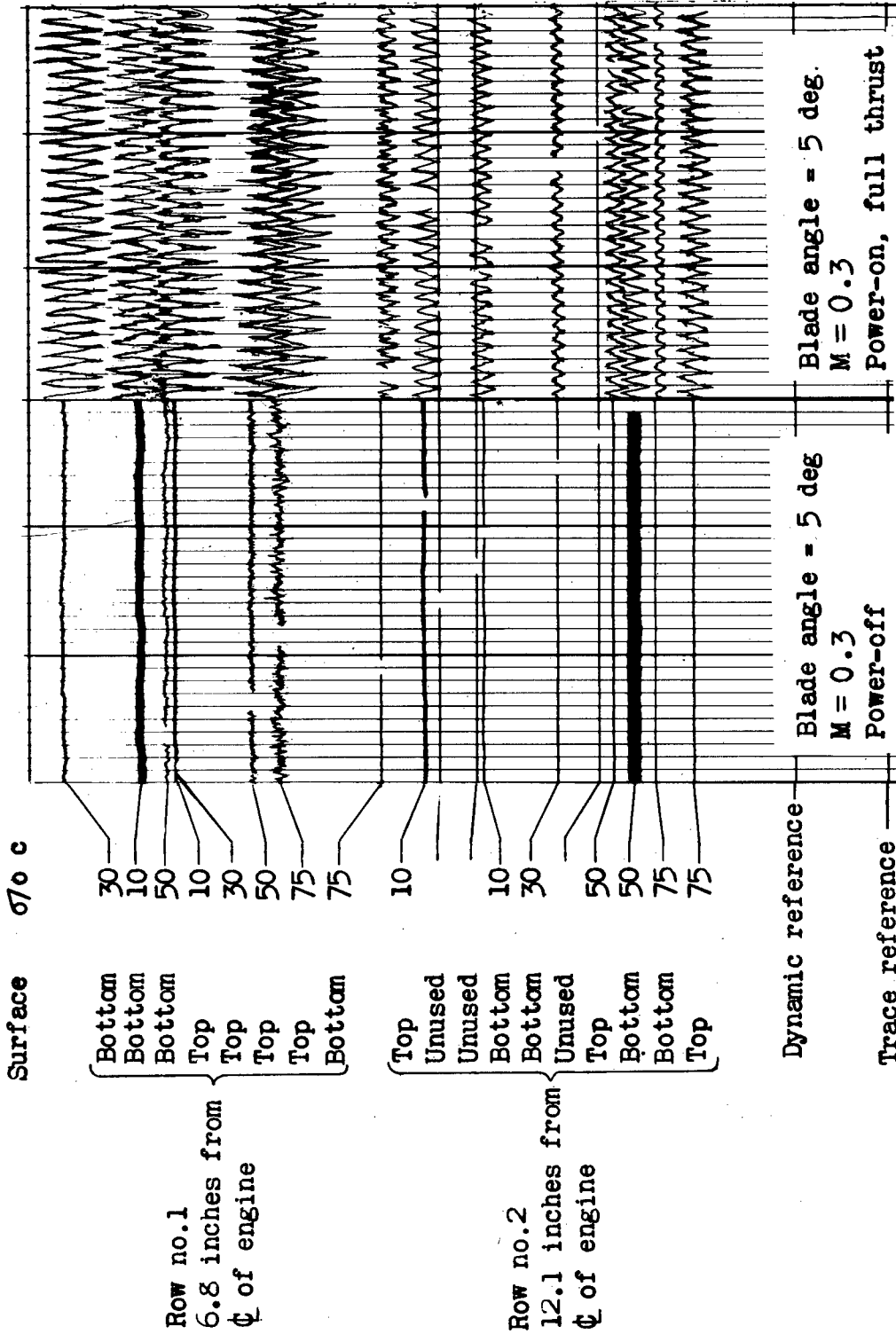

Figure 8.- Plots of corrected propulsive thrust per unit frontal area (at minimum specific fuel consumption) and minimum specific fuel consumption as a function of Mach number for both the whirling and nonwhirling cases.



(a) Airfoil leading-edge pressures.

Figure 9.- Comparison of airfoil pressures with engine power-off and power-on.



(b) Airfoil surface pressures at various percent chord positions.

Figure 9.- Concluded.

NACA TN 3625

National Advisory Committee for Aeronautics.
INVESTIGATION OF THE PROPULSIVE CHARACTERISTICS OF A HELICOPTER-TYPE PULSE-JET ENGINE OVER A RANGE OF MACH NUMBERS AND ANGLE OF YAW. Paul J. Carpenter, James P. Shivers, and Edwin E. Lee, Jr. January 1956.
24p. diags., photos. (NACA TN 3625)

The nonwhirling propulsive characteristics of a helicopter-type pulse-jet engine mounted on a simulated rotor blade have been determined in the Langley 16-foot transonic tunnel. A propulsive thrust of about 1 lb/sq in. of engine frontal area at Mach numbers from 0.25 to 0.45 was obtained. Propulsive thrust at Mach number 0.6 decreased to about 0.73 lb/sq in. frontal area. Yaw angles of 0° to 20° had no significant effect on engine thrust at Mach numbers below 0.5 and only small effects at higher speeds. Specific fuel consumption reached a minimum of 5.3 lb of fuel per hr per hp between

(over)

Copies obtainable from NACA, Washington

1. Helicopters (1.7.3.2)
2. Engines, Pulse-Jet (3.1.6)
3. Combustion - Effect of Engine Operating Conditions and Combustion-Chamber Geometry (3.5.2)

- I. Carpenter, Paul J.
- II. Shivers, James P.
- III. Lee, Edwin E., Jr.
- IV. NACA TN 3625



NACA TN 3625
National Advisory Committee for Aeronautics.
INVESTIGATION OF THE PROPULSIVE CHARACTERISTICS OF A HELICOPTER-TYPE PULSE-JET ENGINE OVER A RANGE OF MACH NUMBERS AND ANGLE OF YAW. Paul J. Carpenter, James P. Shivers, and Edwin E. Lee, Jr. January 1956.
24p. diags., photos. (NACA TN 3625)

The nonwhirling propulsive characteristics of a helicopter-type pulse-jet engine mounted on a simulated rotor blade have been determined in the Langley 16-foot transonic tunnel. A propulsive thrust of about 1 lb/sq in. of engine frontal area at Mach numbers from 0.25 to 0.45 was obtained. Propulsive thrust at Mach number 0.6 decreased to about 0.73 lb/sq in. frontal area. Yaw angles of 0° to 20° had no significant effect on engine thrust at Mach numbers below 0.5 and only small effects at higher speeds. Specific fuel consumption reached a minimum of 5.3 lb of fuel per hr per hp between

(over)

Copies obtainable from NACA, Washington

NACA TN 3625

National Advisory Committee for Aeronautics.
INVESTIGATION OF THE PROPULSIVE CHARACTERISTICS OF A HELICOPTER-TYPE PULSE-JET ENGINE OVER A RANGE OF MACH NUMBERS AND ANGLE OF YAW. Paul J. Carpenter, James P. Shivers, and Edwin E. Lee, Jr. January 1956.
24p. diags., photos. (NACA TN 3625)

The nonwhirling propulsive characteristics of a helicopter-type pulse-jet engine mounted on a simulated rotor blade have been determined in the Langley 16-foot transonic tunnel. A propulsive thrust of about 1 lb/sq in. of engine frontal area at Mach numbers from 0.25 to 0.45 was obtained. Propulsive thrust at Mach number 0.6 decreased to about 0.73 lb/sq in. frontal area. Yaw angles of 0° to 20° had no significant effect on engine thrust at Mach numbers below 0.5 and only small effects at higher speeds. Specific fuel consumption reached a minimum of 5.3 lb of fuel per hr per hp between

(over)

Copies obtainable from NACA, Washington

1. Helicopters (1.7.3.2)
2. Engines, Pulse-Jet (3.1.6)
3. Combustion - Effect of Engine Operating Conditions and Combustion-Chamber Geometry (3.5.2)

- I. Carpenter, Paul J.
- II. Shivers, James P.
- III. Lee, Edwin E., Jr.
- IV. NACA TN 3625



NACA TN 3625
National Advisory Committee for Aeronautics.
INVESTIGATION OF THE PROPULSIVE CHARACTERISTICS OF A HELICOPTER-TYPE PULSE-JET ENGINE OVER A RANGE OF MACH NUMBERS AND ANGLE OF YAW. Paul J. Carpenter, James P. Shivers, and Edwin E. Lee, Jr. January 1956.
24p. diags., photos. (NACA TN 3625)

The nonwhirling propulsive characteristics of a helicopter-type pulse-jet engine mounted on a simulated rotor blade have been determined in the Langley 16-foot transonic tunnel. A propulsive thrust of about 1 lb/sq in. of engine frontal area at Mach numbers from 0.25 to 0.45 was obtained. Propulsive thrust at Mach number 0.6 decreased to about 0.73 lb/sq in. frontal area. Yaw angles of 0° to 20° had no significant effect on engine thrust at Mach numbers below 0.5 and only small effects at higher speeds. Specific fuel consumption reached a minimum of 5.3 lb of fuel per hr per hp between

(over)

Copies obtainable from NACA, Washington

1. Helicopters (1.7.3.2)
2. Engines, Pulse-Jet (3.1.6)
3. Combustion - Effect of Engine Operating Conditions and Combustion-Chamber Geometry (3.5.2)

- I. Carpenter, Paul J.
- II. Shivers, James P.
- III. Lee, Edwin E., Jr.
- IV. NACA TN 3625



1. Helicopters (1.7.3.2)
2. Engines, Pulse-Jet (3.1.6)
3. Combustion - Effect of Engine Operating Conditions and Combustion-Chamber Geometry (3.5.2)

- I. Carpenter, Paul J.
- II. Shivers, James P.
- III. Lee, Edwin E., Jr.
- IV. NACA TN 3625



NACA TN 3625

Mach numbers of 0.4 and 0.5. Comparison of whirling and nonwhirling data indicates significant performance losses due to whirling above centrifugal accelerations of about 200g.

Copies obtainable from NACA, Washington



NACA TN 3625

Mach numbers of 0.4 and 0.5. Comparison of whirling and nonwhirling data indicates significant performance losses due to whirling above centrifugal accelerations of about 200g.

Copies obtainable from NACA, Washington



NACA TN 3625

Mach numbers of 0.4 and 0.5. Comparison of whirling and nonwhirling data indicates significant performance losses due to whirling above centrifugal accelerations of about 200g.

NACA TN 3625

Mach numbers of 0.4 and 0.5. Comparison of whirling and nonwhirling data indicates significant performance losses due to whirling above centrifugal accelerations of about 200g.

Copies obtainable from NACA, Washington



Copies obtainable from NACA, Washington



NACA TN 3625

National Advisory Committee for Aeronautics.
INVESTIGATION OF THE PROPULSIVE CHARACTERISTICS OF A HELICOPTER-TYPE PULSE-JET ENGINE OVER A RANGE OF MACH NUMBERS AND ANGLE OF YAW. Paul J. Carpenter, James P. Shivers, and Edwin E. Lee, Jr. January 1956. 24p. diags., photos. (NACA TN 3625)

The nonwhirling propulsive characteristics of a helicopter-type pulse-jet engine mounted on a simulated rotor blade have been determined in the Langley 16-foot transonic tunnel. A propulsive thrust of about 1 lb/sq in. of engine frontal area at Mach numbers from 0.25 to 0.45 was obtained. Propulsive thrust at Mach number 0.6 decreased to about 0.73 lb/sq in. frontal area. Yaw angles of 0° to 20° had no significant effect on engine thrust at Mach numbers below 0.5 and only small effects at higher speeds. Specific fuel consumption reached a minimum of 5.3 lb of fuel per hr per hp between

Copies obtainable from NACA, Washington

(over)

1. Helicopters (1.7.3.2)
2. Engines, Pulse-Jet (3.1.6)
3. Combustion - Effect of Engine Operating Conditions and Combustion-Chamber Geometry (3.5.2)

- I. Carpenter, Paul J.
- II. Shivers, James P.
- III. Lee, Edwin E., Jr.
- IV. NACA TN 3625



NACA TN 3625

National Advisory Committee for Aeronautics.
INVESTIGATION OF THE PROPULSIVE CHARACTERISTICS OF A HELICOPTER-TYPE PULSE-JET ENGINE OVER A RANGE OF MACH NUMBERS AND ANGLE OF YAW. Paul J. Carpenter, James P. Shivers, and Edwin E. Lee, Jr. January 1956. 24p. diags., photos. (NACA TN 3625)

The nonwhirling propulsive characteristics of a helicopter-type pulse-jet engine mounted on a simulated rotor blade have been determined in the Langley 16-foot transonic tunnel. A propulsive thrust of about 1 lb/sq in. of engine frontal area at Mach numbers from 0.25 to 0.45 was obtained. Propulsive thrust at Mach number 0.6 decreased to about 0.73 lb/sq in. frontal area. Yaw angles of 0° to 20° had no significant effect on engine thrust at Mach numbers below 0.5 and only small effects at higher speeds. Specific fuel consumption reached a minimum of 5.3 lb of fuel per hr per hp between

Copies obtainable from NACA, Washington

(over)

1. Helicopters (1.7.3.2)
 2. Engines, Pulse-Jet (3.1.6)
 3. Combustion - Effect of Engine Operating Conditions and Combustion-Chamber Geometry (3.5.2)
- I. Carpenter, Paul J.
 - II. Shivers, James P.
 - III. Lee, Edwin E., Jr.
 - IV. NACA TN 3625

