

# AMPTIAC

74136



**AN INVESTIGATION  
OF ACOUSTIC EMISSION  
FROM DEFECT FORMATION  
IN STAINLESS STEEL WELD COUPONS**

**JANUARY 1969**



**AEC RESEARCH &  
DEVELOPMENT REPORT**

Reproduced From  
Best Available Copy

**DISTRIBUTION STATEMENT A**  
Approved for Public Release  
Distribution Unlimited

20000519 120

## LEGAL NOTICE

This report was prepared as an account of Government sponsored work. Neither the United States, nor the Commission, nor any person acting on behalf of the Commission:

A. Makes any warranty or representation, expressed or implied, with respect to the accuracy, completeness, or usefulness of the information contained in this report, or that the use of any information, apparatus, method, or process disclosed in this report may not infringe privately owned rights; or

B. Assumes any liabilities with respect to the use of, or for damages resulting from the use of any information, apparatus, method, or process disclosed in this report.

As used in the above, "person acting on behalf of the Commission" includes any employee or contractor of the Commission, or employee of such contractor, to the extent that such employee or contractor of the Commission, or employee of such contractor prepares, disseminates, or provides access to, any information pursuant to his employment or contract with the Commission, or his employment with such contractor.

### PACIFIC NORTHWEST LABORATORY

RICHLAND, WASHINGTON

operated by

BATTELLE MEMORIAL INSTITUTE

for the

UNITED STATES ATOMIC ENERGY COMMISSION UNDER CONTRACT AT(45-1)-1830

BNWL-902

UC-37, Instruments

AN INVESTIGATION  
OF ACOUSTIC EMISSION  
FROM DEFECT FORMATION  
IN STAINLESS STEEL WELD COUPONS

by

C. K. Day

Nondestructive Testing Department  
Systems and Electronics Division

FIRST UNRESTRICTED  
DISTRIBUTION MADE

JAN 31 '69

January 1969

BATTELLE MEMORIAL INSTITUTE  
PACIFIC NORTHWEST LABORATORY  
RICHLAND, WASHINGTON 99352

Printed in the United States of America  
Available from  
Clearinghouse for Federal Scientific and Technical Information  
National Bureau of Standards, U. S. Department of Commerce  
Springfield, Virginia 22151  
Price: Printed Copy \$3.00; Microfiche \$0.65

AN INVESTIGATION OF ACOUSTIC EMISSION FROM DEFECT FORMATION  
IN STAINLESS STEEL WELD COUPONS

C. K. Day

ABSTRACT

Results of an exploratory investigation to determine capabilities and limitations of acoustic emission techniques for detecting weld defects are presented in this report. Acoustic emissions reveal cracks while they form during the welding operation; data indicate that gross porosity can also be detected with this technique. Interference signals, similar to acoustic emissions from bonafide weld defects, can be produced by scale flaking away from the weld surface, by electromagnetic interference, and by impact on the weld material by tools, welding rods, and other metal objects. Suggestions for reducing the effects of interference signals are included in the report.

end

CONTENTS

INTRODUCTION . . . . .	1
SUMMARY . . . . .	1
Conclusions . . . . .	2
Recommendations . . . . .	3
DISCUSSION . . . . .	3
Theory . . . . .	3
Experimental Procedure . . . . .	4
Weld Coupons and Holding Fixture . . . . .	5
Instrumentation . . . . .	8
Record . . . . .	8
Analysis . . . . .	11
Experimental Results . . . . .	13
Comments on a Prototype Monitor System . . . . .	13
ACKNOWLEDGMENTS . . . . .	30
REFERENCES . . . . .	32
APPENDIX . . . . .	A-1

FIGURES

1	Weld Coupon (Material 304L and 316 Stainless Steel)	6
2	Weld Coupon Restraining Fixture with Coupons and the PZT Transducers	7
3	Acoustic Emission Produced by Crack Formation in a Weld and Detected at the Rayleigh Critical Angle	10
4	Block Diagram of System Used to Record Acoustic Emission Data	12
5	Welder Starting Transient. (Lower Signal Monitored by the Reference Channel While Upper Trace is the Same Signal Rectified and Filtered for Use as a Start-Stop Command Used in Data Analysis.)	14
6	Block Diagram of System Used to Analyze Acoustic Emission Data	15
7	Recording and Analyzing Instrumentation	16
8	Transverse Metallographic Section of a Weld Divided into Three Regions for Crack Length Determinations and Correlation Studies	19
9	Acoustic Emission Versus Crack Length (as Measured from Three Metallographic Sections Each) for the Center Region of 24 Welds. (The Numbered Welds Correspond to Samples for Which Data Are Shown in Figures 10 and 11.)	21
10	Acoustic Emission from Three Welds of Different Quality. Total Relative Crack Lengths from Three Metallographic Sections of Each Weld Are: A. Weld No. 25, 0.52; B. Weld No. 27, 5.8; C. Weld No. 23, 6.9. (See Figure 11 for Photomicrographs.)	22
11	Photomicrographs of Test Welds with Differing Weld Quality	23

12	Acoustic Emission from (A) Welds Which Had No Visible Hot Cracks After the First or Second Pass and (B) from Welds Which Contained Visible Hot Cracks During the Same Passes. (See Figure 13 for Photomicrographs of the Numbered Welds in this Figure.)	26
13	Bottom Region of Weld Samples Where Hot Cracks Formed and Were Detected Visually During the Welding Operation.	27
14	Test Welds Containing Porosity. (Large amounts of Acoustic Emission Were Produced by These Welds.)	28
15	Welds Producing Acoustic Emission from Cracks that Were Not Detected by Conventional Radiographic Techniques.	29

#### TABLES

1	Summary of Weld Quality Versus Total Acoustic Emission	17
---	--	----

AN INVESTIGATION OF ACOUSTIC EMISSION FROM DEFECT FORMATION  
IN STAINLESS STEEL WELD COUPONS

C. K. Day

INTRODUCTION

Few in situ or real time weld quality tests exist today since most nondestructive testing takes place after completion of a weld, or in many instances, after a large number of welds. At this point repair can become costly. Therefore, early detection of defects is very desirable. One phenomenon which offers promise as an on-the-line test of weld quality is known as acoustic emission.

Acoustic emission refers to an elastic wave generated within a material by an abrupt stress change such as crack formation or growth. Since emission signals are known to propagate several feet, they provide excellent means for remotely monitoring weld quality during the welding process.

The fact that acoustic emission is produced during a welding operation by the formation of weld defects was demonstrated by earlier experiments.<sup>(1)</sup> The work reported here is essentially a continuation of that original investigation. Other research has established a relationship between acoustic emission rate and the temperature at which weld defects produce emission.<sup>(2)</sup> It is the purpose of this report to discuss some of the capabilities and limitations of detecting weld defects by acoustic emission techniques.

SUMMARY

Acoustic emission is produced by weld defects such as cracking and gross porosity. A study directed at determining the capabilities and limitations of using acoustic emission as a nondestructive test for weld defects is described in this report.

Twenty-nine butt welds were monitored using piezoelectric transducers to sense acoustic emission created by the formation of defects. These signals were stored for later analysis on magnetic tape. Defects revealed radiographically and metallographically were successfully correlated with acoustic emission data.

### CONCLUSIONS

From the results of this study, the following conclusions can be drawn concerning the application of acoustic emission techniques to the problem of detecting weld defects as they form.

1. Acoustic emission is produced by crack formation and growth. There are also indications that porosity formation produces acoustic emission.
2. The amount of acoustic emission observed is related to the size and number of defects in the weld region, but the degree of dependence could not be established because of difficulty in describing actual weld quality.
3. Scale produced by oxidation can flake away from the weld region and produce signals which could be mistaken for acoustic emission from weld defects. This source of background noise can be discriminated against and the effects of such noise reduced to acceptable levels.
4. Metal objects such as the welding torch, tools, and filler rod, which strike the sample, can create signals similar to acoustic emission. Signal processing techniques exist which can and do discriminate between acoustic emission signals and the spurious signals caused by welding-related noise generators.

5. No difference in the welding characteristics of 304L and 316 Stainless Steel from the standpoint of acoustic emission was observed.
6. Large cracks, metallographically confirmed in two poor quality welds, were not detected by radiographic techniques, but gave strong acoustic emission signals.
7. Frequency spectra of acoustic emission pulses were not utilized in this investigation.

### RECOMMENDATIONS

Results of this work suggest that future studies of the relation of acoustic emission to weld quality should include the following:

1. A study of the high frequency characteristics of acoustic emission from weld defects should be conducted.
2. Based on the results of (1) a monitoring system with narrow band characteristics should be designed and evaluated since this technique minimizes the influence of external noises.
3. Transducers capable of observing only longitudinal critical angle signals should be investigated for reducing the influence of scale flaking off the weld surface.
4. A study of thicker and longer welds should be conducted.
5. Additional studies of the frequency content of acoustic emission should be conducted using improved transducers which would not condition emission signals. This should offer additional information on defect type.

### DISCUSSION

#### THEORY

Acoustic emission is a wave produced by deformation and fracture mechanisms occurring within a material as a result

of localized overstress. Since the resultant wave is elastic in nature, it propagates throughout the material and can be sensed at the surface of the material and converted to an electrical signal by ultrasonic transducers. This forms the basis for adapting the phenomenon to nondestructive testing.

Certain types of weld defects result from overstress within the weld region and, during formation, create acoustic emission. The most notable of these are hot and cold cracking. Cracks which form at high temperatures when the weld starts to cool are referred to as hot cracks and those which form below 400 °F are considered cold cracks.<sup>(3)</sup> Acoustic emission was observed from both types of cracks during this investigation.

#### EXPERIMENTAL PROCEDURE

The purpose of the program was to define the capabilities and limitations of detecting weld defects by acoustic emission. To achieve this, 29 gas tungsten arc (GTA) butt welds were fabricated. Acoustic emission data produced during each weld were recorded on magnetic tape for later analysis. After a weld was completed, it was radiographed and then subjected to metallographic examination in order to define its actual quality. As a final step, acoustic emission data were compared with radiographic and metallographic data for each weld in order to establish a correlation between weld quality and the acoustic emission events produced.

The desired variation in weld quality was not easy to produce, but the following "tricks" were used:

1. No current decay. The welding torch was extinguished abruptly and pulled immediately away from the weld region.
2. Noncompatible metallic filler. Titanium, tantalum, and mild steel were tried.

3. Fusion pass. Since there would be little or no ferrite in a fusion pass to aid in preventing fis-suring, it was assumed that microfissures could be produced.
4. Occasional wash passes with higher current.
5. Longer arc lengths than normal.
6. Bubbling the argon cover gas through water.

#### WELD COUPONS AND HOLDING FIXTURE

Two types of stainless steel materials, 304L and 316, were used during the investigation. Weld coupons were constructed from each of these materials according to the drawing shown in Figure 1. A notch was included in the top of the coupon to allow mating with the restraining plate shown in Figure 2. In this way maximum restraint against stresses tending to pull the coupons together was achieved.

The weld coupons were beveled to  $37\ 1/2^\circ$  to produce an included angle of  $75^\circ$  for each butt weld. Filler metal was added manually to produce weave beads with approximately six passes required to complete each weld. Additional information on the welding procedure is included in the Appendix.

Besides providing weld coupon restraint, the weld fixture shown in Figure 2 was drilled to allow water to flow through the base plate. A copper backing bar was built into the base plate to increase the thermal conductivity in the region of the weld. The water flow and copper combined to provide a heat sink to hold the temperature of the weld coupons in a lower range throughout each multipass weld. This insured proper operation of the transducers since they were mounted only 2 in. from the center line of the weld and could have been destroyed by high temperatures. The heat sink also produced high stresses in the weld zone by rapid cooling.

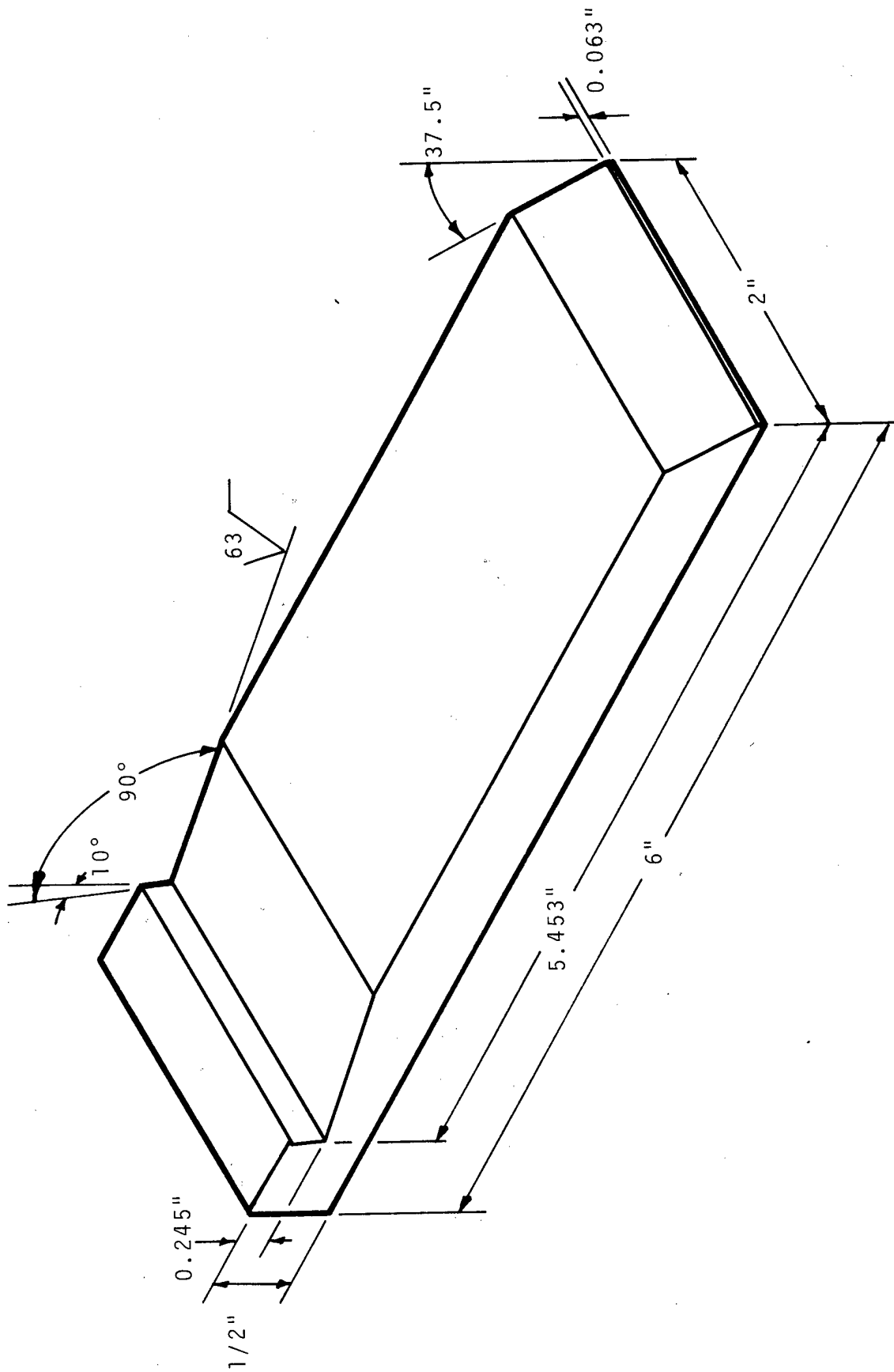
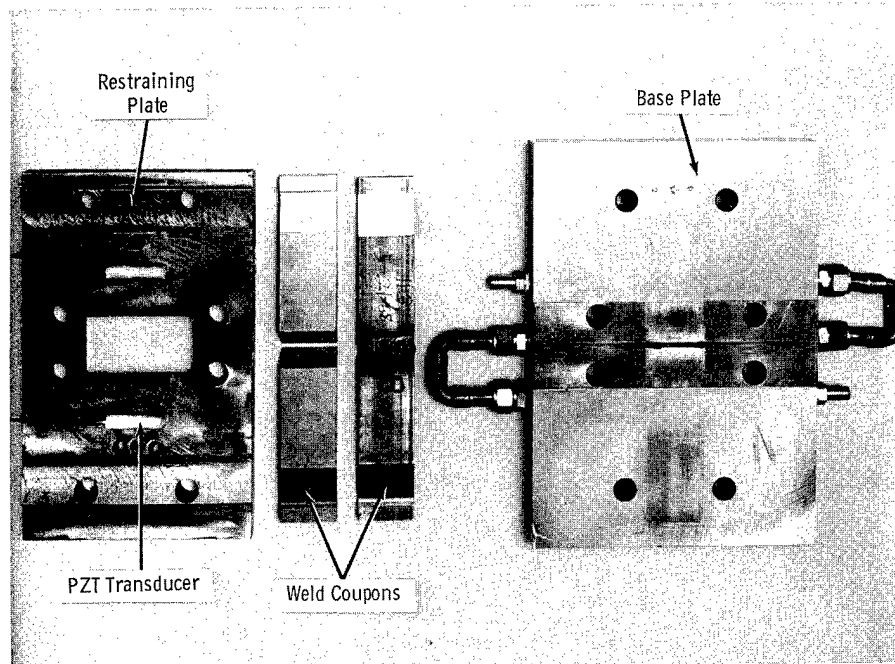


FIGURE 1. Weld Coupon (Material 304L and 316 Stainless Steel)



*FIGURE 2. Weld Coupon Restraining Fixture with Coupons and the PZT Transducers*

The restraining plate shown in Figure 2 was also drilled to provide for mounting four lead-zirconate-titanate (PZT) piezo-electric transducers, one for a mount perpendicular to the weld coupon and the others at the longitudinal, shear, and Rayleigh (surface wave) critical angles. The intent was to segregate the modes of acoustic emission propagation and study the advantages and disadvantages of each in an effort to maximize the ability to detect weld defects.

The angles for the mounting holes were based on Snell's law

$$\frac{\sin \theta_{wc}}{V_{wc}} = \frac{\sin \theta_T}{V_c}$$

$$\theta_T = \sin^{-1} \left( \frac{V_c}{V_{wc}} \sin \theta_{wc} \right)$$

where

$\theta_{wc}$  is the angle the direction of sound propagation makes with a normal to the weld coupons (assumed to be  $90^\circ$ ).

$\theta_T$  is the angle of the mounting holes (transducer) off a normal to the weld coupons.

$V_{wc}$  is the velocity of sound in the weld coupons.

$V_c$  is the velocity of sound in the couplant material.

Critical angle calculations resulted in the following transducer mounting angles: longitudinal  $-10.2^\circ$ ; shear  $-19.1^\circ$ ; Rayleigh  $-20.7^\circ$ .

## INSTRUMENTATION

### Record

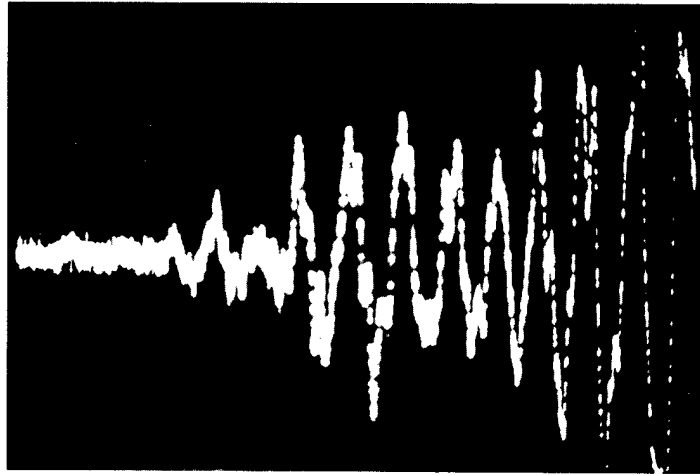
The electrical outputs of the PZT transducers were amplified by two types of electronic systems during this investigation. The more standard acoustic emission monitor system

consisting of low frequency "broadband" (1 kHz to 1 MHz) electronics was used throughout most of the program, but some effort was devoted to studying a high frequency "narrowband" (4 to 6 MHz) system. It was theorized that the weld defect mechanisms which produce acoustic emission occur in fast steps that create high frequencies, perhaps in the megahertz range.

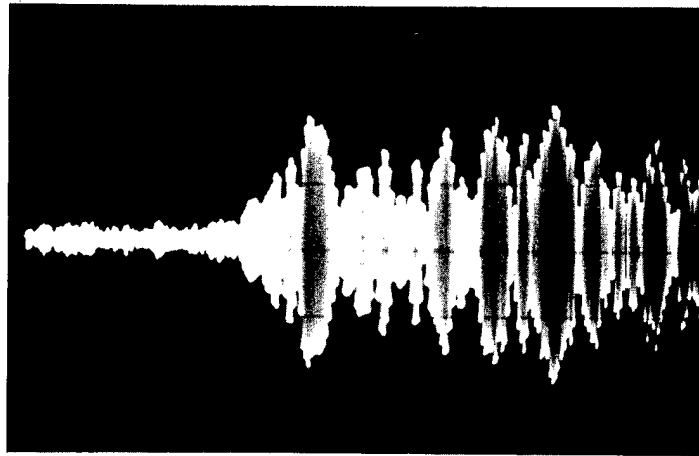
Successful use of the narrowband electronics system confirmed that a significant amount of energy is in the high frequency range (approximately 5 MHz). A comparison of the broadband and narrowband showed no advantage of one over the other as far as sensitivity to acoustic emission was concerned. However, in some areas the narrowband appears to offer other useful advantages over the more conventional low frequency systems. The narrowband is not as sensitive to external influences such as touching or brushing the weld area with objects such as the tools, filler rod, or the welder's hand. The low frequency system was quite sensitive to these noise sources, and the resultant signals could be mistaken for acoustic emission from weld defects.

External low frequency noise sources have in general created problems for broadband monitor systems because of the high signal amplification required to detect acoustic emission. Quite often the noise is coupled through the amplifiers and obscures the emission. Narrowband electronics were not influenced by these noise sources. An additional advantage of narrowband can be explained by Figure 3. Both signals shown in A and B were observed from the same transducer and defective weld but at different times. The PZT transducer was set for the Rayleigh critical angle in both cases. The advantage offered by the high frequency system (B) is the much faster rise time. Since more accurate timing is possible with the leading edge of this signal it would be possible to triangulate to within one inch of a defect or closer, if this were a requirement.

A. 500 kHz Observed by Broadband Electronic System



5  $\frac{\mu\text{s}}{\text{cm}}$



B. High Frequency (5 MHz) Signal Detected by Narrowband Electronics

*FIGURE 3. Acoustic Emission Produced by Crack Formation in a Weld and Detected at the Rayleigh Critical Angle*

A block diagram of the overall system used to record acoustic emission data during the weld tests is shown in Figure 4. Because of the relatively long time required to complete a weld it was not possible to record on magnetic tape all of the weld test at the tape recorder's highest speed. This is normally desirable because frequency response is greatest at its fastest speed and this is necessary to preserve most of the frequency content of acoustic emission signals. However, frequency content was determined to be a function of transducer characteristics and was not considered to be important in describing a weld defect. Therefore, the electrical signals from acoustic emission events were rectified and filtered to produce a low frequency envelope which could be put on magnetic tape running at reduced speed which in turn allowed all data to be recorded.

A nonmounted reference PZT transducer and electronics identical to Channel 1 (see Figure 4), which monitored for weld defects, were used to monitor for electromagnetic interference. The reference channel was used during data analysis by comparing its output (Channel 4) against the weld monitor channels (1, 2 and 3). Most electromagnetic noise sources, which could appear as acoustic emission signals, were eliminated this way.

### Analysis

Analysis of acoustic emission data was accomplished using two techniques, both of which involved counting the signals. One approach counted the number of acoustic events occurring per second throughout the test. The other counted the number of signals during the interval from "welder on" to "welder on."

Each time the welding arc was struck, a high frequency electromagnetic wave was created and coupled into the instrumentation. A typical signal is shown in the lower trace of

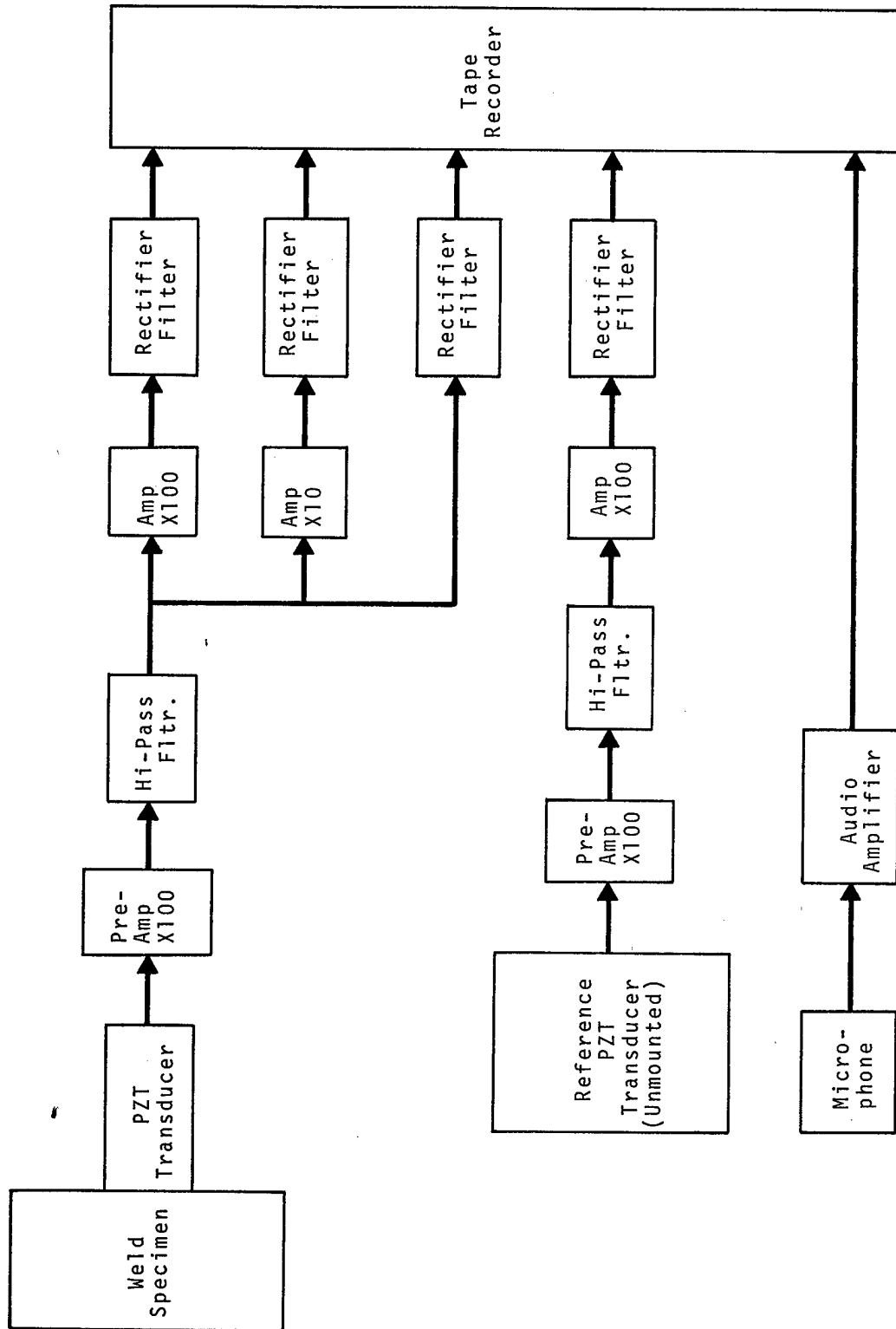


FIGURE 4. Block Diagram of System Used to Record Acoustic Emission Data

Figure 5. This signal provided a convenient way of starting and stopping an electronic counter used to total acoustic emission per weld pass or from "welder on" to "welder on." Each "welder on" pulse was rectified and filtered to produce the correct time and polarity required by the counter, as shown in the top trace of Figure 5.

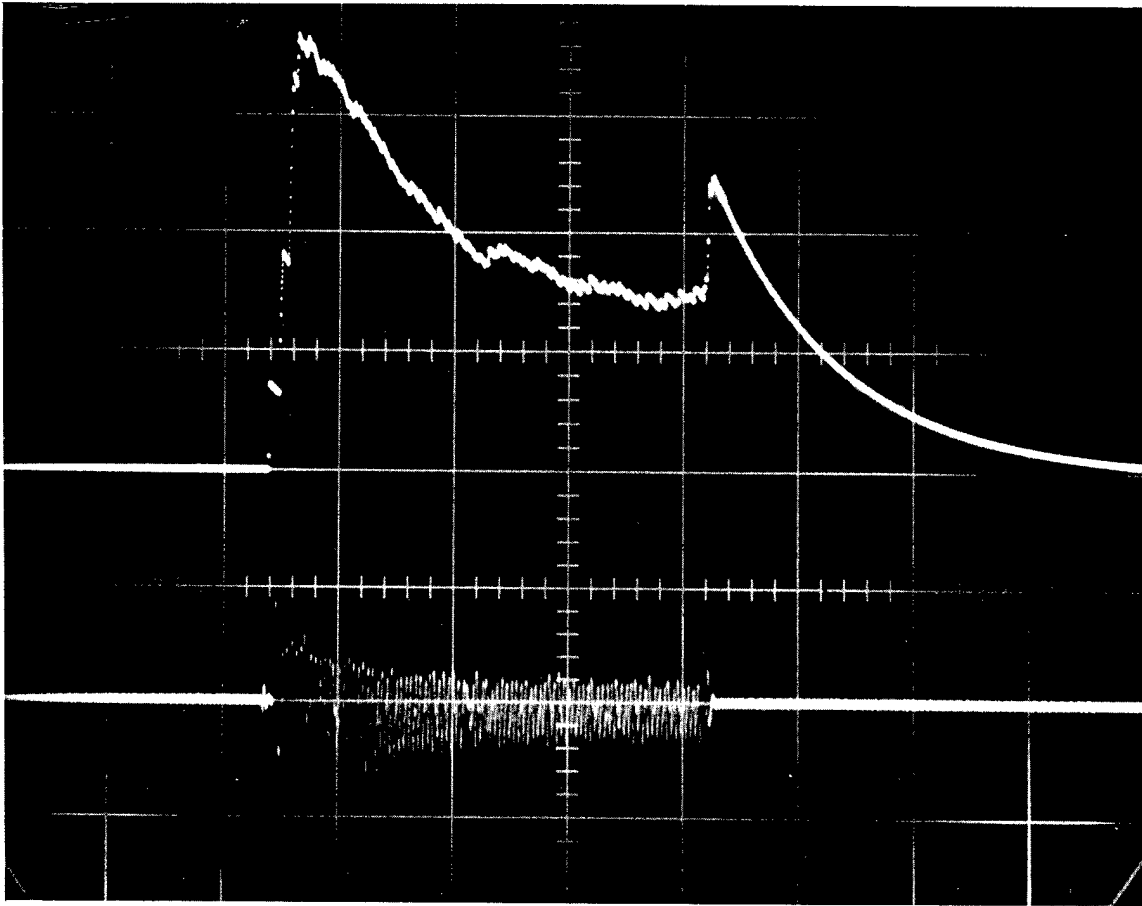
Acoustic emission from the linear gate, shown in the block diagram of Figure 6, triggered an oscilloscope which produced a pulse proportional to the length of the emission signal. These pulses were counted by electronic counter Number 1 which determined the pulse rate (acoustic emission per second) and counter Number 2 which integrated pulses from "welder on" to "welder on."

The recording and analyzing instrumentation is shown in Figure 7.

### EXPERIMENTAL RESULTS

Twenty-nine multipass butt welds were completed, eighteen on 304L and eleven on 316 Stainless Steel base material. Five of these had unusable acoustic emission data. A summary of the weld quality, based on data from radiography, is shown in Table 1 for each weld. Total acoustic emission events are also listed. A wide range of signals were produced during the study, from a low of 77 total acoustic emission events from weld Number 25 to a high of approximately 18,000 from weld Number 23.

Several factors contributed to the variations in the acoustic emission data presented in Table 1. One of the most important was the scale which flaked from the surface of some welds during cooling of the final passes. The amount of scale appeared to be a function of the welding technique and filler material. An example of its influence is demonstrated by Sample 8, which had 425 signals but was one of the best



*FIGURE 5. Welder Starting Transient. Lower Signal Monitored by the Reference Channel While Upper Trace is the Same Signal Rectified and Filtered for Use as a Start-Stop Command Used in Data Analysis.*

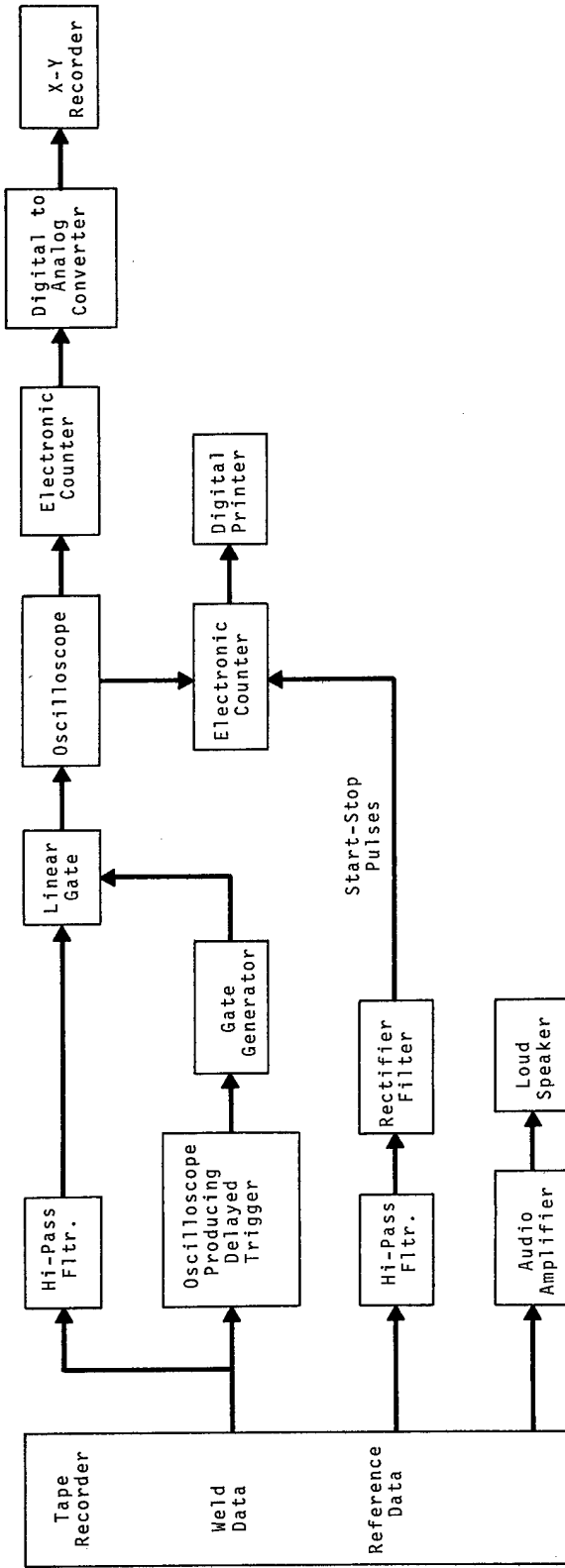
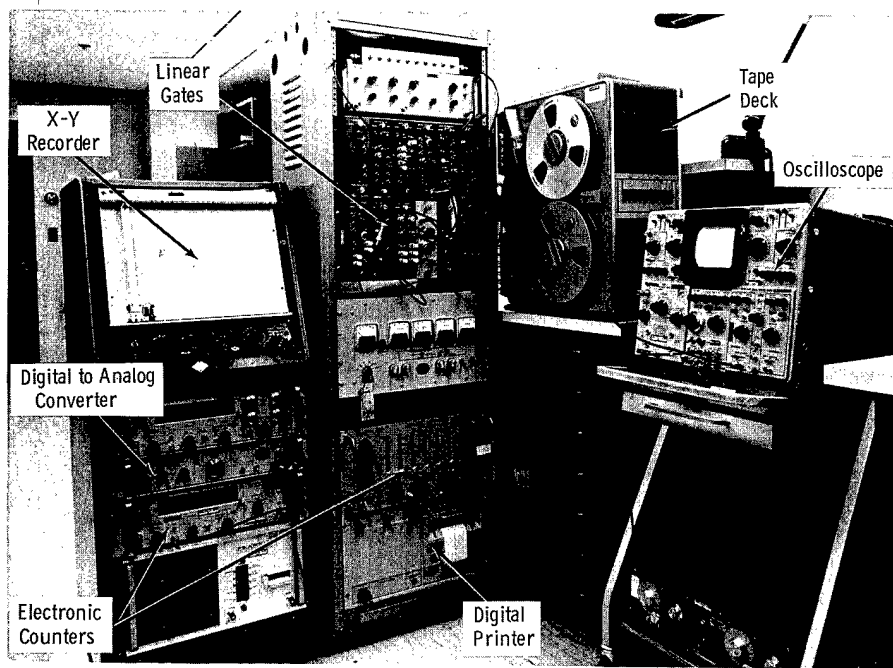
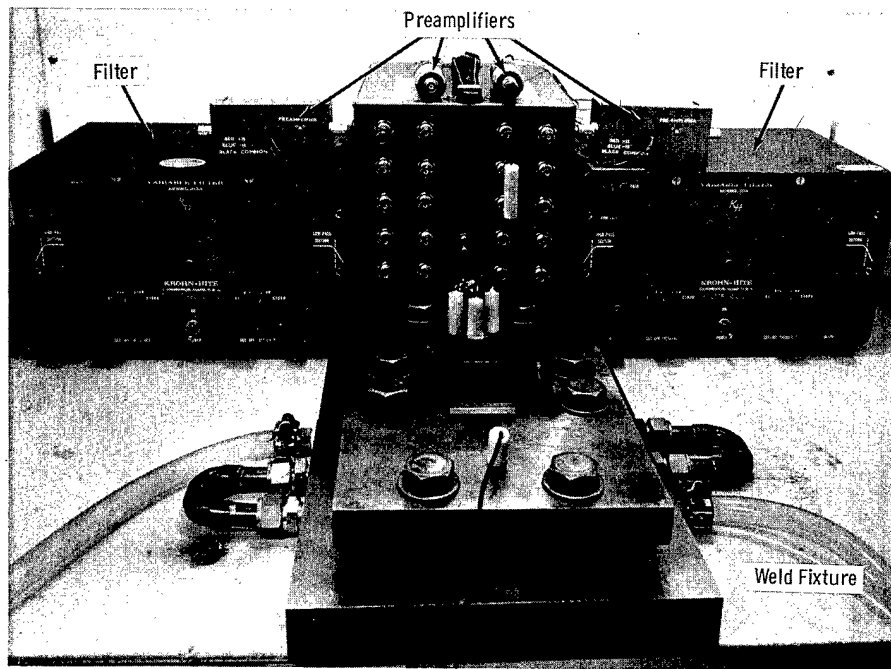


FIGURE 6. Block Diagram of System Used to Analyze Acoustic Emission Data



*FIGURE 7. Recording and Analyzing Instrumentation*

**TABLE 1. Summary of Weld Quality (a) Versus Total Acoustic Emission**

Weld Sample Number	Base Material	Filler Material	Incomplete Pene. Fusion	Porosity	Cracks	Total Acoustic Emission Signals	Comments
1	304L	308		X			No A.E. Data
2	304L	308	X	X			No A.E. Data
3	304L	308		X			No A.E. Data
4	304L	308	X	X		190	
5	304L	308		X		101	
6	304L	OXY-65&308	X	X		86	
7	304L	OXY-65	X	X	X	426	
8	304L	316				425	
9	304L	OXY-65	X		X	466	
10	304L	310			X	285	
11	304L	310			(d)	200	
12	304L	310 & Ti (b)			X	391	
13	304L	310	X	X	X	390	
14	304L	347 & Ti	X	X	(d)	10300	
15	304L	310 & Ti	X		X	13000	
16	304L	347	X	X	X		
17	316	316		X	X		No A.E. Data
18	316	310		X	X		No A.E. Data
19	316	310	X	X	X	1049	
20	316	OXY-65		X	X	138	
21	316	310	X	X	X	411	
22	316	316	X	X	X	324	
23	316	316	X	X	X	607	
24	316	316	X	X	X	18000	
25	316	308	X	X	X	306	
26	316	310 & Ti (c)	X	X	X	77	
27	316	310 & Ta	X	X	X	671	
28	304L	310	X	X	X	487	
29	304L	310 & Ta		X	X	264	
						207	

(a) Taken from radiographic data.

(b) Titanium

(c) Tantalum

(d) Cracks revealed by metallographic studies but not by radiography

welds made during the study. More than half of these signals resulted from flaking of scale. Since scale flakes off the surface, its influence might be reduced by setting the transducers at the longitudinal critical angle to get away from detecting surface waves.

Other errors in the acoustic emission data were produced by striking the weld coupons with objects such as the filler rod, tools, the welding torch, etc. Cleaning the weld region by brushing can also result in acoustic emission-like signals. However, special attention was given each of these items in order to minimize the errors.

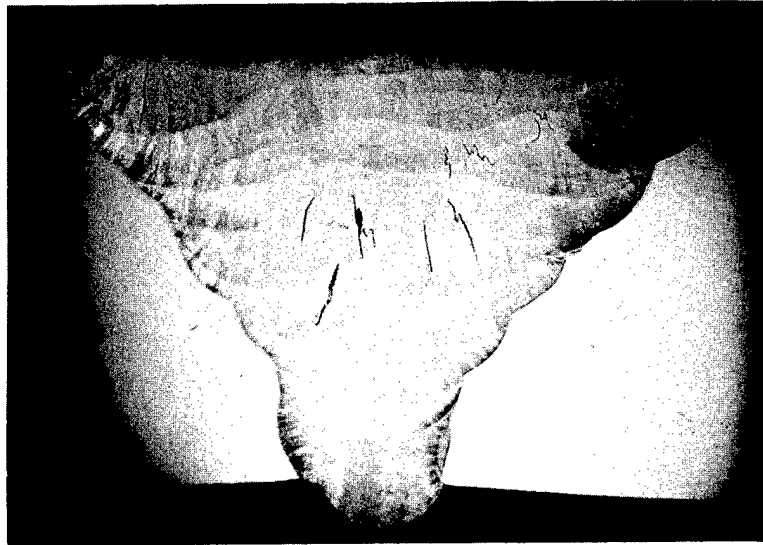
Radiographs of each weld were used as a basis for determining where to make transverse sections through the samples for metallographic studies. If a defect was visible on the X-ray film, the weld was cut and polished in this area. When the film showed no defects, random cuts were made. In all cases at least three sections were made across each weld. All sections removed from a weld were polished and etched. Photographs were then made of the samples at a magnification of 5X.

Examination for possible correlations between the actual weld quality and acoustic emission was made using the photomicrographs and the digital acoustic emission data resulting from the "welder on" to "welder on" analysis technique discussed under Analysis in the Instrumentation Section. Total crack length was determined from each photomicrograph according to the region (see Figure 8) of the weld. The approximate lengths of all cracks were determined and added to produce a number for each region representing total length. If a crack extended into two regions, its total length was considered to be in both regions and counted as such. Since there were three metallographic sections per weld, crack length was determined from each and added together to produce a single number for each region.

Top  
Region

Center  
Region

Bottom  
Region



*FIGURE 8. Transverse Metallographic Section of a Weld Divided into Three Regions for Crack Length Determinations and Correlation Studies*

Approximately six welding passes were required to complete a weld. Acoustic emission signals from the first two passes were assumed to have come from the bottom region, the third and fourth passes from the center region, and the last passes from the top region. Using the "welder on" to "welder on" analysis technique, a number was produced that represented the total acoustic emission for each welder pass.

As one might expect, a direct correlation between acoustic emission and crack length for the three regions was not obtained, mainly because determining crack length from only three photomicrographs taken out of a two-inch length is a very rough approximation. However, for the center region there were indications that a relationship exists between emission and weld quality. This is plotted in Figure 9 for the 24 usable welds made during the investigation.

When least square fitting and a straight line were assumed, the resulting coefficients produced the line also shown in Figure 9. Additional data from the three welds which lie along this line (25, 27, and 23) are shown in Figure 10. In this figure the amount of acoustic emission produced each second from the weld is plotted against test time. The fact that Weld Number 25 was metallographically one of the best produced is confirmed by the small amount of emission obtained from this specimen. Weld Number 27 was defective because of the addition of a 1/16 in. diameter 1/4 in. long piece of tantalum, and Number 23 was one of the worst welds produced as a result of adding titanium on the third pass.

Typical photomicrographs of the weld region for these samples are shown in Figure 11. The relative crack lengths were 0.52 for Sample 25, 5.4 for Weld 27, and 6.9 for Weld Number 23. As can be seen from the photomicrographs, there is a wide variation in the quality of 27 and 23 but they have

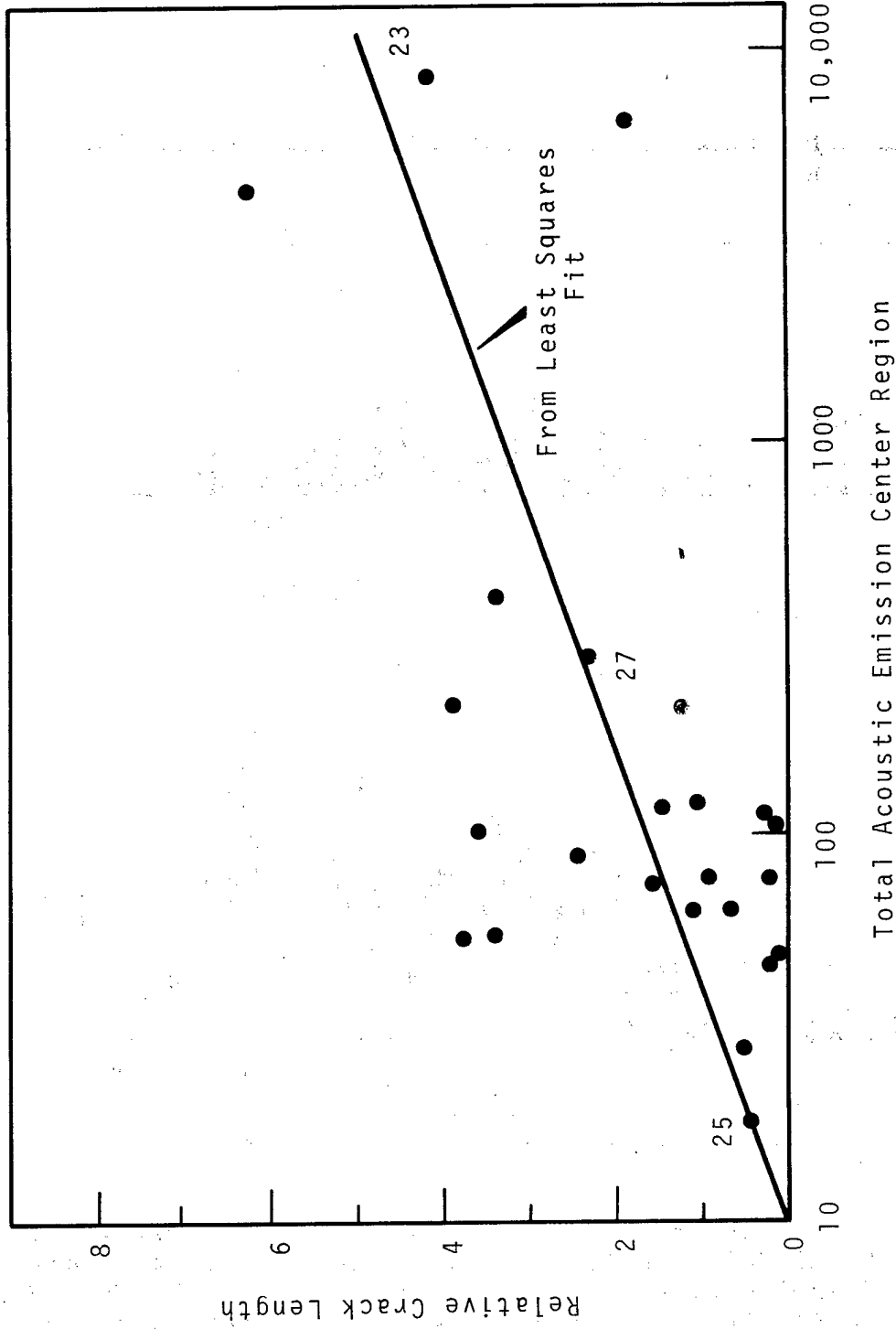
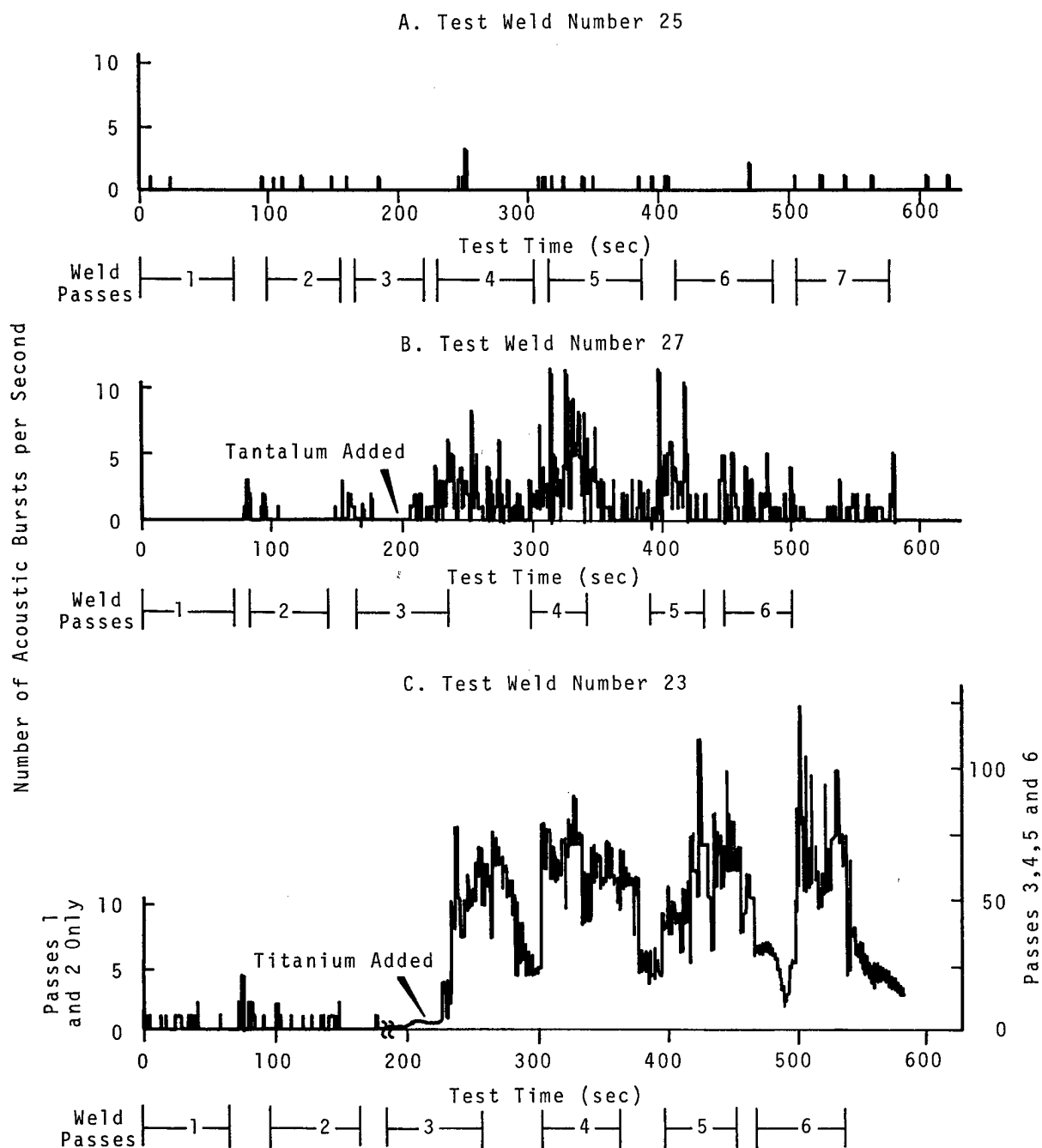


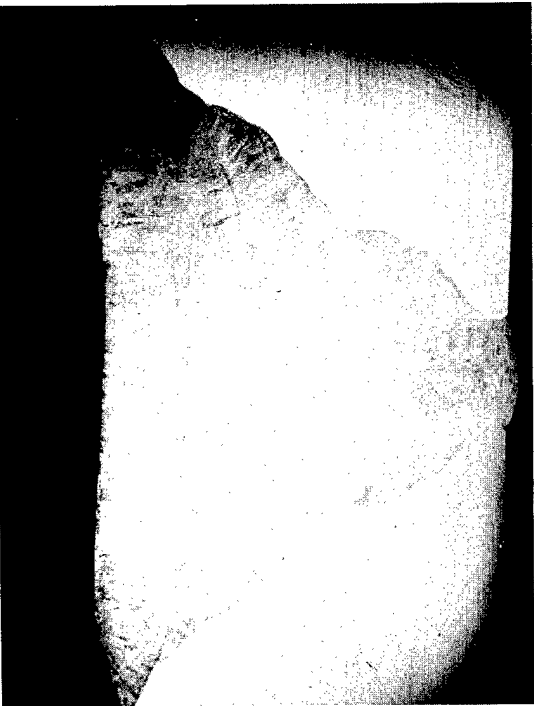
FIGURE 9. Acoustic Emission Versus Crack Length (as Measured from Three Metallographic Sections Each) for the Center Region of 24 Welds. (The Numbered Welds Correspond to those Samples for Which Data Are Shown in Figure 10 and 11.)



**FIGURE 10.** Acoustic Emission from Three Welds of Different Quality. Total Relative Crack Lengths from Three Metallographic Sections of Each Weld Are: A. Weld No. 25, 0.52; B. Weld No. 27, 5.8; C. Weld No. 23, 6.9. (See Figure 11 for Photomicrographs.)



B. Test Weld No. 27



A. Test Weld No. 25



C. Test Weld No. 23

FIGURE 11. *Photomicrographs of Test Welds with Differing Weld Quality*

approximately the same crack lengths. This is because of the difficulty associated with determining the actual length of cracks produced by the addition of titanium.

It should be pointed out that the data presented above are only for the center region and that a good correlation between crack length and acoustic emission for the top and bottom regions was not obtained. For these regions there was even more scattering than that shown in Figure 9.

Two factors contributed to the lack of correlation in the top region. First was the scale which flaked off from the weld of some samples during the passes. This produced acoustic emission-like signals that resulted in large errors for these samples. Also on some welds, especially those where titanium and tantalum were added, emission was received on weld passes corresponding to the top region that were produced by defects forming in the center region of the weld (long after the center passes were completed). The result was high acoustic emission counts but no significant defects in the top region.

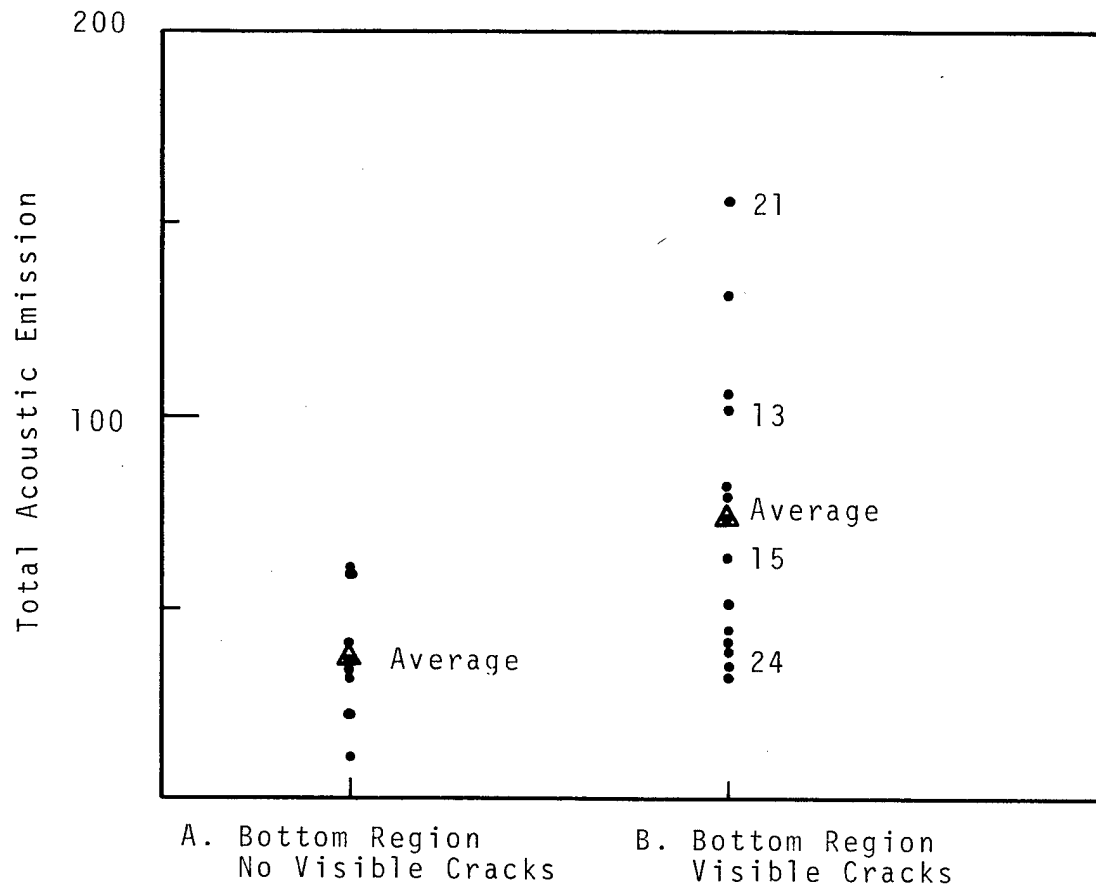
Acoustic emission corresponding to the bottom region varied from 11 counts to 150 and crack lengths from 0 to 2.4 in. with the other welds scattered in these ranges. In general there were a lot of emissions compared to the actual defects as determined from the photomicrographs for the bottom region. Contributing to this inconsistency were hot cracks which formed immediately behind the cooling puddle of the first passes in several samples. These cracks were detected during the visual inspection which followed each pass. They were in general quite shallow and some apparently remelted on subsequent weld passes because several photomicrographs showed no cracks in the region where they were observed during the weld operation.

Hot cracks which formed in the bottom region appeared to "flow" apart for some distance following the puddle of filler material as it cooled. During this growing period acoustic emission was not produced, which is contrary to experience with emission from crack growth.<sup>(4)</sup> Figure 12 shows, however, that in general more acoustic emission was obtained from samples where visible cracks were detected during the first passes than for those where cracks were not observed. Figure 13 is made up of photomicrographs of the four welds listed on Figure 12. Each of these welds had hot cracks that were observed during welding, but some were apparently remelted since they are not all detectable in the photomicrographs.

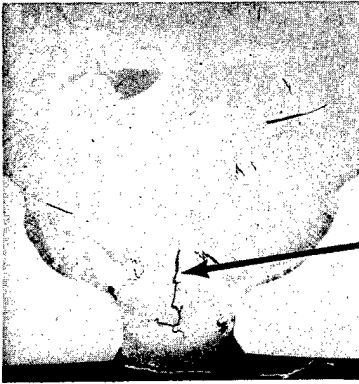
Crack formation appeared to be the weld defect causing most of the acoustic emission throughout this study. There were, however, indications that gross porosity formation produced some of the emission since high signal levels were obtained from Samples 7, 9, and 20, shown in Figure 14. These samples contain large amounts of porosity as demonstrated by the radiographs and photomicrographs. However, some cracking accompanied the porosity, and this may have been the source of all emission.

A comparison of data from all 304L welds with those from the 316 Stainless Steel welds did not indicate a significant difference between the materials. Similar defects were produced in both materials and acoustic emission from the defects gave no indication of differences.

All of the defective welds produced acoustic emission in varying degrees. Two cracked welds produced emission but were not considered as having cracks by radiography. These were Samples 11 and 14 shown in Figure 15. Two hundred signals were produced by Sample 11 while Weld 14 was one of the worst

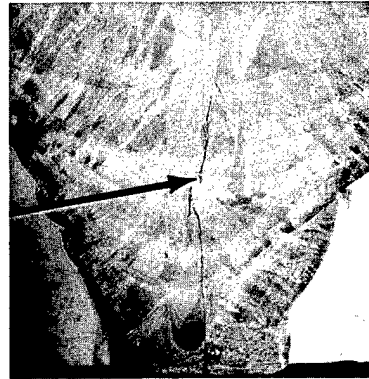


*FIGURE 12. Acoustic Emission from (A) Welds Which Had No Visible Hot Cracks After the First or Second Pass and (B) from Welds Which Contained Visible Hot Cracks During the Same Passes. (See Figure 13 for Photomicrographs of the Numbered Welds in this Figure.)*



A. Test Weld 21

Hot  
Cracks



B. Test Weld 13



C. Test Weld 15

Hot Cracks  
Apparently  
Remelted

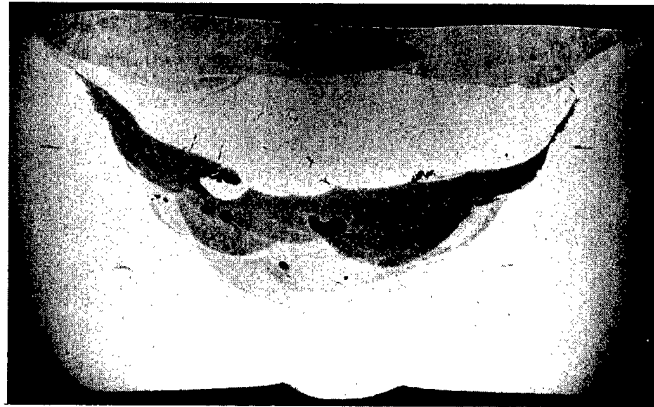
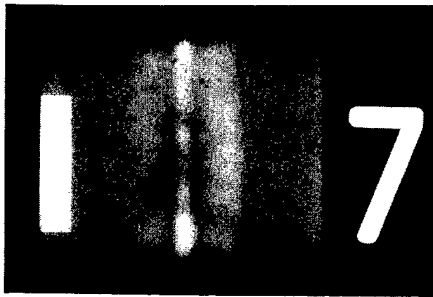


D. Test Weld 24

*FIGURE 13. Bottom Region of Weld Samples Where Hot Cracks Formed and Were Detected Visually During the Welding Operation*

Radiographs

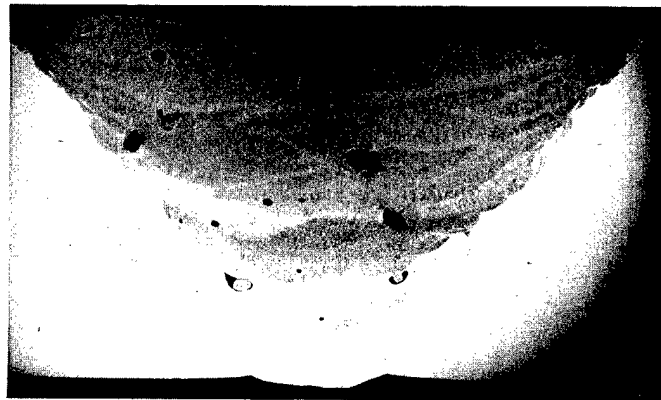
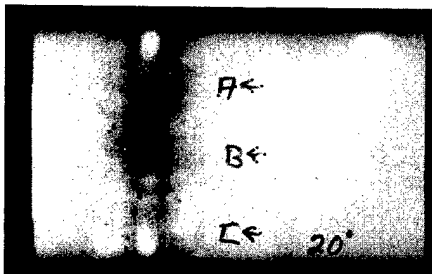
Photomicrographs



A. Test Weld No. 7  
Total Acoustic Emission 426

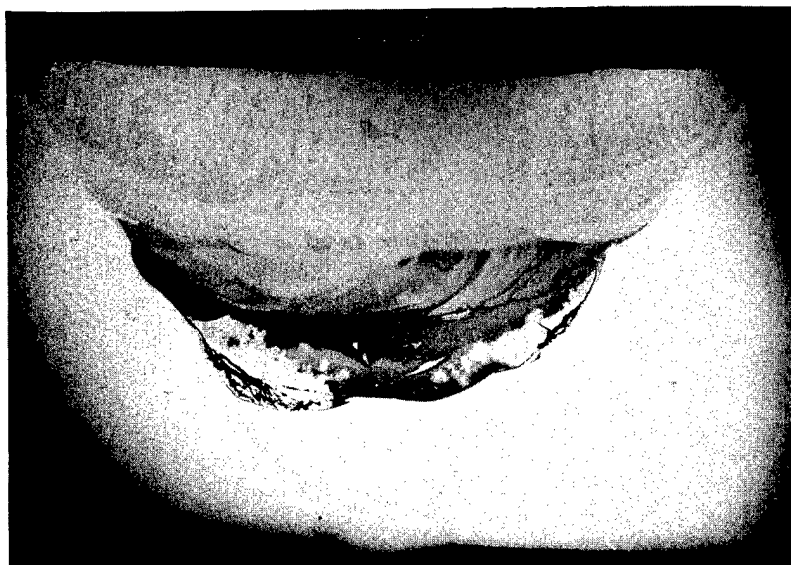


B. Test Weld No. 9  
Total Acoustic Emission 466

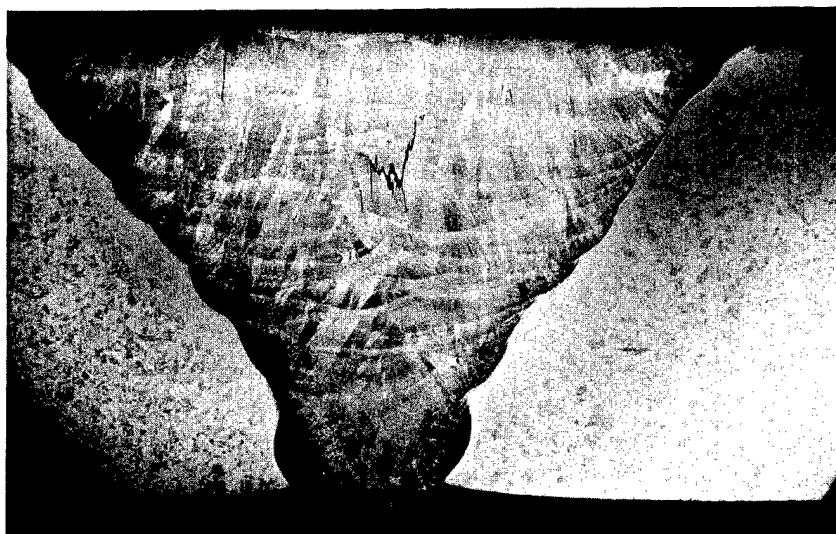


C. Test Weld No. 20  
Total Acoustic Emission 411

*FIGURE 14. Test Welds Containing Porosity. (Large Amounts of Acoustic Emission Were Produced by These Welds.)*



A. Test Weld No. 14  
Total Acoustic Emission 10300



B. Test Weld No. 11  
Total Acoustic Emission 200

*FIGURE 15. Welds Producing Acoustic Emission from Cracks that Were Not Detected by Conventional Radiographic Techniques.*

produced according to acoustic emission with approximately 10,000 signals observed. Photomicrographs of these samples are shown in Figure 15.

#### COMMENTS ON PROTOTYPE MONITOR SYSTEM

A description of the complete acoustic emission weld monitor system, based on the data from this investigation, would be difficult due to the limited scope of the program. The 304L and 316 Stainless Steel base metals used were typical reactor materials, but the coupon geometry and the way defects were produced may not, in most cases, be typical. However, some general comments could apply to any future system.

Since acoustic emission occurs as discrete packets of energy and it is thought that at least one or more is produced by each crack formation or movement, a method of summing the acoustic emissions or counting the rate of acoustic emission would appear to be the most useful processing techniques. Because both of these processes are dependent on the amplitude of the emission signal, it would be important to calibrate the system on the material and geometry which is to be welded.

Based on the results of this investigation, it appears that, for this geometry material and welding technique, an acoustic emission summation exceeding 200 would indicate either cracks or porosity. With titanium included in the weld, a total of 1000 signals or more would be positive indication of a defective weld. Stating a number, above which the weld is known is to be bad, however, depends on several things with the techniques used in this work. If the welder strikes the sample with tools or the torch, this could raise the total count because of the interference produced. Also, the environment in which the welding is conducted is important. That is, are there switching relays and other equipment which can interfere? In short, each weld situation would be considered by itself and a new set of standards developed.

Any future programs to produce a prototype system should devote more effort to producing weld defects which are more typical than the ones resulting from the addition of incompatible materials as used in this program. This would allow more confidence to be placed in any failure levels that were established. Also, improved detection techniques should be investigated to minimize noise interference.

Accurate location of the source of acoustic emission (weld defects) would be possible with a high frequency system. However, its need should again be determined by the weld to be completed. If the sample is small, it may not be necessary to use triangulation since the welder would probably have an idea of the defect location. If, on the other hand, the material to be welded were a large plate or vessel, triangulation should be a requirement because of the amount of welding involved and the difficulty in finding and repairing the proper region.

ACKNOWLEDGMENTS

The author wishes to express his appreciation to W. D. Jolly of the Pacific Northwest Laboratory who provided valuable suggestions during the preliminary stages of the study and continued to offer assistance throughout the course of the program. It is also a pleasure to acknowledge A. Rudy who did the welding and offered many excellent suggestions concerning variation of weld quality.

Special thanks are due W. F. Brown who offered considerable help with his suggestions during the early phases of the program.

REFERENCES

1. W. D. Jolly. Unpublished Data. Acoustic Emission from Weld Defects, NDT-MEMO-68-2. Pacific Northwest Laboratory, Richland, Washington, February 1968.
2. W. D. Jolly. An In-Situ Weld Defect Detector-Acoustic Emission, BNWL-817. Pacific Northwest Laboratory, Richland, Washington. To be published.
3. A. S. Tetelman and A. J. McEvily, Jr. Fracture of Structural Materials, John Wiley & Sons, Inc. New York, N.Y., 1967. pp. 543-546.
4. P. H. Hutton. "Acoustic Emission in Metals as an NDT Tool", Materials Evaluation, vol. XXVI, p. 125-129, July 1968.

BNWL-902

APPENDIX

WELDING PROCEDURE

## APPENDIX

WELDING PROCEDURE

A detailed description of the welding procedure and equipment follows:

1. Materials

- 1.1 Base Materials - 304L and 316 Stainless Steel  
1/2 × 2 × 6 in.
- 1.2 Filler Materials - 308L, 310, 316, 347, OXY-65, tantalum, and titanium.
- 1.3 Electrode - two percent thoriated tungsten electrode conforming with ASTM B297-65T, type EWTH-2 specification.
- 1.4 Inert Gas - Welding grade argon of 99.99% minimum purity was used for the shielding gas.

2. Joint Design

The joint design was a butt joint with a vee groove having a 75° included angle. The root face was approximately 1/16 in. The root opening was approximately 3/32 in.

3. Base Material Preparation

- 3.1 Edge Preparation - The plate edges were beveled by machining.
- 3.2 Cleaning - Some weld coupons were degreased with acetone.

4. Welding Process

Welding was accomplished by the gas tungsten arc process with manual filler rod feed.

5. Welding Equipment

The welder was a Sure Weld Model DR 401 with a 400 A direct current rectifier type power supply. A portable inert gas system was used in conjunction with the welder.

6. Welding Fixture

The coupons to be welded were grooved to allow mating with a restraining plate which was bolted to a base plate over the coupons to form a rigid fixture. A copper backing bar (1/2 × 3 × 10 in.) to back up the weld joint was inserted into the center of the base plate parallel to the direction of weld. A small groove 3/16 in. wide by 1/16 in. deep was machined into the center of the copper bar along the 10 in. length. The base plate contained three 1/2 in. diameter holes through the 10 in. dimension to allow for water flow. The top (restraining) plate was drilled to allow for the mounting of four 1/2 in. diameter transducers.

7. Welding Position

Welding was done in the flat position.

8. Welding Procedure

- 8.1 Welds were made in multipasses. First pass bead and the remaining weave.
- 8.2 Shielding gas flow rate was 30 ft<sup>3</sup>/min.
- 8.3 Shielding gas nozzle diameter was 5/8 in.
- 8.4 The electrode diameter was 3/32 in. The arc end of the electrode was tapered to approximately 1/32 in. diameter.
- 8.5 No purging gas at the back side of the joint was used.
- 8.6 Direct current, straight polarity was used (tungsten electrode positive and work plate negative).

No. of  
CopiesOFFSITE

1	<u>AEC Chicago Patent Group</u> G. H. Lee
30	<u>AEC Division of Reactor Development and Technology</u> M Shaw, Director, RDT Asst Dir for Nuclear Safety Analysis & Evaluation Br, RDT:NS Environmental & Sanitary Engrg Br, RDT:NS Research & Development Br, RDT:NS Asst Dir for Plant Engrg, RDT Applications & Facilities Br, RDT:PE Components Br, RDT:PE Instrumentation & Control Br, RDT:PE Liquid Metal Systems Branch, RDT:PE Asst Dir for Program Analysis, RDT Asst Dir for Project Mgmt, RDT Liquid Metals Projects Br, RDT:PM FFTF Project Manager, RDT:PM (3) Asst Dir for Reactor Engrg Control Mechanisms Br, RDT:RE Core Design Br, RDT:RE (2) Fuel Fabrication Br, RDT:RE Fuel Handling Br., RDT:RE Reactor Vessels Br, RDT:RE Asst Dir for Reactor Tech Coolant Chemistry Br, RDT Fuel Recycle Br, RDT Fuels & Materials Br, RDT:RT Reactor Physics Br, RDT:RT Special Technology Br, RDT:RT Asst Dir for Engrg Standards, RDT
270	<u>AEC Division of Technical Information Extension</u>
1	<u>AEC Idaho Operations Office</u> Nuclear Technology Division C. W. Bills, Director
1	<u>AEC San Francisco Operations Office</u> Director, Reactor Division

No. of  
Copies

- 4     AEC Site Representatives  
       Argonne National Laboratory  
       Atomics International  
       Atomic Power Development Assoc.  
       General Electric Co.
- 2     Argonne National Laboratory  
       R. A. Jaross  
       LMFBR Program Office
- 7     Atomics International  
       D. J. Cockeram (5)
- Liquid Metal Information Center  
       J. J. Droher (2)
- 2     Babcock & Wilcox Co.  
       Atomic Energy Division  
       S. H. Esleeck  
       G. B. Garton
- 8     Bechtel Corporation  
       J. J. Teachnor, Project Administrator, FFTF
- 1     BNW Representative  
       N. A. Hill (ZPR-III)
- 1     Combustion Engineering  
       1000 MWe Follow-On Study  
       W. P. Staker, Project Manager
- 5     General Electric Co.  
       Advanced Products Operation  
       Karl Cohen (3)  
       Bertram Wolfe
- Nuclear Systems Programs  
       D. H. Ahmann
- 2     Gulf General Atomic Inc.  
       General Atomic Div  
       D. Coburn
- 1     Idaho Nuclear Corporation  
       D. R. deBoisblanc
- 1     Oak Ridge National Laboratory  
       Reactor Division  
       P. P. Holz

No. of  
Copies

- 1     Stanford University  
      Nuclear Division  
      Division of Mechanical Engrg  
      R. Sher
- 1     United Nuclear Corporation  
      Research and Engineering Center  
      R. F. Angelis
- 10    Westinghouse Electric Corp.  
      Atomic Power Division  
      Advanced Reactor Systems  
      J. C. R. Kelly

## ONSITE-HANFORD

- 1     AEC Chicago Patent Group  
      R. K. Sharp (Richland)
- 4     AEC RDT Site Representatives  
      P. G. Holsted
- 4     AEC Richland Operations Office  
      FFTF Program  
      C. L. Robinson  
      J. M. Shivley (3)
- 3     Battelle Memorial Institute
- 1     Bechtel Corporation  
      D. H. Weiss (Richland)
- 1     Westinghouse Electric Corp.  
      R. Strzelecki (Richland)
- 124   Battelle-Northwest  
      S. O. Arneson  
      E. R. Astley  
      J. M. Batch  
      C. A. Bennett  
      R. L. Brown  
      C. M. Cantrell  
      J. R. Carrell  
      W. E. Cawley

No. of  
Copies

Battelle-Northwest (contd)

W. L. Chase  
T. T. Claudson  
D. L. Condotta  
R. R. Cone  
J. H. Cox (2)  
K. O. Creek (2)  
C. K. Day (50)  
E. A. Evans  
L. M. Finch  
S. M. Gill  
K. M. Harmon  
R. A. Harvey  
R. E. Heineman  
J. W. Helm (2)  
P. L. Hofmann  
P. H. Hutton  
J. E. Irvin  
R. N. Johnson  
W. D. Jolly  
D. E. Mahagin  
W. B. McDonald  
R. A. Moen  
C. A. Munro  
C. R. Nash  
D. P. O'Keefe  
R. N. Ord  
H. N. Pederson (5)  
O. W. Priebe  
W. E. Roake  
R. L. Roske  
C. B. Shaw  
J. C. Spanner  
R. J. Squires  
C. A. Strand  
C. D. Swanson  
J. C. Tobin (2)  
J. F. Wett  
M. R. Wood  
D. C. Worlton  
J. M. Yatabe  
FFTF Files (10)  
Technical Information (5)  
Technical Publications (2)  
Legal (2)