

AFRL-SN-RS-TR-2000-63
Final Technical Report
May 2000

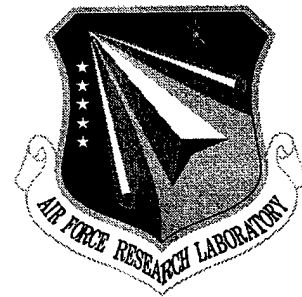

IMPROVED MATERIALS FOR PHOTOCROMIC OPTICAL MEMORY SUBSYSTEM (POMS)

Syracuse University

Joseph Chaiken

APPROVED FOR PUBLIC RELEASE; DISTRIBUTION UNLIMITED.

20000612 023

**AIR FORCE RESEARCH LABORATORY
SENSORS DIRECTORATE
ROME RESEARCH SITE
ROME, NEW YORK**

DTIC QUALITY INSPECTED 4

This report has been reviewed by the Air Force Research Laboratory, Information Directorate, Public Affairs Office (IFOIPA) and is releasable to the National Technical Information Service (NTIS). At NTIS it will be releasable to the general public, including foreign nations.

AFRL-SN-RS-TR-2000-63 has been reviewed and is approved for publication.

APPROVED:

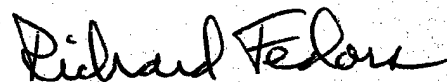

RICHARD FEDORS
Project Engineer

FOR THE DIRECTOR:

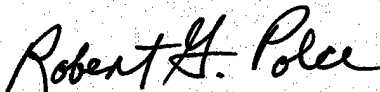

ROBERT G. POLCE, Chief
Rome Operations Office
Sensors Directorate

If your address has changed or if you wish to be removed from the Air Force Research Laboratory Rome Research Site mailing list, or if the addressee is no longer employed by your organization, please notify AFRL/SNDP, 25 Electronic Pky, Rome, NY 13441-4515. This will assist us in maintaining a current mailing list.

Do not return copies of this report unless contractual obligations or notices on a specific document require that it be returned.

REPORT DOCUMENTATION PAGE			Form Approved OMB No. 0704-0188	
Public reporting burden for this collection of information is estimated to average 1 hour per response, including the time for reviewing instructions, searching existing data sources, gathering and maintaining the data needed, and completing and reviewing the collection of information. Send comments regarding this burden estimate or any other aspect of this collection of information, including suggestions for reducing this burden, to Washington Headquarters Services, Directorate for Information Operations and Reports, 1215 Jefferson Davis Highway, Suite 1204, Arlington, VA 22202-4302, and to the Office of Management and Budget, Paperwork Reduction Project (0704-0188), Washington, DC 20503.				
1. AGENCY USE ONLY (Leave blank)	2. REPORT DATE MAY 2000	3. REPORT TYPE AND DATES COVERED Final Mar 98 - Mar 99		
4. TITLE AND SUBTITLE IMPROVED MATERIALS FOR PHOTOCROMIC OPTICAL MEMORY SUBSYSTEM (POMS)			5. FUNDING NUMBERS C - F30602-98-C-0023 PE - 62702F PR - 4600 TA - P6 WU - PO	
6. AUTHOR(S) Joseph Chaiken				
7. PERFORMING ORGANIZATION NAME(S) AND ADDRESS(ES) Syracuse University Office of Sponsored Research 113 Bowne Hall Syracuse NY 13244-1200			8. PERFORMING ORGANIZATION REPORT NUMBER	
9. SPONSORING/MONITORING AGENCY NAME(S) AND ADDRESS(ES) Air Force Research Laboratory/SNDP 25 Electronic Pky Rome NY 13441-4515			10. SPONSORING/MONITORING AGENCY REPORT NUMBER AFRL-IF-RS-TR-2000-63	
11. SUPPLEMENTARY NOTES Air Force Research Laboratory Project Engineer: Richard Fedors/SNDP/(315) 330-3608				
12a. DISTRIBUTION AVAILABILITY STATEMENT APPROVED FOR PUBLIC RELEASE; DISTRIBUTION UNLIMITED.			12b. DISTRIBUTION CODE	
13. ABSTRACT (Maximum 200 words) Photochromic materials based on transition metal oxides were synthesized during this effort, and evaluated for potential use in future optical processing components and subsystems. This work grew out of a collaborative university/government discovery that Tungsten Oxides reversibly change physical state when exposed to certain combinations of optical radiation. Various formulations including different dopings, oxide enhancements, microstructure modifications, and deposition methods were investigated as well. Samples produced during these synthesis experiments were characterized via wavelength, power, and Raman characteristics of their photochromic/electrochromic response. Results show significant promise for this technology in high-density optical memory, fast all-optical switching and a number of advanced digital processing applications.				
14. SUBJECT TERMS Photochromism, Electrochromism, Transition Metal Oxides, Tungsten Cluster Species, Sputtered & Sol-Gel Films, Sub-bandgap Transition, Raman Spectra, Optical Processing-Memory-Switching			15. NUMBER OF PAGES 52	
			16. PRICE CODE	
17. SECURITY CLASSIFICATION OF REPORT UNCLASSIFIED	18. SECURITY CLASSIFICATION OF THIS PAGE UNCLASSIFIED	19. SECURITY CLASSIFICATION OF ABSTRACT UNCLASSIFIED	20. LIMITATION OF ABSTRACT UL	

TABLE OF CONTENTS

I. Introduction to POMS Materials	1
Memory Discovery	1
Switching Behavior Discovery	4
Potential Applications	4
Outstanding Challenges	5
II. POMS Materials – Memory	6
Sub-Bandgap Wavelength Dependence of POMS Writing Process	6
Photochromic vs. Electrochromic Writing-Erasing	10
Sputtered vs. Sol-Gel Substrates	11
Cluster Materials Prospects	12
Spinning Disk Studies	15
III. Prospects for Scanning Probe POMS Memories	16
Rationale for Scanning Probes POMS	16
POMS Media Considerations	16
Materials and System Considerations	17
IV. POMS Materials for All-Optical Switching	17
Background Technology	17
Scientific Basis	18
Testing Tungsten Oxide-Based POMS Materials as All-Optical Switches	19
Film Thickness and Film Properties: sol-gel vs. sputtered	19
Film Thickness: first switching event and subsequent events	20
Switching Power	21
Switching Time	24
Cyclability/Electrochemical Erase	25
POMS Layers	26
V. Conclusions	28
Application Opportunities	28
Future Research	29
Bibliography	31

LIST OF FIGURES

1. Basic idea of the nonlinear interface optical switch (NIOS).	2
2. Apparatus for wavelength dependence and switching measurements.	7
3. Wavelength dependence of writing efficiency for equally oxygen-deficient sputtered films with varying thickness.	9
4. Varying write laser wavelength for a sol-gel sample of WO_3 on borosilicate glass substrate.	12
5. Structural representation of the decatungstate cluster anion ($W_{10}O_{32}^{-12}$).	13
6. Raman spectrum of the $MoO_3(4-4'-bipyridine)_4Mo_8O_{26}$ material.	14
7. The structure(top and side views) of $(4-4'-bipyridine)_4Mo_8O_{26}$.	15
8. Comparison of successive exposures on a film location, showing progressive writing and switching behavior.	20
9. Dependence of modulation depth on control power increases.	22
10. Dependence of switching on pulse duration at constant power.	25
11. Switch transmission decreases as control light is presented to active spot.	24
12. Deuterons have little effect on turn on or turn off time compared to protons.	25
13. Effect of increasing power of first exposure.	27

LIST OF TABLES

1. Characteristics of films selected for detailed study	19
---	----

I. Introduction to POMS Materials

The first materials for POMS, i.e. photochromic optical memory system, were molybdenum (VI) oxide and tungsten (VI) oxide. Results of this Expert Science and Engineering (ES&E) effort show that there are a number of other metal oxide systems which also exhibit useful photochromic behavior. This Final Report begins with a brief description of the initial discovery¹ and properties of the POMS process² and materials;³ the extension of the technology to include optical switching⁴ and memory functions; a non-exhaustive listing of the potential applications for the technology; and finally a discussion of the outstanding challenges for achieving new products which compete with or replace existing technologies. The next section presents the results of this current effort in testing new POMS materials for potential memory applications. Issues relating to the choice of visible laser wavelength, the use of sol-gel versus sputtered films, and the choice of substrate for spinning disk embodiments of POMS are reviewed. In the next section we report a few considerations which have become evident concerning POMS materials for extension to scanning probe type memories. The next section reports on systematic testing of the switching behavior for a few of the most promising thin film POMS materials. A final section presents a brief statement of the main conclusions.

Memory Discovery

The POMS process was discovered during an earlier ES&E contract, and reported in "Dual-Mode Photonic Devices," report AFRL-SN-RS-TR-98-30. The goal for that effort was to test a new type of all-optical switch architecture, the nonlinear interface optical switch (NIOS)⁵. At the time, one popular idea for introducing the advantages of optics into information processing was to implement data and control functions of optical processors by arrays of such switches in crude analogy with electronic computers. Such optical processors⁶ could only be implemented if there were optical switches analogous to electronic transistors. At the time, however, the only existing "photonic switches" were AT&T's self-electrooptic devices, or SEEDs. These devices were essentially electronic in nature, with a photodetector and a laser integrated on one section of GaAs. They were unsuitable to implement practical all-optical systems, though. SEEDs allowed light to control a switching operation with the creation of an optically coded logic state, but their operation required repeated interconversion between the electronic domain and the optical domain, thus defeating their overall purpose.

The NIOS was an attempt to provide an alternative to SEEDs. SEEDs represented a "device oriented" approach to photonic switching in which operation was based on existing electronic devices, i.e. photodetectors and lasers. The other approach is more "materials oriented" in that optical properties of materials would be exploited while the data itself is in the optical domain to achieve switching and other functions. The general idea is that system performance can be maximized, i.e. the contribution of the efficiencies and strengths of each kind of processing to overall system performance is maximized, when the number of data interconversions between optical and electronic domains is minimized.

For example, optical technology is intrinsically better suited to communication tasks, e.g. input/output (I/O), whereas silicon is intrinsically advantageous for processing tasks or

applications (logic/arithmetic). To achieve the type of system-wide improvement needed for the Air Force missions, we must maximize the ability to perform optical processing each time the data is in the optical domain. Therefore, a materials oriented approach seems essential to introducing optical technology into information processing.

The idea of the NIOS is simple and can be explained by reference to Figure 1. Kaplan⁷ proposed that light, i.e. data, incident on a suitable interface very near to Brewster's angle, could be switched between reflecting from and transmitting through the interface if the index of refraction difference between the two (or more) materials comprising the interface depended on the intensity of the light present at the interface. In this way the appropriate net intensity of control and data optical beams would cause switching and thus data and control information would begin and end with the information in the optical domain. Because Brewster's angle is a very sensitive function of index mismatch, only weak nonlinear optical properties would be needed to effect switching, thus loosening the constraints on the choice of suitable optical materials.

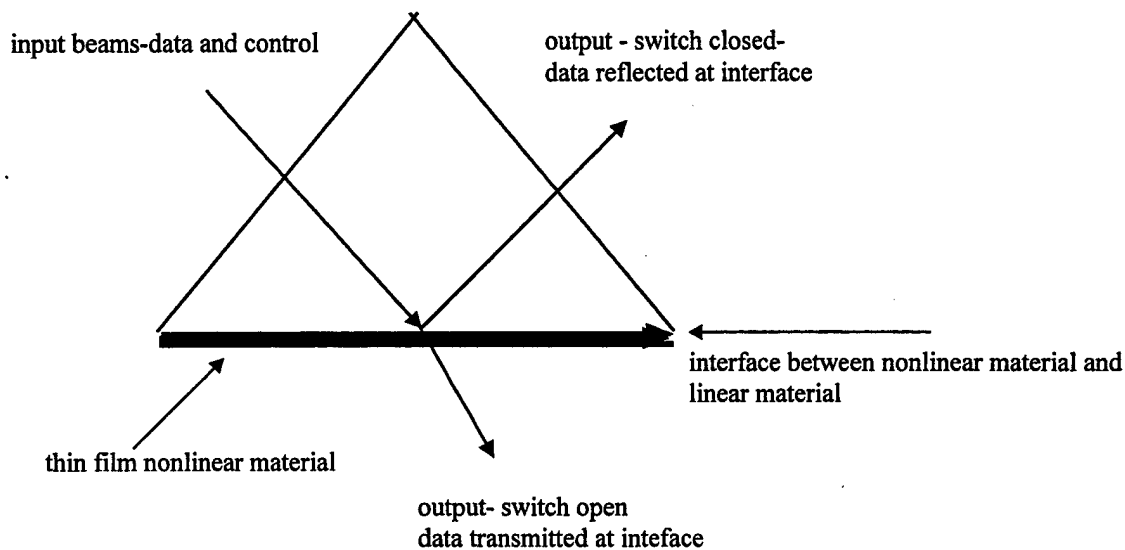

Figure 1. Basic idea of the nonlinear interface optical switch (NIOS).

(In this example, the NIOS is controlled by the net power presented to the interface between the nonlinear material and the substrate. If the total power is insufficient, then the switch remains closed and the data and control beams are reflected. Otherwise, the switch opens and the beams are transmitted. Other configurations are possible and were evaluated in this effort.)

Optical and electrooptic switching based on various well-known nonlinear optical processes, e.g. second harmonic conversion, sum-frequency generation, Kerr Effect, etc. are easily envisioned; but the materials⁸ to implement the large arrays of such switches that would be needed do not exist. Inorganic materials like niobates and titanates have excellent nonlinear optical coefficients and high damage thresholds, but suitable films are not yet possible to mass produce in the quantities and prices needed to implement large systems. Organic materials are generally easily

cast into films, but low damage thresholds prevent their introduction into nonlinear optical devices.

Materials based on atomic and molecular clusters have been predicted for years⁹ to have large nonlinear optical coefficients, but it has proven difficult to produce a wide variety of such materials in thin film form even for testing purposes. By "cluster materials" we denote materials whose state of aggregation consists of particles of a size small compared to the wavelength of whatever light is supposed to interact with it, but also large in that 10^3 - 10^6 atoms are involved in each "cluster." These entities may be very precisely defined in structure and stoichiometry as in the polyoxometallates utilized in this effort, or definable in terms of statistical measures such as the average cluster size and a given standard deviation. Such statistical measures are useful for correlating electronic structure to optical properties as well as being appropriate to materials which can only be synthesized in distributions, e.g. GaAs, CdS, CdSe. In the mid 1980's our group pioneered the use of laser chemistry for organometallics^{10,11} to produce cluster films of inorganic materials such as metal oxides and noble metals. Using proprietary techniques¹², cluster films of metals and metal oxides became accessible and so the opportunity to test switches utilizing the NIOS configuration based on such materials had arrived.

We chose to produce cluster films based on tungsten oxide because of the similarity of its lattice structure with perovskite niobates and titanates, and because suitable films would be economically reasonable within our synthesizing capabilities. In addition, tungsten oxide is well known to be electrochromic and to possess substantial photochromic response in the ultraviolet spectral range. We anticipated that the extensive literature on these processes¹³ would be valuable in trying to understand whatever behavior we would observe. Raman spectroscopy is often utilized to assess the chemical state of tungsten oxide based materials because of the unusual strength of the WO_3 scattering and the sensitivity of the spectrum to changes in tungsten-oxygen stoichiometry, i.e. tungsten oxidation state. To the best of our knowledge, other than to obtain Raman spectra, the Chaiken Group in collaboration with AFRL Rome Site personnel were the first to attempt to observe laser driven photochromism in any form on tungsten oxide.

Using laser chemical vapor deposition (LCVD) we did in fact produce and test, as confirmed by Auger and ESCA analysis, tungsten oxide cluster films having a WO_3 stoichiometry. These films had a nominal index of refraction @ 632.8 nm wavelength more or less equal, (2.2-2.4) to that reported for sputtered films and sol-gel based films. However, LCVD tungsten oxide films were found to exhibit only weak sensitivity to blue-green laser radiation, which is to say that they were poor switches. This was observed in spite of the fact that others¹⁴ had mentioned that WO_3 shows some "decomposition" when sufficiently high blue-green and even red laser power is utilized to obtain Raman spectra. This difference between conventional WO_3 materials and LCVD based materials remains an enigma and potentially useful in an empirical sense.

At the time of testing the switches, because we observed little switching effect using the LCVD materials and we had not yet experimented with sputtered or sol-gel films, we wanted to confirm that our instrumentation was not at fault in some way. To do so, we shifted our attention momentarily to conventional WO_3 which is commercially available in the form of a nominally

anhydrous powder of average particle size $\approx 10 \mu\text{m}$. While obtaining the Raman spectrum of the powder to compare with our LCVD films we found that "decomposition" was strongly affected by having blue-green light present in addition to some IR laser light.

In particular, 532 nm light was being used to excite the Raman spectrum which we obtained by frequency doubling a common 1064 nm YAG laser. Manually varying the phase matching angle for the doubling crystal modulates the frequency conversion process and thereby modulates the relative 532 nm:1064 nm content of the laser output. At low enough power, relatively clean 532 nm light produces a Raman spectrum that does not change over time. Whereas if the 1064 nm content is increased sufficiently, the Raman spectrum can be made to diminish substantially while the originally yellow WO_3 materials simultaneously changes from yellow to blue, i.e. W_2O_5 . Subsequently heating the material in air using either 1064 nm laser light alone or bulk heating changes the blue material back to yellow.

This was summarized in the literature¹⁵ and represents the discovery of the basic POMS process for memory applications. "Writing" data corresponds to exposing a region of yellow material to combined IR and blue-green light, thereby producing a blue spot. "Erasing" the data corresponds to heating the materials so that yellow spots are kept yellow but blue spots are changed back to yellow. The novel aspect of the POMS process was that it allowed use of convenient lasers delivering useful photons without regard to the fact that the photons were decidedly sub-bandgap in energy. This was not predicted by the extensive literature of either WO_3 electrochromism or photochromism, and it allowed us to think realistically about fabricating devices using commercial-off-the-shelf (COTS) lasers and other components.

Switching Behavior Discovery

A subsequent ES&E effort¹⁶ showed that in addition to the POMS change in Raman and optical absorbance/reflectance, i.e. the yellow to blue aspect of the writing process, the electrical properties such as electrical resistance also changed by orders of magnitude. Electrochromic behavior became evident as the material changed from yellow to blue, and the electrical resistivity decreased by as much as 6 orders of magnitude. This showed that it would be possible to produce so-called "dual mode" memories in which the data could be written and/or read and/or erased using either optical or electrical mechanisms. Thus a single device which can be accessed simultaneously using optical and electronic processors is conceivable.

While demonstrating these behaviors we discovered that using blue-green light as the control wavelength, in either a NIOS configuration or even a simple film on substrate configuration, the transmission of red light could be effectively switched¹⁷. It is clear that one part of this switching process is the POMS process itself but there are clearly other processes which occur.

Potential Applications

Immediate applications of the POMS process can be divided into memory and processing tasks. Partly due to this ES&E effort, the collaboration between the Chaiken Group, Laser Chemical

Corporation, and the AFRL Photonics Center have already shown¹⁸ that POMS is capable of performing all the memory tasks of conventional optical memory media such as phase change (PC) and magneto-optic (MO), in spinning disk format. However, PC and MO media have a niche in the marketplace and it currently seems unlikely that the POMS approach will be competitive with these technologies in those niches simply because of their head start.

For certain applications though, notably medical record storage, business records, government records, digital video and audio workstations applications requiring huge capacity in a single easily searchable volume, POMS media have an important technical advantage over all other media. PC and MO are difficult to produce in large size pieces, so that the total capacity of a reasonably priced single volume of memory based on these media is unlikely to exceed 30 Gbyte. POMS can achieve the same densities (both being limited by the wavelength of the light being used to process the media), but in addition POMS media can be produced in much larger pieces allowing the production of volumes capable of holding in excess of 2.5 Tbyte.

Such capacity is currently only available using magnetic tape media. But such media are very slow in virtually every function. Taped information is physically vulnerable to a variety of influences, e.g. magnetic fields. The POMS media are essentially two dimensional, being much faster for all processing. POMS media are comparatively robust to environment, have superior write contrast compared to all other optical media, and are expected to be less expensive to manufacture than either tape or other optical media. Thus POMS media offer superior performance to all other media for those applications requiring terabyte and greater storage capacity.

The most immediate opportunities for switching related applications of POMS media involve switching networks, routers and similar devices, particularly those related to packet switching technology. Integration with fiber amplifiers offers an unprecedented opportunity to produce all -optical devices with no electronics whatsoever in the actual data handling. We know less about the potential applications of POMS in switching partly because we know less of the characteristics of that general type of physical behavior.

Outstanding Challenges

As our understanding of the POMS and related processes and the associated materials matures, we begin to address the myriad challenges which must be met to transition laboratory behavior to commercially viable products. For example, the choice of visible wavelength which is used to implement a POMS based device has considerable flexibility in that all visible wavelengths are effective when applied in high enough power. But at higher powers the process becomes less a POMS type process and more a multiphoton ablation process. In order to discover to what extent the choice of wavelength can be deferred to engineering tradeoffs, it is necessary to examine the wavelength dependence of the efficacy of the POMS process. To our knowledge this is the first measurement of the sub-bandgap wavelength dependence of the photochromic writing efficiency in this widely studied material.

Comparing substrate materials in the context of POMS would give some rational basis for engineering decisions. Such a comparison would be useful for memory either for spinning disk technology or some other format, as well as for switching applications. The potential use of metal substrates has special significance with regard to POMS technology because of the electronic/optical equivalence. Potential POMS materials were synthesized to systematically search for improved materials. The guiding principles underlying the search were based on known photocatalytic behavior and physical characteristics of various materials specified in the patent literature. Another challenge which bears on the question of substrate involves the use of scanning probe technology for information storage. Finally, fundamental measurements related to switching power, rise time, fall time, and cyclability of POMS based switches were addressed.

II. POMS Materials - Memory

Sub-bandgap Wavelength Dependence of POMS Writing Process

Any memory system must consist of a memory medium and an associated drive, which together serve the basic functions of memory. The drive implements the processes whereby information is stored, retrieved and erased. These processes require a write channel, read channel and, when applicable, erase channel. A light source drives the channels, and for POMS two sources are needed. In the case of optical memory, storage density, device reliability, and cost are just a few of the most important consequences of the light source choice.

Except for the read channel, to implement these processes all the light sources must be lasers. In the case of the read channel, less intense sources can be employed but usually it will lower overall system overhead requirements to use the same laser source as for writing except at lower power. In the case of POMS, the write process can involve two sources; a visible source and an infrared source. Results from other studies have shown that the role of the infrared is to provide heat which serves to increase the writing efficiency. The overall writing efficiency and power threshold is limited by the choice of visible wavelength employed. The storage density, is limited by the diffraction spot size allowed by the choice of wavelength. We therefore investigated the media response to visible wavelength by itself without employing an infrared beam.

In the standard microscopic picture of the electronic and optical properties of solids, we need to consider the density and type of excited states which are in resonance with the ground state population and the applied radiation. But the writing process in POMS utilizes sub-bandgap wavelength light. In the lowest order approximation there are no excited states in such resonance, so there should be no absorption and no writing whatsoever. We suspect that the sub-bandgap states which mediate the POMS process occur from one of two sources. They certainly must be associated with species or structures, i.e. impurities and/or defects, which are not part of the lowest order approximation.

Earlier experiments have shown that the states in question are surface states and that they are associated with the presence of W^{+5} species dispersed among the majority W^{+6} species, which is

the major form of tungsten in most forms of tungsten oxide. For engineering purposes, an empirical determination of the wavelength dependence of the POMS writing efficiency will suffice to allow systems design and integration choices to be made rationally. Such a measurement will also help shed light onto the nature of the POMS process itself.

The measurements were made using the apparatus in Figure 2. In this experiment, a Coherent diode-pumped YAG laser is used to pump a Coherent XPO optical parametric oscillator (OPO) giving 2 nsec duration, 1-3 mJ laser pulses continuously tunable from about 425 nm to 620 nm. These pulses were imaged onto various films of tungsten oxide on 1/8 in thick quartz substrates using a microscope objective to obtain a diffraction-limited spot. The back-scattered white light source was imaged onto a CCD camera to allow fine adjustment of the focus and position of the write and read light. Light from a 5 mW continuous wave (CW) HeNe laser was imaged onto exactly the same spot so that the amount of transmitted light could be measured. In this way, we measured the variation in the amount of transmitted light as spots were written using various wavelengths of light from the OPO. The power of each write pulse was measured using a pyroelectric joulemeter with response that was independent of OPO wavelength.

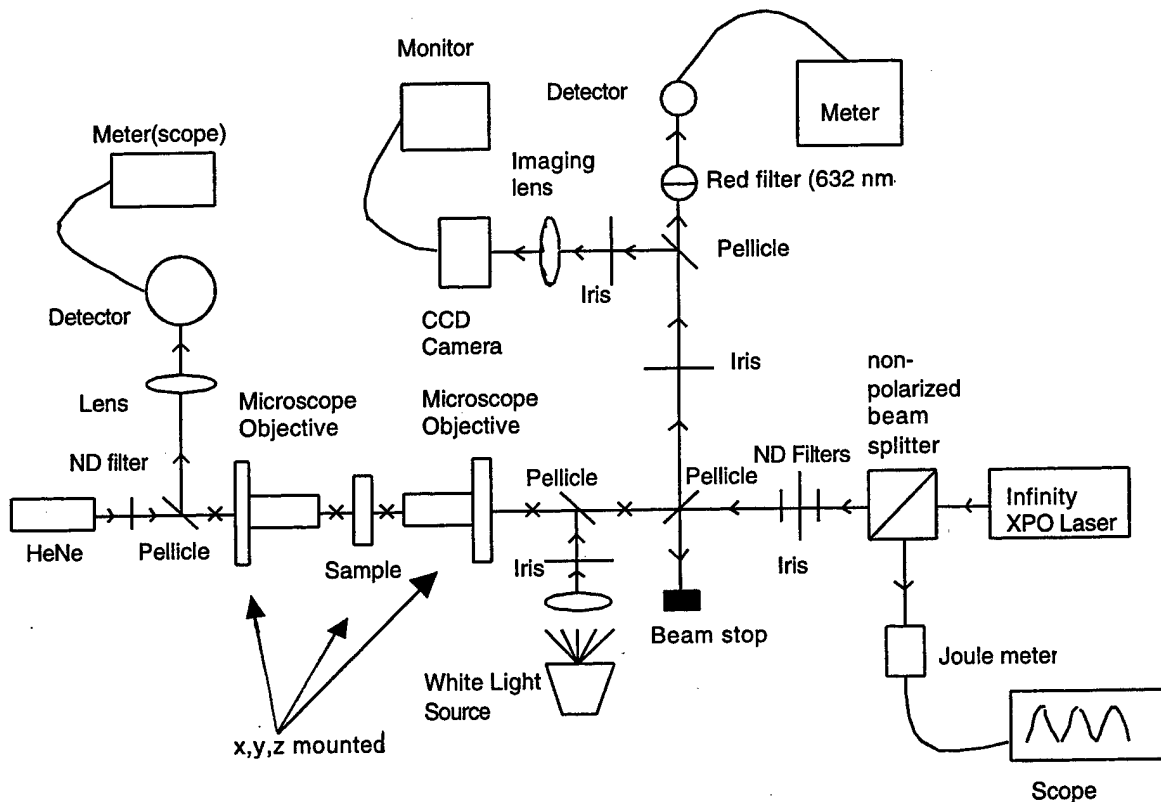

Figure 2. Apparatus for wavelength dependence and switching measurements. (For the switching measurements, the OPO is replaced by a CW argon ion laser and a shutter. In addition, the photodiode which monitors the transmitted HeNe beam is connected to a LeCroy 9400 transient recorder which in turn is interfaced to a PC for long term data storage.)

The same measurement was repeated at least three times on different locations on the same film. This allowed us to average over minor thickness and other potential random variations in the films. Since this experiment involved a substantial variation in wavelength, there was a consequent variation in the size of the diffraction-limited spot diameter. Thus the transmittance of HeNe light needed to be corrected for the variation in the size of the spot with wavelength. Furthermore, since our interest is in the writing efficiency per absorbed photon, we corrected the transmittance variation for the variation in independently measured film absorption with wavelength. Finally, we attempted to use OPO pulses which were of approximately the same energy, so as to minimize any error that might be produced by utilizing a linear normalization of the observed transmittance change to the OPO pulse energy in each case before the averaging over different locations was executed.

Testing was performed on films of varying types to allow a systematic exploration of material properties. Probably the most important characteristic of a film in the POMS context is W^{+5} content. So-called "oxygen deficient" films have a relatively large W^{+5} content and so are blue in appearance, whereas "oxygen rich" films have lower W^{+5} content and are only very slightly colored with exact color depending on thickness due to interference effects. As the films are fabricated thicker, their appearance tends to shift towards slightly yellow. This is true for either sputtered films or sol-gel films. For sputtered films deposited in an oxygen rich atmosphere, controlling oxygen partial pressure or flow rate for a particular deposition apparatus, is the best approach for defining a given film. However, for sol-gel films, other conditions serve as an index for oxygen deficiency in terms of manufacturing conditions.

Although for practical purposes the deposition conditions are defining, another useful index and basis for comparing films made by different technologies is to use the depth of the blue color. That is, for a film of about 400 nm thickness, an "oxygen deficient" film would have an absorption of about 1 absorption unit at 800 nm compared to 0.1 or less for an oxygen rich film. ESCA (electron spectroscopy for chemical analysis) or PES (photo emission spectroscopy) approaches could also be used to assess oxygen deficiency, but visible/near infrared absorption is a simple noninvasive/nondestructive approach which is the most inexpensive, convenient, and easily implemented film characteristic for quality control (QC) in a manufacturing environment. Thus, in this report we will speak of blue and yellow films interchangeably with the adjectives oxygen deficient and rich to imply a quantitatively specified material property.

Not surprisingly, the absolute writing efficiency on oxygen deficient films is much greater than that for less oxygen deficient films, regardless of write laser wavelength. This is partly due to the greater absolute absorption strength across the wavelength range studied and partly due to the dependence of the write/erase chemistry on starting W^{+5}/W^{+6} concentration. At a fixed wavelength, using the spinning disk test stand which includes a small diode pumped, pulsed (2.5 nsec), frequency doubled YAG at 532 nm, the write threshold is about two to three orders of magnitude less for oxygen deficient films than for oxygen rich films. Using the OPO test stand the write threshold was on the order of 10^{-5} J/pulse for oxygen rich films compared to 10^{-8} J/pulse for oxygen deficient films.

The graphs in Figure 3 reveal the *relative* variation of the intrinsic writing efficiency of the POMS process with varying write laser wavelength for a set of equally oxygen deficient sputtered WO_3 films of varying thickness. The error bars represent 2 standard deviations about the average calculated over the different locations. It is clear that there is considerable variation in the writing efficiency with varying wavelength well beyond the noise in our measurements. There appears to be no wavelength which is unsuitable for writing although some wavelengths are clearly better than others.

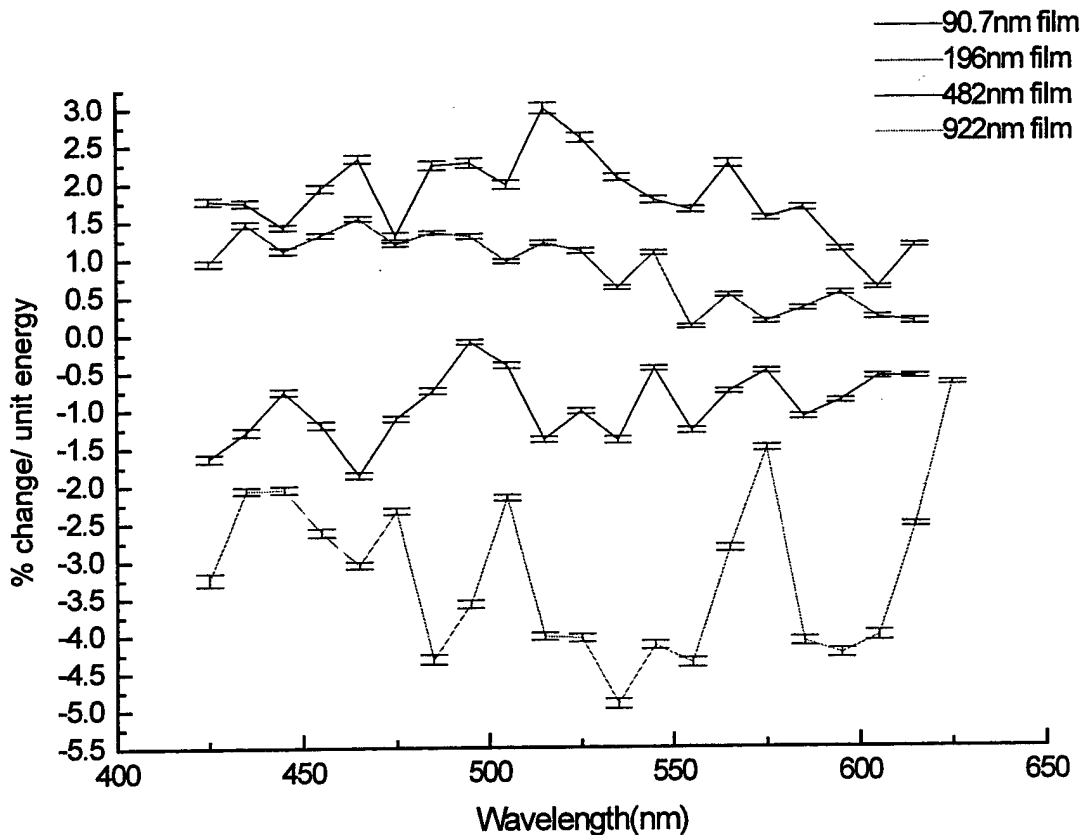

Figure 3. Wavelength dependence of writing efficiency for equally oxygen-deficient sputtered films with varying thickness. (No IR added; writing efficiency normalized for spot size change and pulse-to-pulse power fluctuations.)

The thinner films have a different sign for the change in transmittance than the thicker films. Variations with wavelength for the thicker films are consistent with a change in which the film is initially absorbing/reflecting and after writing, is even more absorbing/reflective, i.e. more transmissive. The thinner films change is consistent with an event in which the film is ablated by the write laser. The ablation was confirmed in many, but not all cases, using profilometry.

To understand what is happening we first point out that the initial excitation event involves an absorption event. Regardless of mechanism, the writing is complete in less than 2.5 nsec given

sufficiently high peak power pulses. The write threshold near 532 nm with no infrared present was found to be ≈ 10 nJ under these conditions. The thinner films apparently do not adhere as tightly to the substrate. It is also possible that they adhere just as strongly but they do not have as much thermal mass and so the deposited energy density is higher. We suggest that the ablation efficiency has essentially the same wavelength dependence as the POMS writing efficiency because they are both initiated by the same sub-bandgap photon absorption event. An ablation event results in an increase in transmitted power, whereas a true write event results in less transmission at 632.8 nm. Thus the two thinner films tend to show an increase in transmission while the thicker films show a decrease. It is interesting that there is apparently no shortage of sub-bandgap states which afford such films oscillator strength (absorptivity) at essentially all wavelengths between 610 nm and 425 nm. The observed variation occurs over a scale of tens of nanometers. We note that the largest fluctuations in writing/ablation efficiency occur at the long wavelength side of the scan range. Because the intervalence absorption associated with W^{+5} to W^{+6} electron transfer also has increasing strength to longer wavelengths, it is clear that the sub-bandgap states therefore have some character of the W^{+5} states. These are in turn associated with O vacancies in the lattice since that is one major source of W^{+5} . But in addition, because the excitation can lead directly to charge transfer to W^{+6} tungsten ions from the lattice oxide, there is considerable character of the states just above the bandgap which are t_{2g} (symmetry designation) in nature, mixed into the sub-bandgap states.

Photochromic vs. Electrochromic Writing-Erasing

As we and many others¹⁹ have detailed in previous publications, tungsten oxide films produced by sputtering in an oxygen deficient environment tend to appear blue because of the W^{+5} content. The films are yellow when an excess of oxygen gas is present during sputtering. These can be made blue by electrochemically reducing the tungsten in a second step, thereby exploiting the electrochromism of these materials. This can be accomplished by a variety of chemical routes but there is always a proton source and a source of electrons. The electrons reduce a number of the W^{+6} ions, which comprise the vast majority of the lattice even for dark blue films, into W^{+5} ion and the protons stabilize these species to easy re-oxidation (into W^{+6} ions) by atmospheric oxygen.

During this effort we tested the POMS writing efficiency on electrochromically reduced sputtered films. This step can be accomplished using a variety of approaches. In this effort we contacted the films with metallic tin in the presence of medium strength mineral acids such as either HCl or H_2SO_4 . This step can also be accomplished using external electrical circuitry and electrodes to inject electrons with a proton electrolyte of some type. Such reduced films were found to be similar to those which were blue "as sputtered." In addition, films which had been written were also erased by the POMS process. The technological issue here is that electrochromism can be used to erase large sections of a WO_3 based POMS medium in a single pass, thus providing an enormous parallelism to the overall process. Such films may have been more susceptible to ablation effects although more testing will be needed to establish this in quantitative terms.

Sputtered vs. Sol-Gel Substrates

As a part of this effort, we made contact with an established manufacturer of tungsten oxide based media, Donnelly Corporation (Advanced Technical Center, Tucson AZ). Since we already had the capability to produce sputtered films ourselves, Donnelly was a prime target for consultation because of their established mastery of the sol-gel approach to producing WO_3 based films. Although their expertise applies directly to films for electrochromism type applications, we hoped to test their materials in the POMS process as a memory/switching medium. Donnelly can produce such films in very large dimensions; in units of *square feet*. This capability is not present for PC and MO based optical media. Since large sections can be used for POMS devices, we have established a fundamental technical advantage for POMS over all other optical media. Currently the only other memory technology capable of storing terabytes of information on a single searchable physical volume is magnetic tape.

The sol-gel approach²⁰ is a general strategy for producing metal oxide films in which the metal of interest is introduced to the substrate as a metal alkoxide. Alkoxides have general formula $M(OC_nH_m)$ where M can be chosen from a wide variety of different metals including W, Mo, Ti and V. Alkoxides have the chemical property that when contacted with water they undergo hydrolysis leaving behind metal oxide. The metal oxide coated substrate is then heated in an oven to drive off all the organic reaction products (from the C in the alkoxide) and to adjust the water content to that which is optimal for the desired application.

There is considerable "black art" in the actual processing of such materials and so we were fortunate to have the cooperation of the largest producer of tungsten oxide coated glass in the world. Donnelly fabricated and provided two samples of relevant material for our testing. These film samples differed slightly in thickness and in the final temperature which was used in the drying/annealing stage. They were fabricated on simple borosilicate glass. Another set was deposited on borosilicate substrates which are used in magnetic hard disk production and which we obtained commercially (Cerion Corp, Champaign-Urbana, IL) and provided to Donnelly. These substrates are high precision float glass which can be safely spun at high angular velocities.

Using the sol-gel samples formed on simple pieces of borosilicate glass, we obtained the data depicted in Figure 4. These data were collected in the same manner as for the sputtered films. The data are actually quite comparable at the shorter wavelengths but are significantly different at the long wavelength side. Given the differences in processing to produce these films, the most obvious difference would seem to involve grain size effects and the oxidation state of the metal. All the sol-gel based films would be expected to have smaller grain size than the sputtered films which are grown at much higher overall temperature during the deposition stage. We can only speculate on this situation since company proprietary methods are involved. The main point to be made is that sol-gel films do in fact allow POMS writing of data much like sputtered films.

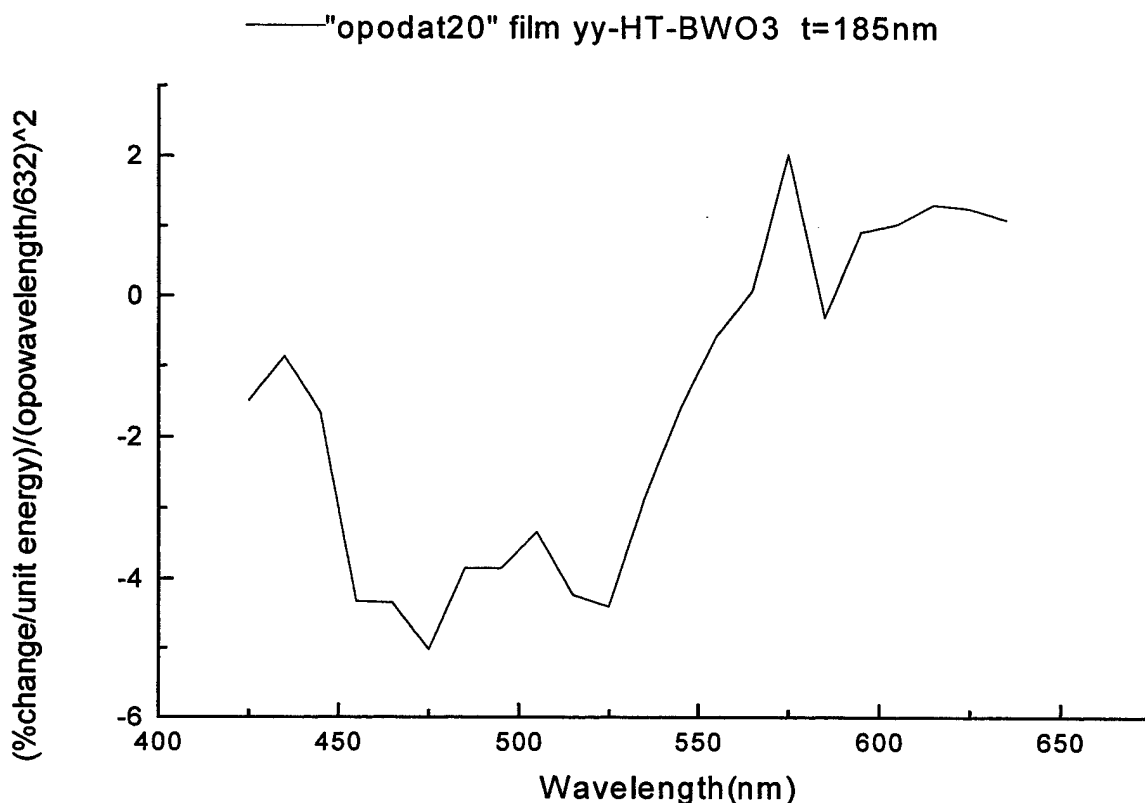

Figure 4. Varying write laser wavelength for a sol-gel sample of WO_3 on borosilicate glass substrate. (The writing efficiency has been normalized for spot size changes and pulse-to-pulse power fluctuations.)

We also demonstrated that the sol-gel films could be electrochromically colored and written in the same way as sputtered films. These films seem to be somewhat more susceptible to ablation than the sputtered films but there are myriad parameters which need to be explored in the deposition/processing steps before this can be stated with any certainty. We can say presently that sol-gel films are quite amenable to the POMS process, and the sub-bandgap states which are needed appear to be as plentiful as for sputtered films.

Cluster Materials Prospects

The patent literature for tungsten oxide based memory products contain numerous references to various types of proton donors which enhance the photochromic response. In recent years the hydrothermal chemical approach to synthesis has produced a huge number of hybrid metal oxides containing organic templating species which are capable of being proton donors. It is therefore rational to survey some of these species to see if they do in fact have potential as POMS materials. In addition, researchers at IBM reported years ago that the electrochromic response of

plain WO_3 could be enhanced by placing them in contact with various types of metal particles and clusters.

With this in mind a number of compounds were synthesized, most for the first time anywhere, in collaboration with Professor Jon Zubieta and Doug Hagrman of Syracuse University. These compounds all contain potential proton donors and in some cases metal based clusters embedded in the actual metal oxide lattice. We surveyed these compounds by measuring their Raman spectra and also by noting whether the material had a tendency to decompose during the process of obtaining the spectrum. This was the manner in which the POMS process was originally discovered and so it represented a reasonable approach to quickly survey a number of compounds for potential to become improved materials for POMS.

In addition to these new materials, a similar set of studies was made on some reasonably well known tungsten based cluster anions. So-called decatungstate ($\text{N}(\text{CH}_4)_3)_2\text{W}_{10}\text{O}_{32}$ and dodecatungstate $\text{W}_{12}\text{O}_{31}$, are well known photoactivated catalysts for a variety of processes. The structure of the decatungstate cluster anion is shown in Figure 5. Doug Hagrman synthesized two members of this class of species for testing during this effort. Both species were found to be *at least* as sensitive as any of the WO_3 based materials themselves. They were so sensitive that a Raman spectrum could not be obtained due to the efficient decomposition. During the course of these synthesis efforts it became clear that we should, in a future effort, test nanoparticles of WO_3 produced by other standard methods²¹, e.g. fast quenching of alkoxide solutions, for POMS activity.



Figure 5. Structural representation of the decatungstate cluster anion ($\text{W}_{10}\text{O}_{32}^{-12}$) (This cluster was found to be very sensitive to 488 nm radiation.)

The following materials were synthesized for this effort. Each is an analogue of MoO_3 doped with an organic proton donor. Although the empirical formula does not explicitly show them, each crystal is known²² to incorporate waters in the lattice. Such proton donors would be expected to serve the same purpose as an added layer of the proton donor on a pure oxygen deficient MoO_3 film. Such layered films are taught in Yoshiike²³ as being advantageous for photochromic writing. It is this connection which motivated us to try these types of materials in a search for improved POMS materials. All of the materials listed below with the possible exception of the pyrazine containing material, were sensitive to the Raman excitation laser and so are potential POMS materials.

$\text{Cu}(4,4'\text{-bipyridine})_4\text{Mo}_8\text{O}_{26}$
 $(4\text{-}4'\text{bipyridine})_4\text{Mo}_8\text{O}_{26}$
 $\text{Cu}(1,2\text{-bis}(4\text{-pyridyl})\text{ethylene})_4\text{Mo}_8\text{O}_{26}$
 $(\text{Cu}(\text{pyrazine})_3)\text{MoO}_4$
 $\text{Cu}_2(1,2\text{-bis}(4\text{-pyrimidine})\text{Mo}_3\text{O}_{10})$
 $\text{Cu}_2(\text{trazolate})_2(\text{H}_2\text{O})_2\text{Mo}_4\text{O}_{13}$

The Raman spectrum of the $(4\text{-}4'\text{-bipyridine})_4\text{MoO}_3$ material and two views of its structure are shown in Figure 6.

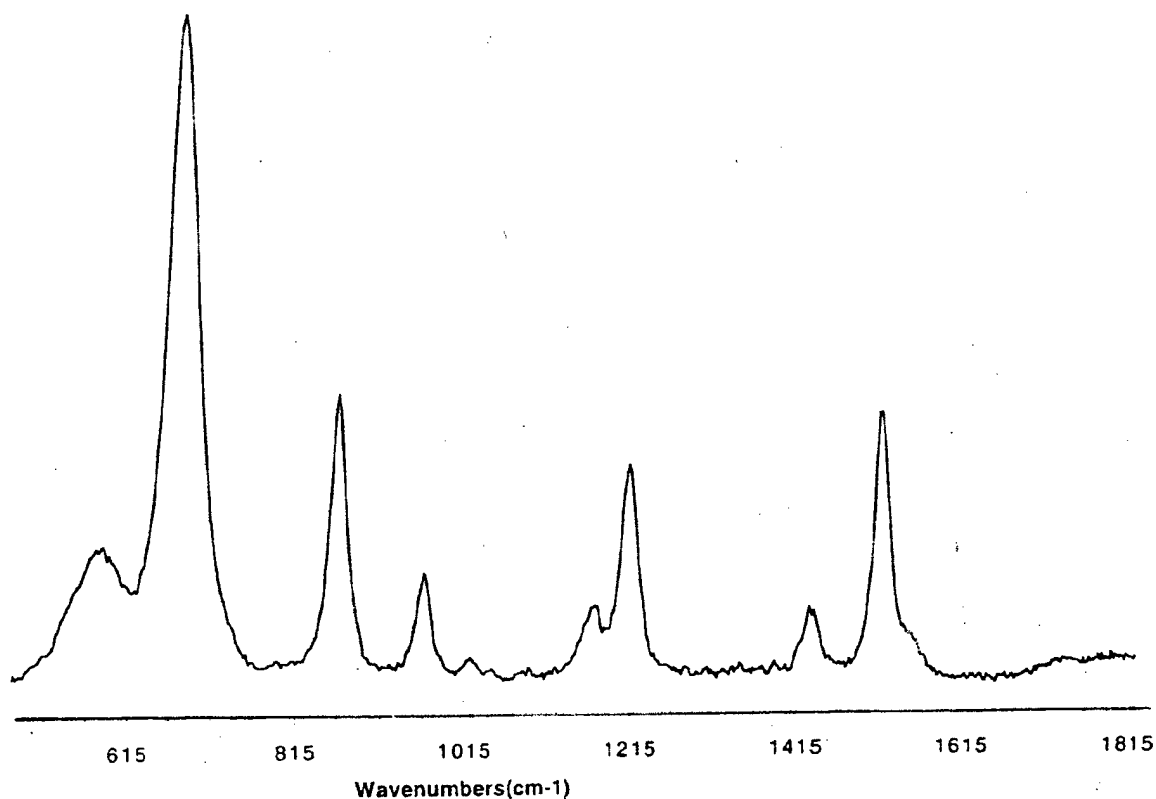
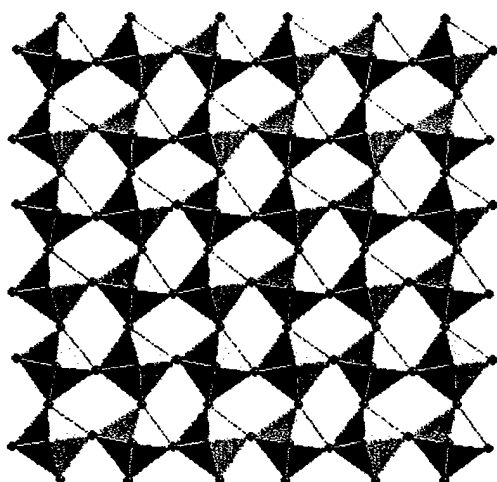
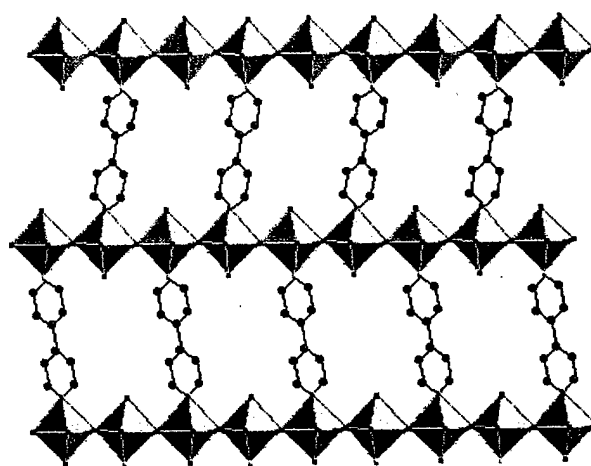

Figure 6. Raman spectrum of $(4\text{-}4'\text{-bipyridine})_4\text{Mo}_8\text{O}_{26}$ obtained using an excitation wavelength of 488 nm. (Some decomposition was observed during the recording of this spectrum suggesting that it has potential as a POMS material.)



(a.)



(b.)

Figure 7. a) Top view (looking down) onto a plane of MoO₆ corner-sharing octahedra in the structure of a single crystal of (4-4'-bipyridine)₄Mo₈O₂₆. b) Side view of same compound showing 4-4'bipyridine ligands connecting adjacent layers of MoO₆ octahedra.

Spinning Disk Studies

Some of our effort was directed towards providing POMS materials and substrates for spinning disk tests of the POMS in a separate AFRL effort¹⁸. Although these results were reported in detail elsewhere, part of the required work for this effort entailed obtaining suitable substrates and materials from established manufacturers for studies in the spinning disk format. These goals were completely met in this effort.

III. Prospects for Scanning Probe POMS Memories

Another part of this effort was to provide improved POMS materials for testing in a scanning probe format. In this respect the effort was also completely successful. Several samples of "Woxyfoil," thermally oxidized tungsten foil, were produced and sent to Professor Matt Cote at Bates College, Lewiston ME where scanning probe testing is planned. The relationship between the other types of POMS device scenarios, i.e. purely optical memory, switching, will be very briefly described in the following.

Rationale for Scanning Probe POMS

The basic idea of the POMS write process is that visible light provides electronic stimulation thereby weakening metal to oxygen bonds in the medium. When used in combination with the visible excitation, the infrared light increases the rate of mass transfer so that oxygen anions/atoms can aggregate with each other thereby forming volatile products that leave the lattice. The net effect is to provide W^{+5} sites such that when the lattice cools, they cannot react thereby preventing the complete re-oxidation of the written spot and the memory function is achieved. Alternatively, the infrared light used alone promotes re-oxidation of the W^{+5} material, thereby inducing the blue to yellow transition. The processing steps seem to have some annealing effect overall, and once formed, highly crystalline regions may not be broken up by any aspect of the POMS process. This would correspond to fatigue in the medium, which eventually renders it inoperable.

Scanning probes provide the electronic stimulation directly by means of an evanescent field directed by a scanning tip. The physical dimensions of the tunneling field are much smaller than any diffraction limited region illuminated using any optical radiation. This approach allows the writing of spots which are not limited by the wavelength of any practical laser source. The spot sizes can then be 10 to 100 times smaller, thereby increasing the storage density and net capacity by factors of from 100 to 10,000. The POMS process is ideal for a scanning probe variant because of the 3-6 order of magnitude variation in electronic properties, e.g. conductivity, between the written and erased states.

POMS Media Considerations

Characteristics of a good medium for scanning probe based memory are still being determined. Our experience suggests that such a material should have reasonable electrical conductivity in either the "1" state or the "0" state for a conventional binary memory. The memory would need to be reasonably flat, although not necessarily atomically flat, so that it can be scanned quickly without physically scraping the surface too much. It would need to have as much contrast as possible between the electronic properties of the written and unwritten states. Tungsten and molybdenum oxides seem to have excellent properties for POMS based scanning probe memory. Preliminary results²⁴ show that these materials are very easily imaged using scanning probes in either a tunneling current or atomic force mode. Although much more testing needs to be done to fully define the possibilities, we believe they hold great promise for future memory systems.

Materials and System Considerations

It is probable that all media will be rough on the scale at which scanning tips are able to sense spatial variation. This will directly impact read and writing speed. The faster one attempts to do either, the more likely will be the occurrence of "tip crashes". These may not be particularly damaging in the sense of causing physical at the site of the crash or the loss of data but it will limit the speed of the read and write functions. It seems quite unlikely that spinning media formats will be practical due to the same problem. However, because the data itself is stored between 10 and 100 times more closely, this will have the effect of making the linear scan velocity effectively 10 to 100 times quicker. The result is a virtual wash with data transfer rates ending up about as fast as they currently are.

To perform scanning tip functions, it will always be necessary for the tip to be in nearly direct contact with the medium surface. It will not be possible to employ elaborate overlayers to perform protective and other functions. Furthermore, unless a volume is to be nonremovable, i.e. like a current hard disk, it will be necessary to employ some type of housing like in Zip disks. Indeed, it will probably be necessary to employ optical tracking to allow fast identification and location of data in either write or read mode. Thus, scanning probe memory will have as one subsystem an optical tracking arrangement in addition to any scanning probe subsystems.

Because the electronic excitation function of the POMS process will be implemented by the scanning tip itself, there is no need for a small visible wavelength laser. In all likelihood, 670 nm lasers which are currently available will be sufficient to implement scanning tip POMS. All optical memories currently yearn for the small blue laser (e.g. GaN at 410 nm). Thus scanning tip POMS may be even more viable than all optical POMS. Although there are a myriad of considerations relating to the extension of POMS into the scanning tip regime, these are a few of the comments we can most reasonably infer from our current process and materials knowledge.

IV. POMS Materials for All-Optical Switching

Background Technology

As described in Section I, the POMS odyssey began during a collaborative attempt by Syracuse University and AFRL researchers to implement all optical switches using the NIOS strategy. Since that time economic and technological developments have progressed to the point where the ideas that drove those first attempts are no longer the most important reasons for continuing the journey. Indeed, the advent of the Internet and the proliferation of all optical communication systems have changed the technical and economic landscapes such that there are now better reasons than ever to continue the march towards all optical switching.

The overall strategies mentioned in the Introduction are still valid, of course, but we now have a better idea of the design restrictions and requirements to which such switching devices and systems must comply. For example, there is a need for devices which can be used to implement optical switching networks in which the switches need not open and close in less than about 10^{-5}

seconds. This is not to say that faster would not be better but it is to say that current needs, and those projected into the not too distant future, are well served by such devices. Currently, thermo-optic switch devices have millisecond switching times and are in actual commercial use.

Thermo-optic devices dissipate 10-100 mW of power per switching event²⁵. This much power is dissipated inside the switch, based on electrical input during the switching event to ensure switching. Although this parameter is currently adequate, it is clear that from the standpoint of system wide power consumption and thermal load, a reduction in this value is necessary. Currently, active optical switches, e.g. Mach-Zehnder niobate type switches, are relatively complicated devices which require careful alignment and are sensitive to environmental fluctuations. Passive optical switches consist mainly of simple filters as for wavelength division multiplexing. The complexity in active devices arises from the various layers of materials needed to fabricate the devices and the physical orientation of the various components of the switch. Furthermore, in some cases there are moving parts. It would be far better to have simple monolithic devices consisting of a substrate and one or more films in some appropriate, but easily manufacturable juxtaposition. Lower insertion loss is always desirable but, in the specific context of 1500 nm communication systems, the advent of the Er doped fiber amplifier is easing the insertion loss induced stress on the overall system.

While there are more considerations than those just mentioned, the following report serves to illustrate both the current state and the potential performance of simple all optical switches based on tungsten oxide films.

Scientific Basis

The basic situation is that the POMS materials films we have tested consist of a mixture of WO_3 and W_2O_5 , that is, W^{+6} and W^{+5} oxides respectively. While the W^{+6} accounts for the vast majority of the tungsten present, the W^{+5} is essential for the process to occur. The darker blue the film, the greater the W^{+5} content in relation to the W^{+6} content, and the less the transmission of red light. Note that the same process leads to specular reflection in addition to absorption because of the strength of optical interaction. Thus, decreased transmission is not directly translatable to thermal heating of the film.

The absorption of sub-bandgap light, i.e. radiation with wavelength longer than about 380 nm, whether blue or red, excites a transition in which the extra electron on the W^{+5} ions is excited into the conduction band. Thus, when blue light, i.e. the "switch control", is brought to the switch, the illuminated region becomes depleted of W^{+5} sites, and the red light, i.e. the "data", senses less absorption and specular reflection and more light is transmitted through the switch. The fate and overall lifetime of those relatively free charge carriers determines a number of the switch characteristics. On the basis of the time response of the reversible portion of our observations, it seems clear at this point that the mobility of whatever carriers/species are involved is less than that for electrons in a metallic conduction band. The deduction is bolstered by the fact that we can induce a much less reversible, non-ablative modification in a sub-nanosecond time scale. There may be some hopping transport which occurs in addition to that which can be traced to

more de-localized quantum states, i.e. conduction band states. Scattering from defect sites and phonons would also seem to be important.

Testing Tungsten Oxide-Based POMS Materials as All-Optical Switches

Using the testing configuration shown in Figure 2 we monitored the transmission of 632.8 nm "data" light through various films under the "control" of a mechanically shuttered 488 nm CW argon ion laser. The switch operates by absorbing/reflecting 632.8 nm light in the closed state and by transmitting in the open state. Presently, our understanding is best represented by noting the general qualitative behavior and the interrelationships between the various operating parameters.

Film thickness and film properties: sol-gel vs. sputtered.

Although many films were fabricated for this effort, the characteristics of the films selected for detailed study are summarized in Table 1. Sputtered films 357 nm, 482 nm and 922 nm thick were tested. A sol-gel switch was tested that was 185 nm thick on a 1 mm thick borosilicate substrate. The 482 nm thick sputtered film was deposited oxygen rich on a fused silica substrate and subsequently electrochemically reduced using metallic tin and 3 M aqueous HCl. The sol-gel films were also fabricated oxygen rich and reduced in the same way. The other two sputtered films were used as deposited, i.e. oxygen deficient. The degree of oxygen deficiency of all the films was approximately equal. The 357 nm and 922 nm films were deposited during the same sputtering run. The reduction conditions applied to the other two films, 196 nm and 482 nm were produced under the same sputtering conditions, i.e. sputtering gas/oxygen flow, target material etc, appeared to produce approximately the same depth of blue color. The composite two film switches utilized 150 nm thick oxygen deficient WO₃ films and 50 nm thick TiO₂ films.

Film/type	Thickness(nm)	oxygen status
WO ₃ /sputtered	90.7	deposited oxygen deficient
WO ₃ /sputtered	196	deposited oxygen deficient
WO ₃ /sputtered	357	deposited oxygen deficient then electrochemically reduced
WO ₃ /sputtered	482	deposited oxygen deficient
WO ₃ /sputtered	922	deposited oxygen deficient
WO ₃ /sol gel	185	deposited oxygen deficient then electrochemically reduced
WO ₃ /TiO ₂ /sputtered	150/50	deposited oxygen deficient on top of a stoichiometric TiO ₂ film
TiO ₂ /WO ₃ /sputtered	50/150	deposited oxygen deficient on top of a stoichiometric TiO ₂ film

Table 1. Characteristics of films selected for detailed study.

Film thickness: the first switching event and subsequent events.

The first exposure or "switching event" of a film is different from succeeding exposures or "switching events". Figure 8 shows a comparison of successive exposures of a given location on a film showing progression of writing and switching behavior. There is always an apparently irreversible change and then for many pulses thereafter, for certain choices of laser power, that location on the film behaves as a switch. If the initial exposure is too intense, i.e. the energy fluence is too large, then the subsequent switching behavior is not observed. This corresponds to having written a "memory spot," and that location on the film surface can only be regenerated by an exposure to visible and infrared simultaneously, i.e. standard POMS.

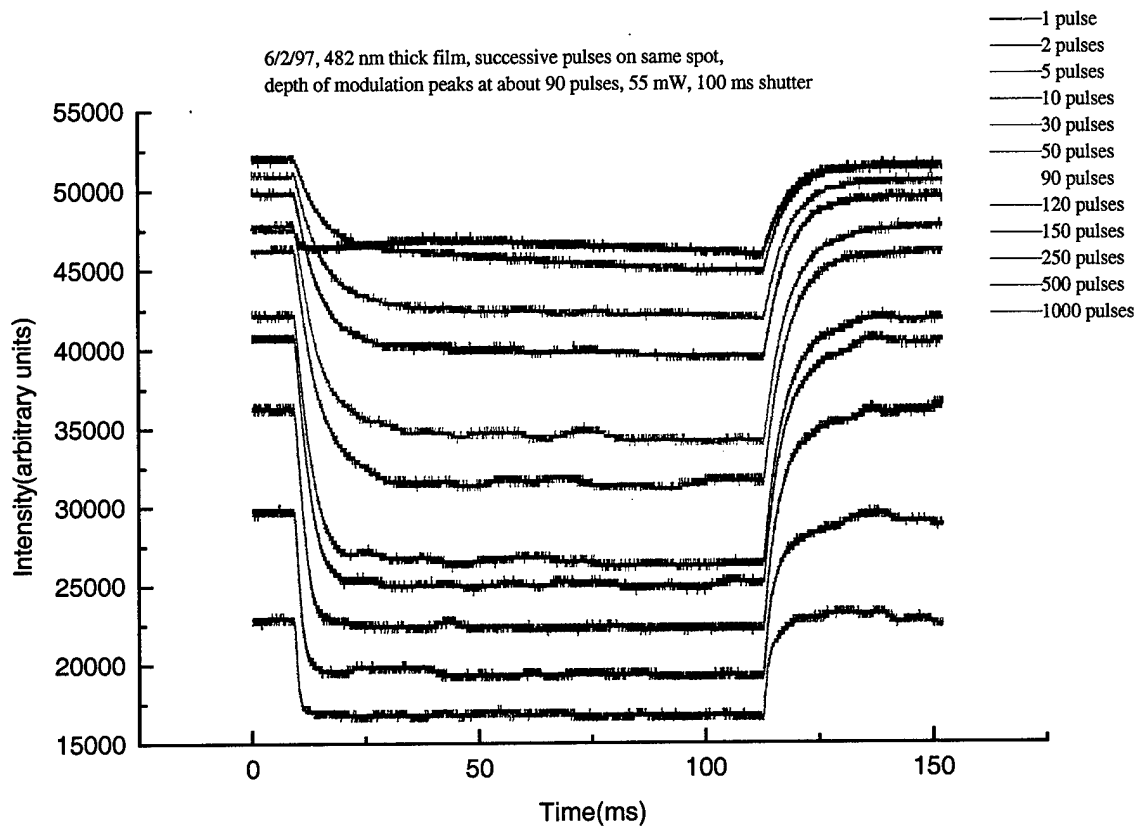

Figure 8. Comparison of successive exposures on a film location, showing progressive writing and switching behavior. (Note that the switching is maximized at about 90 pulses but that there is still modulation after 1000 pulses.)

Results from this study of CW laser controlled switching behavior suggest that there is little ablation, unlike what was observed in the wavelength dependence studies. This is almost certainly a direct consequence of the use of a CW laser for the processing. The higher peak power of the OPO is well known¹⁰ to be much more efficient for driving the nonlinear ablation process.

For continuous wave excitation, the effect of increasing film thickness is to provide more material which can be subjected to laser induced chemistry. This means that a greater

accumulated net excitation, i.e. the energy fluence, can be employed before the film becomes inactive. This is because at least one of the processes which occurs over time is most probably a bleaching of W^{+5} species out of the actively switching material.

Based on the indices of refraction, the total surface reflectivity loss exceeds 15% counting both sides. We observe that the maximum modulation, increases with the thickness of the films since, for all other things being equal, i.e. degree of oxygen deficiency, the amount of loss a data beam experiences in penetrating a given film is proportional to the thickness (Beer's Law). The maximum modulation observed was in excess of 60 % when the modulation was negative, i.e. less light was transmitted when the switch with the control light present, and approximately a doubling of the transmitted intensity when the switch was increasing transmission with the control light present.

Another potential effect involves the possibility of long time exposure to the control light causing a spatially dependent annealing/crystallization of a specific stoichiometry. This could lead to a spatial dependence in the index of refraction, thus producing a lensing effect. The thicker the material, the longer this process may take, but also the "effective focal length" of the lens so formed may be influenced. More experiments will be needed to determine a precise answer to this question.

Overall, there was no qualitative switching effect which was not possible to observe using any of the different thickness films. Film thickness is either not a terribly important factor in determining media/switch characteristics, or other aspects of the processing are able to compensate for the variation in thickness. In either case, it is clear that films of the order 10^{-7} m thick are quite satisfactory for observing a variety of potentially useful switching behaviors.

Switching power.

For all other things being equal, the amount of light transmitted in the open state increases with the power of the control light. This makes sense because the more control power brought to the switch, the more electrons are excited away from W^{+5} species, creating W^{+6} species and, as a direct consequence, the less absorption that can take place. As can be seen in Figure 9, the depth of modulation increases as the control power increases. For this particular film, there is a maximum depth which is achieved near 197 mW.

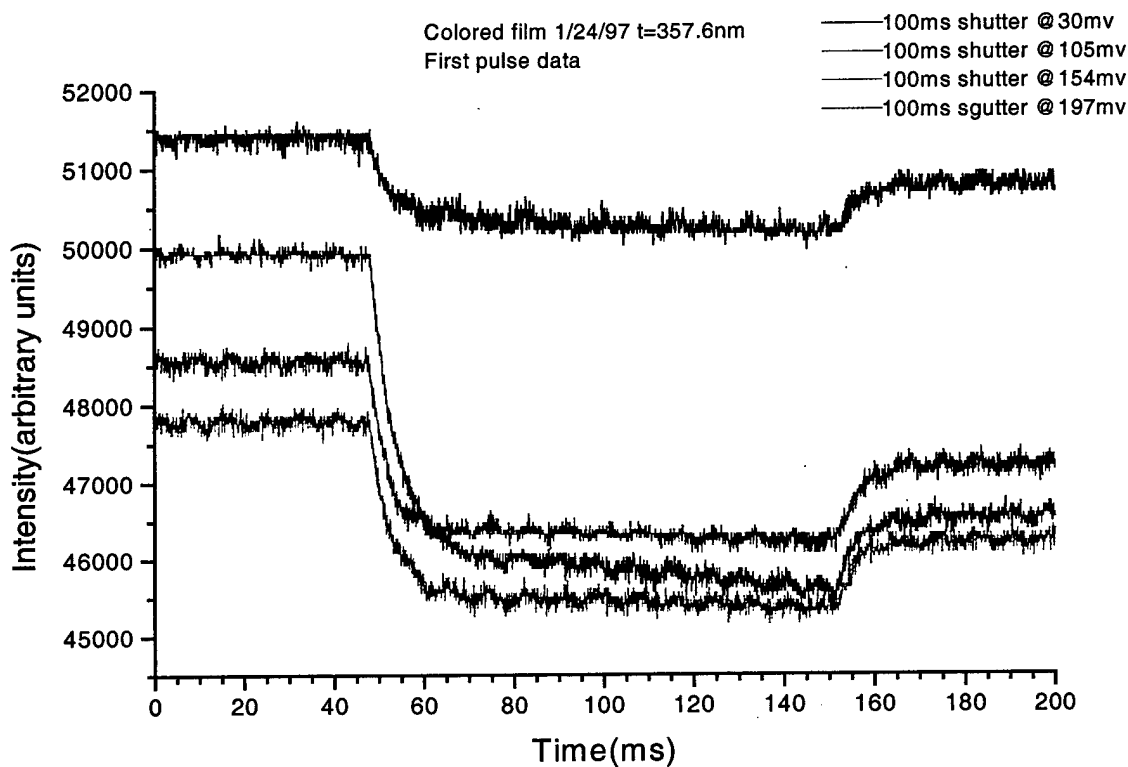

Figure 9. Dependence of modulation depth on control power.
(Each trial is on a different spot on the film.)

We again observe that the transmission after the control light is removed does not always return to its pre-switched level, i.e. there is a memory effect. The higher the applied switching power, the greater difference between the pre- and post-switching transmission level. This observation, which relates to the cyclability of the switches, will be examined more fully in a later section. We shall show later that for a particular duration control pulse, the modulation depth increases with increasing control power whereas for a particular control power, the depth does not increase as the duration of the pulse increases. In this case the duration of the open switch period increases directly with increasing duration of control pulse. This can be seen in Figure 10.

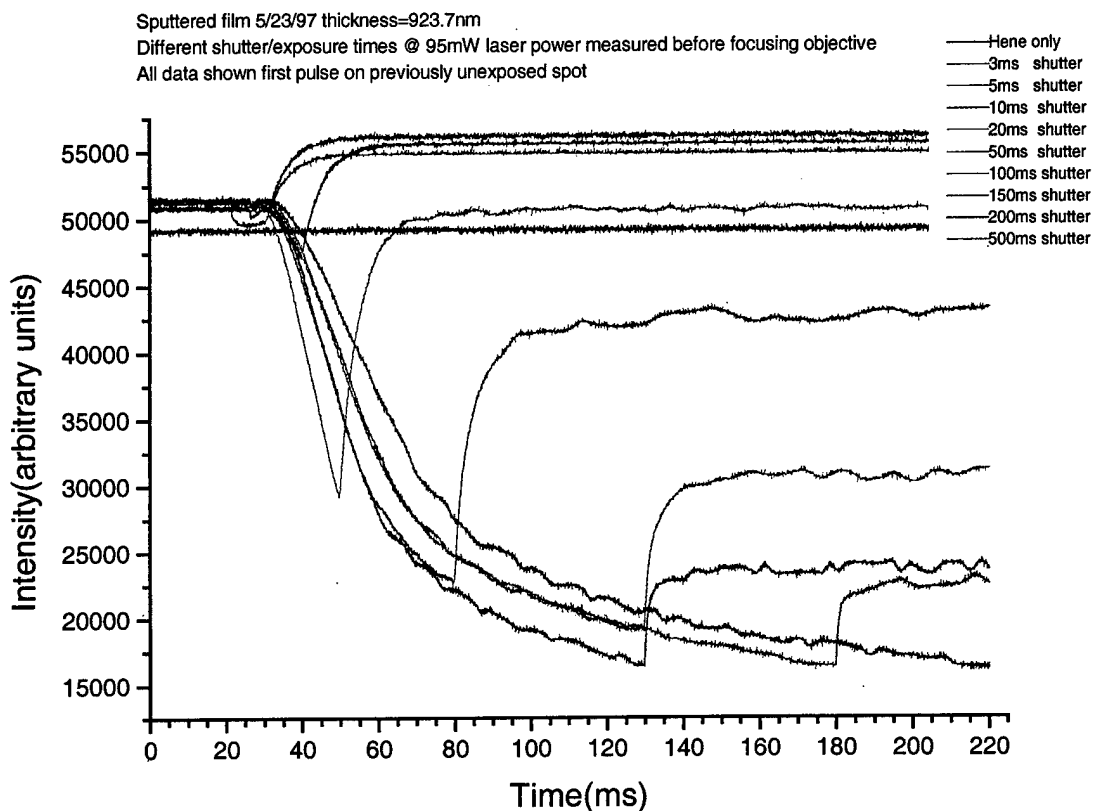

Figure 10. Dependence of switching on pulse duration at constant power

As can be seen in Figure 11, for some sets of conditions, the opposite behavior can be observed. That is, the transmission decreases when the control light is present and, as before, the modulation depth increases with increasing applied switching power. Both switch modes can be observed with either sputtered or sol-gel films and whether the films are deposited oxygen deficient or they are reduced electrochemically after deposition. There are at least a couple different plausible ways to view these films. It is possible that there is a net production of W^{+5} states with the control light present. It is also possible that the control light induces a depth dependent region in a way which resembles a Fabry-Perot (resonant cavity) effect. It should also be possible to create a simple spatial blockage which has greater or lesser physical extent in the transverse directions to the light propagation. We cannot explain this behavior unequivocally at this time, but we note that it is a highly reproducible behavior and that it suggests a variety of switching architectures when used in combination with the opposite type of switching behavior, i.e. increasing transmission with application of control.

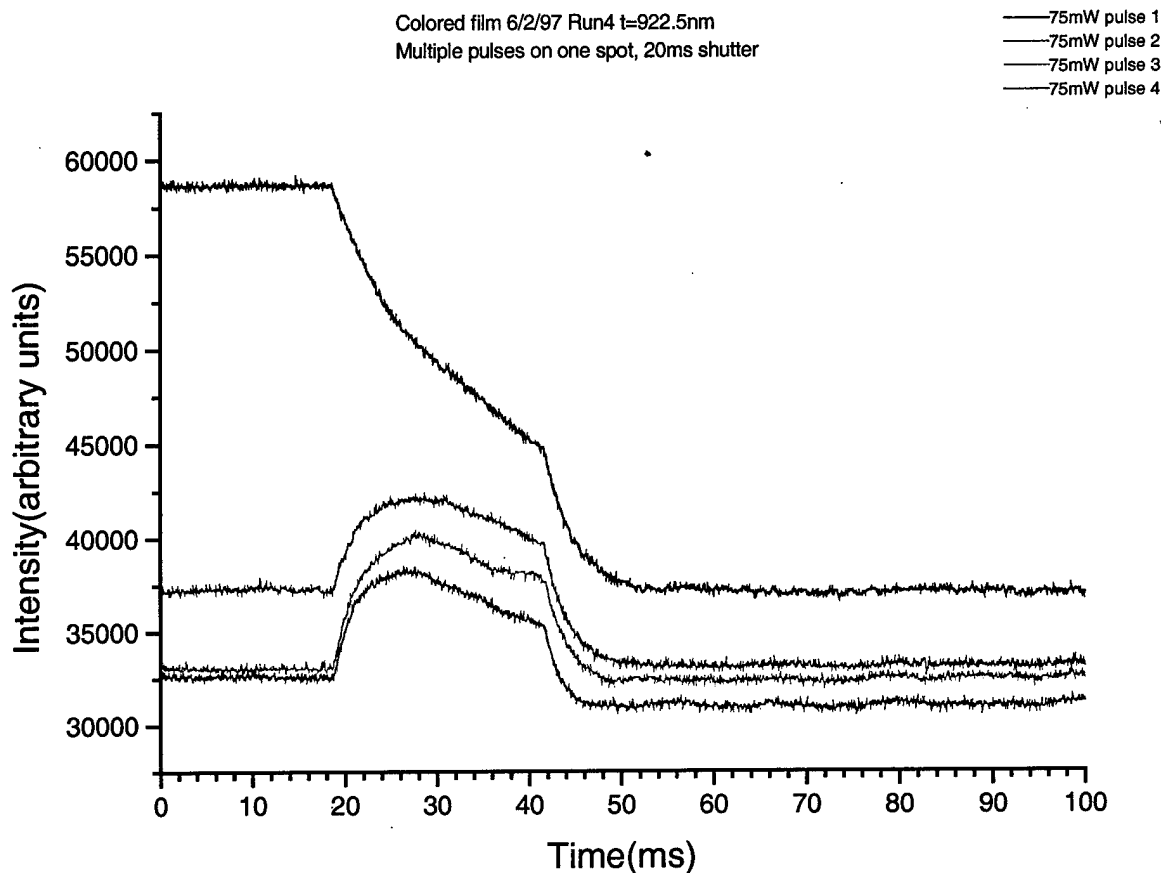

Figure 11. Switch transmission decreases as control light is presented to active spot. (The upward pulse corresponds to increased red light transmitted through the film; i.e. it went blue to yellow and back upon application of the blue green control pulse.)

Switching Time.

There are at least two temporal figures of merit directly related each individual switching event. We define the “turn on time” as the lag between the “opening” of the switch, i.e. time to maximum transmission through the film. Similarly, we define the “turn off time” is then the lag between the actual return to original transmission of the switch following the turn off of the control argon ion light. We regard turn on and turn off to be time to maximum or minimum transmission as appropriate. Thus we observe that the turn on time decreases with increasing control power and the turn off time is not directly sensitive to increasing control power. The turn off time may be affected by the degree to which the memory effect has progressed but more experiments will be needed to fully quantify any effect.

For control light power of about 10^1 mW, the turn on time is on the order of 1 msec regardless of film thickness and decreases with increasing laser power. As noted above, it is known that W^{+5} states are stabilized by the presence of protons in the metal oxide lattice. To ascertain the effect

of these protons on switching times and other characteristics, the behavior of two films was compared in which one was electrochemically reduced using HCl and the other reduced using DCl. In this case the deuterons would be expected to move twice as slowly as the protons for all other conditions being equal. Switching times, either on or off, would be doubled or at least lengthened. As can be seen in Figure 12, this was not observed. In fact there was little effect, thus demonstrating that the motion of electrons is important to switching behavior and not protons.

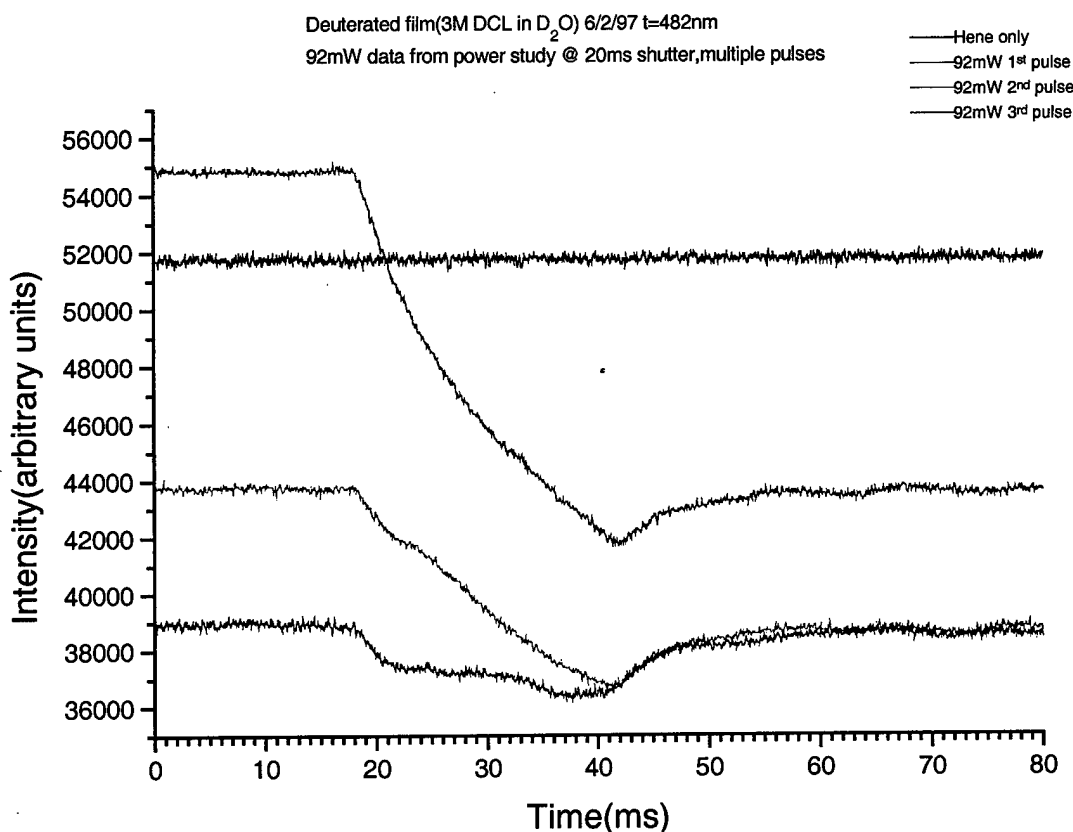

Figure 12. Deuterons have little effect on turn on or turn off time compared to protons. (95 mW measured before focussing objective; thickness difference accounts for the various levels the transmission recovers after control pulse is removed. Turn on time is about equal in each case.)

Cyclability/Electrochemical Erase.

There are two ways to view cyclability of these switches. As noted above, one interesting observation is that the longer the control light is present, for constant control power, the less fully the switch transmission recovers to its pre-switched value after the control light is removed. This memory effect limits the number of times the switch can be operated before some "erasing" processing must occur. At some point, and perhaps equivalently, the depth of transient modulation becomes nil, i.e. the switch latches on and never turns off. The number of switch

transitions before the memory effect causes the film to transmit at all times and the modulation decreases to nil, i.e. consecutive turn-ons and turn-offs depends on the control power and the duration of the open time.

Currently, all the simple films we have observed can be switched for 10^3 - 10^4 times using 10^1 mW of control light power before the modulation depth becomes less than about 10% of the depth observed on the first transition. An example of this is shown in Figure 8. Also, by then the film itself will usually transmit about 10 times more light than it did before it was switched the first time. Electrochemical reduction actually reverses this transmission increasing memory effect and allows continued transient switching. We have yet to quantify the exact amount of reduction which is necessary to reverse a given number of laser induced switching events at a given control laser power.

In general, a very high control power, say 150 mW, opens the switch completely on the first exposure and then the switch does not recover to its pre-switched value when the control light is switched off. This effect is shown in Figure 13. The transmission modulation which is observed when the switch is opened that first time is the maximum that is ever observed for that switch.

That is, the depth of transient modulation never exceeds that value regardless of how much power is applied, for how long the pulse may be applied or for any other characteristic of the light which is applied.

POMS Layers.

It is taught by Yoshiike²³ that, in addition to employing proton donors in the active medium to increase the photochromic response, it is advantageous to employ overlayers of metal oxides such as TiO_2 to prevent reactions with the ambient atmosphere. Specifically, the photo-induced exchange of oxygen between the ambient atmosphere and the tungsten oxide medium must be avoided to minimize fading of written spots over time.

Given these claims, we checked the switching response of oxygen deficient WO_3 films (150 nm thickness) in combination with either a TiO_2 overlayer or a TiO_2 underlayer (50 nm thick in either case). Although the amount of light which penetrates to the interface between both layers is dependent on the index of refraction of the outer layer, in this case the indices of refraction are within ± 0.2 so the difference makes only a small difference.

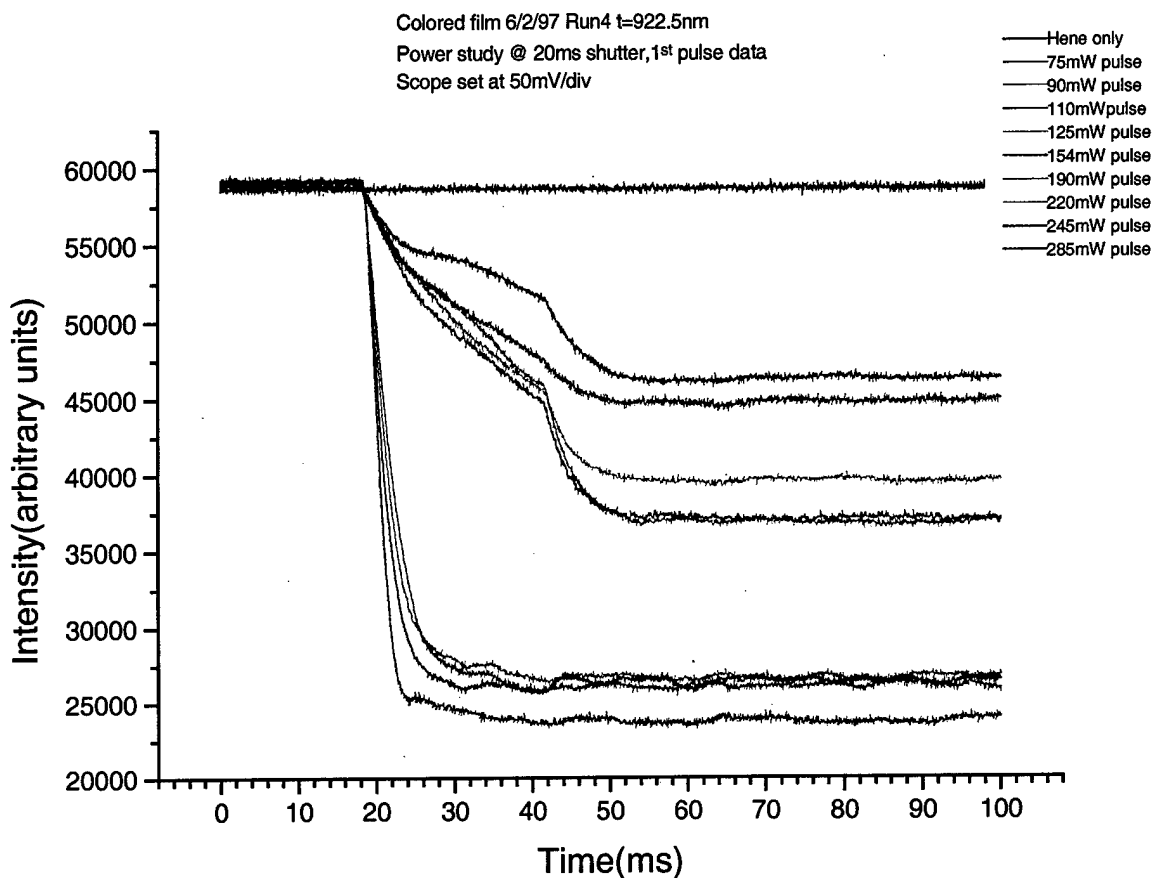

Figure 13. Effect of increasing power of first exposure.
 (Too high a power "writes" a spot which can then not be switched back, except by using electrochemical reduction.)

On the whole the layered films were very similar to each other and to simple oxygen deficient tungsten oxide films. The average maximum modulation of the particular layered films examined was consistently less than the maximum modulation observed for the simple films. Although the thickness of the tungsten oxide layer in the layered films was less than that for any of the simple films, even accounting for the absorption, this does not seem to be sufficient to account for the decrease in modulation compared to the simple films. More experiments will be needed to establish and, if necessary, quantify this as fact.

V. Conclusions

This study has provided unequivocal proof of principle of large-scale memory as well as unique all optical switching behavior. Either phenomenon could be the basis for commercial technology based on tungsten oxide. We have also seen proof of a variety of metal oxides having substantial promise to be superior to the simple oxygen deficient tungsten oxides. There appear to be two processes which are occurring when the control light is present. One involves the irreversible loss of modulation and the other is the reversible modulation. We are currently not able to distinguish between at least a few possible pictures of what microscopic processes are at the base of the memory and switching behaviors observed during this search for improved POMS materials.

We have observed that a number of molybdenum oxides have sensitivity to blue-green light, much like simple tungsten and molybdenum oxide (i.e. nominally WO_3 and MoO_3). In addition, the tungsten cluster species, decatungstate and dodecatungstate, show extreme sensitivity compared to any of the film materials surveyed. These are perhaps the most promising of the new POMS materials we examined. It is interesting to point out that on this basis it is unlikely that the laser chemical vapor deposited tungsten oxide cluster films contain such clusters. The laser deposited films still present perplexing questions regarding their microscopic structure and chemistry.

The irreversible modulation would seem to involve defect annealing out of the active region of the switch. A physical transformation involving a crystallization or perhaps some other modification that eventually prevents defects from re-diffusing back into the active region of the switch seems likely. The reversible process, i.e. switching behavior, involves the motion of photo-generated charge carriers. We have eliminated the possibility that proton mobility has any effect on these switches. This is highly significant because proton and cation mobility are thought to be crucial to the electrochromic and certain parts of the photochromic behavior of tungsten and molybdenum oxide.

Application Opportunities

There are many application possibilities for the observed behaviors. First, multiplexing and demultiplexing optical data off and on to fiber optics systems seems certain. These films can be placed directly onto the output facet of optical fiber. This "fiber mounted switch" can be switched by an external light source or electronically, providing considerable system engineering flexibility. Routers and other switching devices would be potential extensions of these observed behaviors. What is unique about these switches is that incoming optical data can potentially be used to switch its own path or the path of some other incoming optical data. One important question involves the integration of the switching behaviors we have observed with the properties of erbium-doped fiber lasers/amplifiers. If these amplifiers can be used then the switching we have observed may well justify another close look at some type of optical computing application.

This study showed that sol-gel films were quite similar to sputtered films. Whether oxygen deficient as prepared or electrochemically reduced subsequent to deposition, either of these types of films show great promise for switching and memory applications. The manufacturing advantages of sol-gel materials are almost certainly exploitable in implementing tungsten oxide based POMS technologies. In addition, it is clear that electrochemical reduction can be used in juxtaposition to the laser processing we employed, to achieve a type of erasing or simply to achieve large scaling fixing of the oxidation state of the films for large-scale manufacturing.

The use of overlayers may provide useful modifications to the behavior of simple films and should be examined more closely. The simplicity in manufacturing without the use of extra overlayers should not be lost and should be considered in the cost benefit analysis. Such a decision will affect media costs and the types of memory products which can be produced. Since a part of the POMS competitive advantage over other memory technologies is the potential for being able to produce huge capacity products in a single volume, and this would be affected negatively by a need for extra layers, we will always want to avoid the absolute need for such layers when possible.

Finally, we showed that a wide variety of lasers can be used to implement drives for POMS processes. All wavelengths between 410 nm and 610 nm have significant efficacy for initiating POMS behaviors. There are apparently sufficient defects to allow use of virtually any wavelength in this range to implement a POMS based device. GaAs based devices could certainly provide the infrared source, and the new 410 nm GaN based lasers or VCSEL arrays are potentially applicable to implement POMS.

We conclude that there are considerable opportunities for applications of the POMS technology. Proof of principle has been provided for a wide variety of memory and switching devices / systems which can be prototyped with little or no further basic research effort. These devices all offer improvement over currently available systems in performance, price, and the ability to be integrated into existing systems.

Future Research

Despite the clear demonstration of useful behavior, research and/or optimization must continue to reach the point of commercial viability with regard to the switching behavior. With regard to the memory behavior, write once read many or WORM applications abound. Erasable memory will require some more research, but a commercially viable prototype WORM product is only a year or two away. Future research will involve the POMS process itself, new materials and new device architectures and structures which can exploit the POMS process. Since research will also range from basic to applied, only the most poignant experiments we can currently anticipate will be mentioned.

The wavelength dependence of the POMS sensitivity of tungsten oxide now having been measured, it is necessary to examine the effect of adding an infrared source to increase the net write speed and implement an erase function. Since we established that the write time can be

sub-nanosecond given adequate laser power, and the spatial extent of a written spot is determined by the spatial overlap between the visible and infrared light, we can expect to compensate for the limited flexibility of available visible lasers using the high CW power offered by GaAs devices. These experiments can be conducted in a power regime which spans the switching and memory behavior we have observed during this effort.

It would be worthwhile to do both the memory and switching experiments using the kind of electrochromic windows, i.e. so-called "smart windows", that are driven by external circuitry instead of using chemical reduction as was used during this effort. The chemical reduction could be the basis for a commercial device, but the electrochemical approach may have advantages of a more fundamental type. In particular, the memory effect which limits the cyclability of the switching behavior could be more effectively suppressed using the electrochemical treatment.

It would be very exciting to fabricate media from the polyoxotungstate materials investigated during this effort. These materials were shown to be extremely sensitive during this effort. It seems probable that a slurry of these materials dispersed in an appropriate solvent, precipitated so as to be composed of very fine particles, could be spin coated or "squeegeed" onto various types of substrates to produce usable media. Toluene diluted metal alkoxide could be the basis for a useable solvent system.

Investigating the use of scanning probe technology with tungsten oxide materials is more enticing than ever. This effort has provided excellent leads identifying increasingly sensitive metal oxide systems. All the types of materials described in this effort should be examined using some form of scanning tip probe, e.g. scanning tunneling microscopy or atomic force feedback. The sensitivity previously observed by Matt Cote and us pertained to oxidized foils and by Bussjager and us to sputtered films. The latter observations were apparently an electrochemical process accompanying injection of macroscopic charge whereas the tunneling currents are much smaller and therefore, due to the potential for nonlinear reaction kinetics between charge carriers and traps, i.e. W^{+5} and W^{+6} sites, the type of behavior may be different. There is not necessarily any charge transfer accompanying an atomic force metered scan, but the process may be useful for reading and certainly informative on a basic science level.

Finally, it would be smart to investigate the behavior of tungsten oxide films sputtered directly on a cleaved optical fiber. We should be able to switch the fiber on and off using an external laser. By "on" and "off" we intend to modulate the transmission through the end of the fiber. This external laser could be delivered/coupled via free space or fiber. Such behavior would be useful for implementing discrete switching of data in fibers as is needed in switching networks, multiplexers and demultiplexers. One assumes that the data will usually be in the 1550 nm wavelength range and so the possibility of integrating these switches with Erbium doped fiber lasers is clear. Given this situation, it may also be possible to switch the data in one fiber using data contained in other fibers with interconversion between the electronic and optical domains at any level.

BIBLIOGRAPHY

1. R. Martin Villarica, J. Chaiken, Fazio Nash, Joseph Osman, Rebecca Bussjager, "Reversible Phoredox Processing of Transition Metal Oxides", Proc.Mat.Res.Soc.397, 347-352(1996)
2. Chaiken et. al. US Patent 5,691,091
3. Chaiken et. al. US Patent 5,837,424
4. Rebecca Bussjager, Joseph Osman, Joseph Chaiken "A nonlinear interface optical switch structure for dual mode switching revisited" Proc. SPIE 3384, 137-147(1998)
5. M. J. Casey, J. Osman, and J. Chaiken "A nonlinear interface optical switches based on photorefractive thin films" Proc. SPIE 1626, 217-225(1992)
6. see for example Yvonne A. Carts, "Optical computing nears reality", Laser Focus World March 1990, pp. 53-54 and D.A.B. Miller et al, "Integrated quantum well self-electro-optic effect devices: 2x2 array of optically bistable switches", Appl. Phys. 49, 821(1986)
7. A. I. Kaplan "Hysteresis reflection and refraction by a nonlinear NIOS by nonlinear boundary: A new class of effects in nonlinear optics" JETP Lett., 24, 114-119(1976)
8. see Seth Marder, John E. Sohn, Galen D. Stucky editors "Materials for Nonlinear Optics: Chemical Perspectives", vol. 455 ACS Symposium series(American Chemical Society, Washington D.C. 1991)
9. see for example Robert Pool, Science 248, 1186-1188(1990)
10. see J. Chaiken, Chapter 1 (and others) in "Laser Chemistry of Organometallics", vol. 530, ACS Symposium Series (American Chemical Society, Washington, D.C., 1993)
11. J. Chaiken, M. J. Casey, M. Villarica, "Laser chemistry of organometallics as a general synthetic route to metal clusters" J. Phys. Chem. 96, 3183-3186(1992)
12. Chaiken et. al. US Patent 4,971,853
13. W.C. Dautremont-Smith Displays "Electrochromic displays based on anodically and cathodically colored tungsten oxide films", 3, 3-22(1982) note that there are 300 references included
14. Scott Elder, Battelle Pacific Laboratories Northwest, personal communication.
15. J. M. Osman, R. J. Bussjager, F. Nash, J. Chaiken, R. M. Villarica, "Photoredox Laser Chemistry of Transition Metal Oxides" J. Appl. Phys. A. 66, 223-228(1998)

16. Rebecca Bussjager, J. M. Osman, R. Martin Villarica, J. Chaiken "Material for Optical Memory" Proc. SPIE 3075, 34-46(1997)
17. J. Osman, Rebecca Bussjager, J. Chaiken, F. Nash, "One and Two Color Photorefractive Processes in Sputtered WO₃ Films" Proc.Mat.Res.Soc.495, 339-344(1998)
18. R. Bussjager, J.M. Osman, M. Getbehead, Capt. D. Hinkel, D. Grucza, T. McEwen, B. Myers, N. Holzhauser and J. Chaiken, "Spinning Disk test stand for two-color, tungsten oxide based optical memory system" IEEE Aerospace Conf. Proc. on CD ROM ISBN #0-7803-5427-3 paper no. 6.103, March 6-13, 1999
19. for example see K. Miyake, H. Kaneko, N. Suedomi and S. Nishimoto, "Physical and electrochromic properties of rf sputtered tungsten oxide films" J. Appl. Phys. 54, 5256-5261(1983)
20. see J. P. Cronin et. al. "Properties of WO₃ coatings for large area electrochromic devices" Ceram. Trans. 92, 175-193(1999)
21. see for example of the sodium decatungstate cluster" Charles Tanielian, Katherine Duffy and Alexandra Jones, "Kinetic and Mechanistic Aspects of Photocatalysis by Polyoxometallates: A laser flash photolysis, Pulse radiolysis and continuous photolysis study", J. Phys. Chem B. 101, 4267-4282(1997), and references therein.
22. see J. W. Johnson et al "New layered compounds with transition metal oxide layers separated by covalently bound organic ligands: molybdenum and tungsten trioxide-pyridine" J. Am. Chem. Soc.103, 5246-5250(1981)
23. Yoshiike US Patent 4,711,815
24. Matthew J. Cote, Corey Radloff, J. M. Osman, Rebecca, Bussjager, R. Martin Villarica, Fazio Nash and J. Chaiken. A surface Raman and Scanning Tunneling Microscopy study of the spatial distribution of Corner-sharing and edge sharing octahedra on thermally oxidized tungsten" Proc. Mat.Res Soc. 495, 413-418(1998)
25. Akzo Nobel Corp. San Diego CA.