

JPRS 71805

5 September 1978

TRANSLATIONS ON EASTERN EUROPE  
SCIENTIFIC AFFAIRS  
No. 599

EAST

EUROPE

**DISTRIBUTION STATEMENT A**  
Approved for Public Release  
Distribution Unlimited

Reproduced From  
Best Available Copy

20000724 103

DTIC QUALITY INSPECTED 4

U. S. JOINT PUBLICATIONS RESEARCH SERVICE

#### NOTE

JPRS publications contain information primarily from foreign newspapers, periodicals and books, but also from news agency transmissions and broadcasts. Materials from foreign-language sources are translated; those from English-language sources are transcribed or reprinted, with the original phrasing and other characteristics retained.

Headlines, editorial reports, and material enclosed in brackets [ ] are supplied by JPRS. Processing indicators such as [Text] or [Excerpt] in the first line of each item, or following the last line of a brief, indicate how the original information was processed. Where no processing indicator is given, the information was summarized or extracted.

Unfamiliar names rendered phonetically or transliterated are enclosed in parentheses. Words or names preceded by a question mark and enclosed in parentheses were not clear in the original but have been supplied as appropriate in context. Other unattributed parenthetical notes within the body of an item originate with the source. Times within items are as given by source.

The contents of this publication in no way represent the policies, views or attitudes of the U.S. Government.

#### PROCUREMENT OF PUBLICATIONS

JPRS publications may be ordered from the National Technical Information Service, Springfield, Virginia 22151. In ordering, it is recommended that the JPRS number, title, date and author, if applicable, of publication be cited.

Current JPRS publications are announced in Government Reports Announcements issued semi-monthly by the National Technical Information Service, and are listed in the Monthly Catalog of U.S. Government Publications issued by the Superintendent of Documents, U.S. Government Printing Office, Washington, D.C. 20402.

Indexes to this report (by keyword, author, personal names, title and series) are available through Bell & Howell, Old Mansfield Road, Wooster, Ohio, 44691.

Correspondence pertaining to matters other than procurement may be addressed to Joint Publications Research Service, 1000 North Glebe Road, Arlington, Virginia 22201.

JPRS 71805

5 September 1978

TRANSLATIONS ON EASTERN EUROPE  
SCIENTIFIC AFFAIRS

No. 599

CONTENTS

PAGE

INTERNATIONAL AFFAIRS

New Computer Designed by Bulgarian, Soviet Specialists  
(TRUD, 23 Aug 78) ..... 1

CZECHOSLOVAKIA

Digital Channel of the TESLA MPK 32 PCM System  
(Antonin Hajek; SDELOVACI TECHNIKA, No 9, 1977) ..... 2

HUNGARY

Projects of Plant Protection Research Institute Highlighted  
(Gabor Pal Peto; NEPSZABADSAG, 27 Jul 78) ..... 16

YUGOSLAVIA

Tomislav Ivanov Discusses Macedonian Natural Resources  
(Tomislav Ivanov Interview; SABOTA, 15 Jul 78) ..... 21

INTERNATIONAL AFFAIRS

NEW COMPUTER DESIGNED BY BULGARIAN, SOVIET SPECIALISTS

Sofia TRUD in Bulgarian 23 Aug 78 p 1

[Text] Moscow, 22 August (BTA report)--The Soviet Union will soon start the serial production of the EO-1035 [ZEMEDEL'SKO ZNAME 23 August 1978 carries a shorter report and refers to the computer as EC-1035] electronic calculating machine which will have the capacity to perform 140,000-160,000 operations per second. This new machine was highly appraised by CEMA specialists.

The new machine will be widely utilized in the solution of a wide range of scientific-technical, economic, and other problems. Its specific feature consists in its compatibility with other models of calculating machines as well as the convenience with which it can be operated. Bulgarian specialists, jointly with specialists from the Minsk scientific-research institute, actively participated in the development of this new computer.

One of the most vulnerable aspects in previous generations of computers was the operational memory. Bulgarian engineers resolved this problem by developing a control panel and an operational memory device consisting of semi-conductor elements.

The Minsk computer plant will specialize in the production of the new computer. In accordance with the coordination plans Bulgaria will produce parts and components for the new computer.

CSO: 2202

## DIGITAL CHANNEL OF THE TESLA MPK 32 PCM SYSTEM

Prague SDELOVACI TECHNIKA in Czech Vol 25 No 9, 1977 pp 327-331

[Article by Engr. Antonin Hajek]

[Text] The currently manufactured TESLA MPK 32 transmission system is an improved version of the TESLA KPK 32 system (1). This new system, designed for international and domestic circuits, makes it possible to transmit conversation, other signals, or discrete information over 30 telephone channels within a frequency range of 300 to 3,400 Hz.

What constitutes an inseparable part of the system is the digital channel, which provides for transmission of the PCM pulse signal from the equipment of one terminal to another. Transmission in both directions takes place through two pairs of conductors with a transmission speed of 2,048 Mbits per second, a pair of conductors in one direction and a second pair of conductors in the other direction. The transmission can take place on symmetrical unloaded low-frequency copper cables with core diameter of 0.4 millimeter to 1.4 millimeters and paper or plastic insulation, or equivalent diameters with aluminum cores.

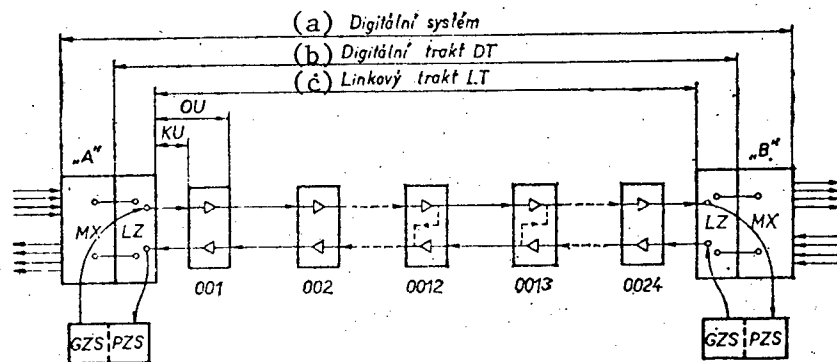

Figure 1. Block diagram of a digital tract of the MPK 32 system.  
 Legend: MX = multiplex equipment, LZ = line terminal, 00 = bidirectional repeater; KU = cable sector, OU = repeating sector, GZS = test signal generator, PZS = test signal receiver.

Key: a. Digital system      b. Digital tract DT      c. Line tract LT

The digital channel of the MPK 32 system, represented in Figure 1, consists of a line channel LT (line channel) and line terminals LZ. The line terminal consists of a set of bays needed for the operation of the chain. Even though from the structural point of view it is part of the MX multiplex bay it constitutes an independent unit. The line chain consists of cable sectors KU and bidirectional repeaters OO. The repeaters are inserted at certain distances into the line, and their task is to amplify the transmitted pulse signals, which after passage through the cable sector becomes attenuated and distorted in both shape and phase. These signals are also accompanied by interference. There may be as many as 24 repeaters in the chain, depending on its length. The repeaters are placed in airtight and watertight boxes (containers), which are located in underground tanks or suspended on poles.

#### LZ Link Terminal

The link terminal contains the following set of bays needed for the operation of a link chain:

- transmission circuit;
- unidirectional reception repeater;
- feeder of LZ bays and remote-control feeding of repeaters;
- control and protection circuits.

The link terminal makes it possible to connect a multiplexing unit with a link chain, to feed repeaters by remote control, to locate a defective repeater by remote control and to locate an interrupted cable sector. The link terminal and the link chain form an independent functional unit called DT digital channel (see Figure 1).

The transmission circuit connects the output of a multiplex unit with a cable line. One pole of the feeder is connected with a phantom circuit line through an output transformer of the transmitting circuit. This instrument contains a generator of test signals GZS and a receiver of test signals PZS. The GZS generator creates both a special signal for remote control closure of the loop in the repeater, as well as triple signals with variable density of 1/4 to 1/11 and a pseudorandom signal PCM for measurements of the quality of the repeaters in the loop, which is described in greater detail for example in (2, 3, 4, 5). The PZS test signal contains a selective audio meter for evaluation of triple signals, which after passing through the loop return to the line terminal. By using another network transmission instrument for measuring the number of errors in the transmitted code, one can determine, on the basis of the measured frequency of errors, the quality of the repeaters in the loop or it is possible to measure the resistance of the repeaters to interference in production and in repair shops, as stated in (6).

The receiving unidirectional repeater is the last unit in a series of repeaters in the receiving direction of the transmission. Its electrical parameters correspond to the parameters of the bidirectional repeaters of the transmission line. From the point of view of its design, it is built as a slide-in standup unit. At its input, it has sensitive overvoltage protections, coarse protections on the input side are part of the high-frequency distribution network. A unidirectional computer transmits the code to the boundary line of the multiplex, and its input transformer makes it possible to connect the second pole of the feeder to the phantom circuit of the line.

The feeder of the line terminal supplies stabilized current for long-distance feeding of the line chain with a maximum voltage of 240 V. When the long-distance feeding circuit is interrupted, the voltage at the power supply increases only to a definite maximum value of about 250 V. The current is stabilized within the range of  $\pm 3$  percent. The power supply also delivers regulated voltage for all LZ units as well as voltage for localized interrupted cable sectors KU. Each LZ can be used to localize the interruption of the KU in that portion of the LT line tract which is fed with power from the given LZ. This is done by reversing the polarity of the voltage of the long-distance supply system.

Monitoring and protection circuits give a warning, when isolated grounding creates a current in some of the energized portions of the LT. If the current does not exceed the value of about  $100\mu\text{A}$ , the warning is visual, when the current reaches about 1 mA, the voltage of the long-distance supply system is automatically reduced to a value which is safe for the service personnel. This not only identifies breakdowns in the cable, particularly where the cable has become wet but it also provides protection to persons, against ground causes shock. Control circuits also include a simple error meter in the transmitted code, which may be either AMI or HDB 3. Errors are indicated for quick reference by a bulb on the panel of the given unit.

The link terminal has the same overvoltage protection provided by lightning arresters as the protection of bidirectional repeaters of a power line.

#### Bidirectional Repeater

Bidirectional repeater 00 constitutes an independent structural unit, which contains two unidirectional repeaters for transmission direction of "go" and "back," circuits for long-distance localization of a defective repeater and interruption of a cable sector, circuits for long-distance power supply and sensitive protection against the effects of overvoltage. A block diagram of a bidirectional repeater is shown in Figure 2. The signal coming from a line terminal or previous repeater reaches the input transformer TR1, from which it passes to the place of decision MR through a solid corrector PK, automatic corrector AK and amplifier Z1. The automatic corrector AK is controlled from MR through the maximum value detector D and

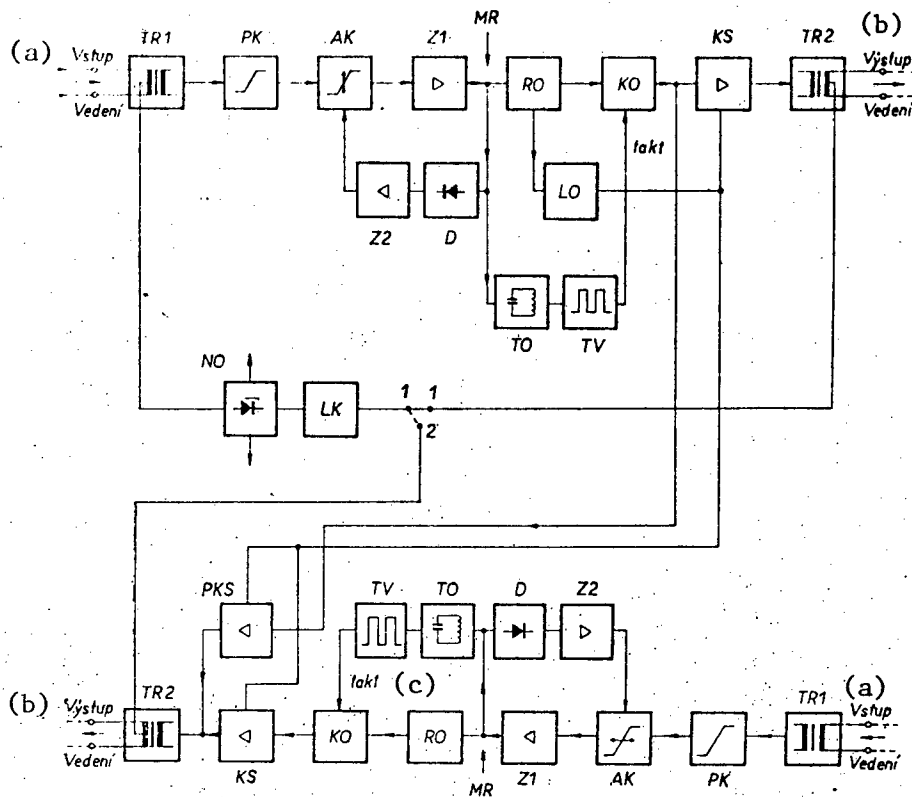

Figure 2. Block diagram of a bidirectional repeater of the MPK 32 system.

Key:

- a. Line inlet      b. Line outlet      c. Tact

unidirectional amplifier Z2. The signal branches further from MR to the so-called "direct path" and "cycle path." The time-carrying component of the signal is renewed in the cycle path. The signal passes to the timing circuit TO which is followed by the forming circuit TV, which converts the sinusoidal voltage from TO to square wave voltage with a width of  $T/2$  and a ratio of 1:1, the so-called cycle. In the direct line behind MR follows the decision-making circuit RO, which determines the probable status of the signals. From there, the signal is brought to the coincidence circuit KO, in which coincidence with the cycle is accomplished. The signal, renewed at the output of KO, is brought to the terminal stage KS, which is attached to the output transformer TR2, from which the signal enters the next cable sector KU.

The power supply process takes place by remote control through the phantom circuit from LZ, so that the supply current is fed from the center of the input transformer TR1 through the power feeding circuit NO containing Zener diodes and a circuit for locating the place of the interrupted cable LO, either on a secondary winding or the output transformer TR 2 in the case of continuous power feed (connected points 1-1) or in the case of the last repeater in the power supply network to the secondary winding of transformer TR2 of the repeater in the opposite direction of the transmission (connection points 1-2), from which the current is returned to LZ.

The activity and function of the repeater was described in greater detail and quite adequately for example in (7, 8, 9), and therefore in the subsequent discussion we shall confine ourselves only to the new, original design of the automatic corrector and remote control location of the defective repeater.

### Automatic Corrector

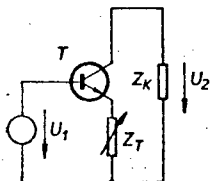

Figure 3. Principal diagram of an automatic corrector with controlled emitter impedance.

The original contacts of the automatic corrector described in (10) are used in the repeater. The principal diagram of the automatic corrector is given in Figure 3. In the emitter of transistor T, there is connected a variable emitter impedance  $Z_T$ , which is connected in the system as a bridged element T, the behavior of which is very similar to that of a Bode corrector. The classic connection of the Bode's variable corrector dates back to 1938, and because of its good properties it continues to be used today. However, the given connection of the variable corrector with controlled emitter impedance has better noise properties than the passive Bode corrector, which has extensive basic dampening. The control scope of the dampening characteristics slope, which can be achieved by one single element, is 12 dB per octave.

By using the given corrector, it was possible to achieve a correction range of the repeater of 4 to 36 dB of the dampening of the cable measured at the frequency of 1 MHz, which is approximately  $f_0/2$  where  $f_0$  is the transmission bit frequency of 2048 KHz. The maximum length of the cable sectors KU, which can be bridged and can be used for local cables with core diameters ranging from 0.5 millimeter of U to 0.9 millimeter of U, and the length of the line tracts used for the maximum number of 24 repeaters in the tract are given in Table 1.

Table 1. Maximum lengths of the cable sectors KU and line routes LT, which can be bridged for local cables with different diameters of the cores.

(a) $\varnothing$ Cu zily [mm]	KU [km]	LT [km]
0,5	1,8	43
0,6	2,3	55
0,8	3,2	77
0,9	3,3	79

Key:

a. Copper core diameter (in millimeters)

The functioning of an automatic corrector can be observed best by means of oscillograms, the so-called "eyes of decision-making," which we get by connecting the probe of an oscilloscope to the place of decision-making of the MR repeater to be tested and synchronization of the oscilloscope with the time base of a pseudorandom code generator, from which the code is brought into the repeater. Figure 4 shows an oscillogram of "eyes of decision-making" of bipolar impulses with an amplitude of  $A_x$ . The internal cover curve of the overlapping impulses creates a detection area, in which at the moments  $t_1$ ,  $t_2$ ,  $t_3$ , and so on the decision-making circuit RO is to decide about the status of the signal, which means it has to decide whether the signal assumes a value of 0 or 1. This detection area, marked in Figure 4 in shaded form, is usually called an eye because of its shape. In order to provide for the same probability of an error of both symbols 0 and 1, the threshold of decision making is adjusted to half of the height of the detection area, which in the given case is  $A_x/2$ . At the moments of  $t_1$ ,  $t_2$ , and  $t_3$ , there is coincidence with timing impulses.

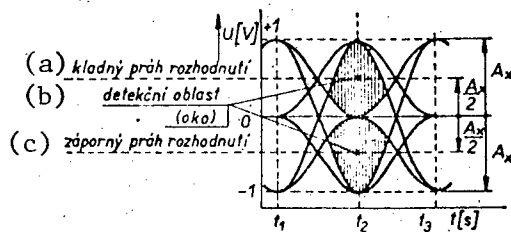

Figure 4. Diagrammatic representation of an oscillogram of "decision-making eyes."

Key:

- a. Positive threshold of decision making
- b. Detection area (of the eye)
- c. Negative threshold of decision making

The larger the detection area, the more open the decision-making eye, and the greater is the resistance of the repeater to interference. The detection area is reduced particularly by symbol interference and disturbance. In the same way, when there is phase instability of the tact impulses, when the decision-making moments  $t_1$  to  $t_3$  are not in the center of the detection area, where the detection area is the highest, the result is a reduction of the resistance of the repeater to interference. A detailed analysis of the influences which reduce resistance to interference is given for example in (11) and (12).

Figures 5 to 8 show oscillograms of the "decision-making eyes," obtained during laboratory tests of the new automatic corrector used for various types of dampening of artificial lines simulating the dampening of the local copper cable 0.8 millimeter in diameter. Figure 5 shows the arrangement for the length of 800 meters, Figure 6 for 1400 meters, Figure 7 for

2200 meters and Figure 8 for the length of 3200 meters of the given cable, which is the maximum length that can be spanned. Among the given oscillograms, one can see that the best correction was obtained for the length of the conductor of 2200 meters and for the short sector of 800 meters. Moderate limiting of the signal in short sectors does not deteriorate the resistance of the repeater to interference, because the input signal has a much higher voltage than in long sectors.

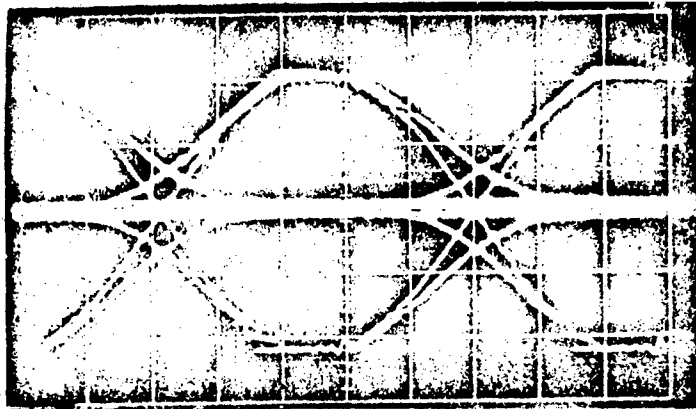

Figure 5. Oscilloscope of "decision-making eyes" at the point of decision-making of the repeater for a length of the cable sector of 800 meters, diameter 0.8 millimeter of Cu,  $t = 100$  ns/division,  $U = 1$  V/division.

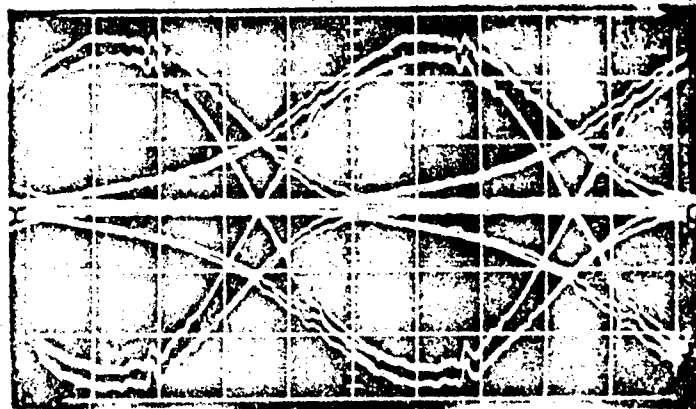

Figure 6. Oscilloscope of "decision-making eyes" at the point of decision-making of the repeater for a length of the cable sector of 1400 meters, diameter 0.8 millimeter of Cu,  $t = 100$  ns/division,  $U = 0.5$  V/division.

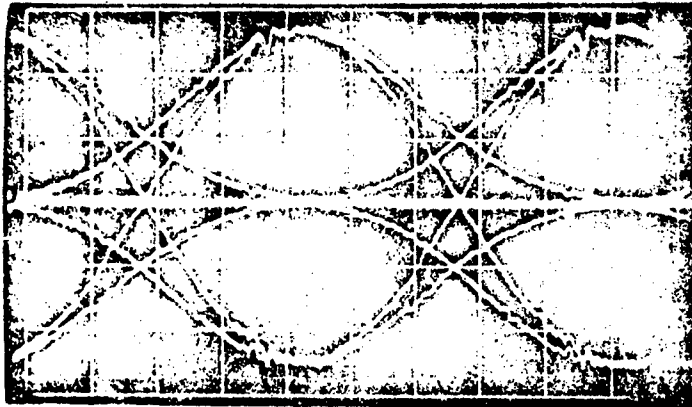

Figure 7. Oscillogram of "decision-making eyes" at the point of decision-making of the repeater for the length of the cable sector of 2200 meters, diameter 0.8 millimeter of Cu,  $t = 100$  ns/division,  $U = 0.5$  V/division.

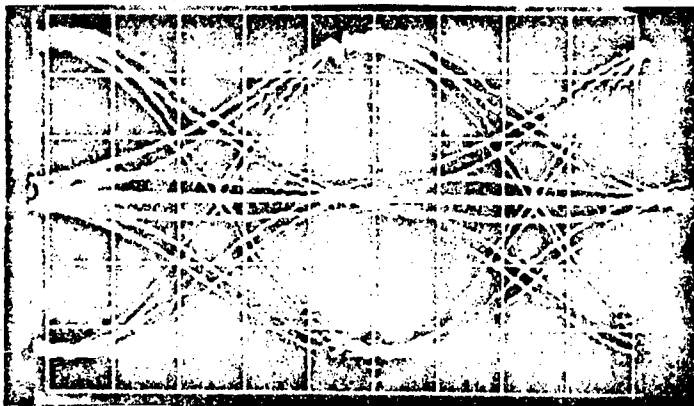

Figure 8. Oscillogram of "decision-making eyes" at the point of decision-making of the repeater for the length of the cable sector of 3200 meters, diameter 0.8 millimeter of Cu,  $t = 100$  ns/division,  $U = 0.5$  V/division.

#### New Method of Remote Control Location of a Defective Repeater

The method used to locate a defective repeater is based on closing of the loops in individual repeaters, as shown in Figure 1 in the case of repeaters 12 and 13. The command for remote control closing of the loop in repeaters number 1 to 12 is transmitted from the service station at point "A" from the generator of the test signal of the GZS, the command for closing the loop in repeaters number 13 to 24 is transmitted from the service station at point "B," which is determined by the fact that each serviced station (of the line terminal LZ) feeds a maximum of 12 repeaters. If the line

tract contains less than 12 repeaters, then the repeaters can be fed and located from one service station.

The command for remote control closing of the loop is formed by interrupted impulse sequence of signals of a given low frequency rate. In the case of the KPK 32 system, it was necessary to locate only seven repeaters from each serviced station, which means that seven different low frequencies were sufficient for locating a defective repeater. These frequencies were determined by a tested repeater. Such frequencies must be coming from a relatively narrow frequency range of 12 to 22 kHz. This range is limited in the direction toward higher frequencies, because incidental spectral components, which occur in a normal transmission of the PCM signal, could result in a spontaneous undesirable coupling of the loop; and in the direction towards lower frequencies such coupling is limited by the feasibility of the tuned circuit, because at lower frequencies the dimensions of induction increase and there appear parasitic resonances of the local circuit.

As a result of the effect of the feasible value of the quality factor of the tuned circuit, which selects the appropriate low frequency component and the threshold of sensitivity of the connecting circuit of remote control location of a defective repeater from the interrupted sequence of impulses, the loop is connected in a given frequency band, the width of which depends on the temperature and varies from about 1 kHz to 2 kHz. In order to keep the locating circuits functioning correctly, it is necessary to make sure that loops of two repeaters are not connected at the same time. This danger exists particularly with regard to those repeaters where the tuned circuits are tuned to adjacent frequencies. In order to eliminate such an undesirable situation, it is necessary to make sure that two locating frequencies not correspond to the connecting frequency band of one locating circuit within the entire extent of the operational temperatures of the repeater, i.e., from  $-40^{\circ}\text{C}$  to  $+50^{\circ}\text{C}$ . It was difficult to satisfy the requirement even during the development of the KPK 32 system, where 7 locating frequencies were used. However, in the case of the MPK 32 system it was necessary to locate 12 repeaters, which means that it was necessary to develop a new method of remote control connection of loops in repeaters. The method is described in detail in (13).

The nature of the new method consists in the fact that by transmitting any of the  $n$  frequencies the remote control locating circuit in  $(n-1)$  repeaters is prepared for activation, and by the subsequent transmission of another of the  $n$  frequencies the loop of the remote control location is connected in a definite repeater out of the total number of  $n$   $(n-1)$  repeaters. This means that in order to locate 12 repeaters we need only 4 frequencies. The pairs of these frequencies are assigned to locating circuits of the repeaters according to Table 2.

Table 2. Attachment of pairs of low locating frequencies to locating circuits of the repeaters

Opakovač č. (a)	1	2	3	4	5	6	7	8	9	10	11	12
Přípravná frekvence (b)	$f_1$	$f_1$	$f_1$	$f_2$	$f_2$	$f_2$	$f_3$	$f_3$	$f_3$	$f_4$	$f_4$	$f_4$
Spínací frekvence (c)	$f_2$	$f_3$	$f_4$	$f_1$	$f_2$	$f_3$	$f_4$	$f_1$	$f_2$	$f_3$	$f_4$	$f_1$

Key:

- a. Repeater number
- b. Preparatory frequency
- c. Connecting frequency

We shall give for example the process involved in closing the loop of repeater number 12, as indicated in Figure 1. First of all, we transmit a pulse sequence modulated by the preparatory frequency  $f_4$  from the generator of the test signal of the GZS connected with the line terminal at point "A." This frequency prepares logical circuits of remote control location of repeaters numbers 10, 11, 12. After that, we transmit the pulse sequence modulated by the connecting frequency  $f_3$ , by which the loop closes only at the 12th repeater. After measuring the repeaters in the loop, we disconnected the closed loop by interrupting the remote control supply current in the line terminal LZ at the point of the service station designated in Figure 1 as "A."

The formation of a loop in the repeater can be observed in a block connection of the bidirectional repeater shown in Figure 2. The locating circuit LO has at its inlet two tuned circuits tuned to one pair of frequencies specified in Table 2. After receiving the connecting frequency, the transistors are closed in the terminal stages KS of both unidirectional repeaters, and the open transistors of the auxiliary terminal stage PKS, through which the signal is transmitted from the outlet of one unidirectional repeater to the inlet of the second unidirectional repeater. As a result of that, a loop is formed in the bidirectional repeater. When the measurements are completed by interrupting the current of the remote control feeding power line and by connecting it again, the transistors of both terminal stages KC open again and the transistors in the auxiliary terminal stage PKS close. As a result of that, the loop is disconnected and the system operates normally.

The new method of two-frequency selection of the located repeater helped considerably to provide for reliability of the locating circuit of the repeater. The circuit is more resistant against accidental and undesirable closing of the loop as a result of incidental spectral components of the PCM signal during normal operation than in the case of single-frequency closing of the loops. The reduction of the number of locating frequencies made it possible to expand the connecting frequency zone of the locating circuits. That reduced the dependence on the temperature and dispersion of the transistors used. When a suitable frequency zone of the locating frequencies is maintained, it is possible to use this

method of location of a larger number of repeaters. A comparison of the methods of remote control of the activities of the repeaters of the systems with PCM is given in (2).

#### Placement of Repeaters

A bidirectional repeater, a functional model of which--removed from the case--is shown in Figure 9, has in its front panel helical tips, which in addition to providing for a high degree of reliability of the connection, makes it also possible to install the repeater under field conditions where a supply power line is not available.

The repeaters are located in airtight and watertight metal cases (containers), which are equipped with two connecting cables about 3 meters long. There are several 4-core wires in the cable. These can be used for service connection between two terminal installations or between a terminal installation and any container. In order to do that, the installation is delivered with a portable service communication set which is supplied with power from batteries inserted in the set.

The internal terminals of the connecting cables and at cable locks of the container and make it possible to connect the container with its internal cable system. Figure 10 shows a container for four bidirectional repeaters, including connecting cables shown in a shipping pack.

[photo not reproduced]

Figure 9. Functional model of a board of a bidirectional repeater of the MPK 32 system.

[photo not reproduced]

Figure 10. Container of the MPK 32 system for four bidirectional repeaters, including connecting cables in shipment packing.

The containers are hermetically sealed against internal overpressure in such a way that the decrease of pressure in the container in the course of a year would not be more than 0.2 atmosphere from the original overpressure of 0.7 atmosphere (at the same temperature). The containers will be manufactured so that they could be placed in 4, 8 or 12, bidirectional repeaters.

It is assumed that the container will be placed in underground cubicles, in driveways, in the cellars of buildings and on poles, where the container would be protected against the weather by a case made of sheet metal.

All pairs of connecting cables will be protected by three-electrode lightning arresters placed inside of the container, which will be equipped with ground terminals. The container can be filled with compressed air or gas at the maximum pressure of 0.7 atmosphere. The air is brought in by a hose,

and at the same time arrangements are made to allow passage of compressed air from cable to cable, and before the container is opened one can seal the cables hermetically inside of the container, so that there would not be an excessive decrease of pressure in the cable. It is expected that a dehumidifier will be placed in the container. Lightning arresters of the container, together with sensitive protective devices in the repeater, protect the repeater against an overvoltage of 2 kV.

#### Evaluation of the Properties of the Digital Tract

Table 3 shows in a schematic way certain major parameters of line tracts of some manufacturers of equipment with PCM of the first order. For purposes of comparison, the table gives also the parameters of the line tract of the KPK 32 system. The table shows that the line tract of the MPK 32 shows better properties, particularly with regard to these indexes.

The length of the repeating sector has been extended for a copper cable with a diameter of 0.8 millimeter from 2.5 km to 3.2 km by using an automatic corrector of a new type. As a result, at the same time this reduced substantially the labor consumption in the process of inserting repeaters in the line, because the measurements of attenuation have been eliminated from individual cable sectors, and the same applies to additional building of lines. In the same way, changes in the attenuation of the cable with temperature, oscillations of the amplitude of impulses as a result of the aging of the components and temperature changes, which deteriorated in the past the properties of transmission, will be controlled by an automatic compensator.

The increased voltage of the source of remote control supply line and the new method of locating a defective corrector made it possible to increase the number of repeaters from 14 to 24. As a result, the length of the line for the given cable has been extended from 35 km to 77 km.

The new design concept makes it also possible to use the line independently, because the digital line constitutes an independent functional unit. Furthermore, the new line is equipped with a system for locating interruption points of the cable pair and continuous control of the quality of transmission.

As a result of a more complex circuit, the input of the repeater has been increased about 15 percent compared to the previous repeater. The higher supply voltage of the source of remote control feeding required protection against contact.

Basic information for projection of the lines of the MPK 32 system from the point of view of their use in the Czechoslovak telecommunications network is given in (14).

Table 3. Parameters of line tracts of the equipment with PCM of the first order

(1) Výrobce	(2) Název systému	(3) Počet hovorených kanálů	(4) Max. délka linky traktu pro kabel s žilami 0,8 mm bez mezilehlé napájecí stanice	(5) Maximální útlum opakovačného úseku	(6) Rozsah korekce		(9) Max. počet obousměrných opakovačů v linkovém traktu (bez mezilehlé napájecí stanice)	(10) Příkon obousměrného opakovače	(11) Napětí zdroje dálkového napájení	(12) Proud zdroje dálkového napájení	(13) Rozsah pracovních teplot opakovače	(14) Počet obousměrných opakovačů v kontejneru	(15) Způsob lokální vady. vady. opak.	(17) Pomocí slyšok
					(7) Automatické	(8) Nemanomatické								
TESLA	KPK 32	30	35 km	28 dB	—	8 ÷ 28 dB	14	0,77 W	120 V	140 mA	-40° ÷ +50 °C	4	/	/
TESLA	MPK 32	30	77 km	36 dB	4 ÷ 36 dB	—	24	0,88 W	240 V	80 mA	-40° ÷ +50 °C	4, 8, 12	/	/
Telefondiar	BD 30-32	30	28,8 km	32 dB	±4 dB	8 ÷ 32 dB	10	1,4 W	160 V	70 mA	-40° ÷ +45 °C	5	/	/
RFT	PCM 30 32	3	43,2 km	40 dB	±10 dB	8 ÷ 36 dB	12	0,72 W	150 V	60 mA	-10° ÷ +35 °C	6	/	/
ITT	PCM 30 32	30	55 km	38 dB	4,5 ÷ 38 dB	—	16	0,55 W	±75 V	50 mA	-40° ÷ +70 °C	6, 36	/	/
Telettra	DT 30	30	45 km	36 dB	—	1,5 ÷ 24 dB	14	0,82 W	±70 V	75 mA	-25 °C ÷ +60 °C	7	/	/
Ericson LM	ZAD 2	30	50 km	35 dB	0 ÷ 35 dB	—	16	0,5 W	±106 V	48 mA	-30 °C ÷ +70 °C	6, 12, 24	/	/
NTT	PCM 24	24	45,5 km	42 dB	10 ÷ 42 dB	—	12	1,1 W	150 V	100 mA	-30 °C ÷ +60 °C	—	/	/
ALCATEL	SMT 2/1	30	109 km	29 dB	—	5 ÷ 29 dB	42	0,42 W	240 V	75 mA	-30 °C ÷ +50 °C	6	/	/
Husler	PCM CH30	30	64,6 km	36 dB	6 ÷ 36 dB	—	20	0,53 W	146 V	49 mA	-5 °C ÷ +45 °C	—	/	/

Key:

1. Manufacturer,
2. Name of the system,
3. Number of telephone channels,
4. Maximum length of the line tract for cables with copper cores 0.8 millimeters in diameter, not including intermediate power supply stations,
5. Maximum attenuation of the repeater sector,
6. Extent of correction,
7. Automatic correction,
8. Non-automatic correction by means of switches,
9. Maximum number of bidirectional repeaters in the line tract (not including intermediary power supply stations),
10. Input of the bidirectional repeater,
11. Voltage of the source of remote control power supply,
12. Current of the source of remote control power supply,
13. Extent of operational temperatures of the repeater,
14. Number of bidirectional repeaters in a container,
15. Method of location of a defective repeater:
16. By means of a special pair,
17. By means of loops.

## Conclusion

The article describes the properties of a digital line of the system with PCM of the first order TESLA MPK 32. There is a detailed description of the original design of the automatic corrector and remote control of location of a defective repeater. This method of remote control location of defective repeaters received authorship certificate in the CSSR No 160,896, in the USSR No 489,229, and the authorship certificates in the GDR and Hungary are being processed. In the same way, authorship certificates No 161,155 and No 176,536 have been granted also for connecting locating circuits.

In conclusion, one can add that the MPK 32 equipment uses modern miniaturized components of a high degree of reliability; it uses silicon semiconductors, digital and analog integrated circuits exclusively. Transmitters, control and service circuits use miniaturized tongue relays. The service life of the installation should be at least 20 years.

## BIBLIOGRAPHY

1. Gajda, J., "Operational Properties of Terminal Equipment of the TESLA KPK 32 system," Sdelovaci Technika (Communications Engineering), 1972, No 11, pp 402-404.
2. Hajek, A., "Remote Control of the Functioning of Repeaters of the Systems Involving the Use of PCM," Sdelovaci Technika, 1977, No 4, p 139.
3. Cermak, J., "Systems With Pulse Code Modulation," NADAS, Prague, 1973.
4. Bennet, G. H., "Testing Techniques for 24-Channel P.C.M. Systems," THE POST OFFICE ELECTRICAL ENGINEERS' JOURNAL, Vol 65, Part 3, October 1972 [in English].
5. Hajek, A., "Testing of Regenerative Amplifiers of the System with PCM by Means of Triple Digital Signals," SBORNIK PRACI (Collection of Works), TESLA VUT, No 11, 1976.
6. Hajek, A., "Measurements of the Resistance of the Repeaters of Systems With PCM to Interference," Sdelovaci Technika, 1976, No 12, pp 451-453.

5668

CSO: 8312/1988 B

## HUNGARY

### PROJECTS OF PLANT PROTECTION RESEARCH INSTITUTE HIGHLIGHTED

Budapest NEPSZABADSAG in Hungarian 27 Jul 78 p 6

[Article by Gabor Pal Peto: "An Old Institution In New Directions. In the Plant Protection Research Institute"]

[Text] It is unlikely that there are too many research institutes in Hungary, in fact there is hardly one, that is already making preparations to celebrate the hundredth anniversary of its foundation as is the MEM [Ministry of Agriculture and Food Industry] Plant Protection Research Institute. The predecessor of the institute was established in 1880 under the name of the National Phyloxera Experimental Station.

Chemicals are the mainstay of the tools of plant protection at present and this situation will continue for a long time in the opinion of experts. This presents a serious problem in two ways: on the one hand, considerations of environmental protection require ever increasing care in selecting chemicals to be utilized for this purpose, and on the other, the production of new and more effective chemicals is a difficult and expensive but necessary task.

#### Sex and Rust

The Plant Protection Research Institute is investigating many facets of plant protection methods. It is concentrating substantial intellectual resources in this area: almost one half of the workers are scientists with academic qualifications. Among them there are two academicians, three possess a Doctor of Sciences degree and there are 15 candidates. The institute has a good reputation abroad; quite often they have to reject foreign researchers wishing to work here for lack of space.

In terms of personnel the biggest department is that of entomology. Historically this has been the kernel of the institute; its activity extends to the most recent scientific area with the greatest long term implications. They are carrying out investigations into sexually attractive scents emitted by insects, called sex feromones. They hope that in time these can be used

to supplement chemical protection measures or reduce the rate of growth of the latter. They have successfully identified and synthetically reproduced the sex feromone of a host of pests, most of them moths. At this time they are utilized merely to assist in collecting specimens and use the sample counts to calculate the reproduction rate of pests and find the optimal timing for chemical protection measures.

Another interesting research topic for the Department of Entomology working in cooperation with the world famous Entomology Institute in Prague is the research into insect hormones: they are studying the compounds which regulate the various phases of the life cycle of insects. On the basis of this knowledge they may be able to synthesize compounds which have no effect on humans or animals but merely prevent this transformation and thereby the emergence of the pest form which is capable of reproduction.

The work carried out in the Department of Pathology is in some ways similar. They are inquiring into the biological and biochemical character of the relationship between the host plant and the organism causing the pathology (virus, bacteria, fungi). This is an area of basic research which represents an indispensable basis for activities directed at breeding of resistant varieties. The department has been working on the propagation and significance of various varieties of the fungus responsible for wheat rot. At the same time it is cultivating these fungus varieties and provides them to domestic wheat breeders. There is also an international research project in pathology coordinated by researchers from the GDR.

#### The Apricot "Stroke"

On the other hand, the research carried out in the Plant Pathology Department belongs under applied research in the strictest sense: investigations into causative factors of new illnesses unknown in Hungary until now and study of the life cycle of the pathogenic organisms. We hear a lot about the "stroke" of apricots and the early destruction of peach trees: these illnesses do not directly harm the fruit, instead, they result in partial or full destruction of the fruit tree itself. This illness endangers the motivation of producers and presents a great problem in other countries, and this is why it called for a coordinated attack by Spanish, Yugoslav, French, Soviet and Hungarian specialists within the framework of the Plant Protection Organization of European and Mediterranean Countries under the direction of Dr Zoltan Klement, senior fellow of the institute. They found that the pathogenic organisms varying from country to country according to climate are wound parasites (bacteria, fungi and in some cases possibly viruses), and they enter through pruning surfaces or other wounds. The key to protection lies in agricultural technology: when pruning of apricot and peach trees is done in the spring instead of in winter (the latter practice is regrettably quite widespread in our country due to the shortage of labor), then the infection almost never occurs, and neither does the "stroke."

It is interesting that there is another direction in the search for a solution: director Dr Lajos Vajna in cooperation with a researcher from the Lorand Eotvos University of Sciences is looking for a chemical (several versions are already in the testing phase) which can get through the bark of the tree (this is the difficult task) and does its work inside, within the cells.

They are also working on illnesses of the sunflower plant, and they have already identified several pathogenic agents. Breeding of resistant varieties is done at the Animal Feed Production Research Institute in Iregszemcse, and the Plant Pathology Department is providing substantial help in this work. This department is also the site of the unit of the domestic microbiological gene bank housing the pathogenic agents which have been exactly identified and are important in Hungary.

Protection must also be found against the oldest known pests, the weeds, especially since there has been a shortage of human labor for manual weeding for a long time. According to one of the directors of this work, Dr Odon Szatala, scientific deputy director of the institute, this research area represents an interesting blending of the most advanced modern direction with the oldest one. This is because certain earlier herbicides discarded due to their toxic effects can again be used after mixing in suitable chemicals; the latter act as antidotes eliminating toxic effects on the crop which were heretofore unavoidable.

#### Ten Kilometers Away

This part of the conversation took place ten kilometers away: the Plant Protection Research Institute has a 120 hectare experimental farm on the outskirts of Budapest (in fact, near the county limit of Pest megye) in Juliamajor where the weed research department is located. There are various laboratories here ("colonies" of other departments), hothouses, and there are small plot farming experiments carried out on approximately twenty hectares.

The virus research department of the institute - the largest plant virus research group in the country - is also located in Juliamajor. Many places would like to be involved in this interesting research area but the equipment and instruments are quite expensive. So the department, led by Dr Laszlo Beczner, has been directed by the MEM to carry out a very important assignment: to coordinate the thematic and financial aspects of domestic plant virus research in addition to basic research and investigations in methodology and virus identification.

To return to the chemicals mentioned in the introduction and to the institute on the Otto Herman Institute Avenue, I was introduced to the work of two departments which were once a single unit. One of them is the biochemical and analytical department. The biochemical group here is studying the

very important question of the functioning of fungicides and the way in which they enter plant tissue. The solution of theoretical problems currently studied by the department may lead to the discovery of laws which may provide indirect help to chemists working on the synthesis of new chemicals. This research topic of the biochemistry department is one of the tasks which are being carried out collectively by institutes of the CEMA countries; this is the coordinating and directing institute under the leadership of the international authority in this area, Dr Gyula Josepovits.

#### One Half of a Dream

The organic chemistry department is struggling with a very difficult question, and the task is again to find the most modern and advanced direction. The production of pesticides (including herbicides, insecticides, fungicides, etc.) and the search for better products has thus far been done using the "reproduction" method via modification and development of existing ones. The long range development program prescribes production of new, original, patentable and exportable pesticides. The research work on a new product takes six to eight years until the start of production. Large Western companies can afford to use a trial method and investigate thousands of compounds, although to find a successful new product nowadays one must in general try 50,000 different compounds. Smaller countries and research groups have only one method open to them: rational pesticide research, which means in essence that new products must be found on the basis of theoretical considerations, i.e., one must discover the chemical structure required for the effect sought. At the present state of the science this remains only a dream. However, the institute has been successful in discovering six pesticides by a semi-rational (i.e., partly trial-and-error) method, which are truly new compounds and not just new variants of known types. Of the approximately eight year calvary of research, development and control (toxicological) work, these have completed two years, and some are in the fourth to sixth year.

Dr Gyorgy Matolcsy, director of the organic chemistry department mentioned a characteristic example of this research method. The effect of some of the medicines used to treat the illness commonly called hardening of the arteries is based on preventing the formation of steroids held responsible for the illness. However, steroids also play an important role in the biological functioning of fungi detrimental to crops. Although the drugs were not directly utilized, they were considered as a model in the search for a fungicide. This product is already in the stage of industrial development.

The principles and methods used by the institute in this area are highly respected internationally; for example, this is demonstrated by the action of the International Union of Pure and Applied Chemistry in selecting Dr Matolcsy as one of the five invited speakers at the rational pesticide research conference held in Zurich on 24-28 July.

The Plant Protection Research Institute is approaching its centenary while working vigorously in search of innovation. Obviously, the above account could cover only a small part of the work going on at the institute (for example, we had no space to include the very important agricultural ecosystem research lead by academician Tibor Jermy and other projects), but perhaps this will suffice to demonstrate that our plant protection research possesses two of its strong bases on the Otto Herman Avenue in Budapest and in Juliamajor.

9164

CSO: 2502

TOMISLAV IVANOV DISCUSSES MACEDONIAN NATURAL RESOURCES

Skopje SABOTA, supplement to NOVA MAKEDONIJA, in Macedonian 15 Jul 78 p 1

[Interview of Prof Tomislav Ivanov by Risto Markovski]

[Text] From a geological viewpoint, Macedonia is extremely interesting. In all of Yugoslavia, 11 new minerals have been discovered up to now, of them, 8 were found in Macedonia. That in itself speaks for the importance of this region to geologists. It can be said that Macedonia is a rare geological polygon with mineral wealth. In its bosom can be found the most varying strata, from the oldest to the youngest. Macedonia is rich in metals, non-metallic deposits, and energy resources. In the past, gold was of major importance, and it remains a goal of prospectors. It is believed that in the near future new discoveries of major ore deposits will be used as an increasing basis of Macedonian economic development.

This retrospective and future projection began the conversation with Prof Dr Tomislav Ivanov, of the Metallurgical Faculty in Skopje. With other geologists, he considers that along with a rich mining tradition, Macedonia still conceals unknown wealth. Ivanov's optimism for Macedonia's geological riches is based on a number of new geological discoveries, and on examination of the mine chart of Macedonia, which is full of new promise for the economy.

Mining Has Gone on in Macedonia for Ages

[NOVA MAKEDONIJA] Mining has been known in Macedonia since ancient times. This is attested by many excavations, old mining operations, remains of smelters, and memorials. Professor Ivanov was asked to say something about the rich mining tradition.

[IVANOV] "Yes, mining has gone on in our region since ancient times. The mines of Macedonia were famous for their rich ores and smelting operations. In this manner, a rich mining tradition was created. The mines were known for their smelting proficiency and for the quality of the metal produced. Both mines and smelters operated here, with production developing without interruption for 700 years and more. It is estimated that mining can be traced back as far as 3,000 years before our era. The first smelting ovens in Europe were unearthed in this region."

In his retrospective summary, Ivanov stressed:

"Macedonia has always been interested in mining. This began with mining related to gold, iron, lead and copper. Then the mining expanded to include more varieties of ores. Later, mining of nonmetallic ores became important. Nonmetals have great potential. Energy resources are also of great significance."

[NOVA MAKEDONIJA] "How would Macedonia be defined geologically?"

[IVANOV] "I think it is a geological polygon in microcosm. In this polygon can be found the most varied strata, from the oldest to the youngest. For Macedonia's geology the key features are the number of major tectonic lines that cross the region. The most important is the so-called Vardar zone. Its chief feature is the wealth of its varying strata with diverse geological origins. I think that from that variety alone we have an enormous wealth in ore deposits.

#### Broadened Perspectives

[NOVA MAKEDONIJA] Professor Ivanov adheres to the conclusion that besides its rich mining tradition, Macedonia still conceals unknown geological wealth. But the present geological findings promise broad prospects in themselves. Here is his scientific and specialized summary:

[IVANOV] "Macedonia is rich in metallic and nonmetallic ore deposits, and in recent times significant energy resources have also been discovered.

"Let us begin with the metal ore deposits. We are rich in iron, nickel, lead, zinc, copper, silver, antimony, and gold. There are good prospects for the discovery of rare elements such as rubidium, cesium, lithium, and strontium. The opportunities for utilizing nickel-bearing ores are also promising."

[NOVA MAKEDONIJA] "And how do you regard the deposits of nonmetals?"

[IVANOV] "There is a great potential in our marbles, as well as in granite, gobjovite and others. There are major discoveries of feldspar as well. In recent years significant deposits of bentonitic clays have been found. The siliceous discovery at Kratovo is the only silica glass deposit found in Europe."

The professor commented on energy resource discoveries as well: "Until now the estimation that Macedonia was poor in fuels was realistic. The energy resources that have been found offer important possibilities."

#### Energy From Coal and Geothermal Sources

Until only 10 years ago, geologists regarded the principle source of coal to be the Negotin fields, followed by the Oslomej deposits near Kicevo. NOVA MAKEDONIJA asked Professor Ivanov about recent discoveries of coal.

[IVANOV] "It is very significant that in recent times important coal reserves have been discovered in the Pelagonian range. There have also been discoveries near Prilep and in Mariovo. I think these are indications of important coal discoveries."

[NOVA MAKEDONIJA] "Uranium has been sought in Macedonia for two decades. Will reserves for fueling atomic reactors be forthcoming from domestic deposits?"

[IVANOV] "I think we must continue to devote attention to nuclear ores."

After pausing to gather his thoughts, the scientist, who has been involved in explorations in geological resources for 24 years, continued:

"It might appear that at Zletovo we have deposits that contain commercial amounts of uranium, but new deposits must be sought in this region. In the same way we must give more attention to extensive deposits with low amounts of uranium. Those too have potential."

[NOVA MAKEDONIJA] "How is the situation on explorations for 'black gold'--oil?"

[IVANOV] "I would say that the test wells drilled so far have not had results. Among energy resources, however, attention must be directed at oil-bearing shale, from which oil can be extracted."

[NOVA MAKEDONIJA] "Certainly, we cannot ignore geothermal energy sources."

[IVANOV] "Macedonia has very favorable circumstances for obtaining geothermal energy. In the vicinities of Gevgelija, Strumica, Kocani, and elsewhere, there are large sites containing geothermal energy. They can provide the most varied energy. Current explorations should be directed toward identifying the sites with the greatest geothermal flow, and this will essentially require combined explorations."

#### Gold-Bearing Rivers Are Not Just History

[NOVA MAKEDONIJA] "In the work of Dr Milovanovic 'How Mineral Wealth Was Found,' it states: 'In the Konjska River west of Gevgelija, gold has been found since the days of Alexander of Macedonia. Large grains of gold have also been found in deposits of the Crna River. Deposits in the lower course of the Vardar River have also been found to contain gold. Significant amounts of gold are also present in the Kriva River, at Bregalnica, and in some other Macedonian rivers....'"

"Civic's well-known work 'The Foundations of Geography and Geology' in 1906 mentions the old mines at Kratovo that produced silver and gold for minting coins.

[IVANOV] "Yes, Macedonia was truly famous for its gold discoveries. In addition to the Konjaska River and Bregalnica, I think there were gold findings at Kriva Lakavica, Dosnica, and probably at other locations. Just 3

months ago, previously unknown gold sluices were found at Bregalnica and Kriva Lakavica. We can conclude that many Macedonian rivers contained gold."

[NOVA MAKEDONIJA] "Are gold-bearing rivers simply a matter of history?"

[IVANOV] "Certainly not. Gold prospecting is a current enterprise. Two years ago a new exploration was begun on the Konjska River. While the findings have not been rich, explorations for gold should be continued on this and other rivers."

The professor considers that it is vitally important to study and verify the quantities of gold found in Macedonian rivers. Only in that manner can it be determined whether production would be economically justifiable. In the same way, determination should be made of the gold that might possibly be obtained as a byproduct of the utilization of other mineral ores.

He stated: "Macedonia is becoming a gold producer from the Bucim copper mine. It will be interesting to determine whether gold can be obtained as a by-product of other ore deposits as they are exploited."

To finish with the thought of Dr Teofilovik, with which Dr Ivanov agrees, as we discover gold-bearing mineral deposits it becomes clear that Macedonian rivers and water basins have a great future in regard to gold.

#### Rare Metals Also Offer Riches

[NOVA MAKEDONIJA] "Specialized volumes that speak of Macedonian mineral wealth often state that this region seems to have been strewn with all possible ores."

[IVANOV] "This thought corresponds to reality. In recent times it has become obvious that we are rich in rare metals. They offer us an important potential.

"In the central part of Macedonia, at the headwaters of the Babuna River, an interesting multimetal deposit has been found. It contains essentially lead, zinc, copper, barium, and uranium. In addition to these elements, it also contains such rare earth elements as rubidium, cesium, and lithium. The quantities are significant.

"As the researcher pointed out, these findings are in a so-called mixed series of crystalline complexes in the Pelagonian range, and there is a broad area for development. In the findings near Nezilovo, rubidium and lithium have been found in nearly all the samples of liscunium analyzed. Cesium was found only in certain forms of liscunium.

"As the researcher pointed out, these findings are in a so-called mixed series of crystalline complexes in the Pelagonian range, and there is a broad area for development. In the findings near Nezilovo, rubidium and lithium have been found in nearly all the samples of liscunium analyzed. Cesium was found only in certain forms of liscunium.

"In the discovery of these rare elements, it was determined that the rubidium and lithium were present in quantities of about 1 percent, while in some lithium samples the cesium amounted to as much as 3 percent."

[NOVA MAKEDONIJA] "At a time when a new page is being written in the history of Macedonian geology and mining, related to these rare metals, what is the significance of these discoveries in practical terms?"

[IVANOV] "These rare elements are extraordinarily important for modern technology. They are involved in the most modern technical developments, and they are invaluable for modern technology."

#### A Discoverer of Unknown Minerals

[NOVA MAKEDONIJA] In his research explorations until the present Professor Ivanov has worked in many Macedonian geological formations. Some of his discoveries are connected with the "nickel-bearing river" of Kozuf. He has also discovered many minerals which were previously unknown in Macedonia, some of which he discovered for the first time.

The names Pelagonia and Ragenite are already recorded in the mineralogical catalogs of the world. The new mineral Pelagonite was discovered at Crn Kamen near Prilep. At Kozuf, near Aslar, the unknown mineral Ragenite was discovered. It was discovered by Professor Ivanov and a group of geologists. About these unknown minerals, he commented:

[IVANOV] "Macedonia's riches in rare metals, new minerals and other geological rarities have a scientific explanation. They confirm that this region is of much interest from a mineralogical point of view."

[NOVA MAKEDONIJA] All of this motivated us to ask Dr Ivanov about the advantages offered by our mineral wealth.

#### Final Resolutions Are Needed

[IVANOV] "I think that we are not yet making proper use of our mineral wealth. In future programs we must devote more efforts to final resolutions, which are more cumulative. We must focus on the larger deposits of metals and on utilization of the rare elements. Concerning utilization of energy resources, I think that we must concentrate on the poorer uranium deposits if they are discovered in extensive amounts. Modern techniques and technology provide the possibility for utilization of so-called poor deposits. In that manner we will be able to overcome one of our geological shortcomings. We have extensive deposits with low concentrations of useful elements, yet those reserves offer us good potential."

[NOVA MAKEDONIJA] This statement ended our interview with Professor Ivanov. At present, in the vicinity of Radovis he is examining strata that contain rare elements. Along with his research interests, however, he is preoccupied with the opening of a new mining and geological faculty in Stip. He believes that new trained personnel will make possible a number of explorations of Macedonia's mineral wealth and open new possibilities for its utilization.