

LOGICA CARNEGIE GROUP

SUMMARY TECHNICAL REPORT

FINAL

March 1997- February 2000

CDRL B001

“CADET Enhancements”

DISTRIBUTION STATEMENT A
Approved for Public Release
Distribution Unlimited

**Commander US Army CECOM
C4IEW Acquisition Center
ATTN: AMSEL-AC-CC-B-CK
Fort Monmouth, NJ 07703-5008**

CONTRACT NO. DAAB07-99-C-K510
(This report includes activities performed under DAAB 07-97-C-D313)

PREPARED BY:
Larry Ground, Project Manager
Alexander Kott, Ph.D., Principal Investigator

LOGICA CARNEGIE GROUP
5 PPG PLACE
PITTSBURGH, PA 15222

20000727 127

DMC QUALITY INSPECTED 4

REPORT DOCUMENTATION PAGE

Form Approved
OMB No. 0704-0188

Public reporting burden for this collection of information is estimated to average 1 hour per response, including the time for reviewing instructions, searching existing data sources, gathering and maintaining the data needed, and completing and reviewing the collection of information. Send comments regarding this burden estimate or any other aspect of this collection of information, including suggestions for reducing this burden, to Washington Headquarters Services, Directorate for Information Operations and Reports, 1215 Jefferson Davis Highway, Suite 1204, Arlington, VA 22202-4302, and to the Office of Management and Budget, Paperwork Reduction Project (0704-0188), Washington, DC 20503.

1. AGENCY USE ONLY (Leave blank) 2. REPORT DATE 27 March 2000 3. REPORT TYPE AND DATES COVERED Final Technical Report, March 1997 - February 2000

4. TITLE AND SUBTITLE
Course of Action Display and Evaluation Tool (CADET) Enhancements
Summary Technical Report, Final, March 1997 - February 2000

5. FUNDING NUMBERS
DAAB07-97-C-D313
DAAB07-99-C-K510

6. AUTHOR(S)
Larry Ground
Alex Kott, Ph.D., Principal Investigator

7. PERFORMING ORGANIZATION NAME(S) AND ADDRESS(ES)
Logica Carnegie Group
5 PPG Place
Pittsburgh, PA 15222

8. PERFORMING ORGANIZATION REPORT NUMBER

9. SPONSORING / MONITORING AGENCY NAME(S) AND ADDRESS(ES)
Commander, US Army CECOM
ATTN: AMSEL-ACCA-D-AX
Fort Monmouth, NJ 07703-5008

10. SPONSORING / MONITORING AGENCY REPORT NUMBER

11. SUPPLEMENTARY NOTES

12a. DISTRIBUTION / AVAILABILITY STATEMENT
Unclassified, Unlimited

12b. DISTRIBUTION CODE

13. ABSTRACT (Maximum 200 words)

Course of Action Display and Evaluation Tool - CADET assists military planners in translating an initial maneuver course of action (COA) into a detailed COA and wargaming it to determine feasibility.

Begun as a Small Business Innovative Research (SBIR) project in 1996, CADET moved on to Phase II under CECOM contract # DAAB 07-97-C-D313. With the completion of the Phase II effort in early 1999, CECOM extended development along the same lines with the award of contract # DAAB 07-99-C-K510.

During the three years covered by this report CADET has evolved from a proof of concept into a working software program that can accept an initial COA from Battlefield Planning and Visualization-Windows (BPVWin). Working with the planner in a series of interleaved user/computer actions, the system details, resources, schedules, elaborates, and analyzes the COA. The results can be exported to a spreadsheet and also transferred seamlessly into BPVWin for animation, providing a useful view of the interaction of friendly and enemy units in a map-based, time and event driven scenario.

CADET provides a highly interactive planning environment where the machine handles the science of war, freeing the human to focus his or her brainpower on the art of war.

14. SUBJECT TERMS
Decision Support, Course of Action Analysis, Interactive Knowledge Base, Object Oriented, Planning and Evaluation Algorithms, Visualization, User-Centered Design, Wargaming

15. NUMBER OF PAGES
292

16. PRICE CODE

17. SECURITY CLASSIFICATION OF REPORT
UNCLASS

18. SECURITY CLASSIFICATION OF THIS PAGE
UNCLASS

19. SECURITY CLASSIFICATION OF ABSTRACT
UNCLASS

20. LIMITATION OF ABSTRACT
UNLIMITED

REPORT DOCUMENTATION PAGE (SF 298)

ABSTRACT

Course of Action Display and Evaluation Tool - CADET assists military planners in translating an initial maneuver course of action (COA) into a detailed COA and wargaming it to determine feasibility.

Begun as a Small Business Innovative Research (SBIR) project in 1996, CADET moved on to Phase II under CECOM contract # DAAB 07-97-C-D313. With the completion of the Phase II effort in early 1999, CECOM extended development along the same lines with the award of contract # DAAB 07-99-C-K510.

During the three years covered by this report CADET has evolved from a proof of concept into a working software program that can accept an initial COA from Battlefield Planning and Visualization-Windows (BPVWin). Working with the planner in a series of interleaved user/computer actions, the system details, resources, schedules, elaborates, and analyzes the COA. The results can be exported to a spreadsheet and also transferred seamlessly into BPVWin for animation, providing a useful view of the interaction of friendly and enemy units in a map-based, time and event driven scenario.

CADET provides a highly interactive planning environment where the machine handles the science of war, freeing the human to focus his or her brainpower on the art of war.

TABLE OF CONTENTS

REPORT DOCUMENTATION PAGE (SF 298).....	ii
ABSTRACT	iii
TABLE OF CONTENTS.....	iv
LIST OF FIGURES AND TABLES.....	v
PREFACE.....	vi
EXECUTIVE SUMMARY	vii
INTRODUCTION	1
1. SUBJECT.....	1
2. PURPOSE.....	1
3. SCOPE.....	2
4. PLAN.....	2
METHODS, ASSUMPTIONS and PROCEDURES	3
1. CADET's Mission	3
2. CADET's Functions	4
3. Ultimate Vision.....	4
SYNOPSIS OF DEVELOPMENT EFFORTS	6
Scenario Development.....	6
Activity Modeling.....	7
Algorithm Design and Implementation	10
Scenarios.....	11
In-Process Reviews.....	12
Demonstrations.....	12
Hardware/Software.....	13
Y2K	13
RESULTS AND DISCUSSION	13
Building a New Plan from Scratch	14
Reconstitution	17
Forward Displacement of Brigade Support Area (BSA)	19
Regeneration	19
Emergency Evacuation of a Brigade Support Area (BSA).....	21
Ammunition modeling at DODIC Level	23
Movement To Contact	24
Automated Modeling of Actions/Counter-actions on Contact	24
Modeling of Unit Displacement to Provide Continuous Support	24
Modeling of Obstacle Breaching Operations.....	25
Modeling Attrition of Personnel and Weapons Systems	26
RECOMMENDATIONS	27
Assessment of current state.....	28
Eventual location of CADET as an application or tool	28
Strengths of CADET's approach.....	28
Approaches to transitioning CADET to operational use	29
The development team's list of ideas for CADET's evolution.....	29
Summary.....	31
REFERENCES	31
LIST OF SYMBOLS, ABBREVIATIONS AND ACRONYMS	32
GLOSSARY	35
DISTRIBUTION LIST	38
Appendix 1. Operations Plan used to drive Development Scenario	
Appendix 2. Division OPORD used for Scenario Development	
Appendix 3. Scenario # 1 - Conventional Warfare	

- Appendix 4. Scheme Of Maneuver Time Line Computations
- Appendix 5. Scenario #2 - Force XXI
- Appendix 6. Scheme Of Maneuver Time Line Computations
- Appendix 7. Friendly Order of Battle
- Appendix 8. Enemy Order of Battle
- Appendix 9. Mission Analysis
- Appendix 10. Wargame Narrative without CADET - Deep Battle
- Appendix 11. Wargame Narrative without CADET - Main Battle
- Appendix 12. Wargame Narrative without CADET - Rear Battle
- Appendix 13. Synchronization Matrix developed in Wargame without CADET
- Appendix 14. Course of Action Sketch
- Appendix 15. Activity Model for 52d Division offensive operations
- Appendix 16. Mapping of Activities to Objects
- Appendix 17. Activity Modeling Sheet - Deep Attack by Army Aviation
- Appendix 18. Modeling for Air Operations Planning.
- Appendix 19. Activity model for Movement to Contact
- Appendix 20. Cadet Functional mapping: Obstacle Breaching
- Appendix 21. CADET functional mapping: Defense
- Appendix 22. Activity Modeling Sheet - Re-supply Operations within a Brigade
- Appendix 23. Activity Modeling Sheet - Emergency Evacuation of Logistics Facilities
- Appendix 24. Activity Modeling Sheet - Regeneration
- Appendix 25. Design Note - Route Selection
- Appendix 26. Design Note - Calculating attrition in ground advance
- Appendix 27. Knowledge Base Specification for Generic Advance Activity
- Appendix 28. Movement to Contact Design
- Appendix 29. Estimation of Battlefield Attrition in a Course of Action Analysis Decision Support System
- Appendix 30. Object Diagrams, Loops and Logic
- Appendix 31. Under the Hood

LIST OF FIGURES AND TABLES

Figure 1: CADET will provide decision support to the analysis step of the DDMP	3
Figure 2: CADET will operate as a COA analysis component of a Battlespace C2 System	5
Figure 3. Objective drawn into BPVWin as a control measure	15
Figure 4. BPVWin Unit Editor window	15
Figure 5. Drawing unit routes into BPVWin	16
Figure 6. When saving the scenario in BPVWin .sca must be used for the file extension.	16
Figure 7. The Collaboration Session must be entered exactly as <i>Cadet</i>	17
Figure 8. The editor window for a new Attack activity	17
Figure 9. Supply Platoons (LOGPACs) travel between BSA and unit	18
Figure 10. BSA moves, DISCOM re-directs deliveries to new location	19
Figure 11. CADET warns initially of significant losses in weapons systems.....	20
Figure 12. CADET recommends a regeneration, but the user can choose not to	20
Figure 13. CADET <i>highly recommends</i> regeneration.....	20
Figure 14. The Unit Editor window has a button to Browse to the Unit Equipment editor	21
Figure 15. For Unit Equipment, CADET focuses on fuel, ammo and number of weapons systems.....	22
Figure 16. The Vehicle Information List window	22
Figure 17. The user can adjust the combat load for each type of vehicle, by unit.....	23
Figure 18. Selected ammunition types are modeled at the DODIC level	23
Figure 19. Ammunition consumption by number of rounds	24
Figure 20. Sensor teams leapfrog for continuous coverage	25
Figure 21. The supporting attack proceeds and occupies Object A.....	26
Figure 22. Combat Calculator.....	27

PREFACE

CADET is the most advanced military course of action (COA) analysis tool currently under development. It continues to evolve from the proof of concept demonstrated under the Small Business Innovative Research (SBIR) program. This project extended the basic research begun in Phase II of the SBIR to further enhance the basic capabilities with the intent of transitioning CADET to a developmental program in the near future. Some areas where CADET demonstrates a superior approach:

- CADET approaches the problem in the same manner as a human planning team would do, focusing initially on the most critical events in the COA and wargaming them in detail first, similar to the "box" technique of wargaming.
- CADET uses "rules of thumb" for planning in the same manner as human planners. The use of a flexible object model representation allows CADET to "see" the activities in the same manner as the human planners. This facilitates interaction with the human planner by making it easier for the planner to see the reasoning behind each step in the process.
- CADET employs a "thinking enemy." The enemy's actions are neither scripted nor pre-determined by a member of the planning staff. Through the use of an object-oriented model, the enemy can be represented with its own set of actions, goals and intents.
- CADET plans throughout the entire battlespace, across time and distance, to determine the impact of events in the deep, rear and close battle on the commander's intent. Unlike a simulation which might examine events only as they occur, CADET can reason ahead, identifying potential actions in the deep battle which could reduce the size of enemy forces to be faced in the close fight.
- CADET is based on a flexible activity model. The object-oriented nature of the model makes it easy to expand, flexible to reason against, and simple to share with other object-oriented planning and execution tools.

The authors wish to acknowledge the tremendous efforts of Jonathan Sewall, the Technical Lead for this project through most of its lifetime. For much of the second phase, Jonathan was the only software engineer assigned full-time to the project. His ability to drive the development forward with minimal assistance was a major factor behind the exceptional success of this project.

The authors also wish to acknowledge the contributions of the rest of the development team, particularly Raymond Budd, who cut his teeth as a new engineer on this project. Others we wish to acknowledge include John Langston, formerly with EER Systems, Inc., and Major General (retired) Bruce Moore. Their contributions to our understanding of the functional domain helped us achieve a high level of acceptance within the user community and for that we are very grateful.

Notice: Logica Carnegie Group was formed in November, 1998 by the merger of Logica North America with Carnegie Group, Inc.

CADET

Course Of Action Display and Evaluation Tool

EXECUTIVE SUMMARY

CADET approaches the "wargaming" phase of the MDMP in much the **same manner as a human planner** would. It looks across the entire range of the plan and assesses each activity for its interaction with other actions and its resource requirements. Unlike a dispatch-driven simulation that assesses each event, records the results and goes on to the next event, CADET looks at every activity in the plan to determine which activities are most critical to success and plans accordingly.

CADET employs **an intelligent approach to wargaming actions**, looking to see how each action affects the friendly force and the enemy force. Similarly, the enemy units are intelligent actors, working to achieve their assigned tasks. **Actions, reactions and counter-actions are independently determined** for each unit in an event-driven approach.

A typical event in CADET is the "Unit advance." For the unit conducting the advance, whether a friendly or enemy force, CADET automatically chooses the best routing, calculates the resources required, checks their availability, and then looks to see if opposition forces will be encountered. If opposition forces are within range, CADET checks the unit's by-pass criteria. Assuming it is too large to by-pass, the unit will attack with corresponding adjustments in speed and consumption rates. The attrition algorithm in CADET calculates the losses in weapons systems and personnel based on a variety of factors including the relative strength and disposition of the forces. All of this is automatic and transparent to the user for the most part until CADET flashes a message to identify shortfalls in resources caused by combat losses.

CADET needs very little to get started. It begins after the user has developed a rough COA in the COA Development phase of the MDMP. Combining the primary tasks of the rough COA with some basic information on the enemy and the battlefield, CADET begins the expansion of the primary tasks into the underlying tasks and supporting tasks. With each expansion it calculates the resources required for that task and determines their availability. Throughout the expansion, CADET is scheduling and sequencing the tasks, with respect to their hierarchy and importance. The results are shown on the computer screen in a standard synchronization matrix designed around the battlefield operating systems (BOS). Graphs are included for detailed analysis of resource consumption across time. For "quick and dirty" analysis, a snapshot window appears on the right end of each activity in the synchronization matrix. Divided into four quadrants, it provides the user with a quick overview of resource consumption for fuel, ammunition, personnel and weapons systems.

The results from CADET can be **exported to a Microsoft Excel spreadsheet**, retaining the form, content and appearance exactly as they appear on the CADET screen. The results can also be exported to BPVWin for animation. In BPVWin, the user can see the units moving along their assigned routes, interacting with other units. The timing of the relative events becomes clear as the user sees the units move through the activities. The movement of units in an unopposed advance is dramatically different from the speed of the opposed advance as enemy forces are encountered. Users seeing the display for the first time learn quickly that movement on the ground is impacted by a lot of factors and may not match preconceived notions.

CADET currently models over 60 activities in detail. It addresses some of the most challenging aspects of military planning, including Deep Attack, Movement To Contact (MTC), Passage of Lines,

Obstacle Breaching, and Emergency Evacuation of Logistics Facilities. Additional activities can be modeled by anyone having knowledge of Java that wishes to build the attributes and methods associated with an object. The development team explored the possibility of building an interface for users to be able to create their own objects on the fly. This was deemed infeasible at this time due to the ease with which one could generate mutually exclusive activities. It would be extremely difficult to create a set of rules to govern creation of objects that would make it possible to check the new objects for feasibility.

Each entry in the synchronization matrix represents an object within the object-oriented representation. Users can "drill down" on each object and link across objects to follow the relationship across units or across events or across resources. As it expands each task, CADET populates each object by performing the calculations, the "number crunching", of the planning. Where distances have to be traveled, CADET figures out how long the travel will take, based on the road type, distance, travel speed and opposition encountered. How much fuel will be consumed? What obstacles will be encountered?

CADET can be set to perform the entire expansion at one time, going from a start point of 6-8 major activities to a fully expanded synchronization matrix with 300-plus tasks. In practice, this has proven to 1) overwhelm the user with data and 2) result in the user not "buying in" to the solution. It generally works better for CADET to expand about 10 activities at a time and let the user assess those before proceeding. The latter approach has resulted in users commenting that "It follows a logical pattern" as they follow the pattern of the expansions.

Users have identified three major areas of potential application for the system.

- The first application is in the number-crunching of planning. In this instance, the user is fully qualified to perform the planning, but wants to delegate the calculations and resource planning and checking to the system. The user and other staff members need to focus on the art of the wargaming process without getting bogged down in the determination of how many gallons of fuel it takes to get point A to point B.
- The second application is as a "checklist." During a period when the user is tired and unable to focus his or her full faculties on the problem, CADET serves as another pair of eyes, making sure the doctrinal "rules" are not violated inadvertently. If the user chooses to overrule the doctrinal "rules" either because the rule doesn't fit or because the user intends to operate "outside the box," CADET helps identify the impact without judging the plan.
- The third application involves the introduction of new persons to the planning process. Most planning at the brigade level is performed by captains and junior majors with limited staff planning experience. A tool to help them identify doctrinal constraints and guide them through attrition estimating would be helpful. Without "grading the COA," it could help identify areas for further examination.

To fully achieve its potential, CADET needs to be expanded to include most of the activities a planner would expect to encounter. The interfaces need to be coordinated with real soldiers and enhanced to improve user acceptance of the system. Finally, the system needs to be tested in a realistic environment to determine how well it improves over the manual wargaming process and to focus the future development.

CADET

Course Of Action Display and Evaluation Tool

INTRODUCTION

1. SUBJECT.

Course Of Action Display and Evaluation Tool - CADET assists military planners in translating an initial maneuver course of action (COA) into a detailed COA and wargames the COA to determine if it is feasible.

- CADET is designed to help the planner expand and flesh out a rough COA by providing a very detailed knowledge base of doctrinal information that is easily accessed through the Graphic User Interface (GUI). As the planner lays down his intended scheme of maneuver, CADET tracks resource utilization automatically and wargames the actions to advise the planner on the feasibility of his COA. The knowledge base is based on doctrinal rates derived from Subject Matter Experts (SME), unit historical data and official Army sources, but gives the user the opportunity to over-ride the default values when better information is available.
- CADET is tying in very closely with Battlefield Planning and Visualization -Windows (BPVWin) as the visualization tool to actually show units moving across the battlespace in time and distance. CADET is taking maximum advantage of off-the-shelf software development tools to speed the development process and focus on the underlying challenges of the problem. This capability has been displayed at each of the In-Process Reviews (IPR).
- CADET provides a very quick analysis of the COA as it expands the tasks, determines the resources required to meet the commander's intent across the entire timeline, wargames against the OPFOR and advises the planner when the COA appears to be infeasible. This all takes place within a 30-minute time frame from beginning to end. CADET is not intended to replace a more detailed simulation such as Eagle, which would be used to further evaluate a COA if time permits.
- CADET has been given a very narrow focus to give it a greater chance of success. It is intended that the rough COA be provided by another source, such as BPVWin or FOX GA. The Intelligence Situation Template (SITTEMP) must also come from another source to show the enemy situation and COA.
- CADET will provide, as output, information in the appropriate format to feed a tactical simulation, which can then be used to run a number of iterations, if time permits, to determine a range of values for the feasibility of the COA.

2. PURPOSE.

This report documents the conclusion of three years of sustained development. Beginning in March, 1997 with the second phase of the Small Business Innovative Research (SBIR) project, the development was extended in 1999 for an additional year to incorporate more functionality. During this period the development team has achieved the objectives set forth in the statement of work in every regard, with the

exception of creating the ability to store the plan. The latter was removed from the list of requirements by the Contracting Officer's Technical Representative (COTR). This occurred after a detailed review when it was determined that building a separate storage capability for CADET alone was duplicative of plans for storage in the Maneuver Control System (MCS) development effort and those in the Battlefield Planning and Visualization (BPV) program.

3. SCOPE.

This report focuses on the technical aspects of the software development with discussion of the functional requirements as they relate to the development cycle. The report is intended for a general audience having a background in Decision Support Systems (DSS) and Command and Control Systems (C2).

- This report is intended to serve as a stand-alone report, separate from all previous technical reports and will, as a consequence, repeat information from the interim technical reports where it is necessary to provide continuity and clarity in understanding.
- Information from previous reports not critical to understanding this report will not be repeated.
- Copies of previous reports may be obtained upon request from the COTR at CECOM.

4. PLAN.

Research and development in software development is generally not a linear process. One studies the problem, talks to the "experts" (if such can be found), and attempts to implement what they have described. There might or might not be published documentation specifying exactly how the system should work with the developing software in place. In the instance of CADET, the development team has been fortunate to deal with some forward thinking program managers within the military who are willing to "think outside the box" and look at what "could be."

This development comes at a challenging point in the Army's evolution as it stands on the brink of the digital revolution. The visions for the future espoused by the Army's leadership repeatedly call for revolutionary changes in the area of command and control for tactical forces, fueled by tremendous strides forward in the automation of the command and control process. It takes a person of great vision and capability to "see" the future, imagine "what could be" and lay out a process to get there.

Many of the officers that were exposed to CADET expressed a belief in its potential as a stepping stone to the digitized planning and execution tools of the future. This notion has been reinforced by the attention CADET has garnered from the Command Post of the Future (CPOF) and from two areas of the TRADOC Concept Experimentation Program (CEP).

- CPOF is a DARPA program designed to create tools for the command and control processes of the near future with focus on "the last 18 inches," the distance between the computer screen and the soldier's brain. DARPA recognized value in CADET as a COA evaluation tool and provided two years of funding for the integration of CADET into CPOF.
- Integrated Course of Action Critiquing and Elaboration System (ICCES) - The Battle Command Battle Laboratory - Leavenworth (BCBL-L) included CADET as a part of this TRADOC CEP, to integrate CADET with the High Performance Knowledge Base (HPKB), another DARPA project.
- CADET- ASAS - ASAS is the All Source Analysis System, the intelligence component of the Army Tactical Command and Control System (ATCCS). Battle Command Battle Laboratory - Huachuca (BCBL-H) included CADET as a part of this project under the TRADOC CEP. This effort will integrate CADET with ASAS to produce an enhancement to the Intelligence, Surveillance and Reconnaissance (ISR) program.

METHODS, ASSUMPTIONS and PROCEDURES

1. CADET's Mission

In order to accomplish a mission, a commander and his or her staff must generate and carry out a course of action, the plan or scheme that will accomplish a predefined mission or goal such as bridging a river or taking a hill. Generating a COA is a resource intensive task. To minimize the effort required and to improve the quality, we have developed CADET (*Course of Action Display and Evaluation Tool*), a wargaming modeling and analysis Decision Support System (DSS), focusing on critical events in the development of a course of action. CADET is a decision support aid for COA analysis which provides commanders with fast, flexible interaction to significantly improve the detailed development, wargaming, and assessment of alternative maneuver courses of action while requiring modest computational power for wargaming simulations.

This ability to provide intelligent decision support to planning staff in the analysis step of the COA planning process will enable revolutionary improvements in speed and accuracy of the process.

Shortfalls and Needs Identified in the Manual COA Development and Analysis Processes

Course of action development and analysis are integral to the overall staff decision-making process, whether at battalion, brigade, or division level. As shown in Figure 1, COA development is preceded by a series of steps, including terrain and threat analysis, arraying friendly and threat forces, and force ratio analysis.

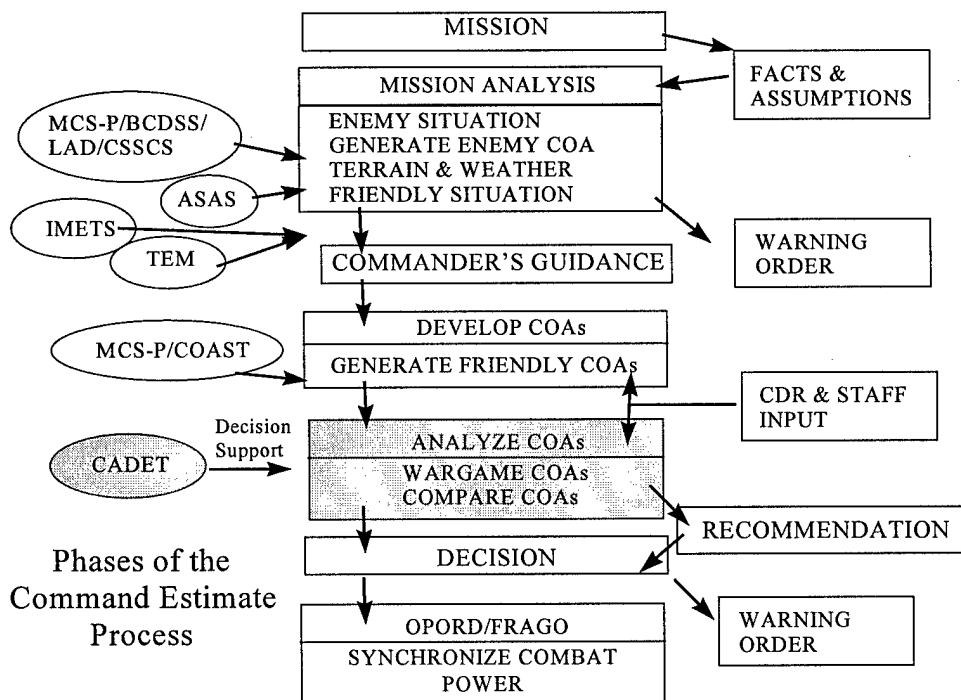

Figure 1: CADET will provide decision support to the analysis step of the deliberate decision-making process (DDMP) — a critical step for which in-depth intelligent computer-based aids are not yet available.

COA analysis includes defining battle phasing and synchronization matrix preparation, defining action/reaction/counteraction sequences, risk analysis, and comparing across the developed and assessed COAs.

The current decision-making process is not without shortfalls. Many aspects of the process could be improved with the appropriate addition of automation components:

- The process is time- and human-intensive, which limits the scope and depth of analysis.
- Attrition, force combat power, and movement and consumption rates calculations are more subjective than desirable.
- The process relies too heavily on the intuitive judgment and individual personalities of the commander and his staff.
- The process is difficult — and subjective at best — for the staff to gauge the impact of combat multipliers and operational and environmental factors.
- The process requires the use of planning factors based on historical data. The sources and data used for these calculations are often outdated and do not match the situation as presented in the COA.

2. CADET's Functions

CADET provides these functions:

- Support actions planning: given an initial or partial concept of a COA, CADET will suggest to the staff additional necessary actions and possible reactions.
- Support actions scheduling: CADET will recommend assignment of the tasks to the most suitable and available assets; suggest timing and synchronization.
- Support feasibility assessment: CADET will continuously review the state of the COA to detect actions that violate feasibility constraints or actions that are inconsistent with each other.
- Support outcome evaluation: CADET will continuously update estimations of attrition, consumption, and risks.

3. Ultimate Vision

CADET will provide a revolutionary capability of continuous, rapid, real-time replanning within the battle execution cycle. This can be achieved in future development based on the strong foundation in this effort for adding this capability.

CADET will function as a team member of the divisional planning cell providing doctrinally correct knowledge related to COA analysis, continuously examining the current state of partially completed COA, offering warnings regarding deficiencies within the COA, and offering extensions and details to the COA (Figure 2). It cannot be overemphasized that the human planners (users of CADET) will retain full control over the process. Ultimately, CADET will be a component of the Battlespace Command and Control (BC2) environment.

Capabilities of CADET will contribute primarily to the analysis step of the current manual planning process (Figure 2). It is likely that the process will change with the introduction of a capable planning

decision support aid such as CADET. Truly revolutionary decision support aids can and often do dramatically influence the decision process, eliminating and combining some steps and drastically speeding up others. It is too early to predict how tools such as CADET specifically will change the COA planning process. One possible change is the merger of COA development and COA analysis steps into one unified process.

More specifically, CADET will provide the following capabilities (Figure 2):

- Plan COA with a rapid semi-automatic, interactive knowledge-base; construct activity models (networks of interdependent actions) for a set of key tasks and objectives specified by the human planners; identify missing or inconsistent tasks.
- Allocate and schedule resources (assets for the COA activities) in an optimized and doctrinally correct manner; find tasking and timing solutions that avoid over-extension or under-utilization of assets.

Discussion of Targeted Capabilities

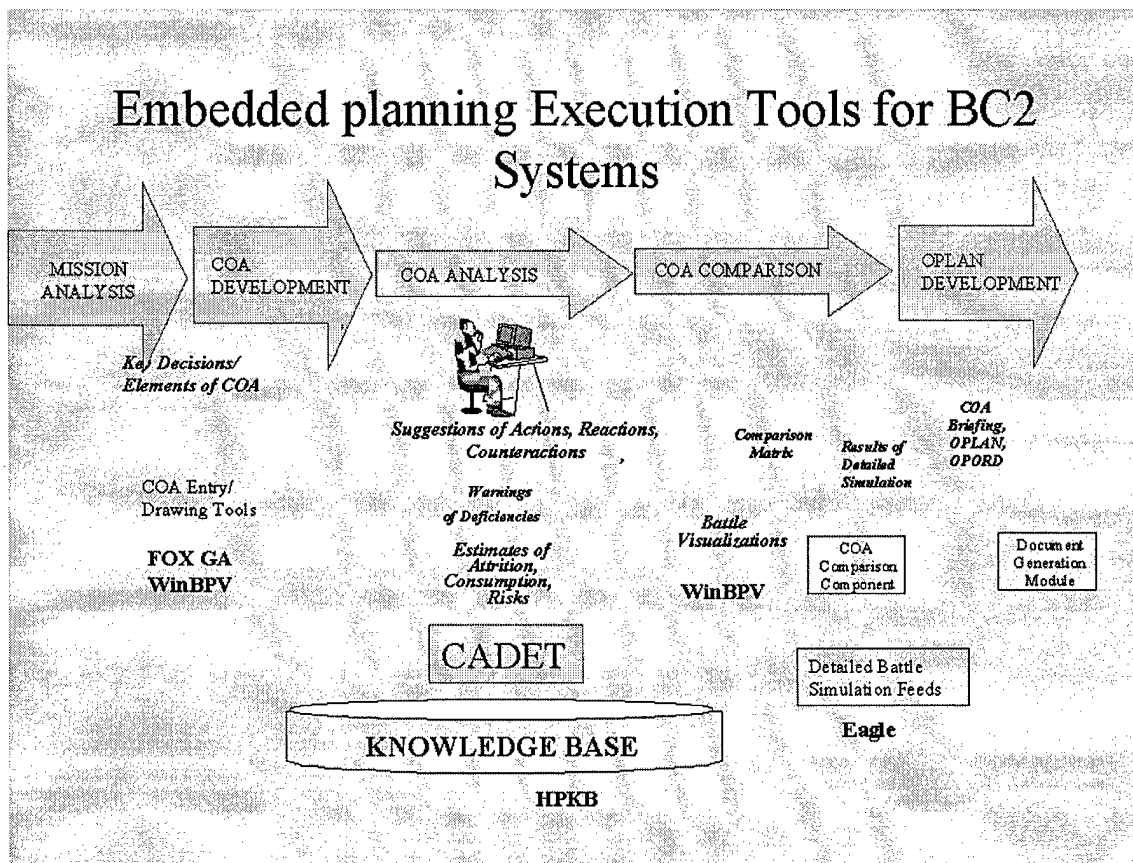

Figure 2: CADET will operate as a COA analysis component of a Battlespace Command and Control (BC2) System. This figure shows CADET's interactions with end users as a component of the planning and execution process.

- Perform feasibility and completeness checking on a partial or complete COA; apply a rich collection of procedures and rules (knowledge base) to examine actions and reactions

individually and in relation to each other; employ doctrine and recommendations of experienced tacticians.

- Support visualization of a sequence of activities for the COA via integration with BPV (Battle Planning and Visualization System).
- Integrate with other tools for COA authoring and document generation (Figure 2), particularly exchanging COA-related information with existing tools for creating the laydown of forces as well as for creating OPLANs, OPORDs, DST, COA briefings, etc.
- Integrate with tools for COA comparison; automatically prepare and provide information regarding estimated COA risks, attrition, etc. to these tools.
- Support multiple users (members of the planning cell) in a concurrent planning session; provide customized interface and information presentation to the members with different roles and needs.
- Provide planning support in multiple modes: fully interactive, fully automated, and mixed-initiative; maintain the ability of the human members of the overall human-computer team to remain in control at all times.
- Provide full, continuous real-time replanning capabilities during the execution of the operation in response to ground-truth events; support not only the deliberate decision-making process (DDMP) but also the combat decision-making process (CDMP).

SYNOPSIS OF DEVELOPMENT EFFORTS

Scenario Development

Test Case. A key ingredient to building a robust, flexible Decision Support System (DSS) is having a challenging test case against which to test functionality. John Langston, EER Systems, Inc., and MG (retired) Bruce Moore were instrumental in the development of the scenario, which guided the early development. To fully understand the operating environment, the scenario needed a full set of artifacts, similar to those used by human planners under realistic conditions. The scenario itself is that of a division planning staff, the 52d Mechanized Infantry Division, conducting offensive operations at the National Training Center (NTC) at Fort Irwin, CA.

- An operations plan (OPLAN) was developed to provide the guidance from higher level headquarters. Attached at Appendix 1 is OPLAN 6099 (MAILED FIST) -- X (US) CORPS, the OPLAN written by the corps staff with directives to the 52d Division.
- An operations order (OPORD) was derived from the OPLAN, using standard manual planning procedures to provide a baseline against which to compare the CADET products. Attached at Appendix 2 is 52d Mechanized Infantry Division OPORD 9X-06-01.
- Appendix 3 shows a possible scenario derived from the Corps OPLAN, using current doctrine and tactics.
- Appendix 4 shows the scheme of maneuver calculations performed by hand to support the current doctrine scenario in Appendix 3. It should be noted that it took a subject matter expert (SME) at least 6 hours to perform these calculations by hand and double-check them for accuracy.

- Appendix 5 shows a different scenario derived from the same planning guidance, but using the Force XXI doctrine to guide the tactical planning. It should be noted that this was developed in early 1997 when Force XXI doctrine was still in a high level of flux.
- Appendix 6 shows the scheme of maneuver calculations performed by hand to support the Force XXI doctrine scenario in Appendix 5. To perform the calculations, the SME made some assumptions about the movement rates in both unopposed and opposed situations. With the manual calculations, it's difficult to perform any "what if" analysis by adjusting the movement rates.
- The friendly order of battle is shown in Appendix 7.
- The enemy order of battle is shown in Appendix 8.
- The SME performed the standard mission analysis to determine the specified and implied tasks and develop a re-stated mission. This is attached at Appendix 9.
- A group of subject matter experts (SME) formed a battle staff and performed a wargame analysis on the COA, following traditional procedures.
 - The narrative for the deep battle portion of their wargame is attached at Appendix 10.
 - The narrative for the main battle portion of their wargame is attached at Appendix 11.
 - The narrative for the rear battle portion of their wargame is attached at Appendix 12.
 - The synchronization matrix developed in their wargame is attached at Appendix 13.
 - The COA sketch associated with their COA is attached at Appendix 14.

Activity Modeling

A big portion of the development has been devoted to obtaining a working understanding of the many activities in the military tactical domain. Our studies began with the basic activities needed to drive the test case scenario. Over time we expanded our activity set to the current list of over 60 different activities. Most of them correlate directly to tactical tasks while some are unique to the needs of a computer model.

The activities modeled in CADET are shown in Table 1 below.

Table 1 Activities modeled in CADET

AdvanceOnAxis	AirDefenseChangeMode
AirMovement	ArtyFire
AssessDamage	AssessEnemy
AssessObstacle	AssumeNewMission
BeingPassed	BreachObstacle
Bypass	BypassObstacle
CoverArea	CrossLine
CrossRiver	DeepAttack
Defend	DevelopSituation
Employ	Engage
EvaluateOutcome	FindEnemy

FindFlank	FireSmoke
HoldEnemy	ImproveRoute
IsolateEnemy	MaintainContact
ManeuverToFlank	Move
MovementToContact	MovementToContactTM
MoveThroughPP	OpposedAdvance
OrganizeForCombat	ForwardPassageOfLines
Position	Reconnaissance
Recover	ReduceObstacle
Rehearsal	ReorderTroops
Reorganization	Resupply
RouteRecon	Screen
Seize	SeizeMilestone
SupportForwardUnit	SupportPassageOfLines
SustainmentSelf	SustainmentSupport
TacticalMarch	TransitionToHastyAttack
Uncoil	UnopposedAdvance
UpdateEnemySituation	

For each activity, we worked closely with the SMEs to develop a comprehensive picture of how the activity takes place and the planning considerations involved.

- Appendix 15 shows a full activity model for the Test Case scenario with the questions and answers addressed between the development team and the functional experts. It is included in this report as being indicative of the exchange of information that facilitated our understanding of the domain. In later modeling, as we became more comfortable with the process, much of this information exchange was handled over the phone.
- Appendix 16 is the initial draft of the modeling of activities to objects. Here the developers are attempting to determine which attributes in the object will map to the activity model developed in Appendix 15 above. This, too, is a preliminary working document, which served as a stepping stone to the final modeling.
- Appendix 17 shows a much more complex activity, deep attack by army aviation. Shown here is a breakout of the sub tasks, as developed by the SMEs. Following that is the detailed question and answer in-depth analysis of each sub-task. The analysis includes the inter-relation of tasks to determine dependencies and hierarchy. Following this are some notes from the developers on possible ways to model the activity.
- In Appendix 18, we show the detailed developer's notes on the proposed approach to the same activity. Note in particular the detail for calculating fuel consumption, the expected workload for the Forward Arming and Refueling Point (FARP) and the time calculations for the travel to and from the Engagement Area (EA). Modeling the activity at this level of detail, and tying the calculations to the terrain rather than using default "rules of thumb" gives CADET the ability to calculate for any terrain or distance. If the travel speeds are increased as new doctrine is introduced by Force XXI, the values can be easily changed in the object screen through the Graphic User Interface (GUI). The underlying code does not have to be changed.

- Appendix 19 shows the activity model for a Movement to Contact. This activity presented a number of new challenges.
 - The whole intent of a movement to contact is to locate the enemy under conditions of uncertainty. We developed algorithms that allow friendly forces to advance, and then take appropriate action upon encountering an enemy, depending on the relative size and strength of the enemy force.
 - Many of the supporting elements can not operate while moving or operate at a diminished capacity. Consequently, the planner must decide whether to leapfrog the assets forward to provide continuous coverage or to move with the assets in the march column and accept the reduced operational capacity.
 - In cases where a force is encountered which needs to be attacked and destroyed (as opposed to bypassing), we needed an algorithm to plan the immediate action for the unit which maintains contact with the enemy while the striking force maneuvers to a vulnerable flank.
- Appendix 20 shows the detailed information provided by the SMEs for obstacle breaching. This is one of the most complex activities and one which has the ability to ruin a tactical plan if not conducted properly.
- Similarly, Appendix 21 shows detailed information for planning a defensive operation. This is a good example of the level of detail provided to the development team by the functional experts on various activities.
- Appendix 22 contains the detailed information on modeling re-supply operations within a brigade. This was particularly challenging because the Heavy Expanded Mobility Tactical Trucks (HEMTT) used for re-supply at the brigade level are slower than tanks and Bradley Fighting Vehicles (BFV). With tracked vehicles needing re-supply approximately every 8 hours, the distance between the combat trains and the Brigade Support Area (BSA) became a limiting factor in many scenarios. Another interesting aspect was the need to "look ahead" for the refueling operations. If we followed a simulation style planning method where each event was addressed only it came to the system's attention, it caused units to run out of fuel during the most critical parts of the conflict. By employing "look ahead," CADET determines how much fuel is needed across the foreseeable planning horizon and schedules the re-supply activity at the time most convenient to the commander.
- Appendix 23 has detailed information on emergency evacuation of logistics facilities. For this activity, it was necessary to determine what the triggering events would be to cause an evacuation. Once the activity was successfully modeled, it produced very interesting depictions of the ripple effects of this event on the supported customers and the supporting higher echelons.
- Appendix 24 has the detailed information on regeneration. This turned out to be an extension of the existing capability to perform re-arming and re-fueling immediately after each battle. The significant difference is the requirement for additional external resources to perform the regeneration and the absolute requirement to remove the unit undergoing regeneration from the fight. The time required to extract the unit from the fight, move it beyond the range of indirect artillery fire, and perform the regeneration makes it impossible to return the unit to the fight quickly. The decision to pull a unit off the line to undergo regeneration should not be made lightly. CADET will help compare the impact of retaining the unit's services for the short term versus the long-term impact on the unit and its personnel.

Algorithm Design and Implementation

The exploration of the functional environment set the stage for design and implementation of the algorithms. The following appendices contain developers' notes on algorithm design and implementation. These notes are aimed at system developers but an effort has been made to make them understandable by potential end users to the maximum extent possible. These notes are presented here as a good example of the early design rationale. Actual implementation of the code was guided by these considerations but *may differ in details*. You should consult the Javadoc Design Documentation for the most current implementation.

- Appendix 25 addresses Route Selection. We formulate the process as a shortest-path problem and employ Dijkstra's algorithm to solve the problem. This section explains how the planning factors for the Avenues of Approach (AA) are applied to the selection of the best routing, including the use of weighting for the various factors. It uses a series of diagrams related to the Test Case scenario to demonstrate how the routing decisions are made.
- Appendix 26 addresses attrition.
 - In current practice, staff planners generally estimate attrition for both friendly and enemy forces using basic rules of thumb.
 - The faculty of the Command and General Staff College (CGSC) teaches students that estimates of attrition are generally inaccurate and have relevance only in comparing one COA to another. They offer the tables in the *G-3 Battle Book* for reference but also caution against placing too much stock in their accuracy.
 - Most officers in the field would like to be able to estimate losses in the same manner as that used by the Corps Battle Simulation (CBS). However, CBS mentors point out that their system is designed to teach command and control procedures and consequently the attrition is not necessarily 100% accurate. They also advise CBS is adopting a new procedure that estimates the probability of hit (PH) and probability of kill (PK) for every engagement. This would take too long for CADET's purposes, based on the availability of adequate computing power.
 - For our purposes, we needed a fast, reliable form of calculating attrition to produce an answer that was "acceptable" to the user. The number had to meet the user's expectations, i.e. it had to calculate losses that were not significantly higher than expected or significantly lower than expected. The method we developed and tested is documented here. It was also briefed to the Land Warfare Sub-group at the 67th Military Operations Research Society Symposium at West Point Military Academy in June 1999. A copy of the presentation is included in Appendix 29 (it is presented out of sequence to facilitate packaging the report).
- Appendix 27 documents the early design notes for the knowledge base specification for the generic advance activity. This is the primary activity for bringing units into contact with one another. It brings together the movement of units with the concurrent checking for the presence of enemy units. Throughout this activity units, both friendly and enemy, are "continuously looking" for the opposition. When opposing forces are encountered, the system evaluates whether to by-pass the other force or to engage and defeat it. None of the responses are scripted into the system. The rules for the activities are coded into the object models, but the outcome of any encounter, to include the basic action, reaction, and counter-action, is totally dependent on the situation. Future additions to the knowledge base could be made by anyone having a working knowledge of Java.

- The Movement to Contact (MTC) activity offers an excellent view into the progression of the development process. In three separate documents, one sees how this activity evolves from the designer's notes into the High Level Design and finally into the system design. Appendix 28 contains the design for the MTC. It contains the methods and attributes for this activity along with some of the pseudo code used to implement this design.
- Appendix 30 gives a good visualization representation of the structure in the object diagrams, the loops and the logic. Combined with the Javadoc Design Documentation, this provides the technical details of the system design.
- Appendix 31 is a PowerPoint presentation titled "Under the Hood," which describes more aspects of how the system functions, particularly the reasoning behind the structuring and sequencing of the algorithms.

Scenarios

A total of twelve scenarios have been developed to explore various parts of the military functionality. One of the questions asked by observers concerned the flexibility of the system to address more than one scenario. We started working initially with the division operations at the National Training Center. We expanded next into operations in Germany. We also modified the system to plan at either the brigade or division level.

In support of Prairie Warrior 99 (PW99), we created a couple of scenarios in the Philippines at the division level. One of them mirrors the plans laid out by the division planning staff. The other approaches the same terrain as a movement to contact (MTC).

A user can create his or her own scenario easily following the instructions in the User's Manual. The user starts by creating units in BPVWin and setting their routes and activities. They proceed to import this information into CADET, populating the synchronization matrix with the initial set of tasks. CADET expands the tasks and performs the calculations for resource consumption and attrition. The user can then export the activities back to BPVWin to observe the animation and they can save the CADET synchronization matrix to an Excel spreadsheet.

The only limits on creating units are those inherent in BPVWin. BPVWin needs to recognize the type and size of unit or else it cannot draw the unit symbol on the map. Generally, any unit and any activity acceptable to BPVWin would be similarly acceptable to CADET. The only exception might occur if recent changes have been applied to BPVWin that haven't had time to be incorporated into CADET as of yet. Unit names, unit types, routes, and activities are entirely under the control of the user. Of course, this applies to both friendly and enemy units in like manner.

The existing scenarios for CADET and the corresponding BPVWin scenario files are identified in Table 2 below.

Table 2. CADET Scenarios

Area	Echelon	BPVWin Scenario	CADET Scenario
Philippines	Division	PW99.sca	BPVPW99Scenario.class
Philippines	Division	mtc.sca	BPVPhilMTCSscenario.class
NTC	Division	BPV1BnAttackACo.sca	BPV1BnAttackACoScenario.class
NTC	Division	BPVMTC.sca	BPVMTCScenario.class

NTC (no MCOO)	Division	cadetPhase2.sca	CadetPhase2BaseScenario.class
NTC	Division	cadetPhase2NTC.sca	CadetPhase2BaseScenario.class
NTC	Brigade	cadetPhase2NTCbde.sca	CadetPhase2BrigadeBaseScenario.class
NTC	Division	cadetExtMTC.sca	BPVMTCScenario.class
NTC	Division	CadetPhase2.sca	MTCScenario.class
Germany	Division	cadetPhase2germ.sca	CadetPhase2GermanyScenario.class
Germany	Brigade	cadetPhase2germBde.sca	CadetPhase2GermanyBrigadeScenario.class
Germany	Division	cadetExtMTCgerm.sca	BPVMTCScenario.class

In-Process Reviews

Throughout the course of the project, we conducted In-Process Reviews (IPR) on a quarterly basis. The site for the IPR was rotated between CECOM at Fort Monmouth, NJ; BCBL-L at Fort Leavenworth, KS and Logica Carnegie Group's home office in Pittsburgh, PA.

For each of the IPRs, we invited everyone in the area known to be working in the area of COA analysis. In the course of three years we have hosted representatives from DARPA and from DARPA's Course of Action Analysis (COAA) program, from many of CECOM's related research areas and from the National Simulation Center (NSC) at Fort Leavenworth. The Battle Command Battle Laboratory - Leavenworth and the Army Research Laboratory have contributed frequently to the meetings. Besides COAA, we have exchanged information with developers for FOX GA, DARPA's Advanced Logistics Program (ALP), WRIIST - Warfighter Rapid Intelligent Information Support Tool (another CECOM SBIR effort) and many others with interest in the CADET efforts.

These collaborative efforts have facilitated the growth of CADET while seeding other programs with some kernels of knowledge gleaned from the CADET development. This collegial sharing of information seems to be one of the strongest aspects of the Small Business Innovative Research (SBIR) program. The return on investment is clear when one looks at the ideas growing out of these communal efforts to solve the problems in the military decision-making process.

Demonstrations

We had the opportunity to demonstrate CADET many times during the past three years. We put it in front of potential users ranging from the faculty and staff at Fort Leavenworth's Command and General Staff College to the division planning staff of the 4th Mechanized Infantry Division (the "Digitized Division") at Fort Hood, TX. Starting at the first quarterly IPR, we included a demonstration of the system in each IPR, using a projector connected to a computer system to display the system for everyone present.

We demonstrated CADET a number of times for developers and program managers at CECOM, including the MCS Program Manager, LTC George Kather. We took CADET on a laptop to the Pentagon and demonstrated it for the Stan Levine, Deputy Director of the Army Digitization Office (ADO). We demonstrated it for the Army Experiment 6 (AE6) committee while they were considering CADET for inclusion in AE6. We demonstrated CADET on multiple occasions to COL Marshall Reed, the MCS TRADOC System Manager.

We received a tremendous amount of encouragement as a result of these demonstrations. Observers provided valuable feedback on every subject from the functional modeling to the colors of the screens. We evaluated their feedback in each instance and implemented their recommendations where possible. Not all of the feedback fell within the scope of this effort, but all of the comments were welcome nonetheless.

Perhaps the most valuable feedback came from MAJ John Frame and the other members of the division planning staff at Fort Hood, TX. They related to us their issues and concerns in the area of digitized planning, particularly in an environment with a mix of analog and digital systems. This feedback helped shape the direction of much of the development. We continued to maintain contact with MAJ Frame and the other staff members via e-mail and phone conversations throughout the project and benefited greatly as a result. We highly recommend repeated exposure to the intended users throughout the development process as a means of maintaining the focus of the project.

Hardware/Software

The initial plan for the project called for CADET to run on a Unix-based system, interfacing with BPV on a Silicon Graphics, Inc. (SGI) platform. Fortunately, CECOM was able to develop a version of BPV that runs on a Windows-based machine, typically a laptop. The ultimate vision for CADET calls for it to become a component on MCS or a similar BC2 system. MCS is currently transitioning from Unix platforms to a Windows NT environment on a high-end laptop.

CADET was written in Java to maintain its portability between Unix machines and laptops. It runs equally well on Unix systems or laptops equipped with Windows NT or Windows 2000. It also works well across a network or in a stand-alone mode.

Y2K

Logica Carnegie Group performed Y2K testing and certified CADET as Y2K compliant in accordance with standard industry practice at the time.

RESULTS AND DISCUSSION

CADET has grown from its early prototype to a highly functional system with tremendous capability. A partial list of the things of which CADET is capable includes the ability to:

- Import units from BPVWin via Collaboration Server
- Import routes from BPVWin via Collaboration Server
- Import control features from BPVWin via Collaboration Server
- Display activities in a synchronization matrix that mirrors the standard used by planning staffs
- Allow the user to add new activities
- Allow the user to edit existing activities
- Calculate attrition based on METT-T
- Model weapons systems and vehicles for
 - fuel consumption,
 - ammunition consumption,
 - fuel transportation,
 - ammunition transportation

- Model ammunition at the individual type of round (DODIC-level)
- Model reconstitution
- Model supply activities at Task Force Support Platoon level
- Model the effect of maintenance and medical activities at the Forward Support Battalion level on the Task Force resource levels
- Determine the need for and schedules movement of the FSB
- Model emergency evacuation of the FSB.
- Pass units, routes and activities to BPVWin for animation
- Print the synchronization matrix to a plotter.
- Export the synchronization matrix to Microsoft Excel, complete with formatting.

To fully understand and appreciate the capabilities of CADET, one should operate the software and examine the various functions. The CADET End User's Manual provides a good start point by identifying the features accessible through the various menus. It does not do full justice, however, to the functions that are based on the current situation to derive a set of outcomes. For instance, CADET will automatically determine the need for a regeneration activity and schedule the location and resources, when the need arises. However, there is no button on CADET for creating a regeneration activity. The circumstances drive the need and CADET reacts. Many of these implicit actions are written into CADET and come into play only when the situation requires them. These features will become evident as one uses the software but remain hidden otherwise.

Building a New Plan from Scratch

A separate chapter in the CADET End User's Manual explains step by step the process for building a new plan from scratch. The five basic steps are as follows:

- Create the units and their routes in BPVWin, along with the control features.
- Open CADET and import the units and their routes.
- Assign activities.
- Expand the plan and perform the resource planning and attrition calculations.
- Pass the units and their expanded tasks back to BPVWin for plan animation.

In the example below, we have created an objective in BPVWin (Figure 3). When this is passed via Collaboration Server to CADET, it will become an object in the CADET knowledge base against which CADET can reason.

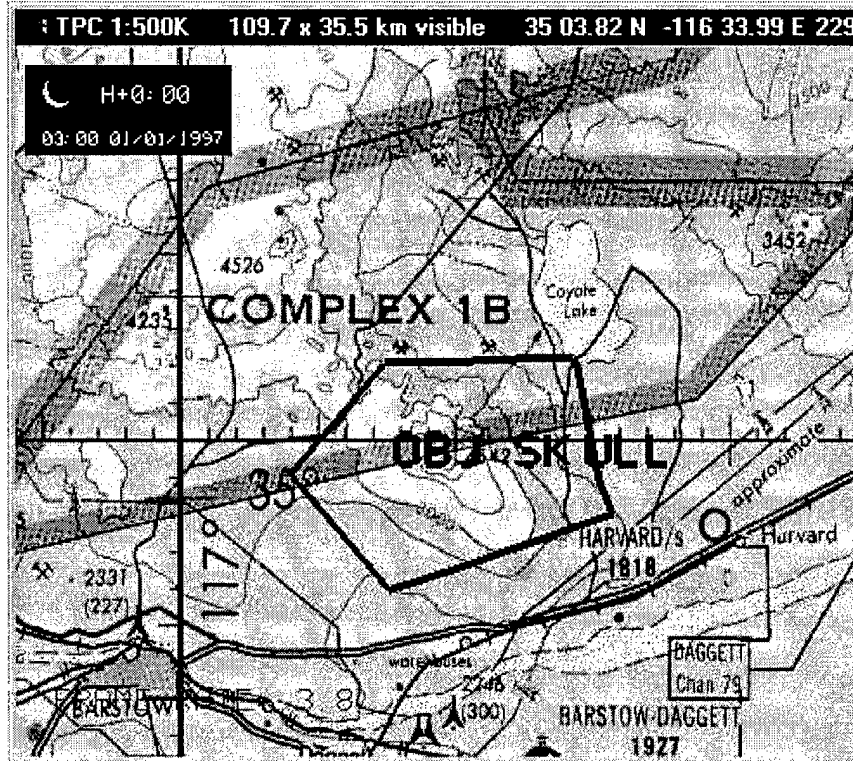

Figure 3. Objective drawn into BPVWin as a control measure

The unit editor in BPVWin (Figure 4) allows the user to designate the type and echelon of the unit. The user can specify the unit name and designate the unit as friendly or enemy.

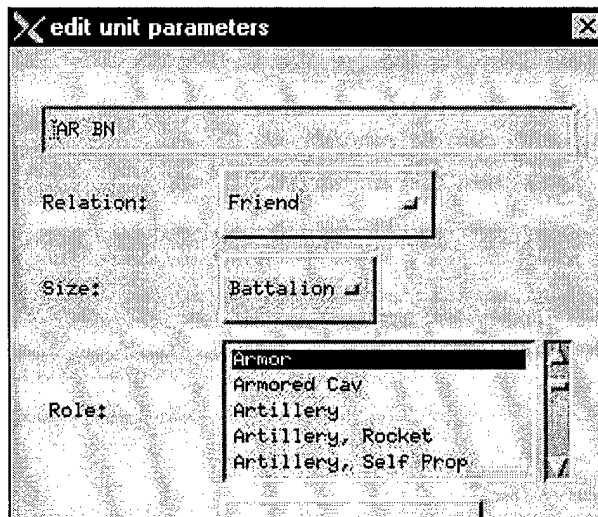

Figure 4. BPVWin Unit Editor window

The user can draw in the routes for each unit in BPVWin (Figure 5). As the cursor moves across the map, the location of that point is displayed in the BPVWin Map Window title bar. The user can also go back and move the points along the route using "drag and drop."

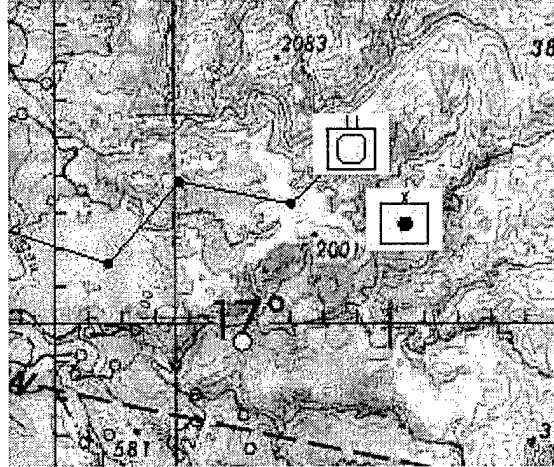

Figure 5. Drawing unit routes into BPVWin

When the user is satisfied with the rough COA in BPVWin, everything is saved as a scenario (Figure 6). The user has to remember to use .sca as the file extension or else the save function won't work.

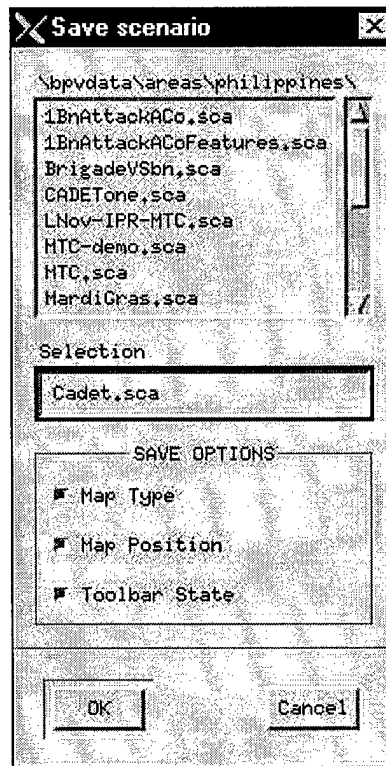

Figure 6. When saving the scenario in BPVWin .sca must be used for the file extension.

With the scenario safely saved, start a collaboration session for Cadet. From the **BPVWin Main Menu**, chose **Collaborate** and then **Start Session**. The name for the collaboration session must be 'Cadet,' as shown in Figure 7.

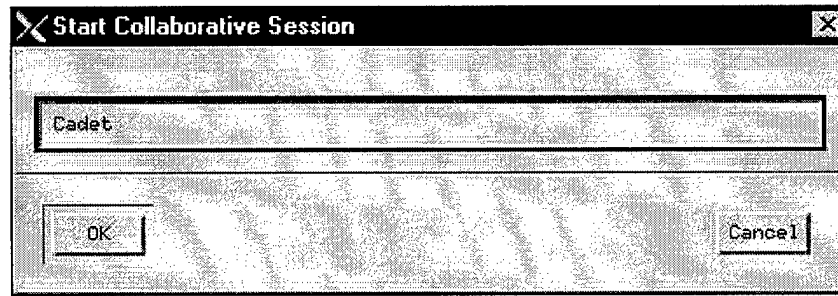

Figure 7. The Collaboration Session must be entered exactly as *Cadet*

At this point, the user can enter CADET. Inside CADET, set the Planner's Echelon to either Division or Brigade as needed. Initially, the column headings should be in one-hour increments. On the **CADET Main Menu**, click on **File**. Move the mouse down to **Import**. When the pop-out menu appears, click on **BPVWin**. It will take a few seconds for the units, routes and control measures to load into CADET. One indication the data has loaded is when the column headings change to 15-minute intervals.

To build an activity in CADET, find the time and BOS row appropriate to the activity. Click in the cell where the time and BOS row intersect. The Activity Menu will appear on the left side of the screen. Click on **Add Activity**. Use the mouse to follow the Sub-menus to the correct activity and release the mouse. For example, if you are creating an attack, the **New Attack In Area Editor** window will appear (Figure 8).

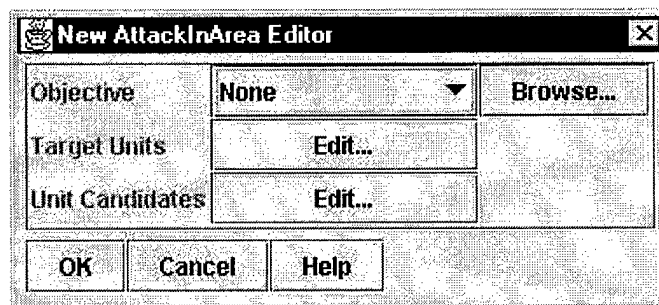

Figure 8. The editor window for a new Attack activity

As shown here, the user designates the objective, by choosing from a drop-down list of the control measures imported from BPVWin. The Target unit is chosen from a drop-down list of units imported from BPVWin. The Unit Candidates are those units to be considered in choosing which unit should perform the mission. Again, this list is built from a drop-down menu of units imported from BPVWin.

The designation of the target unit is more a convenience than a necessity. If the route of the friendly unit brings it in contact with enemy units it will assess each one against its by-pass criteria and determine whether to attack the unit or by-pass it. By designating the unit as the target the user ensures the friendly unit will attack the unit, even if it is so small that it might otherwise by-pass it.

Reconstitution

Reconstitution is something CADET inserts automatically when needed. For each activity, CADET determines the resource requirements and tracks the remaining resources. It also projects the requirements across the entire operation to ensure sufficient resources to complete each future activity. When the future activity falls short of the required resource requirements, CADET assesses the need for and capability to provide reconstitution.

CADET routinely schedules reorganization, the simplest form of reconstitution. In reorganization, the unit performs **self-sustainment** and receives **sustainment support** from the Division Support Command (DISCOM).

For self-sustainment operations, CADET models the support platoon or supply element for each Task Force. If the support platoon doesn't already exist in the Task Organization, CADET will insert the support units for all combat units automatically. CADET assumes a combat unit would never fight without its organic support units. The user can override this assumption by deleting out the support activities.

Aviation units are a little different in that the attack helicopters can often travel to the support when it's provided at a remote site, such as in the case of a Forwarding Arming and Refueling Point (FARP). There might also be differences in whether the supply support is provided by units within the Aviation Brigade or by the Aviation Support Battalion, which is subordinate to the Division Support Command (DISCOM). The general concept remains the same.

The Logistics Package (LOGPAC) operations for the task force are modeled in detail. The support platoon organizes a LOGPAC in the Brigade Support Area (BSA) and travels to the combat trains to provide sustainment support, returning to the BSA to replenish its stocks. In CADET, this looks something like the support for two attack helicopter battalions shown in Figure 9.

	H+0:45	H+1	H+1:15	H+1:30	H+1:45	H+2	H+2:15	H+2:30	H+2:45	H+3	H+3:15
1 Attk Bn Supply Travel to LRP											
1 Attk Bn Reorganization after Attk											
1 Attk Bn Supply Travel to BSA											
Aviation Support Bn resupply 1 Attk Bn Suppl											
2 Attk Bn Reorganization after Attk											
2 Attk Bn Supply Travel to BSA											
Aviation Support Bn resupply 2 Attk Bn Suppl											
2 Attk Bn Supply Travel to LRP											

Figure 9. Supply Platoons (LOGPACs) travel between BSA and unit

The actual time for the self-sustainment will be determined by CADET after it assesses the full range of future scheduled activities to determine when a self-sustainment will be least disruptive. In a dispatch-driven planner, such as a simulation-based planner, a unit might move rapidly across the battlefield and find itself short on fuel just as it starts the final assault. CADET, by looking across the longer time horizon, recognizes the fallacy of such planning and looks to see if a self-sustainment operation earlier in the operation will provide the needed resources to get past the critical event.

It is worth noting at this point that the level of detail displayed here far exceeds the division staff's normal level of interest. The same is true of many activities in CADET but it is perhaps more obvious here. The need exists for a capability to filter the display, setting an upper level and lower level of detail to be displayed, subject to the user's particular focus.

The time spent performing the support functions at the using unit site is factored in, along with the time required to draw replenishment stocks in the BSA. The travel time between the two locations becomes a major factor in determining the feasibility of a plan. As the combat trains get further away from the BSA, the time required to make the round-trip back to the BSA to replenish the LOGPAC gets correspondingly longer.

Forward Displacement of Brigade Support Area (BSA)

CADET will automatically schedule the Brigade Support Area (BSA) to move under the control of the Forward Support Battalion (FSB). Figure 10 shows a planned movement for a BSA with the pre-movement preparation activities, which might include evacuation of medical patients and maintenance jobs that exceed the maintenance timelines. The DISCOM would be involved in directing deliveries to the old location until the new site is operational. As the new site becomes fully functional, the DISCOM would direct new deliveries to the new site.

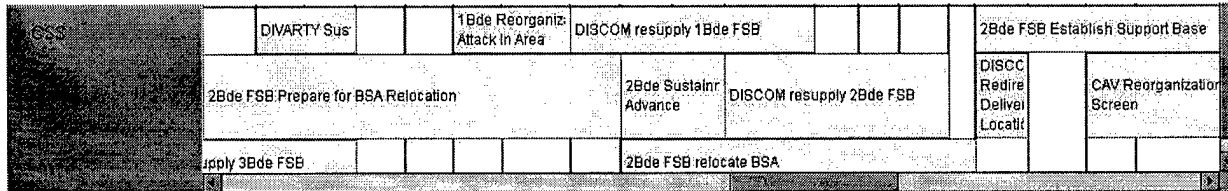

Figure 10. BSA moves, DISCOM re-directs deliveries to new location

Sustainment support between the DISCOM and other higher echelon support units and the Brigade Support Area (BSA) appear in Figure 10 under the activity *DISCOM resupply 2Bde FSB*. Under current Army doctrine, there is a significant amount of support to a brigade that might come directly from the Corps Support Command (COSCOM) or even delivered directly by Theater Army Area Command (TAACOM) units. The latter is most likely when stocks arrive in port already pre-configured for the forward combat units. This might allow the direct delivery of stocks without any handling at the intermediate support echelons.

Regeneration

Regeneration is the more complex form of reconstitution. Regeneration occurs whenever a unit requires significant replacement of resources such as personnel and weapons systems, beyond the capability of the next higher level command to supply them. For instance, if a brigade is unable to reconstitute a battalion using the resources available from within the FSB, backed up by the DISCOM, it falls on the division to regenerate the battalion using its resources. The rule of thumb is that a unit being regenerated requires the support of the headquarters two echelons higher. A battalion requires division support for regeneration. A brigade requires corps support for regeneration.

The two other significant pieces of regeneration are **location and time**. Experts agree that a unit undergoing regeneration should be withdrawn from the fight and moved to a safe location outside of indirect artillery fires, if possible. The travel time from the unit's current location to the regeneration site, added to the time needed for the regeneration and the time needed to travel back to the fight generally prevents that unit from being effective for combat in the near term.

CADET will warn the user when a unit's resources are falling low (Figure 11).

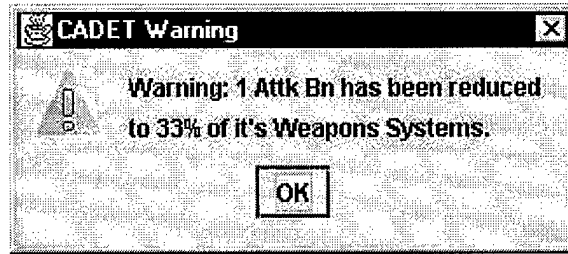

Figure 11. CADET warns initially of significant losses in weapons systems

CADET continues to monitor the losses and if they become significant, CADET will recommend a regeneration operation (Figure 12).

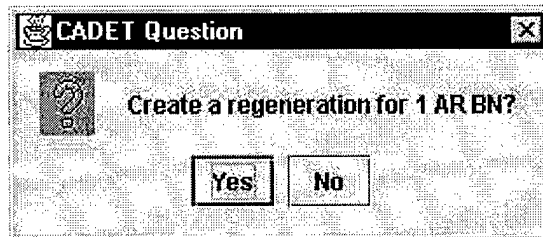

Figure 12. CADET recommends a regeneration, but the user can choose not to

If the user disagrees, CADET continues to watch the unit's losses and interjects a message when the losses become prohibitive to the unit continuing its mission (Figure 13). At this point, CADET will *highly recommend* regeneration.

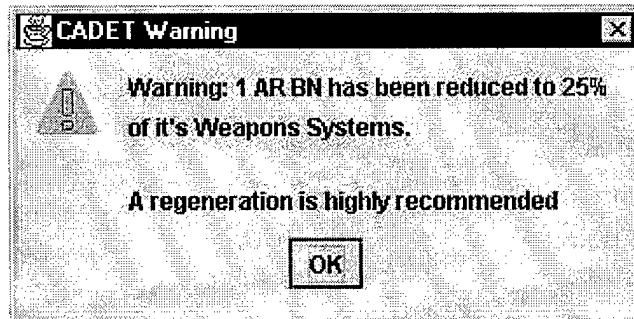

Figure 13. CADET *highly recommends* regeneration

If the user agrees to schedule one, CADET will plan the movement of the unit to the nearest site deemed safe for regeneration. That unit will be removed from the fight for the duration of the current plan.

There are two prime examples of CADET's ability to insert an activity based on other actions. For instance, any time a unit is moving in the attack and firing artillery, CADET will automatically plan for the enemy to perform counter-battery targeting and to fire **counter-battery artillery fire**. It also assumes friendly artillery will attempt to locate the enemy artillery and fire its own counter-battery fires. (At this point CADET stops expanding the counter-battery fires, recognizing the potential for an endless loop of counter actions and counter-counter actions.)

Emergency Evacuation of a Brigade Support Area (BSA)

The second example of an automatic response occurs whenever the location of the FSB becomes untenable and requires **emergency evacuation**. CADET evaluates the BSA location whenever it plans a self-sustainment operation to determine if the distance between the BSA and the combat trains has become too great. It also looks at the BSA location whenever the friendly units perform retrograde movements. There is a clear trigger for the BSA to move whenever the threat units get too close. CADET expands this basic idea by assessing whether or not the location of the BSA is interfering with the friendly combat units' ability to maneuver freely. CADET will recommend the BSA move as soon the friendly combat units get too close for their own comfort. In planning the retrograde of the BSA, CADET will schedule the activity in much the same way as described above. If the movement can be foreseen with enough foresight to appear in the MDMP, it should be planned with the same level of detail provided for any BSA movement.

Defensive operations are not specifically called out as a separate activity in CADET. CADET will cause a unit to defend itself any time it is attacked. However, the preparation of defensive positions is not yet modeled. We have conducted extensive research and interviews with SMEs on the subject. The modeling would be a relatively straightforward extension of the work already performed

CADET calculates resource consumption at two levels.

For general levels of supply, CADET looks at the amount of supplies on hand as a percentage of the basic load. This is usually sufficient for advanced planning where the precise consumption rates can be expected to vary based on terrain, weather and operational tempo. This type of calculation works well for fuel consumption where the unit has a finite number of vehicles with specific fuel tank capacities and measurable amounts of resupply capability. CADET models a series of vehicle types and their associated fuel carrying capacities. The intent would be to link CADET at some future time with a system having more detailed information on unit equipment (UE) and related resource requirements. The Combat Service Support Control System (CSSCS) tracks the number of vehicles in a unit, including the number operational and non-operational. For CADET, unit equipment can be found by clicking on the **Browse** button beside the **Equipment** attribute on the unit editor window (Figure 14).

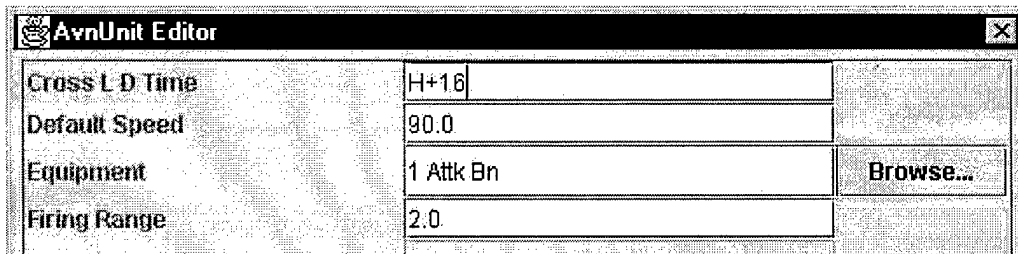

Figure 14. The Unit Editor window has a button to Browse to the Unit Equipment editor

In the Unit Equipment Editor window (Figure 15), the user can access three primary types of information: available weapons systems and vehicles, ammunition consumption, and fuel carrying capacity.

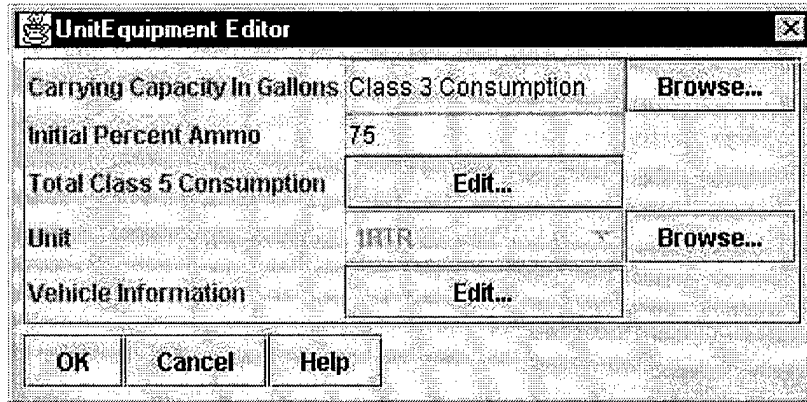

Figure 15. For Unit Equipment, CADET focuses on fuel, ammo and number of weapons systems

By clicking on the Edit button beside the Vehicle Information attribute, the user can access the list of vehicles. CADET will open up a Vehicle Information List window (Figure 16). The user can see the list of UE loaded for this unit. They can add or delete vehicles. They can also edit the attributes of a particular type of vehicles by highlighting the vehicle name in the list pane and then clicking on the **Browse** button in the lower right hand corner of the window.

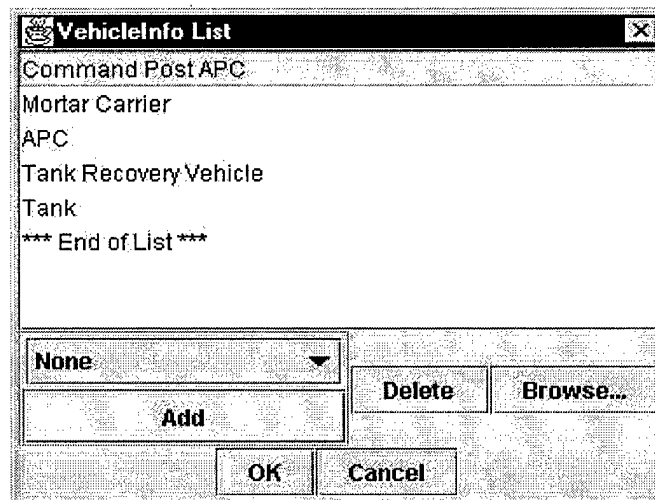

Figure 16. The Vehicle Information List window

Figure 17 shows the Vehicle Information Editor window. The user can access the basic loads established for each unit's equipment and make adjustments. This is also where the user could adjust the number of vehicles up or down based on experience with maintenance activities and planned replacement schedules.

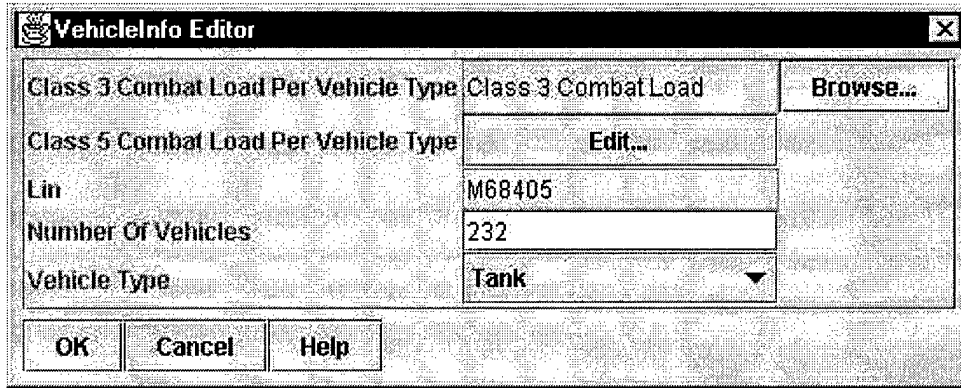

Figure 17. The user can adjust the combat load for each type of vehicle, by unit

Ammunition modeling at DODIC Level

A number of ammunition types have been modeled at the DODIC level of detail to illustrate the utility of this functionality. Working through the editor windows for Class V (ammunition)(see Figures 15 and 17), the user can access the Class 5 factors. The user can determine the mix of ammunition in a tank's combat load, balancing between SABOT rounds and High Explosive Anti-Tank (HEAT). As Figure 18 shows, SABOT appears as Model M829A1 and HEAT appears as Model M830. A future enhancement would be to add the ability to recommend alternative ammunition types when the preferred munition is not available.

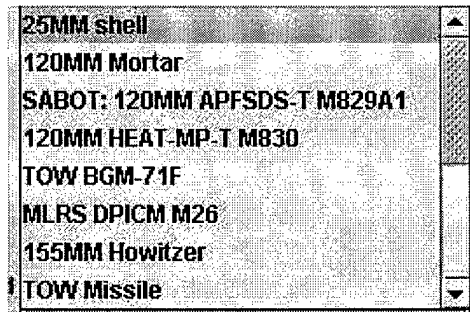

Figure 18. Selected ammunition types are modeled at the DODIC level

The consumption of various types of ammunition is reflected in the resulting resource consumption graph (Figure 19). Note the graph shows number of rounds rather than a percentage of the basic load.

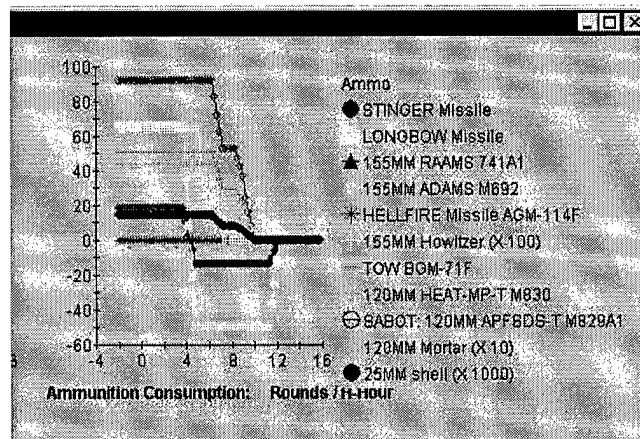

Figure 19. Ammunition consumption by number of rounds

Movement To Contact

The modeling of a Movement To Contact introduced a number of significant challenges but the result is a modeling approach that lends itself easily to modeling Force XXI operations.

Automated Modeling of Actions/Counter-actions on Contact

First and foremost, the unit making the contact had to know what to do upon making unexpected contact. In a directed activity such as an attack, the acting unit has a designated target. In a movement to contact, the unit might, and by design probably will, make contact with another force at a time and place not of his own choosing. For this reason, we added to CADET the ability to assess an enemy force upon contact in comparison to the by-pass criteria.

- If the unit is smaller than the by-pass criteria, CADET will attempt to find a new route around the unit. Depending on how many routes are available for the initial plan definition, it may require help at this point.
- If the unit is larger than the by-pass criteria, CADET will employ the unit making first contact to maintain contact while following units maneuver to a flank.

Modeling of Unit Displacement to Provide Continuous Support

Second, CADET needed the ability to model continuous coverage provided by sensors, communications support and artillery support. There are two major approaches to providing continuous coverage.

- Support in-column, on the move. With this method, the supporting activities travel along with the march column, providing continuous support while moving and stopping only as necessary. The most modern artillery is particularly adept at stopping and delivering immediate response artillery fires on a moment's notice, thanks to Global Positioning System (GPS) and other advances in indirect fire support. Communications and sensor support are not as good on the move.

- Leapfrog movement. Also referred to as bounding, this technique involves splitting the assets into two teams. One team supports while the other travels with the march column. As the march column nears the limit of coverage provided by the stationary team, the moving team stops and sets up to provide support. The trailing team must then move from the rear of the march column and advance to a point where it can provide support. Because it is difficult for them to move faster than the march column, their speed determines the speed of the overall movement. For smaller teams such as sensors and communications, movement by helicopter might speed up the process. Figure 20 shows sensor teams moving by the leapfrog method.

	0:45	H+1	H+1:15	H+1:30	H+1:45	H+2
THREAT ACTION						
DECISION POINTS						
INTEL		Sensors Team B Re-position to provide continuous coverage		Sensors Team B Provide coverage for area		
			Sensors Team A Provide coverage for area		Sensors Team A Re-position to provide continuous coverage	

Figure 20. Sensor teams leapfrog for continuous coverage

- As modeled in CADET, the user has the option of choosing between the in-column movement and the leapfrog method of movement.

Modeling of Obstacle Breaching Operations

Third, CADET needed the ability to deal with obstacles.

Obstacle breaching is generally a task for a brigade or lower echelon, but it is needed for any movement to contact. If not dealt with efficiently, obstacles will slow the movement of the march column and risk mission success. We were fortunate to get good advice from subject matter experts (SME) on modeling obstacle breaching operations. Figure 21 is an example of a situation where the unit is able to achieve its objectives without breaching every obstacle it encounters.

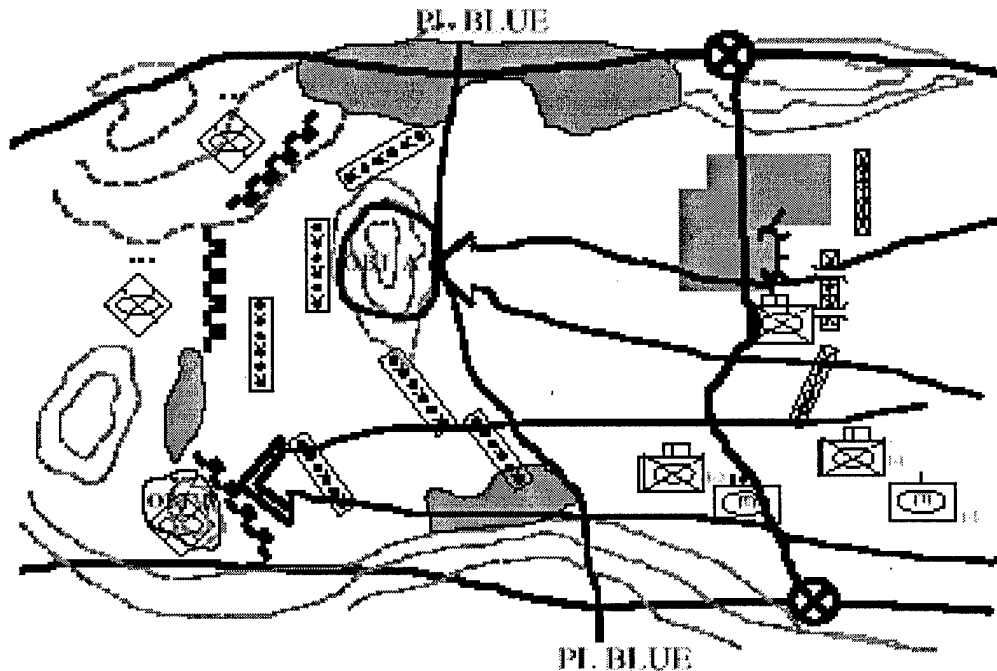

Figure 21. The supporting attack proceeds to and occupies Object A. The company team does not attempt to breach the minefields on the far side of the objective. Rather from this high ground, the company team *supports by fire* the main attack in the south.

Modeling Attrition of Personnel and Weapons Systems

Fourth, CADET had to have a rapid means of calculating attrition to be able to fight a series of engagements over a period of time.

Without a means of estimating attrition, it was impossible to estimate relative unit strengths going into the subsequent engagements. The attrition had to be calculated rapidly, reliably, and in a means reasonable to the average user.

We created a calculator that considers relative unit combat power, as well as the intended objective, the terrain, level of defense preparedness, weather, and time of day. The result can be viewed and used for off-line analysis by clicking on **Analysis** on the **Cadet Main Menu**. On the Analysis sub-menu, click on **Combat Calculator**.

The Combat Calculator window (Figure 22) will appear. The user can set the number of units by type and other parameters before hitting the Compute button.

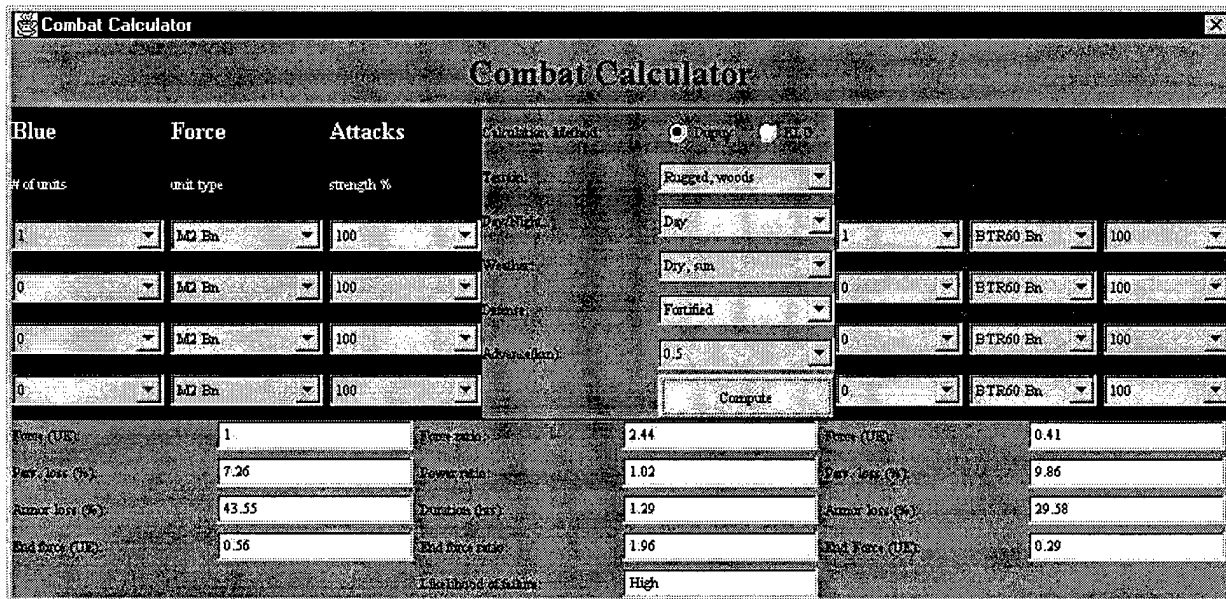

Figure 22. Combat Calculator

The user can choose between the Dupuy parameters for the attrition calculations and the KLG method. KLG refers to Dr. Alexander Kott, Lt.Col. (ret.) John Langston and Lt. Col. (ret.) Larry Ground, the developers of this method. The KLG method has been reviewed and tested with numerous subject matter experts and the results briefed at the 67th Military Operations Research Society Symposium (MORSS) at West Point, NY as mentioned earlier.

The results of the Movement To Contact modeling have been very satisfying, providing a realistic view of the unit movement, impeded at some points by the movement of sub-elements to provide continuous support with sensors and communications. The interaction between friendly and enemy units follows doctrine with regard to by-pass and attack criteria. The breaching of obstacles, when done properly, slows the movement without disrupting the overall mission success.

These represent the most significant of the activities modeled today in CADET. To model a highly complex activity, such as Movement To Contact, which in turn creates about a dozen new major activities, requires about 250 man-hours of labor. To fully model all of the tactical missions, tasks and activities used at the brigade and division level would be a significant task, but certainly not an impossible one.

RECOMMENDATIONS

Users have identified three major areas of potential application for the system.

- The first is in the number-crunching of planning. In this instance, the user is fully qualified to perform the planning, but wants to delegate the calculations and resource planning and checking to the system. The user and other staff members want to focus on the art of the wargaming

process without getting bogged down in the determination of how many gallons of fuel it takes to get point A to point B.

- The second is as a "checklist." During a period when the user is tired and unable to focus his or her full faculties on the problem, CADET serves as another pair of eyes, making sure no doctrinal "rules" are violated inadvertently. If the user chooses to overrule the doctrinal "rules" either because the rule doesn't fit or because the user intends to operate "outside the box," CADET helps identify the impact without judging the plan.
- The third situation involves the introduction of new persons to the planning process. Most planning at the brigade level is performed by captains and junior majors with limited staff planning experience. A tool to help them identify doctrinal constraints and guide them through attrition estimating would be helpful. Without "grading the COA," it could help identify areas for further examination.

In January, the development team performed a detailed analysis of CADET as it currently exists at the end of the CADET Enhancements effort with a view to determining what actions would be necessary to make it useful as a planning tool for officers in the field. The team concluded CADET would benefit greatly from

Assessment of current state

From the software perspective, CADET is that of a pre-alpha or alpha release. It is a good deal better than most prototypes, as the coding was done with more care and unit testing than usual in the research world. The software has substantially proven the feasibility and practicality of concepts from which it originated. It has a notable number of gaps, which could be addressed with some additional features, identified in this section.

Eventual location of CADET as an application or tool

- Originally, CECOM and the development team saw CADET as an embedded component within MCS, but it is unclear if it still makes sense. The Army's experience with MCS so far cautions against embedding CADET as a back-end calculator integrated within a large software component: it is unclear when MCS will be ready for an add-on capability of this type, if ever.
- It now appears that CADET should be useable without being embedded into another system. It could still benefit greatly as an MCS data customer, just as BPV-SGI does now, to our understanding. That is, CADET can work apart from MCS but can be linked to MCS for data feeds. The current situation and unit status information in MCS would be very sensible and valuable inputs to CADET.
- This implies, of course, that CADET would need its own user interfaces, its own concept of operations and its own knowledge base, etc. We have not developed a lot of effort to these areas, hoping they would come with MCS.

Strengths of CADET's approach

CADET's approach is mature enough. It is very pragmatic. It uses straightforward heuristics and techniques of hierarchical task network planners. It is scalable in that it uses a no-backtracking procedure whose algorithmic complexity grows much more slowly than the backtracking approaches.

Absent the demands of BPVWin (whose developers recommend a dedicated machine), CADET doesn't heavily tax an ordinary PC.

Approaches to transitioning CADET to operational use

A very key task is to extend the knowledge base. Experience from other, larger knowledge-based developments has taught us not to recommend the invention of yet another "end-user" language for encoding knowledge; these languages are almost always harder to use than regular programming languages, and there are, of course, no available personnel already trained in them. Instead, we can use simple procedures known to have worked in the past to interface domain experts and programmers.

We recommend the knowledge base be made available for other programmers to modify as needed. We made special efforts that the CADET objects representing the knowledge base be carefully separated from all other modules of CADET and readily modifiable by any programmer.

We recommend the end-user be provided with inexpensive and easy to use facility for entering and editing some of the most common knowledge base objects. Although we have experience with building full-blown knowledge editors, we cannot recommend such an effort - too expensive and still does not solve all the problems. There is a simple compromise that should give 80% of the functionality for 20% of the cost.

The development team's list of ideas for CADET's evolution

Objectives/Vision:

18-24 months from now, an officer in field environment, given a couple of hours of training, would be able to rapidly (within 15-30 minutes) introduce a problem (or receive the statement of the problem electronically), produce detailed battle plan for division or brigade-sized operation, then generate and email the products.

- A blind-jury experiment confirms that the products are comparable in quality to those produced by several experienced officers over a 3-hour planning session.
- A blind-jury experiment also confirms that the products produced by a team of CADET plus inexperienced (or very tired) officer are noticeably better in quality than those produced by a similar officer over 3 hours of work.

Input:

An XML file that arrives as an email from another officer; or from a COA-generator like FOX GA; or a coarse COA entered from a map-based interface.

Output includes all of the following:

1. Synchronization matrix, directly editable and printable
2. Map overlays in PPT or JPG formats
3. Animation output to BPV
4. XML formally-encoded plan
5. Textual OPLAN draft
6. E-mail messages with attachments: XML and text versions of OPLAN

User Interface:

We recommend exploring and choosing one of the following, in order of our current preferences: improved, fast-edit, fast-navigation Smatrix; MS Excel with two-way access to CADET; or MS Project with two-way access to CADET

As far as the map-based interface, we recommend exploring with CECOM if BPV is a realistic platform for map-based interface, and how it would support CADET work. We recommend looking for a smaller, lighter, faster, more user-friendly mapping application. There are a couple of options to consider.

Save/Restore:

User would be able to save/restore plans at any level of completion: from initial input to partial or completed plan. We recommend use of XML files only, avoiding the use of a database for simplicity, low footprint, and portability.

Process/Intelligent support:

- User could modify a plan in the middle of the planning process, and CADET would be able to continue in all cases.
- CADET could automatically resolve infeasibilities (with user's approval).
- CADET could add a broad variety of action/reaction/counteraction activities when situation requires (with user's approval).
- CADET could ask the user if an additional unit might be available, if this appears reasonable.
- CADET stops the planning when it observes serious military difficulty or uncertainty (e.g., very low level of attrition, etc.) and prompts the user.

Breadth of scope:

The scope would encompass both offensive and defensive tasks, but would focus primarily at either the division or brigade level. The unit structure and armament could be oriented to either conventional heavy armored or new light armored such as that proposed for the intermediate brigade concept.

Support for Replanning during the Execution phase:

- CADET would accept XML messages that describe current situation reports (in formal representation) and display the actual execution status of the Synchronization matrix along with the initial plan (a la MS Project).
- CADET would not do a full-blown dynamic continuous replanning, in a strict sense. However, it would provide several significant replanning capabilities, sufficient for many practical situations.
- CADET would allow the user to add/delete/modify any number of activities from a partial or complete plan, and then will attempt to complete the plan. Also, the user could specify the "now" point in time, and CADET would add/change activities only from that point forward
- CADET would permit the user to un-expand a task or undo the plan back to an arbitrary point in an expansion sequence, change something, and re-plan from there.

External System Interfaces:

Collaborative Server is currently too slow, must speed-up 1-2 orders of magnitude. We would rather consider direct call for near-instantaneous transfer to/from mapping application. We recommend using

XML as primary system interface technology. No specific interfaces are recommended other than those implied by the Input and Output sections above.

Summary

The development team believes CADET is poised on the brink of exceptionally great usefulness to the military tactical planner. The obstacles remaining in CADET's path are things significant to user acceptance and real-world functionality, but insignificant in terms of complexity. The most challenging of the research and development issues have been met head-on and resolved. The feasibility of this approach is clearly demonstrated, from the task expansion algorithm to the object-oriented modeling of units, activities and interactions. A tremendous amount has been accomplished for a relatively small investment, a clear testament to the value of the Small Business Innovative Research program. It's time to capitalize on this investment and turn CADET into a functional tool for the soldier in the field.

REFERENCES

- Argo, H., Brenan, E., Collins, M., Gipson, K., Lindstrom, C., MacKinnon, S., *Level 1 Model For Battle Management Language (BML-1)*, TEMO Simulation Laboratory (TSL), 23 March 1999
- Bitters, David L., "Efficient Concentration of Forces, or How to Fight Outnumbered and Win," *Naval Research Logistics*, Vol. 42, pp. 397-418.
- Carnegie Group, Inc., *Course of Action Display and Evaluation Tool Monthly Progress Report, March, 1999*, Carnegie Group, Inc., Pittsburgh, Pa., 1997. [also April, 1999; May, 1999; June, 1999; July, 1999, and August, 1999]
- Carnegie Group, Inc., *Course of Action Display and Evaluation Tool Semi-Annual Progress Report, March – August 1997*, Carnegie Group, Inc., Pittsburgh, Pa., 1997
- Carnegie Group, Inc., *Course of Action Display and Evaluation Tool Semi-Annual Progress Report, September 1997 – February 1998*, Carnegie Group, Inc., Pittsburgh, Pa., 1998
- Carnegie Group, Inc., *Course of Action Display and Evaluation Tool Semi-Annual Progress Report, March 1998 – August 1998*, Carnegie Group, Inc., Pittsburgh, Pa., 1998
- Carnegie Group, Inc., *Course of Action Display and Evaluation Tool Semi-Annual Progress Report, September, 1998 - February, 1999*, Carnegie Group, Inc., Pittsburgh, Pa., 1999
- Carnegie Group, Inc., *Course of Action Display and Evaluation Software Design Document*, Carnegie Group, Inc., Pittsburgh, Pa., 1998
- Carnegie Group, Inc., *FOX-CADET Integration, Description of Tasks, Rough Order of Magnitude Cost Estimate*, Carnegie Group, Inc., Pittsburgh, PA, June 23, 1998.
- Dupuy, Trevor N. *Attrition: Forecasting Battle Casualties and Equipment Losses in Modern War*, Hero Books, Fairfax, Va., 1990.
- Dupuy, Trevor N., *Numbers, Predictions, and War: Using History to Evaluate Combat Factors and Predict the Outcome of Battles*, Hero Books, Fairfax, Va., 1985.
- EER Systems, Inc., *Battle Command Battle Lab (BCBL) Battle Command Combat Training Center Focused Rotation (BCFR) Program (Phase III): Maneuver Battalion and Brigade Commander's Battle Command Tasks*, EER System, Inc., Leavenworth, KS, May, 1996.
- Field Manual 34-130, *Intelligence Preparation of the Battlefield*, Headquarters, Department of the Army, Washington, D.C., 8 July 1994.
- Field Manual 71-123, *Tactics and Techniques for Combined Arms Heavy Forces: Armored Brigade, Battalion/Task force, and Company/Team*, Headquarters, Department of the Army, Washington, D.C., 30 Sep 92

- Field Manual 100-5, *Operations*, Headquarters, Department of the Army, Washington, D.C., 14 June 1993.
- Field Manual 101-5, *Staff Organization and Operations*, Headquarters, Department of the Army, Washington, D.C., 31 May 97
- Field Manual 101-5-1/Marine Corps Reference Publication 5-2A, *Operational Terms and Graphics*, Headquarters, Department of the Army, U.S. Marine Corps, Washington, D.C., 30 Sep 97
- *Fundamentals of Tactical Operations (FB030)*, U.S. Army Command and General Staff College, Fort Leavenworth, Kansas, Feb 95.
- Grubbs, F., *Engineering Design Handbook, Army Weapons Systems Analysis, Part Two*, DARCOM-P 706-102, U.S. Army Material Development and Readiness Command, 1979, Chap. 28-29.
- Haywood, O.G. Jr. "Military Decision and Game Theory," *Journal of the Operations Research Society of America*, Vol 2:4, Nov, 1954, pp 365-385.
- Instructor Notes, C310 Instructor Lesson Plan to Lesson 6 (*The Tactical Decisionmaking Process*), U.S. Army Command and General Staff College, Fort Leavenworth, Ks, Aug 96.
- Kott, A., Ground, L., and Langston, J. *Estimation of Battlefield Attrition in a Course Of Action Analysis Decision Support System*. 67th Military Operations Research Society Symposium, West Point Military Academy, 1999.
- Lanchester, F.W., "Mathematics in Warfare," in J.G. Newman (Ed.), *The World of Mathematics*, Simon and Schuster, New York, 1956, Vol. 4.
- *Marne Division Rules of Thumb Planner's Guide (Draft)*, Headquarters, 3d Infantry Division, Germany, 6 Jun 91
- *Marne Division Command, Control, and Planning Guide (Draft)*, Headquarters, 3d Infantry Division, Germany, 6 Jun 91
- Schlabach, Jerry L., *SHAKA: A Simple Genetic Algorithm for Generating and Analyzing Battlefield Courses of Action*, Graduate research paper, University of Illinois, 1997.
- *Student Text 100-3, Battle Book*, U.S. Army Command and General Staff College, Fort Leavenworth, Kansas, 1 Jul 97.
- *Student Text 100-9, The Command Estimate*, U.S. Army Command and General Staff College, Fort Leavenworth, Kansas, 1 Jul 92.
- *Student Text 101-5, Command and Staff Decision Processes*, U.S. Army Command and General Staff College, Fort Leavenworth, Kansas, 1 Feb 96.
- *Tactical Standing Operating Procedures (TSOP): Armor and Mechanized Division (Coordinating Draft)*, U.S. Army Command and General Staff College, Fort Leavenworth, Kansas, June, 1991
- *Training and Doctrine Command Pamphlet 11-9, Blueprint of the Battlefield*, Headquarters, Department of the Army, Washington, D.C., 10 Sep 93.

LIST OF SYMBOLS, ABBREVIATIONS AND ACRONYMS

4ID(M)	4th Infantry Division (Mechanized)	AG	Advance Guard
A2C2	Army Airspace Command & Control	AG	Army Group
AA	Assembly Area	AI	Air Interdiction
AA	Avenue of Approach	ALP	Advanced Logistics Planner
ACE	Armored Combat Earthmover	AO	Area of Operations
ACR	Armored Cavalry Regiment	ARL	Army Research Laboratory
AD	Armored Division	ASAS	All Source Analysis System
ADA	Air Defense Artillery	ASF	Advanced Security Force
AE6	Army Experiment 6	AT	Anti-Tank
AE7	Army Experiment 7	ATB	Attack Helicopter Battalion

ATCCS	Army Tactical Command and Control System	DAG	Division Artillery Group
BAI	Battlefield Air Interdiction	DARPA	Defense Advanced Research Projects Agency
BC2	Battlespace Command and Control	DDMP	Deliberate Decision-Making Process
BCBL-H	The Battle Command Battle Laboratory - Huachuca	DEUCE	Deployable Combat Earth Mover
BCBL-L	Battle Command Battle Lab - Leavenworth	DISCOM	Division Support Command
BCFR	Battle Command Combat Training Center Focused Rotation	DIVARTY	Division Artillery
BCTP	Battle Command Training Program	DoD	Department of Defense
BDA	Battlefield Damage Assessment	DODIC	DoD Identification Code
Bde	Brigade	DP	Decision Point
BML	Battle Management Language	DS	Direct Support
Bn	Battalion	DSS	Decision Support System
BOS	Battlefield Operating System	DST	Decision Support Template
BP	Battle Position	DTAC	Division Tactical Command Post
BPV	Battlefield Planning and Visualization	EA	Engagement Area
BSA	Brigade Support Area	EEFI	Essential Elements of Friendly Information
BTH	Blade Team Hour	EW	Electronic Warfare
C&C	Command And Control	FA	Field Artillery
C2	Command and Control	FAA	Forward Assembly Area
CAB	Combat Aviation Brigade	FAC3	Field Artillery Command, Control and Communications
CADET	Course Of Action Display and Evaluation Tool	FACP/OP	Field Artillery Command Post/Observation Post
CAS	Close Air Support	FARP	Forward Arming and Refueling Point
CBS	Corps Battle Simulation	FASCAM	Family of Scatterable Mines
CCIR	Commander's Critical Information Requirement	FLOT	Forward Line of Own Troops
CDM	Command Decision Modeling	FM	Frequency Modulated (radio)
CDMP	Combat Decision-Making Process	FM	Field Manual
CECOM	Communications-Electronics Command	FS	Fire Support
CEP	Concept Experimentation Program	FSB	Forward Support Battalion
CEV	Combat Engineer Vehicle	GA	Genetic Algorithm
CFL	Coordinated Fire Line	GS	General Support
CGI	Carnegie Group, Inc.	GUI	Graphical User Interface
CGR	Continuity-Guided Regeneration	HDP	Hull Defilade Position
CGSC	Command and General Staff College	HEMTT	Heavy Expanded Mobility Tactical Truck
Class III	Fuel Supplies	HHC	Headquarters And Headquarters Company
Class IV	Barrier Materiel	HPKB	High Performance Knowledge Base
Class V	Ammunition	IEW	Intelligence & Electronic Warfare
COA	Course Of Action	IMR	Independent Motorized Rifle
COAA	Course Of Action Analysis	ICCES	Integrated Course Of Action Critiquing And Elaboration System
COFM	Correlation of Forces and Means	IN	Intelligence
COSCOM	Corps Support Command	IPR	In-Process Review
COTR	Contracting Officer's Technical Representative	ISR	Intelligence, Surveillance and Reconnaissance
CP	Command Post	ITR	Independent Tank Regiment
CPOF	Command Post of the Future	JCDB	Joint Common Data Base
CSB(F)	Corps Support Battalion (Forward)	JRTC	Joint Readiness Training Center
CSG	Corps Support Group	KB	Knowledge Base
CSG(R)	Corps Support Group (Rear)	KBLPS	Knowledge Based Logistics Planning Shell
CSR	Controlled Supply Rate		
CSS	Combat Service Support		

KMPH	Kilometers Per Hour	PK	Probability of Kill
LC	Line of Contact	PL	Phase Line
LD	Line of Departure	POW	Prisoner of War
LLTR	Low Level Transit Route	PR	Power Ratio
LOA	Limit Of Advance	RES	Radiation Exposure Status
LOC	Lines Of Communication	ROM	Refuel on the Move
LOGPAC	Logistics Package	RSA	Regimental Support Area
LRP	Logistics Release Point	RTD	Return To Duty
LZ	Landing Zone	RTF	Regeneration Task Force
M/C/S	Mobility/Counter-mobility/Survivability	RTR	Royal Tank Regiment
MAB	Medium Assault Bridge	S&R	Search and Rescue
MBA	Main Battle Area	SAM	Surface-to-Air Missile
MCS	Maneuver Control System	SBIR	Small Business Innovative Research
MDMP	Military Decision Making Process	SEAD	Suppression of Enemy Air Defenses
METT-T	Mission, Enemy, Terrain, Troops, And Time Available	SEE	Small Emplacement Excavator
MI	Military Intelligence	SEP	Separate
MICLIC	Mine	SGI	Silicon Graphics, Inc
MLRS	Multiple Launch Rocket System	SITTEMP	Situation Template
MOPP	Mission Oriented Protective Posture	SME	Subject Matter Expert
MP	Military Police	SOI	Signal Operating Instructions
MRB	Motorized Rifle Battalion	SOP	Standing Operating Procedure
MRC	Motorized Rifle Company	SOSR	Suppress, Obscure, Secure, And Reduce
MRP	Motorized Rifle Platoon	SOW	Statement of Work
MRR	Motorized Rifle Regiment	SPL	Support Platoon Leader
MSB	Main Support Battalion	SPOTREP	Spot Report
MSC	Major Subordinate Command	ST	Student Text
MSE	Mobile Subscriber Equipment	TAI	Target Area of Interest
MSR	Main Supply Route	TAR	Tactical Air Reconnaissance
MST	Maintenance Support Team	TBP	To Be Published
N/A	Not Applicable	TCF	Tactical Combat Force
NAI	Named Area of Interest	TDP	Turret Defilade Position
NBCE	Nuclear, Biological and Chemical Element	TEMO	Training, Exercises and Military Operations
NET	Not Earlier Than	TF	Task Force
NFL	No-Fire Line	TOC	Tactical Operations Center
NLP	Natural Language Processing	TRADOC	Training and Doctrine Command
NLT	No Later Than	TRP	Target Reference Point
NTC	National Training Center	TSL	TEMO Simulation Laboratory
O/C	Observer/Controller	UAV	Unmanned Aerial Vehicle
O/O	On Order	UE	Unit Equivalent
OBJ	Objective	US	United States
OPCON	Operational Control	USACGSC	US Army Command and General Staff College
OPLAN	Operations Plan	UTO	Unit Task Organization
OPORD	Operations Order	WRIIST	Warfighter Rapid Intelligent Information Support Tool
OPSEC	Operations Security	Y2K	Year 2000
PIR	Priority Information Requirement		
PH	Probability of Hit		

GLOSSARY

Reference: FM 101-5, Staff Organization and Functions.

Acceptability - One of the four criteria a COA must meet for validity. The tactical or operational advantage gained by executing the COA must justify the cost in terms of resources, especially casualties. This assessment is subjective.

Action/Reaction/counteraction.

Actions are those events initiated by the side with the initiative (usually the force on the offensive).

Reactions are the other side's actions in response.

Counteractions are the first side's responses to reactions.

Avenue-in-Depth Technique - a wargaming technique that focuses on one avenue of approach at a time, beginning with the main effort. This is a good technique for offensive COAs, or in the defense when canalizing terrain inhibits mutual support.

Belt Technique -- a wargaming technique that divides the battlefield into belts (areas) running the width of the sector, zone, or area of operations. The shape of the belt is based on battlefield analysis, and is most effective when the terrain is divided into well-defined cross-compartments; during phased operations (such as river crossings, air assault or airborne operations), or when the enemy is deployed in clearly defined belts or echelons.

Box Technique - a wargaming technique that is a detailed analysis of a critical area (such as an engagement area (EA), a river-crossing site, or a landing zone (LZ)). It is most useful when time is limited, as in a hasty attack, and attention is focused on essential tasks.

Course of Action Analysis (Wargaming) - Identifies which COA accomplishes the mission with the minimum casualties while best positioning the force to retain the initiative for future operations. The wargame is a disciplined process, with rules and steps, that attempts to visualize the flow of the battle. The process considers friendly dispositions, strengths and weaknesses, enemy assets and probable COAs, and characteristics of the area of operations. It focuses the staff's attention on each phase of the operation in a logical sequence. It is an iterative process of action, reaction, and counteraction. It highlights critical tasks and provides familiarity with tactical possibilities otherwise difficult to achieve. During the wargame, the staff takes a COA and begins to develop a detailed plan, while determining the strengths and weaknesses of each COA. Wargaming tests a COA or improves a developed COA after identifying unforeseen critical events, tasks, requirements or problems.

COA Comparison - analysis and evaluation of the advantages and disadvantages of each COA using the evaluation criteria developed earlier. The staff compares feasible COAs to identify the one that has the highest probability of success against the most likely COA and the most dangerous COA. Included in the comparison should be considerations such as the level of risk to soldiers, equipment and mission accomplishment; the position of the force for future operations; the flexibility to meet "unknowns" during execution; and the amount of latitude for initiative by subordinates. The most common technique to accomplish this is the **Decision Matrix**.

COA Development - After receiving guidance, the staff develops COAs for analysis and comparison. Each COA considered must meet the criteria of: **Suitability, Feasibility, Acceptability, Distinguishability**. There are normally 6 steps in COA development:

1. Analyze relative combat power - the effect created by combining the elements of maneuver, firepower, protection, and leadership in combat against the enemy to gain insight into friendly capabilities, type of operation, and enemy vulnerabilities.
2. Generate options - as a minimum, the options should include the most probable and the most dangerous COAs.
3. Array initial forces - starting with the main effort at the decisive point and continuing through supporting efforts, normally placed two levels down (at division, down to battalion). This identifies the total number of units needed, develops a base of knowledge to make decisions, and identifies possible methods of dealing with the enemy during scheme of maneuver development.
4. Develop the scheme of maneuver - describes how arrayed forces will accomplish the commander's intent. It is the central expression of the commander's concept for operations and governs the design of supporting plans or annexes. During this step, units are converted from generic to specific types of units (armor, mech, light), and control measures (graphics) to control subordinates units during the operation are selected.
5. Assign headquarters - to groupings of forces, creating a task organization. This assignment should consider the types of units to be assigned to a headquarters and its span of control.
6. Prepare COA sketches and statements - the sketch provides a picture of the maneuver aspects of the COA. Together, the sketch and the statement cover who (generic task organization), what (tasks), when, where, how, and why (purpose) for each subordinate unit, and any significant risks and where they occur for the force as a whole.

Critical Events are those that directly influence mission accomplishment. They include events that trigger significant actions or decisions (commitment of an enemy reserve), complicated actions requiring detailed study, and essential tasks identified during mission analysis.

Decision Points are an event or a location on the battlefield where tactical decisions are required during mission execution.

Distinguishability - One of the four criteria a COA must meet for validity. Each COA must be significantly different from any others.

Feasibility - One of the four criteria a COA must meet for validity. The unit must have the capability to accomplish the mission in terms of available time, space and resources.

Military Decision Making Process (MDMP) - A seven step process, including:

- Step 1 - Receipt of the Mission
- Step 2 - Mission Analysis
- Step 3 - **COA Development**
- Step 4 - **COA Analysis (Wargaming)**

Step 5 - **COA Comparison**

Step 6 - COA Approval

Step 7 - Orders Approval

Rehearsals - the act or process of practicing an action in preparation for the actual performance of the action. Rehearsing key combat actions allows participants to become familiar with the operation and to translate relatively dry recitation of the tactical plan into visual impression. This visual impression helps them orient themselves to both their environment and other units during the execution of the operation. The repetition of combat tasks during the rehearsal leaves a lasting mental picture of the sequence of key actions within the operation.

Suitability – One of the four criteria a COA must meet for validity. It must accomplish the mission and comply with the commander's guidance.

Terrain Visualization - Actually, not a part of COA Development, but is actually a part of Mission Analysis. However, as stated above, you cannot properly do COA Analysis without visualizing the terrain. For the purposes of Automated COA Tools, Terrain Visualization is much more than placing a digitized map background on a computer screen. This should be obvious to even the most casual observer. Terrain Visualization is the ability to conduct terrain analysis in a usable format on available hardware/software, and includes, but is not limited to, data on vegetation, surface transportation and traffic density, soil and drainage, terrain slope, obstacles, cross-country movement, groundwater, cover and concealment. This comes directly from the MCS User Functional Description (UFD), dated March 1994. In short, you are looking at the ability to determine restricted or unrestricted (go-no go) terrain, avenues of approach, weapons line-of-sight (LOS) analysis, etc.

War Gaming Steps - The staff follows eight steps during the wargaming process (some may not be necessary in an automated environment):

1. Gather the tools (for the wargaming process)
2. List all friendly forces - combat, combat support (CS), and combat service support (CSS) units, paying special attention to support relationships and constraints
3. List assumptions
4. List known critical events and decision points - **Critical Events** are those that directly influence mission accomplishment. They include events that trigger significant actions or decisions (commitment of an enemy reserve), complicated actions requiring detailed study (passage of lines), and essential tasks identified during mission analysis. **Decision Points** are an event or a location on the battlefield where tactical decisions are required during mission execution.
5. Determine evaluation criteria - those factors the staff uses to measure the relative effectiveness and efficiency of one COA relative to other COAs following the wargame. Evaluation criteria change from mission to mission, and should look not only at what will create success, but also at what will cause failure.
6. Select the Wargame method - there are three generally accepted techniques, however, the staff is not limited to just these three. In short, whatever works is fine, as long as it considers the area of

interest and all enemy forces affecting the outcome of the operations. The three generally accepted techniques are: **Belt Technique, Avenue-in-Depth Technique, and Box Technique**

7. Select a method to record and display results - this gives the staff a record from which to build task organizations, synchronize activity, develop decision support templates (DSTs), confirm and refine event templates, prepare plans and orders, and analyze COAs based on identified strengths and weaknesses. There are two generally accepted techniques, however, the staff is not limited to just these two. Again, whatever works. A **Synchronization Matrix** allows the staff to synchronize the COA across time and space in relation to the enemy COA, and allows ready translation into a graphic decision-making product, such as a decision support template, at the conclusion of the wargame process. The **Sketch Note, or Wargame Worksheet** uses brief notes concerning critical locations or tasks.
8. Wargame the battle and assess the results - the commander and staff try to foresee the dynamic of a battle's action and analyze each selected event by identifying the tasks the force must accomplish one echelon down, using assets two echelons down. Identifying the COA's strengths and weaknesses allows the staff to make adjustments as necessary. In the wargame process, **Actions** are those events initiated by the side with the initiative (usually the force on the offensive). **Reactions** are the other side's actions in response. **Counteractions** are the first side's responses to reactions. The staff looks at many areas in detail during the wargame, including movement considerations, closure rates, depths of formations, and ranges of weapons systems. Analysis is done by Battlefield Operating System (**BOS**), or, in the automated world, Battlefield Functional Area (BFA). The 7 BOS are: Maneuver, Air Defense, Fire Support, Intelligence, Engineer, CSS, and C2.

DISTRIBUTION LIST

- U.S. Army CECOM, C4IEW Acquisition Center, ATTN: AMSEL-AC-CC-B-CK, Fort Monmouth, NJ 07703-5008
- U.S. Army CECOM, ATTN: AMSEL-RD-C2-BC-CC-2 (V. Rebbapragada), Myer Center, Building 2525, Fort Monmouth, NJ 07703-5603
- U.S. Army CECOM, ATTN: AMSEL-RD-C2-O, Myer Center, Fort Monmouth, NJ 07703-5603
- D. Chapman, ACO; DCMC Pittsburgh, Pittsburgh, PA 15222
- Logica Carnegie Group, 5 PPG Place, Pittsburgh, PA 15222
- Defense Technical Information Center

Appendix 1. Operations Plan used to drive Development Scenario

OPLAN 6099 (MAILED FIST) -- X (US) CORPS

Time Zone Used Throughout the Plan: Sierra.

Task Organization: Annex A (Task Organization).

1. Situation.

A. Enemy Forces. Annex B (Intelligence).

12th Army is opposed by the enemy 1st Front, consisting of the 3rd and 6th Armies and the 16th Praetorian Guards Armored Division, the Front's only operational reserve. Both armies of the front have been badly attrited in offensive operations against our defenses. The 3rd Army is at approximately 30% strength and in hasty defense; 6th Army is at approximately 60% strength and also has reverted to the defense. The 16th Praetorian Guards Division remains uncommitted in sector and occupies an assembly area 60 kms behind 6th Army to the north and is at 95% strength. All indications are that the 1st Front will continue to defend until reinforcements can replenish its offensive capability.

B. Friendly Forces.

(1) 12 AG Commander's Intent: The 12th Army will conduct offensive operations in zone in order to destroy the 1st Enemy Front, seize the port city of San Luis Obispo, and continue offensive operations north toward the enemy's capital city of Monterrey. To accomplish this, 12 AG will conduct a double envelopment to encircle and destroy the 3rd and 6th Armies, exploit to seize the port city of San Luis Obispo, and prepare for continued offensive operations north along the coast.

(2) 16th US Corps to the south, will conduct offensive operations in zone in order to fix elements of the 1st Tank Corps and prevent any shift of forces north or withdrawal to the west.

(3) 5th US Corps to the north will conduct the 12 AG's main effort in zone. The 5 (US) Corps, as the AG main effort initially, will destroy or drive enemy formations into our defenses by continuing offensive operations southward to reduce the pocket. 5th Corps will penetrate the enemy's 6th Army, destroy the 16th Praetorian Guards, and link-up with 10 US corps in order to encircle and destroy the 3rd and 6th Armies in subsequent operations.

(4) 3rd US Corps as the 12 AG reserve will follow 5th US Corps in zone, exploit deep into enemy territory to seize the port of San Luis Obispo, and prepare to continue operations north along the coast as the AG's subsequent main effort.

2. Mission.

10th (US) Corps conducts offensive operations in zone in order to penetrate the enemy 3rd Army, seize objective Skull, establish hasty defense, links up with 5th (US) Corps, and defeat remaining enemy formations in subsequent defensive operations. % 10th Corps will exploit to the coast protecting the 3rd US Corps flank and revert to AG reserve vic San Luis Obispo.

3. Execution.

Intent. Our purpose is to fix the bulk of enemy forces in zone, penetrate the 3rd Army southern flank, and exploit to favorable defensive positions in the enemy's rear. Once link-up with 5th US Corps is achieved, we will destroy all elements of 1st Front formations caught in the AG's encirclement through defensive operations. Once this operation is complete, the corps will reorient west, exploit to the coast, occupy AA VICTORY as the 12 AG reserve, and prepare for subsequent offensive operations to the north.

A. Concept of the Operation. Annex C (Operations overlay).

(1) Maneuver. This is a two-phased operation.

a. Phase I. The 10th US Corps will attack in zone with three divisions abreast. In the north, the 88th and 103rd Divisions will fix enemy forces, and prevent their early withdrawal west. In the south, the 52nd Division as the Corps main effort will destroy the 63rd Division in zone, seize objectives Rhino and Skull, establish hasty defense and revert to defensive operations. 49th Armored Division will follow and support the 52nd in zone, assuming defensive responsibility northwards from PL Wolf to the original LD. Deep operations will be conducted against Army and Front C2 elements in zone by elements of 8th Air Force. 197th Separate Infantry Brigade (M) will be 10th Corps reserve. 203rd ACR will perform security operations to the south screening the corps boundary from elements of the enemy's 1st Tank Corps should it attempt to move north. 10th CAB will perform as corps TCF.

b. Phase II. After the destruction of the enemy's 3rd and 6th Armies, 10th US Corps will reorient west and exploit to the coast with two division abreast and two divisions in follow and support. 49th Armored Division as the corps main effort in the south, 52nd (M) Division is the supporting effort in the north. 103rd Division (M) will follow and support the 49th Division in the south, 88th Division (M) will follow and support the 52nd (M) Division in the north. 197th Infantry Brigade (M), corps reserve will follow the 103rd Division in zone. Priority of security operations will remain to the south with 203rd ACR screening the south flank. Deep operations during phase II will be conducted by the 8th Air Force against armored targets of opportunity along the corps southern flank.

(2) Fires. Annex F (Fire Support) Corps fire support priority efforts during Phase I will be the 88th Division in the north. This will serve to deceive the enemy army commander as to the location of our main attack in the south and also pin the 41st and 22nd Divisions in position until our exploitation to Objective Skull can be accomplished. Once Objective Skull is reached, priority of fires will shift the 52nd Division (M). During Phase II,

priority of fires will shift in support of the 203rd ACR security efforts along the 10 Corps south flank.

(3) Counter Air Operations. During Phase I the priority is to the protection of the 52nd and 49th Divisions and their sustainment operations. During Phase II priority of protection will be to the 203rd ACR and 49th Division.

(4) Intelligence. Annex B (Intelligence). Priority of tasks throughout each phase is to chemical indicators and warnings; identification of threat main effort; response to 10 US Corps deception plan; deep operations targeting; commitment of 1st Tank Corps northward; and identification of rear area threats, in that order. During Phase I, intelligence must identify the withdrawal of the 41st and 22nd Divisions; determine whether 1st Front's operational reserve division is moving south; and conduct battle damage assessment of Phase I operations. An essential aspect will be the monitoring of the corps NAIs forward of PL Wolf. During Phase II, intelligence must continue to monitor the 1st Tank Corps activities and maintain the locations of committed divisions, the IMR brigade, and the 1st Tank Corps reserve.

(5) Electronic warfare. Corps EW will augment implementation of the corps deception plan through all phases of the operation. During Phase I, EW assets will assist in the delay of the northern divisions and destruction of the southern 3rd Army division. Targeting priorities are to disruption of ADA, artillery, and Headquarters C2.

B. Tasks to Maneuver Units.

(1) 52d Division (M).

a. Phase I.

1. Provide 1 BN of AH-64 helicopters to augment Corps TCF.
2. Attack and destroy enemy 63rd Division east of PL Snake.
3. Destroy 1st Royal Guards Tank Regiment in zone.
4. Seize OBJS Rhino and Skull in that order.

5. Assist forward movement of 203rd ACR in zone.
6. Ensure link-up with 5 (US) Corps vic OBJ Skull.
- b. Phase II.
 1. Defend in sector from NA 200300 to NB 235123.
 2. % continue offensive operations west in zone as the corps supporting effort.
- (2) 49th Armored Division.
 - a. Phase I. Follow and support 52nd Division (M) in zone.
 - b. Phase II.
 1. Defend in sector from 235125 to 550093.
 2. % continue offensive operations west in zone as Corps main effort.
 3. 103rd Infantry Division (M).
 - (a) Phase I.
 - (1) Attack and fix enemy 22nd Infantry Division in position.
 - (2) Establish defensive positions along PL Snake.
 - (3) Provide 1 Inf Bn to 10 CAB for TCF operations.
 - (b) Phase II. % conduct follow and support operations for 49th Armored Division in zone.
 4. 88th Infantry Division (M).
 - (a) Phase I.
 - (1) Attach and fix enemy 41st Infantry Division in position.
 - (2) Establish defensive positions along PL Snake.
 - (b) Phase II. % conduct follow and support operations for 52nd Division (M) in zone.

5. 197th Infantry Division (SEP).

(a) Phase I. Corps reserve.

(b) Phase II.

(1) Corps reserve.

(2) % follow 203rd ACR in zone.

(3) Be prepared to conduct defensive operations

against 1st Tank Corps along Corps southern boundary.

6. 10th AVN Bde.

(a) Phase I. Conduct TCF operations against Army and Front Special Operations troops in zone.

(b) Phase II. % support 103rd and 88th Divisions in clearing the corps zone of bypassed enemy forces of company-size or larger.

7. 203rd ACR.

(a) Phase I.

(1) Conduct rear area security operations in coordination with 10th AVN Bde.

(2) Screen corps southern flank from PL Wolf to 12 AG LOA.

(3) Ensure link-up with 5th US Corps along 12 AG LOA.

(b) Phase II. Screen Corps southern flank.

C. Tasks to Combat Support Units.

(1) Fire Support. Annex F (Fire Support).

a. Air Support.

1. BAI and TAR. Corps will retain control of all BAI and S&R allocations. Corps anticipates 25 BAI and 10 TAR sorties daily, D-day through D+3; 40 BAI and 10 S&R sorties daily D+4 through D+6. BAI missions allocated after D+3 will be used to isolate the 2 Corps from other army assets and supplies.

2. CAS (allocations for planning purposes).

	D-day	D+1	D+2	D+3	D+4	D+5	D+6
52d Mech Div	40	40	40	20	10	10	10
88 th Mech Div	10	10	10	10	10	10	10
103 rd Mech Div	10	10	10	20	30	30	30
49 th Armd Div	10	10	10	20	30	30	10
197 th Sep Inf Bde (M)	0	0	0	20	30	30	0
10 th Avn Bde	0	10	10	10	10	10	10
209 th ACR	0	10	30	20	30	30	30
Corps control	10	10	30	10	50	40	40
TOTAL	80	100	140	130	200	190	140

b. Chemical.

c. FA Support.

(1) General. Organization for combat. Annex A (Task Organization).

(2) Phase I.

(a) 545th and 710th FA Bdes will move to AOs STRANGE and CHARM respectively. Be prepared to conduct operations NLT H+24.

(b) Fires will be planned in corps-designated TAIs.

The decision to implement these fires will be based on actions at corps NAIs and DPs as reflected on corps DST.

(c) X (US) Corps Arty is responsible for interdiction and SEAD planning and execution in Phases I and II beyond PL Wolf.

(d) 203rd ACR and 197th Inf Bde (M) are responsible for counterfire.

(e) 52d Mech DIVARTY will clear all fires west of PL Wolf and forward of LOA with 10 Corp Artillery.

3. Phase II.

(a) 545th FA Bde will occupy AO HIDE, GS to X (US) Corps. 00, 710th FA Bde will occupy AO SPACE to reinforce 49th Armd DIVARTY.

(b) 1003rd FA Bde GS to X (US) Corps positioned within 197th Sep Inf Bd (M) AO; 00, follow 197th Bde in zone.

(c) 203rd ACR and 197th Sep Inf Bde (M) are responsible for counterfire.

(2) Air Defense. See Annex G (Air Defense).

a. Organization for combat. See Annex A (Task Organization).

b. Missions. See paragraph 3, Basic Order.

c. Priorities for protection.

1. Phase I. Priority for protection will be the 52d and 49th Divisions, C2, and field artillery.

2. Phase II. Priority of protection will be to C2, MSRs, and corps and division logistics support.

(3) Chemical. See Annex J (Chemical).

a. Phase I. Priority of chemical support initially will be to the 52d and 49th Divisions during the attack and subsequent defense. Priority of decontamination will be to C2, field artillery, and engineers, in that order.

b. Phase II. Priority of chemical support during the exploitation to the coast will be to the 203rd ACR, 49th Armored Division, and 197th Inf Bde. Priority of decontamination will be to army aviation, field artillery, and C2.

(4) Engineer. See Annex D (Engineer).

a. Phase I. Priority of engineer effort will be initially to mobility, then force protection for the 52d and 49th Divisions.

b. Phase II. Priority of work during the exploitation will again be mobility then to force protection for the 203 ACR, then the 49th Armored Division.

(5) IEW. See Annex B (Intelligence and Electronic Warfare).

a. Intelligence. See Annex B (Intelligence).

1. Phase I. During Phase I priority of intelligence collective efforts will concentrate on the activities and intentions of the 22nd and 42nd Divisions.

2. During Phase II priority of intelligence collection efforts will shift to the 1st Tank Corps and other potential threats to the 10th Corp southern flank.

b. Electronic warfare. Priority of corps joining efforts will be against 3rd Army C2 and any army rocket artillery units and to enemy reserve moving into zone.

c. Unmanned Aerial Vehicles. UAVs will be employed in security efforts along the corps southern flank and along the corps planned axis of advance during Phase II.

d. Miscellaneous.

1. Coordinating instructions * * * .

2. CSR * * * .

3. Unexpended ordnance will be jettisoned into corps free fire areas.

D. Coordinating Instructions.

(1) This plan is effective for planning on receipt and implementation on order.

(2) Phase line Snake is LOA during Phase I for 103rd and 88th Divisions.

(3) CCIR.

a. PIR.

1. Phase I.

(a) How is the threat reacting to the corps deception plan?

(b) Is the threat preparing to use chemical weapons?

2. Phase II.

(a) Where are the 1st Tank Corps lead divisions?

(b) What are the disposition and strength of the two remaining first-echelon divisions of 3rd Army?

(c) What are the location and disposition of the Praetorian Guards Tank Division?

(d) Where are the SSM units, the indep hel regt, and the heavy lift regt?

(e) Will 1st Tank Corps units turn north to attack the 10th Corps flank?

b. EEFI.

1. The attack plans of 52nd Inf Div (M) and 85th Inf Div (M).

2. Composition and disposition of forces in AOs STRANGE

and CHARM.

(4) Air defense weapons status is TIGHT.

(5) When the 52d Inf Div (M) seizes OBJ Skull, east-west grid line 34 will become a corps NFL/LOA.

(6) Priority of road movement.

a. Phase I. 52nd Div (M), 103 Inf Div (M) and 88th Inf Div (M).

b. Phase II. 203rd ACR, 49 Armd Div, and 52nd Inf Div (M).

(7) Annex L (Deception).

(8) MOPP.

a. Phase I. Level 1: 203rd ACR, 52nd Div (M), 10th Avn Bde, 105th and 88th Div (M) FA Bdes. Level 0: Remainder of corps.

b. Phases II and III: Level 0.

(9) Troop-safety criteria.

a. Phase I: negligible risk to unwarned exposed personnel.

b. Phase II and III: negligible risk to warned exposed personnel.

(10) Corps FSCL in Phase I is PL ARGON. Phase II is PL X-RAY.

4. SERVICE SUPPORT.

A. Concept of Support. 10th COSCOM must accept risk with support units to provide continuous support to X (US) Corps deep operations. Support operations will require extensive use of all transportation modes and emergency augmentation by aerial resupply with 10th Avn Bde assets. 10th COSCOM will coordinate integration of available coalition support forces into traffic circulation plans and provide fuel, medical, transportation and limited ammunition support as required.

(1) Support during Phase I. Initial priority of support is to 10th Avn Bde, FA Bdes, and 52nd Div and 88th Div, in order. All units will limit repairs to 24 hours or request

ground evacuation assets to establish maintenance collection points. Priority of evacuation to MLRS, howitzers, and tanks, in order. COSCOM will establish MSRs to corps forward bases. Priority of shipments is cl V, III, IV and IX, in order. Unit distribution of supplies will be made to RSA, FAAs 1 and 2, AO CHARM, and AO STRANGE. Air medical evacuation of URGENT patients to corps medical facilities. Support to corps TCF units will be provided by 14th CSG.

(2) Support during Phase II. 10th COSCOM initial priority of support is to 49th Armd Div as the main effort, 203rd ACR, 10th Avn Bde, Corps FA Bdes, and 52nd Inf Div (M). %, 14th CSG will echelon support forces forward to continue support to corps FA bdes and 10 CAB as they deploy forward.

(3) Support After the Operation. 13th CSG will continue support to 49th Armored Division. 14th CSG continues support to 52nd Mech Division and 203rd ACR and corps FA bdes. 15th CSG will assume support mission for remaining corps units reconstituting north of PL MASS. Priority of reconstitution effort is to 203rd ACR, 49th Armd Div, and 10th Avn Bde, in order. Priority of effort is to prepare to support continued offensive operations to the north.

B. Annex Q (Service Support).

5. COMMAND AND SIGNAL.

A. Command.

(1) Phase I.

a. Rear CP at Las Vegas (NA660170).

b. TAC CP will control the battle forward of LD and north of PL

XENON. TAC CP at BAKER (US4278); alternate at JEAN (PB3092).

c. Main CP will control the units south of PL XENON. Main CP at

TIPTON (PB199459); alternate at JEAN (PB3092).

(2) Phase II.

a. Rear CP at Bakersfield (NA650150).

b. TAC CP will control the battle forward of PL LIGHT and north of

PL XENON. TAC CP location initially at BAKER (US4278); 00 TAC CP will move to TIPTON (PB6521).

c. Main CP initially at DELANO (PB2045). After TAC has completed its move to TIPTON, the main will move to SONDERHAUSEN (PB3092).

(3) Succession of Command: deputy corps commander, 52nd Mech Div Cdr, 49th Armd Div Cdr, 103rd Div Cdr, in order.

B. Signal.

(1) X (US) Corps SOI INDEX 102 in effect.

(2) Commanders and staff at battalion level and above will maximize the use of MSE communications and minimize use of FM communications to higher and lateral headquarters.

ACKNOWLEDGE.

Hensel

LTG

OFFICIAL:

GREETHAM

G3

Annexes: A--Task Organization
B--Intelligence
C--Operation Overlay
D--Engineer
F--Fire Support
G--Air Defense
J--Chemical
Q--Service Support

ANNEX A Task Organization TO Operation Plan (6099) (MAILED FIST) - X US CORPS

PHASE I

52D INF DIV (M)
1002 BN (MLRS) 1003 FA BDE

103RD INF DIV (M)
710 FA BDE
2D BN (MLRS) 718 FA
2D BN (MLRS) 719 FA
2D BN (155 SP) 731 FA
2D BN (155 SP) 732 FA
2D BN (155 SP) 733 FA

508TH ENGR CBT BN (CORPS)
334TH NBCE
501ST CA TAC SPT CO

88TH INV DIV (M)
545 FA BDE
2D BN (MLRS) 541 FA
2D BN (MLRS) 542 FA
2D BN (155 SP) 561 FA
2D BN (155 SP) 562 FA
2D BN (155 SP) 563 FA

509 ENGR CBT BN (CORPS)
333D NBCE
500TH CA TAC SPT CO

20TH MI BDE

201ST MI BN (AERIAL XPLT)
211TH MI BN (TAC XPLT)
221ST MI BN (OP)

49TH ARMD DIV
197TH SEP INF BDE (M)
203RD ACR

CORPS ARTY
1003 FA BDE MLRS
1001 BN (MLRS) 110 FA
1003 BN (MLRS) 110 FA
1004 BN (MLRS) 110 FA

CORPS TRPS
10TH CBT AVN BDE
1 BN (ATTK) 52 AVN BDE
1 BN 22 IN 103 ID (M)

142 AIR DEFENSE BDE
1ST BN (PATRIOT) 430 ADA
2ND BN (PATRIOT) 430 ADA
3RD BN (PATRIOT) 430 ADA

506 ENGR BDE
510 ENGR CBT BN
550 ENG CBT BN (HV)
5000 ENGR TOPO CO
5035 ENGR PNL BRG CO
5070 ENGR MAB CO
5071 ENGR MAB CO
5080 ENGR CBT SPT EQUIP CO

1042ND PSYOPS BN
62ND FIN GRP

89TH PERS GRP

10TH COSCOM

CADET Final Scientific and Technical Report - March 1997 - February 2000

222 ND MP BDE	13 CSG
270 TH MP BN	14 CSG
271 ST MP BN	15 CSG
272 ND MP BN	

644TH SIG BDE

- 700TH SIG BN (CO) (CORPS)
- 704TH AREA SIG BN
- 705TH AREA SIG BN
- 706TH AREA SIG BN
- 707TH AREA SIG BN
- 712TH SIG BN (RDO)
- 756TH SIG BN (CABLE)

133TH CHEM BDE

16TH CA BDE

PHASE II

52D INF DIV (M)

710 FA BDE

2D BN (MLRS) 718 FA

2D BN (MLRS) 719 FA

2D BN (155 SP) 731 FA

2D BN (155 SP) 732 FA

2D BN (155 SP) 733 FA

508TH ENGR CBT BN (CORPS)

334TH NBCE

501ST CA TAC SPT CO

49TH ARMD DIV

545 FA BDE

2D BN (MLRS) 541 FA

2D BN (MLRS) 542 FA

2D BN (155 SP) 561 FA

2D BN (155 SP) 562 FA

2D BN (155 SP) 563 FA

509 ENGR CBT BN (CORPS)

333D NBCE

500TH CA TAC SPT CO

88TH INV DIV (M)

203RD ACR

197TH INF BDE (M) (SEP)

510 ENGR CBT BN

CORPS ARTY

1003 FA BDE MLRS

1001 BN (MLRS) 110 FA

1002 BN (MLRS) 110 FA

1003 BN (MLRS) 110 FA

1004 BN (MLRS) 110 FA

CORPS TRPS

10TH CBT AVN BDE

142 AIR DEFENSE BDE

1ST BN (PATRIOT) 430 ADA

2ND BN (PATRIOT) 430 ADA

3RD BN (PATRIOT) 430 ADA

506 ENGR BDE

550 ENG CBT BN (HV)

5000 ENGR TOPO CO

CADET Final Scientific and Technical Report - March 1997 - February 2000

5035 ENGR PNL BRG CO
5070 ENGR MAB CO
5071 ENGR MAB CO
5080 ENGR CBT SPT EQUIP CO

1042ND PSYOPS BN

20TH MI BDE

201ST MI BN (AERIAL XPLT)

211TH MI BN (TAC XPLT)

221ST MI BN (OP)

62ND FIN GRP

89TH PERS GRP

10TH COSCOM

222ND MP BDE

270TH MP BN

271ST MP BN

272ND MP BN

13 CSG

14 CSG

15 CSG

644TH SIG BDE

700TH SIG BN (CO) (CORPS)

704TH AREA SIG BN

705TH AREA SIG BN

706TH AREA SIG BN

707TH AREA SIG BN

712TH SIG BN (RDO)

756TH SIG BN (CABLE)

133TH CHEM BDE

16TH CA BDE

Appendix 2. Division OPORD used for Scenario Development

Copy 1 of 43 Copies
HQ, 52nd MECH DIV
Zzyxx, California
12 1200 JUN 9X

OPORD 9X-06-01

Reference: Maps USACGSC Specials, Ft Irwin (West), and Ft. Irwin (East), Sheets 2654 IV and 2654 I, Edition 21 FEB 1989, 1:50:000

Time Zone Used Throughout Order: Sierra

Task Organization: See Annex A (Task Organization)

1. SITUATION.

A. Enemy forces. (See Annex B, Intelligence)

(1) Enemy Order of Battle: 52nd Division is directly opposed by the 63rd Inf DIV. Regimental-sized remnants of the 23rd and 41st Inf DIV are defending to the north of the 63d Inf DIV. An unidentified enemy infantry division from the enemy 10th Tank Corps is defending to the south. The 1st Royal Guards ITR (minus) is in our zone of action, approximately 45 kilometers behind the current LC.

(2) Strength and Recent Activities:

63d Inf DIV Approximately 30% strength. It is defending with two regiments abreast, one blocking the I-15 approach to Barstow and one the Red Pass approach to the Fort Irwin cantonment area. These two light infantry regiments are at approximately 30% strength. The 63rd Infantry Division has a battalion-sized reserve force in the center of its sector, east of Red Pass Lake. This reserve is close to 100% strength. These three units constitute all

the maneuver forces of the 63rd Inf DIV. The 63rd Inf DIV is improving its defensive positions, but is currently in a hasty defense.

1st Royal Guards ITR (-) Strength is believed to be 30% +. This unit appears to be postured to act as a counterattack force. It is likely to be committed to support the defense of the 63rd Inf DIV.

B. Friendly Forces.

(1) X Corps:

a. Mission: X Corps conducts offensive operations in zone in order to penetrate the enemy 3rd Army, seize Objective Skull, and destroy remaining enemy formations in subsequent defensive operations. O/O X Corps will exploit to the coast, protecting the III Corps flank and revert to AG reserve vic San Luis Obispo.

b. Commanders Intent: Our purpose is to fix the bulk of enemy force in zone, penetrate the 3rd Army southern flank, and exploit to favorable defensive positions in the enemy's rear.

c. Once link-up with V Corps is achieved, we will destroy all elements of 1st Front formations caught in the AG's encirclement through defensive operations. The V Corps, the 12th AG initial main effort, will destroy or drive enemy formation into our defenses by continuing offensive operations southward to reduce the pocket. Once this operation is complete, X Corps will reorient west, exploit to the coast, occupy AA Victory as the 12th AG reserve, and prepare for subsequent offensive operations to the north.

(2) 203rd ACR conducts security operations on the 52nd MECH DIV's southern flank and maintains contact with the XVI Corps.

(3) 103rd Division conducts offensive operations to the north to fix enemy forces and prevent their withdrawal to the west.

(4) 49th Armored Division follows and supports the 52nd MECH DIV's attack.

(5) 8th USAF supports 52nd MECH with 40 sorties daily.

C. Attachments and Detachments.

(1) 1-1 AHB is detached to X Corps effective 12 1800 JUN 9X.

(2) 1st BDE is OPCON to 103rd DIV effective 13 0700 JUN 9X until 15 0200S JUN 9X. See Annex I (Deception).

2. MISSION.

52nd MECH DIV attacks to destroy enemy 63rd Inf DIV and 1st Royal Guards Tank Regiment at 15 0430S JUN 9X in zone between PL Snake and PL Wolf to envelope enemy elements to the north. O/O, 52nd MECH DIV continues attack to secure OBJ Skull to complete the envelopment.

3. EXECUTION.

INTENT: To be successful in this operation, 52nd MECH DIV must rapidly destroy enemy forces in zone then move to secure OBJ Skull in time to trap enemy forces to the north. The division must end this operation on OBJ Skull, defending to the north; tied in to the 49th AD to the east; and postured to quickly transition back to the offense to continue the attack to the west.

A. Concept of the Operation. See Annex C (Operations Overlay).

(1) Maneuver. This is a four-phase operation:

a. Phase I. The division attacks with two brigades abreast to destroy enemy forces in zone to PL Snake. 2nd BDE is the division main effort. 52nd AVN BDE attacks to defeat 1st RTR in AA Vil NK 300 020. 1-4 CAV is initially the division TCF. 2nd BDE is responsible for the divisions's southern flank. Phase I ends when 1st BDE clears the I-15 corridor, so as to enable the forward passage of the 1st BDE.

b. Phase II. This phase begins with the forward passage of 1st BDE through 2nd BDE. The 1st BDE becomes the division main effort and attacks on Axis Bull to complete the destruction of 1st RGR in EA Hog. 52nd Avn Bde supports the destruction of 1 RTR in EA HOG. The 2nd and 3rd BDE continue to clear in zone. 1-4 CAV begins to screen the

division's right (north) flank and maintains contact with the 103rd Division. The division accepts risk and has no reserve or TCF in this phase. Phase II ends with the destruction of 1st RTR in EA Hog.

c. Phase III. This phase begins with the resumption of the division's attack to the west. O/O boundary between 1st and 2nd BDE goes into effect at the beginning of Phase III. 1st BDE continues as the division's main effort and attacks in zone to secure OBJ Bear. 2nd BDE attacks in zone to secure OBJ Tiger. 3rd BDE follows 1st BDE and secures OBJ Lion. 52nd AVN BDE assumes responsibility for the division's right (north) flank. 52nd AVN BDE screens from the LD to PL Wolf, facilitates the forward movement of the 49th AD, and coordinates the turnover of the sector from the LD to PL Wolf. 1-4 CAV assumes division reserve. Phase III ends when OBJ Tiger, Bear, and Lion are secured.

d. Phase IV. This phase begins as the division transitions to a the defense, oriented to the north, to contain enemy forces and assist in their destruction by the 103rd and 88th DIV. 1st BDE continues as the 52nd DIV main effort. 1-4 CAV becomes the division TCF. 52nd AVN BDE is the division covering force. 2nd Bde assumes division reserve.

(2) Fires. See Annex F (Fire Support).

a. Concept of Fire Support. Fire support for the division must accomplish two critical tasks: 1) attrit the 1 RTR by 30% in order to disrupt the enemy's ability to effectively counterattack our brigades and 2) with close air support, attrit the 63rd Division in order to fix the enemy in position so that the brigades can focus on their destruction in the close fight. To accomplish this, DIVARTY will attack to attrit the division reserve 30%. Army attack aviation in concert with artillery will attack to attrit 1st Royal Guard Tank REGT by 40% in its assembly area. As the enemy division defends, artillery will shift to attrit the forward regiments as required. DIVARTY has responsibility for counterfire. DIVARTY will develop ingress and egress SEAD plans for all aviation attacks in zone.

b. Priority of Fires.

[1] Phase I. Initially to 52nd AVN Bde during deep attacks, then upon LD priority 2nd Bde, 3rd BDE, then 1st Bde upon commitment in order. Counterfire priorities: DAG, jammers, FACP/OPs and FAC3 cells. The division retains 20 air sorties to attack the 1st RTR in EA HOG and conduct SEAD.

[2] Phase II. No change from Phase I.

[3] Phase III. Priority of support to division main effort, 1st Bde.

[4] Phase IV. Priority of support to Div CF; 52nd Av Bde.

c. Allocation (Annex D, Fire Support).

d. Restrictions. Both COPPERHEAD and artillery delivered

FASCAM are in short supply. Release authority for FASCAM is retained at division level. 1st and 3rd Brigades are allocated two FASCAM minefields for planning purposes within their zones during Phase IV.

B. Tasks to Maneuver Units

(1) 2nd Bde. (Division main effort initially)

a. Phase I

[1] Attacks in zone (1504305 Jun 9X) to destroy the 2nd Regt 63rd Division.

[2] Seizes Obj RHINO in zone.

[3] Assumes hasty defense of PL SNAKE.

[4] Clears axis BULL of plt sized units and EN AT weapons.

[5] Coordinates and establishes a minimum of two passage points in zone with 1st Bde.

b. Phase II. Support the forward passage of lines of 1st Bde

c. Phase III. (Supporting effort)

[1] o/o, resume the attack in zone as division supporting effort.

CADET Final Scientific and Technical Report - March 1997 - February 2000

- [2] Seize Obj TIGER.
- d. Phase IV. (Reserve)
 - [1] Division reserve.
 - [2] o/o continue the attack west as Division supporting effort.
- (2) 3rd Bde (Division supporting effort initially).
 - a. Phase I.
 - [1] Attack in zone 1504305 Jun 9X to destroy the 1st Regt 63rd Division.
 - [2] Seize Obj RHINO in zone.
 - [3] Assume hasty defense at PL SNAKE.
 - [4] Clear I-15 corridor of EN plt sized units and EN AT weapons.
 - b. Phase II. No change.
 - c. Phase III. (Follow and support)
 - [1] Upon commitment of 1st Bde, assume follow and support role in 1st Bde zone.
 - [2] Seize Obj LION.
 - d. Phase IV.
 - [1] Defend from NK203 209 to NK234118.
 - [2] o/o, continue the attack to the west as the division main effort.
- (3) 1st Bde (Reserve initially).
 - a. Phase I (Division reserve).
 - b. Phase II (Division main effort)
 - [1] o/o conduct a forward passage of lines through 2d Bde along Axis BULL and assume the Division main effort.
 - [2] Destroy the 1st Royal Guards Tank Regt vic EA HOG.

CADET Final Scientific and Technical Report - March 1997 - February 2000

- c. Phase III. o/o resume the attack in zone and seize Obj BEAR.
 - d. Phase IV.
 - [1] Defend from NK233239 to NK203209.
 - [2] o/o follow Division main effort in zone as Division reserve.
- (4) 52nd Avn Bde.
- a. Phase I. Conduct deep operations to defeat 1st RTR in its AA vic
NK300 030.
 - b. Phase II. Support 1st Bde's destruction of 1 RTR in EA HOG.
 - c. Phase III.
 - [1] Assume responsibility for screening the Division north flank from LD to PL WOLF from 1-4 CAV.
 - [2] Facilitate the forward movement of 49 AD in zone.
 - [3] Coordinate and turnover 52nd Division sector responsibility from LD to PL WOLF to 49 AD.
 - d. Phase IV.
 - [1] Division covering force.
 - [2] o/o be prepared to conduct advanced guard operations during the attack west.
- (5) 1-4 CAV.
- a. Phase I. Division TCF.
 - b. Phase II.
 - [1] Screen the division north flank from division LD to PL SNAKE.
 - [2] Maintain contact with elements of the 103rd Division to the north.
 - c. Phase III.

CADET Final Scientific and Technical Report - March 1997 - February 2000

[1] Coordinate and relinquish security responsibility for the division north flank to 52 Avn Bde.

[2] Assume Division reserve.

d. Phase IV.

[1] Assume Division TCF.

[2] o/o be prepared to operate as part of 52nd Avn Bde in the advance guard during subsequent offensive operations.

C. Tasks to Combat Support Units.

(1) Air Defense. Phases I-IV (Annex G). Priority of protection to maneuver forces, Class III logistical sites, and C2 facilities.

(2) Chemical. Phases I-IV (Annex F). Priority of effort to reconnaissance and avoidance; then to decontamination.

(3) Engineer Support. (Annex H). During Phases I-III priority of effort to mobility and survivability. During Phase IV priority of effort to countermobility and survivability in that order.

(4) Fire Support (Annex D).

(5) Intelligence and Electronic Warfare (Annexes B and E, Intelligence and Electronic Warfare). During Phases I and II priority of effort to support of deep operations against 1st RTR. During Phases III and IV priority to the location of reconnaissance, C2, radars, artillery and rocket firing units. Provide early warning of impending attack.

(6) Military Police (Annex K). During Phases I-III priority of effort to EPW collection and battlefield circulation control. During Phase IV priority of effort to security against Levels I and II threats to rear area operations, terrorism, operations, and law enforcement.

D. Coordinating Instructions.

(1) OPCODE 9X-06-01 is effective for execution upon receipt.

(2) SAFETY (Annex M). Troop safety is negligible risk to warned, exposed personnel.

CADET Final Scientific and Technical Report - March 1997 - February 2000

- (3) Operational Exposure Guide. Do not exceed moderate risk to unwarned, exposed troops (RES-O).
 - (4) MOPP O in effect. MOPP status may be upgraded at discretion of commanders.
 - (5) PIR (Annex B - Intelligence).
 - (6) Anti-terrorism Actions (Annex K).
 - (a) Units: Continue to stress OPSEC at every level of operation.
 - (b) 52d MI: Collect and disseminate timely and accurate intelligence concerning potential or actual 3rd Army threat. Identify security vulnerabilities.
 - (7) Line of Departure (LD).
 - a. LD is LC 1504305 Jun 9X.
 - b. Scouts are authorized to cross LD NET 150330 Jun 9X.
 - (8) Fire Support Coordination Measures.
 - a. 52nd ID (M) CFL is initially PL WOLF effective 15 1430 Jun 9X.
 - b. X (US) Corps NFL is east west grid line 34.
 - (9) Use of lift aviation assets authorized within forward Brigade zones upon coordination with DTAC under constraints improved by A2C2 plan. All Brigade requests for aviation support are due to division NLT 12 hours prior to required execution time.
 - (10) Bdes and separate TFs/BNs must provide DTAC completed Brigade and Task Force orders and graphics NLT 13 1200 Jun 9X.
 - (11) Brigades are responsible for countering all Level III threats within their zones of action.
4. SERVICE SUPPORT (Annex J, Service Support).
- A. Priority on WEST-bound MSR is to CL III then CL V. EAST-bound traffic priority is to casualty evacuation. Priority of support to Division main effort.
 - B. Division MSR is ARNHEM-IWO JIMA.

5. COMMAND AND SIGNAL.

A. Command.

- (1) Division Main CP located at NK 070880. Future location: NK 070190.
- (2) Division TAC CP located at NK 980800. Future location: NK 138162.
- (3) Rear CP. Location: NK 950070. Alternate CP is DIVARTY TOC.

Location: NK 070140.

B. Signal (Annex I, Communications/Electronics).

- (1) SOI 95-02, Special Edition (TBP) in effect.
- (2) Red star cluster and red smoke are used for emergency situations only.

Acknowledge

LAPORTE
BG

OFFICIAL:

WATERS
ASST G3

ANNEXES: A - Task Organization
B - Intelligence
C - Operations Overlay
D - Fire Support
E - Electronic Warfare
F - NBC Support
G - Air Defense
H - Engineer
I - Communications/Electronics
J - Service Support
K - Traffic Control Plan and Rear Area Operations
M - Troop Safety

Appendix 3. Scenario # 1 - Conventional Warfare

SCENARIO #1 CONVENTIONAL WARFARE 10TH CORPS PENETRATION, EXPLOITATION, AND TURNING MOVEMENT

MISSION/CONCEPT OPS: 52d DIV (M) conducts a deliberate attack as the 10th Corps main effort to seize Obj Rhino in zone. % DIV continues the attack in zone, destroys EN Army reserve, exploits to seize Obj Skull, blocks the withdrawal of EN divisions.

ENEMY: EN Infantry Division in zone is at 30 percent strength, with low morale and capable of only hasty defenses. EN Tank Regt., the Army reserve is at 30 percent strength.

TROOPS: 52d DIV (M) is at 100 percent strength with one corps MLRS Bn attached. The 52d Avn Bde has been detached for use at the 10th Corps TCF.

TERRAIN: The terrain of the area of operations is desert terrain. All zones in this operation have some slow go mountainous terrain features but are readily bypassed by numerous high-speed mobility corridors and open areas.

REFERENCES: Wargaming calculations computed using the EER document entitled, *Doctrinal Briefing, Formats and Planning Factors*; Appendix G.

Appendix 4. Scheme Of Maneuver Time Line Computations

1. INITIAL FORCE RATIOS AT THE FLOT:

A. 3rd Bde vs 1st EN Regt = 3:1

- 1st EN Rgt equates to 1 Bn on extended frontage with low morale; capability to defend equates to hasty defense
- EN Bn #1 is EN Division reserve. Equates to two companies in capability in hasty defense. 3d Bde will have a force ratio of 4:1.

B. 2nd Bde vs 2nd EN Regt = 3:1 force ratio for the same reasons as above; while the sector is even wider, the enemy in force ratio rises to 4:1.

C. Table 4-11 on p. 4-18 was used to compute maneuver rates of 3rd and 2d Bdes from the FLOT to PL Snake.

2. 1st Bde attack vs Enemy Tank Bn (-) equates to 12 companies versus 2 or a 6:1 ratio; "Negligible Resistance" was used to compute force ratio maneuver speed for this battle. Again table 4-11 on p. 4-18 was used.

3. As Enemy Division is destroyed east of PL Gator maneuver from there to division objectives Bear, Tiger, and Lion were computed as unopposed in slow go terrain.

4. The following maneuver times apply to this operation given the estimates previously described in Para. 1-3:

CADET Final Scientific and Technical Report - March 1997 - February 2000

UNIT	FRO M	TO	DISTANCE	TIME	FORCE RATIO	TYPE OF TERRAIN	TYPE OF RESISTANCE
3 rd Bde (3 Bns)	FLOT	PL Snake	@ 22 kms	6 hrs	3:1	Restrictive	3:1 Heavy
2 nd Bde (3 Bns)	FLOT	PL Snake	@ 16 kms	4 hrs	4:1	Restrictive	4:1 Medium
1 st Bde (4 Bns)	AA	Axis Bull En Tk Regt	@ 4 kms	2 hrs	6:1	Unrestricted	Unopposed
CAV Sqdrn	N/A						
DIVARTY	N/A						
ENGR Bn	N/A						
MI Bn	N/A						
MP Co	N/A						
DISCOM	N/A						

UNIT	FRO M	TO	DISTANCE	TIME	FORCE RATIO	TYPE OF TERRAIN	TYPE OF RESISTANCE
1st Bde (4 Bns)	EN Tk Rgt	PL Gator	@ 15 kms	1 hr	None	Restrictive	16 kmph/ unopposed
2 nd Bde (3 Bns)	PL Snake	PL Gator	@ 26 kms	2 hrs	None	Restrictive	16 kmph/ unopposed
3rd Bde (3 Bns)	PL Snake		DIV Res.	N/A	None	N/A	N/A
CAV Sqdrn	N/A						
DIVARTY	DIV Rear area	PL Gator	@ 40 kms	2 hrs	None	Unrestrictive	Unopposed
ENGR Bn	N/A						

CADET Final Scientific and Technical Report - March 1997 - February 2000

MI Bn	N/A						
MP Co	N/A						
DISCOM	N/A						

UNIT	FROM	TO	DISTANCE	TIME	FORCE RATIO	TYPE OF TERRAIN	TYPE OF RESISTANCE
1st Bde (4 Bns)	PL Gator	PL Wolf	@ 17 kms	2 hrs	None	Restrictive	Unopposed
2 nd Bde (3 Bns)	PL Gator	PL Wolf	@ 25 kms	1 hr	None	Nonrestrictive	Unopposed
3rd Bde (3 Bns)	PL Snake	PL Gator	@ 20 kms	1 hr	None	Nonrestrictive	Unopposed
CAV Sqdrn	PL Snake	PL Gator	@ 20 kms	1 hr	None	Nonrestrictive	Unopposed
DIVARTY	N/A						
ENGR Bn	N/A						
MI Bn	N/A						
MP Co	N/A						
DISCOM	DIV rear area	New DSA	@ 65 kms	½ in 12 hrs	None	Nonrestrictive	Unopposed

UNIT	FROM	TO	DISTANCE	TIME	FORCE RATIO	TYPE OF TERRAIN	TYPE OF RESISTANCE
1st Bde (4 Bns)	PL Wolf	Obj Bear	@ 20 kms	2 hrs	None	Restrictive	Unopposed
2 nd Bde (3 Bns)	PL Wolf	Obj Tiger	@ 21 kms	2 hrs	None	Restrictive	Unopposed
3rd Bde (3 Bns)	PL Gator	Obj Lion	@ 23 kms	2 hrs	None	Restrictive	Unopposed
CAV Sqdrn	PL Gator	Obj Wolf	@ 17 kms	2 hrs	None	Restrictive	Unopposed
DIVARTY	N/A						

CADET Final Scientific and Technical Report - March 1997 - February 2000

ENGR Bn	N/A						
MI Bn	N/A						
MP Co	N/A						
DISCOM	DIV rear area	New DSA	@ 65 kms	½ in 12 hrs	None	Nonrestrictive	Unopposed

Appendix 5. Scenario #2 - Force XXI

SCENARIO #2

FORCE XXI

52nd (M) DIVISION SECURES BATTLESPACE X-RAY

FOREWORD: Unlike AirLand Battle, Force XXI operations seek to address all enemy forces in the AO simultaneously. Force XXI OPS are heavily joint in nature; however, these assets have been included for simplicity's sake. Moreover this operation also assumes weapon capabilities within the 52nd (M) Division that are currently unfielded, as well as organizational capabilities that are untested and unapproved.

MISSION/CONCEPT OPS: 52d DIV (M) attacks H-Hour, D-Day, to simultaneously destroy enemy forces throughout the depth of battlespace X-RAY and secure the battlespace for support of subsequent peacekeeping operations within the Island of Lilliputia.

ENEMY: Lilliputian forces are at 100 percent strength but possess Vietnam era Chinese and Soviet equipment. Enemy forces in battlespace x-ray equate to two infantry brigades widely dispersed for population control and a field artillery brigade.

TROOPS: 52d DIV (M) is at 100 percent strength with one corps MLRS Bn attached. The 52d Avn Bde has been detached for use at the 10th Corps TCF.

TERRAIN: The terrain of the area of operations is desert terrain. All zones in this operation have some slow go mountainous terrain features but are readily bypassed by numerous high-speed mobility corridors and open areas.

REFERENCES: Wargaming calculations computed using the EER document entitled, *Doctrinal Briefing, Formats and Planning Factors*; Appendix G.

Appendix 6. Scheme Of Maneuver Time Line Computations

1. INITIAL FORCE RATIOS WITHIN BATTLESPACE X-RAY AT H-HOUR:

<u>UNIT</u>	<u>TARGET</u>	<u>NUMERAL FORCE RATIO</u>	<u>ADJUSTED FORCE RATIO</u>
1 ST Bde - 3 Bns vs	1 st EN AR Bn	3:1	6:1
2 nd Bde 3 Bns vs	1 st EN INF Bn	3:1	6:1
3 rd Bde 3 Bns vs	2 nd EN INF BN (-) + EN A Co	3:1	6:1
TF Killer 1 Bn	N/A DIV Reserve	N/A	N/A
DIVARTY (+ CAS			
+ MLRS) vs	1 st EN FA Bde	3:1	6:1
AVN Bde (-)			
Commanche vs	2 nd AR Bn	2:1	6:1
JTF (Air/Naval) vs	1 st EN INF Regt (-)	N/A	6:1

A. Force ratio adjustments have been made to account for US superiority in technology, leadership, morale, and CS/CSS. (See Figure D-1 “relative - force ratio” factors.)

B. Friendly maneuver computations (2.3 kmph) were computed using Table 4-11 (p. 4-17); negligible resistance (6:1), restrictive terrain, EN in hasty defense. Combat effects are multiplied X 3 due to substantial surprise (see Note 2, p. 442).

2. The following maneuver times apply to this operation given the projections outlined in para 1 above:

CADET Final Scientific and Technical Report - March 1997 - February 2000

UNIT	FROM	TO	DISTANCE	TIME	FORCE RATIO	TYPE OF TERRAIN	TYPE OF RESISTANCE	REQUIRED START TIME
3 rd Bde (3 Bns)	Staging area (SA)	EN Tgt	@ 24 kms	11 mins	6:1	Restrictive	N/A Air assault	H-11 mins
2 nd Bde (3 Bns)	Staging area (SA)	EN Tgt	@ 14 kms	6 hrs	6:1	Restrictive	Negligible	H-6
1 st Bde (3 Bns)	Staging area (SA)	EN Tgt	@ 12 kms	5.2 hrs	6:1	Restricted	Negligible	H-6
TF Killer (Div Reserve 1 BN)	DSA	New DSA	@ 19 kms	72 hrs	N/A	Restrictive	N/A	H + 30
CAV Sqdrn	DSA	New DSA	@ 19 kms	6 hrs	N/A	Restrictive	Negligible	H - 6
DIVARTY	N/A	N/A	@ 20 kms	N/A	6:1	N/A	Negligible	H - Hour
ENGR Bn	DSA	New DSA	@ 19 kms	2 hrs	N/A	N/A	N/A	H - 4
MI Bn	DSA	New DSA	@ 19 kms	N/A	N/A	N/A	N/A	N/A
MP Co	DSA	New DSA	@ 19 kms	2 hrs	N/A	N/A	N/A	H - 4
DISCOM	DSA	New DSA	@ 19 kms	72 hrs	N/A	N/A	N/A	H + 30
AVN BDE	Staging area (SA)	EN Tgt	@ 30 kms	9 mins	N/A	N/A Attack HELOS	Negligible	H - 9 mins

Appendix 7. Friendly Order of Battle

FRIENDLY ORDER OF BATTLE

10TH US Corps

203rd Armed Cavalry Regiment

49th Armored Division

103rd Infantry Division (M)

88th Infantry Division (M)

52nd Infantry Division (M)----->

10th Aviation Brigade

197th Separate Infantry Brigade (M)

10 Corps Artillery

545 Field Artillery Brigade

710 Field Artillery Brigade

1003 Field Artillery Brigade (MLRS)

506th Engineer Brigade

142nd Air Defense Brigade

644th Signal Brigade

133rd Chemical Brigade

222nd Military Police Brigade

1042nd Psychological Operations Battalion

16th Civil Affairs Brigade

62nd Finance Group

89th Personnel Group

10th Corps Support Command (COSCOM)

52nd Infantry Division (M)

1st Brigade 52 Division (M)

2nd Brigade 52 Division (M)

3rd Brigade 52 Division (M)

1 Battalion 1st Infantry Regiment

2 Battalion 1st Infantry Regiment

3 Battalion 1st Infantry Regiment

1st Battalion 2nd Infantry Regiment

2nd Battalion 2nd Infantry Regiment

1st Battalion 1st AR Regiment

2nd Battalion 1st AR Regiment

3rd Battalion 1st AR Regiment

1st Battalion 2nd AR Regiment

2nd Battalion 2nd AR Regiment

DIVARTY

1st Battalion 1st Field Artillery Regiment
(DS)

2nd Battalion 1st Field Artillery Regiment
(DS)

3rd Battalion 1st Field Artillery Regiment
(DS)

K Btry, 2d Field Artillery (MLRS)

52nd Aviation Brigade

1st Battalion 1st ATTK

2nd Battalion 1st ATTK

27th General Support Aviation Battalion

52d Command Aviation Battalion

1st 4th Cavalry Squadron

52nd MP Co

52nd Chemical Company

52nd Division Support Command

1st FSB

2nd FSB

CADET Final Scientific and Technical Report - March 1997 - February 2000

3rd FSB

4th DASB

52nd MSB

1st Battalion 52nd Air Defense Artillery

52nd Military Intelligence Battalion

52d Engineer Brigade

63rd Engineer Battalion

64th Engineer Battalion

65th Engineer Battalion

1st Signal Battalion

Appendix 8. Enemy Order of Battle

ENEMY ORDER OF BATTLE

3rd Army

41st Infantry Division (-)

22nd Infantry Division

63rd Infantry Division (-)

1st Regiment 63rd Infantry Division (-)

2nd Regiment 63rd Infantry Division (-)

1st Battalion 1st Infantry Regiment 63rd Division Reserve

1st Royal Guards Tank Regiment (-) 3rd Army Reserve

Appendix 9. Mission Analysis

52ND DIVISION

Mission: Attack to seize Obj Rhino
 Defeat EN 63rd Division and seize Obj Skull
 o/o defend in sector

Specified Tasks:

Provide 1 bn of AH-64 helicopters to augment Corps TCF.
Attack and destroy enemy 63d Division east of PL SNAKE.
Seize OBJs Rhino and Skull in that order.
Assist forward movement of 203rd ACR in zone.
Ensure link-up with 5 (US) Corps vic OBJ SKULL.
Defend in sector from NA 200300 to NB 235123.
o/o Continue offensive operations west in zone as the corps supporting effort.
Clear all fires west of PL WOLF and forward of LOA with 10 Corp Artillery.

Implied Tasks: Secure 10th US Corps left flank from LD to PL Wolf
 Secure Division right flank
 Support Corps deception plan to disguise main effort
 Provide designated routes to 203 ACR movement in zone
 Maintain contact with 103rd Infantry Division (M)

Appendix 10. Wargame Narrative without CADET - Deep Battle

52d DIV (M) WARGAME NARRATIVE

CRITICAL EVENT: DEEP BATTLE(S) - 2 INITIAL PHASE									
Seq. No.	Action	Reaction	Counter-action	Assets	Time	Decision Point	CCIR	Control Measures	Remarks
1.	Preparatory artillery fires	Counter battery	Shift from EN Artillery to EN Defensive positions	52d DIVARTY + 1 MLRS (Corps)	H-1 to H-5 min	N/A	EN FA suppression		EN Arty neutralized
2.	SEAD	EN AD moves	FA destroys AD assets	52d DIVARTY + 1 MLRS (Corps)	H-5 min to H-Hour	N/A	EN AD radars suppressed	LLTR	LLTR established
3.	USAF CAS (deep battle)	EN BN defends in position	N/A	USAF Sorties	H-Hour to H+1		USAF BDA reports	LLTR	EN BN suppressed/ fixed in position 50% casualties
4.	52d MI BN jams Royal Guards Regt C2	EN executes ECM measures	Jamming continues	52d MI BN	H-5 min to H-Hour	MI battle reports	N/A	N/A	EN Regt ceases C2 transmission
5.	52d CAB attacks Royal Guards Regt	1st Royal Guards TK Regt defends	Engagements continue	1 Attk Helo Bn	H-Hour to H+1	Battle reports	52d CAB BDA	LLTR and CAB OPLAN	EN Rgt loses 1 co of tanks

CRITICAL EVENT: DEEP BATTLE(S) - SUBSEQUENT PHASE									
Seq. No.	Action	Reaction	Counter-action	Assets	Time	Decision Point	CCIR	Control Measures	Remarks
6.	DIVARTY shifts to SEAD	EN TK Regt begins to move forward	FA suppresses units in LLTR	52d DIVARTY and MLRS	H + 6	N /A	Intelligence reports	LLTR	N/A
7.	52d CAB attacks Royal Guards Regt on the move	EN TK Regt defends	Engagement continues	1 Attk HELO Bn	H + 6 to H + 7	CAB battle reports	N/A	LLTR	1/2 TK Regt destroyed

Appendix 11. Wargame Narrative without CADET - Main Battle

52d DIV (M) WARGAME NARRATIVE

CRITICAL EVENT: MAIN BATTLE 52d DIV (M)

Seq. No.	Action	Reaction	Counter-action	Assets	Time	Decision Point	CCIR	Control Measures	Remarks
1.	52d Div attacks w/3d Bde in north, 2d Bde in south	EN 1st Regt defends in north; 2nd Regt defends in south	A N/	2 AR 2 IN 1 FA 1 MLRS in north; 1 AR 2 IN 2 FA in south	H - hour to H + 1	Bde combat reports	Rupture of EN defenses	Annex C Ops overlay	Main battle begins
2.	DIVARTY shifts to SEAD	EN engages returning FR AIR	FA suppresses units in LLTR	52d DIVARTY and MLRS	H + 55 min to H + 2	Sorties return	USAF BDA	LLTR	Deep battle sorties return
3.	52d Div main effort seizes Obj Rhino 52d Div supporting effort cont. attack	2d EN Regt defends 1st EN Regt defends	Obj Rhino Seized N/A	1 AR 2 IN 2 FA 2 AR 2 IN 1 FA 1 MLRS	H + 2 to H + 3 H + 2 to H + 3	2d Bde battle reports 3rd Bde battle reports	2d Bde cbt reports 3rd Bde battle reports	Ops overlay Ops overlay	EN 2d Regt destroyed Battle continues
4.	52d Div main effort reaches PL Snake (2d Bde)	EN Tank Rgt begins to move forward	HASTY defense at PL Snake	1 AR 2 IN 2 FA	H + 4	PL Snake	N/A	PL Snake	Obj Rhino cleared of EN units
5.	52d Div supporting effort reaches PL	EN Regt and BN reserve defends	Obj Rhino secured HASTY	2 AR 2 IN 2 FA	H + 4 to H + 6	PL Snake	3rd Bde battle reports	PL Snake	EN 1st Regt and 1st BN destroyed

CADET Final Scientific and Technical Report - March 1997 - February 2000

	Snake		defense										
6.	52d Div reserve begins mvmt on Axis Bull	N/A	Passage of lines at PL Snake	2 AR 1 IN and 1 IN OPCON; and 1 FA BN (DS)	H + 4 to H + 5	N/A	N/A	N/A	Axis Bull	N/A		N/A	
7.	52d Div shifts main effort to 1st Bde	EN Tk Regt reaches EA HOG	1st Bde attacks EN TK Regt	2 AR 2 IN 1 FA	H + 6 to H + 7	1st Bde battle rpts	Battle rpts	EA Hog		EN Tk Regt destroyed			
8.	52d Div begins exploitation 1st Bde main effort in north; 2d Bde spptng effort in south; 3rd Bde reserve	N/A	Lead Bdes in MTC (1st and 2nd) reserve in HASTY defense at PL Snake	North 2 AR 2 IN 1 FA South 1 AR 2 IN	H + 6 to H + 7	PL Gator	Intel rpts deep in EN zone	PL Gator		N/A			
9.	CAV Sqdrn begins moving screen on north flank	N/A	A	1 Cav Sqdrn	H + 7	Destruction of EN TK Regt	N/A	Ops overlay		N/A			
10.	52d CAB begins aerial zone recon	N/A	A	1 Attk HELO Bn	H + 7	Destruction of EN TK Regt	N/A	Ops overlay		N/A			
11.	52d Div main effort reaches PL Gator HASTY defense	EN Divs in north begin withdrawal (22nd and 41st)	Monitor EN activities on north flank	2 AR 2 IN MI BN CAV Sqdrn 3rd and 1st Bdes	H + 8	PL Gator	EN CATK indicators	PL Gator; 52d Div north boundary; Ops overlay		N/A			
12.	DIVARTY begins forward	N/A	A	N/A	A	N/A	N/A	A		N/A			N/A

CADET Final Scientific and Technical Report - March 1997 - February 2000

13.	displacement 2d Bde reaches PL Gator 3rd Bde begins follow and support of 1st Bde in zone 1st Bde resumes exploitation	N/A N/A N/A	A N/A N/A	N/ N/A N/A	1 AR 2 IN 1 FA 2 AR 1 IN 2 AR 2 IN	H + 9 H + 9 H + 9	Battle rpts Battle rpts 2d Bde rpts	N/A N/A N/A	PL Gator PL Gator PL Gator	Exploitation continues Exploitation continues Exploitation resumes
14.	1st and 2d Bde reach PL Wolf	N/A	A	N/ A	2 AR 2 IN 1 AR 2 IN	H + 10	PL Wolf	N/A	PL Wolf	N/A
15.	3rd Bde reaches PL Gator	N/A	A	N/ A	2 AR and 1 IN	H + 10	N/A	N/A	OPLAN	N/A
16.	CAV Sqdrn extends screen from PL Snake to PL Gator	N/A	A	N/ A	1 CAV Sqdrn	H + 10	N/A	N/A	OPLAN	N/A
17.	ENGR Bn clears MSR to PL Gator	N/A	A	N/ A	Engr Bn (-)	H + 8 to H + 10	N/A	N/A	Service support traffic circulation plan	N/A
18.	52d Div seizes Obj Skull 1st Bde Obj Bear 2nd Bde Obj Tiger 3rd Bde Obj Lion	N/A	Bdes begin defense preparatio ns	N/ A	2 AR 2 IN 1 FA 2 AR 2 IN 2 AR 1 IN 1 FA	H + 10 to H + 12	Bde reports	Status of EN Divs to the north and east	OPLAN	N/A
19.	CAV Sqdrn extends screen	N/A	A	N/ A	1 CAV Sqdrn	H + 10 to H + 12	Obj Skull seized	Status of EN Div to north	OPLAN	N/A

CADET Final Scientific and Technical Report - March 1997 - February 2000

20.	to PL Wolf 52d Div defends in sector coord defense w/49 Div	N/A	A	N/	Div Hqs; 3d Bde	H + 13 to mission complete	N/A	N/A	A	N/	N/A
21.	CAV Sqdrn moves to Obj Skull	N/A	A	N/	CAV Sqdrn	H + 13	49th Div Elts arrive at PL Wolf	N/A	Corps OPLAN		CAV Sqdrn relinquishes sector responsibility to 49 AD
22.	52d CAB begins aerial screen east	N/A	A	N/	1 ATTK HELO Bn	H + 13	52d Div defensive Ops begin	Intell reports	OPLAN		N/A

Appendix 12. Wargame Narrative without CADET - Rear Battle

52d DIV (M) WARGAME NARRATIVE

CRITICAL EVENT: REAR OPERATIONS									
Seq. No.	Action	Reaction	Counter-action	Assets	Time	Decision Point	CCIR	Control Measures	Remarks
1.	Security Ops in Div rear area	N/A	N/A	DISCOM patrolling cavalry sqm	H-2 to H+6	Patrol repts	N/A	Rear area security plan	Action based on contact w/EN
2.	DISCOM prepares for displacement	N/A	N/A	DISCOM HQ and MSB	H+2	N/A	N/A	OPLAN	N/A
3.	DISCOM begins displacement	N/A	N/A	DISCOM HQ + MSB	H+10	Lead bdes reach PL Wolf	N/A	OPLAN	N/A
4.	Engr Bn completes MSR clearance	N/A	N/A	Engr Bn (-)	H+13	Obj Skull occupied	N/A	Service support plan	N/A
5.	1/2 DISCOM completes displacement	N/A	N/A	DISCOM HQ and MSB elts	H + 19	OPNS begin in new DSA	N/A	Service support plan	N/A
6.	DISCOM moves to new DSA complete	N/A	N/A	DISCOM HQs and MSB elts	H+72	N/A	N/A	Service support plan	N/A

Appendix 13. Synchronization Matrix developed in Wargame without CADET

CONVENTIONAL SCENARIO

TIME	H-2	H-1	H-Hour	H +1	H + 2	H + 3	H + 4
Enemy	Defend in sector				Launch CATK in north	EN DIV destroyed	
Decision Points			DEEP battle resolution		Destruction of Bn Reserves in zone		
DEEP (N/A) CAS / ATTK HELOS		ATT K EN DIV RES TLBN			Attack Bn CATK force		
Security CAV SQDRN							
Main Effort 2d Bde		DS ART Y fires in zone	Cross LD (Delib Attack penetration)				Reach PL Snake
Supporting Effort 3d Bde		DS ART Y fires in zone	Cross LD				
Reserve 1st Bde			AA activities				Begin fwd movement

CADET Final Scientific and Technical Report - March 1997 - February 2000

TIME	H-2	H-1	H-Hour	H +1	H + 2	H + 3	H + 4
DIVARTY * 1 GS Bn * 1 MLRS Btry * 1 MLRS Bn		ATT K DIV RES Bn			Engage EN Div Reserve		
ENGR Bn			AA Activities		Begin RTE clearance for 1 st Bde		
MI Bn		Jam enem y TK Regt (RES)	Halt jamming monitor EN RES				
MP Co					Estab TCP for 1 st Bde		
DISCOM					DISCO M prepares for displace- ment		

CONVENTIONAL SCENARIO

TIME	H + 5	H + 6	H + 7	H + 8	H + 9	H + 10	H + 11
Enemy				EN Division in north begin withdrawal			
Decision Points			Intention s & actions of EN Division north of right flank				
DEEP (N/A) CAS / ATTK HELOS		Attack EN Tank Regt	Begin aerial zone recon				
Security CAV SQDRN			Estab moving screen on Div north flank		Screen PL Snake to FLOT	Screen PL Gator to PL Snake	
Main Effort 2d Bde	Hasty defense		Assume sptying effort; begin exploitation to PL gator		Reach PL Gator	Reach PL Wolf	
Supporting Effort 3d Bde		Reach PL Snake	Assume Div Reserve		Begin follow & support in 1 st Bde zone	Reach PL Gator	

CADET Final Scientific and Technical Report - March 1997 - February 2000

TIME	H + 5	H + 6	H + 7	H + 8	H + 9	H + 10	H + 11
Reserve 1st Bde	Conduct passage of lines / assume main effort	MTC; Engage & destroy EN Reserve (TK Regt)	Begin exploitation to PL Gator	Reach PL Gator Hasty defense		Reach PL Wolf	
DIVARTY * 1 GS Bn * 1 MLRS Btry * 1 MLRS Bn				Begin displacement to PL Gator		Reach PL Gator	
ENGR Bn	Begin MSR clearance					MSR cleared to PL Gator	
MI Bn			Monitor Div North Flank				
MP Co	Provide security for ENGR detachments / Estab MSR TCPs						
DISCOM						DISCOM begins displacement	

CONVENTIONAL SCENARIO

TIME	H + 12	H + 13	H + 14	H + 15	H + 16 - H + 18	H + 19
Enemy						
Decision Points						
DEEP (N/A) CAS / ATTK HELOS		Begin aerial screen				
Security CAV SQDRN	Screen PL Wolf to PL Gator					
Main Effort 2d Bde	Reach Obj Tiger assume reserve	Clear Div rear area and conduct rear area security actions				
Supporting Effort 3d Bde	Reach Obj Lion Hasty defense	Improve defenses	Coord defense with 49 DIV			
Reserve 1st Bde	Reach Obj Bear Hasty defense	Improve defenses				
DIVARTY * 1 GS Bn * 1 MLRS Btry * 1 MLRS Bn						
ENGR Bn	MSR cleared to PL Wolf		MSR cleared to new DSA			

CADET Final Scientific and Technical Report - March 1997 - February 2000

TIME	H + 12	H + 13	H + 14	H + 15	H + 16 - H + 18	H + 19
MI Bn	Monitor with- drawing EN Division s					
MP Co			Maintain MSR TCPs			
DISCOM						Half of DISCO M arrives new DSA at H+22 second half at H+72

Appendix 14. Course of Action Sketch

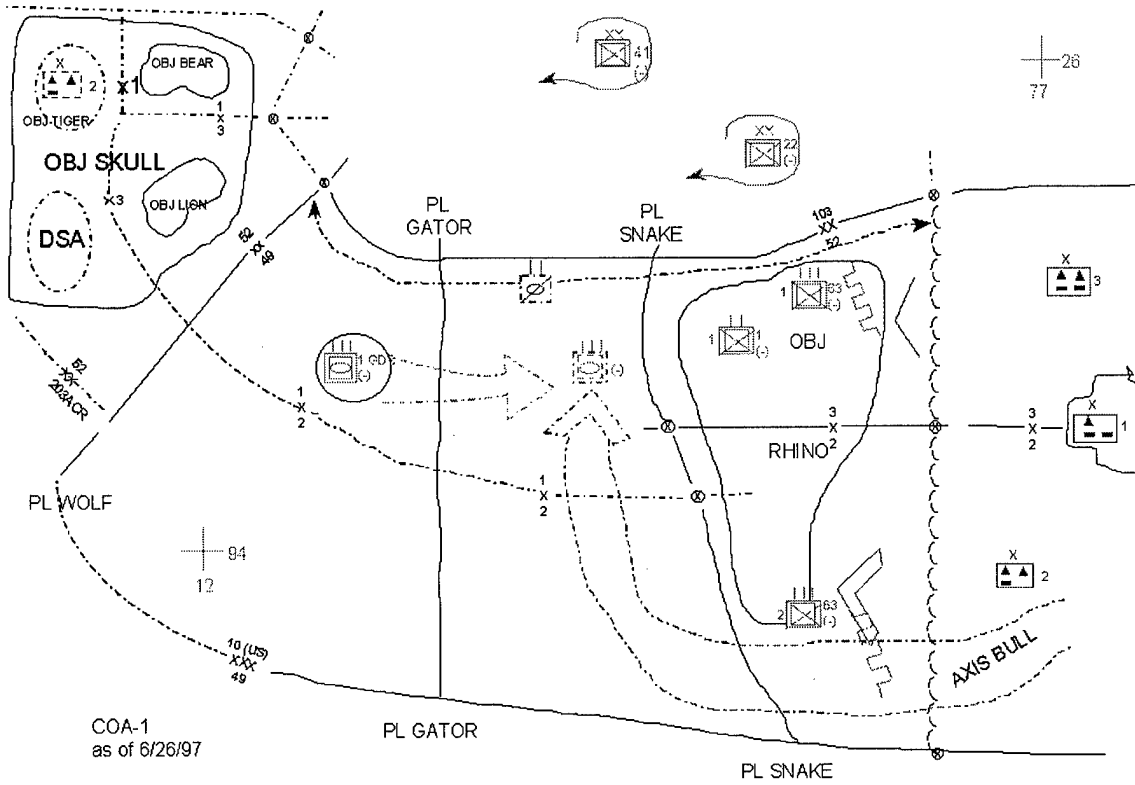

Figure 1. COA Sketch for CADET input.

Appendix 15. Activity Model for 52d Division offensive operations

Activity Model for: 2.3.3 – The MECH Heavy Brigade becomes the division main effort.

[this is not part of the activity being modeled. We only want the sentence "becomes main effort." The rest is already answered. and attacks on axis Bull to complete the destruction of the 1st RTR in EA Hog.]

1. Why do we need this activity?

Places "Fresh" Bde w/4 Bns against 1st RTR.
2. When not to add this activity?

N/A – planned activity.
3. If this activity is not performed, how much riskier will be the parent activity?

Significant risk because 2nd and 3rd Bde have already fought 1 RG each and now must face RTR.
4. Which BOS does it belong to?

Maneuver.
5. Should it be displayed on sync matrix?

Yes – see H+5.
6. When should it start relative to the parent activity?

H+5.
7. When should it end relative to the parent activity?

H+7.
8. What is the minimum time required to perform this activity?

3 hours.
9. Does it have to be performed exactly by the same unit that performs the parent task?

Parent task is the Division's attack, the Brigade is a subordinate MSC, hence different issues.
10. What kind of units can perform it?

Maneuver.

11. How much of these units is needed?

One (1) Bde.

12. Is it reaction or counteraction to the parent?

Neither, it is a planned action.

13. If this task supports the parent task, what is the support relation?

Bde is a subordinate MSC of the division; i.e., Division task of destroying RTR becomes Bde's mission.

14. Which enemy units will oppose this activity?

1st RTR, and division troops of EN 63rd Division (Arty, etc.).

15. Anything else that is important to decide about this activity?

No.

Activity Model for: 2.3.4 – The AVN Bde supports the destruction of 1 RTR in EA Hog. The CAV Squadron begins to screen the division's right (north) flank and maintains contact with the adjoining Division

1. Why do we need this activity?

Deep battle creates disorganization of enemy target, inflicts casualties and, better force ratios and disrupts enemy timing.

2. When not to add this activity?

When no appropriate targets exist (this happens in this scenario beyond PL WOLF.

3. If this activity is not performed, how much riskier will be the parent activity?

1st RTR should be defeated anyway, but casualties in 1st Bde will be higher, ∴ higher risk

4. Which BOS does it belong to?

Fires.

5. Should it be displayed on sync matrix?

Yes.

6. When should it start relative to the parent activity?

H+2 vs. 1st Bn 2nd REGT ending at H+3 vs. RTR H-1 and again at H+6.

7. When should it end relative to the parent activity?

H+7.

8. What is the minimum time required to perform this activity?

Planning time is 1 hour vs. 1 Bn 2nd Rgt; 2 hours vs. RTR.

9. Does it have to be performed exactly by the same unit that performs the parent task?

Deep battle is a mix of assets, i.e., EW, ARTY, CAS and Army AVN – mix depends upon availability and capability.

10. What kind of units can perform it?

See above.

11. How much of these units is needed?

Use of these units will continue until desired BDA or effect is achieved.

12. Is it reaction or counteraction to the parent?

It is a division task and hence a mission assigned to the MSC – (AVN BDE)

13. If this task supports the parent task, what is the support relation?

Part of the scheme of maneuver.

14. Which enemy units will oppose this activity?

EN Air Defense and Arty, EN Air and EN, 1st RTR.

15. Anything else that is important to decide about this activity?

No.

Activity Model for: 2.3.5 – The CAV squadron assumes division reserve.

1. Why do we need this activity?

Maintaining a ground force as a reserve allows the commander a resource for contingencies; doctrinally desirable.

2. When not to add this activity?

N/A – see above.

3. If this activity is not performed, how much riskier will be the parent activity?

Risk increases with no reserving capability (see 1 above).

4. Which BOS does it belong to?

Maneuver.

5. Should it be displayed on sync matrix?

Yes.

6. When should it start relative to the parent activity?

Reserves are always accounted for throughout the sync matrix; when committed and when reconstituted.

7. When should it end relative to the parent activity?

Never unless committed or risk accepted.

8. What is the minimum time required to perform this activity?

N/A.

9. Does it have to be performed exactly by the same unit that performs the parent task?

No; reserve is a mission assigned by the division to a subordinate maneuver MSC.

10. What kind of units can perform it?

Maneuver units only.

11. How much of these units is needed?

METT-TC dependent; usually assigned to MSC's; "How much" is determined by task organization decisions.

12. Is it reaction or counteraction to the parent?

Neither – plans and orders, i.e., an action.

13. If this task supports the parent task, what is the support relation?

See #9.

14. Which enemy units will oppose this activity?

A mission/ when reserve is committed vs. an enemy, it is no longer in reserve.

15. Anything else that is important to decide about this activity?

No.

Activity Model for: 2.3.6 – The MECH DIV transitions to a defense, oriented to the north, to contain enemy forces and assist in their destruction by the adjacent divisions.

1. Why do we need this activity?

Division must defend at OBJ SKULL to accomplish its mission assigned by Corps and the intent on both the Corps and Army Group commanders.

2. When not to add this activity?

When corps orders change.

3. If this activity is not performed, how much riskier will be the parent activity?

Corps and AG missions and intent will probably fail; i.e., the enemy 42 and 22 Divisions will probably escape encirclement and subsequent destruction.

4. Which BOS does it belong to?

Maneuver.

5. Should it be displayed on sync matrix?

Yes; maneuver boy at H+10.

6. When should it start relative to the parent activity?

H+10.

7. When should it end relative to the parent activity?

It is reflected at H+14 by a change in mission – “o/o offensive ops”. If corps does not order offense then defense continues.

8. What is the minimum time required to perform this activity?

4 hours – orders dependent.

9. Does it have to be performed exactly by the same unit that performs the parent task?

It is the "parent task"; i.e., the division missions.

10. What kind of units can perform it?

All maneuver units and their MSCs.

11. How much of these units is needed?

Task organization dependent.

12. Is it reaction or counteraction to the parent?

It is an action planned by division to accomplish corps task.

13. If this task supports the parent task, what is the support relation?

See #9.

14. Which enemy units will oppose this activity?

The enemy 42nd and 22nd Divisions.

15. Anything else that is important to decide about this activity?

No.

Activity Model for: 2.3.7 – The AVN Bde assumes responsibility for the division's right (north) flank and screens from the LD to PL WOLF, facilitates the forward movement of the adjacent armored division and coordinates the turnover of the sector from the LD to PL WOLF.

1. Why do we need this activity?

Ordered by corps.

2. When not to add this activity?

See #1 above.

3. If this activity is not performed, how much riskier will be the parent activity?

Must be performed by Division or mission fails; the division cannot defend from LD to Skull.

4. Which BOS does it belong to?

C².

5. Should it be displayed on sync matrix?

The coordination should not – it is staff work; the assumption of sector responsibility by the AD should.

6. When should it start relative to the parent activity?

Coordination of this activity will occur prior to the attack between the two division staffs (@ H-24 hrs).

7. When should it end relative to the parent activity?

At H+10, it is accomplished.

8. What is the minimum time required to perform this activity?

METT-TC dependent.

9. Does it have to be performed exactly by the same unit that performs the parent task?

Both the 49 AD and the MECH Division will assign MSC actions to be accomplished to their respective commands.

10. What kind of units can perform it?

All units.

11. How much of these units is needed?

N/A.

12. Is it reaction or counteraction to the parent?

Neither; it is a planned action by both divisions coordinated by corps.

13. If this task supports the parent task, what is the support relation?

See #12.

14. Which enemy units will oppose this activity?

22nd Div, EN Army troops and perhaps the 41 Division, later.

15. Anything else that is important to decide about this activity?

No.

Activity Model for: 2.3.8 – The MECH Division accepts risk and has no reserve.

[only the sentence above is pertinent. How do you want to model "accepts risk"? The rest of this is already modeled... The MECH DIV resumes the attack to the west. The MECH Heavy Bde continues as the division's main effort and attacks in zone to secure OBJ BEAR. The Tank Heavy Bde attacks in zone to secure OBJ TIGER. The balanced Bde (MECH-Tank) follows the MECH Heavy Bde and secures OBJ LION.]

1. Why do we need this activity?
Commander decides when to accept risk; he always tries to minimize risk at every point in battle.
2. When not to add this activity?
When COA does not demand it or if the commander rejects the risk.
3. If this activity is not performed, how much riskier will be the parent activity?
Division north flank would then have to be secured by another MSC; as they all have missions at this point risk would be more significant if all MSC were given a dual task.
4. Which BOS does it belong to?
None – command issue; ART.
5. Should it be displayed on sync matrix?
No; only the fact that reserve is not committed.
6. When should it start relative to the parent activity?
Planned at H+5.
7. When should it end relative to the parent activity?
Planned at H+8.
8. What is the minimum time required to perform this activity?
3 hours.
9. Does it have to be performed exactly by the same unit that performs the parent task?
No – performed by subordinate MSC.
10. What kind of units can perform it?
Maneuver units perform reserve functions.

11. How much of these units is needed?

As directed in task organization.

12. Is it reaction or counteraction to the parent?

Planned action.

13. If this task supports the parent task, what is the support relation?

See #9.

14. Which enemy units will oppose this activity?

Screen will be opposed by 22nd Division, 43rd Division and EN Army troops.

15. Anything else that is important to decide about this activity?

No.

Activity Model for: 2.3.9 – Alex added. MP Company tasks.

1. Why do we need this activity?

MP operations assist in traffic control, rear area security, law and order, and POW refugee management.

2. When not to add this activity?

These activities are always planned for and execution as doctrinal missions for the MPs.

3. If this activity is not performed, how much riskier will be the parent activity?

These activities would then be performed by combat units in zone; not so much a risk as an additional burden.

4. Which BOS does it belong to?

CSS.

5. Should it be displayed on sync matrix?

No; MP operations are managed through the rear CP and DISCOM.

6. When should it start relative to the parent activity?

MP operations are on-going efforts regardless of mission.

7. When should it end relative to the parent activity?

See #6 above.

8. What is the minimum time required to perform this activity?

METT-TC and activity dependent.

9. Does it have to be performed exactly by the same unit that performs the parent task?

Combat units can perform their activities (CS and CSS also) but not desirable.

10. What kind of units can perform it?

See #9 above.

11. How much of these units is needed?

MP assets are scarce and organized to perform the tasks listed at #1 above; all will be used.

12. Is it reaction or counteraction to the parent?

Planned action.

13. If this task supports the parent task, what is the support relation?

Not directly supporting – i.e., DISCOM or rear CP usually direct and control.

14. Which enemy units will oppose this activity?

Stragglers, Special OPS Forces, POWs and bypassed EN troops.

15. Anything else that is important to decide about this activity?

Note: MP Ops, like many CS and CSS units, are not done by “units” *per se*; i.e., an MP company has small sections of specialists to perform each task at #1 above.

Appendix 16. Mapping of Activities to Objects

Time: H-1 to H+2

Mission: 2nd Brigade (main effort) attacks in zone to destroy the 2nd Regiment, 63rd Division and Seizes and Secures Objective Rhino in Zone.

BOS: Maneuver/C2/ADA/CSS/INTEL/FS

Resources Needed: 3 Brigades, 1 Battalion Artillery & 1 Battalion attack helicopter, 1 military Intelligence Battalion, Air Defense Artillery Battalion, Direct Support Battalion and Engineer Battalion.

Activities:

- Prep fire in zone
- Fire on targets of opportunity
- Cross LD
- Supporting attack
- Attack enemy reserves
- TAC CP Displace
- Prepare EPW Camp
- Collect EPW
- Enemy Counterattacks
- Enemy Reinforce
- Enemy Delays
- Enemy Withdraws
- Rearm/Refuel

Start Window: H-Hour

End Window: H + 2

Minimum Duration: 1 Hour

Maximum Duration: 2 Hours

Constraints: Crossing LD
Remain with in zone

UNIT CANDIDATE:	Prep fire in zone
START WINDOW:	H-1
END WINDOW:	H
MINIMUM DURATION:	1 Hour
MAXIMUM DURATION:	1 Hour
CONSTRAINTS:	Artillery Ammunition CAS Allocation
RESOURCE (UNIT) COMSUPTION:	DIVARTY 1-2 FA (GS) 1002 FA Bn (MLRS) (Corps) (GS) 52 nd Tgt Acq Btry
	2 nd Bde 2-1 FA (DS) 3-1 FA (R)
	3 rd Bde 1-1 FA (DS)

UNIT CANDIDATE: Cross LD

START WINDOW: H – Hour

END WINDOW: H – Hour

MINIMUM DURATION: H – Hour

MAXIMUM DURATION: H – Hour

CONSTRAINTS: H – Hour

RESOURCE (UNIT) CONSUMPTION:

2 nd Bde	3 rd Bde
2-1 IN (M)	1-2 AR
2-2 IN (M)	3-1 AR
2-2 AR	1-2 IN (M)
	3-1 IN (M)
B/63 Engr (DS)	C/63 Engr (DS)
5 GSR Tms	5 GSR Tms

UNIT CANDIDATE: Fire on targets of opportunity

START WINDOW: H - Hour

END WINDOW: H + 2

MINIMUM DURATION 1 Hour

MAXIMUM DURATION: 2 Hours

CONSTRAINTS: Artillery Ammunition
CAS Sorties
of ATTK HELOS

RESOURCE (UNIT) CONSUMPTION:

DIVARTY

1-2 FA (GS)
1002 FA Bn
(MLRS) (Corps)
(GS)
52nd Tgt Acq Btry

2nd Bde
2-1 FA (DS)
3-1 FA (R)

3rd Bde

1-1 FA (DS)
1-1 FA (DS)

52 AVN Bde
2-1 ATTK Bn

UNIT CANDIDATE: Supporting Attack

START WINDOW: H – Hour

END WINDOW: H + 2

MINIMUM DURATION: 2 Hours

MAXIMUM DURATION: 3 Hours

CONSTRAINTS: Remain w/in zone

RESOURCE (UNIT) CONSUMPTION:

3rd Bde
1-2 AR
3-1 AR
1-2 IN (M)
3-1 IN (M)
1-1 FA (DS)
C/63 Engr (DS)
3rd FSB
5 GSR Tms

UNIT CANDIDATE: Attack Enemy Reserves

START WINDOW: 1st RTR H - 1
1st Bn 1st Regt H - 1

END WINDOW: 1st RTR H - 7
1st Bn 1st Regt H - 3

MINIMUM DURATION: 1st RTR -----H + 5
1st Bn 1st Regt H + 1

MAXIMUM DURATION: 1st RTR ----- H + 7
1st Bn 1st Regt---- H + 3

CONSTRAINTS: None

RESOURCE (UNIT) CONSUMPTION:

1st RTR
H - 1 to H + 6

1st Bn 1st Regt
H - 1 to H + 2

DIVARTY

52 MI Bn (-)

1-2 FA(GS)
1002 FA Bn
(MLRS) (Corps)

52 AVN Bde

(GS)

2-1 ATTK BN 52nd Tgt Acg Btry

H + 5 to H + 7

H + 2 to H + 3

1st Bde

DIV ARTY

3rd Bde

1-1 AR

1-2 FA (GS)

1-2 AR

2-1 AR

1002 FA Bn

1-2 IN (M)

1-1 IN (M)

(MLRS) (Corps)

3-1 IN (M)

3-1 AR

(GS)

1-1 FA (DS)

3-1 FA (DS)

52nd Tgt Acg Btry

C/63 Engr (DS)

A/63 Engr (DS)

5 GSR Tms

5 GSR Tms

UNIT CANDIDATE:	TAC CP DISPLACES
START WINDOW:	H - 1
END WINDOW:	H + 11
MINIMUM DURATIN:	10 hrs (H+11)
MAXIMUM DURATION:	11 hrs (H+12)
CONSTRAINTS:	None
RESOURCE (UNIT) CONSUMPTION:	TAC CP

UNIT CANDIDATE: Prepare EPW CAMP

START WINDOW: H - 2

END WINDOW: H - Hour

MINIMUM DURATION: 2 Hours

MAXIMUM DURATION: 3 Hours

CONSTRAINTS: OPSEC
BARRIER MATERIALS
Corps EPW policy

RESOURCE (UNIT) CONSUMPTION:

DIV TRP
1-63 Engr Bn (-)
52 MI Bn (-)

DISCOM
52nd MSB

UNIT CANDIDATE:	Collect EPW
START WINDOW:	H - Hour
END WINDOW:	H + 19 (+)
MINIMUM DURATION:	19 Hours
MAXIMUM DURATION:	19 Hours
CONSTRAINTS:	None
RESOURC (UNIT) CONSUMPTION:	All Units

UNIT CANDIDATE: Enemy Counter Attacks

START WINDOW: H + 1 (orders) 1st Bn 1st Regt
H + 2 1st RTR

END WINDOW: H + 3 1st Bn 1st Regt
H + 7 1st RTR

MINIMUM DURATION: 2 Hours 1st Bn 1st Regt
3 Hours 1st RTR

MAXIMUM DURATION: 3 Hours 1st Bn 1st Regt (EN)
5 Hours 1st RTR

CONSTRAINTS:

RESOURCE (UNIT) CONSUMPTION: 1st Bn 1st Regt (EN)
1st RTR

UNIT CANDIDATE:	Enemy Reinforce	
START WINDOW:	H + 1	1 st Bn 1 st Regt
	H + 2	1 st RTR
END WINDOW:	H + 2	1 st Bn 1 st Regt
	H + 5	1 st RTR
MINIMUM DURATION:	1 Hour	1 st Bn 1 st Regt
	3 Hours	1 st RTR
MAXIMUM DURATION:	2 Hours	1 st Bn 1 st Regt
	4 Hours	1 st RTR
CONSTRAINTS:		
RESOURCE (UNIT) CONSUMPTION:	1 st Bn	1 st Regt
	1 st RTR	

UNIT CANDIDATE: Enemy Delays

START WINDOW: H + 5

END WINDOW: H + 19

MINIMUM DURATION: H + 19

MAXIMUM DURATION: 14 Hours

CONSTRAINTS:

RESOURCE (UNIT) SONSUMPTION: 1st RTR

UNIT CANDIDATE: Enemy Withdraws

START WINDOW: H + 2

END WINDOW: H + 19

MINIMUM DURATION: 17 Hours

MAXIMUM DURATION:

CONSTRAINTS:

RESOURCE (UNIT) CONSUPTION: 63rd Div (-)
1st RTR

UNIT CANDIDATE: Rearm/Refuel

START WINDOW: H + 12

END WINDOW: H + 17

MINIMUM DURATION: 5 Hours 15 Minutes

MAXIMUM DURATION: 7 Hours

CONSTRAINTS: Assumption is 1-hour fuel time per Bn (2)
Per support Bn (4) ∴ time is 5 hours 15
minutes

RESOURCE (UNIT) CONSUMPTION: 1st FSB
2nd FSB
3rd FSB
52 MSB

Appendix 17. Activity Modeling Sheet - Deep Attack by Army Aviation

ACTIVITY MODELING SHEET

November 11, 1997

Deep Attack by Army Aviation

GENERAL

4 Conduct Deep Attack by Army Aviation

4.1 Conduct Preparations

- 4.1.1 Develop plan
- 4.1.2 Coordinate with other air operations and deep attack missions
- 4.1.3 Plan air corridors
- 4.1.4 Brief aircrews
- 4.1.5 Coordinate with air defense artillery
- 4.1.6 Rehearse mission
- 4.1.7 Fuel and arm aircraft
- 4.1.8 Coordinate with field artillery

4.2 Assemble Forces for Deep Attack

- 4.2.1 Move FARP to forward assembly area
- 4.2.2 Move artillery to support SEAD
- 4.2.3 Move aircraft to forward assembly areas
- 4.2.4 Fuel and arm aircraft
- 4.2.5 Update target information

4.3 Conduct Deep Attack

- 4.3.1 Fire SEAD for penetration of FLOT
- 4.3.2 Penetrate FLOT into enemy territory
- 4.3.3 Travel to battle points/engagement area
- 4.3.4 Attack targets
- 4.3.5 Assess damage to target
- 4.3.6 Report damage to target and friendly forces
- 4.3.7 Recover downed aircrew members
- 4.3.8 Travel back to FLOT
- 4.3.9 Fire SEAD for penetration of FLOT
- 4.3.10 Penetrate FLOT into friendly territory
- 4.3.11 Recover aircraft

4.4 Recover from Deep Attack Operation

- 4.4.1 Fuel and arm aircraft
- 4.4.2 Debrief aircrews
- 4.4.3 Evaluate effect of damage to target
- 4.4.4 Determine need for follow-on attack
- 4.4.5 Move FARP
- 4.4.6 Move field artillery
- 4.4.7 Move aircraft to rear

ACTIVITY MODELING QUESTIONS

Questions to answer about each task:

- Description:
- Why do we need this activity:
- When NOT to add this activity:
- If task not performed, how much riskier will be the parent activity:
- BOS or sub-BOS:
- Synchronization matrix: Yes
- Start relative to other tasks:
- End relative to other tasks:
- Minimum duration (hours):
- Maximum duration (hours):
- Location relative to parent task:
- Performed by the same unit as parent task:
- Units which perform this task:
- How much of unit needed (percent):
- Reaction or counteraction to parent task:
- Support relation to parent unit:
- Which enemy units will oppose this activity:
- Anything else that is important to decide about this activity:

4 Conduct Deep Attack Operation by Army Aviation

Description: Deep operations comprise activities directed against enemy forces not in contact. These activities are designed to influence the conditions in which future close operations occur. The principal objectives (targets) of deep operations are the freedom of action of the enemy and the coherence and tempo of enemy operations. Army aviation deep operations include the following phases: conduct preparations, assemble forces, conduct deep attack (including travel to and from target area), and recovery from the mission. This task describes an aviation deep attack operation where forces move from the rear area to forward assembly areas, refuel, penetrate the FLOT to an objective area, attack the target, withdraw through the FLOT, and recover for future operations. Other scenarios are described in FM 1-111, Aviation Brigades.

4.1 Conduct Preparations

- Description: Preliminary tasks to prepare for actual deep attack mission consist of tasking and coordination of participating units. Planning should begin 24-48 hours before the mission, but tasked units may not be involved unit 24 hours prior to the mission. See sub-tasks for details.

4.1.1 Develop plan

- Description: Unit staff receives order to conduct deep attack and develops plan after considering target, enemy forces, terrain, available friendly forces, logistics support.

- Why do we need this activity: Essential to success
 - When NOT to add this activity: Never
 - If task not performed, how much riskier will be the parent activity: Extremely (impossible)
 - BOS or sub-BOS: Maneuver
 - Synchronization matrix: Yes
 - Start relative to other tasks: Before all others
 - End relative to other tasks: Before 4.2.1
 - Minimum duration: 4 hours
 - Maximum duration: 24 hours
 - Location relative to parent task: Unit CP (Aviation Brigade/Battalion)
 - Performed by the same unit as parent task: Yes
 - Units which perform this task: Unit CP(Aviation Brigade/Battalion) Liaison at next higher level to supporting units (ADA, FA)
 - How much of unit needed: 30 to 100 percent (Aviation Battalion can task one company or more)
 - Reaction or counteraction to parent task: No
 - Support relation to parent: Self
 - Which enemy units will oppose this activity: No
- Anything else that is important to decide about this activity:

4.1.2 Coordinate with other air operations and deep attack missions

- Description: Directing unit must coordinate deep attack with possible conflicts. Tasking commander (corps or division) will check that other air operations (BAI, AI) and deep attack (FA, Aviation) are not a conflict.
- Why do we need this activity: To eliminate conflicts that might degrade success
- When NOT to add this activity: Never. Tasking commander should deconflict all operations, including deep attack.
- If task not performed, how much riskier will be the parent activity: Moderately
- BOS or sub-BOS: C2
- Synchronization matrix: Yes
- Start relative to other tasks: Same time as 4.1
- End relative to other tasks: After 4.3 starts
- Minimum duration (hours): 4
- Maximum duration (hours): 48
- Location relative to parent task: division or corps commander
- Performed by the same unit as parent task: no
- Units which perform this task: division or corps
- How much of unit needed (percent): 5
- Reaction or counteraction to parent task: no
- Support relation to parent: N/A
- Which enemy units will oppose this activity: none

Anything else that is important to decide about this activity: Which Aviation units will be tasked for the mission, which FA units will support SEAD, routes to fly (4.1.3), time of attack, tactics around area (included in 4.1.4), location of FARPs, logistics situation

4.1.3 Plan air corridors

- Description: The planning commander (Aviation Brigade/Battalion) must select minimum risk ingress and egress routes based on enemy location, target location, enemy defenses, fighter routes, distance, terrain, other operations, friendly air defense, etc.
- Why do we need this activity: Essential to aircraft survivability and mission success
- When NOT to add this activity: Never
- If task not performed, how much riskier will be the parent activity: Extremely
- BOS or sub-BOS: C2
- Synchronization matrix: Yes
- Start relative to other tasks: After 4.1.1
- End relative to other tasks: Before 4.3
- Minimum duration (hours): 4
- Maximum duration (hours): 8
- Location relative to parent task: Same as 4.1.1 or at tasked Aviation Battalion CP
- Performed by the same unit as parent task: Same as 4.1.1 or at tasked Aviation Battalion CP
- Units which perform this task: Brigade CP or Battalion CP
- How much of unit needed (percent): 5
- Reaction or counteraction to parent task: No
- Support relation to parent unit: N/A
- Which enemy units will oppose this activity: none

Anything else that is important to decide about this activity:

4.1.4 Brief aircrews

- Description: Aircrews must plan and brief the mission together to achieve appropriate coordination.
- Why do we need this activity: Essential to success - must coordinate flight operations
- When NOT to add this activity: never
- If task not performed, how much riskier will be the parent activity: extremely - impossible
- BOS or sub-BOS: C2
- Synchronization matrix: Yes
- Start relative to other tasks: After 4.1.1
- End relative to other tasks: Before 4.2.3
- Minimum duration (hours): 2
- Maximum duration (hours): 4
- Location relative to parent task: Area of Aviation Battalion/Company tasked with mission
- Performed by the same unit as parent task: no - performed by tasked Aviation unit aircrews and planners
- Units which perform this task: Aviation unit (Battalion/Company)
- How much of unit needed (percent): 30-80
- Reaction or counteraction to parent task: no
- Support relation to parent unit: no
- Which enemy units will oppose this activity: none

Anything else that is important to decide about this activity:

4.1.5 Coordinate with air defense artillery

- Description: ADA must know details of mission to let the aircraft through the defended area and to protect against enemy aircraft entering friendly area.
- Why do we need this activity: Prevent destruction of friendly aircraft and prevent penetration of enemy aircraft
- When NOT to add this activity: if ADA not available
- If task not performed, how much riskier will be the parent activity: moderately
- BOS or sub-BOS: C2
- Synchronization matrix: yes
- Start relative to other tasks: after 4.1.1, before 4.2.3
- End relative to other tasks: before 4.3
- Minimum duration (hours): 2
- Maximum duration (hours): 4
- Location relative to parent task: same as 4.1.1
- Performed by the same unit as parent task: same as 4.1.1 and 4.2.1
- Units which perform this task: tasking unit (division or corps staff)
- How much of unit needed (percent): 5
- Reaction or counteraction to parent task:
- Support relation to parent unit:
- Which enemy units will oppose this activity:

Anything else that is important to decide about this activity: Can ADA defend area during deep attack mission, can ADA determine friendly aircraft from enemy

4.1.6. Rehearse mission

- Description: Time permitting and depending on availability of forces and complexity of mission, Aviation unit may need to rehearse mission. Usually this will not be done. A rehearsal might not be a good idea if it might reveal the mission to the enemy.
- Why do we need this activity: Improve mission coordination and success
- When NOT to add this activity: If mission is not too complex or if a rehearsal might reveal the mission to the enemy.
- If task not performed, how much riskier will be the parent activity: Moderately/slightly depending on the complexity of the mission
- BOS or sub-BOS: AVIATION
- Synchronization matrix: Yes
- Start relative to other tasks: After 4.1.4
- End relative to other tasks: Before 4.2.3
- Minimum duration (hours): 4
- Maximum duration (hours): 24
- Location relative to parent task: friendly AO
- Performed by the same unit as parent task: no - performed by tasked Aviation unit (Battalion/Company)

- Units which perform this task: tasked Aviation unit (Battalion/Company)
- How much of unit needed (percent): 30-100
- Reaction or counteraction to parent task:
- Support relation to parent unit:
- Which enemy units will oppose this activity: none

Anything else that is important to decide about this activity: Is a rehearsal necessary or possible.
Where to conduct the rehearsal.

4.1.7 Fuel and arm aircraft

- Description: Aircraft must depart home base fully fueled and armed. They will usually move to a FARP to launch on the mission depending on distance to the target or security in the forward area. At the FARP they will refuel, but usually not rearm unless tasked for a mission enroute to the FARP.
- Why do we need this activity: Essential to success - aircraft need fuel and arms
- When NOT to add this activity: If aircraft are already fueled and armed
- If task not performed, how much riskier will be the parent activity: Extremely - impossible if aircraft have no fuel or arms
- BOS or sub-BOS: CSS
- Synchronization matrix: Yes
- Start relative to other tasks: after 4.1.6, before 4.2.3
- End relative to other tasks: before 4.2.3
- Minimum duration (hours): 2 - depends on amount of work and capabilities of unit
- Maximum duration (hours): 4
- Location relative to parent task:
- Performed by the same unit as parent task: no
- Units which perform this task: Aviation Battalion/Company
- How much of unit needed (percent): 30-100
- Reaction or counteraction to parent task:
- Support relation to parent unit: self
- Which enemy units will oppose this activity: no - possible collateral relationship to coincidental attack

Anything else that is important to decide about this activity: When to refuel and rearm. Will enemy suspect attack because of extra activity. Is additional support required at servicing point.

4.1.8 Coordinate with field artillery

- Description: The tasking unit (division/corps) must coordinate deep attack mission with FA units which will fire SEAD along FLOT. Must coordinate any other artillery mission with aircraft routes. Possible need for diversion from FA against enemy. FA units might need to move to firing locations.
- Why do we need this activity: SEAD protects aircraft during penetration of enemy ADA
- When NOT to add this activity: if SEAD not required
- If task not performed, how much riskier will be the parent activity: Extremely - depends on enemy ADA opposing mission

- BOS or sub-BOS: FS
- Synchronization matrix: Yes
- Start relative to other tasks: after 4.1.1, before 4.2
- End relative to other tasks: Before 4.2
- Minimum duration (hours): 2
- Maximum duration (hours): 4
- Location relative to parent task: same as 4.1
- Performed by the same unit as parent task: yes
- Units which perform this task: tasking unit (div/corps)
- How much of unit needed (percent): 5
- Reaction or counteraction to parent task:
- Support relation to parent unit:
- Which enemy units will oppose this activity: no

Anything else that is important to decide about this activity: FA firing locations - might require separate locations for ingress and egress, might require immediate move after firing. Location of enemy ADA.

4.2 Assemble Forces for Deep Attack

Description: Forces must move to departure locations. FARP must move to forward location. Aircraft must move to FARP. FA and ADA units must move to support locations. Intel must get latest information on enemy and pass info to forces. Forces must arrive at forward locations in time to participate appropriately. FARP must arrive in time to support flight operations.

4.2.1 Move FARP to forward assembly area

- Description: If FARP is not in place, it must move to support location and be ready for arming and fueling operations.
- Why do we need this activity: Fuel and arm aircraft before launching on mission
- When NOT to add this activity: if FARP is not required
- If task not performed, how much riskier will be the parent activity: Extremely - impossible if aircraft cannot reach target without refueling
- BOS or sub-BOS: CSS
- Synchronization matrix: Yes
- Start relative to other tasks: before 4.2.4
- End relative to other tasks: before 4.2.4
- Minimum duration (hours): 4 - depends on distance, terrain, etc.
- Maximum duration (hours): 24
- Location relative to parent task: move to forward area
- Performed by the same unit as parent task: no
- Units which perform this task: FARP
- How much of unit needed (percent): 100
- Reaction or counteraction to parent task:
- Support relation to parent unit:
- Which enemy units will oppose this activity: units which can attack forward area

Anything else that is important to decide about this activity: Where to place FARP, supplies needed at FARP to support launch and recovery of aircraft, should FARP move to support returning aircraft

4.2.2 Move artillery to support SEAD

- Description: FA units might need to move to support SEAD. Units might need to move after firing. Units might need to move to support returning aircraft
- Why do we need this activity: SEAD reduces loss of friendly aircraft to enemy air defense. FA units must be in place to support SEAD.
- When NOT to add this activity: if no air defense expected - very unlikely situation. If FA already in position to fire SEAD.
- If task not performed, how much riskier will be the parent activity: Extremely - depends on amount of enemy air defense
- BOS or sub-BOS: FS
- Synchronization matrix: Yes
- Start relative to other tasks: after 4.1.8, before 4.3.1
- End relative to other tasks: before 4.3.1
- Minimum duration (hours): 2
- Maximum duration (hours): 24
- Location relative to parent task: forward area
- Performed by the same unit as parent task: no
- Units which perform this task: FA units firing SEAD, FA Battalion/battery
- How much of unit needed (percent): 30-100 of BATTALION. All of Battery, if tasked alone.
- Reaction or counteraction to parent task:
- Support relation to parent unit: DS
- Which enemy units will oppose this activity: FA units within range

Anything else that is important to decide about this activity: Where to place FA units, SEAD targets, routes to travel to firing locations

4.2.3 Move aircraft to forward assembly areas

- Description: Aircraft must move to forward locations (usually with a FARP) to extend range and to prevent early detection by enemy. Fuel, and possibly munitions, will be required (4.2.4). FARP must arrive in time (4.2.1) to fuel and arm aircraft before launch on mission. Aircraft travel on minimum risk routes when possible and avoid friendly forces when possible.
- Why do we need this activity: Essential to success if range to target requires it.
- When NOT to add this activity: If range to target is 60 km or less.
- If task not performed, how much riskier will be the parent activity: Extremely - impossible if range is too far.
- BOS or sub-BOS: Maneuver - Aviation
- Synchronization matrix: Yes
- Start relative to other tasks: After 4.1, before 4.2.4
- End relative to other tasks: before 4.2.4

- Minimum duration (hours): 0.5
- Maximum duration (hours): 2
- Location relative to parent task: forward area
- Performed by the same unit as parent task:
- Units which perform this task: Aviation Company
- How much of unit needed (percent): 100
- Reaction or counteraction to parent task:
- Support relation to parent unit:
- Which enemy units will oppose this activity: ADA and forward units which can detect and range aircraft and landing area.

Anything else that is important to decide about this activity: Aircraft should minimize time exposed in forward area. Aircraft should not reveal location of FAA or FARP to enemy.

4.2.4 Fuel and arm aircraft before attack

- Description: Aircraft arrive in the forward assembly area after flying from the rear or recovering from a mission. The aircraft must be refueled and rearmed if necessary. Aircraft will have to cycle through the FARP, which is in or near the FAA.
- Why do we need this activity: Essential to success - aircraft must have fuel and arms for the mission
- When NOT to add this activity: If aircraft are already ready for the mission
- If task not performed, how much riskier will be the parent activity: Extremely - possibly impossible
- BOS or sub-BOS: CSS
- Synchronization matrix: Yes
- Start relative to other tasks: After 4.2.3
- End relative to other tasks: Before 4.3.2
- Minimum duration (hours): 2 - depends on capabilities of FARP and number of aircraft, distance to FARP
- Maximum duration (hours): 4
- Location relative to parent task: forward area near FLOT
- Performed by the same unit as parent task: no
- Units which perform this task: FARP
- How much of unit needed (percent): 100
- Reaction or counteraction to parent task:
- Support relation to parent unit: DS
- Which enemy units will oppose this activity: FA or other units which can detect and attack FAA or FARP location

Anything else that is important to decide about this activity: Aircraft should not reveal location of FAA or FARP to enemy. FARP must have adequate supplies. Several FARPs and locations might be required depending on size of attack force. Each Aviation Company should have FAA.

4.2.5 Update target information

- Description: Corps/div intel staff must continually update information about the mission and pass this information to all concerned: FA, ADA, aircrews, ground forces in forward area. Attack aircrews must have best information and receive updates before launch and during mission. Sources of information include all collectors available to corps: ground units, Guardrail, Quick Fix, national sources, OH-58 aircraft, etc.
- Why do we need this activity: Provide attack crews latest target and route information.
- When NOT to add this activity: Never
- If task not performed, how much riskier will be the parent activity: Moderately
- BOS or sub-BOS: IN
- Synchronization matrix: Yes
- Start relative to other tasks: before 4.3
- End relative to other tasks: after 4.3.10
- Minimum duration (hours): 1
- Maximum duration (hours): 4
- Location relative to parent task: Forward assembly area
- Performed by the same unit as parent task: no
- Units which perform this task: Intel staff in forward area, based on info from Brigade/div/corps intel staff
- How much of unit needed (percent): 5
- Reaction or counteraction to parent task:
- Support relation to parent unit: same unit
- Which enemy units will oppose this activity: Along FLOT and route to target - enemy attempts to hide location and movement

Anything else that is important to decide about this activity: Info must arrive in timely manner and be as complete as possible. Highly sensitive information must be "sanitized" before pertinent details provided to aircrews. Intel staff must predict enemy movement and location at time of mission.

4.3 Conduct Deep Attack

- Description: Deep attack is a complex operation which coordinates the basic attack helicopter mission with support from intelligence, ground maneuver units along the FLOT, FA units which provide SEAD, and other aviation forces.

4.3.1 Fire SEAD for penetration of FLOT

- Description: Field artillery units fire SEAD missions to disrupt enemy air defense along the FLOT to allow safe attack helicopters to safely penetrate this congested and heavily defended area. SEAD may also include deception fires. SEAD needs to disrupt enemy air defense for the period that aircraft are passing through the FLOT. SEAD may cover different penetration points for each Aviation Company.
- Why do we need this activity: Essential to defeat enemy air defense
- When NOT to add this activity: If FA not available or enemy forces not along flight path
- If task not performed, how much riskier will be the parent activity: moderately
- BOS or sub-BOS:
- Synchronization matrix: Yes

- Start relative to other tasks: before 4.3.2
- End relative to other tasks: after 4.3.2
- Minimum duration (hours): 5
- Maximum duration (hours): 25
- Location relative to parent task: along FLOT
- Performed by the same unit as parent task: no
- Units which perform this task: supporting FA batteries
- How much of unit needed (percent): 50-100
- Reaction or counteraction to parent task:
- Support relation to parent unit: DS
- Which enemy units will oppose this activity: FA units which can detect and attack FA batteries

Anything else that is important to decide about this activity: SEAD must be synchronized with aircraft penetration of FLOT. All fire must cease five minutes before aircraft enter the impact or trajectory area.

4.3.2 Penetrate FLOT into enemy territory

- Description: Attack helicopters must pass through the heavily defended and congested area of the FLOT using special tactics and procedures for this area to defeat enemy defenses and to prevent attack from friendly forces. Each company will usually penetrate at different location. This resembles a passage of lines of ground forces.
- Why do we need this activity: Must penetrate FLOT to get to target area
- When NOT to add this activity: If no FLOT or if mission begins in enemy rear area - usually never
- If task not performed, how much riskier will be the parent activity: N/A
- BOS or sub-BOS:
- Synchronization matrix: Yes
- Start relative to other tasks: after 4.3.1 ends
- End relative to other tasks: before 4.3.3
- Minimum duration (hours): 5 minutes
- Maximum duration (hours): 15 minutes
- Location relative to parent task: at FLOT
- Performed by the same unit as parent task: yes
- Units which perform this task: Aviation co groups - three companies per battalion will penetrate at different locations, if possible due to terrain, enemy forces
- How much of unit needed (percent): 100
- Reaction or counteraction to parent task:
- Support relation to parent unit: same unit
- Which enemy units will oppose this activity: all enemy forces along FLOT

Anything else that is important to decide about this activity: Aircrews will determine location of FLOT penetration based on enemy defenses, terrain, and other tactical considerations.

4.3.3 Travel to battle points/engagement area

- Description: Attack Aviation flies to engagement and enters battle points for the attack. Route determined by tactical considerations, such as, enemy defenses, distance, terrain, day/night, weather. Each company will take a separate route for maximum security.
 - Why do we need this activity: Aircraft must fly to target area
 - When NOT to add this activity: never
 - If task not performed, how much riskier will be the parent activity: N/A - must be performed
 - BOS or sub-BOS: Maneuver
 - Synchronization matrix: Yes
 - Start relative to other tasks: after 4.3.2
 - End relative to other tasks: before 4.3.4
 - Minimum duration (hours): 20 minutes
 - Maximum duration (hours): 1
 - Location relative to parent task: enemy rear area
 - Performed by the same unit as parent task: yes
 - Units which perform this task: Aviation Battalion/co in company groups
 - How much of unit needed (percent): 100
 - Reaction or counteraction to parent task:
 - Support relation to parent unit: same unit
 - Which enemy units will oppose this activity: ADA along route, ground forces along route
- Anything else that is important to decide about this activity:

4.3.4 Attack Targets

- Description: Attack helicopters move to battle points and identify target. Aviation companies attack targets in sequence and reattack to provide maximum effect and mutual support in accordance with training and attack plan.
- Why do we need this activity: Essential to success - purpose of whole task
- When NOT to add this activity: Enemy target not located. Situation not as predicted and attack not indicated: friendly, noncombatant or neutral forces in area.
- If task not performed, how much riskier will be the parent activity: Slight increase in risk, but probable unsuccessful outcome
- BOS or sub-BOS: Maneuver
- Synchronization matrix: Yes
- Start relative to other tasks: after 4.3.3
- End relative to other tasks: before 4.3.8
- Minimum duration (hours): 5
- Maximum duration (hours): 30
- Location relative to parent task: enemy rear area
- Performed by the same unit as parent task: yes
- Units which perform this task: Aviation Battalion/co attack units
- How much of unit needed (percent): 30-100 of Battalion, 100 of co
- Reaction or counteraction to parent task:
- Support relation to parent unit: self
- Which enemy units will oppose this activity: forces in target area

Anything else that is important to decide about this activity: The battle force commander must decide to attack based on identification of proper target. Unexpected conditions may force commander to cancel attack or move target location.

4.3.5 Assess damage to target

- Description: During and after the attack, the attack forces must determine the damage to the target and the effectiveness in achieving mission objectives. For example, the mission objective may be to delay or disrupt movement of an enemy force to the front. In this case, it is not necessary to destroy the unit because fewer losses may be enough to stop the unit or render it ineffective. Information collected in this task is used later to determine the need for another attack or other response.
- Why do we need this activity: Essential to determine effectiveness of attack and to determine need for further action.
- When NOT to add this activity: Never - conditions may limit ability to collect information however.
- If task not performed, how much riskier will be the parent activity: Slightly
- BOS or sub-BOS:
- Synchronization matrix: Yes
- Start relative to other tasks: after 4.3.4
- End relative to other tasks: before 4.3.8
- Minimum duration (hours): 5
- Maximum duration (hours): 30
- Location relative to parent unit task: in enemy rear area
- Performed by the same unit as parent task: yes -
- Units which perform this task: attack co/Battalion aircrews observe damage
- How much of unit needed (percent): 30-100
- Reaction or counteraction to parent task:
- Support relation to parent unit: same unit
- Which enemy units will oppose this activity: enemy units around target area

Anything else that is important to decide about this activity: Aircrews observe damage and report it to intelligence staff during debriefing (4.2.2). Corps/div/Brigade determines need for additional missions.

4.3.6 Report damage to target and friendly forces

- Description: Enemy damage report used by commander (corps/div/Brigade) to determine need for reattack and for effect of friendly operations if enemy force arrives at FLOT. Friendly damage used to determine need for repair, recovery of downed aircrews, recovery of sensitive material, and destruction of lost equipment.
- Why do we need this activity: Battle damage needed to determine effectiveness of mission and need for another mission.
- When NOT to add this activity: Never - report may be delayed by communications limitations.
- If task not performed, how much riskier will be the parent activity: slightly
- BOS or sub-BOS: C2, IN

- Synchronization matrix: Yes
 - Start relative to other tasks: after 4.3.5
 - End relative to other tasks: as soon as possible, but not later than 4.4.2
 - Minimum duration (hours): 5 minutes
 - Maximum duration (hours): 2
 - Location relative to parent task: Ideally in target area, but possibly enroute to recovery base
 - Performed by the same unit as parent task: no
 - Units which perform this task: attack co aircrew members
 - How much of unit needed (percent): 5
 - Reaction or counteraction to parent task:
 - Support relation to parent unit: same unit
 - Which enemy units will oppose this activity: enemy EW comm jamming
- Anything else that is important to decide about this activity: Aircrews decide how much to report and contents of report while airborne. Follow-up debriefing (4.4.2) included thorough description of all information.

4.3.7 Recover downed aircrew members

- Description: If aircraft have to land enemy territory, they must be recovered by friendly forces, either aviation or ground. This might not be possible immediately or at all depending on the situation.
 - Why do we need this activity: Preserve aircrew resources for future missions
 - When NOT to add this activity: When prevented by enemy activity
 - If task not performed, how much riskier will be the parent activity: slightly - may cause greater risk to future missions if aircrews not available or if enemy gains tactical information from prisoners
 - BOS or sub-BOS:
 - Synchronization matrix: Yes
 - Start relative to other tasks: after 4.3.2
 - End relative to other tasks: before 4.3.10
 - Minimum duration (hours): 15 minutes
 - Maximum duration (hours): 1
 - Location relative to parent task: along ingress/egress routes or in target area
 - Performed by the same unit as parent task: yes
 - Units which perform this task: attack aircrews
 - How much of unit needed (percent): 30-100
 - Reaction or counteraction to parent task: counteraction to enemy actions
 - Support relation to parent unit: same unit
 - Which enemy units will oppose this activity: units along ingress/egress routes or in target area
- Anything else that is important to decide about this activity: Possibility of recovery depends on local situation, including enemy defenses and friendly forces

4.3.8 Travel back to FLOT

- Description: After ending the attack, the helicopters must travel from the target area to the recovery area using different routes for each company and different routes from the ingress. Routes selection is similar to ingress route selection.
 - Why do we need this activity: Aircraft must return to friendly area
 - When NOT to add this activity: never
 - If task not performed, how much riskier will be the parent activity: N/A
 - BOS or sub-BOS: Maneuver
 - Synchronization matrix: Yes
 - Start relative to other tasks: after 4.3.5
 - End relative to other tasks: before 4.3.10
 - Minimum duration (hours): 15 minutes
 - Maximum duration (hours): 1
 - Location relative to parent task: enemy rear area to FLOT
 - Performed by the same unit as parent task: yes
 - Units which perform this task: attack co aircrews
 - How much of unit needed (percent): 30-100
 - Reaction or counteraction to parent task:
 - Support relation to parent unit: same unit
 - Which enemy units will oppose this activity: units along egress routes, ADA
- Anything else that is important to decide about this activity:

4.3.9 Fire SEAD for penetration of FLOT

- Description: Friendly FA fires SEAD to suppress enemy air defense and to create diversion during flight across FLOT.
- Why do we need this activity: Diverts and confuses enemy air defense so aircraft can fly safely across FLOT
- When NOT to add this activity: If no FLOT or no enemy forces
- If task not performed, how much riskier will be the parent activity: Extremely
- BOS or sub-BOS: FS
- Synchronization matrix: Yes
- Start relative to other tasks: Before 4.3.10 (5-15 minutes)
- End relative to other tasks: Five minutes before 4.3.10
- Minimum duration (hours): 5 minutes
- Maximum duration (hours): 15 minutes
- Location relative to parent task: along FLOT
- Performed by the same unit as parent task: no
- Units which perform this task: supporting FA units
- How much of unit needed (percent): 100 Bty, 30-100 Battalion
- Reaction or counteraction to parent task: enemy may return counterbattery fire
- Support relation to parent unit: DS
- Which enemy units will oppose this activity: enemy units which can detect and attack the FA bty

Anything else that is important to decide about this activity: SEAD must be synchronized with returning aircraft times and routes. Aircraft should not fly across target area or through trajectory of fire support during SEAD.

4.3.10 Penetrate FLOT into friendly territory

- Description: Aircraft penetrate the FLOT along different routes to avoid enemy air defense and friendly fires. This resembles a passage of lines of ground forces
- Why do we need this activity: Aircraft must return to base
- When NOT to add this activity: If no FLOT
- If task not performed, how much riskier will be the parent activity: N/A - must penetrate FLOT to return from enemy area
- BOS or sub-BOS: Maneuver
- Synchronization matrix: Yes
- Start relative to other tasks: after 4.3.8, five minutes after 4.3.9 ends
- End relative to other tasks: before 4.3.11
- Minimum duration (hours): 5 minutes
- Maximum duration (hours): 20 minutes
- Location relative to parent task: through FLOT in several locations (one per Aviation co)
- Performed by the same unit as parent task: yes
- Units which perform this task: Aviation co returning from mission
- How much of unit needed (percent): 30-100 Aviation Battalion, 100 co
- Reaction or counteraction to parent task:
- Support relation to parent unit: same unit
- Which enemy units will oppose this activity: ADA and units along FLOT

Anything else that is important to decide about this activity: Aviation co will use different points to exit enemy area than they used to enter enemy area, if possible. What points should they penetrate the FLOT depends on enemy forces and ADA defenses and friendly SEAD capabilities.

4.3.11 Recover aircraft

- Description: This task includes travel from FLOT to landing area. Aircraft land in a forward assembly area or return to corps/div rear area depending of distance from target. Aircraft must not reveal location of landing area to enemy or remain in the forward area longer than necessary (perhaps one hour). Aircraft cycle through FARP to fuel and arm for next mission (4.1.1).
- Why do we need this activity: Aircraft must land after mission
- When NOT to add this activity: never
- If task not performed, how much riskier will be the parent activity: N/A
- BOS or sub-BOS: Maneuver
- Synchronization matrix: Yes
- Start relative to other tasks: After 4.3.10
- End relative to other tasks: before 4.4
- Minimum duration (hours): 20 minutes
- Maximum duration (hours): 1

- Location relative to parent task: near FLOT in friendly area
 - Performed by the same unit as parent task: yes
 - Units which perform this task: Aviation Battalion/company
 - How much of unit needed (percent): 30-100 Battalion, 100 co
 - Reaction or counteraction to parent task:
 - Support relation to parent unit: same unit
 - Which enemy units will oppose this activity: units able to detect and attack landing areas
- Anything else that is important to decide about this activity: Forward assembly areas and FARPs usually in different location from ingress to prevent detection. Areas should be near logistic support, but away from ground combat operations.

4.4 Recover from Deep Attack Operation

Description: This task includes operations to complete the attack mission, assess results, and prepare for later missions. Aircraft will return to the corps/division rear area or launch on subsequent missions. All units must change location to prevent detection and attack by enemy.

4.4.1 Fuel and arm aircraft

- Description: Aircraft will fuel and arm as quickly as possible by cycling through the FARPs. Crews will inspect aircraft for damage and make hasty repairs so aircraft can return to rear area. Aircraft may launch on subsequent missions or return to rear area (4.4.6).
- Why do we need this activity: Aircraft cannot fly without fuel and cannot fight without arms.
- When NOT to add this activity: Do not arm aircraft if they are returning to rear area.
- If task not performed, how much riskier will be the parent activity: moderately - must refuel if required to return to rear area
- BOS or sub-BOS: CSS
- Synchronization matrix: Yes
- Start relative to other tasks: after 4.3.11
- End relative to other tasks: before 4.4.7
- Minimum duration (hours): 1
- Maximum duration (hours): 3 - duration depends on number of aircraft and capabilities of FARPs
- Location relative to parent task: forward area near FLOT
- Performed by the same unit as parent task: yes
- Units which perform this task: Aviation Battalion maintenance/aircrew personnel or FARP
- How much of unit needed (percent): 20
- Reaction or counteraction to parent task:
- Support relation to parent unit: same unit
- Which enemy units will oppose this activity: FA or ground units which can detect and attack FAA

Anything else that is important to decide about this activity: Should FARP locate at FAA.
Should units depart after servicing.

4.4.2 Debrief aircrews

- Description: Aircrews must report details of mission and enemy battle damage so corps/division staff can determine success and need for follow-up mission. Aircrews debrief to intel personnel as soon as possible after landing. Aircrews make preliminary in-flight report after the attack (4.3.6), but this task is a more thorough report.
 - Why do we need this activity: determine success and need for follow-up response, change to battle plans, additional attack mission, other response to enemy operations.
 - When NOT to add this activity: never - debriefing might be delayed by communications problems.
 - If task not performed, how much riskier will be the parent activity: Moderately - risk is to subsequent operations which need information about enemy force
 - BOS or sub-BOS: IN
 - Synchronization matrix: Yes
 - Start relative to other tasks: after 4.3.11
 - End relative to other tasks: before 4.4.3
 - Minimum duration (hours): 15 minutes
 - Maximum duration (hours): 1
 - Location relative to parent task: forward assembly area, if that is where the aircraft land. Otherwise, at corps/division rear area.
 - Performed by the same unit as parent task: yes - intel and aircrew personnel
 - Units which perform this task: Aviation aircrews and intel personnel
 - How much of unit needed (percent): 20
 - Reaction or counteraction to parent task:
 - Support relation to parent unit: same unit
 - Which enemy units will oppose this activity: none
- Anything else that is important to decide about this activity: intel personnel must forward information to corps/div for evaluation and integration into battle plan

4.4.3 Evaluate effect of damage to target

- Description: Corps/div/Brigade intel personnel and operations staff evaluate effect of damage to target for desired results and determine need for follow-on operations (4.4.4).
- Why do we need this activity: determine need for follow-on operations and effect on friendly battle plans.
- When NOT to add this activity: never - results may be hard to determine
- If task not performed, how much riskier will be the parent activity: moderately
- BOS or sub-BOS: IN
- Synchronization matrix: Yes
- Start relative to other tasks: after 4.4.2 - debriefing must be relayed to corps/div/Brigade staff
- End relative to other tasks: before 4.4.4
- Minimum duration (hours): 1
- Maximum duration (hours): 4
- Location relative to parent task: corps/div/Brigade command post
- Performed by the same unit as parent task: no
- Units which perform this task: corps/div/Brigade staff

- How much of unit needed (percent): 10
 - Reaction or counteraction to parent task:
 - Support relation to parent unit:
 - Which enemy units will oppose this activity: none
- Anything else that is important to decide about this activity: corps/div must decide follow-on operations or response to evaluation (4.4.4)

4.4.4 Determine need for follow-on attack

- Description: Based on evaluation of attack results, corps/div staff decides need to reattack target.
 - Why do we need this activity: Reattack might be required to achieve desired effect on enemy operations.
 - When NOT to add this activity: if enemy will have no effect on friendly operations
 - If task not performed, how much riskier will be the parent activity: moderately
 - BOS or sub-BOS: IN, C&C
 - Synchronization matrix: Yes
 - Start relative to other tasks: after 4.4.3
 - End relative to other tasks: no relation. Might generate another attack mission.
 - Minimum duration (hours): 1
 - Maximum duration (hours): 4
 - Location relative to parent task: corps/div/Brigade command post
 - Performed by the same unit as parent task: no
 - Units which perform this task: corps/div/Brigade staff
 - How much of unit needed (percent): 10
 - Reaction or counteraction to parent task:
 - Support relation to parent unit:
 - Which enemy units will oppose this activity: none
- Anything else that is important to decide about this activity:

4.4.5 Move FARP

- Description: Activity around FARP might reveal its location to enemy, who might attack the FARP. FARP should move as soon as it refuels aircraft if it is in sensitive location.
- Why do we need this activity: Protect FARP from attack. Prevent loss of servicing capability.
- When NOT to add this activity: If FARP is in secure location. If enemy units cannot detect and attack FARP.
- If task not performed, how much riskier will be the parent activity: Moderately
- BOS or sub-BOS: CSS
- Synchronization matrix: Yes
- Start relative to other tasks: after 4.4.1 ends
- End relative to other tasks: no relation
- Minimum duration (hours): 1

- Maximum duration (hours): 4 - duration depends on distance to new location and travel conditions.
 - Location relative to parent task: forward area
 - Performed by the same unit as parent task: no
 - Units which perform this task: FARP
 - How much of unit needed (percent): 100
 - Reaction or counteraction to parent task:
 - Support relation to parent unit: DS - FARP is part of Aviation Battalion
 - Which enemy units will oppose this activity: units which can detect and attack FARP
- Anything else that is important to decide about this activity: When to move FARP. Where to go. Route.

4.4.6 Move field artillery

- Description: Similar to moving FARP (4.4.5), the FA bty must move after firing. FA units easily detected by enemy radar and are quickly targeted by enemy counterbattery fire. FA units must move quickly after firing missions or risk being attacked by enemy.
 - Why do we need this activity: To prevent attack by counterbattery fire.
 - When NOT to add this activity: if no enemy units can detect and attack FA
 - If task not performed, how much riskier will be the parent activity: extremely
 - BOS or sub-BOS: FS
 - Synchronization matrix: Yes
 - Start relative to other tasks: after 4.3.9
 - End relative to other tasks: no relation - unit should be in position to fire next mission
 - Minimum duration (hours): 30 minutes
 - Maximum duration (hours): 2
 - Location relative to parent task: forward area, within 10 km of FLOT
 - Performed by the same unit as parent task: no
 - Units which perform this task: FA batteries
 - How much of unit needed (percent): 30-100 Battalion, 100 bty
 - Reaction or counteraction to parent task:
 - Support relation to parent unit: DS
 - Which enemy units will oppose this activity: units which can detect and attack FA bty
- Anything else that is important to decide about this activity: When to move. Route to new location. New location.

4.4.7 Move aircraft to rear

- Description: After aircraft refuel in FAA, they move to rear area for repair and tasking to another mission.
- Why do we need this activity: to reduce vulnerability to enemy attack
- When NOT to add this activity: if enemy not a threat, not within range, cannot attack
- If task not performed, how much riskier will be the parent activity: moderately
- BOS or sub-BOS: Maneuver
- Synchronization matrix: Yes

- Start relative to other tasks: after 4.4.2
- End relative to other tasks: final action
- Minimum duration (hours): 30 minutes
- Maximum duration (hours): 1 - duration depends on distance to rear area and route
- Location relative to parent task: corps/div rear area
- Performed by the same unit as parent task: yes
- Units which perform this task: Aviation Battalion/co
- How much of unit needed (percent): 30-100 Battalion, 100 co
- Reaction or counteraction to parent task:
- Support relation to parent unit: same unit
- Which enemy units will oppose this activity: enemy units along FLOT

Anything else that is important to decide about this activity: If aircraft are tasked for another mission, should they launch from FAA or from rear area - depends on time of mission, distance to target, enemy threat.

Model of a Deep Attack in CADET

Activities prior to Deep Attack

SEAD #1, direct fire, indirect fire, electronic weapons (jamming)
Deception (false crossing of FLOT - simulate deep attack at different Locations);
Ways IEW aircraft from Air Force to support for jamming
Also try to get CAS A-10, dual threat for En, they Joint Air Attack Team (fixed wing + rotary)
SEAD is Corps level effort, but most assets will come from Div
UAV is great for BDA, for clearing routes, etc.
Jamming is part of SEAD

SEAD - MLRS beyond FLOT, cannon DIVARTY at FLOT, MI Battalion, some forward deployed forces (e.g., tank Battalion at FLOT would be req'd to suppress En by fire of even demonstration)
Seconds before crossing the FLOT (to avoid revealing the route)

May do false SEAD - deception.

May specify additional ISR activities, but little Div can do, perhaps UAV controlled by Div

Position FARP fuel, and ammo, not too early (easy to find), 30 min before helos arrive for refuel/rearm, takes 45 min to set up, then move out. One FARP would be enough.

Activities During Deep Attack

Attack itself: load, trip to station, on-station, trip back, rearm/refuel and repeat if multiple rotations required

one company fires, another loiters (hovers?)

SEAD repeated on way back.

During ATTK may support with MLRS, either at tanks or En ADA; may set FASCAM ; may continue some jamming

AH-64 has capability of self-SEAD (jamming, firing at ADA assets) - not an ideal solution

Attributes of Key Activities of the Deep Attack

- Friendly assets:
 - Apache (AH-64) battalions of the Aviation Brigade
 - CAS - A-10 - Air Force (requested from Corps)
 - MLRS
 - FA

Always take at least two companies

May take more cannon, take fewer Hellfire

Number of CAS sorties is allocated by CMRD

Attack Helicopter Battalion may have 18-24 helos ; 3 companies

- Time to station, on station, return trip

Time on station must be minimum; can be matter of minutes, but not likely; typical is about 15 minutes (given good intel and enough shooters) no good guidance about time on station; depends on enemy formation, etc. How long to acquire target, fire, etc.? Target acquisition and maneuvering into position (different for each missile).

For trip to station and back use 90 km/hr; might assume FARP 15-20 km behind FLOT

- Total req'd time for the attack
calculate what time is req'd to accomplish the entire deep battle
(all rotations, sorties, etc.) - see Marne Division planning booklet.

How much time required for a given number of sorties of CAS?

May assume sorties in pairs; 3 pairs per hour (6 sorties per hour?)

- Preferred time: AH-64 - should be night attack, otherwise use CAS or MLRS or Arty is better
- How many Friendly sorties required:

Avoid re-attacking with the same unit; more risk, try use more units and try do in one shot
Do not use same air axis of attack

Enemy TK REGT has 135 tanks, assume partial strength
assume 93 med. Tanks on the ground, 50% missiles hitting,

Number of Missiles of aircraft (16 max. with min. rockets and cannon and fuel) 40 mm self-defense, rocket for illumination. And smoke, for deep attack usually rockets but do carry ammo for self defense; fuel dependent on how far to go; Hellfire is the typical missile

- Fr attrition

Depends on terrain, ADA of forces,

If ADA is strong, position is hard, e.g., compartmentalized terrain (req's getting close to target) ADA if they have SA13 covering remotely, ZSU (Soviet ADA) is not hard, but SA8 + shoulder-fired missiles, even main gun of tank

Assume En is Top of line Soviet, desert terrain,

Battalion has 25 AH-64, if you lose 2 out of 6 - real bad;

10:1; 12:1; 15% - all ring true

Mission abort if loses more than trigger number of losses

- Req's throughput capacity of FARPs

how many FARPs do I need for this operation - see Marne capacity (expressed in minutes per Aviation Co, perhaps?) of each FARP - see Marne typically should do 20-30 minutes per company

Brigade can have at most 2 FARPs

- Req'd resupply of Class III and V
calculate how much of Class III and V will be needed for this operation - see Marne

Activities After Deep Attack

After: recovery of crew and A/C. Search and rescue is in Air Force; Aviation Battalion may try Blackhawk to use for rescue, not best solution. For recovery need Corps Chinooks

Damage Assessment (probably Corps assets, or Air Force)

Maintenance - some helos come damaged, Aviation Maintenance assets will do.

plan evacuation of downed birds, send rescue teams, to retrieve crew and aircraft, destroy if capture is possible.

rescue teams come from the Brigade that controls the zone;
Aviation Brigade provides AirCraft for rescue team.

Post attack resupply of the Aviation Brigade

En reactions

- maintain radar silence - basic ADA technique
- tanks will disperse will try to find place to hide (a hole, or terrain mask), a place that exposes shooter and limits shooter's directions approach

- smoke is a good technique
- call En ARTY at the battle position (hovering position) against helos
- maneuver ADA to get at helos
- bring forward fixed-wing assets

Fr Counteraction

- don't fire more than once from same firing positions
- cannot do much about smoke

Appendix 18. Modeling for Air Operations Planning.

The memorandum is divided in the following sections:

- Overview
- Proposed Scope Limits, Simplifications, Priorities
- Appendix: Aviation Planning from the draft "Marne Division Command, Control and Planning Guide"

Section 1. Introductory Overview

In the following, we summarize key aspects of the problem of analysis of a deep attack with air assets, focusing mainly on those issues that appear to be relevant to CADET.

Prior to the analysis phase, the following is determined and communicated to the planning staff:

1. enemy targets to be engaged;
2. nature of targets (e.g., type of En weapon systems, extend of ADA capabilities, soft or armored);
3. start time window of the attack;
4. end time window of the attack
5. criteria: En defeat or degree of attrition (e.g., reduce by 30%)
6. friendly assets to be involved (e.g., 1 Avn Bn and 20 CAS sorties)
7. method of attack (continuous, phased, max. destruction)
8. air axis of attack

During the analysis, these can be modified, although items 1,2 and 5 are not commonly modified.

In addition to potentially modifying the above parameters, the analysis process must determine the following:

1. En attrition
2. Fr attrition
3. Fr supporting actions (SEAD, deception, ISR, FARP, use of MLRS, FASCAM, recovery, rescue, maintenance)
4. En reactions (may include: withdraw, disperse and take static positions, ADA fires, smoke, use of fixed-wing assets, etc.)
5. En rate and direction of movement during the attack
6. Locations of AA, forward AA, FARP
7. Required number of sorties, rotation
8. Time to station, on station, return trip
9. Required throughput capacity of FARP (how many minutes per company)
10. Required resupply of Class III and V

Section 2. Proposed Scope Limits and Simplifications

In CADET, we propose to limit the scope of the computations and reasoning about air operations as follows:

- only deep attack by Army AH-64 will be considered
- only continuous method of attack will be considered
- will not suggest or otherwise consider air axis of attack
- will not suggest locations of AA, forward AA, FARP

CADET will estimate the following for a deep attack:

1. Required number of sorties of AH-64s, based on the desired En attrition; En attrition will be estimated using guidelines in ST 101-5, Fig. 4-8;
2. Fr attrition for AH-64 (using loss ratio guidelines in ST 101-5, Fig. 4-8);
3. Time to station, on station, return trip similarly to computations in Appendix 1 and also using time-distance guidelines of ST-101-5, Table 4-6; will assume FARP location 15 km behind the FLOT;
will assume 15 minutes on station;
4. Number of rotations and total required time for the attack based on items 3 above;
5. Required number and throughput capacity of FARPs, similarly to computations in Appendix 1;
6. Required resupply of Class III and V, similarly to computations in Appendix 1;

CADET will suggest activities related to the deep attack, when appropriate (specific rules-of-thumb are TBD):

- En reaction will be assumed dispersion and taking of static defensive positions while employing available ADA;
- Fr counteractions (such as SEAD, jamming, counterbattery, C2 disruption, rescue missions) will be proposed;
- Required rearm/refuel activities;
- Required maintenance activities.

Like with all other activities, CADET will propose assignment of time and assets to these aviation employment activities, attempting to satisfy desired timing of the attack and taking into account availability of assets, other demands on the same assets, and precedence constraints between activities.

Appendix 1

The following is an excerpt from the draft "Marne Division Command, Control and Planning Guide."

This section describes the continuous attack method of employing two attack helicopter companies in battle for a 6 hour period.

1. Assumptions.
 - a. Composition is two attack helicopter battalions, task organized as one battalion composed of two companies, and one battalion composed of four companies. Each company is made of three (3) OH58 and five (5) AH1

aircraft. Two companies will be in the battle, thus maintaining a total of 10 attack helicopters on station simultaneously.

- b. Each battalion has 100% equipment, aircraft and personnel.
- c. AH-1 loading. Aircraft will depart the FARP with a minimum of 1200 lbs of fuel to give 1:40 flight time and loaded with 6 TOW missiles, 350-400 rounds of 20mm and a minimum amount of rockets (10 or less).
- d. FARP operations will include two FARP's, one for each battalion. Each FARP has six (6) refuel points and three (3) rearm points (see diagram). Normal operations can rearm/refuel a company in 30 minutes.
- e. FARP enroute travel times will vary based upon distance to the battle.

<u>DISTANCE TO BATTLE</u>	<u>TIME ENROUTE</u>
15 Km	12:30 min
20 Km	15:00 min
27 Km	20:00 min
40 Km	25:00 min

Doctrinal FARP locations should be 15-30 Km behind the FLOT based upon METT-T and out of medium field artillery range.

2. Scenario:

- a. Estimated times used for this example.

Battle Duration = 40 minutes (includes 5 minutes to handover battle to the relieving companies when necessary).

Enroute time to FARP = 25 minutes (FARP 27 Km)

Return to holding area (25:00) and accept battle handover and move into battle positions (5:00) = total 30:00

FARP rearm/refuel = 30 minutes

- b. Execution - see example matrix and graph (figure)

- c. Total In-Battle rotations - 18 company/teams

Total FARP rotations - 12 company/teams

Total ammunition fired = 540 TOWs; 36,000 rounds 20mm; 900 rockets

Total Fuel Used = 18,529 gal. AH-1

3,176 gal. OH-58

21,705 gal. Total

- d. FARP utilization (Class III and V not already loaded on the aircraft) Total ammunition FARP loaded = 360 TOWs, 24,000 rounds of 20mm, 600 rockets.

Total fuel FARP loaded = 12,353 gal. AH-1

2,118 gal. OH-58

14,471 gal. Total

This will require 6 refuel HEMMTs and six ammo HEMMTs with complete basic load of class III and V.

- e. This planning doesn't include battle losses we may incur, which may be up to 15% per rotation, per team. If so, each battalion would lose 3-4 OH-58's and 6-7 AH-1 aircraft during this time, and ammunition and fuel requirements would be lowered.

		N hour									
		:15	:30	:45	1:00	1:15	1:30	1:45	2:00	2:15	
"A"	BATTL			ENRO	REAR		ENROUTE		BATTLE		
Bn/Co?	E			UTE	M,		BATTLE		ENROUTE		
TM#1				FARP	REFU						
& 2					EL					FARP	
"B"	HOLDI	BATT		ENRO		ENROUTE			BATTLE		
Bn/CO/	NG	LE		UTE	REAR	REFUEL			BATTLE		
TM#1	AREA			FARP	M						
& 2											
"B"	HOLDI			BATT		ENROUTE			ENROUTE		
Bn/CO/	NG			LE		REARM			FARP		
TM#3	AREA								REFUEL		
& 4									BATTLE		

18 CO/TM ROTATIONS IN BATTLE
 12 CO/TM ROTATIONS IN FARP

Figure III-II

Appendix 19. Activity model for Movement to Contact

Movement to contact

1. Prepare to move
 - Organize for combat
 - Position engineers near front to respond to counter-mobility obstacles.
 - Position artillery to provide continuous coverage.
 - Position air defense assets to provide continuous coverage.
 - Position communications assets to provide continuous coverage.
 - Position sensors to provide continuous coverage.
 - Update Enemy Situation and expected Enemy COA
 - Rearm, refuel as needed
 - Rehearse
 - Employ advance security force
 - Employ advance guard
 - Employ flank security
 - Employ rear security
 - Perform route reconnaissance.
 - Update movement plan
2. Move
 - Move along route.
 - Reduce counter-mobility obstacles
 - Re-position artillery to provide continuous coverage.
 - Re-position air defense assets to provide continuous coverage.
 - Re-position communications assets to provide continuous coverage.
 - Re-position sensors to provide continuous coverage.
 - Update Enemy Situation and expected Enemy COA
 - Rearm, refuel, fix enroute using tailgate support.
 - Move support elements by echelon to provide continuous support.
 - Perform resupply
 - Secure LOCs to protect logistics elements or
 - Travel with field trains and forego any connection to base element or
 - Rely on alternate means of resupply: airdrop, airlift, UAV, cache, capturing enemy stores. (We will not model at this time ???)
3. Upon encountering significant obstacles: assess to determine whether to by-pass, reduce, or breach.
 - By-pass
 - Reduce
 - Breach
4. Upon locating enemy forces: assess to determine
 - Is enemy moving or stationary?
 - Does the enemy present a vulnerable flank?
 - Should the BLUE force by-pass, conduct hasty attack or conduct hasty defense?

Transition to Hasty Attack

- Advance security force maintains contact with the enemy.
- Main body maneuvers as needed to reach an assailable flank.

- Artillery re-positions to support attack, if needed.
- Field trains assume temporary support location.
- Intelligence assesses enemy force intentions.
- Employ security to isolate enemy force and prevent surprise.

Transition to Hasty Defense

- Advance security force maintains contact with the enemy.
- Main body assumes best defensive posture based on METT-T.
- Designate and position a counter-attack force.
- Artillery re-positions to support attack, if needed.
- Field trains assume temporary support location.
- Intelligence assesses enemy force intentions.
- Employ flank and rear security to avoid surprise.

Hasty Attack against Moving Enemy

- Advance security force makes initial contact and attempts to develop the situation.
- Advance security force moves to flank and adjusts artillery fire to confuse and suppress enemy
- Fire suppressive artillery fire against flanks.
- Advance security force looks for enemy trying to envelope BLUE.
- Advance guard assumes a defensive position as perpendicular as possible to the enemy direction of movement
- Advance security force identifies assailable flank.
- Main body maneuvers to attack flank.
- Designate a reserve to block penetration of fixing force or to maneuver against any enemy bypassing the engagement area.

Appendix 20. Cadet Functional mapping: Obstacle Breaching

1. Task Description:

U.S. Army maneuver and engineer battalions conduct the breach obstacle task to obtain and maintain the freedom of both tactical maneuver and operational movement. This battlefield task has the following three functional areas:

- Countermine. Detection, neutralization (breach / bypass), marking, and proofing of mined areas.
- Counterobstacle. The employment of tactics and equipment systems to reduce, breach or bypass obstacles other than mined areas.
- Gap crossing. The crossing of gaps in the terrain in order to pass equipment and personnel.

While these functional areas of breach obstacle are discussed separately, they are all used to support an operation and may be accomplished simultaneously. In the offense, the execution of breach obstacle mission allows forces to overcome known or unexpected obstacles and sustain the momentum necessary to retain the initiative. In the defense, the breach obstacle task assists forces to move rapidly, mass, disperse, and be resupplied. The breach obstacle task may be linked because of a mutual purpose and the nature of the battlefield. The three functional types of breach obstacle support activities are similar in the individual missions generated as shown in Table 1 below:

Breach Obstacle Mission		
Countermine	Counterobstacle	Gap Crossing
Detect	Detect	Reconnoiter
Bypass	Bypass	Deploy Assets
Breach	Breach	Prepare Assault site
Mark	Mark	Secure Far Shore
Proof	Report	Construct/Emplace
Report	Reduce	Cross
Clear		

2. Task Definition: Breach is a tactical task where any means available are employed to break through or secure a passage through an enemy defense, obstacle, or fortification (FM 101-5-1).

Breach obstacle training should focus on these criteria:

- Execute under fire. Troops must be trained to immediately suppress enemy fire and to perform their tasks under enemy fire. Mobility activities are undertaken after enemy tank, antitank guided missile, and artillery fire have been suppressed.
- Overcome obstacles in stride. Maneuver forces overcome obstacles with minimum delay by through planning, deploying mobility equipment forward, and by use of standardized drills.
- Execute tasks during darkness. Mobility tasks should be done at night when possible as periods of limited visibility reduce friendly force vulnerability.

3. Types of Breaching Operations:

Attacks take place along a continuum based on the knowledge of the enemy's capabilities, disposition, and intentions and details of the friendly unit's planning and preparation. The two terms "deliberate attack" and "hasty attack" refer to the opposite ends of that continuum and describe characteristics of the attack.

The deliberate attack is characterized by a more complete knowledge of the enemy situation and by more planning and preparation time for the attacking force. With knowledge of the enemy and ample time for planning and preparation, the force conducting the deliberate attack can develop detailed plans, task organize to accomplish the mission and execute rehearsals down to the lowest levels. The term deliberate does not apply to the speed or tempo of attack execution.

The hasty attack is the opposite of the deliberate attack. The hasty attack is defined by a vague / rapidly changing enemy situation and / or by a lack of time for the attacking force to prepare for operations. Since its purpose is to maintain momentum or take advantage of the enemy situation, a hasty attack is normally conducted with resources immediately available.

Breaching operations are categorized by attack type; a deliberate attack requires a deliberate breach with its accompanying planning, reconnaissance, task organization change etc. In a deliberate breach, the engineer commander task organizes his unit to conduct the breach in the most efficient manner. If the maneuver unit is conducting a movement to contact or a hasty attack, then the breach activities are all hasty with the maneuver unit conducting the breach with minimum planning (by use of unit SOP battle drills) in its current task organization with immediately available resources. The hasty breach occurs when the maneuver unit has crossed the LD (Line of Departure) encounters a previously unknown/unexpected obstacle and the tactical situation requires immediate action in the form of a hasty attack.

There is a third case that requires explanation. A unit may be attacked by means of an air or artillery delivered scatterable minefield. Thus, within seconds a unit may find itself trapped mobility wise in the middle of a minefield. The unit must extract itself from this situation by means of a hasty breach entailing a rapidly cleared lane out of the minefield with the available assets. The actions required to perform a minefield extraction are nearly identical to those required for a hasty breach.

4. Breaching Fundamentals:

Suppress, obscure, secure, and reduce (SOSR) are breaching fundamentals that must be applied to ensure success when breaching against a defending enemy. These tactics and techniques apply in all breach operations but may vary slightly based on specific tactical situations.

- **Suppress.** Suppression is the focus of all available fires on enemy personnel, weapons, or equipment to prevent effective fires on friendly forces. Suppressive fires include the full range of weapons from direct and indirect fires, electronic countermeasures, and directed energy. The purpose of suppression is to protect forces reducing and maneuvering through the obstacle and to soften the initial foothold (assault force objective). Effective suppression is the mission-critical task during any breaching operation. Suppressive fires in sufficient volume serve to isolate the breaching site. Successful suppression generally triggers the rest of the actions at an obstacle. Fire control measures are used to ensure that all fires are massed, lifted and shifted synchronized with other actions at the obstacle.

- **Obscure.** Obscuration hampers enemy observation and target acquisition and conceals friendly activities and movement. Obscuration smoke deployed on or near the enemy position minimizes its vision. Screening smoke employed in the breaching area or between the breaching area and the enemy conceals movement and obstacle-reduction activities. It also degrades enemy ground and aerial observation. Obscuration must be employed to protect obstacle reduction, passage of assault forces, and deployment of forces in assault

formations. Obscuration must be carefully planned to provide maximum degradation of enemy observation and fires, but it must not significantly degrade friendly fires and control.

- Secure. The force secures the breaching operation site to prevent the enemy from interfering with obstacle reduction and passage of the assault force through the lanes created during the reduction. Security must be effective against all enemy units that can directly fire at the breaching force. In general, fires secure enemy tactical obstacles.
- Reduce. Reduction means creating lanes through or over the obstacle to allow the attacking force to pass. The number and width of lanes created varies with the situation and type of breaching operation. The lanes must be sufficient to allow the force to cross and accomplish the mission. Lanes are handed over to follow-on forces by the breaching element. The unit reducing the obstacle will mark and report obstacle and lane locations and conditions to higher headquarters. Follow on units will further reduce or clear the obstacle when possible. Reduction cannot be accomplished until the other SOSR breaching fundamentals are applied and become effective. The force must synergistically isolate the breaching site and overwhelm the defender before reduction can proceed and the breach can be exploited.

5. Breaching Organization:

The commander organizes the force to accomplish SOSR breaching fundamentals quickly and effectively. This requires him to organize support, breach, and assault forces with the assets needed to accomplish their roles. Usually, engineer units compose the majority of the breaching element. A breaching operation is the maneuver commander's responsibility. The operation is comprised of a headquarters (controlling agency) and the three distinct entities discussed below:

- Assault Force. The assault force's primary mission is to destroy or dislodge the enemy on the far side of the obstacle. In most breaching operations, it secures the far side by physical occupation. The assault force may be tasked to assist the support force with suppression while the breach force reduces the obstacle.
- Support Force. The support force must eliminate the enemy's ability to interfere with the breaching operation. It must isolate the battlefield with fires and suppress enemy fires covering the obstacle and control obscuring smoke to prevent enemy-observed fires.
- Breach Element. The breach element's mission is to create the lanes that enable the attacking force to pass through the obstacle and continue the attack. It is also responsible for marking the lanes along the lane's length, report the exact location of the lane entry point and assist the passage of the assault force through the created lane.

The breach element is a combined arms force. It normally includes engineers, but always contains breaching assets/supplies and enough maneuver force to provide local security. Since the support force may not be in the position to effectively observe and suppress all enemy direct-fire systems, the breach element must be capable of providing its own suppressive fires. The breach element employs vehicle-mounted smoke systems and smoke pots for self-defense and to cover lanes while the assault force is passing through them. The breach element protects itself from small threat forces that are providing short-range protection of the obstacle. After reducing the obstacle, the breach element may be required to secure a lodgment on the far side for deployment of the assault force into an assault formation.

The breach element must be able to deploy and reduce obstacles as soon as enemy fires have been suppressed since it can expect enemy artillery fires within a matter of minutes. The engineers with the breach element are allocated / organized by platoons with the breaching assets necessary to handle mines, non-explosive obstacles, and small gaps. They also look for pre-existing local bypasses or pre-existing lanes. Engineer units are allocated and breaching

equipment / supplies based on the number of lanes required. The breach element must be capable of creating a minimum of one lane for each assaulting battalion or two lanes for an assaulting task force. Once the breach element has reduced the obstacle and passed the assault force through, it will hand over the lane to follow-on units. The lanes must be marked and their locations / conditions reported to higher headquarters and follow-on units as prescribed in the unit's standing operating procedure.

6. Vignette: The following scenario illustrates a battalion task force (TF) attack conducting a deliberate breach at night:

The TF mission is to breach the northern motorized rifle company (MRC) of a defending motorized rifle battalion (MRB) for the purpose of allowing the brigade main effort to move in the northern avenue of approach. Based on the TF's mission, the commander directs the staff to develop the COA depicted below. Previously, the S2 and the engineer developed an enemy situational template (SITEMP) depicting the enemy's probable defensive posture, including obstacle and fortifications also depicted below.

The maneuver unit's COA calls for a supporting attack (support force) in the north with a mechanized company team. The company will destroy the enemy combat security outpost, then move to support-by-fire positions to suppress the enemy during the breach for the purpose of denying the enemy the ability to reposition forces reacting to the breach in the south. This mechanized team receives a tank platoon equipped with two tank plows. A mechanized team (breach force) will breach the tactical obstacles in the south and destroy the southern motorized rifle platoon (MRP) allowing the TF main effort to move to destroy the center (MRP) from a flank. An engineer platoon is cross-attached to the mechanized company team. This platoon is equipped with two MICLICs. The mechanized company team will also have a plow-equipped tank platoon with two plows. The engineer company (-), with the breach force, will reduce the obstacles in the south, allowing the main effort (assault force) to destroy the remaining enemy forces. The main effort is tank team with 2 tank and 1 mechanized platoon.

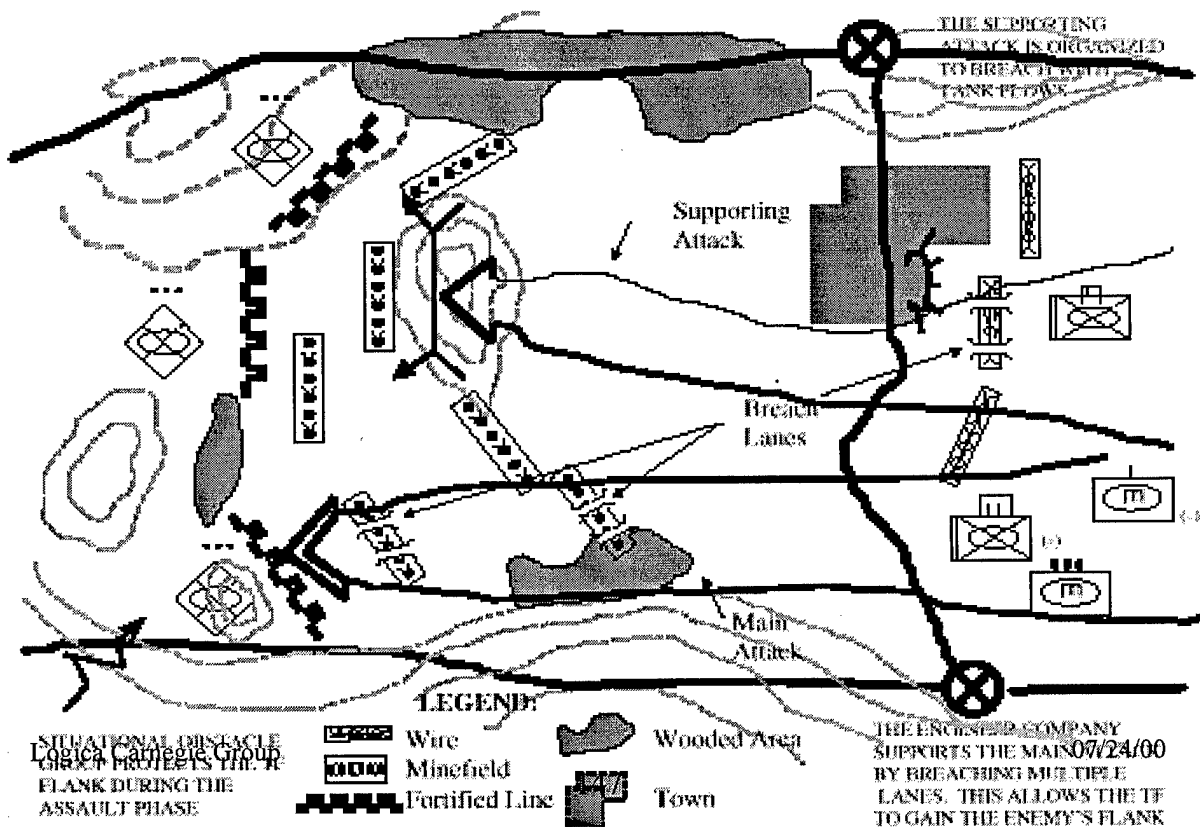

At H-hour, both companies simultaneously cross the line of departure. The northern company team clears two lanes in the wire obstacles to their front using bangalore torpedoes. The company moves through the lanes and destroys the enemy combat outpost.

The company team in the south, with its attached engineer platoon, bypasses the enemy wire obstacles and proceeds toward its objective, OBJ B. The main effort company team, with the engineer company (-) follows on the main attack axis.

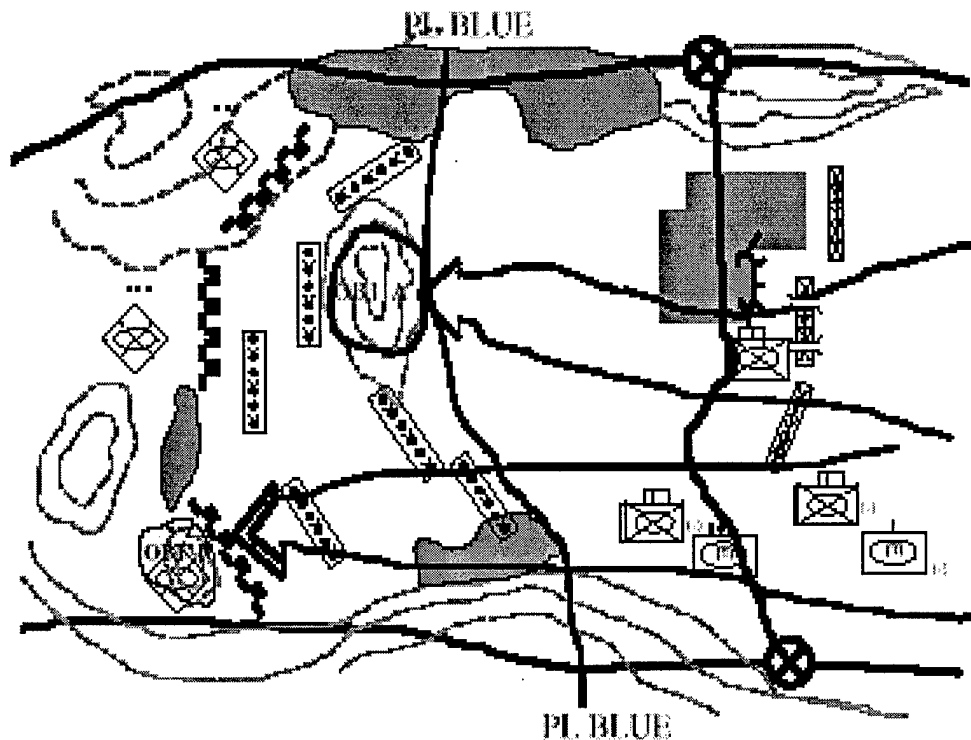

The supporting attack proceeds to and occupies Object A. The company team does not attempt to breach the minefields on the far side of the objective. Rather from this high ground, the company team *supports by fire* the main attack in the south.

The lead company team on the main attack axis (south) reaches the minefields along phase line (PL) Blue. The company team conducts a breaching operation to open two lanes in the minefield. The engineer platoon, as part of the breaching element, uses two MICLICs to open lanes. The engineers move through the lane to ensure it is clear of mines, mark the lanes, and then act as guides for the remainder of the company. The engineer platoon remains at the minefield to guide the remainder of the TF elements through the lanes. **Note: The breach force maneuver company commander may have to organize his unit into a force consisting of a breaching element, a support element, and an assault element. The maneuver company commander organizes his unit into these three elements if the Battalion Task Force support force is not accomplishing its mission or other METT-T considerations.)**

Next the tanks equipped with mine plows breach the minefields forward of the enemy's fortified positions. They open two lanes through the minefields, thus providing access to the enemy position for the remaining elements of the company team and the battalion TF. Once this position is secured, the company team assumes a support position.

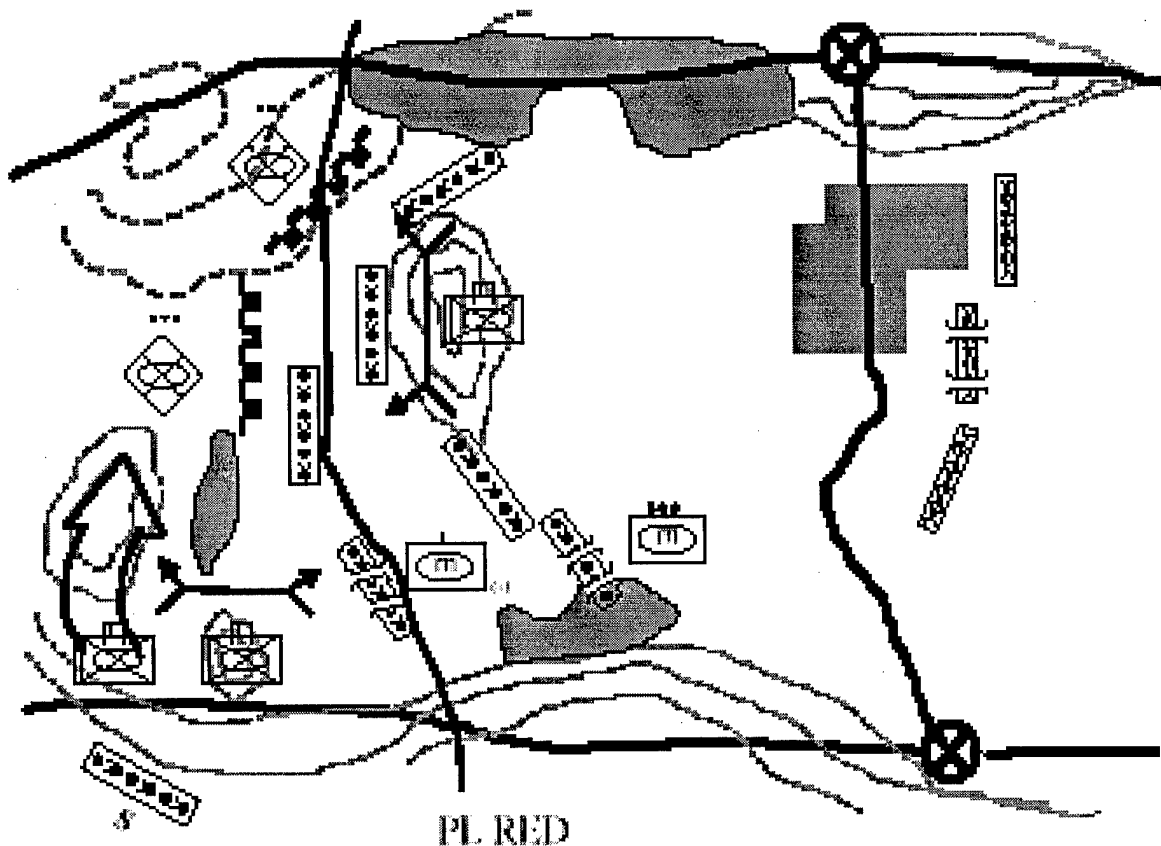

The engineer company (-) arrives at the second minefield, along PL Red, and using all of its armored combat earthmovers (ACEs) to widen the lanes through the minefield.

A situational obstacle (an artillery deliver scatterable minefield) group is executed at this time to protect the TF's left flank during the assault phase. Since this obstacle is outside of the task force boundary, it is coordinated with the adjacent unit.

The third maneuver company team (main effort assault force) then rolls up the enemy's flank. The engineer company has an engineer squad remain at the minefield lanes until the follow-on unit arrives. At this point,

they would handoff responsibility for the minefields to this unit. The engineer company prepares to employ its ground Volcano assets to reinforce the artillery delivered scatterable minefield. These assets are on standby, and aren't employed unless told to do so by the maneuver commander.

6. Activities to be modeled using the vignette.

a. Reconnaissance prior to LD: Before the unit can breach an obstacle it must ascertain two critical bits of information: where the breach is to occur and the nature of the obstacle (its composition and dimensions). Complete and detailed information about the obstacle construction may or may not be provided by the original OPORD/FRAGO. The exact location of the breach must be articulated to the breach element commander. The decision on where to breach an obstacle is the maneuver force commander's decision. It is a vital part of his scheme of maneuver. This step involves a decision on how this information is to be collected, which then dictates how long this process will take. To acquire information on the nature of the obstacle and its precise dimensions, the commander conducts as detailed a reconnaissance of the breach site.

The reconnaissance can be conducted by the scout platoon, engineer recon personnel, UAV or other resources available. The recon forces moves from their current location to an observation point overlooking the obstacle. **Time for this movement is determined by selecting the shortest covered and concealed route to a point overlooking the obstacle. This distance is multiplied by the appropriate movement rates of the methods used (M). Allow 30 minutes to obtain the desired information once he reaches the observation point. The total time to conduct the reconnaissance is the movement to and from the observation point and the time to observe the objective: $(2) \times (M) + 30 \text{ min} = T_{\text{total recon}}$. The recon element could stay at the observation and report over radio thereby eliminating movement back from observation point making the equation $(M) + 30 \text{ min} = \text{Total recon}$.**

Time to complete reconnaissance evaluation using the SPOTREPs from unit/elements making initial contact with the obstacle is 10 minutes.

So total time for recon would be $M + 40$ mins.

b. Initial Breach and Bypass of Obstacles: At H-hour, both companies simultaneously cross the line of departure. The northern company team clears two lanes in the wire obstacles to their front using Bangalore torpedoes. The company moves through the lanes and destroys the enemy's combat outpost. **For the initial breach against the northern anti-vehicle wire obstacles it will take an infantry squad 20 mins to complete this task. If conditions were dark (and they are) you would need to add 10 mins for a total of 30mins. If the squad was exposed to enemy fire (and it was) increase by 6 mins. Therefore this activity would take 36 mins.**

The company team in the south, with its attached engineer platoon, bypasses the enemy wire obstacles and proceeds toward its objective, OBJ B. **For this activity we make the assumption that this by pass was found and then decided on from the recon discussed above in para 6a. therefore no additional time other than movement would be added. Movement rate is that of the slowest vehicle in the unit. The main effort company team, with the engineer company (-) follows on the main attack axis.**

Total time for Initial Breach and Bypass of Obstacles is 36 mins.

c. Establish Support by Fire and Breach of Minefields : The supporting attack proceeds to and occupies Object A. The company team (co/tm) does not attempt to breach the minefields on the far side of the objective. Rather from this high ground, the company team *supports by fire* the main attack in the south. **Movement rate is that of the slowest vehicle in the unit. The time required for the (co/tm) to establish a support by fire position would be 20 mins.**

The lead company team on the main attack axis (south) reaches the minefields along phase line (PL) Blue. The company team conducts a breaching operation to open two lanes in the minefield. The engineer platoon, as part of the breaching element, uses two MICLICs to open lanes. The engineers move through the lane to ensure it is clear of mines, mark the lanes, and then act as guides for the remainder of the company. The engineer platoon remains at the minefield to guide the remainder of the TF elements through the lanes.

The time to breach a lane through a minefield is directly tied to the depth, density, and type of mines within that minefield. Minefields can be categorized according to intended purpose; to fix, delay, turn, and disrupt. The following minefields all have doctrinally defined standards in regard to width, depth, and density. (Density is defined as number of mines per linear frontage of the minefield.)

Therefore, standard breaching times can be calculated for these minefields. The table below provides the doctrinally defined characteristics for five types of minefields.

Type	Depth	Width	Density
Disrupt	100 meters	250 meters	0.5
Fix	120 meters	250 meters	0.6
Turn	300 meters	500 meters	1.0
Block	320 meters	500 meters	1.1
Hasty Protective	60 meters	200 meters	1.0

Work rates for Breaching Minefields

Equipment	Work Rate for Standard Minefield
Grizzly	Can clear a lane at a rate of 15 meters per minute
Tank Plows	Can clear a lane at a rate of 10 meters per minute
Explosives	Can clear a lane at a rate of 4 meters per minute
(B.T. & APBOS)	Can clear a footpath at a rate of 6 meters per minute
Grapnel	Can clear a footpath at a rate of 4 meters per minute Can clear a vehicle lane at a rate of 3 meters per minute
Probing/Visual Detection	Can clear a footpath at a rate of 3 meter per minute Can clear a vehicle lane at a rate of 2 meter per minute
*AVLM	Can clear a lane of up to 200 meters in depth in 10 minutes
**MICLIC	Can clear a lane of up to 100 meters in depth in 10 minutes
***DEUCE	Can clear a lane at a rate of 5 meters per minute
***ACE	Can clear a lane at a rate of 5 meters per minute
***Dozer	Can clear a lane at a rate of 5 meters per minute
***SEE	Can clear a lane at a rate of 4.5 meters per minute

Modifiers:

- If the breach is being conducted at night, add 50% to the work rate. $WR = WR + 0.5(WR)$
- If the breach force is under enemy fire, add 30% to the work rate. $WR = WR + 0.3(WR)$
- If the soil is soft subtract 10% from the work rate (except for explosives, MICLIC, and

- AVLM). $WR = WR - 0.1(WR)$
 • If the soil is hard add 10% to the work rate (except for explosives, MICLIC, and AVLM).
 $WR = WR + 0.1(WR)$

The minefield just west of PL Blue on the main attack axis is a turning minefield. Using the table below the time required to breach this minefield can be calculated.

Table 25. Breaching a Linear Obstacle - Turn Minefield

PRIORITY	EQUIPMENT	PERSONNEL	SUPPLIES	WORK RATE	MODIFIERS		
					Dark	Under Fire dark/light	Soil Condition
1	2 AVLMs	••• Crew of 2 for each AVLM ••• 1 Engr Squad	••• M113 or Bradley or HMMWV ••• 3 MICLIC.V	20 min	30 min	39/26 min	N/A
2	3 MICLICs	••• Crews for prime movers	••• 3 MICLIC.V ••• Prime movers for MICLICs	30 min	45 min	58.5/39 min	N/A
3	GREZZLY	••• Crew - 2	••• M113 or	20 min	30 min	39/26 min	Soft:

The type of equipment used by the unit was two MICLICs therefore using the table above it would take 59 mins to breach this obstacle considering a turning type obstacle, under fire and at night. It would take the engineer squad another 5 mins to ensure mines are clear and lane is marked. The remaining elements of the breach co/tm and the engineers supporting would take 10 mins through the lanes. Total time would be 74 mins.

Next the tanks equipped with mine plows breach the minefields forward of the enemy's fortified positions. They open two lanes through the minefields, thus providing access to the enemy position for the remaining elements of the company team and the battalion TF. Once this position is secured, the company team assumes a support position. This minefield is a blocking type so the following table would apply.

Table 26. Breaching a Linear Obstacle - Block Minefield

PRIORITY	EQUIPMENT	PERSONNEL	SUPPLIES	WORK RATE	MODIFIERS		
					Dark	Under Fire dark/light	Soil Condition
1	2 AVLMs	••• Crew of 2 for each AVLM ••• 1 Engr Squad	••• M113 or Bradley or HMMWV ••• 4 MICLIC.V	22 min	33 min	43/28.5 min	N/A
2	4 MICLICs	••• Crews for prime movers	••• 4 MICLIC.V ••• Prime movers for MICLICs	40 min	60 min	78/52 min	N/A
3	GREZZLY	••• Crew - 2 ••• 1 Engr Squad	••• M113 or Bradley or HMMWV	22 min	33 min	43/28.5 min	Soft: - 10% WR Hard: + 10% WR
4	TANK PLOW	1 tank crew	1 tank with mine plow	32 min	48 min	62.5/41.5 min	Soft: - 10% WR Hard: + 10% WR

The type of equipment used to breach was 2 tank plows at night, under fire and in soft ground so the total time is $WR = 62.5 - 0.1(62.5) = 56$ mins. It will take the co/tm 15 mins to establish its support by fire position. Total time is 71 mins.

The engineer company (-) arrives at the second minefield, along PL Red, and using all of its armored combat earthmovers (ACEs) to widen the lanes through the minefield. Using 6 ACEs the two lanes can be widened in 15 mins. This activity can occur simultaneously with the establishment of the support by fire position of the breach force.

A situational obstacle (an artillery delivered scatterable minefield) group is executed at this time to protect the TF's left flank during the assault phase. Since this obstacle is outside of the task force boundary, it is coordinated with the adjacent unit. **Coordination and firing of this obstacle by the DS FA Battalion will take 25 mins. This can occur simultaneously with the establishment of the support by fire position of the breach force and the widening of lanes through the minefield.** Total time for Establish Support by Fire and Breach of Minefields is 145mins.

d. Assault of OBJ: The third maneuver company team (main effort assault force) then rolls up the enemy's flank. **This phase of the battle should take 20 minutes. The assault force is through the obstacles and will destroy the remaining enemy in the center MRP.** The engineer company has an engineer squad remain at the minefield lanes until the follow-on unit arrives. At this point, they would handoff responsibility for the minefields to this unit. The engineer company prepares to employ its ground Volcano assets to reinforce the artillery delivered scatterable minefield. These assets are on standby, and aren't employed unless told to do so by the maneuver commander.

Total time requirements:

approx. 4hrs

Reconnaissance prior to LD:	40 mins
Initial Breach and Bypass of Obstacles:	36 mins
Establish Support by Fire and Breach of Minefields:	145 mins
Assault of OBJ:	20 mins
Total:	241 mins

Appendix 21. CADET functional mapping: Defense

1. Operation Definition:

Defensive operations are conducted with the immediate purpose of defeating an enemy attack. Defensive operations may also achieve one or more of the following:

- ◆ Gain time.
- ◆ Concentrate forces elsewhere.
- ◆ Wear down enemy forces as a prelude to offensive operations.
- ◆ Control key or decisive terrain.
- ◆ Retain tactical, strategic, or political objectives.

Defensive positions are usually nonlinear and the battle is planned and fought in depth. Supporting fires and reinforcing obstacles are planned to assist in shaping the battlefield, to slow and confuse the enemy, and to destroy the continuity of his formations. The battle starts forward of the Forward Line of Troops (FLOT). Supporting indirect fires are planned and used as early as tactically feasible. The initiative must be taken from the attacking enemy. He may be attacked before he closes on the security area or main battle area. A reserve should be available to counterattack at the critical point or contingency missions.

Brigades may attack, defend, or delay as part of the security area, main battle area (MBA), or reserve force. Additionally, a battalion within the brigade may conduct offensive operations (counter attack) while the majority of the brigade is defending. At times, the brigade may be required to retain key terrain or facilities, or conduct an attack as the striking force of a division or as a reserve force for the corps. The brigade's mission to retain key terrain may be ordered if it assists or creates an opportunity for the higher headquarters to shift to the offensive. Inevitably, the brigade defense focuses on regaining the tactical initiative or creating the opportunity for its higher headquarters to shift to the offensive. The commander conducts simultaneous operations in depth and organizes the battlefield into three complementary elements of deep, close, and rear operations. These elements are discussed below:

- ◆ Deep - Deep operations are directed against enemy forces and functions beyond the close battle. Generally, the brigade needs additional assets from division to conduct deep operations. These assets may include electronic jamming equipment and attack helicopters. The brigade commander must synchronize these additional assets to simultaneously attack the enemy throughout the depth of the battlefield. Brigades may also maneuver as part of the division's deep attack.
- ◆ Close - The MBA comprises the area we typically designate as close operations. Brigades generally array the bulk of their combat power within the MBA. Normally brigades defend within the MBA, act as the higher commander's reserve,

or act as part of the division or corps striking force. The brigade could act as the security force for the higher commander or it could provide its own security force, although this is not desirable. In either case, the brigade conducts passive and active reconnaissance and security measures throughout the depth of Area of Operations (AOs). The brigade commander retains a reserve force based on the threat force assessment.

- ◆ Rear - The brigade's rear operations include self-protection of its units and protection and maintenance of its Lines of Communications (LOCs). The brigade normally designates a tactical force to react to rear threats. Rapid response ability to a rear area threat, particularly Levels II and III threats, is integral to the commander's ability to sustain a viable defense. The brigade may also be tasked to provide tactical forces to support the higher commander's AO.

The Battalion Task Force and Company Team executes three basic techniques of defense:

- ◆ Defend a battle position (BP):
 - To destroy an enemy force in an engagement area.
 - To block an enemy avenue of approach.
 - To control key or decisive terrain.
 - To fix the enemy force to allow another unit to maneuver.
- ◆ Defend in sector:
 - When flexibility of maneuver is desired.
 - When retention of specific terrain features is not necessary.
 - When the task force cannot concentrate fires because of:
 - Extended frontages.
 - Intervening or cross-compartment terrain features.
 - Multiple avenues of approach.
 - To prevent the enemy from penetrating the sector rear boundary.
- ◆ Defend a strongpoint: (Not normally assigned to an armor or mechanized infantry force)
 - To hold key or decisive terrain critical to the TF scheme of maneuver.
 - To provide a pivot for the maneuver of friendly forces.
 - To block an avenue of approach.

- To canalize the enemy into one or more engagement areas.

At BDE/BN level the most common technique of defense is a defense in sector. This defensive technique requires a defending unit to prevent enemy forces from passing beyond the rear boundary of the sector while retaining flank security and ensuring integrity of effort within the parent unit's scheme of maneuver. Initial positions generally are established as far forward as possible, but a commander may use any technique to accomplish the mission.

Two defensive patterns are described below.

- ◆ Mobile - A mobile defense orients on the destruction of the attacking force by permitting the enemy to maneuver to a position of disadvantage that exposes him to the striking force. A brigade may conduct a movement to contact or deliberate attack as part of a division or corps striking force.
- ◆ Area - Area defense orients on retention of terrain or facilities for a specified time. When planning the area defense, the brigade commander decides the decisive point, when to concentrate his main effort, and where to economize forces based on his own estimate of the situation and the higher commander's concept. He then assigns missions; allocates forces, fires, and other support; and sets priorities for resources to fight a combined arms battle.

The key element in locating a battle position is the commander's determination of the Engagement Area (EA). The EA is an area along an enemy avenue of approach where the commander intends to trap and destroy an enemy force using the massed fires of all available weapons. The size and shape of the EA is determined by the relatively unobstructed intervisibility from the weapon systems in their firing positions and the maximum range of those weapons. Sectors of fire are usually assigned to subordinates to prevent fratricide. The success of any engagement depends on how effectively the commander can integrate the obstacle plan, the indirect fire plan, and the direct fire plan within the EA to achieve the company team's tactical purpose.

There are certain definitions with regard to battle positions that are germane to the discussion. The specific terms are *primary position*, *alternate position* and *supplementary position*.

- ◆ *Primary Position*. A place for a weapon, unit, or individual to fight, which provides the best means to accomplish the assigned mission.
- ◆ *Alternate Position*. The position given to a weapon, unit, or individual to be occupied when the primary position becomes untenable or unsuitable for carrying out its task. The alternate position is located so that the original task can be completed.

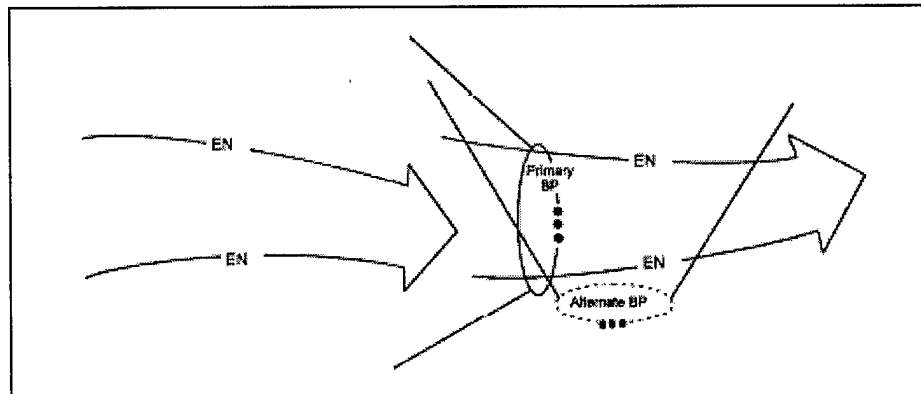

Figure 1. Alternate BP

- ◆ *Supplementary Position.* That location which provides the best means to accomplish a task that cannot be accomplished from the primary or alternate positions.

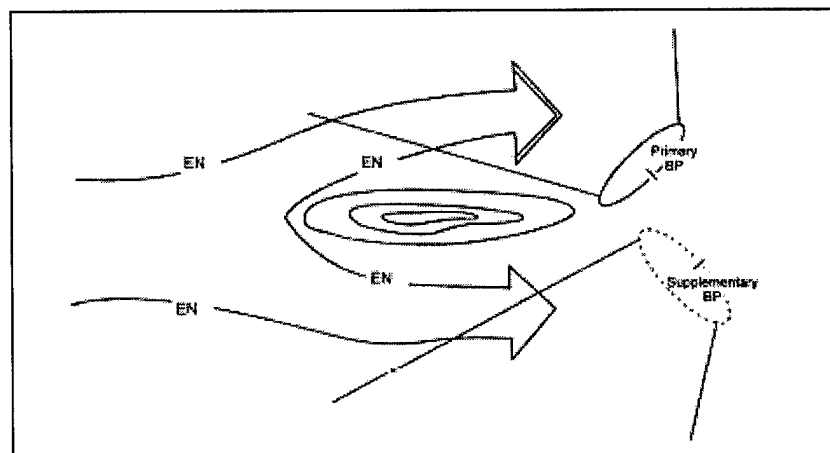
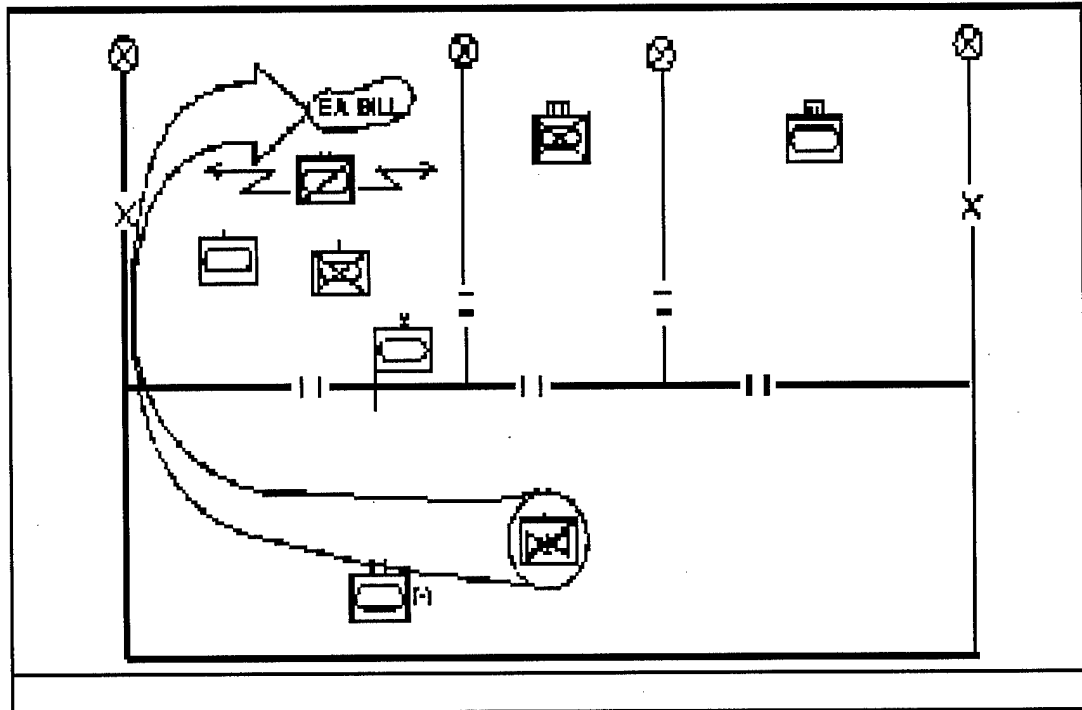

Figure 2. Supplementary BP

2. Operation Description:

The brigade commander elects to defend forward or in depth based on METT-T and higher commander's intent. A defense in the forward part of the sector requires early commitment of the main defensive effort. This may be achieved either by an initial forward deployment of forces or by planning counterattacks well forward in the MBA or even forward of the MBA. A defense in depth may be selected when missions are less restrictive, defensive sectors are deep, and key terrain lies deep in the sector. A defense in depth relies on elements in the security force area and forward elements in the MBA to identify, define, and control the depth of the enemy attack. The flanks of the enemy main

effort are counterattacked to isolate and destroy enemy forces in the MBA Figure below portrays a brigade defense in sector.



A commander will normally order a BN/TF to Defend in Sector when one or more of these conditions apply:

- ◆ Flexibility is required to compensate for uncertainty in enemy intent and/or location.
- ◆ Retention of specific terrain features is not necessary.
- ◆ Unit fires and placement cannot be concentrated because of extended frontage, intervening terrain features/terrain compartmentalization, or multiple enemy avenues of approach.

The BN/TF has a number of options in tasking its subordinate units. It may:

- ◆ Divide the sector into company/team size sectors and assign the teams to conduct a defense in sector.
- ◆ It may designate company/team battle positions and direct the companies through a series of battle position.
- ◆ It may designate one unit to occupy a strong point in order to anchor the defense along a “no penetration line”.

- ◆ It can use a combination of all of the above.

The decision on which method or combination of methods to use is outlined in the following table.

Terrain	Sectors	BPs	Strongpoint
If the terrain supports the ability for 2 or more companies to bring the preponderance of their weapon systems to fire into a single Engagement area (EA). Areas of operation Narrow, Avenues of approach well defined; enemy can be canalized. Mutual support Achievable.		X	
If the terrain is compartmentalized to the point where the companies cannot easily support one another. Multiple avenues prohibit concentration. Dominating terrain not available. Wide.	X		
If the terrain supports a well defensible position near the no penetration line (if one is designated). The remainder of the TF/BN will execute either BPs or Sectors.			X (1 Company)
If the terrain is compartmented in one area but not the majority.	X (1 Company)	X	

The BN/TF commander considers the enemy's doctrine, equipment, recent or past tendencies, intent, and probable courses of action (COAs) (most likely and most dangerous) in planning the defense. The commander prioritizes his defense planning against the enemy's probable COAs. Defending commander's view themselves and their sectors through the enemy commander's eyes to anticipate whether the enemy will orient on bypassing the friendly force, or destruction of the friendly force. This allows the BN/TF commander to visualize which enemy actions they must disrupt and/or counteract during the friendly COA development.

In the defend sector, the TF commander may or may not be able to see the entire sector due to terrain compartmentalization. The BN/TF S2 supports the preparation of the defense in sector/delay by conducting the terrain analysis throughout the depth of the assigned sector. He identifies mobility corridors down to the platoon level (mounted and dismounted). It is important when planning a Defend in Sector to analyze possible threat flank AAs in the same detail as the primary threat AAs coming directly into the front of the BN/TF sector. Next, the commander identifies where the threat is most vulnerable in the sector. This includes choke points and natural or constructed obstacles perpendicular to the threat's direction of travel and locations where the enemy force may change formations, dismount, or move to bypass. These are used later for the planning of obstacles and indirect fires.

The task force commander sets his scheme of maneuver into motion by assigning missions to company teams. He task organizes to give each team the required assets. He allocates space using sectors, battle positions, and strongpoints, and gives specific tasks for each. EAs, Target Reference Points (TRPs), terrain that must be held (if any), and counterattack missions are also included as required. The task force commander states whether his company teams may accept decisive engagement. When explaining his concept, the task force commander states disengagement criteria. He informs each company team commander of the conditions under which to disengage, e.g., when the enemy reaches a point on the ground, after destroying a certain number of vehicles, at a certain time or event, or do not disengage until ordered to do so. Supporting fires and reinforcing obstacles are used to assist in shaping the battlefield, to slow and confuse the enemy, and to destroy the continuity of enemy formations. The BN/TF commander plans for man-made obstacles *Construct Hasty Protective Obstacles without the aid of Engineer and/or Engineers Construct Obstacles* to improve the natural impediments, to slow or canalize enemy movement, and to protect friendly positions and maneuver throughout the sector. Note that the company commander's assumes responsibility for exact placement of obstacles within his sector / BPs from the battalion defensive plan. The commander coordinates with supporting engineers to ensure obstacles do not limit friendly fields of fire or maneuver into the EAs. Generally for the defense, doctrine emphasizes that when a specific piece of terrain in the sector is a critical factor in a defense, commanders make it a focal point of their plan. This tenet holds when the company defends in sector; however, the company is usually assigned a Defend in Sector mission when dominating terrain is not available. When dominating terrain is not available, the commander must compensate his plan by maximizing the use of firepower and maneuver. In periods of adverse or limited visibility, commanders plan for the impact on weapons systems and optical devices. A defensive plan that succeeds in ideal weather conditions may be less effective in periods of bad weather or on different ground/soil. For example, tanks would not be most effective in wetlands. Contingencies to the basic plan should address necessary modifications to the defense during periods of reduced visibility, including the use of supplementary BP and/or alternate BPs.

3. Planning Considerations:

The brigade commander arrays his BN/TF's against regimental-size avenues of approach. He determines BN/TF sectors by considering the positioning of troops. The BN/TF commanders array company-size forces against battalion-size avenues of approach. In doing this, he considers the positioning of platoons. The positions must provide for an integrated defense so that all available weapon systems can be effectively used. Positioning should allow shifting of fires and forces to meet enemy actions during the battle. Once this is completed, the commander considers the formation of teams. Available maneuver space and subordinate combat power are considered when forming teams. Commanders organize and assign missions in the defense based on the considerations described in the following paragraphs.

- ◆ Dispersion - Commanders disperse units and weapons laterally and in depth to reduce the enemy's ability to suppress. This also allows the unit to engage the enemy from multiple directions.
- ◆ Cover and Concealment - Elements are placed in positions where cover and concealment are available; obvious terrain is avoided. Hide positions are used to check the adequacy of concealment, leaders travel approaches to their units from the enemy's direction of movement. Covered routes must be available to allow movement in and between positions and for maneuver against the enemy.
- ◆ Flanking Fire - Flanking fires are far more effective than frontal fires. Initial positions for anti-armor weapons may maximize long-range engagements, but primary positions are normally picked to maximize flanking fires from defilade positions.
- ◆ Security - Battle position security includes patrols, observation posts, and other measures to provide security from enemy attacks, mounted or dismounted, along covered routes.
- ◆ Ability to Maneuver - Units must be able to concentrate on the avenues of approach being used by the enemy. To do this, plan and rehearse routes between on-order positions with sectors of fire and positions in depth.
- ◆ Range of Weapon Systems - When selecting tentative positions for weapon systems, the commander considers the effective range and acquisition capabilities of each system.
- ◆ Weapons are positioned to engage out to maximum effective range and to provide an increasing volume of massed fires. Tanks have a fast rate of fire and short engagement time. Antitank missiles provide long-range fires but are limited by rate of fire and time of flight.
- ◆ Transition to Limited Visibility - An attacker uses night, bad weather, smoke, and suppressive fire to limit the defender's visibility. The defender anticipates this

problem and prepares to occupy predetermined, limited visibility fighting positions. Limited visibility capabilities of fire control systems are a key factor in determining the amount of adjustment required.

- ◆ Dismounted Infantry - Battle positions or sectors for dismounted infantry are chosen to hold or deny mounted and dismounted avenues of approach to key terrain. Positioning dismounted infantry on forward slopes may needlessly expose them to long-range direct and observed indirect fires. Positions to the flanks or on reverse slopes that deny approaches to key terrain avoid exposing dismounted infantry and provide cover and concealment. Dismounted infantry is best suited to close-in fighting on restrictive terrain with limited fields of fire. Dismounted infantry should be positioned so they can only be threatened inside the ranges of their antitank weapons. When good infantry terrain is not available, construction of obstacles and time to construct strong fighting positions are required to allow infantry to hold terrain and defeat armor.

4. Vignette

Option 1:

This option discusses a Mechanized Task force defending in sector by battle positions. The TF consists of 3 mechanized infantry companies, 1 tank company, a DS air defense platoon, a DS engineer company, and the organic forces assigned to a BN. The TF is part of a Brigade defense in sector. Intelligence estimates describe the enemy threat as a motorized regiment. The mission is to contain enemy forces in EA Kill allowing division attack aviation, close air support and massed indirect fire to complete the destruction of the motorized regiment east of PL Red.

Concept of the Operation:

The TF commanders concept consists of:

- ◆ Forward deploy 3 Teams in BP's 1, 2 and 3.
- ◆ The scout Plt will screen the southern flank, and a mechanized infantry company will occupy BP 4.
- ◆ Initial engagements in EA's Hit and Hat.
- ◆ Combination of turning, disrupting, and fixing obstacles that will put the enemy in EA Kill.
- ◆ All four Company/Teams engagement into EA Kill, where the enemy will be destroyed, by direct, indirect, and air fires.

See Figure 8 for the initial disposition and graphics.

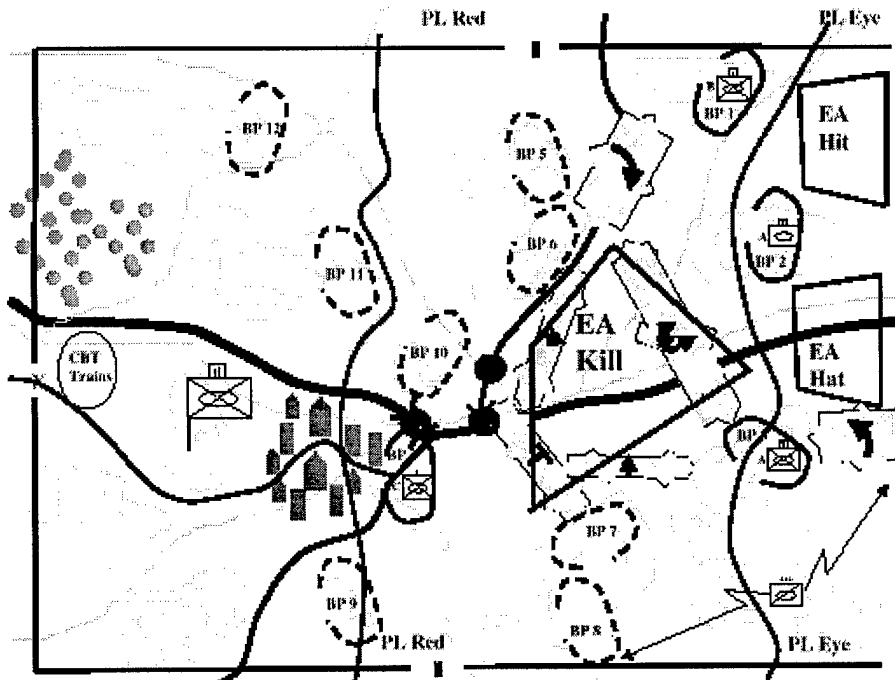

Figure 8. Tactical Option 1 TF Plan Initial Disposition

As the enemy approaches EA's Hit and Hat the three forward Teams begin to engage the enemy with direct and indirect fires. (See Figure 9).

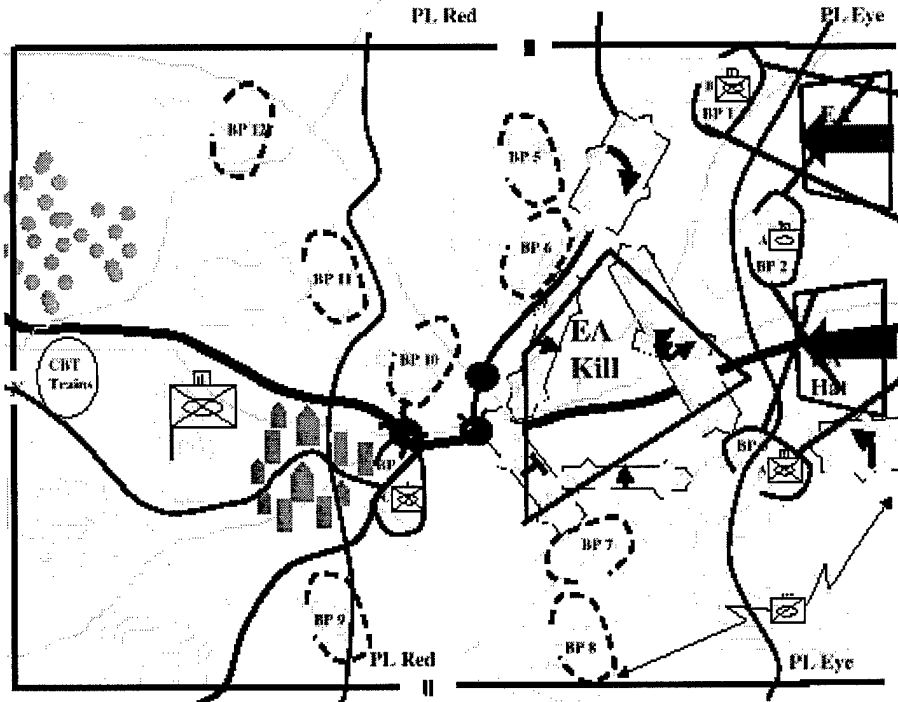

Figure 9. Tactical Option 1 TF Plan Enemy Approach

When the enemy reaches a pre-determined position the forward teams will begin movement to their next BP's. In this option the Armor Team will move 1 st to BP 6, once there and able to cover the other two teams will move to BP's. The mech tm in the south will move next to BP 7 and the mech tm in the north will on order move to BP 10. The Scout platoon will adjust its screen in the south to cover PL Red to PL Eye (See Figure 10).

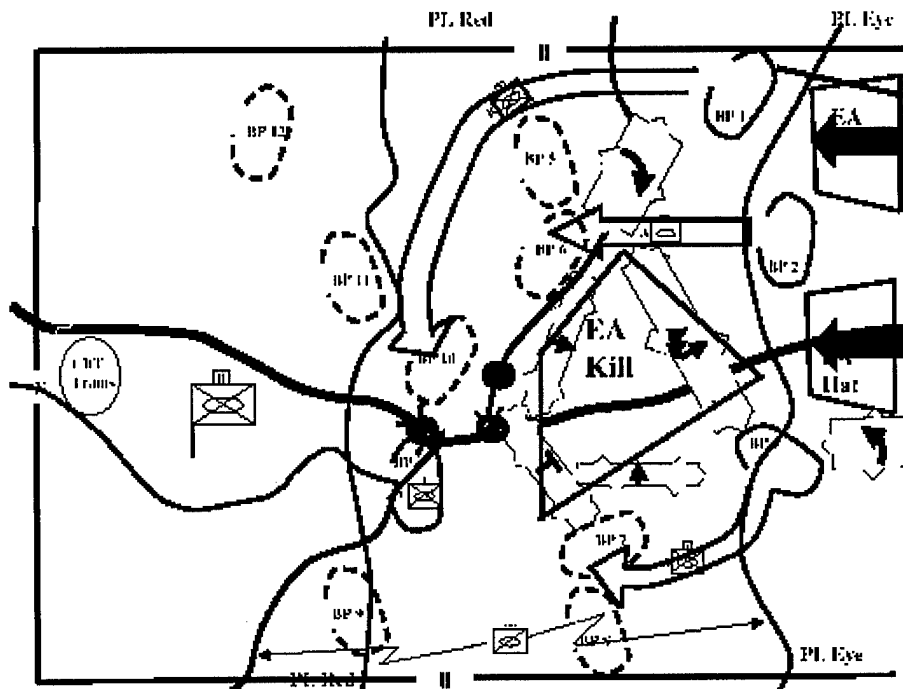

Figure 10. Tactical Option 1 TF Plan Scout Platoon Adjustment

The final destruction of the enemy occurs in EA Kill with a combination of direct fires, indirect fires, obstacles, and aircraft (see Figure 11).

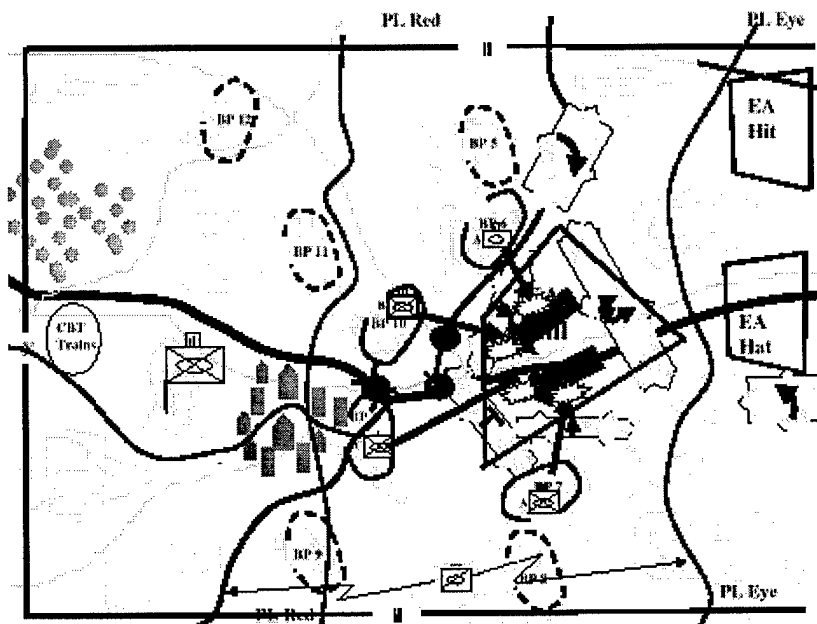

Figure 11. Tactical Option 1 TF Plan Final Destruction

Option 2:

This option discusses a Light Infantry BN defending in sectors with a Strongpoint position. The BN consists of 4 infantry companies and the normal additional forces

assigned to a BN. The mission of the BN is to block west of PL Dog to deny the enemy use of the main road juncture in sector. The BN has planned the defense using company sectors, due to the terrain compartmentalization, and a strong point at the road juncture. The graphical concept can be seen in Figure 13. The BN has designated the northern sector to A company, the center sector to B company and the southern sector to D company. C company has been tasked to occupy the strongpoint with the scouts providing a screen to the north along a flank avenue of approach .

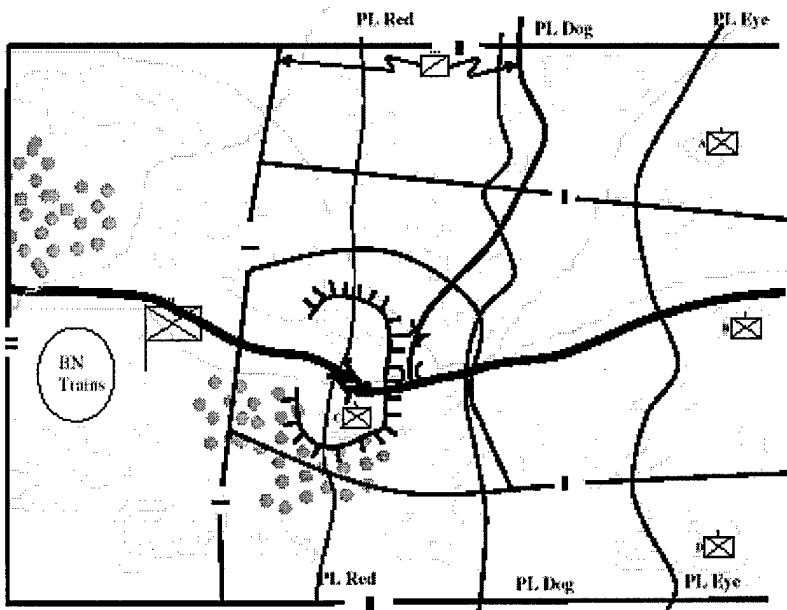

Figure 13. Tactical Option 2 Initial Positions

When the enemy approaches the three forward rifle companies will begin engaging the enemy with direct and indirect fires. They will execute the defense in their sectors using platoon battle positions. The BN will maintain coordination between the rifle companies to ensure that they remain tied into each other thereby avoiding a gap in the defense (see Figure 15).

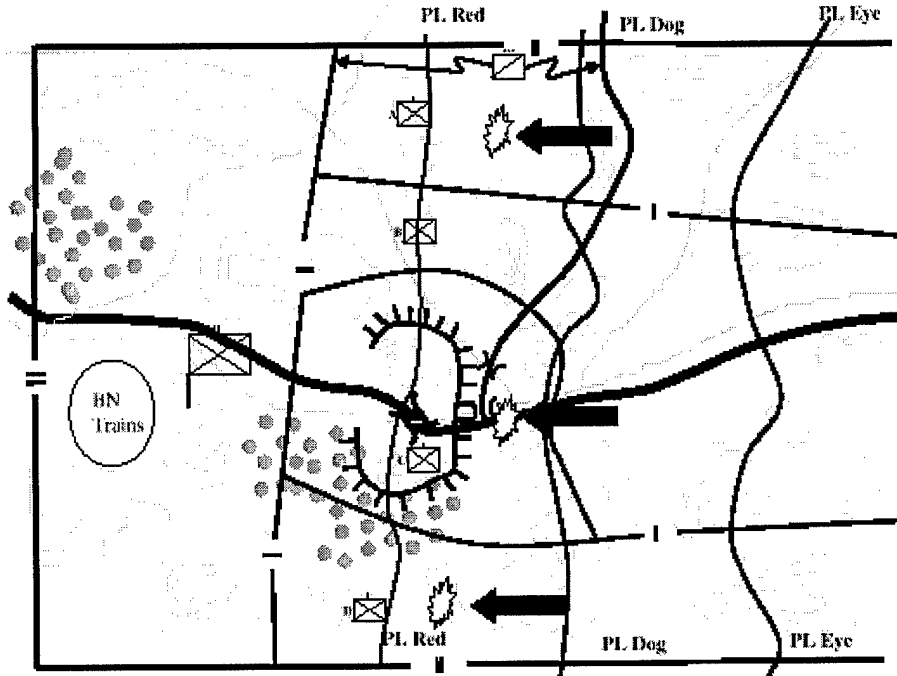

Figure 15. Tactical Option 2 Execute Defense

5. Activities to be modeled using the vignette option 1.

Preparation of the defense: Most defenses take between 36-48 hrs to prepare. This includes reconnaissance of the area of operation. The terrain box in the vignette is 15(width) x 20 (depth)kms so you would need to allocate 4 hrs for reconnaissance at Battalion and Company level. Other than reconnaissance the majority of time consumed in the preparation of a defend in sector is conducting survivability and countermobility operations.

An engineer company provides support to the defensive operations of battalion/task forces, and/or company/teams (both Heavy and Light). The engineer company provides support in the following areas:

- ◆ **MOBILITY:** Mobility enables the force commander to maneuver tactical units into advantageous positions over the enemy. In the attack, engineers aggressively execute drills to breach enemy obstacles and assault and destroy enemy fortifications. The supported commander designates routes for ground forces, well in advance of their intended use, so that engineer units can upgrade the routes, as necessary, and keep them open or repaired. **(Normally not critical in battalion and below level defenses.)**

- ◆ **SURVIVABILITY:** Survivability provides concealment and protective shelter from the effects of enemy weapons. Engineers have the technical knowledge, skills, and equipment to:
 - Assist other units in developing defensive positions into fortifications and in improving defensive positions.
 - Provide technical advice on camouflage.
 - Dig fighting positions beyond the combat units' organic capabilities.
 - Harden facilities to resist destruction by the enemy.
 - Provide equipment support necessary to establish NBC decontamination points and assist in route and area decontamination.

- ◆ **COUNTERMOBILITY:** Countermobility augments natural terrain with obstacle systems according to the supported commander's concept. This adds depth to the battle in space and time by attacking the enemy's ability to maneuver its forces. With its movement disrupted, turned, fixed, or blocked, the enemy is vulnerable to the supported units forces. Engineers advise the commander on the best means to reinforce the terrain and emplace obstacles that support his plan.

Lets first examine survivability: The essence of survivability planning revolves around the following:

- ◆ Forming blade teams from available assets. These assets consist on the organic engineer equipment. However, the task force may provide manpower, additional equipment, and supplies to support the engineer effort (these assets may be military or in some cases the task force may procure civilian supplies/equipment).
- ◆ Knowing the maneuver commander's priority of work and the available assets, the engineer applies his resources to complete the tasks, to the degree required, and within the time allotted.
- ◆ Once the order is executed, the engineer officer monitors the performance of the engineer elements. He adjusts assignments as the tactical situation dictates (for example, a blade team must be replaced because a bulldozer was lost to an enemy air attack).

Maneuver units can handle the preparation (construction) of most individual and light crew-served weapons positions. Engineers concentrate on labor-intensive heavy construction (i.e., digging in of tanks, combat vehicles, command posts, artillery, air defense weapons, etc.) The focus of engineer effort in survivability operations centers on the concept of blade teams. The following engineer items of equipment (or their civilian equivalent) are the primary sources for forming these blade teams:

- ◆ M9 Armored Combat Earthmover (ACE).
- ◆ Deployable Combat Earth Mover (DEUCE).
- ◆ Crawler Tractor, D7 (referred to as dozer or bulldozer).
- ◆ Scoop Loader.
- ◆ Small Emplacement Excavator (SEE).
- ◆ Scrapers/graders.
- ◆ Blade teams are built through the following process:

Divide the available excavators into teams based on the number of dozers, DEUCEs, and ACEs available, and assign the other excavators to complete the teams.

Example, heavy engineer company. Equipment available is 7 ACEs, 2 JD. Since the ACE (or equivalent) must form the basis of a blade team, five teams are formed. Team one is 1 ACE & 1. Team two is 1 ACE; Team three is 2 ACEs; Team four is 2 ACEs, and Team five is 1 ACE. Utility tractors and SEEs are usually dedicated to digging individual/crew served weapons positions.

The following is an example of the above process using vignette 1. The task force commander directs that within 48 hours:

- ◆ All tanks (M1) are to be protected turret defilade positions for alternate positions constructed.
- ◆ All infantry carriers/command vehicles (M113) protected to infantry carrier defilade alternate positions constructed.
- ◆ Bradley Fighting Vehicle (M2) protected defilade positions for alternate positions constructed.

The elements concerned are the task force command post and three of the four maneuver companies:

Company A - a mechanized infantry team defending in the south initially in Battle Position (BP) 3 then moving to BP 7.

Company B - a mechanized infantry team defending in the north initially in BP 1 then moving to BP 10.

Company C - a mechanized company defending in BP 4.

Company A - a tank team defending in the center initially in BP 2 then moving to BP 6. (The Bn TF Cdr has decided not to dig in this company team given the unit will be the first to move.)

The task force engineers have two bulldozers, and two utility tractors assigned. These assets compose a total of two blade teams. Both teams have one bulldozer. There is also

one blade team consisting of the two utility tractors. The highest priority unit is Company C because it is conducting its defend mission from a fixed location.

Calculations determine that the first blade team (bulldozer) can accomplish all of its Company C's required survivability tasks in 36 hours. The second blade team (bulldozer) supporting company team A cannot complete its tasks within the required time, reaching only primary positions for the (M2) within 48 hours. The third blade team (2 utility tractors) is applied against Company team B's requirements. The two working in conjunction are capable of completing all the work at company teams B position in 40 hours. Once the first blade team has completed its assigned tasks with Company C it proceeds to conduct the work required to protect the task force command post (CP). Calculations determine that this work will not be completed in the allotted time. Therefore, the other two blade teams join the first one at the task force CP once they have completed work on Company B. Company A (tank) is not on the priority list because it has a mission that will keep the unit moving and the tank is the most survivable system in the TF. Table 3 below indicates the standard work rates for the most common positions and Table 4 gives the time for an ACE to build CO/TM and pure company positions.

Table 3. Standard Work Rates

Survivability	Dozer BTH¹	ACE BTH
Hull Defilade Position (HDP)	1 each/ 1 BTH	1 each/ 1.5 BTH
Turret Defilade Position (TDP)	1 each/ 2.5 BTH	1 each/ 3.5 BTH
HMMWV TOW Position	1 each/ 1.5 BTH	1 each/ 2 BTH
Vehicle Protective Position	1 each/ .75 BTH	1 each/ 1 BTH
1. Blade Team Hour (BTH) is one blade team working for one hour. A blade team consists of two blades (dozer, ACE, etc.). One vehicle digs (center) while the other blade spreads the spoil (strikes). A mixed dozer/ACE/other team uses the dozer BTH. A mixed ACE/other excavator team uses the ACE BTH.		

Planning assumptions:

- ◆ Personnel work 12 hours per day.
- ◆ Blades work 18 hours per day.
- ◆ Time is increased 20 % for travel.
- ◆ Platoon and blade team are the basic planning unit.
- ◆ Blades are employed as teams. At least one blade of the team is a dozer or ACE.
- ◆ ACEs, dozers, CEVs, and bucket loaders are the excavators primarily used.

Available Blade Team Hour (BTH) formula for the engineer company above, with two days of preparation time:

- ◆ BTH available = number of teams x effective hours per day x the number of days
- ◆ BTH available = 5 x 18 hrs/1 day x 2 days = 180 hours

Therefore survivability preparation for both engineer and individual and light crew served weapons would take 48 hrs.

Table 4. Work Estimates (in days) for Turret Defilade Positions for Various Units¹

Type Unit	Primary	Alternate	Supplementary	Total
M2 Co (14 x M2)	2.7	2.7	2.7	8.1
M1A1 Co (14 x M1A1)	2.7	2.7	2.7	8.1
M2 hvy tm (9x M2+ 4 x M1)	2.5	2.5	2.5	7.5
M2 hvy tm w/TV Pli (9 x M2+ 4 x M1+4 x M901)	3.3	3.3	3.3	9.9
M1A1 hvy tm (10 x M1A1+4 x M2)	2.7	2.7	2.7	8.1
Balanced tm Tk Co HQ (10 x M1+4 x M2)	3.5	3.5	3.5	10.5
Hvy mortar plt (3 x M106+1 x M577)	.7	.7	.7	2.1
M109A2 Bty (8 x M109A2+8 x FASVs+3 x M577)	3.7	3.7	3.7	11.1
M109A2 Bn	11.0	11.0	11.0	33.0
1. Based on M9 ACE Blade teams (3.5 BTH per turret defilade position). Actual times may vary based on different soil types, and equipment, personnel, and physical dimensions of the equipment to be emplaced. 2. Numbers are necessary blade team days to emplace the unit. (BTH divided by 18 hours/day)				

Lets now examine countermobility:

The essence of countermobility planning revolves around the following:

The EA is where the commander intends to trap and destroy an enemy force using the massed fires of all available weapons. Obstacles are designed to increase target acquisition time within the EA and therefore increase the effectiveness of the direct and indirect weapon systems. For the following example the task force commander designates the following engagement area. (See Figure 11.)

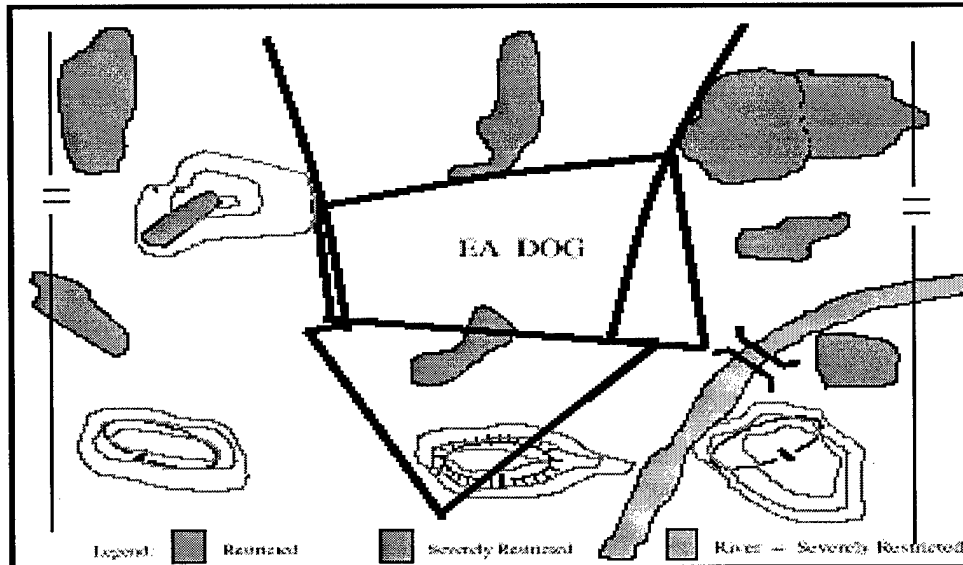

Figure 11. Engagement Area

Whenever terrain provides the enemy an option of more than one (regimental/brigade) avenue of approach, the task force commander wants to emplace an obstacle group that *turns* the enemy into his preferred AA. For example, Figure 12 depicts two regimental/brigade-sized avenues of approach. The task force commander wants to force the enemy into AA1 because it leads into his engagement area. He directs that a turning obstacle group be placed at the junction of the two avenues of approach. The turn effect is designed to divert an enemy formation off one AA to an adjacent AA or into an EA. Its development requires well-defined mobility corridors and AAs. To achieve this effect, the obstacles have a subtle orientation relative to the enemy's approach. The obstacles and fires allow bypasses in the direction desired by the friendly scheme of maneuver. Obstacles at the start (closest to the enemy) of the turn are visible and look more complex than those in the direction of the turn. The obstacles tie into severely restricted terrain at the initial point of the turn. Along a similar vein, once the enemy is in the preferred avenue of approach the task force commander does not want the enemy to exit. Therefore, exits out of the AA need a turning obstacle group to assure the enemy enters the engagement area.

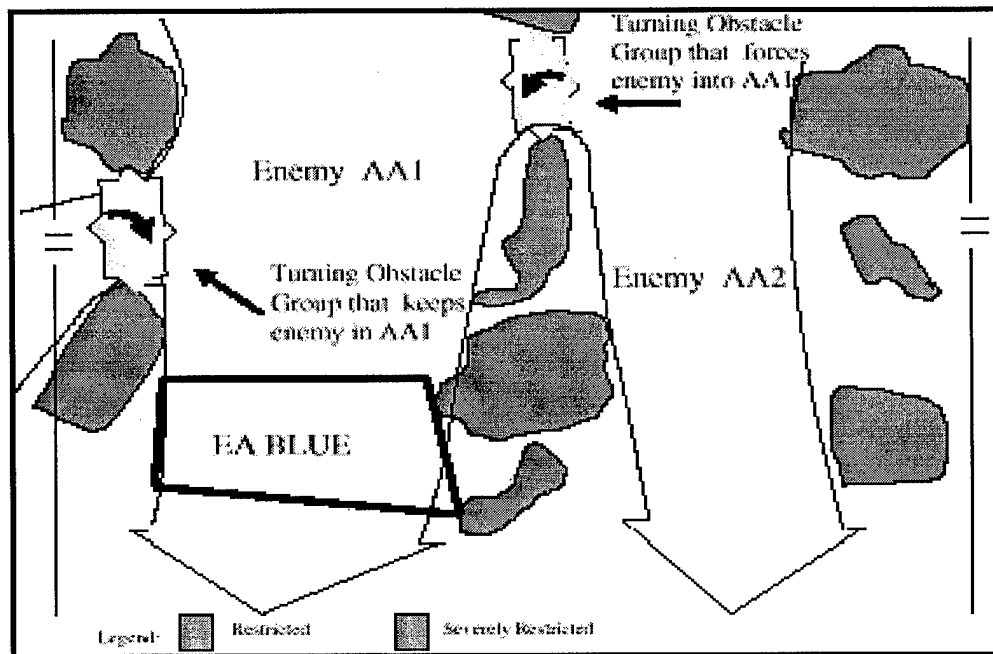
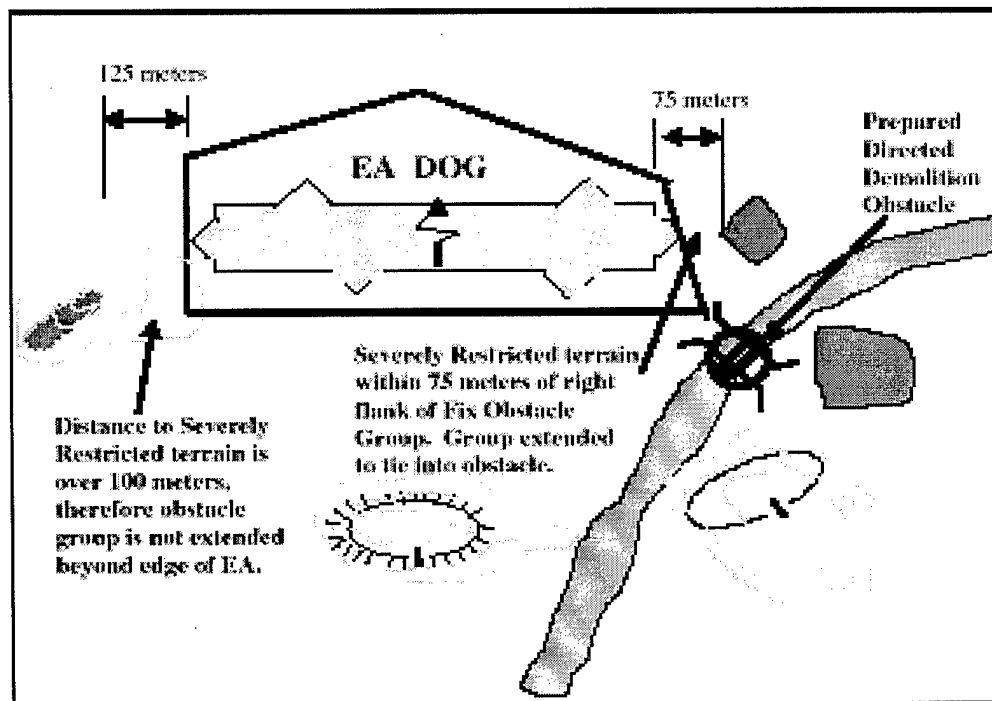

Figure 12. Turning Obstacle Group

The Fix obstacle group is positioned next. The fix effect focuses fire planning and obstacle effort to slow an attacker within a specified area, normally an EA. Primary use of this effect is to give the friendly unit time to acquire, target, and destroy the attacking enemy with direct and indirect fires. To achieve the fix effect, units array obstacles so as to cause the enemy formation to react and breach repeatedly. (See Figure 16.)



Placement of the Disrupt obstacle group is the next procedure. The disrupt effect is to break up enemy formations and his tempo, interrupt his timetable, commit breaching assets prematurely, and piecemeal the attack. Disrupt obstacles are normally used forward of the engagement area. Thus the formations of enemy units entering the EA lose their cohesiveness. It also helps to deceive the enemy concerning the location of friendly defensive positions or to separate combat echelons. To achieve a disrupt effect the obstacles normally cover one half of the AA/EA. Disrupt obstacle groups are placed on the forward edge of the EA as shown in Figure 18.

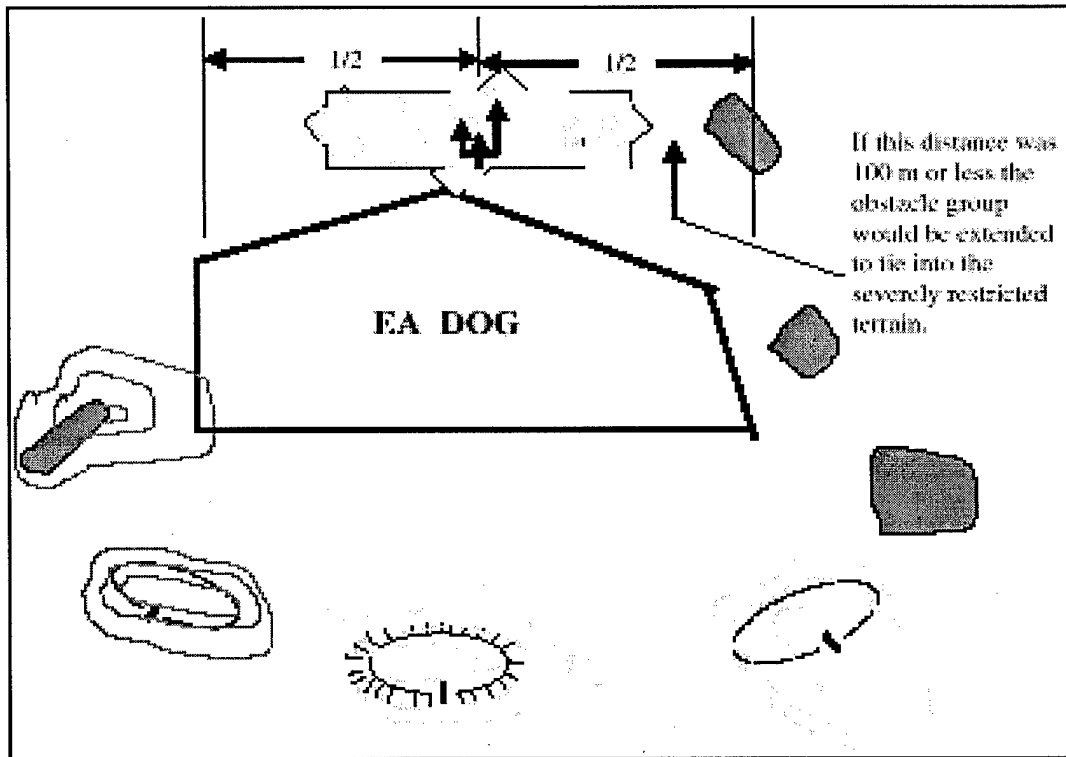

Figure 18. Positioning of Disrupt Obstacle Group

Block obstacle effect is to stop an attacker along a specific AA or prevent him from leaving an engagement area. Because of the massive effort required to achieve this effect, these obstacles are planned and executed last. The primary purpose of a block obstacle group is to stop the enemy's forward movement and assist in the complete destruction of its force.(See figure 19)

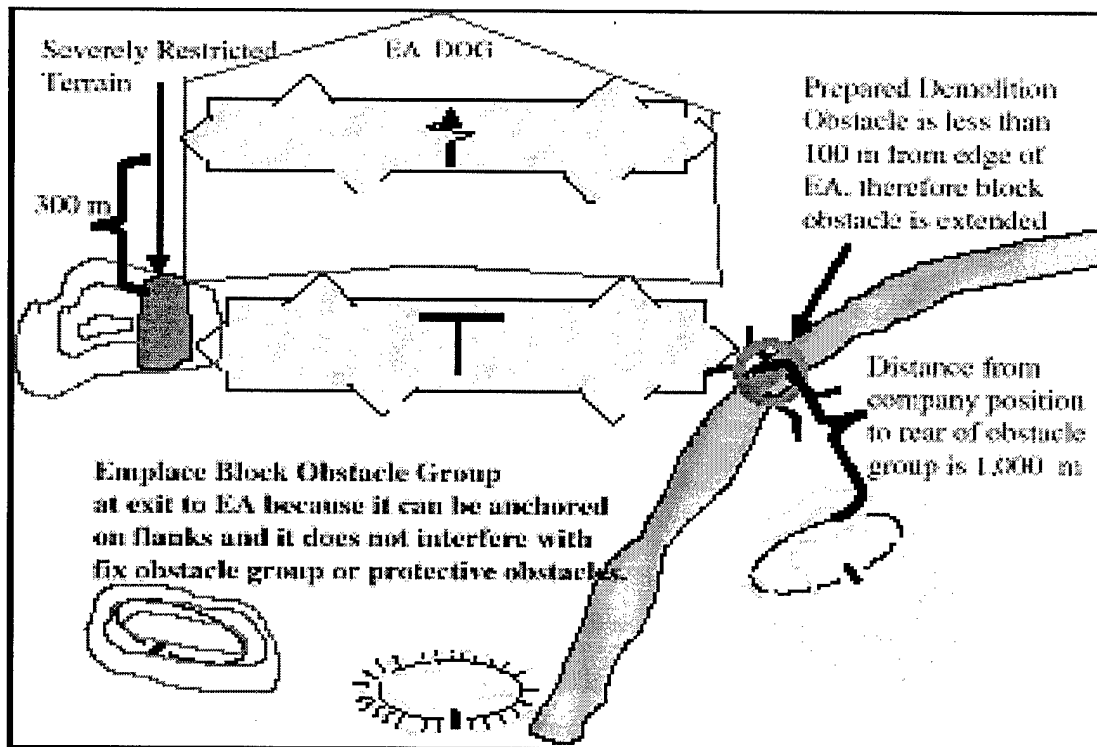

Figure 19. Block Obstacle Group at Exit of EA

Figure 21 is a summary of the emplacement of the four obstacle groups, turn, fix, disrupt, and block plus a directed obstacle. Not shown is the company protective obstacle that would be developed immediately around the company defensive positions.

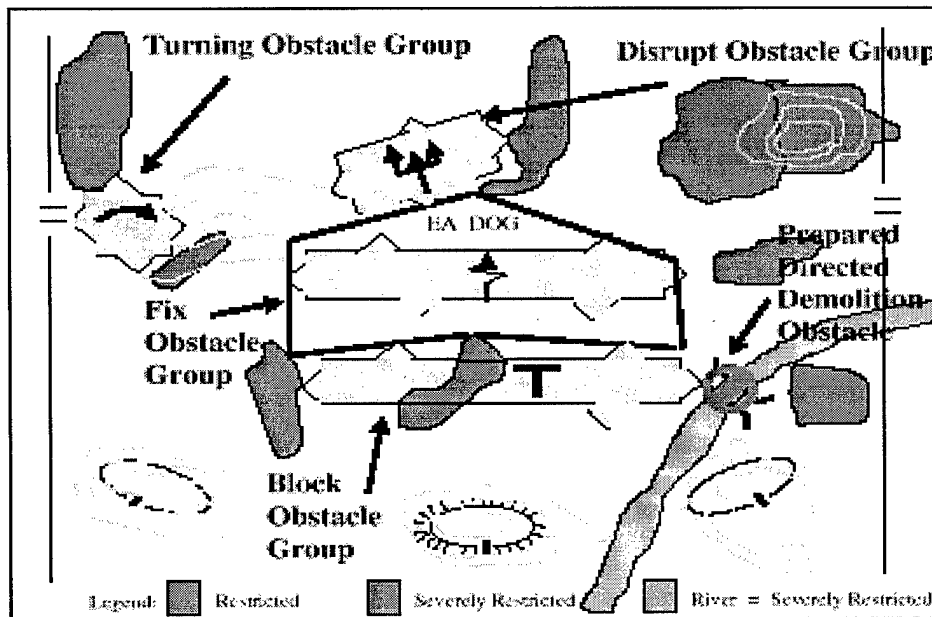

Figure 21. Summary of Obstacle Placement

There are numerous types of obstacles that support the construction of turning, fixing disruptive and blocking obstacles. Following is a discussion of three of the most common types antitank ditch, landmines and scatterable mines.

Antitank Ditch

The antitank ditch is a linear obstacle. Its dimensions are given as a trench 3.3 meters wide, 1.8 meters deep, with the length as a variable. Table 12 depicts the equipment, personnel, and supplies required to emplace this obstacle. The work rate is representative of the amount of ditch, per hour, that can be dug by two (in some cases three) vehicles working in concert (a blade team). The work rate is blade team hours (BTH). If one of the blade team vehicles is missing, reduce the work rate by 60%. For example, 2 ACE vehicles are digging 70 meters per hour. One vehicle is destroyed by enemy air activity. The remaining ACE continues to work on the ditch but is only producing 28 meters per hour. Conversely, if three vehicles are present they can produce 98 meters per hour, four vehicles can dig 140 meters per hour, etc.

- ◆ All acceptable pairs of equipment that constitute a valid *blade team*.
- ◆ Work Rate is given in BTH.
- ◆ Work Rate is for *normal* soil, with hard packed/frozen soil decrease work rate m/hr by 10%, loose/sandy soil increase work rate m/hr by 10%.

- ◆ During periods of darkness, decrease work rate meters by 20%.

Table 12 Antitank Ditch Requirements

Priority	Equipment	Personnel	Supplies (Class IV/V)	Work Rate
1	<ul style="list-style-type: none"> • 2 ACEs • 1 HMMWV 	<ul style="list-style-type: none"> • 1 engr squad • 2 ACE crews 	None	70 meters per BTH
2	<ul style="list-style-type: none"> • ACE/CEV • 1 HMMWV 	<ul style="list-style-type: none"> • 1 engr squad • 1 ACE crew • 1 CEV crew 	None	70 meters per BTH
3	<ul style="list-style-type: none"> • ACE/Dozer • 1 HMMWV 	<ul style="list-style-type: none"> • 1 engr squad • 1 ACE crew • 1 Dozer crew 	None	70 meters per BTH
4	<ul style="list-style-type: none"> • ACE/DEUCE • 1 HMMWV 	<ul style="list-style-type: none"> • 1 engr squad • 1 ACE crew • 1 DEUCE crew 	None	70 meters per BTH

Land Mines

Mines destroy, delay, disrupt, and channel enemy forces. Conventional mines are hand-laid mines that require manual arming. They are resource (time, labor, supply, and transportation) intensive. Table 15 depicts the effort/resources required to lay a conventional minefield by hand. The work rate and amount of essential supplies are also provided as a function of the minefield density. Table 46, found in section 7 of this document, is a matrix of minefields dimensions and density requirements based on the intent of the obstacle. For example, the purpose of a minefield is to fix the enemy. Table 46 says the minefield should be at least 120 meters deep and 250 meters in length. It also will have a density of 0.6. Therefore, the amount of supplies and work rate is determined by selecting the categories for greater than 0.5. The work rate is shown as the number of man-hours required to emplace 100 square meters of minefield.

Table 15 Land Mines - Conventional Requirements

Priority	Equipment	Personnel	Supplies (Class IV/V)	Work Rate
1	None	Engineer	Minefield density ≤ 0.5 • 1.7 tons (mines, wire, and pickets) Minefield density > 0.5 • 2.6 tons (mines, wire, and pickets) • 1 MOPMS or 1 HORNET per lane	Minefield density ≤ 0.5 • 32 man hours per 100 by 100 meters Minefield density > 0.5 • 66 man hours per 100 by 100 meters
2	None	Non-engineers	Minefield density ≤ 0.5 • 1.7 tons (mines, wire, and pickets) Minefield density > 0.5 • 2.6 tons (mines, wire, and pickets) • 1 MOPMS per lane	Minefield density ≤ 0.5 • 48 man hours per 100 by 100 meters Minefield density > 0.5 • 99 man hours per 100 by 100 meters

- Density is defined as the number of mines per linear meter of frontage. The purpose of the minefield sets the density levels: Disrupt = 0.5, Fix = 0.6, Turn = 1.0, Block = 1.1, and Hasty Protective = 1.0.
- Work Rate is for *normal* soil, with hard packed/frozen soil increase work rate hours by 10%, loose/sandy soil decrease work rate hours by 10%.
- During periods of darkness, increase work rate hours by 100%.

Table 46 Minefield Dimensions

Type	Depth	Width	Density
Disrupt	100 meters	250 meters	0.5
Fix	120 meters	250 meters	0.6
Turn	300 meters	500 meters	1.0
Block	320 meters	500 meters	1.1

Scatterable Mines

Scatterable mines are laid without regard to classical pattern. They are designed to be delivered or dispensed remotely by aircraft, artillery, missile, or ground dispenser. All scatterable mines have a limited active life and self-destruct after their active life has expired. The duration of the active life varies with the type of mine and delivery system. Scatterable mine systems enable the tactical commander to emplace minefields in enemy-held or contaminated territory, or in other areas where it is impossible to emplace conventional minefields. Some systems allow for rapid emplacement of minefields in friendly areas. As with all minefields and obstacles, scatterable minefields are an engineer responsibility. Based on the tactical plan, the maneuver commander's staff engineer determines the location, size, time, and density of the minefield. Use Table 46 above to determine the size of the area that must be seeded by these systems. The company team only has responsibility for emplacing scatterable mines when the ground Volcano, MOPMS, or HORNET systems are used.

- ◆ Volcano - ground. This system is truck mounted and has a capacity of up to 960 mines. (This is sufficient to emplace: 4 disrupt minefields, 4 fix minefields, 1 turn minefield, or 1 block minefield). Mines are dispensed from their canisters by an explosive propelling charge. For ground vehicles, mines can be dispensed 25 to 60 meters on both sides of the vehicle. The vehicle can travel at speeds of 5 to 55 mph (whatever the cross-country terrain allows). Disrupt and turn minefields can be emplaced with one pass along the center of the minefield site. Turn and block minefields require two passes to complete. The Volcano's responsiveness is limited only by the crew's ability to reload the dispenser (20 minutes) and the vehicle speed in traveling to and traversing the area to be mined. Work rates (emplacement times) are determined by the time to load the system (if not already accomplished), the time to drive from the mine dump to the edge of the minefield, and the time to make the required number of passes using the maximum allowable cross-country speed for the vehicle.

- ◆ HORNET. This is a hand emplaced *smart* (it attacks targets from the top at ranges of up to 100 meters and provides a mobility kill to a designated target array) mine used with MOPMS communication capability. In its tactical role it may be employed to disrupt, turn, fix, or block the enemy. It could also be used to close lanes in major antitank obstacles.

- ◆ MOPMS. This is a man-portable suitcase shaped mine dispenser. It can be emplaced anytime before dispensing the mines. Mines are dispensed on command using a remote controlled unit or an electronic initiating device connected to the container by wire. When fired, explosive charges propel 21 mines 35 meters from the container in a 180-degree semicircle. Once the mines are dispensed, they cannot be recovered or reused. They have a life-cycle of 4 hours. This self-destruct time can be recycled three times, for a total duration of 16 hours. (The mines can also be self-destructed on command.) However, if the mines are not dispensed, the container may be disarmed and recovered for later use.

Table 17 Land Mines - Scatterable Requirements

Priority	Equipment	Personnel	Supplies (Class IV/V)	Self-Destruct	Work Rate
1	Volcano - ground 5 ton truck or M548 tracked cargo carrier	crew	960 mines per truck load	<ul style="list-style-type: none"> • 4 hrs • 48 hrs • 15 days 	Disrupt and Fix minefields require 1 pass; Turn and Block minefields require 2 passes (# passes) x (distance/max wcf)
2	HORNET systems <ul style="list-style-type: none"> • Disrupt minefield - 3 • Fix minefield - 4 • Turn minefield - 5 • Block minefield - 6 • Close lane - 1 	2 men to emplace, 1 to fire	1 HIMMWV or small truck	N/A	5 minutes per system
3	MOPMS systems <ul style="list-style-type: none"> • Disrupt minefield - 4 • Fix minefield - 5 • Close lane - 2 	2 men to emplace, 1 to fire - up to 7 systems	None, system is man-packed	<ul style="list-style-type: none"> • 4 hrs • 8 hrs • 12 hrs • 16 hrs 	5 minutes per system

In the Option 1 vignette, the Bn Cdr wants a turning obstacle south of EA Hat, another turning obstacle in front of BP's 5&6, a disruptive obstacle in the eastern portion of EA Kill, two fixing obstacles in EA Kill (one in the south and one in the northwest) and finally a blocking obstacle in front of BP 4. The priority for construction and type of obstacle is:

1. blocking in front of BP4 (landmines)
2. disruptive eastern portion of EA Kill (scatterable mines)
3. turning north of EA Kill (scatterable mines)
4. fixing in the south of EA Kill (landmines)
5. fixing in the northwest of EA Kill (landmines)
6. turning south of EA Hat (anti-tank ditch)

Before an obstacle can be emplaced/constructed a reconnaissance of the site is conducted. This reconnaissance is as detailed as time and the tactical situation permit. The reconnaissance party normally consists of the engineer officer, the company team commander, the engineer squad leaders, and a maneuver fire team for security. (If the likelihood of enemy contact at the obstacle site is *expected* the security element becomes a squad.) The reconnaissance party moves from their current location to the assigned obstacle sites over the shortest route. As a planning factor, site reconnaissance takes 45 minutes for each obstacle site. If two obstacles are to be constructed within close proximity to each other there is only a need for one site reconnaissance (for example, an antitank ditch with a minefield starting on the near edge of the ditch). Any two sites that are within 250 meters of each other are considered to be one site. Distances greater than

this require multiple site surveys. For this vignette the time would be 3hrs. and 45 mins. since the blocking and the southern fixing can be sited in at the same time.

The second calculation focuses on the time available to move the employing element forces from their current locations to the obstacle site, and arrive at the site at the time designated in the OPORD. These times are normal movement times given the actual distance.

The final time is the time to construct the obstacles. An example of the time requirements will be demonstrated using the block obstacle since it is the #1 priority. Using the data in tables 46 a blocking obstacle needs to be 320x500. Table 15 then tells us that it will take engineers 66 man hrs to build a greater than 0.5 density minefield 100x100. A blocking obstacle requires 1.0 density so the man hrs will be approx. 200. This would take an engineer platoon of 20 available soldiers, 10 hours to build. All the remaining obstacles could be built within the 48-hrs. preparation time, with the exception being the turning south of EA Hat. This obstacle was planned as an anti-tankditch and will cause assets that were used in survivability (2 ACE's), so if the Cdr wanted the tank-ditch, he would sacrifice survivability of some of his command and control or direct fire systems.

Overall the defense planning and preparation would take:

Leaders recon	6 hrs
Survivability and countermobility	48 hrs
Total	54 hrs

Appendix 15. Activity Model for 52d Division offensive operations	90
Appendix 16. Mapping of Activities to Objects	100
Appendix 17. Activity Modeling Sheet - Deep Attack by Army Aviation	114
GENERAL	114
ACTIVITY MODELING QUESTIONS	115
Model of a Deep Attack in CADET	134
Activities prior to Deep Attack	134
Activities During Deep Attack	134
Attributes of Key Activities of the Deep Attack	135
Activities After Deep Attack	136
En reactions	136
Fr Counteraction	137
Appendix 18. Modeling for Air Operations Planning	138
Section 1. Introductory Overview	138
Section 2. Proposed Scope Limits and Simplifications	138
Appendix 1	139
Figure III-II	141
Appendix 19. Activity model for Movement to Contact	142
Appendix 20. Cadet Functional mapping: Obstacle Breaching	144
Appendix 21. CADET functional mapping: Defense	154
Option 1:	162
Leaders recon 6 hrs	181
Survivability and counter mobility 48 hrs	181

Appendix 22. Activity Modeling Sheet - Re-supply Operations within a Brigade

ACTIVITY MODELING SHEET

November 18, 1999

Re-supply Operations within a Brigade

GENERAL

Logistical support for a maneuver brigade is centered around the operations of the Brigade Support Area (BSA). The Brigade S-4 and S-1 will operate the Brigade Rear Command Post (CP) from the BSA, co-locating with the tactical operations center (TOC) of the Forward Support Battalion (FSB) to provide command and control (C&C) for support operations.

The FSB is organic to the Division Support Command (DISCOM) and placed in Direct Support (DS) to the brigade. It consists of a supply company, a maintenance company and a medical company. The Maintenance Company deploys Maintenance Support Teams (MST) to assist the maneuver battalions. The Medical Company sends ambulances forward to pick up patients from the battalions. The result is that even though an FSB has about 300 people assigned, only about half them will be present in the BSA during operations.

The other occupants of the BSA are the field trains of the brigade subordinate elements, including the Headquarters and Headquarters Companies (HHC) of the maneuver battalions. The field trains include a large portion of the maintenance capability (including about half of the MST from the FSB), supply vehicles and logistics C&C.

The BSA might also have MSTs from higher echelons. Often the Main Support Battalion (MSB) will deploy its MSTs forward to help the FSB and make the handoff of workload from the FSB to the MSB easier. Also, doctrine says the Corps Support Command (COSCOM) may deploy its MSTs forward into the division area to assist. (Conventional wisdom says if you wake up one morning and MSTs start appearing from the MSB and from COSCOM, your life is about to get a lot more interesting.)

The BSA is fairly large, occupying up to 12 square kilometers of space. It is difficult to disguise its location and purpose. It will normally be at or near the limit of enemy artillery.

The BSA will move every 2-3 days, more often if the situation dictates. The guiding principle of the FSB is to keep only those things which can be entered back into the fight within 1-3 days. For example, medical patients with serious injuries will be evacuated back to higher echelon medical support. The same applies to maintenance work. If it can't be fixed within a reasonable time, it gets handed off to higher echelon maintenance. The management of the exact timelines is a critical piece of the log planning as the logisticians balance the need to keep maximum combat power forward while minimizing the impact of dragging around extra weight.

Immediately behind the combat elements, the maneuver units will establish combat trains with emergency fuel and ammunition supplies and emergency medical and maintenance support (including the other half of the MST from the FSB). The combat trains are well within range of indirect artillery fire, which puts them at constant risk. Accordingly, they will attempt to minimize their signature to avoid detection. They will also try to keep the size to a minimum to increase mobility. The combat trains might move 2-3 times per day or more.

Supplies are delivered to the FSB by higher level supply elements. These include the MSB in the DISCOM, COSCOM units from the Corps Support Battalion (Forward), CSB(F), directly behind the division, the Corps Support Group (Rear), CSG(R), supporting the entire

corps and might include deliveries directly from the port. Evolving doctrine calls for maximum use of through-put which means there will be more of this direct delivery. Modeling the source of deliveries to the brigade is impractical unless the entire theater is modeled.

Supplies are delivered through-out the day, based on the distribution schedule of the COSCOM and DISCOM, rather than by schedule. The tremendous volume of ammunition and fuel required to support a brigade in heavy combat requires a turn-over of inventory at least three times per day. The brigade burns approximately 180,000 gallons of fuel daily. The FSB can only store 50,000 gallons at any given time, since they only have 10 each 5,000 gallon tankers. The FSB must receive and issue their full capacity three and a half times daily to meet the demand of their customer units.

The primary method of distributing fuel and ammunition to the combat elements is via logistics packages (LOGPAC). LOGPACs are initiated by the Support Platoon Leader (SPL) of the HHC. As requirements dictate, he puts together a LOGPAC to take forward critical resupply, typically once or twice daily. Included in the LOGPAC will be fuel and ammo trucks, along with repaired vehicles, repair parts, water, mail, other supplies, replacement soldiers, and soldiers returning from medical facilities. If hot meals are being served, the meal will be cooked in the field trains and transported forward, too. With the fuel and ammo trucks and the vehicles returning from maintenance, a LOGPAC can easily number over two dozen vehicles and stretch 3 kilometers in length.

The SPL will lead the LOGPAC to a pre-designated point called a Logistics Release Point (LRP) near the rear of the maneuver companies. There, a guide will link up with the LOGPAC and vehicles designated to support a particular company (these can be thought of as company LOGPACs) will peel off from the formation, moving independently to the company area. After the SPL has linked up all of the company LOGPACs with their guides, he proceeds to the battalion combat trains to perform re-supply.

After the SPL completes his support operations at the combat trains, he will begin re-assembling the LOGPAC to return to the field trains. The return LOGPAC includes broken vehicles which need repair in the field trains, personnel casualties not previously evacuated, requests for repair parts, and empty re-supply vehicles. In peacetime, it generally includes truckloads of trash for disposal. The SPL leads the LOGPAC along a path past the company LRPs (in practice, the LRPs often change between pick-up and drop-off to avoid setting an obvious pattern for the enemy. Good units will also establish a number of alternative LRPs in the event some are compromised.) As the SPL passes the LRPs, the company LOGPACs rejoin the LOGPAC for the return to the BSA.

Upon arrival at the BSA, the empty supply trucks will be re-stocked as soon as possible. This keeps them "ready". It also helps the FSB keep stocks flowing.

MODELING WITHIN CADET

Four major activities need to be modeled.

- 1) Movement from the BSA to the LRP.
- 2) Servicing the Maneuver Unit (the download of fuel and ammo)
- 3) Movement from the LRP to the BSA
- 4) Receiving resupply from the FSB (the upload of fuel and ammo)

Movement from the BSA to the LRP

CADET's Dijkstra route selection will be used to get the shortest path from the BSA to the LRP. This is based upon the road quality or restriction level of each segment. (Dijkstra's algorithm is used by CADET for route selection).

The speed should be set at 40 kph default.

It is not necessary to model the different company LRPs. Instead, the location of the combat trains should suffice.

Servicing the Maneuver Unit

The current modeling of re-supply should work well in this activity.

Modeling the sub-activities would not benefit the battalion planners.

This requires 100% of both the unit being supplied and the LOGPAC resources.

This activity will last 30 minutes.

Movement from the LRP to the BSA

CADET's dijkstra route selection will be used to get the shortest path from the BSA to the LRP. This is based upon the road quality or restriction level of each segment. For more advanced modeling, it might be nice to give the user an option to search for an alternate route to avoid setting a pattern but that is beyond the current level of effort.

Speed should be set at 30 kph default in recognition of the broken vehicles being dragged back, if that is feasible.

Receiving resupply from the FSB

The current modeling of re-supply should work well in this activity.

This requires 100% of the LOGPAC resources. The FSB can resupply only one LOGPAC at a time, but it can handle about half the LOGPAC simultaneously. The actual time length for this activity should be default to 60 minutes. If the LOGPACs are scheduled correctly into the FSB, there should be little or no queuing but in the case that a LOGPAC is being resupplied by the FSB at the time another LOCPAC returns to the BSA, the first resupply will be completed before scheduling next LOGPAC resupply.

	End at H+N	End at H+(N+0:30)	End at H+M	End at H+(M+60)
CSS	<i>Supply Unit</i> Travel from BSA To LRP	<i>Mvr Unit</i> Resupplied by <i>Supply Unit</i>	<i>Supply Unit</i> Travel from LRP to BSA	<i>Supply Unit</i> resupplied by <i>FSB</i>

Figure 1: Appearance on the Sync matrix.

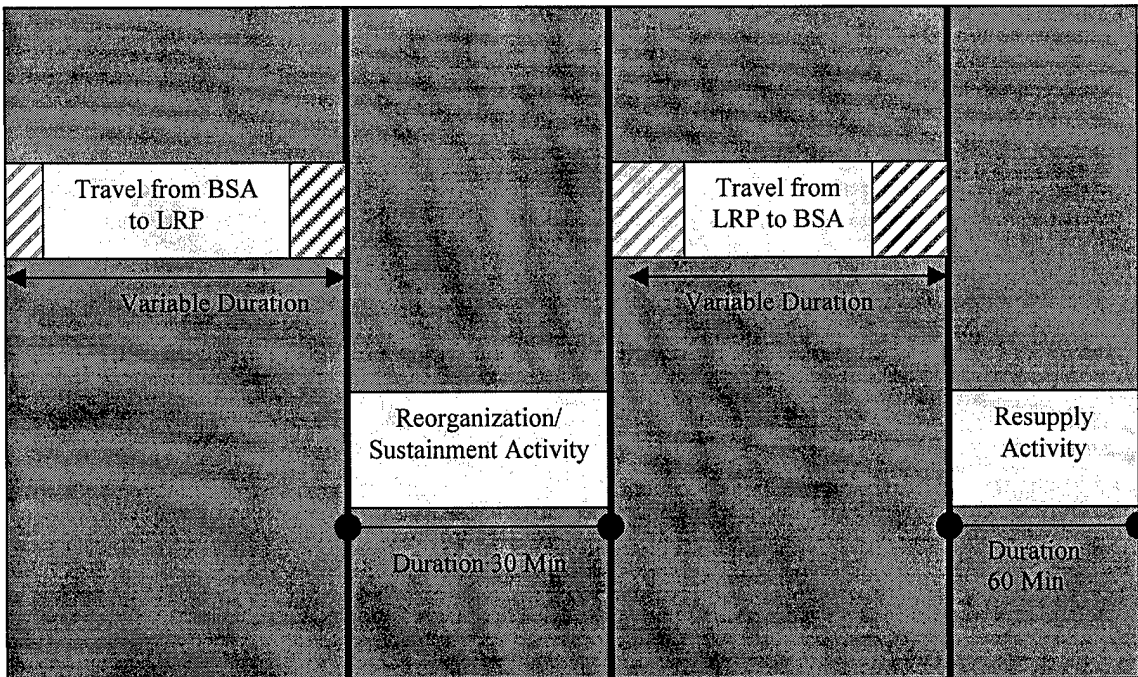

Figure 2: Timings for Derived Activities

BIBLIOGRAPHY

FM 10-1 Quartermaster Principles

FM 63-3 Corps Support Command

FM 71-123 Tactics and Techniques for Combined Arms Heavy Forces: Armored Brigade, Battalion/Task Force, and Company/Team

FM 100-10 Combat Service Support

LM 0026 Support Operations Phase I (course material)

ALM 69-0026-LB(D) Lesson Book, Support operations Course (Phase I)

CGSC ST 63-1 Division and Corps Logistics

CGSC ST 101-6 G1/G4 Battle Book

Appendix 23. Activity Modeling Sheet - Emergency Evacuation of Logistics Facilities

ACTIVITY MODELING SHEET

November 18, 1999

Emergency Evacuation of Logistics Facilities

GENERAL

The general rule for logistics units is that they need to be as close as necessary to provide adequate support but far enough away to avoid interfering with the maneuver units need to retain mobility. A complementary rule is that fixes, both to personnel and materiel, should take place as far forward as possible to return them to the fight with minimal delay. Conversely, any failures which cannot be returned to the fight within a desirable period of time, should be evacuated out of the area quickly.

Timelines are set for both maintenance and medical, called maintenance time lines and medical evacuation timelines. A medical timeline of 72 hours means any soldier injured or diseased who cannot be returned to duty (RTD) within 72 hours would be evacuated as soon as possible. Note the patient isn't held 72 hours and then evacuated. The evacuation happens as soon as the determination is made that he does not meet the 72 hour time frame for RTD.

Timelines are lengthened during offensive operations, to keep potentially repairable systems as far forward as possible and avoid evacuating systems too far to the rear. Timelines are shortened during defensive operations to get systems which cannot be repaired quickly out of the way and free up resources for other missions.

During offensive operations, where friendly forces are moving forward, the lines of communication (LOC) are stretched if the maneuver units continue moving forward but the log units don't move to keep up. Log facilities should be located close behind the maneuver elements prior to launching the offensive. Then, they must be prepared to move often when the distance between them and the lead elements becomes too much to allow timely re-supply.

During defensive operations, if it may be necessary for friendly units to move rearward, often to position on more defensible terrain. The log units must be prepared to move rearward, usually before the maneuver units begin moving rearward. With proper planning, the log unit would move to a new support location and provide continuous support from the new location as the maneuver units fight and move rearward.

Rules Of Thumb

The **rules of thumb** for Brigade Support Area (BSA) locations are:

- In the offense, close behind the maneuver units (10 kms or closer) and prepared to move forward when LOCs stretch to about 40 km.
- In the defense, back about 20 kms or more, behind the maneuver units and prepared to move when the maneuver units are within 10 kms.

- The need for an emergency evacuation is indicated by maneuver unit movements, friendly or enemy, which place the logistics facility within their direct fire range. Because logistics units present "easy" targets, units coming in contact with logistics units can be expected to engage them and attempt to destroy them.

Planning Considerations

- In planning for an emergency evacuation, the log unit should:
- Always evacuate irreparables as soon as possible. Personnel who cannot be returned to duty within the evacuation timelines and equipment which cannot be repaired within the maintenance timelines should be evacuated on a continual basis.
 - Review the timelines for maintenance and medical and update them as the situation changes.
 - Always designate an alternate location for the BSA in the event of an emergency evacuation. It should be approximately 30 kms rearward of the current location. Moving less than 30 kms is normally more trouble than the advantage gained by moving.
 - Movement is usually by echelon. The bulk of the log unit will move in the first echelon, to establish a new base of support in the new location. The remainder of the log unit will remain to provide "stay behind" support. The "stay behind" element should be highly mobile, and be limited to the smallest possible size, bearing in mind they will be subject to a high degree of risk.
 - Deliveries from higher level support must be diverted to the new location.

MODELING IN CADET

Indication: Emergency evacuation will be needed when combat forces are projected to move within direct fire range of the BSA.

The timing of the initial unit move should occur so that the first echelon moves to the new location and arrives prior to the final echelon moving and the final echelon moves out before the closest approaching unit gets within direct fire range.

This does not factor in movement of the advance party or quartering party.

For most large unit movements, an advance party of no more than 5% of the unit will move early to secure the site and conduct reconnaissance.

A quartering party consisting of up to 15% of the unit will follow to select locations on the ground and prepare for movement of the main body (in this case, the first echelon of the main body).

Neither the advance party nor the quartering party is capable of performing logistical support for customer units. Both are tailored for the specific mission of facilitating and speeding the movement of the main body.

The timing and composition of the advance party and the quartering party will vary based on the size of the unit moving and METT-T factors. We will not model them in CADET because they do not contribute significantly to the combat planning and are generally well handled at the battalion level.

The first echelon will require approximately 2 hours to prepare for movement. Movement will be calculated based on the distance, using the advance along secondary roads default speeds.

Higher level support is notified of the time of the move to re-direct deliveries.

When the first echelon arrives, it will initially begin "tailgate support" while simultaneously establishing support base. The later requires approximately 2-4 hours.

The second echelon will move as soon as the first echelon arrives. Movement is calculated based on the distance, using secondary road advance rules.

BIBLIOGRAPHY

FM 10-1 Quartermaster Principles

FM 100-10 Combat Service Support

LM 0026 Support Operations Phase I (course material)

ALM 69-0026-LB(D) Lesson Book, Support operations Course (Phase I)

CGSC ST 63-1 Division and Corps Logistics

CGSC ST 101-6 G1/G4 Battle Book

Appendix 24. Activity Modeling Sheet - Regeneration

ACTIVITY MODELING SHEET

November 18, 1999

Regeneration

GENERAL

There are two types of reconstitution: **reorganization and regeneration**. Reorganization is further broken down into hasty and deliberate.

Hasty reorganization includes the re-arming and re-fueling which occurs at the end of most offensive operations. The unit conducting the offense will stop its forward movement long enough to re-arm and re-fuel the tactical vehicles using the assets from the battalion combat trains. The activity goes pretty quickly. Each fuel HEMTT (heavy expanded mobility tactical truck) can service two combat vehicles at the same time.

The tanks will generally need 150-200 gallons of fuel each, after a fight of average length, say 4-6 hours. (The fuel consumption rate for cross-country movement is 54.2 gallons per hour, but most tanks will have experienced some combination of cross-country movement along with significant periods of idling, while they wait for others to get into position. While idling, the M1A2 burns only 10.2 gallons per hour.)

If the HEMTT fuel pumps are operated at 50 gallons per minutes, it will take up to 4 minutes of pumping time per tank. The time required to switch tanks varies from 1 to 5 minutes per tank, depending on training and motivation. On the average, 5-7 minutes will suffice to re-fuel tanks.

Re-arming takes about the same amount of time. Using a "bucket brigade" chain, the ammunition can be passed into the turret very quickly. The slowest part is maneuvering the rounds into the stow racks and securing them. Attempting to ride with the rounds lying loose in the bottom of the turret is disastrous. The ammunition gets damaged and the crew does not have enough room to move around safely. It takes only a few seconds longer to secure the rounds properly.

Re-arming and re-fueling can be performed simultaneously.

The other activities taking place during the hasty reorganization include medical and maintenance, as well as eating.

All or most of the actions required in the hasty reorganization are handled by the maneuver unit and the combat trains. Following the hasty reorganization, the combat trains need to be resupplied soon by the field trains to get back to full strength. The field trains would, in turn, obtain resupply from the forward support battalion in Direct Support to the brigade.

A deliberate reorganization would take place when a unit has suffered a higher degree of casualties and losses but still within the capability of the unit and its higher echelon support unit to resolve. A deliberate reorganization involves the maneuver unit and its trains, both combat and

field trains, and the support battalion from the Division Support Command (DISCOM) operating in Direct Support.

One way of looking at the deliberate reorganization is to consider a situation where all three support elements are co-located: the combat trains, the field trains and the FSB assets. The combat trains and field trains are ministering directly to the combat vehicles, while the FSB assets provide continuous re-supply into the trains without their having to travel to pick-up supplies.

A good example is the re-fueling method where a HEMTT is set up to provide retail support to the combat vehicles with tanks driving up on either side to get fuel from the HEMTT. Meanwhile, the Forward Support Battalion (FSB) positions a 5,000 tanker of fuel close by and continuously refuels the HEMTT. The advantages here are that the HEMTT's hoses and pumps are designed specifically to refuel tanks. The FSB tanker's hoses are designed to go into HEMTTs or ground storage. The FSB's pumps are not well suited to refueling tanks and in numerous attempts have been shown to blow out the fuel cells in the tanks, necessitating expensive repairs. The arrangement also allows the FSB to swap tankers easily, keeping the fuel flowing smoothly into the HEMTT without interruption.

A deliberate reorganization will generally occur further to the rear than a hasty reorganization, possibly at some point about half way between the combat trains usual location and the Brigade Support Area (BSA). Moving FSB assets further forward can be a problem because they lack the maneuverability of HEMTTs and other tactical vehicles. They also provide a larger signature making them easier for the enemy to see and attack. The value and scarcity of the support vehicles makes it important to minimize the risk to them. Also of major concern is the time lost by the tactical unit moving rearward to perform the reorganization and then moving forward again to re-join the fight. The tactical unit will be subject to observation and attack as a result of its movements, too, making it important to minimize movement for him as well.

Regeneration is the most serious of reconstitution efforts, undertaken only when a unit can not longer perform its assigned tactical mission. It requires large amounts of support from outside the unit being regenerated. The doctrinal rule of thumb is that a unit being regenerated requires the support of the unit two echelons higher. Thus, regeneration of a battalion requires support from the division. Regeneration of a brigade requires support from corps.

Regeneration takes a lot of time. For a battalion, regeneration would be planned to last 24 hours at a minimum and closer to 72 hours. For a brigade, it would take a minimum of 72 hours with 120 hours preferred.

Experience has shown that regeneration is generally most successful if the unit is removed completely from the fight. The rule of thumb for location is that it should take place in a secure area beyond artillery range, and if possible, beyond the sound of artillery.

The determination of when a unit should undergo regeneration rests with the higher level commander, in coordination with his commander. At the division level, commanders may choose to form a Regeneration Task Force (RTF), with personnel trained especially to enter units and evaluate the need for regeneration. The DISCOM can assist with the regeneration. Because they are closer, DISCOM assets should move immediately to the site to secure the site, to greet the unit when it arrives, and to provide limited support until the RTF arrives and takes over.

For planning purposes, there is some consensus that a unit which has fallen below 70% effectiveness should be monitored closely for possible regeneration. A unit which drops below

50% is considered a prime candidate for regeneration. A unit which drops below 30% should be withdrawn from the fight as soon as possible and is at risk of being too depleted for regeneration to be effective. In this case, the unit is disbanded and the weapons systems and soldiers consolidated into other units. In cases where this has been necessary, the impact on the morale and spirit of the soldiers has been devastating. Experts recommend erring on the side of withdrawing a unit for regeneration too early rather than taking the risk of doing so too late.

There are no absolutes. There are historical examples of units reduced to shells of their former selves which have continued to fight well because the situation demanded it. There are examples of units suffering negligible losses which became incapacitated for whatever reason and were to continue their missions.

The key elements of the regeneration are:

- Identifying the need for regeneration
- Moving the unit expeditiously to a safe, secure place.
- Moving the Regeneration Task Force (RTF) to the regeneration site.

MODELING IN CADET

Identifying the need for regeneration.

A unit will be identified at two points. A "caution" will happen when the unit falls below 70% effectiveness. The planner will be advised to "Monitor this unit for possible need to regenerate."

A "warning" will happen when a unit falls below 50% effectiveness. The model will attempt to schedule a regeneration at that point.

Moving the unit to a safe place.

CADET will move the unit "back" along the route of advance to a location approximately 10 kilometers behind the BSA. The user will adjust the location as needed. The default speed for movement along secondary roads will be used.

Moving the RTF to the site.

Because the higher level support units are not modeled, CADET will not try to model their current locations and movements.

CADET assumes a DISCOM unit will provide the immediate RTF support until the RTF can arrive. DISCOM units are generally closer and can move to the site and set up initial capability until the RTF arrives. After the RTF has been on site 12 hours, the DISCOM units would return to their normal duties.

CADET will assume that from the time a regeneration is scheduled, until the RTF is in place and fully functional will be no more than 12 hours.

CADET will schedule the regeneration to be 72 hours for a battalion and 120 hours for a brigade.

Maneuver unit

A unit undergoing regeneration cannot perform any other missions, including reconnaissance and planning, until the regeneration is complete.

The unit effectiveness returns at the completion of the regeneration in a single discrete increase. It is not a gradual increase over time.

Support unit

A support unit/RTF can only regenerate only one unit at a time.

A support unit/RTF cannot conduct any other missions at the same time.

BIBLIOGRAPHY

FM 10-1 Quartermaster Principles

FM 63-3 Corps Support Command

FM 71-123 Tactics and Techniques for Combined Arms Heavy Forces: Armored Brigade, Battalion/Task Force, and Company/Team

FM 100-10 Combat Service Support

LM 0026 Support Operations Phase I (course material)

ALM 69-0026-LB(D) Lesson Book, Support operations Course (Phase I)

CGSC ST 63-1 Division and Corps Logistics

CGSC ST 101-6 G1/G4 Battle Book

Appendix 25. Design Note - Route Selection

Design Note:

Notes on the approach and rules for selecting a route in CADET.

This is a good example of the early design rationale. Actual implementation of the code was guided by these considerations but *may differ in details*. Consult the Javadoc Design Documentation for the most current implementation.

Author: A. Kott

Date: 5/11/98

Last updated: 5/11/98

This memorandum presents CADET's team proposal to define the scope and the development approach to the route planning capabilities within Phase-II CADET system. The key objective is to assure that the CADET system designers and developers have appropriate, clear and realistic objectives and guidance for developing what has been termed "Route Planning" capabilities within CADET Phase-II project.

The memorandum is divided in the following sections:

- Introductory Overview of Planning Movement under Maneuver
- Example
- Problem Statement
- Proposed Scope Limits, Simplifications, Priorities

Section 1. Introductory Overview of Planning Movement under Maneuver

The following considerations focus the entire discussion in this document:

- we focus on the Analysis Phase of the MDMP;
- we focus on the process performed by the Divisional Planning Cell;
- we focus on planning the movement under maneuver.

The COA development phase occurs prior to the Analysis phase and results in determination of various axis of attack involved in the COA. However, the route/axis planning also occurs in the Analysis phase as explained below.

Wargaming includes identification of opportunities for branches and sequels. As a staff member identifies possible enemy reactions for each of his own actions, he can also identify branches (alternatives) that he can later develop for possible inclusion into the OPORD/OPLAN. A branch is defined as follows: A contingency plan or course of action (COA) (an option built into the basic plan/course of action) for changing the mission, disposition, orientation, or direction of movement of the force to aid success of the operation based on anticipated events, opportunities, or disruptions caused by enemy actions and reactions as determined during the wargaming process.

An evaluation of AAs identifies those that best support maneuver capabilities. It should be performed by the G2/S2 or his analysts, with assistance from the G3/S3 as required. Evaluate them for suitability in terms of:

- Access to key terrain and adjacent avenues
- Degree of canalization and ease of movement
- Use of concealment and cover (force protection from both fires and intelligence collection)
- Use of observation and fields of fire
- Sustainability (LOC support)
- Directness to the objective.

Once the avenue of approach (or a sequence of AA's) has been selected, the maneuver control will be selected. One type of maneuver control is axis of advance. Another is a direction of attack.

“Axis of advance is a general **route** of advance, assigned for purposes of control, which extends toward the enemy.... It follows terrain suitable for the size of the force assigned the axis and is often a road, a group or roads, or a designated series of locations. A commander may maneuver his forces and supporting fires to either side of an axis and the objective...

Direction of attack is a specific direction or **route** that the main attack or the center of mass of the unit main body of the force will follow. The unit is restricted, required to attack as indicated, and is not normally allowed to bypass the enemy. The direction of attack is used primarily in counterattacks or to ensure that supporting attacks make maximal contribution to the main attack. Direction of attack is a more restrictive control measure than axis of advance, and units are not free to maneuver off the assigned route. It usually is associated with infantry units conducting night attacks, or units involved in limited visibility operations, and in counterattacks. “

Section 2. Example

Figure 1 depicts a COA sketch. Figure 2 a branch of the COA. Branch 2 was developed due to the results of COA analysis. Wargaming determined that the 1-63 Infantry Regiment is degraded by friendly artillery, and attack helicopters to the point it is not a threat to the 2nd Brigade. The 1-1 Guards Tank Regiment is proceeding rapidly to Obj Rhino and the 2nd Brigade must move quickly to assist in the destruction of the tank regiment at EA Hole. The staff directs the 2nd Brigade to follow axis of advance Shark. This axis of advance is determined during the analysis phase. It will support a brigade with two battalions abreast in battalion-sized mobility corridors in brigade-sized avenues of approach. In this case, axis of advance Shark has been composed from several avenues of approach (see Fig. 3). Selection of these specific avenues of approach is done from an evaluation of available avenues of approach utilizing the criteria discussed above. During the analysis, it is determined that as compared to axis of advance Bull, the axis of advance Shark offers the advantage of time, which in this case was determined to be the decisive criteria.

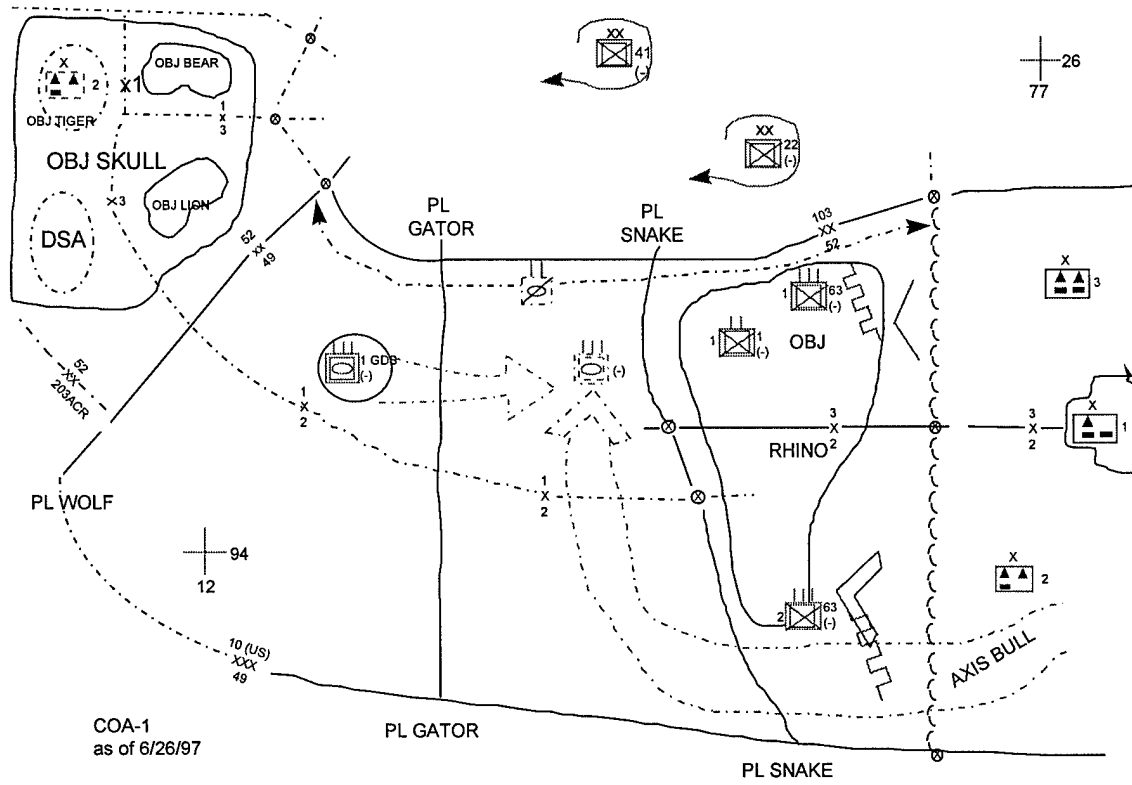

Fig. 1. The Initial COA.

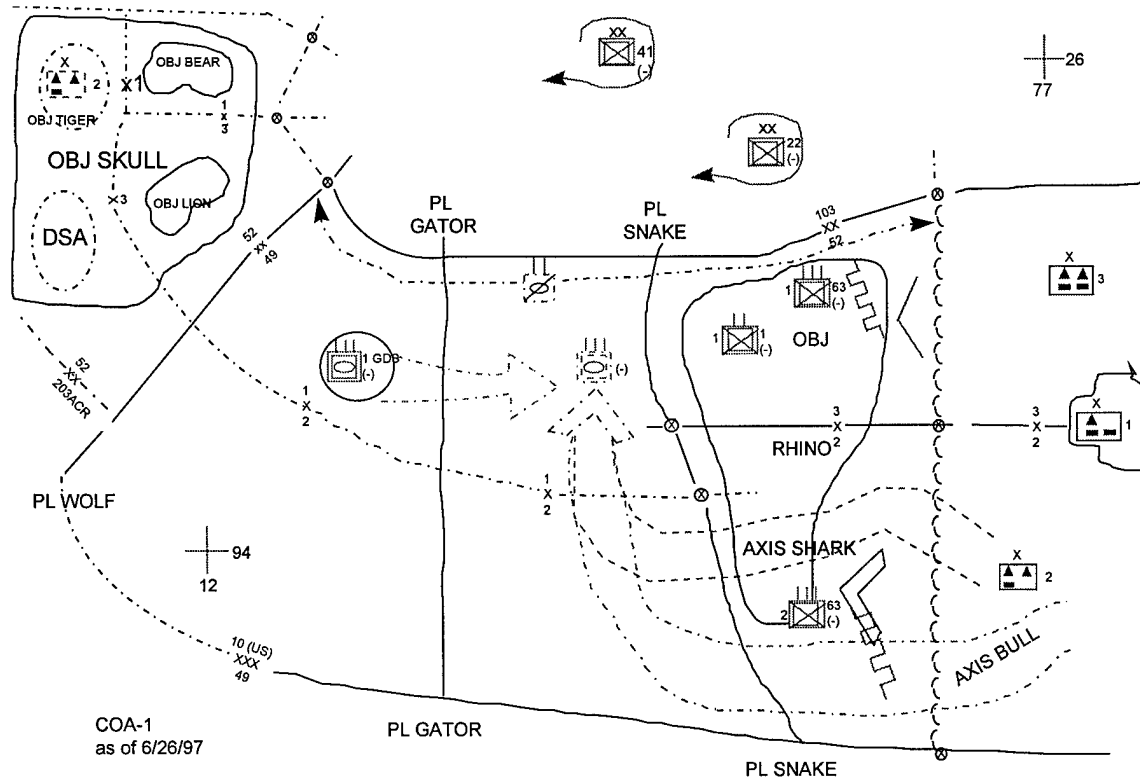

Fig. 2. Branch of the Initial COA, Showing a New Axis of Advance SHARK.

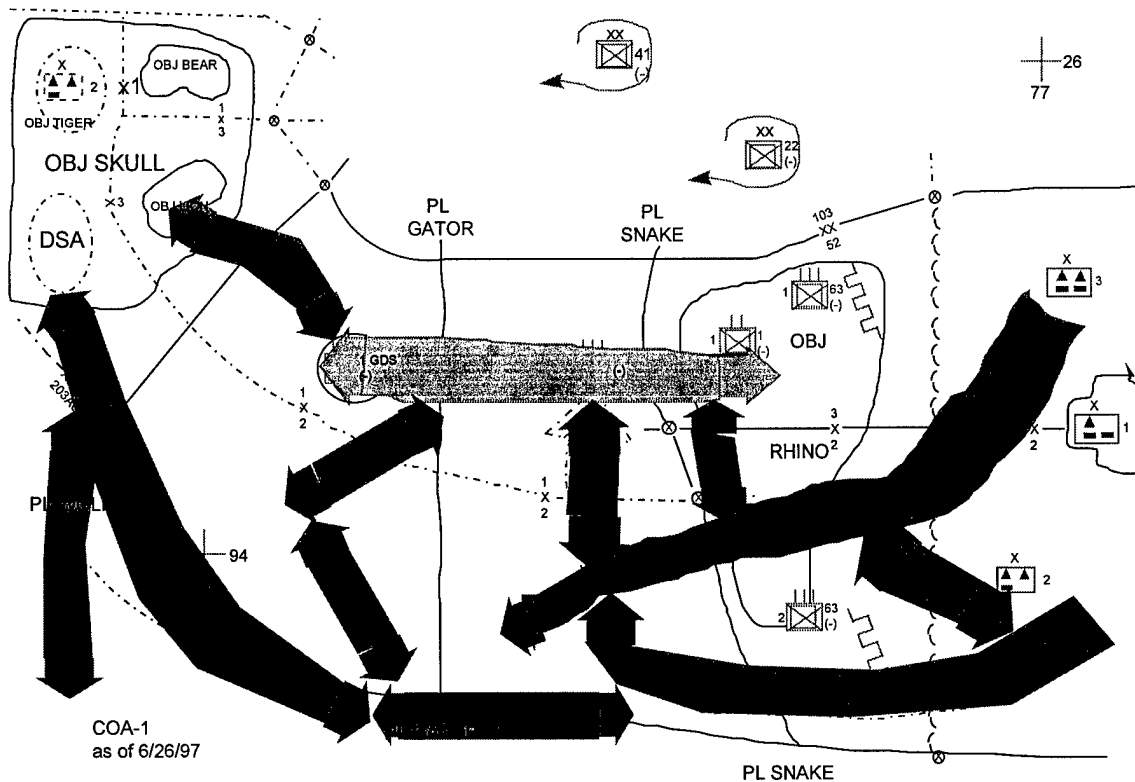

Fig. 3. Avenues of Approach.

Section 3. Problem Statement

What follows is our understanding of what constitutes the nature of the Automated Route Planning problem to be addressed by a computational decision-aid such as CADET. Although specified mainly in terms familiar to the end-user, this statement is biased toward the needs of the system designers. It strives to formulate what can be considered as "given" to the computer when it starts the problem solving, what needs to be determined, and what considerations should be observed by the computer while finding good solution. Naturally, it is restricted in scope - there are many aspects to this problem and we selected what we considered most important to this project.

Given:

- one or several Friendly units of force that are to perform movements, e.g., brigades, squadrons or batallions;
- each unit is characterized by:
 - nominal size (Bde or Bn)
 - type (armored or mechanized infantry)
- a network of multiple Avenues of Approach (e.g., such as depicted in Fig.3)
- each Avenue of Approach (AvApp) is characterized by:
 - set of coordinate points representing the axis of the avenue;
 - size (Bn or Bde);
 - length;
 - characterization of the traversed terrain in terms of mobility;

- characterization of the traversed terrain in terms of cover and concealment;
- presence of key terrain where En forces can offer strong defense;
- narrow passages that restrict formations;
- presence of air avenues of approach advantageous to enemy;
- specific obstacles on the AvApp, kill zones, river crossings;
- strength of enemy present on the AvApp, or within the range of direct or indirect fires;
- ability to switch to alternative route;
- time window of unavailability (e.g., it may be known upfront that the AvApp will not be available for movement in a given time window); .
- move origination area (e.g., an Assembly Area);
- move destination, which can be of two types:
 - fixed destination - area;
 - moving destination - a moving footprint area (enemy unit), for which route and timing are known from the En COA;
- departure time window - when the unit can start the movement;
- arrival time window in which the unit must reach the destination;
- definition of route cost function (see below).

Find:

- a connected sequence of AvApp's for each Friendly unit that enables each unit to move from its origination area to the destination, observing all pertinent constraints and objectives (here we will call it route, although depending on the particular maneuver control type selected, a more appropriate term is either Axis of Advance or Direction of Attack);
- required supporting activities (mobility, refuel, etc.) with their locations and timing;
- time of start and end movement for each AvApp;
- waiting points and time periods during the route (e.g., the unit may have to wait until another unit passes, or for refueling, etc.).

The objective in selecting a good route is to minimize the route "cost" or "penalty" as described by a combination of its disadvantages:

- presence of key terrain where En forces can offer strong defense; in case of ARMD/MECH forces examples include: ridge line, high ground, built-up areas, forested areas;
- obstacles, kill zones, river crossings;
- areas of restricted mobility: swamps, rocky terrain, high slopes (particularly in rain and snow);
- narrow passages that restrict formations;
- air avenues of approach that offer concealment to the approaching En air assets (this is mitigated by availability of friendly ADA assets);
- being within LOS of enemy units;
- being within range of fire of enemy units;
- terrain that does not offer opportunities for concealment of movement;
- potential for heavy traffic of civilians or POWs;
- overall time required for the move via the selected route;
- lack of opportunity to switch to another AvApp in case of necessity;

Additional possible disadvantages in case when a unit "splits" into two (or more) sub-groups and advances over several routes:

- inability to communicate (e.g., a terrain feature between two routes prevents radio LOS);
- inability of to move between the two (or more) routes in order to support another group (lateral mobility);
- Fire Support unable to support all of the separate groups;

Observe constraints:

- size of the unit must be compatible with the capacity of the AvApp, e.g., a Bde should not be normally assigned to a Bn-sized AvApp;
- timing of all activities consistent with rate of movement of the unit;
- normally, only one unit can use the same section of AvApp at the same time;
- normally, only one unit can use the intersection of two AvApp's at the same time.

Section 4. Proposed Scope Limits, Simplifications, Priorities

As described above, the problem is complex and a complete solution is far beyond what can be accomplished within the scope of this project. We now discuss the selected aspect of the problem that we propose to consider in this project. We also propose priorities (Priority 1 and Priority 2) to the capabilities. Our primary focus will be the Priority 1 features. Some of the Priority 2 features may also be addressed, depending on the extent of demands from other functional areas of the project.

We will assume that CADET will have available a database that describes a network of AvApps (Priority 1). Each AvApp will be given numerical or qualitative characteristics such as mentioned in Section 3 above (Priority 1). Where an AvApp has widely different characteristics along its length, it will be divided into approximately uniform sections (Priority 1). However, many characteristics related to the risk and threat, particularly cover and concealment, degree of restriction, threat air avenues of approach, flexibility, etc., will be "lumped" into a single ranking. In this project, all this data will be entered manually. In future developments of CADET, we expect this information to be available from other systems that are responsible for IPB and terrain analysis.

Estimation of strength of the threat for a given AvApp will be done based on static information of enemy defensive COA (without taking into account possible reactive movements of En forces) (Priority 1). Later such reactive movements of En forces can also be taken into account (Priority 2).

CADET will automatically search for a sequence of AvApp's that lead from the origin area to the destination area (Priority 1), including those cases where the destination is a "moving target" like in Fig.1 or Fig.2. (Priority 1). It will search to find several such routes (Priority 1), up to a specified number (say, 3). CADET will take into account size of the unit and capacity of the AvApp (Priority 1).

For each route found, CADET will compute the time required for traversal taking into account mobility characteristic of the AvApp and the type of the unit (Priority 1). It will also compute the measure of "penalty" (as discussed in Section 3) combining overall measures of threat risks and the time required to accomplish the move (Priority 1). The weighting factors of risk vs. time will be adjustable by the users of CADET (Priority 1). CADET will present several selected and ranked routes to the user and the user will make the final selection of the desired route (Priority 1). The user will be able to request and obtain the summary of specific calculations for each route (Priority 1).

For each route, CADET will automatically add movement-related activities (Priority 2) if required, specifically: rest, refuel/rearm, wait for supporting units, wait for passing units, breach obstacles. CADET will assign specific time points for each move (Priority 1), including the movement-related activities mentioned above (Priority 2).

When multiple units move on different routes and have a potential for interfering with each other movements (e.g., two units must use the same mountain pass or route of one unit must cross the route of another), CADET will assign times of movements in such a manner as to optimize the use of space and speed-up higher priority movements (Priority 2).

We will not yet attempt to address the very complex issues that relate to the automated reasoning about splitting of a unit into sub-units for maneuver movement, or the issues arising from the need for several units to provide mutual support during the maneuver.

The Provisional Technique for Automated Selection of Optimal Route/Avenue of Approach/Axis of Attack

Assume $\{R\}$ is the set of all possible routes from A to B

We will select the route R' with the lowest weight among all routes within the set $\{R\}$. The weight is defined below.

$W(R)$ - weight of a route.

Then $R' \in \{R\} | W(R') \leq W(R)$, for $\forall R \in \{R\}$.

Route is a sequence of segments.

$R = \{S_i\}$, $i \in [1, n]$

Weight of a route is a sum of the weights of route's segments.

$$W(R) = \sum_{i=1}^n W(S_i)$$

A segment's weight is a sum of penalties for the time it takes to traverse it, for suboptimal access to key terrain and adjacent avenues of approach, for suboptimal degree of canalization; for suboptimal concealment and cover; for suboptimal observation and field of fire, and for presence of threat in the vicinity of the segment. Each component of the penalty is multiplied by a weight. All values of weights and coefficients in this memo should be interpreted as provisional and subject to future calibration.

$$W(S) = t(S) \cdot wt + AK(S) \cdot wAK + DC(S) \cdot wDC + CC(S) \cdot wCC + OF(S) \cdot wOF + TH(S) \cdot wTH$$

$t(S)$ - time to traverse the segment S (hrs); $t(S) = f(\text{length of } S, \text{trafficability, type of unit})$, $wt = 1$;

$AK(S)$ - penalty points, 3 for medium, 9 for low for each KM for less than high access to key terrain and adjacent AA's;

$$wAK = .25$$

$DC(S)$ - penalty points, 3 for medium, 9 for high for each KM for less than low degree of canalization;

$$wDC = .25$$

$CC(S)$ - penalty points, 3 for medium, 9 for low for each KM for less than high use of concealment and cover;

$$wCC = .25$$

OF(S) – penalty points, 3 for medium, 9 for low for each KM for less than high observation and field of fire;
 wOF = .25

TH(S) – strength of the hostile forces (threat) capable of attacking the unit, i.e., within the range of the threat unit; measured by threat UE divided by the UE of the friendly unit.
 wTH = 30

All weights can be modified by the user. User's input, for simplicity, will be limited to 3 values: high, medium, low (e.g., "high" denotes that the user gives high priority to minimizing the impact of the given factor). The default weight will be multiplied by 5 if the user enters "high"; by 1 if "medium," by .2 if "low.

Example

Let us consider how the above weight-computing procedure is applied for computing the weight of a given route. The Route consists of 3 10km-long segments. The unit is heavy mech. Strength of the unit is 3 UE.

Segment S1 is severely restricted, otherwise no concerns.

S2 – threat of 1UE, otherwise no concerns, excellent trafficability.

S3 – poor AK, DC, CC, OF; no threat, excellent trafficability

$$W(S1) = 10 \text{ (hrs)} * wt + 0 + 0 = 10$$

$$W(S2) = .2 \text{ hrs} * wt + 0 + 1/3 * wTH = 11$$

$$W(S3) = .2 \text{ hrs} * wt + 9 * wAK + 9 * wDC + 9 * wCC + 9 * wOF + 0 = 10$$

$$\text{where } \begin{cases} wt = 1 \\ wTH = 30 \\ wAK = wDC = wOF = wCC = .25 \end{cases}$$

$$\text{Total weight of the route: } W(R) = 10 + 11 + 1 = 31$$

Conclusion

We have now formulated the CADET's routing problem as a problem of finding the shortest path between a source and a destination in a weighted graph. We have also proposed a procedure for computing the weight for each edge in the graph, specific to the CADET problem domain. We succeeded in confining all domain-specific information to the definition of the edge weight.

There are a number of algorithms for solving the shortest-path problems. One example is the Dijkstra algorithm (Cormen, Leiserson and Rivest, "Introduction to Algorithms," the MIT Press, 1990). We expect to adapt one of such algorithms.

Appendix 26. Design Note - Calculating attrition in ground advance

Design Note:

Calculating attrition in ground advance in CADET.

This is a good example of the early design rationale. Actual implementation of the code was guided by these considerations but *may differ in details*. Consult the Javadoc Design Documentation for the most current implementation.

Author: A. Kott
Date: 5/11/98
Last updated: 5/11/98

Introduction

The purpose of this memo is to document the approach and the numerical models for computing attrition in opposed ground advance in Phase II of the CADET project.

Current initial implementation targets and Limitations of Scope

- We assume Armored/Mechanized forces
- Blue is the attacker
- The size of the Blue forces are on the order of magnitude of a Brigade.

Force Ratio Computations

Force ratio computed from the types and strength of the Bns within the Blue and Red forces, using UE values per CGSC ST 101-5.

Time Requirements

Time required to advance to objective is computed from the distance of required advance, force ratio, terrain type, and advance rates per ST 101-5.

Personnel Loss

Power ratio (Dupuy's) computed from force ratio, weather, posture and terrain factors per eq. (4) of reference [2]:

$$P = (N * s_o) * (m * u * r * h * S_u) * CEV$$

Where:

N – personnel strength of a force,
so – weapons sophistication factor,
m – mobility factor,
u – posture factor,
r – terrain factor,
h – weather factor,
Su – surprise factor,
CEV – relative military effectiveness.

Personnel loss rate is computed per eq. (1) of [2] and accounts for terrain, weather, posture, opposition and size factors. Personnel Casualty Equations (equation (1) of [2], chapter 7):

$$C = .04(N \times r_c \times h_c \times u_c \times t_z \times o_p \times S_u) \times s_o$$

where:

C = Daily casualties incurred by the force
N = Personnel strength of the force
rc = Terrain factor for casualties
hc = Weather factor for casualties
uc = Posture factor for casualties
tz = Strength-size factor
op = Opposition factor
Su = Surprise factor
so = Sophistication factor

Simplifications applied to the model above:

- weapon sophistication and mobility factor assumed to be approximated within UE value;
- surprise factor not included;
- military effectiveness factor not included
- size factor estimated from UE, not directly from personnel or armor numbers

Unlike [2], however, we pro-rate the loss rate as follows:

$$\text{Adjusted_Loss_Rate} = \text{Base_Loss_Rate} * (\text{Time_of_advance_in_hrs} / 12)$$

The above adjustment is based on the assumption that the loss rates given by eq. (1) of [2] is a daily loss rate, and that it is based primarily on historic data of WW2 when night-time operations were uncommon. We therefore assume that the daily loss rate of [2] is a loss per 12 hours of operations.

Armor Loss

Armor loss rate: computed from personnel loss rate per eq. (7) of [2]:

$$DTLa = CR \times CKT \times NT \times CEV_d \times t_z \times u_c \times S_{ui}$$

where:

DTL = Daily tank loss
a = Attacker identifier
d = Defender identifier
CR = Personnel casualty loss rate
CKT = Standard tank loss rate; (attacker ~ 6.0, defender ~ 3.0)
NT = Number of tanks
CEV_o = Opponent's relative combat effectiveness. (Usually 1.0)
tzi = Strength-size factor for tanks
Sui = Surprise attrition factor for tanks

Simplifications applied to the model above:

- surprise factor not included;
- military effectiveness factor not included
- size factor estimated from UE, not directly from personnel or armor numbers.

Overall Reduction in Force

We assume that the overall reduction in unit's strength is equivalent to the armor loss rate. This appears to be a reasonable assumption for a heavy mechanized / armored force.

Risk / Outcome

Here we use the term "risk" to denote the probability of Blue success. Based on the inspection of figure 501 of [3], we hypothesize the following relation between Power Ratio (as defined in [2] and [3]) and the likelihood of victory:

Power Ratio	Victory	Risk
> 1.3	Very Likely	Low
1.1 - 1.3	Likely	Medium
0.9 - 1.1	Doubtful	High
< 0.9	Unlikely	Very High

Another approach (not a part of the current implementation) could be suggested based on the assumptions used in the CBS system. There it is assumed that when attacker's losses reach 25%, the attack culminates. Thus, we may hypothesize the following characterization of risk based on the computed loss rate at the end of the attack:

End Loss Rate	Victory	Risk
0-5%	Very Likely	Low
5-20%	Likely	Medium
20-25%	Doubtful	High
> 25%	Unlikely	Very High

References

[1] "Command and Staff Decision Processes, Student Text 101-5" U.S. Army Command and General Staff College, Ft. Leavenworth, KS, February 1995.

[2] Trevor N. Dupuy, "Attrition: Forecasting Battle Casualties and Equipment Losses in Modern War," ISBN 0-9638692-3-X. (Note: we refer mainly to the Chapter 7 of this book.)

[3] Trevor N. Dupuy, "Numbers, Predictions and War: Revised Edition," HERO Books, Fairfax, VA, 1985, ISBN 0-915979-06-3

Appendix 27. Knowledge Base Specification for Generic Advance Activity

This is a good example of the early design rationale. Actual implementation of the code was guided by these considerations but *may differ in details*. Consult the Javadoc Design Documentation for the most current implementation.

All times are in hours.

Parent activity: Passage of Lines, Seize, Destroy, others ...

This expansion is meant to form a part of the expansion of any activity that requires a unit to advance from one position to another.

Expansion function for Seize Obj.

known:

the Unit - Unit to perform the seizure
the Objective - the objective to be seized

find last activity of the Unit, with (see comment *2 below)
end window before start window of this. (*1)
last Activity :=85

Find end location (point in network) of the last Activity
last Point :=85
start Point : last Point //now we know the starting point of the
advance

find the point that lies within the Objective that is farthest from the
start Point (*5)
end Point :=85

find earliest overall start time for all child activities; it is the
earliest end time of the last activity
overall Early time :=85

find the latest overall end time; it is the latest end time of this:
overall Late Time :=85

find route from start Point to end Point, given the route selection
criteria (static attributes of
activity?) and overall time window: (*3)
route :=85.

present route to the user (*4); the user can either approve the route
(click "OK"), or change selection criteria weights and click "Reselect".
If OK, continue, else repeat route selection.

create empty list Of New Activities. for each segment of the route,
create new activities as follows. (*6) =

1. If the segment has a friendly unit, and the next segment (*10) has enemy unit(s), create Passage Of Lines activity and append to list of New Activities. =

If the next segment does not have enemy, create and add Tactical March.

2. If the segment has enemy unit(s), then if total size of enemy unit(s) is less than this. allowed to Bypass, then create and add Bypass; else create and add Attack, with intent : destroy, initial location : segment.startPoint, final (*8) location : segment.endPoint
=

3. If the segment is empty, then if the next segment has enemy then create and add Unopposed Advance else create and add Tactical March
=

4. If the end of segment has a line, create and add CrossLine.

5. Estimate if the unit needs Rearm/Refuel at the end of this segment (*7), and add if required.

Add temporal constraints as follows:

1. the first in the list Of New Activities must be after (anytime) the last Activity
2. each activity must be anytime after an activity preceding in the list.
3. the 1st activity in the list must be anytime before this.

Create and add Secure Obj activity, immediately after this.

Comments:

- (*1) it may not have been scheduled yet
- (*2) last activity that consumes more than 20% (?) of unit's capacity
- (*3) in a mobile battlefield, selection of route can depend on time when it is expected to be traversed; assume that exists a function that selects a route given the start/end points and times
- (*4) probably not for Phase 2.
- (*5) Assume exists a function that returns all points within a given objective. (or any Area)
- (*6) Simplifying assumption (or it can be construed as a requirement on how the network is constructed):
 - a segment can be associated with either
 - 1. 0-1 friendly unit

2. 0-N enemy units

an end or start point of a segment can be associated with a Line (LD or PL)

(*7) Assume exists function that does simple estimate if the unit needs rearming or refueling based on when was last Rearm/Refuel and how many miles/hours passed since then.

(*8) If the enemy unit is the same that was already attacked in the preceding segment, do not create a new attack, but rather extend the preceding attack.

(*9) ignore

(*10) location of Passage Of Lines is the end Point of the segment (that's where the friendly unit faces the enemy).

This case:

seize objective, after arbitrary long
advance advance from initial position;
may involve multiple instances of:
Attack to destroy, Bypass, Pass of Lines,
Reduce Obstacles , Rearm/Refuel,
Cross Line X =

Cross LD
Secure

-Assume "Cross LD" is not pre-specified.

-Assume start of planning horizon is given-
restricts earliest time for any activity

- Important related cases:

- Destroy Enemy X in given objective;
- Destroy Enemy X wherever (intercept)

Supporting activities:

Route recon
Conduct Rehearsal
Improve Mobility on Route
Colocate Command Posts
Position arty
Sustain. Ops
Supp. Sustain. Ops
Uncoil
Move to PP
Suppressive fire
Lift and shift fires
ADA change phase
Being passed

Main CP displace fwd
Artillery displace fwd
Passing unit assumes main effort
Passed unit assumes new mission

Parent activity:

Bde-to-Bde Passage of Lines

Name: "Bde-to-Bde Passage of Lines"
Inst. of Class: POL
BOS: Main Effort, if activity was specified in guidance
Start window: [0, any]
End window: [any, 10]
Min duration: 3
Max duration: 12
Expansion rule: see below POLExpandRule
temporal constraints: none
resource consumption requirements:
 1. entire Bde for full duration
Allocate before expand: true (supporting activities' resource
 candidates depend on unit and route chosen)
Special attributes:
 1. passingUnit = theDoer = assigned Unit
 2. passedUnit

Notes:

What is the minimum time required to perform this activity?: unit size dependent. Assume 100 meter interval maximum and speed of 40 km/hr. Could be faster or smaller interval when necessary.
Example: 80 vehicles x 100 meters = column length of 8,000 meters.
At 40 km/hr, it takes 12 minutes to clear 80 vehicles through one passage point. If you assign 2 passage points, divide the time in half. Doctrine recommends a minimum of 2 passage points per battalion. 3 is better. Planners calculating this tend to high-side the number of vehicles by including every vehicle in a unit (only the combat vehicles are relative. The CSS units will follow in the trains). Planners also tend to be overly optimistic concerning vehicle interval and speed. It is possible to bunch up a unit and spurt through, but the trade-off is clustering on the road leading to the PP, not recommended. In practice at NTC, units tend to bog down on the route and then race through the PP.

POLExpandRule:

Generate additional activities as follows:

Route recon

Name: "Route recon"
Inst. Of Class: RouteRecon
BOS: M/C/S

Resource need: Negligible. If did model:

1. Unit candidates: 0.02 parent.passingUnit; 0.06 Div Eng Bn; 0.25 Div Eng Co; 0.02 any other resource of type "ground maneuver" and size "BDE"

2. Route candidates: "move to PP".route

Start window: [any, any]

End window: [any, any]

Min duration: 0.5: should be length of rte @ 40 km/hr

Max duration: 24

Temporal constraints:

1. ends 12 to 0 hrs before start of move to PP

Resource consumption requirements: Negligible. If did model:

1. unit for full duration
2. route for full duration

Notes:

why do we need this activity: to verify route supports movement
(this is not the activity of sending the leaders down the route;
instead it's testing bridges' capacity, etc.)

when NOT to add this activity: if time does not permit

if this activity is not performed, how much riskier will be the
parent activity: extremely risky

which BOS does it belong to: M/C/S

should it be displayed on syn-mtrx?: yes or no? yes

when should it start relative to the parent activity?: ? 1 hour
after 3.1.1 begins

when should it end relative to the parent activity?: ? before 3.2 starts

what is the minimum time required to perform this activity?:
distance based. Distance from current location to LD and return
at 20 km/hr average.

in what location should it be performed relative to the parent?: ???
route from current loc to LD

does it have to be performed exactly by the same unit that performs
the parent task?: ??? No. Could be done by engineers or MP's.

If so, add 1/2 hour for recon party to back-brief leaders before
3.2 begins.

what kind of units can perform it: ??? Maneuver unit, Engineers, MP's.

how much of these units is needed: ??? A platoon

is it reaction or counteraction to the parent?: ??? no

if this task supports the parent task, what is the support_relation: none

which enemy units will oppose this activity?: ??? rear area threat

add anything else that is important to decide about this activity?

Conduct Rehearsal

Name: "Conduct Rehearsal"

Inst. Of Class: Rehearsal

BOS: C2

Resource need:

1. Unit candidates: parent.passingUnit

Start window: [any, any]

End window: [any, any]

min duration: 0.5
max duration: 6
temporal constraints: ends 24 to 0 hrs before sibling activity
"uncoil" starts.
resource consumption requirements:
1. 0.25 Bde for full duration

Notes:

why do we need this activity: ??? Improves chances for success
when NOT to add this activity: If time doesn't permit
if this activity is not performed, how much riskier will be the
parent activity: Moderately
which BOS does it belong to: C&C
should it be displayed on syn-mtrx?: yes or no? Yes
when should it start relative to the parent activity?: ? end of 3.1.3
when should it end relative to the parent activity?: ? Before 3.2
what is the minimum time required to perform this activity?: 1 hour
in what location should it be performed relative to the parent?:
Secure area to the rear
does it have to be performed exactly by the same unit that performs
the parent task?: ??? Yes
what kind of units can perform it: ??? Maneuver units, Artillery,
Engrs, MPs
how much of these units is needed: ??? Everyone not on higher priority tasks
is it reaction or counteraction to the parent?: ??? No
if this task supports the parent task, what is the support_relation: None
which enemy units will oppose this activity?: ??? None
add anything else that is important to decide about this activity?
Could interfere with sleep plan. Could reveal locations, size.

Improve Mobility on Route

Name: "Improve Mobility on Route"

Inst. Of Class: ImproveRoute

Resource need:

1. Unit candidates: parent.passingUnit; Div Eng Co
2. Route candidates: "move to PP".route

Start window: [any, any]

End window: [any, any]

Min duration: 0

Max duration: 24

Temporal constraints: begins 0-any hrs after start of route recon;
ends 0-any hrs before start of move through pp

resource consumption requirements:

1. 0.05 Bde or 1 Eng Co for full duration
ASSIGN_INTEGRATING

Notes:

This activity is needed if the route to the passage point must be
cleared of mines, trees or other debris or must be bridged, leveled or
otherwise altered.

Colocate command posts

Name: "Colocate command posts"

Inst. Of Class: Move

BOS: C2

Resource need:

1. Unit candidates: parent.passingUnit HQ Co
2. Route candidates: "move to PP".route (not used)

Start window: [any, any]

End window: [any, any]

Min duration: 0.5

Max duration: 2.0

Temporal constraints: starts 0-24 hrs before start of Uncoil;
ends 0-any hrs before move through passage point begins.

resource consumption requirements:

1. Bde HQ Co for full duration
2. route to new area

RECOMMENDED NOT REQUIRED

Notes:

why do we need this activity: makes coordination during key parts easier

when NOT to add this activity: not recommended

if this activity is not performed, how much riskier will be the
parent activity: extremely

which BOS does it belong to: C&C

should it be displayed on syn-mtrx?: yes or no? yes

when should it start relative to the parent activity?: about 1 hour
after 3.1.2 ends?

when should it end relative to the parent activity?: an hour before
3.3 begins

what is the minimum time required to perform this activity?:

movement time from current location to passed unit CP.

in what location should it be performed relative to the parent?: ???

CP of passed unit

does it have to be performed exactly by the same unit that performs
the parent task?: ??? yes

what kind of units can perform it: ??? TAC CP of passing unit

how much of these units is needed: ??? TAC CP only

is it reaction or counteraction to the parent?: ??? no

if this task supports the parent task, what is the support_relation: no

which enemy units will oppose this activity?: ??? enemy targets CPs

add anything else that is important to decide about this activity?

comms from TAC CP to subordinate Cps may be problem due to distance.

Position arty

Name: "Position arty"

Inst. Of Class: Move

BOS: FS

Resource need:

1. Unit candidates: Div Arty Bn

Start window: [any, any]

End window: [any, any]

Min duration: 0.5

Max duration: 2.0 : if more than this, model separately

Temporal constraints: ends 0-any hrs before start of suppressive fire resource consumption requirements:

1. 1 Div Arty Bn for full duration

Notes:

why do we need this activity: Artillery is probably firing to support others before POL starts, since artillery is NEVER in reserve. They need to be moved, if not in position, to support POL.

when NOT to add this activity: If already in place.

if this activity is not performed, how much riskier will be the parent activity: extrememly

which BOS does it belong to: FS

should it be displayed on syn-mtrx?: yes or no? yes

when should it start relative to the parent activity?: ? dependent on end

when should it end relative to the parent activity?: ? before 3.2

what is the minimum time required to perform this activity?:

distance from current location to new location at 40 km/hr

in what location should it be performed relative to the parent?: ???

generally 1/3 of range back from LD and center of sector or other location suitable to cover entire LD and out to 2/3ds of range.

does it have to be performed exactly by the same unit that performs the parent task?: ??? No. Could be DS artillery bn or a

reinforcing bn. The latter is preferred if you want to keep your DS artillery uploaded and mobile to support a deep penetration.

what kind of units can perform it: ??? Artillery

how much of these units is needed: ??? one battalion per brigade minimum. 3-5 bns preferred.

is it reaction or counteraction to the parent?: ??? no

if this task supports the parent task, what is the support_relation:

DS or DS-R

which enemy units will oppose this activity?: ??? Enemy artillery

add anything else that is important to decide about this activity?

Crowding along the FEBA; time needed to reach location from previous location; amount of ammo to be conserved for future needs; ability of en arty to employ counter-battery.

Sustain. Ops

Name: "Sustain. Ops"

Inst. Of Class: SustainmentSelf

BOS: parent.BOS

Resource need:

1. Unit candidates: parent.passingUnit

Start window: [any, any]

End window - [any, any]

min duration - 1

max duration - 6

temporal constraints: ends 0 or more hrs before sibling "uncoil"

resource consumption requirements:

2. 0.5 Bde for a total of 1 unit-hour

Notes:

why do we need this activity: ensure adequate sustainment for attack

when NOT to add this activity: if unit is already at acceptable

levels to conduct ops until next available sustainment opportunity

if this activity is not performed, how much riskier will be the

parent activity: extremely

which BOS does it belong to: CSS

should it be displayed on syn-mtrx?: yes or no? Yes

when should it start relative to the parent activity?: after 3.1.1?

when should it end relative to the parent activity?: before 3.2?

what is the minimum time required to perform this activity?: 1 hour

minimum, 6 hours preferred

in what location should it be performed relative to the parent?: ???

secure area to rear

does it have to be performed exactly by the same unit that performs

the parent task?: yes

what kind of units can perform it: ??? all units

how much of these units is needed: ??? unit trains and FSB for

entire period. all others for 1/2 hour

is it reaction or counteraction to the parent?: ??? no

if this task supports the parent task, what is the support_relation: no

which enemy units will oppose this activity?: ??? no

add anything else that is important to decide about this activity?

resources must be available

Supp. Sustain. Ops

Name: "Supp. Sustain. Ops"

Inst. Of Class: SustainmentSupport

BOS: CSS

Resource need:

1. Unit candidates: Div Support Cmd

Start window: [any, any]

End window - [any, any]

Min duration - 1

Max duration - 6

temporal constraints: ends 0-any hrs before start of uncoil

"sustain. Ops"

resource consumption requirements:

1. 1 Bn-hr: ASSIGN_INTEGRATING

Uncoil

Name: "Uncoil"

Inst. of Class: Uncoil

BOS: parent.BOS

Resource need:

1. Unit candidates: parent.passingUnit

Start window: [any, any]

End window: [any, any]

Min duration: 0.25*number of Bns

Max duration: 0.5*number of Bns

temporal constraints: must end immediately before start of "move to PP" sibling

resource consumption requirements:

1. 0 Bde for full duration: here's why
start of uncoil should be scheduled to coincide with start of moveToPP. If that's so, then we can't allocate the same bde to both: one of the resource req'mt must be 0, but shouldn't we occupy the entire bde for $\max(\text{uncoil.duration}, \text{moveToPP.duration})$? No. Only occupy for moveToPP.duration , which is defined as time from first elements depart until first elements arrive (by definition of passingNewMission , which starts when 1st elements move through PP): for these first elements, uncoil duration is zero. Hence uncoil requires 0% of bde.

Notes:

why do we need this activity: essential

when NOT to add this activity: no

if this activity is not performed, how much riskier will be the parent activity: extremely

which BOS does it belong to: Manuever

should it be displayed on syn-mtrx?: yes or no? Yes

when should it start relative to the parent activity?: In time to reach LD on time

when should it end relative to the parent activity?: When last maneuver unit has left AA

what is the minimum time required to perform this activity?: 15 minutes per bn/TF under good conditions. 30 minutes under bad conditions

in what location should it be performed relative to the parent?: ???
Secure area/AA

does it have to be performed exactly by the same unit that performs the parent task?: yes

what kind of units can perform it: ??? maneuver

how much of these units is needed: ??? all

is it reaction or counteraction to the parent?: ? no

if this task supports the parent task, what is the support_relation: no

which enemy units will oppose this activity?: ??? indirect fire, if they can range and detect

add anything else that is important to decide about this activity?

speed is essential. Avoiding detection/minimizing signature are important too.

Move to PP

Name: "Move to PP"

Inst. Of Class: Move

BOS: parent.BOS

Resource need:

1. Unit candidates: parent.passingUnit
2. Route candidates: a function of parent.startArea, parent.ppArea;
assume returns ANTELOPE and DEER

Start window: [any, any]

End window: [parent.est, parent.lst]

Min duration: length("move to PP".route) @ 40 km/hr
assume value is 0.5

Max duration: 4*minDuration: if longer than 2 hrs, should be modeled
in its own right:

duration is defined here as the time elapsed from when the first
elements of the Bde start on the route until the first elements
arrive at the end of the route

temporal constraints: ends 0 hrs before start of parent

resource consumption requirements:

1. 1 Bde for full duration
2. route to passage point for full duration

Notes:

why do we need this activity: essential

when NOT to add this activity: never

if this activity is not performed, how much riskier will be the
parent activity: extremely

which BOS does it belong to: Maneuver should it be displayed on
syn-mtrx?: yes or no? yes

when should it start relative to the parent activity?: immediately
after 3.2.1 begins

when should it end relative to the parent activity?: at 3.3

what is the minimum time required to perform this activity?:

distance based. assume 40 km/hr day and 20 km/hr night

in what location should it be performed relative to the parent?:
from AA to LD

does it have to be performed exactly by the same unit that performs
the parent task?: yes

what kind of units can perform it: ??? all maneuver units and
combat trains

how much of these units is needed: ??? all

is it reaction or counteraction to the parent?: ??? no

if this task supports the parent task, what is the support_relation: no

which enemy units will oppose this activity?: ??? yes. indirect
fire, if they can range and detect

add anything else that is important to decide about this activity?
speed is very sensitive to conditions

Suppressive fire

Name: "Suppressive fire"

Inst. Of Class: ArtyFire

BOS: FS

Resource need:

1. Unit candidates: Div Arty Bn

Start window: [any, any]

End window: [any, any]

Min duration: any: set by constraint

Max duration: any

Temporal constraints: starts 0 hrs before start of "uncoil";
ends 0 hrs before start of movement through pp

Resource consumption requirements:

1. 1 Bn*number of brigades in parent for the duration of activity.

Notes:

why do we need this activity: minimizes enemy's ability to
"see" and to attack passing unit

when NOT to add this activity: if enemy is very weak or ammo is very
restricted

if this activity is not performed, how much riskier will be the
parent activity: extremely

which BOS does it belong to: FS

should it be displayed on syn-mtrx?: yes or no? yes

when should it start relative to the parent activity?: usually when
3.2.1 begins but may vary to deceive enemy

when should it end relative to the parent activity?: when 3.3 begins

what is the minimum time required to perform this activity?: 15
minutes. (table available for specific enemy effects desired).

in what location should it be performed relative to the parent?: 1/3
range from LD

does it have to be performed exactly by the same unit that performs
the parent task?: No. See Task 3.1.7

what kind of units can perform it: ??? See 3.1.7

how much of these units is needed:

is it reaction or counteract to the parent?: ??? no

if this task supports the parent task, what is the support_relation:
DS or DS-R

which enemy units will oppose this activity?: ??? en artillery

add anything else that is important to decide about this activity?

if you always follow same pattern in firing suppressive fires,
enemy will be able to predict your activity.

Lift and shift fires

Name: "Lift and shift fires"

Inst. Of Class: ArtyFire

BOS: FS

Resource need:

1. Unit candidates: Div Arty Bn

Start window: [any, any]

End window: [any, any]

min duration: 0: event only

max duration: 0

temporal constraints: begins exactly when "fire suppressive fires" ends;

resource consumption requirements:

1. 1 Bn*number of brigades in parent for the duration of activity.

Notes:

why do we need this activity: suppressive fires give way to fires
against designated targets

when NOT to add this activity: not recommended
if this activity is not performed, how much riskier will be the
parent activity: extremely
which BOS does it belong to: FS
should it be displayed on syn-mtrx?: yes or no?yes
when should it start relative to the parent activity?:
when movement masks suppressive fires
when should it end relative to the parent activity?: same time
what is the minimum time required to perform this activity?: same as parent
in what location should it be performed relative to the parent?: along LD
does it have to be performed exactly by the same unit that performs
the parent task?: yes
what kind of units can perform it: ??? Artillery and maneuver FS
how much of these units is needed: ??? all
is it reaction or counteraction to the parent?: ??? no
if this task supports the parent task, what is the support_relation: DS, DS-R
which enemy units will oppose this activity?: ??? en artillery
add anything else that is important to decide about this activity?
control measure

Set ADA weapons control

Name: "set ADA weapons control"
Inst. Of Class: AirDefense
BOS: ADA
Resource need:
1. Unit candidates: Div ADA Co
Start window: [any, any]
End window: [any, any]
min duration: 0: event only
max duration: 0
temporal constraints: start 0 hrs before start of uncoil
resource consumption requirements:
1. 1 ADA Co for full duration (not used)
Notes:
Change ADA weapons control status to weapons free if no close
air support for POL; to weapons tight if close air support. ??

Being passed

Name: "Being passed"
Inst. Of Class: BeingPassed
BOS: Supporting Effort
Resource need:
1. Unit candidates: parent.passedUnit
Start window (in hours): [any, any]
End window: [any, any]
Min duration: parent.minDuration
Max duration: parent.maxDuration
Temporal constraints: coincides with "Move thru PP"
Resource consumption requirements:

1. passed Bde for full duration

Notes:

Activity ensures unavailability of passed unit for duration of move through PP.

Main CP displace fwd

Name: "Main CP displace fwd"

Inst. Of Class: Move

BOS: C2

Resource needs:

1. Unit candidates: parent.passingUnit
2. Route candidates: "move to PP".route (not used)

Start window: [any, any]

End window - [any, any]

Min duration: 0.5

Max duration: 1.5

Temporal constraints: starts .5-1 hrs after "move through PP" begins

resource consumption requirements:

1. Bde HQ Co for full duration
2. route to new area

Notes:

why do we need this activity: to shorten comms distance and follow the attack

when NOT to add this activity: if distances are very short
if this activity is not performed, how much riskier will be the parent activity: extremely

which BOS does it belong to: C&C

should it be displayed on syn-mtrx?: yes or no? yes

when should it start relative to the parent activity?: one third of waythrough 3.3.3

when should it end relative to the parent activity?: instaneous

what is the minimum time required to perform this activity?: 1/2 hour

in what location should it be performed relative to the parent?:

from passed unit CP to mid-point (generally) of passing unit, following main attack

does it have to be performed exactly by the same unit that performs the parent task?: yes

what kind of units can perform it: ??? TAC CP

how much of these units is needed: ??? TAC CP

is it reaction or counteraction to the parent?: ??? no

if this task supports the parent task, what is the support_relation: no

which enemy units will oppose this activity?: ??? no

add anything else that is important to decide about this activity?

MAIN CP must be in place during this move

Artillery displace fwd

Name: "Artillery displace fwd"

Inst. Of Class: Move

BOS: Fire Support

Resource need:

1. Unit candidates: Bde Arty
2. Route candidates: same as for "move to PP" (not used)

Start window: [any, any]

End window: [any, any]

min duration: 0.25

max duration: 0.5

temporal constraints: starts 0-1 hrs after activity "move thru PP" starts:
schedule 15 min gap in one of the columns moving through the PP and
the Bde task force arty files into that gap

resource consumption requirements:

1. Bde Arty for full duration
2. route to new area

Notes:

why do we need this activity: to keep artillery ranging forward of
lead elements

when NOT to add this activity: if depth of attack is very small
if this activity is not performed, how much riskier will be the
parent activity: extremely

which BOS does it belong to: FS

should it be displayed on syn-mtrx?: yes or no? yes

when should it start relative to the parent activity?: about half
way thru 3.3.3

when should it end relative to the parent activity?: by end of 3.3

what is the minimum time required to perform this activity?:
distance dependent

in what location should it be performed relative to the parent?:
from current location to new location where artillery can range
forward line and about 2/3d of range forward

does it have to be performed exactly by the same unit that performs
the parent task?: DS artillery bn must do it. Reinforcing artillery
needs to do it.

what kind of units can perform it: ??? DS and reinforcing arty

how much of these units is needed: ??? bn

is it reaction or counteraction to the parent?: ??? no

if this task supports the parent task, what is the support_relation:
DS, DS-R

which enemy units will oppose this activity?: ??? enemy artillery
will target friendly artillery moves

add anything else that is important to decide about this activity? no

Passing unit assumes responsibility

Name: "Passing unit assumes responsibility"

Inst. Of Class: AssumeNewMission

BOS: parent.BOS

Resource need - Unit, candidates - parent.passingUnit

Start window (in hours): [any, any]

End window: [any, any]

min duration: 0 (min time bucket)
max duration: 0 (min time bucket)
temporal constraints: starts 0 hrs after START of movement through pp:
 passing unit is expected to begin new mission as it comes through,
 without waiting for all elements.
resource consumption requirements: None.

Passed unit assumes new mission

Name: "Passed unit assumes new mission"
Inst. Of Class: AssumeNewMission
BOS: Supporting Effort
Resource need - Unit, candidates - parent.passedUnit
Start window (in hours): [any, any]
End window: [any, any]
min duration: 0 (min time bucket)
max duration: 0 (min time bucket)
temporal constraints: starts 0 hrs after end of movement through pp
resource consumption requirements: None.

Notes:

why do we need this activity: Releases passed unit to other missions.
when NOT to add this activity: Never
if this activity is not performed, how much riskier will be the
 parent activity: no risk
which BOS does it belong to: Maneuver
should it be displayed on syn-mtrx?: yes or no? no
when should it start relative to the parent activity?: when 3.3 is
 substantially complete
when should it end relative to the parent activity?: instant
what is the minimum time required to perform this activity?: instant
in what location should it be performed relative to the parent?: along LD
does it have to be performed exactly by the same unit that performs
 the parent task?: No. Passed unit
what kind of units can perform it: ??? Passed unit
how much of these units is needed: ??? All
is it reaction or counteraction to the parent?: ??? reaction
if this task supports the parent task, what is the support_relation: no
which enemy units will oppose this activity?: ??? no
add anything else that is important to decide about this activity? if
 the passed unit is providing resources to passing unit (CSS,
 artillery, etc) those resources will not be freed up immediately
 and may limit follow-on mission.

Appendix 28. Movement to Contact Design

This is a good example of the early design rationale. Actual implementation of the code was guided by these considerations but *may differ in details*. Consult the Javadoc Design Documentation for the most current implementation.

MovementToContact class design

Class Attributes

- private Unit targetUnit;
This is the unit being targeted.
- private double maxBypass = 0.0;
This is the maximum UE that should be bypassed during the tactical march.

Class Methods

- public void init(args)
An initialization method.
- public void expand (ArrayList newActivities)
The over ride of Activity's expand method
- private int prepForMove(ArrayList newActs, RoutePoint assemPt)
This is a localization of all preparation for movement activities. assemPt is the assembly point (the place where everyone should gather before the movement to contact). The return value is the length of time that the prep has taken
This Includes:
 - Organize for combat
 - Employ engineers
 - Employ Artillery
 - Employ air defense
 - Employ communications assets
 - Employ sensors
 - Employ Advanced security force
 - Employ Advanced Guard
 - Update enemy situation
 - Reorganization, if needed
 - Rehearse
 - Route Recon.
 - Update movement plan
- private int initializeMarch(ArrayList newActs)
This is a localization of the first two steps of the MTC-TM. The return value is the time the new activities take. This includes the first and second steps of the ASF (To get its lead-off) and the first step of the AG(To get its leadoff)
- private Activity addEmployAct(unit, time, bos, newLocation)
This method adds an employ activity. NOTE: This does not set any time constraints, they must be set after the activity is created.

Method Pseudocode

```
public void init(Unit target, double bypassLevel)
{
    // initialize all class variables
    targetUnit = target;
```

```

        maxBypass = bypassLevel;
    }

    public void expand (ArrayList newActivities)
    {
        prepForMove(newActivities);
        initializeMarch(newActivities)

        create a MovementToContactTM

    }

    private int prepForMove (ArrayList newActivities, RoutePoint assemPt)
    {
        now = 0
        // org for combat.

        OrgForCombat creation tasks
            make a resource need for the unit
            make the org for combat
            set the bos (main effort, or threat action)
            set the amount needed to 0
            create the activity time with duration of zero
            set the attributes set to true

        // employ engineers
        Employ emp1 = addEmploy(engineers, now, "M/C/S", assemPt)
        make a time constraint for emp1 to start after org starts

        // employ artillery
        Employ emp2 = addEmploy(arty, now, "FIRE SUPP", assemPt)
        make a time constraint for emp2 to start after org starts

        // employ air defense
        Employ emp3 = addEmploy(air defense, now, "security???", assemPt)
        make a time constraint for emp3 to start after org starts

        // employ comm. assets
        Employ emp4 = addEmploy(communications assets, now, "C2", assemPt)
        make a time constraint for emp4 to start after org starts

        // employ sensors
        Employ emp5 = addEmploy(sensors, now, "INTEL", assemPt)
        make a time constraint for emp5 to start after org starts

        // employ ASF
        Employ emp6 = addEmploy(asf, now, "SUPP. EFFORT", assemPt)
        make a time constraint for emp6 to start after org starts

        // employ AG
        Employ emp7 = addEmploy(ag, now, "SUPP. EFFORT", assemPt)
    }

```

```
make a time constraint for emp7 to start after org starts

// update enemy sit
updateEnSit tasks
    get MI candidate unit.
    make resource need for cand. unit
    create UpdateEnemySituation act.
    set the bos ("INTEL", or "THREAT ACTION")
    set amt needed to 1.0
    create activity time with duration 1
    set time constraint

// reorg if needed
if (calcReorgNeeded(now))

    create reorg act
    set now += reorg duration

// rehearse
Rehearse tasks
    get unit candidate,
    get unit need
    set bos
    set amt needed 1.0
    make act. time for 2 hrs, to 4 hrs.
    set now += 2hrs

// route recon.
recon tasks
    get unit
    get unit need
    set bos
    set amt needed to 0.0
    make activity time, duration 0- number of time buckets.

// update movement plan
improve route tasks
    get unit
    make unit need
    make route need
    make improve route task
    set bos
    set amt needed to 0.0
    make activity time, duration 1 hr, to 5 hours.

}

private int initializeMarch(ArrayList newActs)
{
    ArrayList asfSegments = new ArrayList();
    // create a tactical march for ASF
```

```
// build the route for the ASF march ahead
for (i = 0; i < MovementToContactTM.ASF_LEADOFF; i++)
    if (i < route.size())
        asfSegments.add(route.getSegments(i);

Route asfRoute = new Route(asfSegments);

//make resource need for route

//make unit need for ASF unit

//make need array

//create ASF tactical march
TacticalMarch asfMarch = new Tactical March
    ("supporting tactical march",
    needs, asfRoute);

//set bos

// set amt needed
asfMarch.setAmountNeeded(1.0);

// get the route duration

// create a new activity time, with duration == route duration

// create a tactical march for AG

ArrayList agSegments = new ArrayList();

// build the route for the AG march ahead
for (i = 0; i < MovementToContactTM.AG_LEADOFF; i++)
    if (i < route.size())
        agSegments.add(route.getSegments(i);

Route agRoute = new Route(agSegments);

//make resource need for route

//make unit need for AG unit

//make need array

//create AG tactical march
TacticalMarch agMarch = new Tactical March
    ("supporting tactical march",
    needs, agRoute);

//set bos
```

```
// set amt needed
agMarch.setAmountNeeded(1.0);

// get the route duration

// create a new activity time, with duration == route duration

// also update the time
}

private Employ addEmployAct(Unit unit, int timeBucket, String bosName
                           RoutePoint newLocation)
{
// create the resource need for the unit
ResourceNeed unitNeed = new Resource(Unit.class, unit,
                                     "EmployUnitNeed",
                                     new AssignMethodEnum
                                     ("AssignLevel"));

// create the employ activity
Employ employ = new Employ("Employ unit for movement to contact",
                           unitNeed, unit, newLocation);

// specify the bos
employ.setBos(BattlefieldOpSys.nameToBos(bosName));

// you don't need any of the resource to do this because it's a
// milestone
employ.setAmountNeeded(0.0);
employ.setAttributesSet(true);

// create the activity time with a zero length duration.
new ActivityTime(employ, minHorizon, maxHorizon, minHorizon,
                 maxHorizon, 0, 0);

// make this activity supported by the employ.
this.SupportingActivities.add(employ);
employ.setSupportedActivities(this);

// you want to allocate the employ first
this.addAllocateBeforeActivity(employ);

// NOTE: this method does not set time constraints

return employ;
}
```

>

MovementToContactTM class design

Class Attributes

- private int offset;
This is the number of segments already covered.
- public final static int ASF_LEADOFF = 10;
This is the number of segments that the Advanced security force is ahead of the main body.
- public final static int AG_LEADOFF = 5;
This is the number of segments that the Advanced guard is ahead of the main body.
- public final static int UPDATE_AFTER = 10;
This is the number of segments to traverse before performing any movement to contact tactical march house keeping activities (i.e. re-positioning arty so that they are in range)

Class Methods

- public void expand (ArrayList newActivities)
The over ride of Activity's expand method
- private Position addReposition(Unit, time, bosName, newLocation)
This returns a new Reposition activity with the given specifications.
- private Route getNextRoute(int leadoff)
This returns a route consisting of the segments (maintained in super.getRoute) from offset to leadoff.
- private int enemyHandling(ArrayList newActivities)
This creates enemy assessment, Bypass, Hasty attack, and hasty defense. The time that these obstacles take is returned.
- private int obstacleHandling(ArrayList newActivities)
This creates any obstacle related activities, assessment, reduce, bypass, or, breached.
- private int createSupportActivities(ArrayList supportActs)
This method creates any supporting activities that must occur. (reorg, etc.) The time that these obstacles take is returned.

```
public void expand (ArrayList newActivities)
{
    int now = parent.latestStartTime;

    // do all checks first
    now = obstacleHandling(newActivities);
    now = enemyHandling(newActivities);

    // create the ASF's activity

    // get the route
    Route asfRoute = getNextRoute(ASF_LEADOFF);
    // get unit
    Unit.getCandidateUnits(...)

    // make ResourceNeeds

    // make needs array

    // create tactical march
    TacticalMarch asfTM = new TacticalMarch("Supporting Tactical March",
                                           needs, asfRoute);
}
```

```

// set all standard attributes (bos, activity time, etc.);
// create the AG's activity
// get the route
Route agRoute = getNextRoute(AG_LEADOFF);

// get unit
Unit.getCandidateUnits(...)
// make ResourceNeeds
// make needs array
// create tactical march
TacticalMarch agTM = new TacticalMarch("Supporting Tactical March",
                                       needs, agRoute);

// set all standard attributes (bos, activity time, etc.);
// create the main force's activity
// get the route
Route mainRoute = getNextRoute(0);

this.setRoute(mainRoute);
this.setDuration(...)

}

private Route getNextRoute(int leadoff)
{
    ArrayList segments = new ArrayList();
    Route route = super.getRoute();

    for (int i = 0; i < leadoff; i++)
    {
        segments.add(route.getSegments(i+offset));
    }
    return new Route(segments);
}

private int enemyHandling(ArrayList newActivities)
{
    if (we can see the enemy)
        assess enemy
        use assessment to
            a. bypass
            b. hasty defense
            c. hasty attack

    if (we found && handled the enemy)
        stop MTC.

    if (we are out of formation)
        create a tm for ASF to give them their leadoff again.
        create a tm for AG to give them their leadoff again.
}

```

```
}
private int obstacleHandling(ArrayList newActivities)
{
    if (we can see an obstacle)
        assess obstacle
        use assessment to
            a. create a bypass
            b. create a reduce
            c. create a breach

    if (we are out of formation)
        create a tm for ASF to give them their leadoff again.
        create a tm for AG to give them their leadoff again.
}
private int createSupportActivities(ArrayList supportActs)
{

    // create re-position activities.
    // re-position arty
    // re-position air defense
    // re-position comm. assets
    // re-position sensors
    // create update enemy sit. act.
    if (reorgNeeded(now))
        create reorg act.
    // create improve route activity

}
```

Appendix 29. Estimation of Battlefield Attrition in a Course of Action Analysis Decision Support System

Appendix 30. Object Diagrams, Loops and Logic

Appendix 31. Under the Hood

Appendix 22. Activity Modeling Sheet - Re-supply Operations within a Brigade.....	180
GENERAL	180
MODELING WITHIN CADET	181
Movement from the BSA to the LRP	182
Servicing the Maneuver Unit.....	182
Movement from the LRP to the BSA	182
Receiving resupply from the FSB.....	182
Figure2: Timings for Derived Activities	183
BIBLIOGRAPHY	183
Appendix 23. Activity Modeling Sheet - Emergency Evacuation of Logistics Facilities.....	184
GENERAL	184
Rules Of Thumb	184
Planning Considerations	185
MODELING IN CADET	185
BIBLIOGRAPHY	186
Appendix 24. Activity Modeling Sheet - Regeneration.....	187
GENERAL	187
MODELING IN CADET	189
Identifying the need for regeneration.....	189
Maneuver unit.....	189
Support unit	190
BIBLIOGRAPHY	190
Appendix 25. Design Note - Route Selection.....	191
Design Note:.....	191
Notes on the approach and rules for selecting a route in CADET.....	191
Section 1. Introductory Overview of Planning Movement under Maneuver.....	191
Section 2. Example.....	192
Section 3. Problem Statement.....	195
Section 4. Proposed Scope Limits, Simplifications, Priorities.....	197
The Provisional Technique for Automated Selection of Optimal Route/Avenue of Approach/Axis of Attack	198
Example.....	199
Conclusion.....	199
Appendix 26. Design Note - Calculating attrition in ground advance.....	200
Design Note:.....	200
Calculating attrition in ground advance in CADET.	200
Introduction	200
Current initial implementation targets and Limitations of Scope	200
Force Ratio Computations	200
Time Requirements.....	200
Personnel Loss.....	200
Armor Loss.....	201
Overall Reduction in Force.....	202
Risk / Outcome	202
References	202
Appendix 27. Knowledge Base Specification for Generic Advance Activity	203
Appendix 28. Movement to Contact Design	219
Appendix 29. Estimation of Battlefield Attrition in a Course of Action Analysis Decision Support System	225
Appendix 30. Object Diagrams, Loops and Logic	226
Appendix 31. Under the Hood.....	227

CADET Design

Plan Object Model

Main Loop Objects/Logic

Main Loop Expansion Logic

Selected Expansion Objects/Logic

Air Attack

Forward Passage Of Lines

Activity.Advance

Movement To Contact

Scheduling and Allocation Objects/Logic

Attrition Calculation

Route Calculation

Plan Object Model

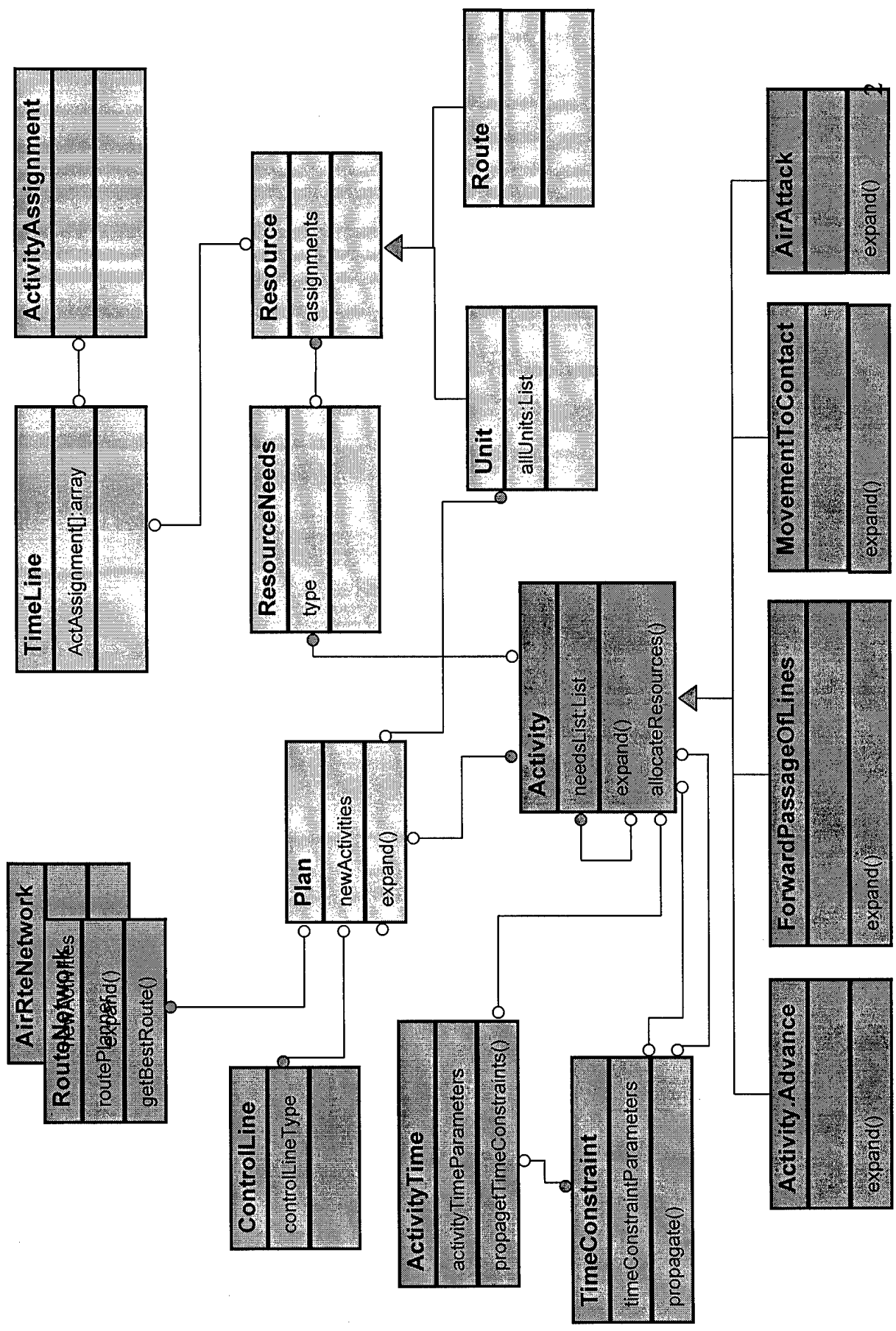

Main Loop Objects

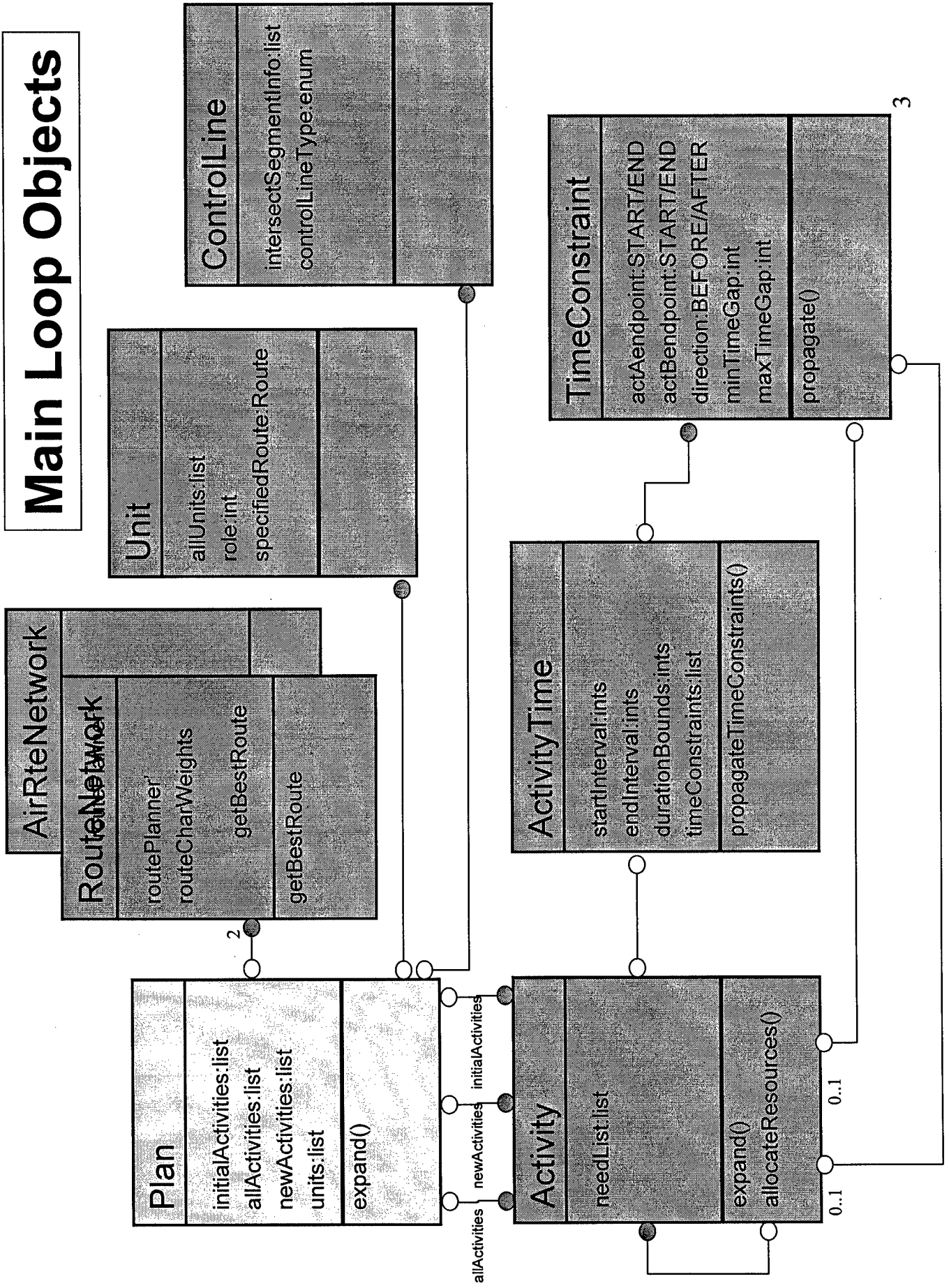

Main Loop Logic

At scenario load time:
propagateTimeConstraints(initialActs)

During expansion:
while there exist unscheduled activities
 act = sortByPriorityOfAllocation()
 if act needs expansion
 newActs = act.expand()
 propagateTimeConstraints(newActs)
 if act is ready for allocation
 act.allocateResources()
 propagateTimeConstraints(act)

Selected Expansion Objects

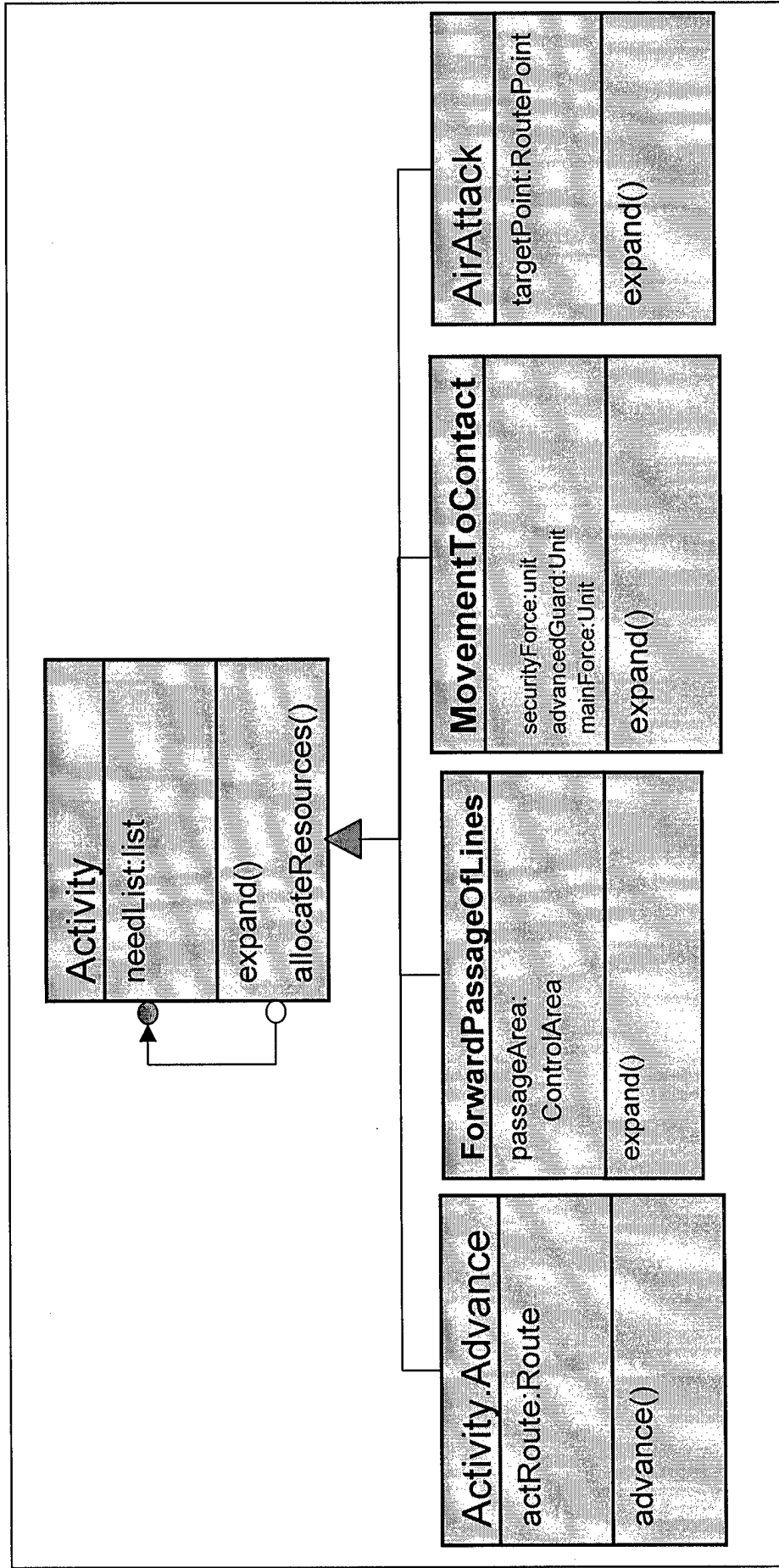

AdvanceOnAxis
 AirDefenseChangeMode
 AirMovement
 ArtyFire
 AssessDamage
 AssessEnemy
 AssessObstacle
 AssumeNewMission
 BeingPassed
 BreachObstacle
 Bypass
 BypassObstacle
 CoverArea
 CrossLine
 CrossRiver
 DeepAttack
 Defend
 DevelopSituation
 Employ
 Engage
 EvaluateOutcome
 FindEnemy

Activities

FindFlank
 FireSmoke
 HoldEnemy
 ImproveRoute
 IsolateEnemy
 MaintainContact
 ManeuverToFlank
 Move
 MovementToContact
 MovementToContactTM
 MoveThroughPP
 OpposedAdvance
 OrganizeForCombat
 ForwardPassageOfLines
 Position

Position
 Reconnaissance
 Recover
 ReduceObstacle
 Rehearsal
 ReorderTroops
 Reorganization
 Resupply
 RouteRecon
 Screen
 Seize
 SeizeMilestone
 SupportForwardUnit
 SupportPassageOfLines
 SustainmentSelf
 SustainmentSupport
 TacticalMarch
 TransitionToHastyAttack
 Uncoil
 UnopposedAdvance
 UpdateEnemySituation

Main Loop Expansion

favor activities with a singleton start and end interval
then key activities
then activities with earlier lates

After each activity allocation, Time constraint propagation can cause activities to have singleton time intervals. Therefore, we calculate the activity to be selected each time through the loop, and remove it from the list

```
Plan.expand()  
create a list of activitiesEligibleForAllocation based on the list of AllActivities  
while there are still activitiesEligibleForAllocation  
{  
    activity = .sortByPriorityOfAllocation(activitiesEligibleForAllocation);  
    if activity requires expansion  
        do not expand yet, but set a flag for later expansion  
        if activity needs to be allocated before expansion  
            activity.allocateResources()  
            activity.expand()  
        add the new activities generated by the expansion to the activity  
        lists  
        propagate TimeConstraints for each new activity and cur activity  
        if activity is not ready to be allocated  
            get the next activity on the activitiesEligibleForAllocation list  
        else  
            activity.allocateResources()  
            if allocation is successful  
                add the new activities generated by the allocation to the  
                allocation lists  
            propagate TimeConstraints on each new activity and cur activity  
            else  
                return status (FailureToAllocate) if this is an infeasibleActivity  
        return status  
        list of newlyCreatedActivities  
        list of newly AllocatedActivities  
        list of InfeasibleActivities  
}
```

Expansion: Air Attack Activity

determine the attacking unit
determine the activity starting time
find the attacking unit's starting position
get the routes from the beginning point to the target and back
calculate the amount of time needed for the air attack

```
rehearsal = new Rehearsal()  
updateTargets = new FindEnemy()  
moveToTarget = new AirMovement()
```

```
attack = new AirAttack()
```

```
recoverCrews = new RecoverAirCrews()  
assessDamage = new AssessDamage()  
moveFromTarget = new AirMovement()  
reorg = new Reorganization()  
evaluate = new EvaluateOutcome()
```

Air Attack Activity Expansion

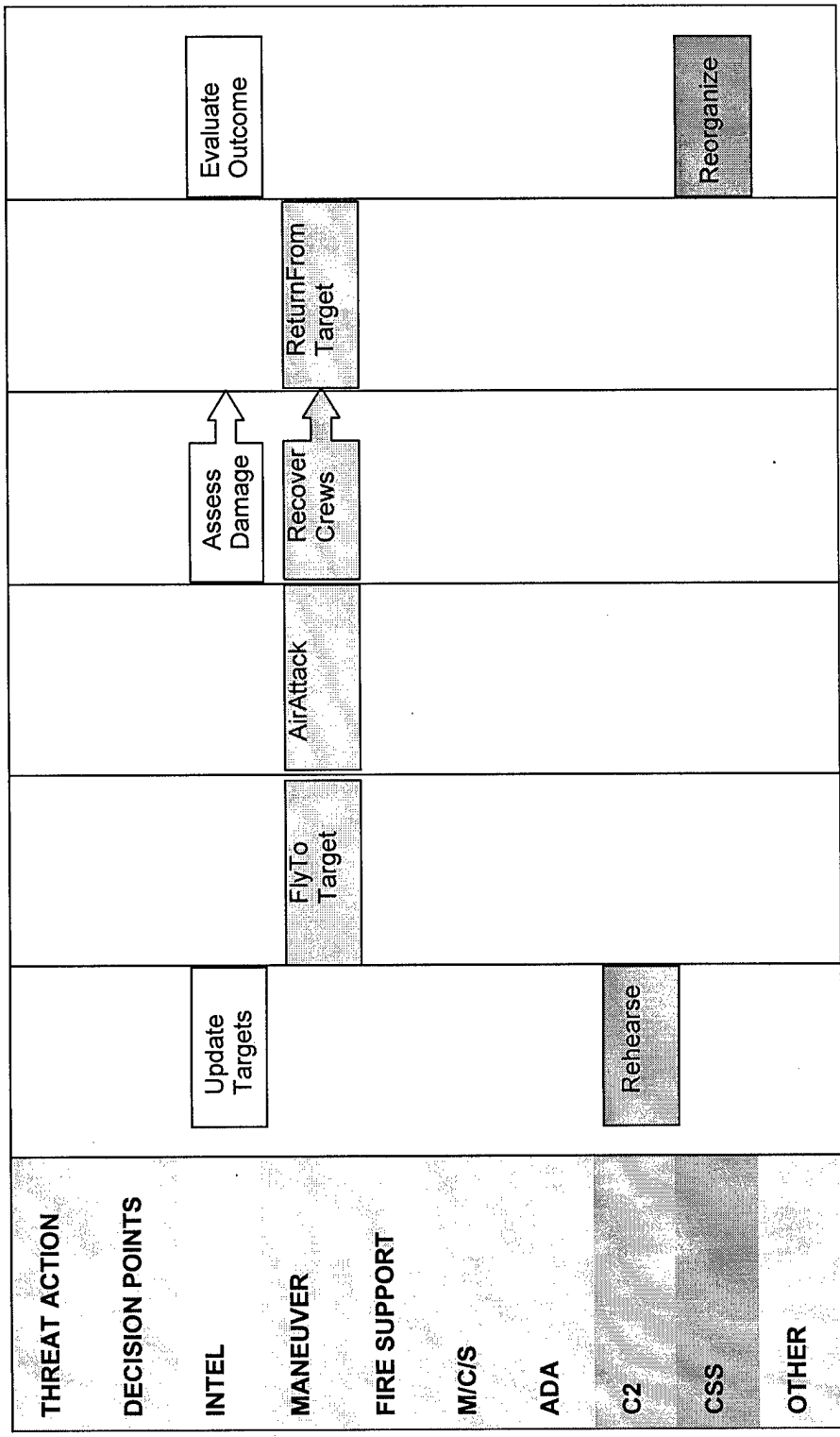

```

Activity.advance()
Given: unit to perform the advance
       route from unit's prior position to destination position

for each segment of the route, create new activities as follows:
{
  if ( the segment has a friendly unit )
  {
    if ( the next segment (*10) has enemy unit(s) )
      create Passage Of Lines activity and append to list of
      New Activities;
    else
      create and add Tactical March;
  }
  else if ( the segment has enemy unit(s) )
  {
    if ( total size of enemy unit(s) is less than this.allowedToBypass )
      create and add Bypass;
    else
      create and add Attack( intent=destroy,
                           initialLocation=segment.startPoint,
                           finalLocation = segment.endPoint (*8) );
  }
  else if ( the segment is empty )
  {
    if ( the next segment has enemy )
      create and add Unopposed Advance;
    else
      create and add Tactical March;
  }
  if ( the end of segment has a line )
  {
    create and add CrossLine;
    estimate if the unit needs Rearm/Refuel at the end of this segment
    (*7); add if required;
  }

// If we added any activities, insert time constraints between these
// activities to ensure they're scheduled consecutively. Do not set
// a maximum time between activities: allow a unit to pause during an
// advance.
for each activity A[i] in the sequence of activities generated above
  create TimeConstraint( A[i], END, BEFORE, 0, any, A[i+1], START );

```

Advance:

Advance.Activity

Notes:

- (*7) Assume exists function that does simple estimate if the unit needs rearming or refueling based on when was last Rearm/Refuel and how many miles/hours passed since then.
- (*8) If the enemy unit is the same that was already attacked in the preceding segment, do not create a new attack, but rather extend the preceding attack.
- (*10) location of Passage Of Lines is the end Point of the segment (that's where the friendly unit faces the enemy).

Activity.Advance

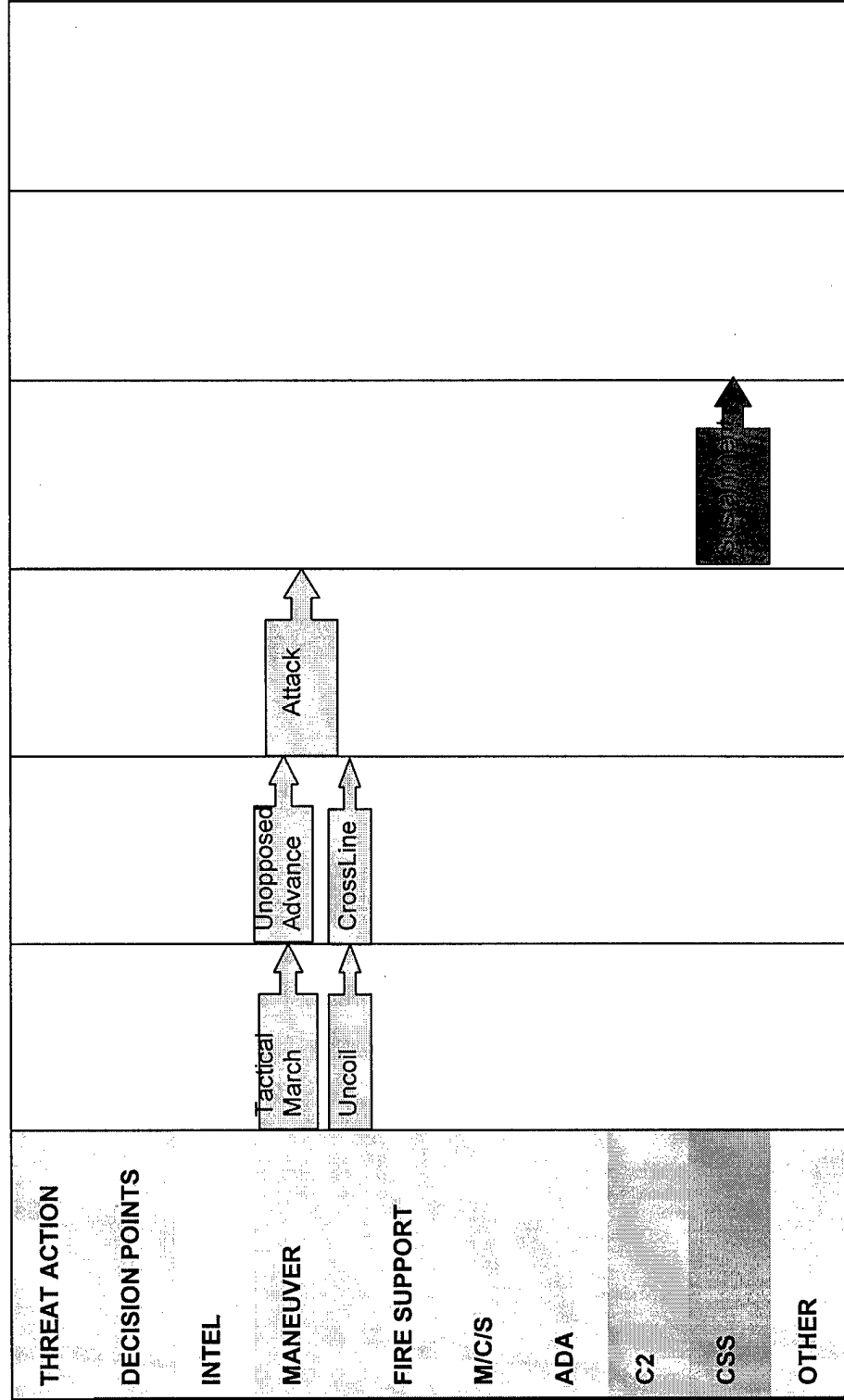

Expansion:

Forward Passage Of Lines Activity

ForwardPassageOfLines.expand()

get the route network
if the passing unit is not already on the march
 get a new route
 advance() //move unit to the passage point
 routeRecon = new RouteRecon
 improveRoute = new ImproveRoute

➔ rehearsalPoL = new Rehearsal
if the size of the passed unit >= regiment
➔ collocateCmdPosts = new Move()
➔ positionArty = new Move()

sustainOps = new SustainmentSelf()
supportSustainOps = new SustainmentSupport()
➔ suppressiveFire = new ArtyFire()
➔ liftShiftFire = new ArtyFire()
➔ airDefenseChangeMode = new AirDefenseChangeMode()
➔ beingPassed = new BeingPassed()
if size of passed unit >= regiment
➔ mainCmdPostDisplaceFwd = new Move()
➔ artyDisplaceFwd = new Move()
➔ passingNewMission = new AssumeNewMission()
➔ passedNewMission = new AssumeNewMission()
if this is a blue ACTION
if enemy artillery unit is available
➔ enArtyFire = new DirectSupportArtyFire()
create the time constraints on these activities

Forward PassageOfLines Activity Expansion

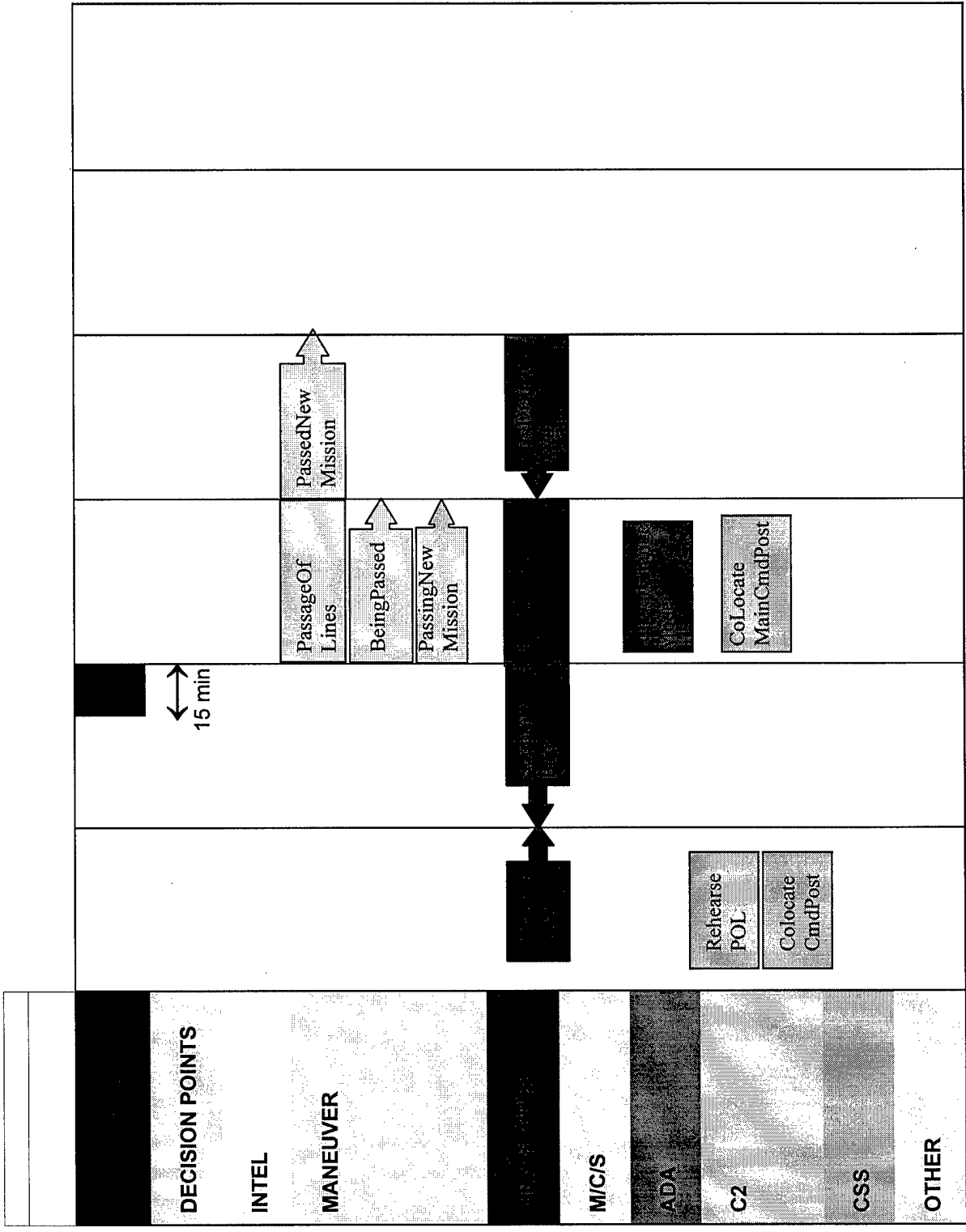

Expansion: Movement to Contact Activity

```
MovementToContact.expand()
{
  if (this route == null) get this route.
  prepForMove()
  setLeadoffForces()
  create a MovementToContactTM
  if (the advanced sf has a leadoff march)
  {
    TimeConstraint.create(this, start, after, 0, any, the advanced sf leadoff march, ends)
    TimeConstraint.create(this, start, after, 0, any, the advanced guard leadoff march, ends)
  }
  else
  {
    // this is the rehearsal
    TimeConstraint.create(this, start, after, 0, any, the last part of the initialization, ends)
  }
  TimeConstraint.create(movementToContactTM, start, after, 0, 0, this, starts)
}

prepForMove()
{
  create an organize for combat activity
  employ(theDoer, ArtyBtryA, ArtyBtryB, ADABnA, ADABnB, engineers, advSF,
  advGuard, CommTeamA, CommTeamB, SensorsA, SensorsB)

  create a recon activity
  create an update enemy situation activity
  create an improve route activity
  if (advSF needs sustainment)
  create a sustainment(advSF)
  if (advGuard needs sustainment)
  create a sustainment(advGuard)
  if (theDoer needs sustainment)
  create a sustainment(theDoer)

  create a rehearse activity

  // create all time constraints
  TimeConstraint.create(all employments, start, after, 0, 0, org for combat, start)
  // create reconnaissance, improve route, and rehearse constraints
  TimeConstraint.create(reconnaissance, start, after, 0, 0, improve route, start)
  TimeConstraint.create(reconnaissance, end, after, 0, 0, rehearse, end)

  if (doer has a reorganization)
  TimeConstraint.create( doers reorg, start, before, 0, any, rehearse, start)
  if (advanced security force has a reorganization)
  TimeConstraint.create( adv security reorg, start, before, 0, any, rehearse, start)
  if (advanced guard has a reorganization)
  TimeConstraint.create( adv guard reorg, start, before, 0, any, rehearse, start)
}
}
```

Expansion: Movement to Contact (SetLeadoffForces)

```
setLeadoffForces()
{
    scan the route until we encounter a target enemy unit, or an obstacle,
    or we have reached teh length that the adv security force must travel
    {
        if (enemy is encountered)
        {
            create an enemy assessment activity
            if (the assessment recommends any action other than none )
            {
                get the occupying units
                stop the advanced security force march
            }
        }
    }
    if (an obstacle was found)      handleObstacle()
    if (advanced security force has segments to travel)
    {
        create an advance (Advanced security force)
        if (there is an assess enemy activity)
            TimeConstraint.create(assess, start, after, 0, any, adv sec advance, ends)
        TimeConstraint.create(adv sec advance, start, after, 0, any, the last act
            created, ends)
    }

    build the advanced guards route based on the distance traveled
    by the advanced security

    if (advanced guard has segments to travel)
    {
        create an advance (advanced guard)
        if (advanced security has to do an advance)
            TimeConstraint.create(adv guard advance, start, after, 0, any, adv sf
                advance,ends)
        else
            TimeConstraint.create(advanced guard advance, start, after,
                0, any, last activity created, ends)
    }
    if (we did not find an enemy requiring a coordinated attack)
    {
        if (leapfrog is necessary)
            update the locations of the both support teams, and switch moving team
    }
    else
        makeAttack()
    return the calaculated time
}
```

Expansion: Movement to Contact TacticalMarch

```
MovementToContactTM.expand()  
{  
  while (adv SF route distance < support interval distance) AND (enemy not found)  
    AND (obstacle not found)  
  {  
    look for an obstacle and the enemy on the next segment  
    if (an enemy was found AND no obstacle found)  
    {  
      create an assess enemy activity  
      if (assessment result != NONE) stop looping  
    }  
  }  
  get the advanced guard and main force routes  
  if (an obstacle was found)  
  {  
    super.handleObstacle()  
    create a MovementToContactTM  
    TimeConstraint.create(mtctm, start, after, 0, any, last adv security march, end)  
    TimeConstraint.create(mtctm, start, after, 0, any, last adv guard march, end)  
    cleanup expand and return  
  }  
  if (enemy was found)  
  {  
    super.makeAttack()  
    if (assess enemy != null)  
      TimeConstraint.create(assess, start, after, 0, 0, this, start)  
  }  
  create a movement to contact tactical march  
  TimeConstraint.create(mtctm, start, after, 0, any, last asf march, end)  
  TimeConstraint.create(assess, start, after, 0, any, last advguard march, end)  
  cleanup expand and return  
}  
  
if (asf has a route)  
{  
  create an asf advance and update projected consumables  
  if (assessEnemy != null)  
    TimeConstraint.create(assess, start, after, 0, 0, asf advance, end)  
}  
  
if (adv guard has a route)  
{  
  create an advance guard advance  
  update projected consumables  
}  
  
if (main force has a route)  
{  
  create a main force advance  
  update projected consumables  
}  
else cleanup expansion and return
```

Time Constraints:

Movement to Contact

TacticalMarch

```
if (asfAdvance != null)
    TimeConstraint.create(this, start, before, 0, any, asf advance, start)
if (agAdvance != null)
    TimeConstraint.create(this, start, before, 0, any, advGuard advance, start)
if (mainForceAdvance != null)
    TimeConstraint.create(this, start, before, 0, any, main force advance, start)

update the projected time
create a movement to contact tactical march

if (agAdvance != null)
    super.createSupportActivities(constrainAct = agAdvance)
else
    super.createSupportActivities(constrainAct = main force Advance)

if (an enemy was found)
    update support team information and call super.makeAttack()
if (an enemy was found)
{
    if (last asf march != null)
        TimeConstraint.create(mtctm, start, after, 0, any, last asf march, end)
    if (last adv guard march != null)
        TimeConstraint.create(mtctm, start, after, 0, any, last adv guard march, end)
}

if (no enemy was found)AND(an adv guard advance was created)
{
    update support team information
    TimeConstraint.create(mtctm, start, after, 0, any, adv guard advance, end)
}

if (adv security advance != null)
    TimeConstraint.create(mtctm, start, after, 0, any, adv sec advance, end)
if (main force advance != null)
    TimeConstraint.create(mtctm, start, after, 0, any, main force advance, end)
}
```

Movement To Contact Activity Expansion (Overview)

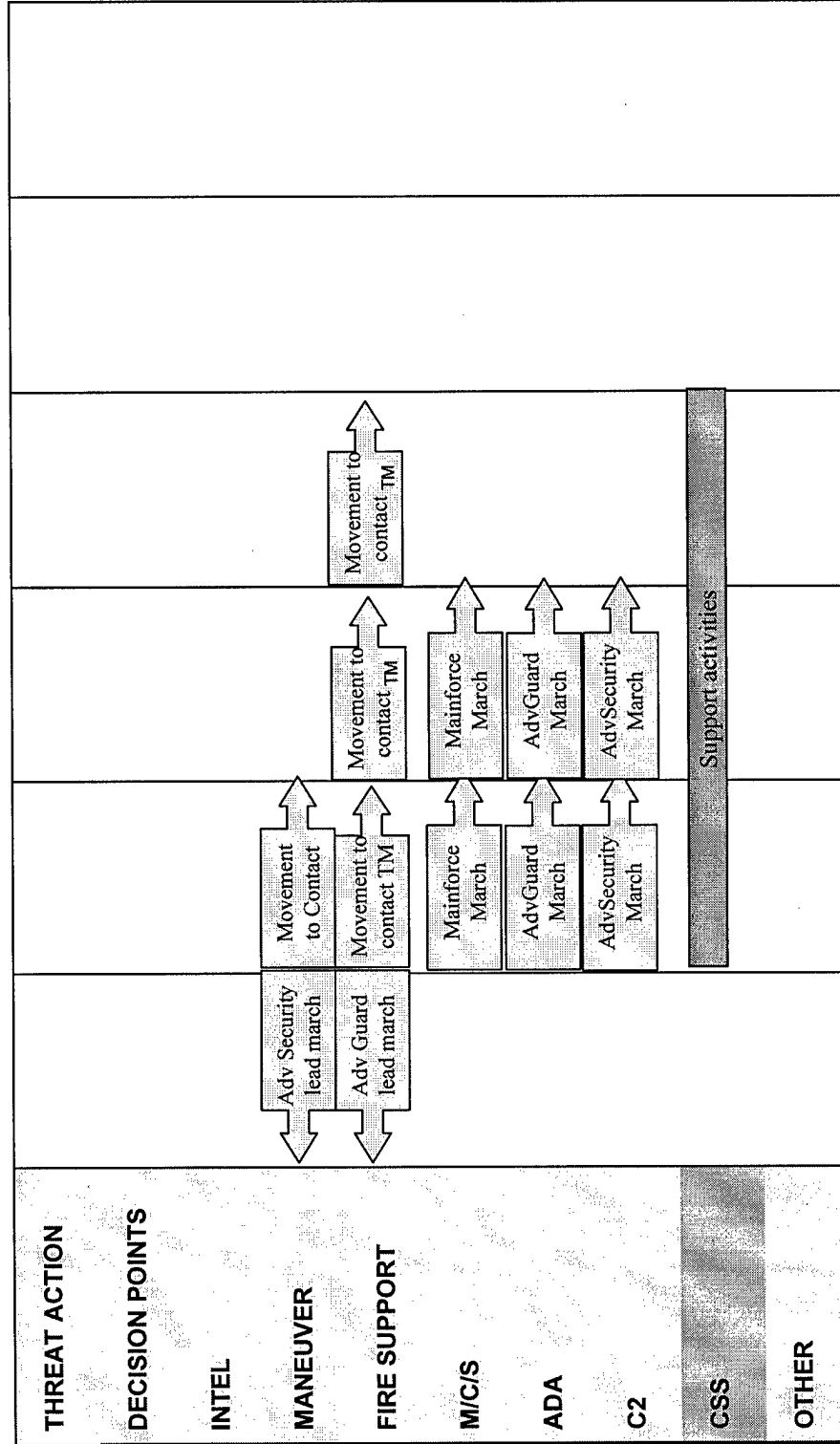

Movement To Contact Activity Expansion (Preparation)

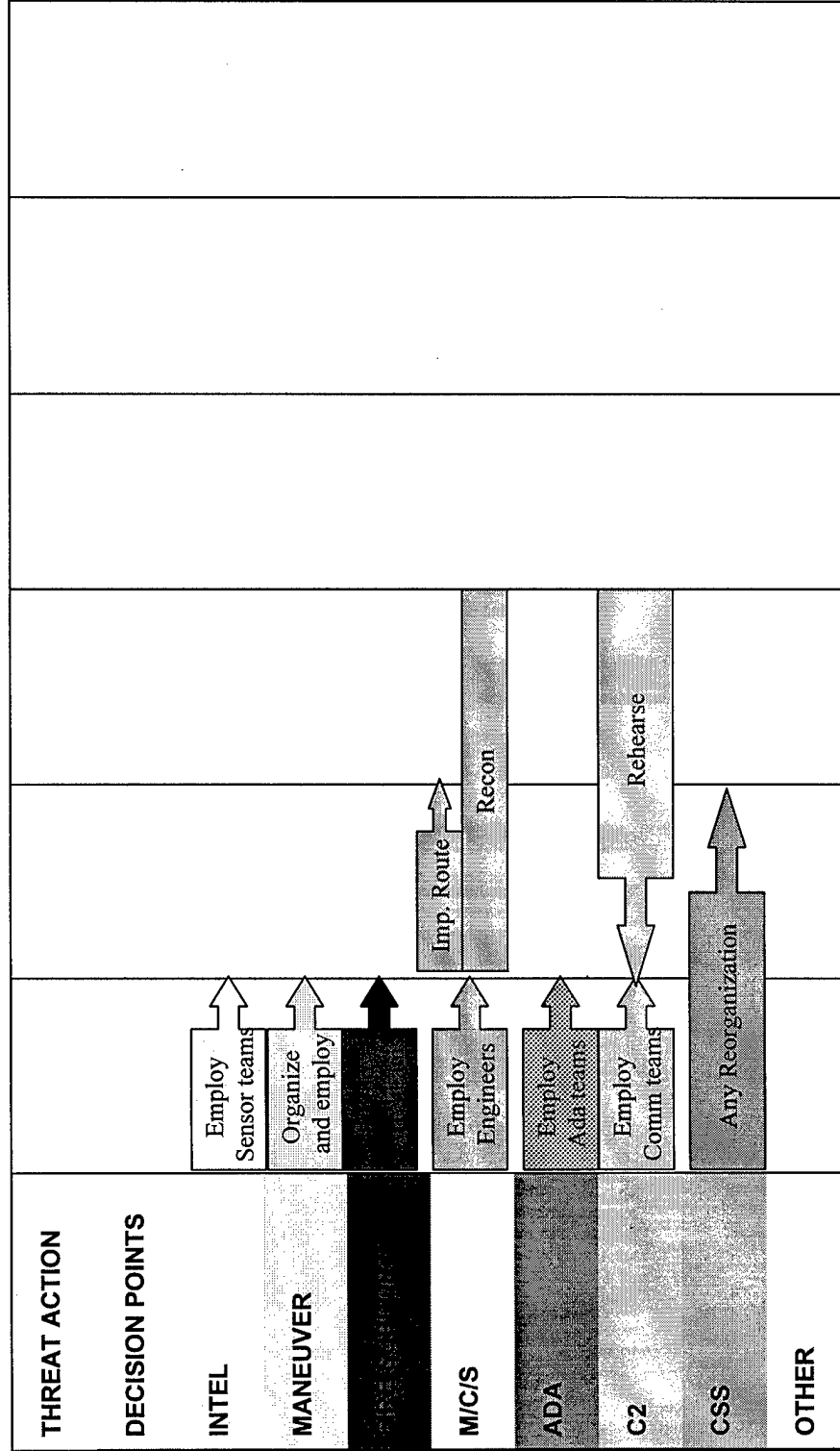

Movement To Contact Activity Expansion (Support)

THREAT ACTION					
DECISION POINTS					
INTEL	Reposition Sensor Team A Sensor Team B provide coverage Update enemy situation	Reposition Sensor Team B Sensor Team A provide coverage Update enemy situation			
MANEUVER	Adv Guard March	Adv Guard March			
FIRE SUPPORT					
M/C/S	Reposition Engineers Improve Route Reconnaissance	Reposition Engineers Improve Route Reconnaissance			
ADA	Reposition ADA Team B ADA Team A provide coverage	Reposition ADA Team A ADA Team B provide coverage			
C2	Comm Team A provide coverage Reposition Comm Team B	Comm Team B provide coverage Reposition Comm Team A			
CSS					
OTHER					

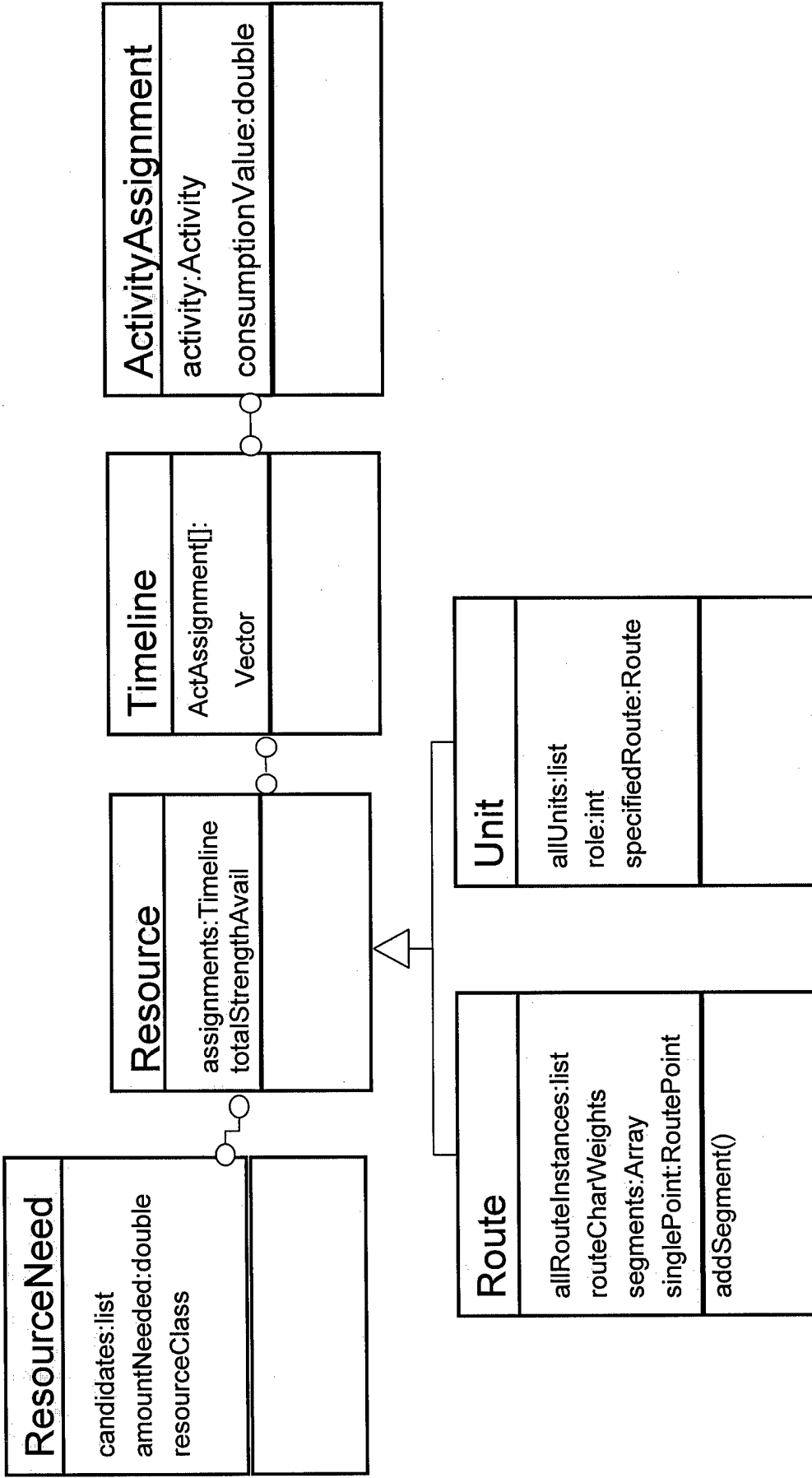

Allocation and Scheduling Objects

Allocation and Scheduling Logic

```
Plan.sortByPriorityOfAllocation()

// make a list of all Plan activities that need resource/time allocation
// return ActivityList Activities sorted by order of allocation

keyList = new ActivityList()
nonkeyList = new ActivityList()

foreach activity in this.AllActivities
{
    // skip if either already allocated or it is an aggregate activity
    if (activity.Allocated OR !activity.AtomicFlag)
        continue

    // sort key activities separately, ahead of all nonkey ones
    if (activity.isKey)
        add activity to keyList
    else
        add activity to nonKeyList
}

// pick based on simplest "earliest first" heuristic, plus the key heuristic
sort keyList by Activity.ActivityTime.getLatestEndTime() ascending
sort nonKeyList by Activity.ActivityTime.getLatestEndTime() ascending
return concatenate( keyList, nonKeyList );
```

create keyActivityList of all Activities with key == true;
if keyActivityList is empty
pick the activity with the lowest value of the latest end time;
else
pick the activity from keyActivityList that has lowest value of latest end time (i.e., activity.ActivityTime.getLatestEndTime)
return that activity;

OutcomeCalculators: Modeling Attrition

Typical Description of a Case

Blue Task Force: Conducting a hasty attack using an envelopment with 3 Maneuver Battalions consisting of the following maneuver and field artillery equipment.

- 1) 54-M1A2s
- 2) 108-M2A2s
- 3) 18-M155mm (DS) FA BN
- 4) 18-M155mm (R) FA BN

Red Force: Conducting a hasty defense with 1 Battalion; frontage for defense is 1.5kms.

- 1) 10-T-80s
- 2) 30-BMP-3s
- 3) 18-122mm SP Howitzers
- 4) 6-BM21s MRLs

Force Ratio: 3 to 1 (Blue)

Avenues of approach: rolling foothills; good trafficability; ability to maintain attack formation and dispersal.

Cover: adequate

Concealment: limited

Observation: direct fire engagement will occur at 1800 meters or less

Natural obstacles: none

Man-made obstacles: 24 hours of obstacle belt and survivability preparation

Conditions: light rain/daylight attack

Distance: LD to objective for the blue task force is 10 kms

Dupuy Outcome Calculator

- Note: our presentation omits surprise, sophistication, relative quality factors;
- Basic form:
 - Attrition = f(Terrain, Weather, Posture, Size, Force Ratio, Relative Quality)
- Personnel Ca = $.037 * T_c * W_c * P_{ca} * S_{ca} * [(F_d * T_{pd} * P_{pd}) / (F_a * W_{pa})]^{**}.42$
- Personnel Cd = $.037 * T_c * W_c * P_{cd} * S_{cd} * [(F_a * W_{pa}) / (F_d * T_{pd} * P_{pd})]^{**}.42$
- Armor Aa = $6 * C_a$
- Armor Ad = $3 * C_d$

Where:

T _c = Terrain Condition	W _c = Weather Condition
P _{ca} = Posture of Attacker	P _{cd} = Posture of Defender
S _{ca} = Size of Attacker	S _{cd} = Size of Defender
F _a = Attack Force	F _d = Defense Force
C _a = Attacker Personnel Attrition Rate	C _d = Defense Personnel Attrition Rate

Force Ratio = Size of Attacker/Size of Defense
 $(F_d * T_{pd} * P_{pd}) / (F_a * W_{pa})$ = Power Ratio = force ratio / (defense posture * (1/terrain factor) * terrain factor)
 $(F_a * W_{pa}) / (F_d * T_{pd} * P_{pd})$ = 1/Power Ratio = 1 / (force ratio / (defense posture * (1/terrain factor) * terrain factor))

KLG Outcome Calculator

Attacker Personnel Attrition Rate:

$$Ca = K * Pa * [(Fd * T * Pp) / Fa]^{**} .41$$

Defender Personnel Attrition Rate:

$$Cd = K * Pd * [(Fd * T * Pp) / Fa]^{**} (-.41)$$

Armored Vehicles Attrition Rate:

$$T \sim 1.0 * C$$

K	0.42
Pa(withdraw)	0.5
Pa(hasty)	0.75
Pa(fortif)	0.87
Pd(withdraw)	0.91
Pd(hasty)	1.03
Pd(fortif)	0.97
I(desert)	1.39
I(hills)	1.52
I(rugged)	2.71
Pp(withdraw)	1.15
Pp(hasty)	1.3
Pp(fortif)	2.2

Dupuy

Compute force ratio, attrition, etc., set as attributes of this attack.

```
redForceTotal = calculateForceTotal( false );
blueForceTotal = calculateForceTotal( true );
forceRatio = blueForceTotal / redForceTotal;

powerRatio = forceRatio / ( defensePostureFactor * // table K
    ( 1 / weatherFactor ) * // table J
    terrainFactor ); // table I
risk = powerRatio level in
    OutcomeCalculator.LIKELIHOOD_OF_FAILURE_STATUS_THRESHOLDS;

rateOfAdvance = getRateAdvance( terrain, defensePosture, forceRatio );
duration = advance / rateOfAdvance;

// Personnel and weapons system losses for attacker and defender.
//
persLossAttk = getPostureFactor3( defensePosture ) * // table K
    getWeatherFactor2( weatherType ) * // table J
    getTerrainFactor2( terrainType ) * // table I
    getOppFactor( powerRatio ) * // table M
    getSizeFactor( blueForceTotal ) * // table L
    0.04;
armorLossAttk = persLossAttk * 6;

persLossDef = getPostureFactor3( defensePosture ) * // table K
    getWeatherFactor2( weatherType ) * // table J
    getTerrainFactor2( terrainType ) * // table I
    getOppFactor( 1 / powerRatio ) * // table M
    getSizeFactor( redForceTotal ) * // table L
    0.04;
armorLossDef = persLossDef * 3;
```

Sets:

```
redForceTotal
blueForceTotal
forceRatio
powerRatio
risk
duration
persLossAttk
armorLossAttk
persLossDef
armorLossDef
redEndForce
blueEndForce
endForceRatio
```

KLG

Compute force ratio, attrition, etc., set as attributes of this attack.

```
redForceTotal = calculateForceTotal( false );
blueForceTotal = calculateForceTotal( true );
forceRatio = blueForceTotal / redForceTotal;

powerRatio = forceRatio / ( defensePostureFactor * // table K
    terrainFactor ); // table I
risk = powerRatio level in
    OutcomeCalculator.LIKELIHOOD_OF_FAILURE_STATUS_THRESHOLDS;

rateOfAdvance = getRateAdvance( terrain, defensePosture, forceRatio );
duration = advance / rateOfAdvance;

// Personnel and weapons system losses for attacker and defender.
//
persLossAttk = getPostureFactor2( defensePosture ) * // table K
    powerRatio ** 0.41 *
    0.42;
armorLossAttk = persLossAttk * 1.3;

persLossDef = getPostureFactor3( defensePosture ) * // table K
    powerRatio ** 0.41 *
    0.42;
armorLossDef = persLossDef * 1.3;
```

Sets:

```
redForceTotal
blueForceTotal
forceRatio
powerRatio
risk
duration
persLossAttk
armorLossAttk
persLossDef
armorLossDef
redEndForce
blueEndForce
endForceRatio
```

Route Calculation Objects

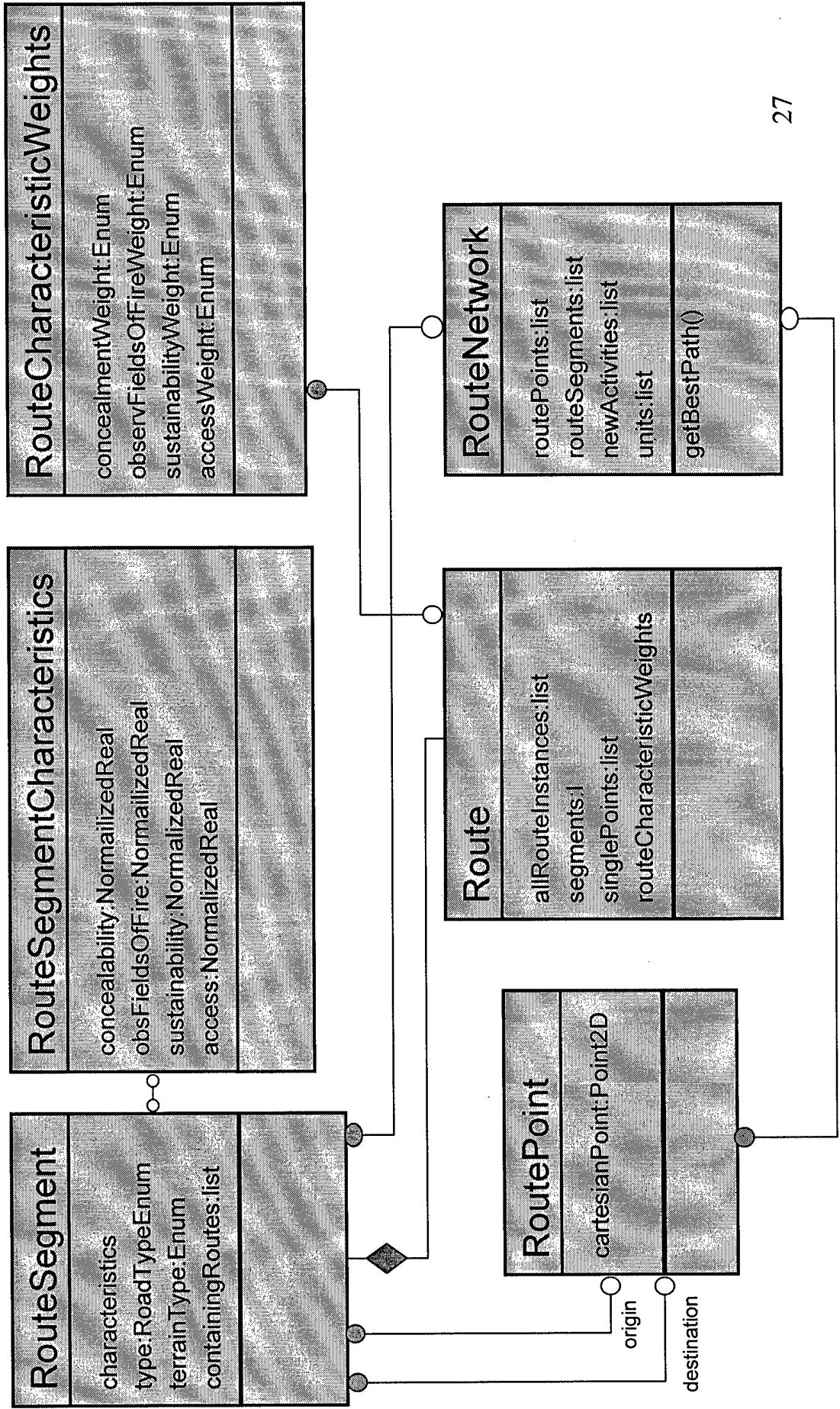

Route Calculation Logic

```

for each segment in the route network
  calculate the segment badness
  given origin A and destination B
  create the least bad path using Dijkstra's Algorithm
  {
    new Route r;
    r.segments = RouteNetwork.getShortestPath(
      A, B, startTime, unit )
  }
return r;

```

Dijkstra's Algorithm:

Find the single source shortest path for a weighted, directed Route network where:

S = set of Route Points whose shortest path distance from the origin has been determined

Q = priority queue containing all vertices in V - S

keyed by d values (segment.badness values)

V = set of all Route Points (vertices)

E = set of all Route Segments (edges)

u = vertex with minimum shortest path

w = weight (segment.badness)

create an initialized priority queue Q where each vertex is represented as <name><distance><predecessor>

(INITIALIZE-SINGLE-SOURCE)

while Q is not empty

get the vertex u with the minimum shortest-path estimate (EXTRACT-MIN)

insert u into S

for each vertex v that is adjacent to u

if v provides a shorter path to u

update the shortest-path estimate and

update the predecessor of u (RELAX)

segment.badness =

$$\left(\sum_{\text{for each segment characteristic}} \text{segment characteristic value} * \text{segment characteristic weight} \right) * \text{segment length in km}$$

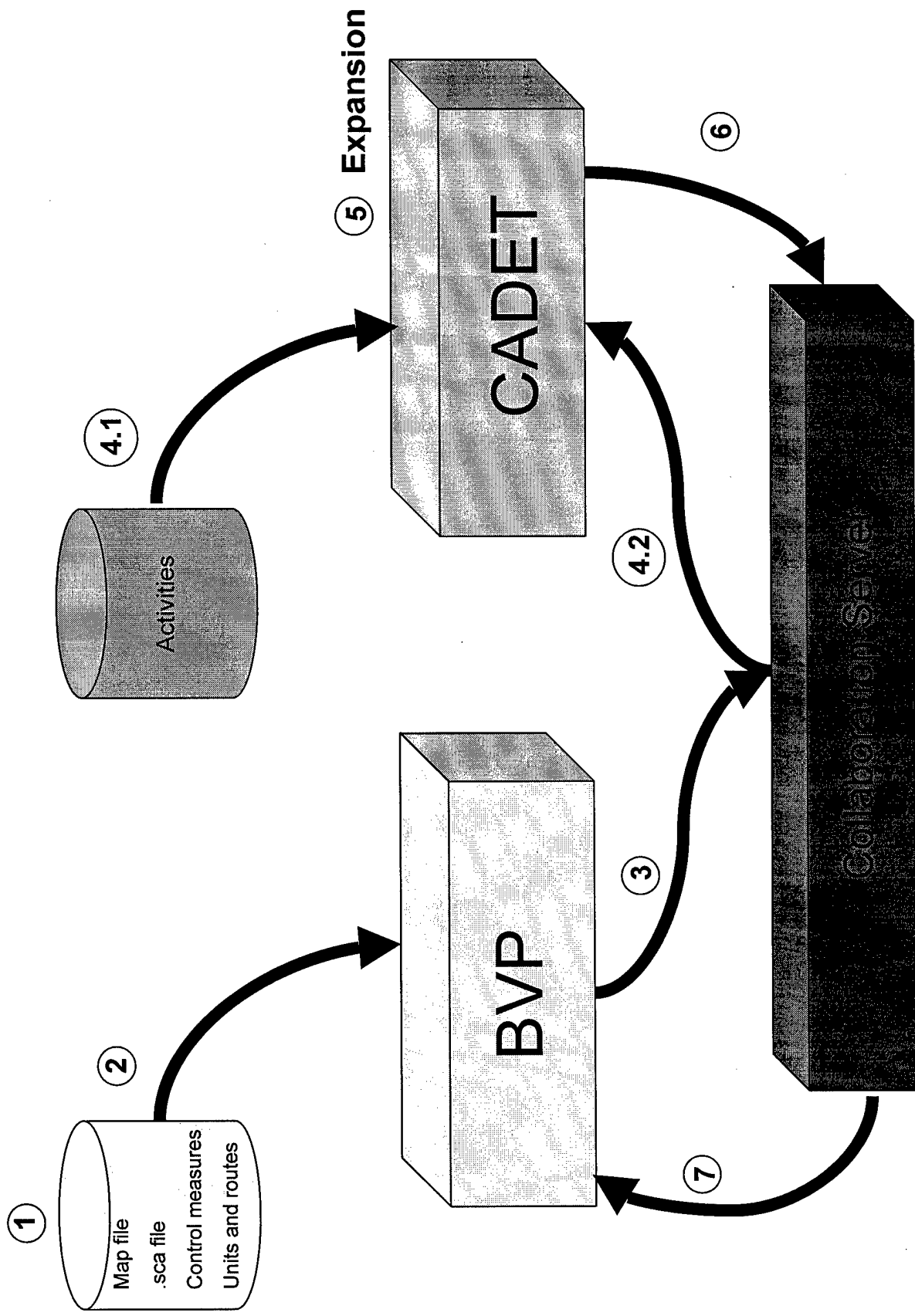

Estimation of Battlefield Attrition

in a Course Of Action Analysis

Decision Support System

Alexander Kott, PhD, Logica Carnegie Group;

Larry Ground, Logica Carnegie Group;

John Langston, EER Systems, Inc.

Land and Expeditionary Warfare Workshop

June 22-24, 1999

Outline

- Motivation and desired characteristics of the objective model
- Our approach
- The experiments and data
- The resulting model
- Observations and arguments
- Future work

Motivation

Emergence of real-time decision-support
battle planning and analysis tools =>

Need for fast, simple, real-time attrition
estimation models:

- computationally frugal and data frugal
- relatively transparent to the operator with no training
- fully automated or operator-driven

Example Decision-Support System: CADET

Key Inputs:

- COA Statement (object-represented, 10-20 main activities)
- Friendly troops, strength, location
- Enemy COA, troops, strengths, location
- IPB Products

CADET



Key Outputs:

- Detailed Plan
 - * 200-500 activities
 - * all BOS's
 - * timing, synchronization
 - * assets allocated
 - * DST, etc.
- Estimates
 - * attrition
 - * consumption
 - * risk

Compute Attrition, Consumption

Resource Consumption

- Consumption varies based on mission, terrain
- Logistics resupply
- CADET recommends schedule for resupply to minimize impact on operations

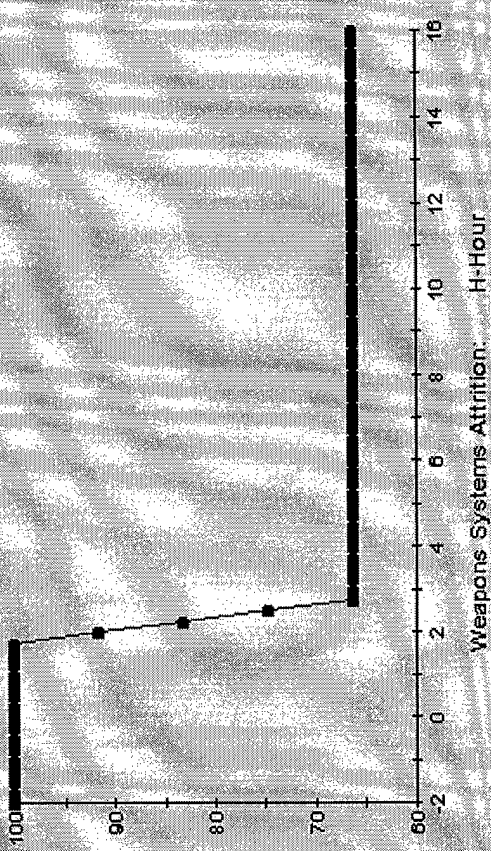
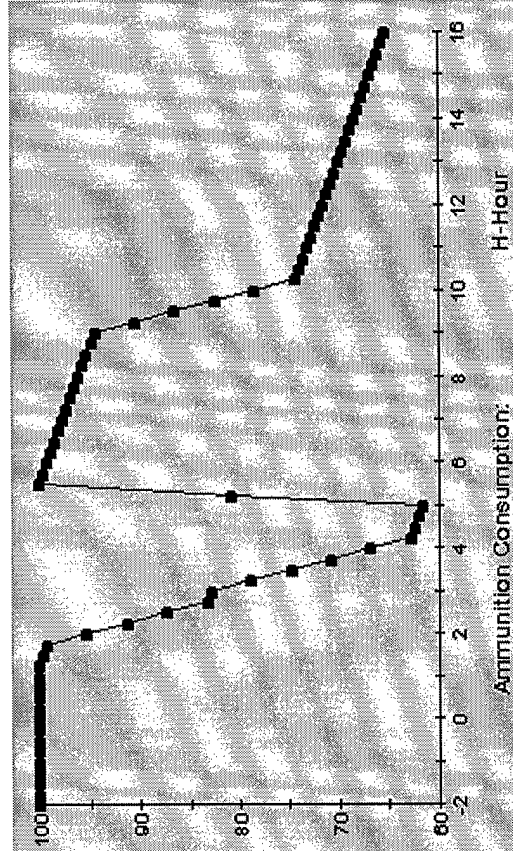
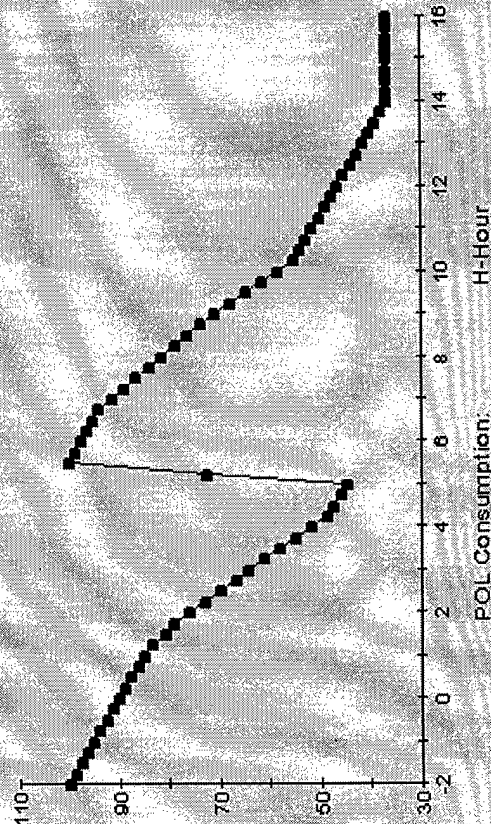
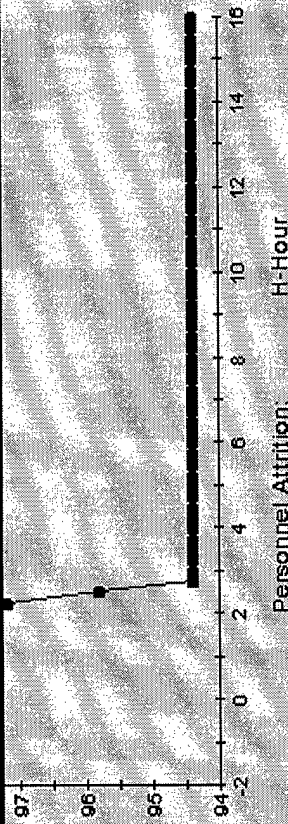

Observe the Resource Situation

Quick-reference Resource Indicator

- Resource consumption for each activity displayed on right end of activity box
- Personnel, Ammo, Fuel, Weapons Systems

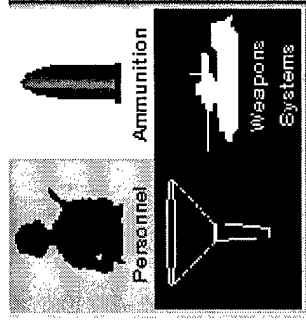

Color Key	
Ammunition	pct of full complement
Green	□80%
Yellow	□60%
Black	□40%
	□40%

M/C/S	FIRE SUPPORT	2 Attk Bn Return From Target	2 Attk Bn Cross FLOT	DIVARTY
			2 Attk Bn Cross FLOT	DIVARTY
		DIVARTY SEAD to Cross FLOT	DIVARTY SEAD to Cross FLOT	DIVARTY
		DIVARTY Prep Fire for Attk		DIVARTY

View the Animated Plan

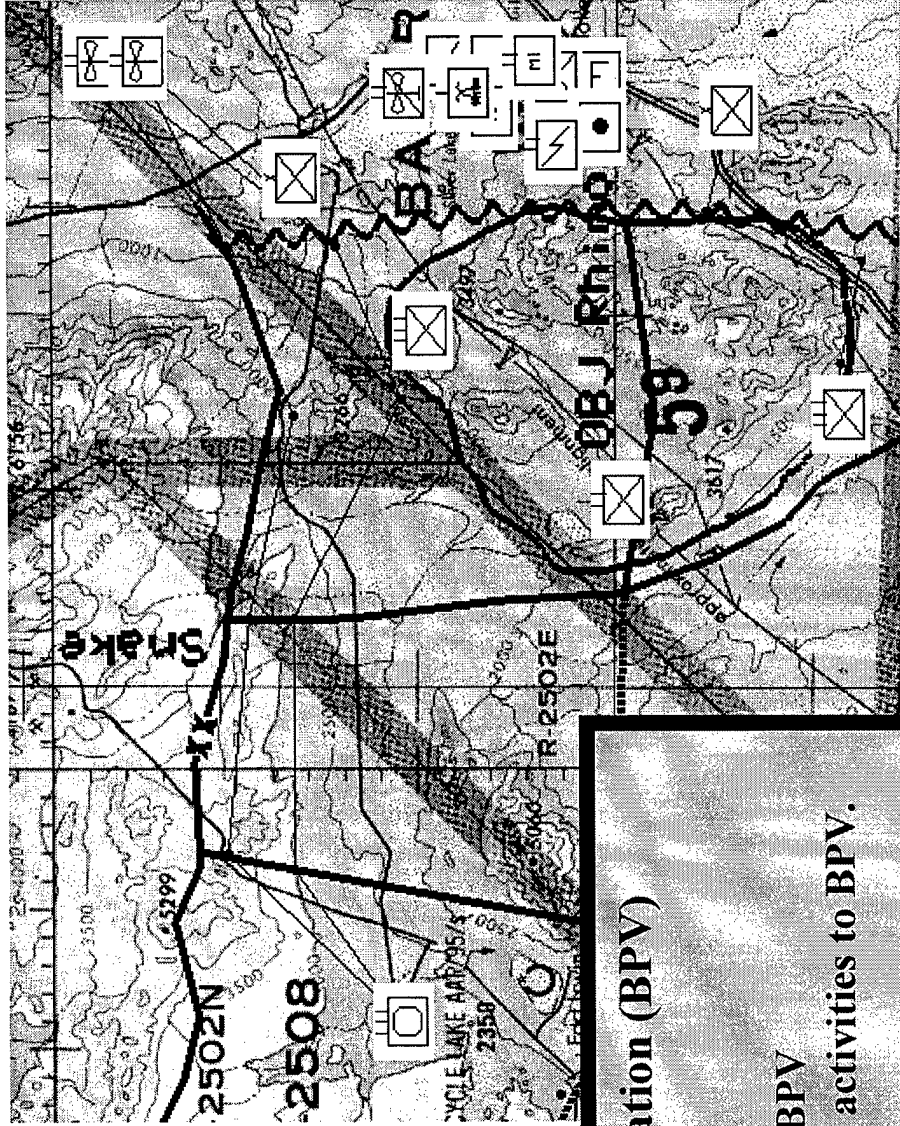

Battlefield Planning and Visualization (BPV)

- **Government Off The Shelf (GOTS)**
- **Laptop version (WinBPV)**
- **User can enter rough-cut COA into BPV**
- **CADET sends detailed units, routes, activities to BPV.**
- **BPV animates the plan**

June 22, 1999

Logica Carnegie Group
EER Systems, Inc.

Motivation: the need for fast, simple attrition model

- computationally frugal (interactive nature of CADET, multiple calculations in under 2 seconds, using COTS laptop/palmtop computers)
- data frugal
- relatively transparent to the operator with no training
- fully automated or operator-driven
- scope:
 - “activity”: tasks 0.1-10 hrs in duration
 - unit: Bn to Bde

Motivation: we asked around

- “oh, there was so much work done - there must be tons of stuff available...”
- “I cannot think of anything specific...”
- “ask Col Jones - they did something like that...”
- “...no, we did not...”
- “attrition cannot be calculated anyway...”
- “oh, that’s too hard to do!”

Motivation: what we found

- The closest to our needs: Dupuy, Trevor N.,
“Attrition: Forecasting Battle Casualties and
Equipment Losses in Modern War,” Hero Books,
Fairfax, Va., 1990.
- Not a perfect match:
 - granularity of Dupuy’s model tends to Div, per
day...
 - some of predicted outcomes are not believable

The Dupuy Model

- Note: our presentation omits surprise, sophistication, relative quality factors;
- the basic form:

Attrition = f(Terrain, Weather, Posture, Size, Force Ratio, Relative Quality)

- Personnel Ca = $.037 * Tc * Wc * Pca * Sca * [(Fd * Tpd * Ppd) / (Fa * Wpa)]^{**.42}$
- Personnel Cd = $.037 * Tc * Wc * Pcd * Scd * [(Fa * Wpa) / (Fd * Tpd * Ppd)]^{**.42}$
- Armor Aa = $6 * Ca * Sta$
- Armor Ad = $3 * Cd * Std$
- Dupuy derived his coefficients from historic records (WW2, Middle East); worked well for Gulf War too

Our Approach

- Ultimate objective: a model as simple as Dupuy's but with numerical coefficients that produce results resembling the judgements of today's Army officers
- Assume the basic form of the Dupuy's model
- Make modifications to the model based on experiments with estimates of today's military experts

Methodology

- **Based on a set of Attrition Estimation Experiments: 15 engagements designed to cover a range of conditions**
- **Participants: officers (MAJ, LTC, COL) of US Army**
- **Experiments: each participant asked to estimate attrition and several other parameters**
- **Currently a total of 180 data-points processed**
- **Coefficients are derived to give best fit to the data**

Current Range of Experiments

- Force Type: heavy mech; Blue attacks
- Blue Echelons: TF from 1Bn to 6 Bns
- Red Echelons: 2 Bn to 1 Co
- Force Ratio: from 2:1 to 9:1
- Posture: from hasty to fortified
- Weather: from mild to extreme cold/snow
- Terrain: from flat desert to extreme rugged

Experimental Cases

- #1 - nominal
- #2 - low Fa/Fd
- #3 - high Fa/Fd
- #4 - small units
- #5 - large units
- #6 - bad terrain
- #7 - good terrain
- #8 - bad weather
- #9 - good weather
- #10 - fortified defense
- #11 - withdrawal
- #12 - short advance
- #13 - long advance
- #14 - harsh terrain, weather, fortification
- #15 - easy -//-

Typical Case

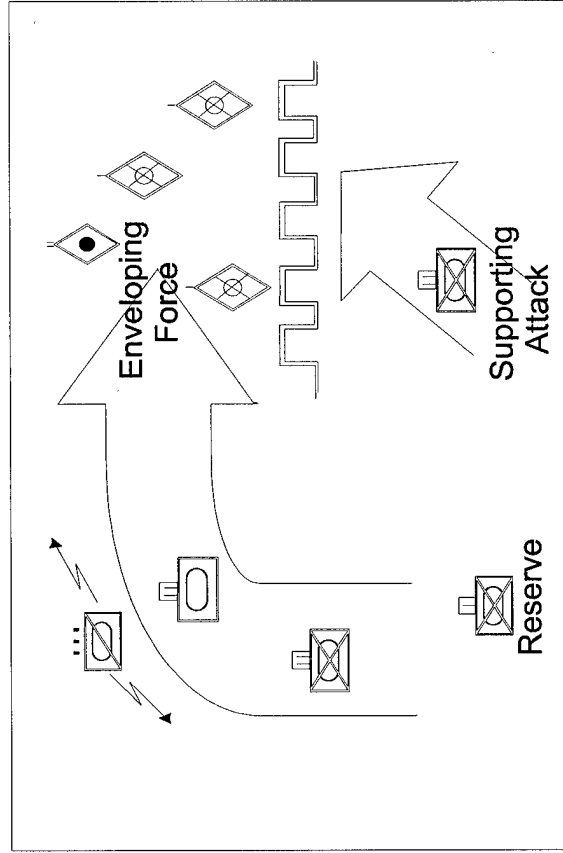

Typical Description of a Case

Blue Task Force: Conducting a hasty attack using an envelopment with 3 Maneuver Battalions consisting of the following maneuver and field artillery equipment.

- 1) 54-M1A2s
- 2) 108-M2A2s
- 3) 18-M155mm (DS) FA BN
- 4) 18-M155mm (R) FA BN

Red Force: Conducting a hasty defense with 1 Battalion; frontage for defense is 1.5 kms

- 1) 10-T-80s
- 2) 30-BMP-3s
- 3) 18-122mm SP Howitzers
- 4) 6-BM21s MRLs

Force Ratio: 3 to 1 (Blue)

Avenues of approach: rolling foothills; good trafficability ability to maintain attack formation and dispersal.

Cover: adequate

Concealment: limited

Observation: direct fire engagement will occur at 1800 meters or less

Natural obstacles: none

Man-made obstacles: 24 hours of obstacle belt and survivability preparation

Conditions: light rain/daylight attack

Distance: LD to objective for the blue task force is 10kms.

Questions / Data Collected

- Anticipated % of blue personnel casualties
- Anticipated % of blue armor loss
- Anticipated % of red personnel casualties
- Anticipated % of red armor loss
- Duration of the engagement
- Likelihood of success for the attacker

Another Example of a Case

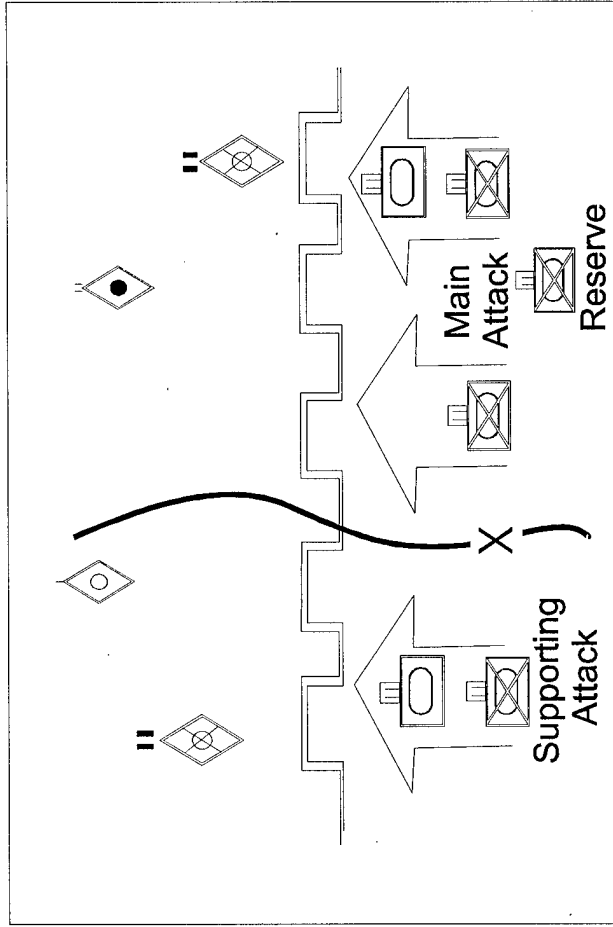

...and another

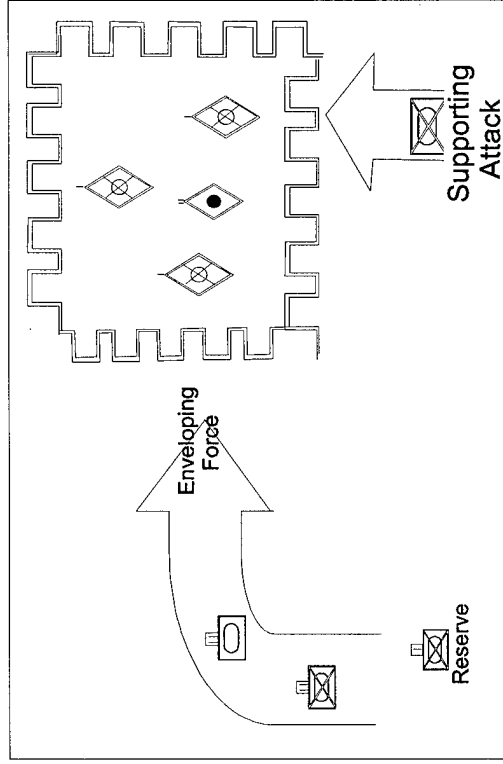

Subjects - Participants of the Experiments

US Army officers, 90% active duty

COL - 28%

LTC - 56%

MAJ - 17%

Years of service: 16-29, avg. 22

Data Collected

- total 180 points and additional 450 recently became available
- data scatter significant
- a typical response

Mean	1
Standard Error	0.036818
Median	0.896391
Mode	0.547945
Standard Deviation	0.493971
Sample Variance	0.244007
Kurtosis	1.992892
Skewness	1.039558
Range	3.09095
Minimum	0.196721
Maximum	3.287671
Sum	180
Count	180
Confidence Level(95.0%)	0.072654

What is the anticipated % of blue casualties?		What is the anticipated % of red casualties?		Hrs to complete	Attker w on out of 10
Personnel	Armd Veh	Personnel	Armd Veh		
0.20	0.30	0.70	0.75	1.50	9.00

The Resulting Model

Attacker Personnel Attrition Rate:

$$C_a = K * P_a * [(F_d * T * P_p) / F_a]^{**}.41$$

Defender Personnel Attrition Rate:

$$C_d = K * P_d * [(F_d * T * P_p) / F_a]^{**}(-.41)$$

Armored Vehicles Attrition Rate:

$$T \sim 1.0 * C$$

K	0.42
P _a (withdraw)	0.5
P _a (hasty)	0.75
P _a (fortif)	0.87
P _d (withdraw)	0.91
P _d (hasty)	1.03
P _d (fortif)	0.97
I(desert)	1.39
I(hills)	1.52
I(rugged)	2.71
P _p (withdraw)	1.15
P _p (hasty)	1.3
P _p (fortif)	2.2

- note that we have not yet generated models for rate of advance and probability of success, although data are collected
- formal R2 and significance tests have not been yet conducted

Blue Attrition Rate: Experts vs. Model

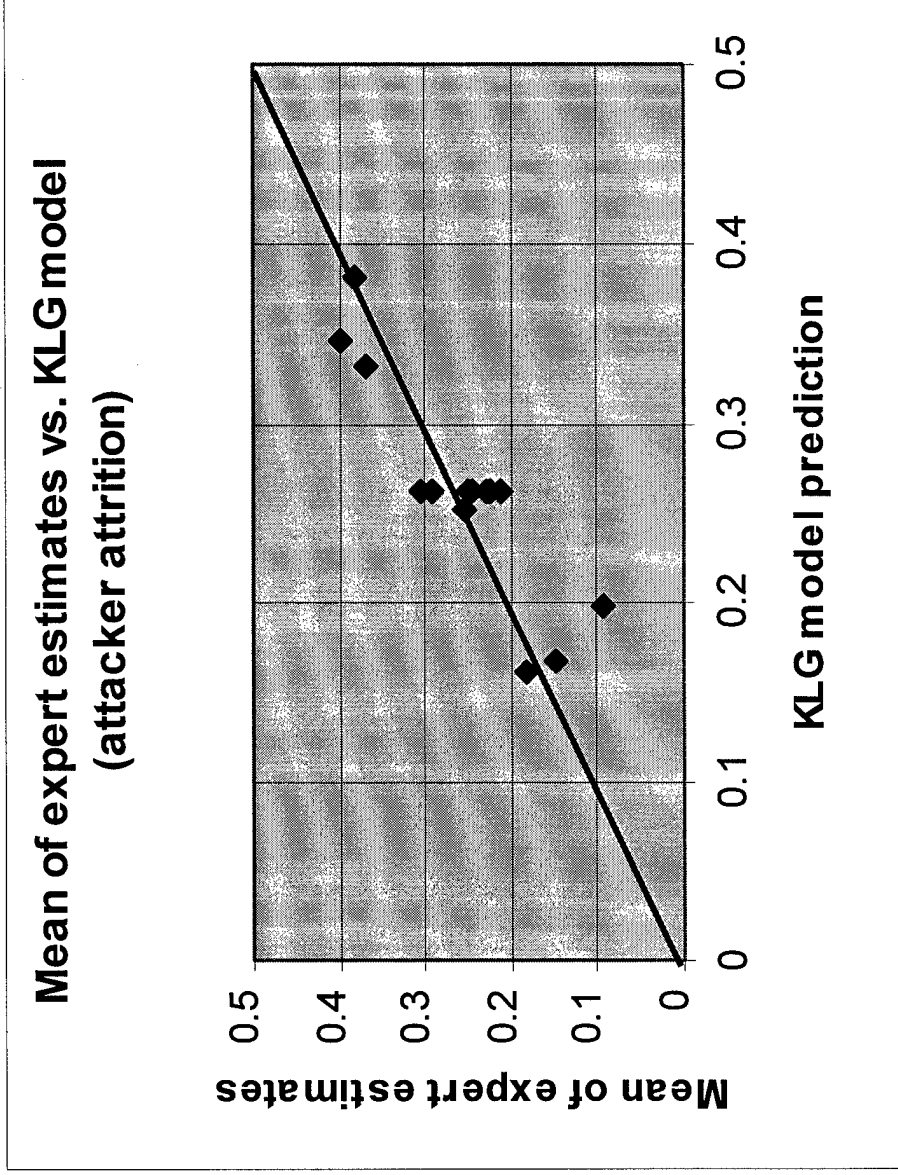

KLG = Kott-Langston-Ground Model

Red Attrition Rate: Experts vs. Model

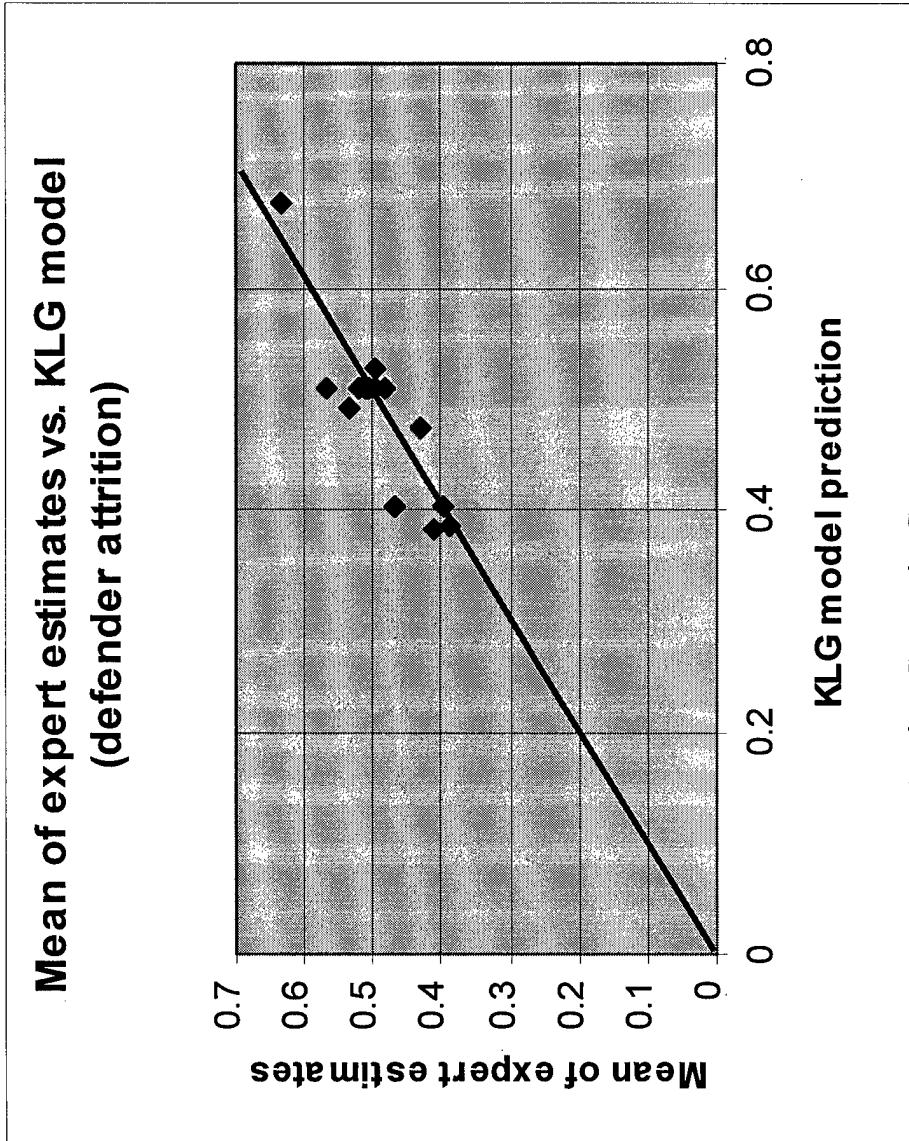

Fractional Exchange Rate: Experts vs. Model

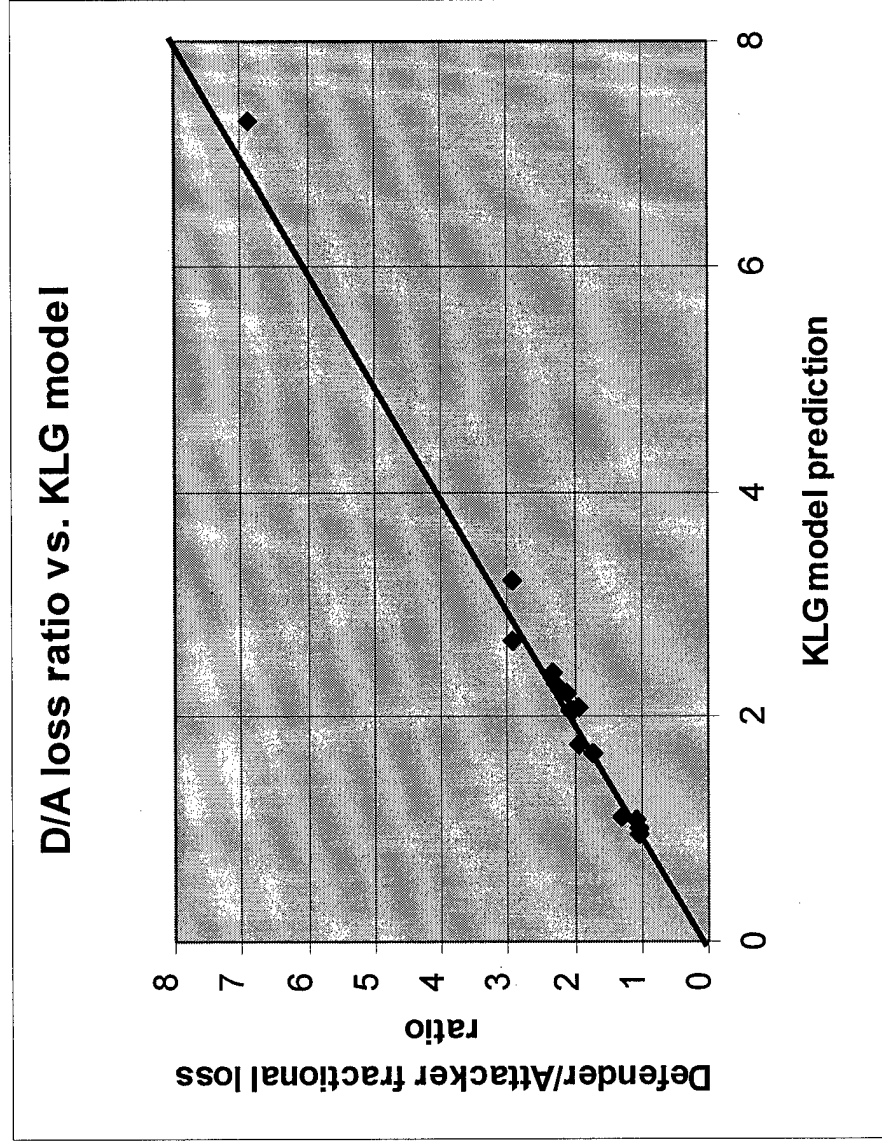

Key Observations

- Experts and Dupuy strongly disagree on relative armor/personnel attrition
- Experts ascribe less importance to weather than Dupuy
- Experts ascribe more importance to terrain and fortifications
- Experts ascribe less importance to overall unit size

Relation of Personnel and Armor Attrition

- Dupuy's model seem to state that attacker rate of personnel attrition is about 1/6 of armor
- Experts in our experiments disagree: attrition rate of personnel is about equal to that of armor

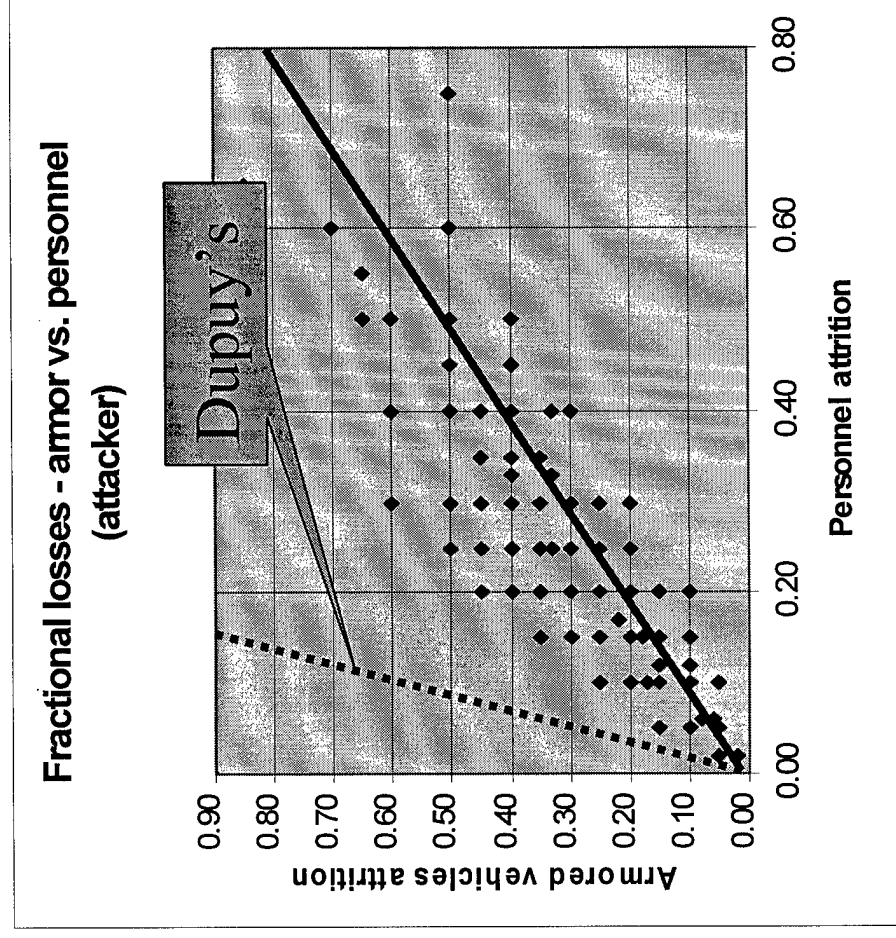

Relation of Attrition Rate to Unit Size

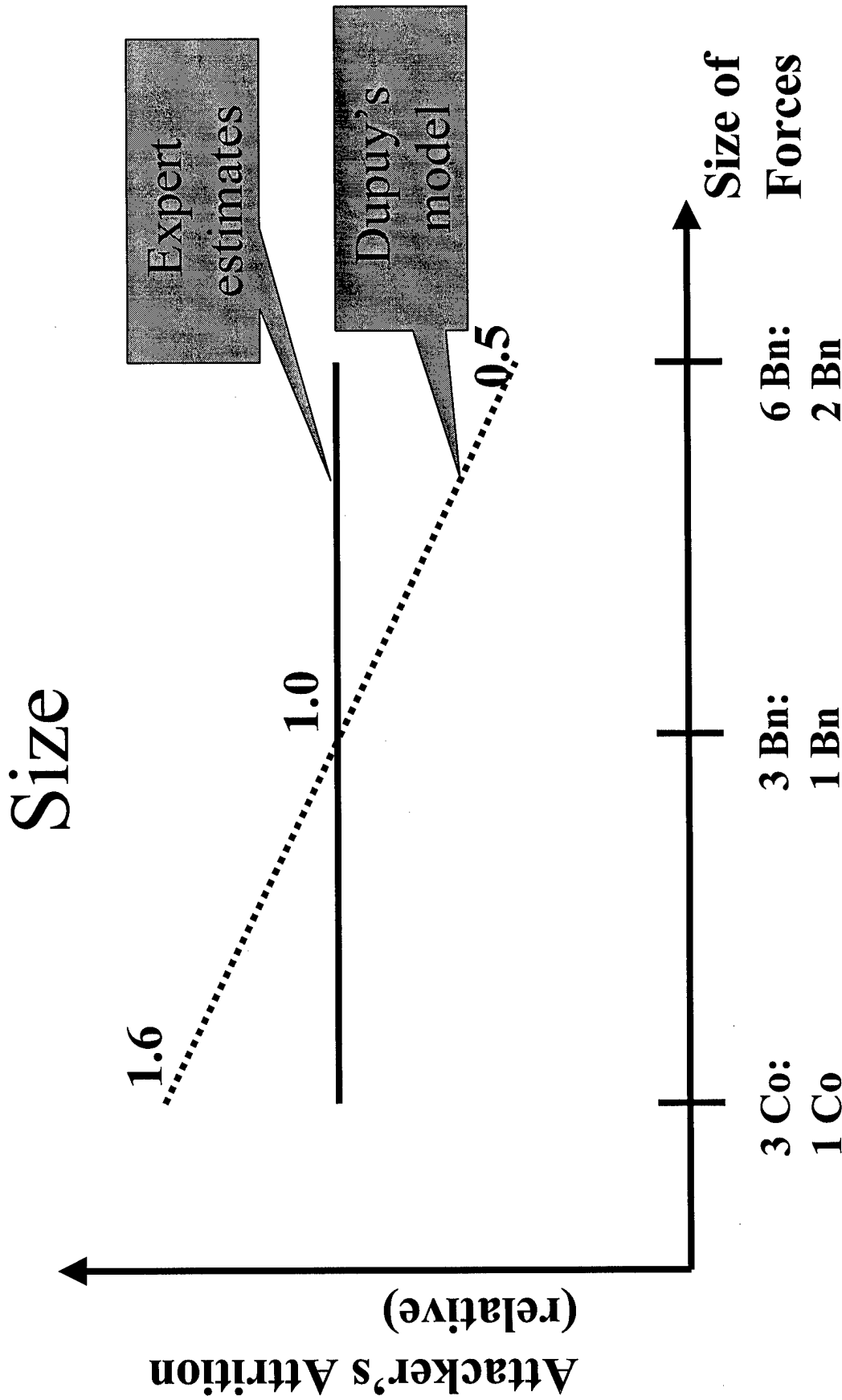

June 22, 1999

Logica Carnegie Group
EER Systems, Inc.

Impact of the Terrain

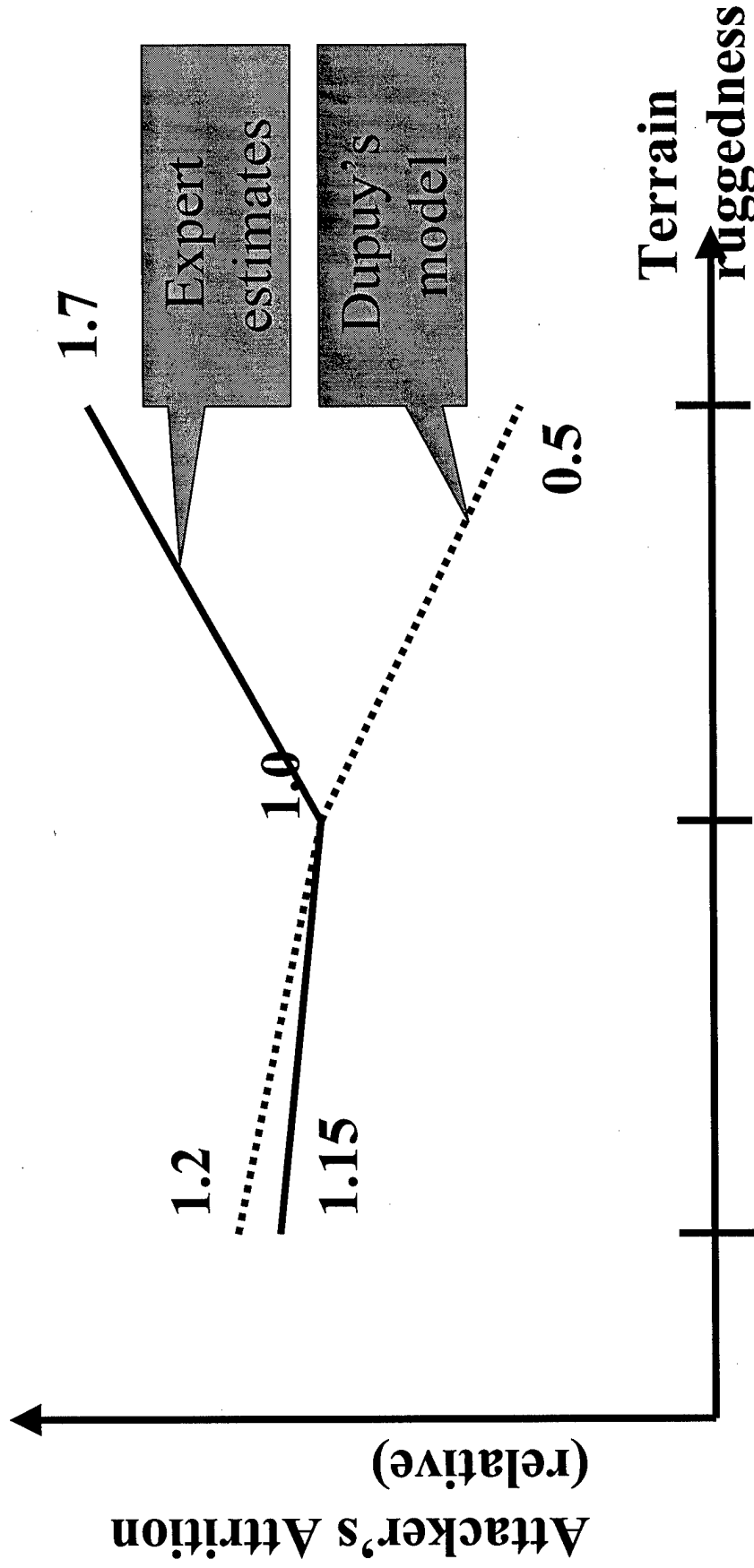

**Desert,
flat, hard**

**Hills,
mixed**

**Rugged
wooded**

June 22, 1999

Logica Carnegie Group
EER Systems, Inc.

An Opinion: Numbers Irrelevant

- Colonel A:
 - COA decisions are hardly dependent on power ratios
 - Battle outcomes are hardly dependent on power ratios
 - other factors more important: intuition, skills, proficiency, surprise
 - good generals never use attrition-based analysis

An Opinion: Wrong Fight

- Colonel C:
 - the doctrine has changed - we would not fight like this
 - Apaches have changed the battle

An Opinion: Evidence of Risk-Aversion

- Colonel B:
 - your experiments show our officers too conservative
 - CTC/MILES misrepresent the fight, cause risk-aversion
 - try to correlate OC's vs. non-OC's

Current Implementation

- The KLG model is implemented as part of the CADET software
- User can select between the Dupuy model and the KLG model
- The model is used both for automated computations and for user-driven calculator

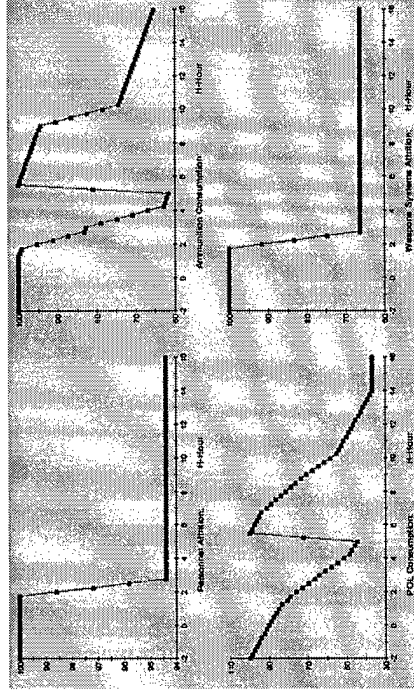

The screenshot shows the 'Combat Calculator' interface. It features a central control panel with various input fields and buttons. The interface is divided into several sections:

- Force Selection:** Two columns of force selection buttons. The left column includes 'M2 Bn', 'M1A1 Bn', 'M3 Bn', and 'M2 Bn'. The right column includes 'BTR60 Bn', 'T80U Bn', 'BTR60 Bn', and 'BTR60 Bn'.
- Force Ratio:** A field showing '3.19'.
- Power Ratio:** A field showing '0.81'.
- Duration (hr):** A field showing '4.85'.
- End force ratio:** A field showing '3.04'.
- Force (UE):** A field showing '3.32'.
- Per. loss (%):** A field showing '1.47'.
- Armor loss (%):** A field showing '4'.
- End force (UE):** A field showing '3.62'.
- Force (UE):** A field showing '0.91'.
- Per. loss (%):** A field showing '2.48'.
- Armor loss (%):** A field showing '7.44'.
- End force (UE):** A field showing '0.84'.
- Health of failure:** A dropdown menu set to 'Low'.
- Terrain:** A dropdown menu set to 'Rugged, woods'.
- Weather:** A dropdown menu set to 'Dry, sun'.
- Defense:** A dropdown menu set to 'Fortified'.
- Advance (km):** A dropdown menu set to '2'.
- Advance (km):** A dropdown menu set to 'Combat'.

Future Work

- Additional 40 sets of responses became available; data analysis in process
- Analysis of fit and significance tests
- Models to be formulated: rate of advance; probability of success
- Some adjustments of the model are warranted
- Collaboration is invited

June 22, 1999

Logica Carnegie Group
EER Systems, Inc.

Summary of Key Points

- immediate practical needs for models that are:
 - based on task/activity
 - tactical/operational granularity
 - real-time & frugal in data and CPU
 - passing “gut-check”
 - can be fully automated or operator driven
- benefits in modeling the expert’s anticipation
 - perhaps best info on the future conflicts
 - operator’s acceptance of decision-support
 - byproduct: insights into training issues

June 22, 1999

Logica Carnegie Group
EER Systems, Inc.

BACKUP SLIDES

Purpose

To provide the Commander in a tactical situation with an attrition Model that will assist him in answering “If I know the desired end-state, which COA will enable me to best achieve it” .

CADET: Under the Hood

Logical Carnegie Group

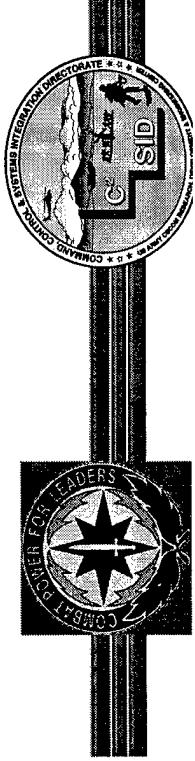

CADET: *Under the Hood*

- Object Diagrams
- Examples of Expansion Rules
- Significant Algorithms
- Integration with BPV
- User Interface

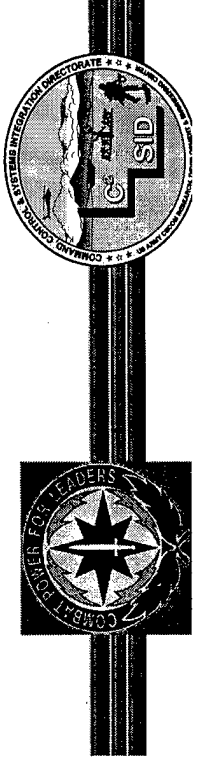

Object Diagrams

- High-level structure
- Planner-scheduler object diagram
- Current Activity subclasses
- GUI object diagram



High-Level Structure

- Identify and abstract those aspects of plan objects that external systems need
- Allows evolution of major components independently of each other
 - planner-scheduler
 - knowledge base
 - user interface
 - external system interface



High-Level Structure

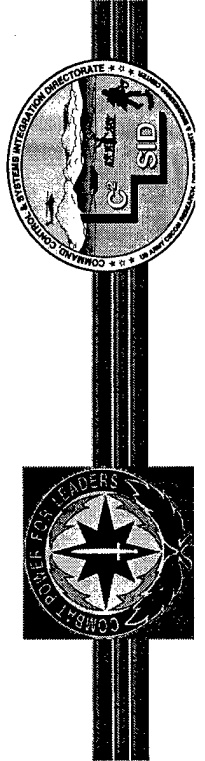
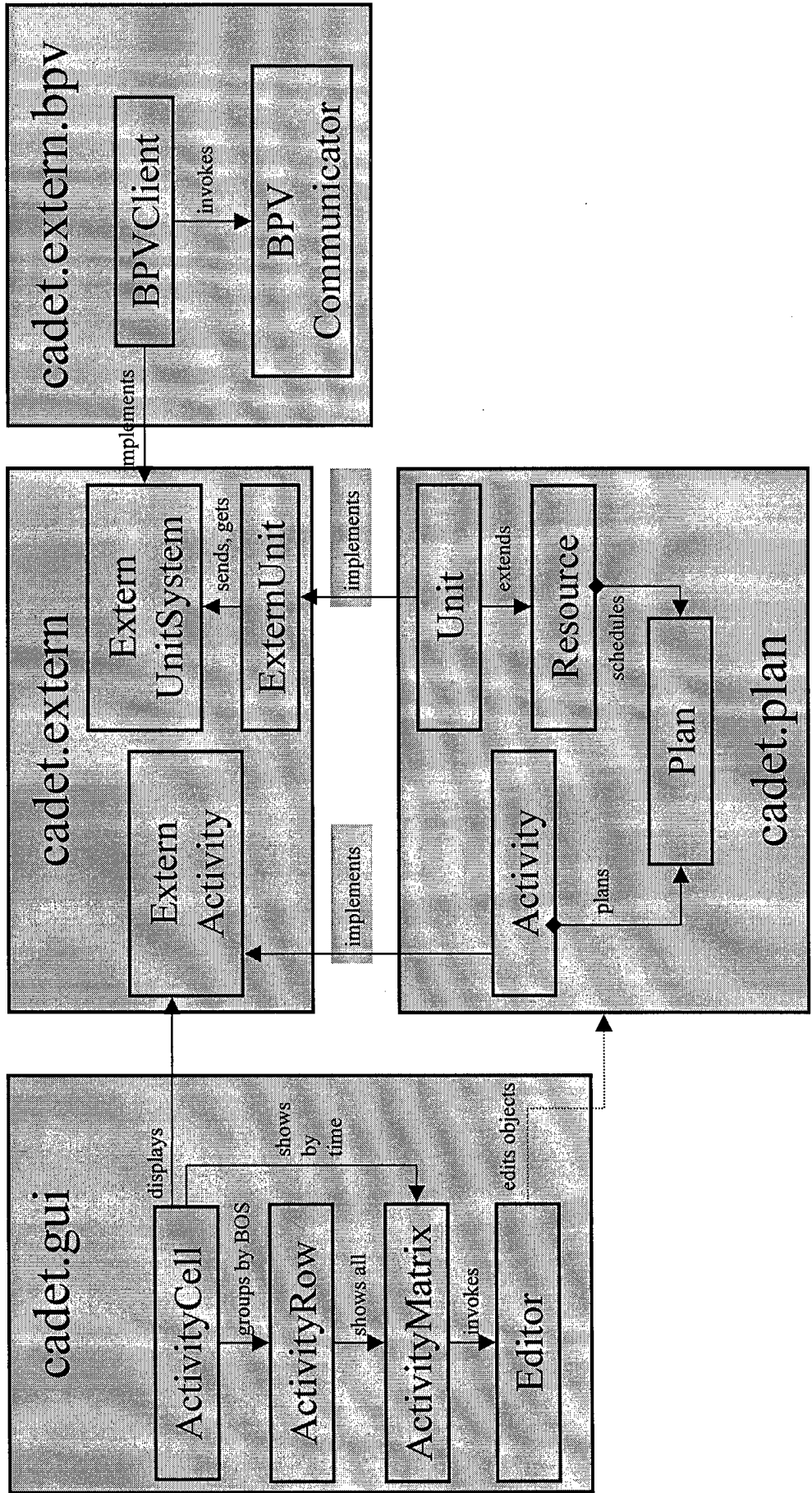

Planner-Scheduler Object Diagram

- Principal classes:
 - Plan
 - Activity
 - ActivityTime
 - TimeConstraint
 - Resource
 - Unit
 - Route

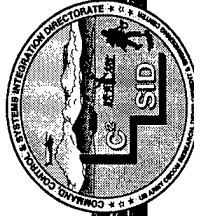

Examples of Unit-Related Knowledge

- **Characteristics speeds**
- **Method for determining suitability for an activity**
- **Method for converting unit's activities into time-space characteristics**
- **Method for unit status update**



Examples of Activity-Related Knowledge

- Expansion method
- Method for calculation of outcome
- Route requirements
- Unit requirements (capability, strength)
- Impact of activity on speed
- Impact of activity on use of supplies



Current Activity Subclasses Diagram

- **Principal part of Knowledge Base**
- **Subclass structure is mostly determined by common attributes and methods**
- **Expansion method governs creation of supporting activities**

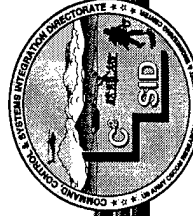

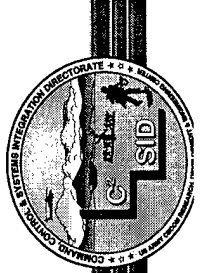
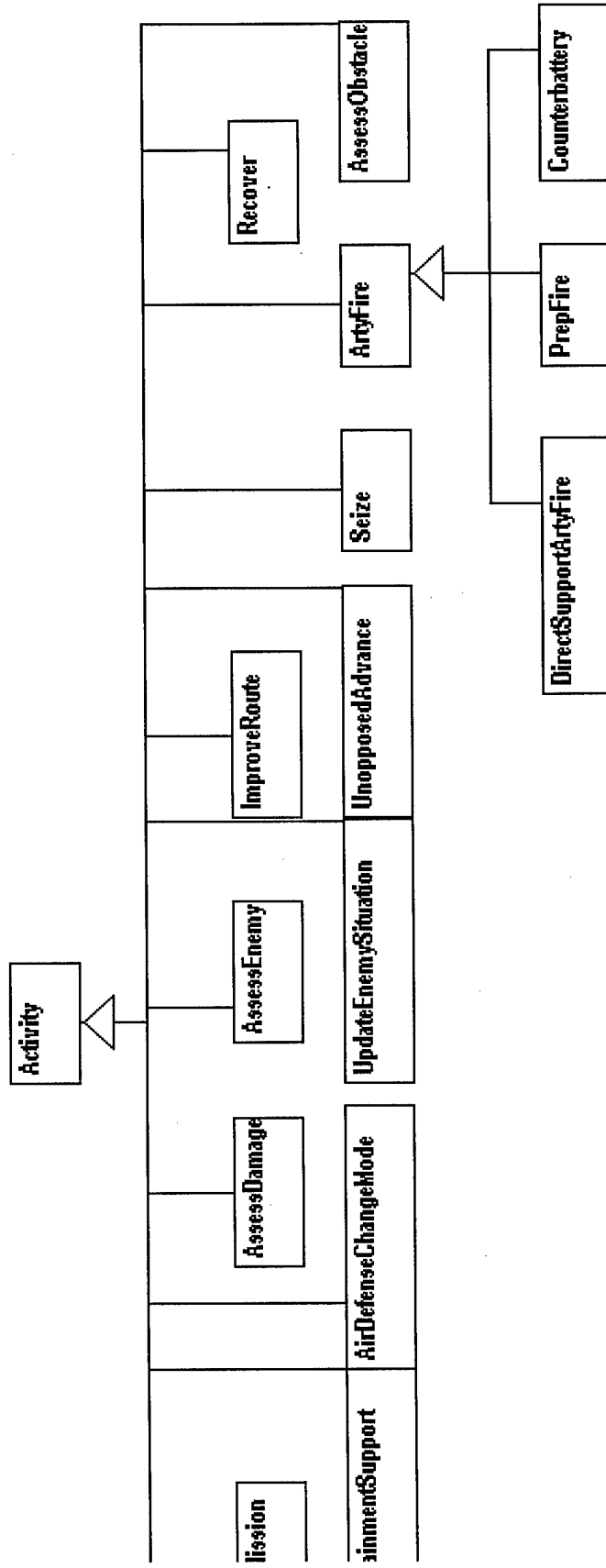

Examples of Expansion Rules

- **Activity-specific expansions with Advance**
 - **Seize Objective**
 - **Passage of Lines**
- **Advance**
 - **adds tactical march, unopposed advance or attack according to forces encountered**
 - **adds uncoil, cross line, refuel-rearm as needed**

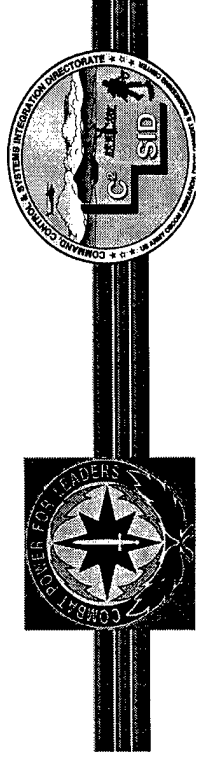

Significant Algorithms

- **Expansion & Allocation interleaved**
- **Planning interleaved with human input**
- **Routing**
- **Enemy Reaction and Counteraction**
- **Attrition**
- **Consumption**

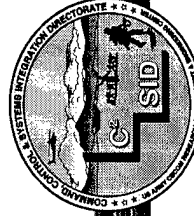

Expansion & Allocation Algorithms

- Variant of Hierarchical Task Network planning
- Practical, heuristic-based no-backtracking approach
- Interleaves planning and scheduling and permits user intervention

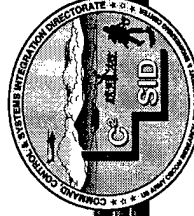

Expansion-Allocation Algorithm Main Flow

- 1. Choose the next activity to expand.**
- 2. Call this activity's expansion method to create supporting activities; propagate time constraints among the new activities.**
- 3. Perform resource allocation and scheduling for this activity.**
- 4. If the number of newly-added activities exceeds N, stop and present plan to user on synchronization matrix; else repeat 1-4.**



1. Choosing the Next Activity to Expand

- **Can let user choose the next activity by pointing to it on synchronization matrix**
- **When proceeding automatically, choose next by ranking all to-be-scheduled activities by these heuristics:**
 - **whether time of activity already fixed by constraints**
 - **whether activity is more important for domain-specific reasons (by activity class or BOS, e.g.)**
 - **whether activity must be completed sooner**

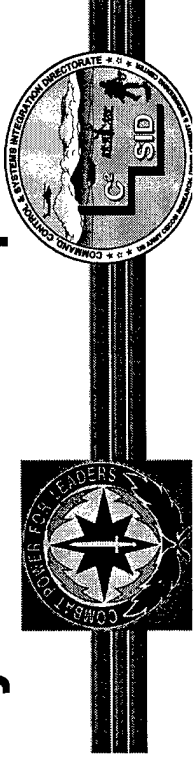

2. Activity-Specific Expansion Method

- **Key knowledge base rule for each Activity subclass**
- **Creates supporting activities appropriate to the activity: if traverses a route, infers activities from items found on route (phase lines, other units, obstacles)**
- **Sets time constraints among the supporting activities**
- **Sets resource candidates appropriate to the supporting activities**
- **Can request user selection**

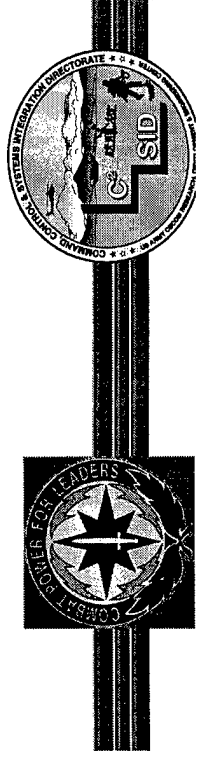

2. Activity-Specific Expansion Examples

- If a route crosses phase line Gator, insert an activity “Cross Phase Line Gator”
- If a route crosses the positions of enemy units, insert Attack or Bypass activity depending on force ratio (currently, but can elaborate rule as desired)
- To support an activity Seize Objective Rhino, add a following activity Secure Objective Rhino whose candidate units are the same as those in the Seize

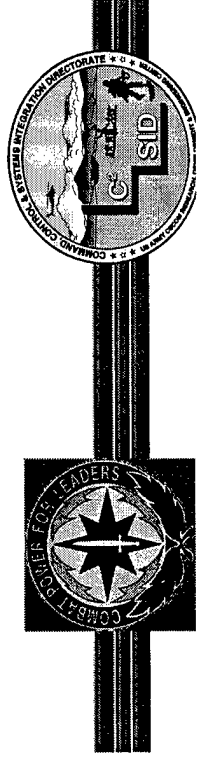

3. Resource Allocation and Scheduling

- Knowledge base rules specific to Activity subclasses provide
 - what kind and size of resources are needed
 - for a given resource, activity duration
- For Phase 2, modeling 2 classes of resources:
 - units
 - routes

3. Resource Allocation Example Rules

- Activity Prep Fire can be performed by DIVARTY or brigade DS artillery and lasts no more than 30 minutes
- Activity Improve Route for a given route can be performed by an Engineer company in 3 hours or an Engineer battalion in 1 hour

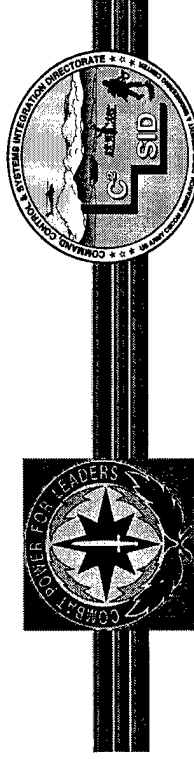

4. Presenting Partial Plans to User

- Lets user watch plan evolve
- Avoids single, massive result that's not easily comprehended
- Subject of next section

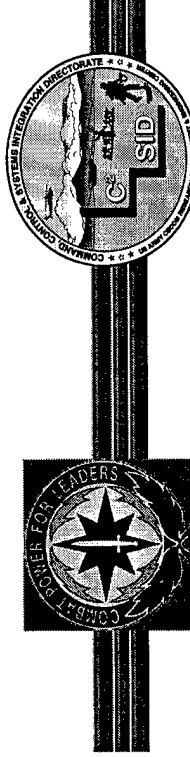

Interleaving Planning with Human Input

- Goal is to let user comprehend and, if desired, direct plan evolution
- When, during expansion processing, the number of activities newly added to plan or newly scheduled exceeds N , stop the main cycle and display the activities generated so far
- Pauses have no effect on planning algorithm unless user actually changes something
- Currently $N=10$; could change with experience
- Colors show what's new, scheduled, etc.

Routing Algorithm

- Avenue of Approach modeling: nodes and segments
- Segment characterization
- Weighting important characteristics
- Can solicit route from user
- Adapted shortest-paths algorithm to select route



Route Selection Algorithm

- Adaptation of a class of shortest-paths algorithm
- Input is network of routes and segments, origin point
- Output is “shortest” path from origin to every other point
- Redefine meaning of “shortest” by characteristics described above



Enemy Reaction and Counteraction

- **Opposite-side reactions and counteractions inserted where appropriate into expansion methods for activities**
- **Action-reaction-counteraction is depth limit**
- **Current modeling same for red and blue reactions; can introduce doctrinal differences**
- **Example: Passage of Lines; Fire on Passage Points; Find artillery & Counterbattery**



Attrition Calculations

- Current initial implementation targets
 - **Armored/Mechanized forces,**
 - **Blue is the attacker**
- Force ratio computed from UE values per CGSC ST 101-5
- Time required to advance to objective computed from:
 - **Force ratio, terrain type, advance rates per ST 101-5**
- Power ratio (Dupuy's) computed from
 - **Force ratio,**
 - **Weather, posture and terrain factors per Dupuy (4)**

Attrition Calculations (cont'd)

- **Armor loss rate: computed from personnel loss rate per Dupuy (7)**
- **Success likelihood roughly judged from Dupuy's data on outcome vs. power ratio**
- **Personnel loss rate per Dupuy (1), accounts for**
 - **terrain, weather, posture, opposition and size factors;**
 - **pro-rated for time of advance**

Attrition Calculations (concluded)

- Simplifications applied to the Dupuy's model:
 - weapon sophistication and mobility factor assumed to be approximated within UE value;
 - surprise factor not included;
 - military effectiveness factor not included
 - size factor estimated from UE, not directly from personnel or armor numbers

Consumption Calculations

- **Items consumed:**
 - **Fuel (POL)**
 - **Ammunition**
- **Goal for Phase 2: simple time-based rates of consumption**
- **Specific to activity subclass**
- **Not yet implemented**

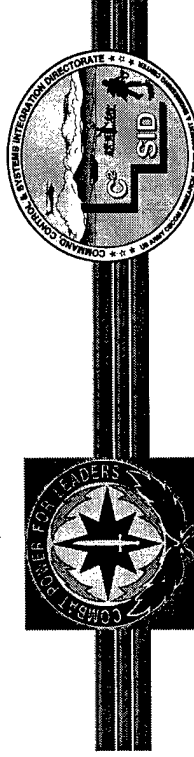

POL Consumption

	Tracked Vehicles	Wheeled Vehicles	Fuel Requirements
HHC, Bde	10	104	462
Tank Bns (2)	404	384	13,952
Mech Bn	147	103	1,946
Artillery Bn	64	94	1,398
Engineer Bn	131	187	3,777
ADA Btry	15	24	271
MI Co	5	8	62
FSB	16	161	1,149
			<u>23,017</u>

Other equipment: generators, heaters, cooking equipment, boats, included in total requirements

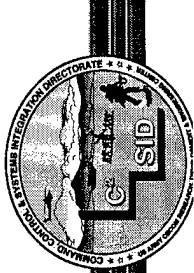

POL Consumption

- Calculate an “average” hourly rate for the Brigade Task Force.
 - During any activity, the brigade is engaging in a myriad of different sub-activities.
 - For our purposes, an estimation is sufficient.
- Use full rate (100%) for combat, direct contact.
 - Use 80% for movement along secondary roads
 - Use 20% for all other activities, including Out Of Contact



Ammunition Consumption

- For Phase 2, modeling is for direct combat actions of maneuver units (FASCAM, smoke ops would differ)
- Proposed: not yet reviewed by SMEs
- Principles:
 - Consumption is function of mission, power ratio, activity type
 - Overwhelming force requires less ammunition



Ammunition Consumption

	Weapons Systems	Ammo per hour (short tons)
Tank Bns (2)	Tanks, mortars	28.3
Mech Bn	Bradleys, mortars	12.7
Artillery Bn	Howitzers	71.5
Engineer Bn	CEVs, mines	14.5
ADA Btry	Stingers	2.0
		131.0

HHC, Bde, MI Co, FSB individual & crew-served only: combined total weight 2.0 short tons.

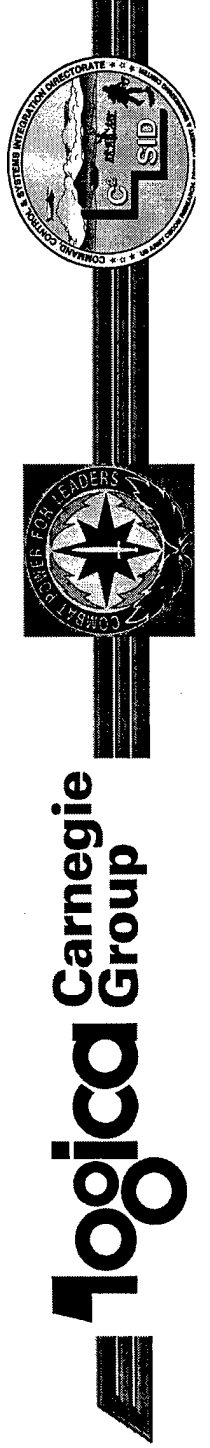

Ammunition Consumption

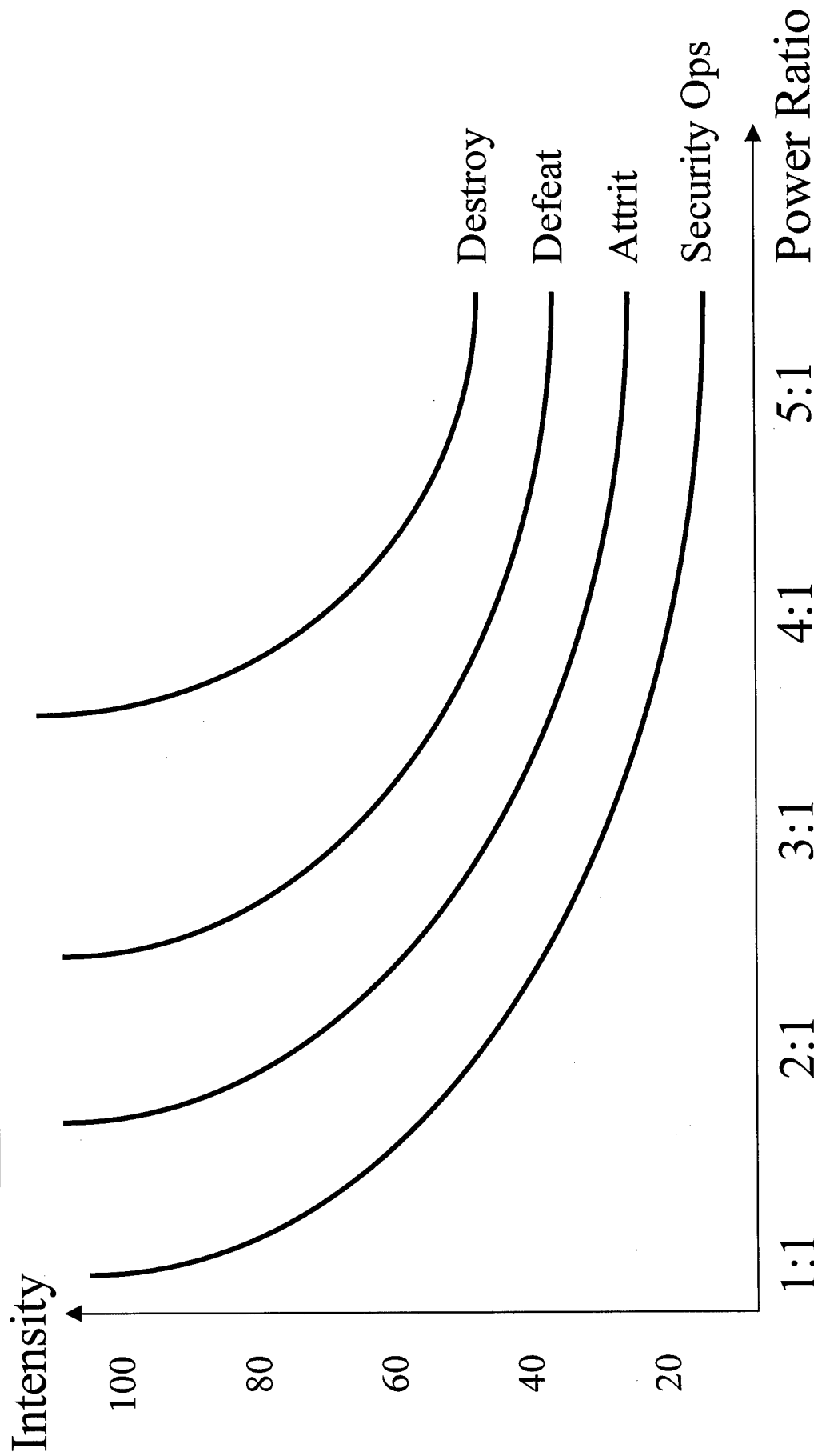

Logical Carnegie Group