

**REPORT DOCUMENTATION PAGE**

Form Approved  
OMB No. 0704-0188

The public reporting burden for this collection of information is estimated to average 1 hour per response, including the time for reviewing instructions, searching existing data sources, gathering and maintaining the data needed, and completing and reviewing the collection of information. Send comments regarding this burden estimate or any other aspect of this collection of information, including suggestions for reducing the burden, to Department of Defense, Washington Headquarters Services, Directorate for Information Operations and Reports (0704-0188), 1215 Jefferson Davis Highway, Suite 1204, Arlington, VA 22202-4302. Respondents should be aware that notwithstanding any other provision of law, no person shall be subject to any penalty for failing to comply with a collection of information if it does not display a currently valid OMB control number.

**PLEASE DO NOT RETURN YOUR FORM TO THE ABOVE ADDRESS.**

<b>1. REPORT DATE (DD-MM-YYYY)</b> 4/8/00			<b>2. REPORT TYPE</b> Final Report		<b>3. DATES COVERED (From - To)</b> Aug. 1 1999 to July 31, 2000	
<b>4. TITLE AND SUBTITLE</b> Hybrid Optical/Digital Imaging for Automatic Inspection					<b>5a. CONTRACT NUMBER</b> Contract # DAAD19-99-C-0043	
					<b>5b. GRANT NUMBER</b>	
					<b>5c. PROGRAM ELEMENT NUMBER</b>	
					<b>5d. PROJECT NUMBER</b>	
<b>6. AUTHOR(S)</b> Edward. R. Dowski, Jr.					<b>5e. TASK NUMBER</b>	
					<b>5f. WORK UNIT NUMBER</b>	
<b>7. PERFORMING ORGANIZATION NAME(S) AND ADDRESS(ES)</b> CDM Optics, Inc. 4001 Discovery Drive Suite 390 Boulder, Colorado 80303					<b>8. PERFORMING ORGANIZATION REPORT NUMBER</b>	
<b>9. SPONSORING/MONITORING AGENCY NAME(S) AND ADDRESS(ES)</b> U. S. Army Research Office ATTN: AMSRL-RO-RI (Sylvia Hall) P.O. Box 12211 Research Triangle Park, NC 27709-2211					<b>10. SPONSOR/MONITOR'S ACRONYM(S)</b>	
					<b>11. SPONSOR/MONITOR'S REPORT NUMBER(S)</b>	
<b>12. DISTRIBUTION/AVAILABILITY STATEMENT</b> Approved for public release					<b>20000809 133</b>	
<b>13. SUPPLEMENTARY NOTES</b> Report Developed under STTR contract for topic "Army 99 T001".						
<b>14. ABSTRACT</b> During this project a revolutionary system for digital imaging was demonstrated. This system is based on the newly-developed imaging technology of Wavefront Coding (WFC). WFC employs specialized aspheric optics and digital signal processing to greatly increase the depth of field and depth of focus. WFC can also simultaneously decrease the size, weight, and cost of a variety of digital imaging systems. During this effort new WFC single lens systems were designed and simulated that can perform as well as expensive multi-lens systems. WFC systems were also shown to passively athermalize IR imaging systems. A high-magnification WFC microscope was constructed. Images from this system showed revolutionary increases in performance. Applications of Wavefront Coding include high magnification biological and materials microscopy, endoscopy, inexpensive miniature imaging systems, bar code scanners, and machine vision systems. For further information see STTR Report.						
<b>15. SUBJECT TERMS</b> Digital imaging, Wavefront Coding, single-lens imaging, athermalization, IR imaging						
<b>16. SECURITY CLASSIFICATION OF:</b>			<b>17. LIMITATION OF ABSTRACT</b> UU	<b>18. NUMBER OF PAGES</b> 11 Total	<b>19a. NAME OF RESPONSIBLE PERSON</b> Edward R. Dowski, Jr.	
<b>a. REPORT</b> U	<b>b. ABSTRACT</b> U	<b>c. THIS PAGE</b> U			<b>19b. TELEPHONE NUMBER (include area code)</b> (303) 449-5593	

## Hybrid Optical/Digital Imaging for Automatic Inspection Final Report

There were four goals of the Phase I effort. These goals were centered on the refinement of CDM Optics' WFCDesign optical/digital design software, the testing of WFCDesign software tools on commercially important imaging applications, evaluation of Wavefront Coded (WFC) imaging examples, and the evaluation of real-time processing DSP hardware for processing Wavefront Coded imagery. Each of these goals were realized. The following describes the efforts taken towards each of the Phase I goals and the results achieved.

Goal #1 Refinement of WFCDesign WFCDesign is the name of CDM Optics' custom optical/digital design software. This software consists of Zemax commercial lens design software and custom software extensions to model the digital sampling and filtering aspects of Wavefront Coded imaging systems. While commercial optical design software is well suited to designing traditional optics that require no signal processing of the images, WFCDesign specifically allows the design of the system from the spherical and aspherical optics, through the digital detector, to the signal processing. Both the optics and signal processing can be jointly optimized in this manner. Since the optics influence the signal processing, and the type and form of the signal processing influences the optics, the ability to design both together leads to very powerful optical designs. A block diagram of WFCDesign is shown in figure 1.

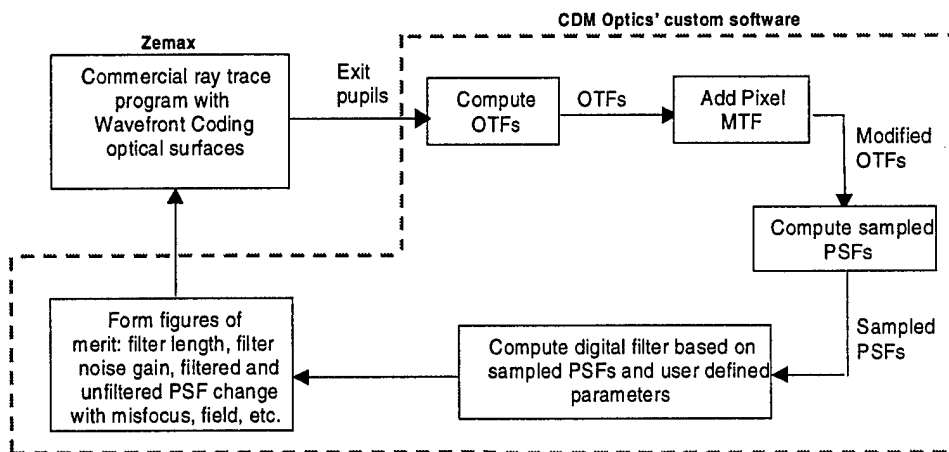

Figure 1: WFCDesign block diagram. By designing the Wavefront Coded optics and signal processing *together*, system-wide optimization and tradeoffs can be made.

The main refinements made to WFCDesign during the Phase I effort were to speed the execution, develop new optical surface forms, and develop optical/digital design rules. A large number of computations are needed to simulate the sampled optical signals as well as perform the image filtering. The original version of WFCDesign used Matlab-based processing for calculations. Although easy to program, Matlab processing is slower than needed. In order to make WFCDesign practical, the time required to perform these types of calculations has to be short so that large numbers of optimization parameters can be automatically searched. We have reduced the computation time by using a combination of C++ programming and Pentium-based MMX calculations. A number of new Wavefront Coded optical surface forms have been developed. These include very general polynomial forms as well as spline forms. Design rules for generation of Wavefront Coded optics have been developed from using the systems. Much as with traditional optical design rules, Wavefront Coding design rules allow users to navigate the often complicated multi-dimensional design optimizations.

Early Wavefront Coded imagery was formed with an optical element with a surface shape of a simple cubic. This is the only general optical part that is physically available today. During the Phase I effort more general surface forms were developed that can significantly improve the performance of the optical/digital system. One general form is:

$$S(x,y) = \sum a_i \text{sign}(x) |x/r_n|^b + a_i \text{sign}(y) |y/r_n|^b$$

where the sum is over the index  $i$ .  $\text{Sign}(x) = -1$  for  $x < 0$ ,  $+1$  for  $x \geq 0$ . The parameter  $r_n$  is a normalized radius value. This Wavefront Coding surface form is rectangularly separable and allows for fast processing if ideally fabricated. In practice it is difficult to achieve the ideal speed allowed by such a form due to fabrication errors. Other forms of Wavefront Coding surfaces are non-separable, and the sum of rectangularly separable forms. A non-separable form is defined as:

$$S(r,\theta) = \sum r_i^a \cos(b_i \theta + \phi_i)$$

where the sum is again over the subscript  $i$ .

Goal #2 Testing of WFCDesign on Commercially Important Imaging Applications A number of optical designs were performed as part of the Phase I effort to test the WFCDesign software tools, to use as a test bed to develop design rules, and to highlight the power and simplicity of Wavefront Coding. These designs include a very fast and compact singlet that images with a large field of view and depth of field, a germanium/silicon triplet IR lens that is very insensitive to temperature-related effects, and a simple 10X microscope lens that uses two aspheric plastic optical elements and images well over a large field of view. Each is briefly described below.

- **The fast and compact singlet** system was designed to illustrate the power of Wavefront Coding applied to miniature imaging systems soon to be found in cell phones, personal digital assistants, and PC cameras. The primary constraints of these systems are to use a minimum number of optical elements, to have very short length, and to image with high quality over a very wide field of view. When using a single optical element, these constraints are impossible for traditional optics. With Wavefront Coded optics, all of the constraints can be met and very high quality imaging can be produced.

The lens drawing in figure 2 describes a version of the singlet lens designed. The first element is an aspheric Wavefront Coded optic made of acrylic. The two elements to the right represent the IR filter and detector cover glass. This lens has a speed of F/2.8 and a full field of view of 50 degrees. The focal length is 3.5mm The detector is a one-quarter inch Bayer color filter array detector. The system, after digital signal processing, images over nearly the entire field of view and stays in focus with objects from infinity to 30cm.

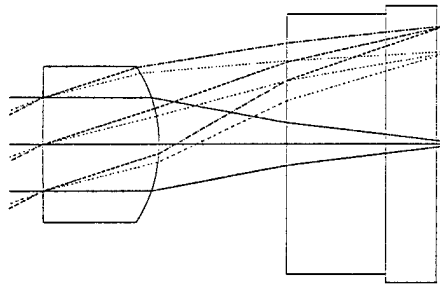

Figure 2: Lens drawing of fast and compact singlet that images with a wide field of view. The first element is an aspheric imaging optic made of acrylic. The two elements to the right are the IR filter and detector cover plate. This type of lens is meant for miniature optics of cell phones, personal digital assistants, and PC cameras. The lens has a focal length of 3.5mm, a speed of F/2.8, a full field of view of 50 degrees, and an overall length of 5.4mm.

- **Temperature corrected** germanium/silicon IR imaging system with *aluminum* mounting material was designed to show how Wavefront Coding can be used to reduce the effects of ambient temperature changes on passive optical/digital systems. Traditional IR imaging systems require active thermal compensations to perform well over even a 10 degree C temperature range. With Wavefront Coding, a specially designed system that uses only aluminum mounting material can operate with diffraction-limited performance over a 90 degree C temperature range.

Figure 3 represents the layout of this IR imaging system and the exit pupil of the system. The system is a germanium, silicon, germanium triplet design. The aperture stop is at the back surface of the third element. The system is fast, F/2, and has a focal length of 100mm. The design wavelength is 10 microns and the mounting material is purposely chosen to be aluminum which makes the design more difficult. IR imaging systems usually use much more thermally stable, and expensive, mounting materials, such as Invar.

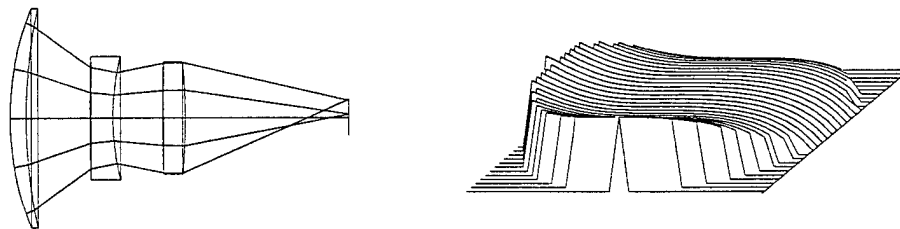

Figure 3: IR imaging system with aluminum mounting material that operates over a 90 degree C temperature range without active compensation. Left drawing represents the three optical elements of germanium, silicon, and germanium. The aperture stop is at the back surface of the last element. The drawing on the right represents the exit pupil of the system.

The performance of this Wavefront Coded IR imaging system in terms of the modulation transfer function (MTF) is given in figure 4. The upper graph of figure 4 shows the MTF of the all-optical traditional IR system over a temperature range of -20 degrees C to +70 degrees C. At +20 degrees C the system is diffraction-limited. With a 10-20 degree change the system becomes badly misfocused. The lower graph of figure 4 shows the Wavefront Coded version of the system over the same

temperature range. The MTFs before digital filtering are seen to have very little variation with temperature. These MTFs are the MTFs of the intermediate image (before digital filtering) and therefore produce blurred imagery. After digital filtering the MTFs are nearly ideal. Since the Wavefront Coded MTFs are all related to sampled systems, each MTF for the Wavefront Coded system includes the pixel MTF response that was not included in the all-optical traditional system MTFs.

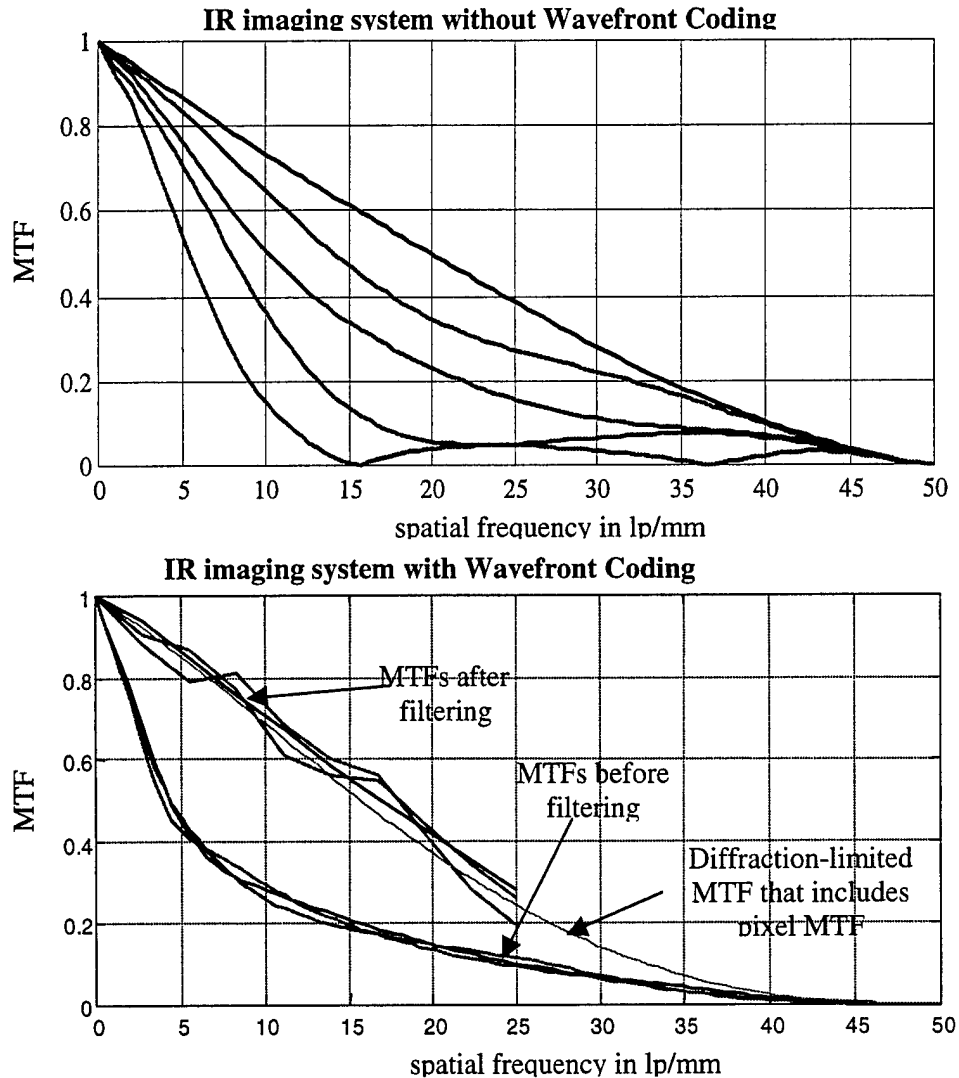

Figure 4: MTFs of traditional and Wavefront Coded IR imaging systems as a function of temperature. The top graph represents the all-optical traditional version of the IR imaging system of figure 3 without Wavefront Coding as the ambient temperature is varied between  $-20$  degrees C and  $+70$  degrees C. The system is seen to be badly out of focus as the temperature is varied. The bottom graph represents the MTFs of the IR imaging system with Wavefront Coding. Since the Wavefront Coded MTFs include sampling, they all include the pixel MTFs that are not included on the all-optical traditional MTFs. The MTFs before filtering over the same 90 degree temperature range show very little variation with temperature. The MTFs after filtering are also have little variation with temperature and are very close to the optimum diffraction-limited MTF.

- **A Simple 10X microscope objective** design that employs Wavefront Coding to reduce the optical complexity and fabrication cost was also designed as part of the Phase I effort. By reducing the optical complexity, the fabrication time and tolerances can also be reduced, thereby greatly decreasing the cost of the objectives. Since microscope objectives typically have a very narrow field of view, the main aberrations to be controlled are field curvature and chromatic aberration. Since both field curvature and chromatic aberration are “focus-like” aberrations, they can be ideally corrected with Wavefront Coding. A simple acrylic objective that images with high quality can allow very low cost objectives suitable for high volume applications such as industrial inspection, and student or children’s microscopes, that are not possible with traditional optical designs.

Figure 5 shows the layout of a two-element Wavefront Coded 10X microscope objective. Both elements are acrylic and aspheric. The second is located at the aperture stop and contains a Wavefront Coded surface. The remote stop ensures a very low level of distortion over the field.

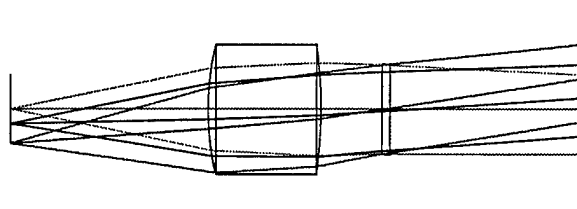

Figure 5: Layout of Wavefront Coded 10X microscope objective. Both elements are aspheric and acrylic. The second element is at the aperture stop of the system and contains a Wavefront Coded surface. This simple set of optics produces imagery, after digital processing, that has very low distortion and is very well corrected for chromatic aberration and field curvature.

Figure 6 shows the MTFs for this system both with and without Wavefront Coding. Both sets of MTFs include pixel MTFs. Without Wavefront Coding the system suffers from severe axial chromatic aberration and field curvature. Field curvature is the major problem for the traditional system. The top curve of figure 6 shows the MTFs as a function of field angle. On-axis the system is diffraction limited. For off-axis field points the MTF quickly degrades and produces a poor image.

The lower graph of figure 6 shows the MTFs for the objective with Wavefront Coding. The MTFs before digital filtering are seen to have very little variation with field angle. After digital filtering the MTFs over the entire field very nearly follow the ideal diffraction-limited curves. The Wavefront Coding objective has ideal performance while using only two acrylic optical elements. This is a revolutionary design.

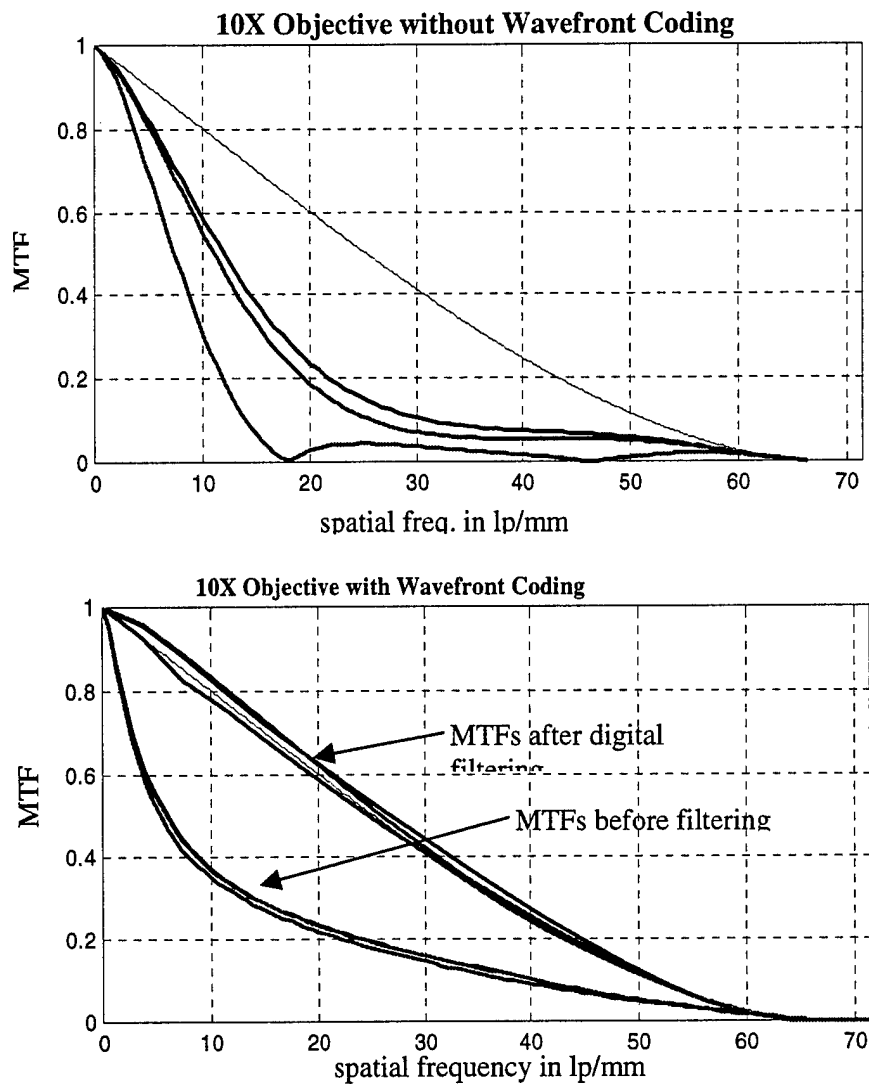

Figure 6: MTFs of simple 10X objective with and without Wavefront Coding. The top graph represents the MTFs without Wavefront Coding as a function of field angle. While the MTF is diffraction-limited for on-axis imaging, performance is severely degraded for off-axis imaging. The bottom graph represents the MTFs with Wavefront Coding. Before filtering the MTFs are seen to have little variation with field angle. After filtering the MTFs for all field angles are nearly identical to the ideal diffraction-limited MTF. Pixel MTFs are included in both graphs.

Goal #3 Evaluation of Wavefront Coded Imaging with Real Systems As part of the Phase I effort we modified a Zeiss biological research-grade microscope for Wavefront Coding and produced a series of measurements and images. The measured MTFs and PSFs as a function of misfocus clearly showed vast improvements in depth of field through Wavefront Coding. The images produced gave dramatic proof of the benefits of Wavefront Coding for extended depth of field microscopy applications.

We modified the Zeiss microscope by placing a cubic-phase Wavefront Coding optical element near the back of the microscope objective. The Zeiss microscope has a slot in the housing above the objective intended for differential interference contrast (DIC) optical elements. Using this slot for the Wavefront Coding optical element made the modifications of the microscope relatively simple and mechanically accurate.

Measurements of the MTFs of the system with a 40X, NA=1.3 oil immersion objective with a 2.5X eyepiece (for a total magnification of 100X) are shown in figure 7. Without wavefront coding the system has a depth of field of less than 1 micron. With Wavefront Coding the depth of field was increased to over 10 microns. From figure 7 the MTFs from the traditional system vary greatly with misfocus. (MTFs were taken in 2 micron stage increments) The Wavefront Coded MTFs before filtering show very little variation with misfocus, and after filtering produce MTFs that are very similar to the in-focus MTF from the traditional system.

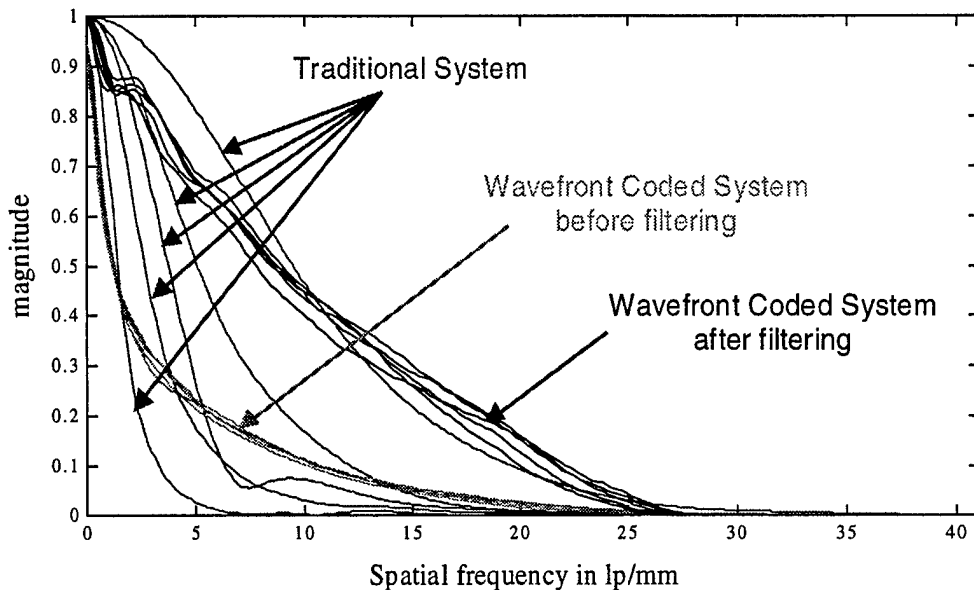

Figure 7: MTFs from Zeiss 100X, NA=1.3 oil immersion microscope system with and without Wavefront Coding. The MTFs from the traditional system are seen to vary greatly with misfocus. MTFs are measured in 2 micron stage increments. The MTFs of the Wavefront Coding system are nearly constant over the same misfocus range. After filtering, the MTFs are again nearly constant and very similar to the in-focus MTF from the traditional imaging system.

Examples of imaging with the 100X system are shown in figures 8 and 9. In figure 8, the object is a leaf with water bubbles. The distance from the surface of the leaf to the top of some of the bubbles exceeds 20 microns. The traditional system image can only clearly image the surface of the leaf. The surface of the bubbles are all well beyond the depth of field of the traditional system. The Wavefront Coding image in

contrast clearly images the surface of the leaf and the entire bubbles. The depth of field is large enough that perspective can be seen in the Wavefront Coded image.

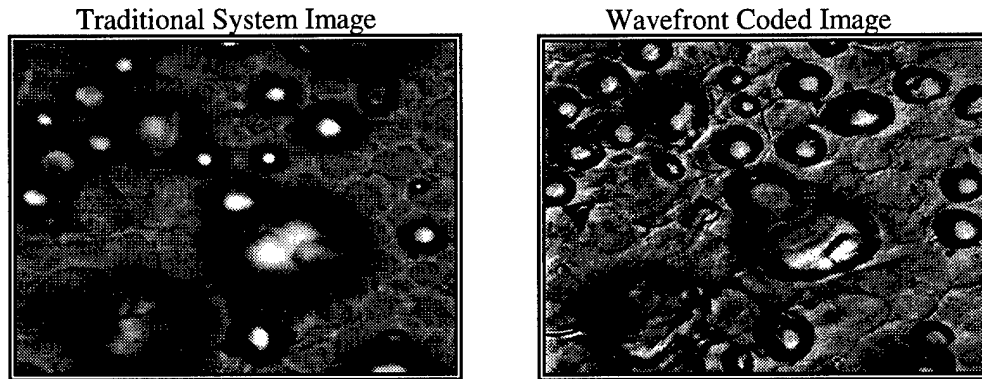

Figure 8: Example 100X, NA=1.3 Zeiss microscope with and without Wavefront Coding. The object is a leaf with bubbles. The distance from the surface of the leaf to the top of some of the bubbles exceeds 20 microns. The image on the left is from the traditional system. Only the surface of the leaf is clearly in focus. The image on the right is from the Wavefront Coded system. The surface of the leaf as well as all the bubbles are clearly imaged. The depth of field is so great that perspective is even seen.

In figure 9 the main objects are water conducting tubes (tracheids) of a leaf. The tracheids have a helical coil that surround the tube. The depth of the coils is large enough that they cannot be imaged clearly with the traditional system. The Wavefront Coded system can clearly image all the coils with resolution at least as high as the traditional, focused system.

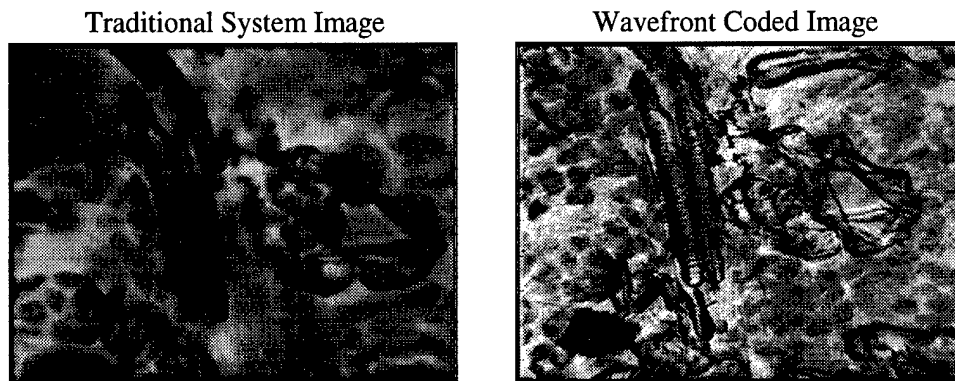

Figure 9: Example 100X, NA=1.3 Zeiss microscope with and without Wavefront Coding. The main object is a water conducting tubes (tracheids) of an ivy leaf. The image on the left is from the traditional system. The traditional system does not have a large enough depth of field to image the helical coils of these cells. The image on the right is from the Wavefront Coding system. This image is seen to clearly resolve the helical coils of the tracheids as well as sharply image nearly all objects in the scene.

Goal #4 Evaluation of Real-Time Processing DSP for Wavefront Coding Many Wavefront Coding systems require real-time processing. As part of the Phase I effort we considered the processing speed and complexity of DSP implementations for real-time Wavefront Coding processing. We specifically

considered the Texas Instruments TMS64C6X series of microprocessors. Early level programming and algorithm design was performed on a development TI board.

The TI C6X series of microprocessors has an advertised speed of 3 billion multiply and accumulates per second when operating on data stored in memory internal to the processor itself. For small image sizes and compact digital filters, this speed should be sufficient for real time processing. It was determined, however, that Wavefront Coding digital filtering requires external memory that would greatly degrade actual processing speeds. Realized processing speeds could degrade by a factor of 10. The amount of internal memory of the TI chip is low and so a processing algorithm design to minimize memory was required. For large image sizes or large filter sizes (greater than 32 1D taps) the algorithm requirements are such that real-time processing is not possible with the TI series 'C6x' device.

### **Feasibility of Phase II Based on Phase I Effort**

Based on the Phase I effort, future work should include: 1) development of an general high magnification Wavefront Coded microscope working with a variety of objectives and illumination methods, 2) design of real-time Wavefront Coded processors for high-magnification for live-cell microscopy and high-speed manufacturing/inspection systems, and 3) the design of optical systems representative of next-generation microscope optics.

A microscope retrofit system for Wavefront Coding has been proven on a Zeiss biological microscope working at the limits of optical microscopy. This system has very high magnification (100X) and the largest spatial resolution available, with a numerical aperture (NA) of 1.3. Results from this system indicates that retrofits for other types of microscopes and objectives are feasible.

The first-generation optical phase elements for Wavefront Coding were proven to give a high degree of performance. New Wavefront Coded optical designs should further increase performance of the system by reducing the amount of computation required. Optical designs for simplified objectives done during Phase I also indicate that Wavefront Coding can also be used to greatly simplify the complexity of microscope objectives, thus lowering the overall cost for a number of applications.

Real-time Wavefront Coded (WFC) image production for large-format microscope applications requires over ten billion multiply-adds per second. The minimum data rate for modest sized microscope images is approximately 1k x 1k pixels per frame at 10 frames per second, or 10Meg pixels per second. In general, the maximum length of a PSF for a WFC biological system is 32 pixels in either spatial dimension. Such a system will require a large filter kernel that would contain 32 x 32 elements, or 1024 = 1k coefficients. This system requires 1k computations per pixel, with 10M pixels per second, or 10 billion multiply-adds (MACs) per second.

Some Wavefront Coded optical systems can be processed in a separable fashion, where the columns of the image are filtered independently of the rows. Such filtering is more efficient mathematically than two-dimensional, or non-separable, spatial filtering. A rectangularly separable design similar to that described above would contain  $32+32=64$  coefficients and require 640 million MACs per second. Based on the results from the Phase I effort, both an FPGA-based solution and a DSP-based solution are proposed for implementing WFC processing. The processing must also be scalable, as future WFC microscope systems for biological and medical use can approach 4k x 4k sensors operating at 25 frames per second.

Real-time stand-alone Wavefront Coded processors for two-dimensional filtering can be produced efficiently using current state-of-the-art silicon-based processing hardware. Hardware processing for high-quality image rendering is practical due to the high parallelism offered in Field Programmable Gate Array (FPGA) devices currently available. The Virtex-E and Virtex-EM family of chips from Xilinx, Inc.

are examples of capable FPGA devices. In contrast, the separable designs may be processed on cheaper digital signal processing (DSP) chips currently available today, provided the data throughput can be achieved (data throughput was the limiting case with the TI 'C6x investigated in Phase I). An important distinction is that DSPs are sequential machines, capable of doing one task at a time. Even though several data entries may be processed simultaneously on a DSP, the instructions are executed sequentially. FPGAs offer parallel instruction implementation with multiple data entries, a huge advantage for non-separable Wavefront Coded processors. The FPGA solution is considered a hardware solution for non-separable processing, and the DSP is a software solution for separable processing.