

Col Gibbs

NACA TN No. 1767

NATIONAL ADVISORY COMMITTEE FOR AERONAUTICS

TECHNICAL NOTE

No. 1767

THE APPLICATION OF GREEN'S THEOREM TO THE SOLUTION
OF BOUNDARY-VALUE PROBLEMS IN LINEARIZED
SUPERSONIC WING THEORY

By Max. A. Heaslet and Harvard Lomax

Ames Aeronautical Laboratory
Moffett Field, Calif.

DISTRIBUTION STATEMENT A
Approved for Public Release
Distribution Unlimited



Washington

April 1949

Reproduced From
Best Available Copy

20000807 168

DTIC QUALITY INSPECTED 4

AGM 00-11-3608

NATIONAL ADVISORY COMMITTEE FOR AERONAUTICS

TECHNICAL NOTE NO. 1767

THE APPLICATION OF GREEN'S THEOREM TO THE SOLUTION
OF BOUNDARY-VALUE PROBLEMS IN LINEARIZED
SUPERSONIC WING THEORY¹

By Max. A. Heaslet and Harvard Lomax

SUMMARY

Following the introduction of the linearized partial differential equation for nonsteady three-dimensional compressible flow, general methods of solution are given for the two- and three-dimensional steady-state and two-dimensional unsteady-state equations. It is also pointed out that, in the absence of thickness effects, linear theory yields solutions consistent with the assumptions made when applied to lifting-surface problems for swept-back plan forms at sonic speeds. The solutions of the particular equations are determined in all cases by means of Green's theorem and thus depend on the use of Green's equivalent layer of sources, sinks, and doublets. Improper integrals in the supersonic theory are treated by means of Hadamard's "finite part" technique.

Four applications of the general solutions are given: First, the angle-of-attack load distribution for a supersonic, yawed, triangular plate with subsonic leading edges is determined. Second, downwash is calculated along the center line in the plane of the unyawed triangular wing. Third, the growth of load distribution is presented for subsonic and supersonic two-dimensional flat plates either starting from rest at a uniform velocity or experiencing an abrupt angle-of-attack change. The transient effects on lift-curve slope are then calculated. Finally, the load distribution and lift-curve slope of a specific swept-back lifting surface are determined at a free-stream Mach number of one.

¹Presented by Dr. Heaslet at the VII International Congress of Applied Mechanics, September 1948, London.

INTRODUCTION

If the effects of viscosity are assumed small and shock-free compressible flow is considered, the velocity field about a two- or three-dimensional body placed in a uniform free stream is irrotational and thus possesses a velocity potential. In the determination of the pressures exerted on such a body or in the calculation of the induced velocity components, the theoretical aerodynamicist is concerned essentially with finding the velocity potential of the flow field and, thus, must determine the solution of a second-order nonlinear partial differential equation subject to certain boundary conditions. The known mathematical difficulties that arise in the treatment of such a problem make it expedient to resort to simplifying assumptions. In applied aerodynamics, however, efficiency of flight at high speeds has focused attention on bodies inducing relatively small velocities throughout the field of flow and, as a consequence, the demands of engineering furnish a guide for the mathematical simplification of the theory. The so-called linearized theory of compressible flow was developed to solve such problems and, although considerable work of a more precise nature has been presented in two dimensions, a large amount of investigation in unsteady flight and in three-dimensional wing theory remains to be completed within the framework of the simplifying conditions.

The present paper is restricted to a discussion of wing theory subject to the assumptions of linearized compressible flow. It therefore employs solutions of Laplace's equation and the wave equation for cases where the boundary conditions are specified in the plane of the wing. Attention will be directed primarily to the analysis of steady-state conditions although an equivalence will be established between the two-dimensional differential equation containing the time variable and the equation applying to three-dimensional supersonic wing theory. Solutions in all cases will be obtained through the use of Green's theorem and the resultant concept of Green's equivalent layer of sources, sinks, and doublets. The correspondence between the theoretical development for subsonic and supersonic speeds is particularly useful since experience related to analysis in either flight regime is more readily transferred.

In view of the widespread use of sources, sinks, and doublets in low-speed studies and the fact that the earlier applications to supersonic wing theory by Prandtl (reference 1) and Schlichting (reference 2) corresponded to the use of Green's equivalent layer, it is notable that later emphasis has shifted to other methods of solution. Sources alone were used by Puckett (reference 3) to create symmetrical nonlifting wings and were also applied to the study of

lifting triangular wings with supersonic leading edges, but the use of source, sink, and doublet sheets has not been as extensive as might have been expected. This anomaly is even more apparent in view of the vast mathematical and physical literature centering around the use of Green's theorem. One possible explanation may stem from the fact that the interest of the mathematician and physicist in the wave equation has arisen in connection with problems in acoustics, optics, and vibrating membranes. Such problems introduce boundary conditions of the Cauchy type, that is, initial conditions need to be known both for the unknown function and its rate of change. The supporting surface for such boundary conditions cuts the characteristic cone of an arbitrary point in a closed curve and has been called by Hadamard (reference 4) a duly inclined surface. In aerodynamics the supporting surface is nonduly inclined and cuts the characteristic surface or Mach cone along the arc of a hyperbola and, as a result, the problem is no longer of the Cauchy type and the analysis becomes similar to that used in subsonic theory in the solution of Laplace's equation. Prior to the interest of the theoretical aerodynamicist in supersonic wing theory, it appears that little attention in application was paid to this type of solution.

The material presented here is divided into two main divisions: Analysis and Applications. In the first part of the Analysis division, the linearized differential equation for nonsteady compressible flow is given together with the underlying assumptions made. Specific forms of this equation for two- and three-dimensional steady states and two-dimensional unsteady states are then considered. It is pointed out in particular that for swept-back lifting surfaces linearized theory yields consistent solutions at a free-stream Mach number of one although the analysis of arbitrary thickness distributions is not possible. Following the various equations, Green's theorem is applied to find, in terms of the known boundary conditions, the desired solution by means of source and doublet distributions.

Applications of the general methods are confined to four problems. As an example of the manner in which angle-of-attack load distributions are determined for a lifting flat plate, the case of a yawed triangular wing with subsonic leading edges is solved. Doublet distributions are then applied in the second problem to the calculation of downwash behind the same wing in an unyawed position. Third, the growth of load distribution with time is derived for a supersonic two-dimensional flat plate either experiencing a sudden sinking motion or starting from rest at a uniform velocity. Such distributions are of value in the calculation of indicial lift functions and can be used, together with Duhamel's integral, in the study of certain dynamic maneuvers. The final application considers at a Mach number equal to one the case

of a swept-back lifting surface with tips normal to the free-stream direction.

All important symbols are defined in the appendix.

ANALYSIS

The Partial Differential Equations

Basic differential equation.— Consider an aerodynamic body flying at an arbitrary Mach number M_0 in air initially at rest. If a Cartesian coordinate system x, y, z is fixed relative to the body, the body may then be assumed stationary and situated in a free stream with the same Mach number. If the free-stream velocity vector is parallel to and in the direction of the position x axis and if ϕ denotes the perturbation velocity potential for isentropic flow, the linearized partial differential equation for ϕ may be written in the form

$$(M_0^2 - 1) \phi_{xx} - \phi_{yy} - \phi_{zz} + \frac{1}{a_0^2} \phi_{tt} + \frac{2M_0}{a_0} \phi_{xt} = 0 \quad (1)$$

where a_0 is the velocity of sound in the free stream and t denotes time.

The assumptions underlying the derivation of equation (1) have been stated in numerous places but are not always obviously compatible. It is assumed here that the ratios $\frac{u}{V_0}, \frac{v}{V_0}, \frac{w}{V_0}$ are small compared to one, where u, v, w are induced velocity components and V_0 is the velocity of the free stream; moreover,

$$\frac{\gamma - 1}{2} M_0^2 \left(\frac{2u}{V_0} + \frac{u^2 + v^2 + w^2}{V_0^2} \right) \ll 1$$

and, finally, the velocity gradients at a given point of the flow field are all of similar magnitude.

Special cases.— The particular forms of equation (1) to be considered are given in table I. In the steady-state equations the original independent variables are retained; the two-dimensional unsteady-state equation has, however, new variables defined by the relations

$$x' = x - a_0 M_0 t, \quad z' = z, \quad t' = a_0 t \quad (2)$$

and consequently the boundary conditions for any particular example will be subject to the same transformation. In all the equations the constraints imposed by the linearization permit, for problems in wing theory, the boundary conditions to be specified in the plane of the wing. This plane shall arbitrarily be taken to be $z=0$.

TABLE I.- LINEARIZED PARTIAL DIFFERENTIAL EQUATIONS OF COMPRESSIBLE FLOW

Steady State		
Two Dimensions	$\left\{ \begin{array}{l} (1-M_0^2) \phi_{xx} + \phi_{zz} = 0, \quad M_0 < 1, \\ (M_0^2-1) \phi_{xx} - \phi_{zz} = 0, \quad M_0 > 1, \end{array} \right.$	(A)
		(B)
Three Dimensions	$\left\{ \begin{array}{l} (1-M_0^2) \phi_{xx} + \phi_{yy} + \phi_{zz} = 0, \quad M_0 < 1, \\ (M_0^2-1) \phi_{xx} - \phi_{yy} - \phi_{zz} = 0, \quad M_0 > 1, \\ \phi_{yy} + \phi_{zz} = 0 \quad \quad \quad \quad \quad \quad \quad M_0 = 1, \end{array} \right.$	(C)
		(D)
		(E)
Unsteady State		
Two Dimensions	$\phi_{t't'} - \phi_{x'x'} - \phi_{z'z'} = 0$	(F)

The Mach number range for which the equations are valid cannot be prescribed a priori since induced velocities are functions of wing geometry and angle of attack. We can say, however, that for certain configurations at small angles of attack the equations and their solutions are consistent with the assumptions. In particular, three-dimensional lifting surfaces with sufficient sweepback yield solutions of this class at $M_0=1$. The differential equation shows that in this case the boundary conditions need only be specified along strips in the transverse direction. The surfaces of the Mach cones also are normal to the free-stream direction so that any disturbance point makes itself felt at all points not upstream of it. Since for these

lifting surfaces the disturbances do not become excessive at $M_0=1$, we have a specific kind of lateral strip theory that yields formal solutions compatible with the assumptions made.

Boundary Conditions

Steady state.— The boundary conditions are given in the $z=0$ plane and in the case of two-dimensional theory the wing is assumed to extend infinitely, parallel to the y axis. As a convenience in notation, two subscripts will be introduced: the first, u , denotes conditions on the upper surface of the wing, that is, the limit of the function as z approaches zero through positive values; the second, l , denotes conditions on the lower surface of the wing, that is, the limit of the function as z approaches zero through negative values.

Four types of boundary conditions arise in practice:

1. Symmetrical nonlifting wing (boundary-value problem of the first kind).— The conditions $w_u = w_l = 0$ hold over all of the xy plane except for the region occupied by the wing. On the wing, the relations $2w_u = -2w_l = \Delta w_0 = f(x,y)$ are given, the function $f(x,y)$ being determined by the geometry of the configuration. Over all of the xy plane, $\Delta u_0 = u_u - u_l = 0$ applies.
2. Lifting surface with specified loading (boundary value problem of the first kind).— The condition $\Delta u_0 = u_u - u_l = 0$ holds over the xy plane except for the region occupied by the wing. On the wing, the relations $2u_u = -2u_l = \Delta u_0 = f(x,y)$ are given, the function $f(x,y)$ being determined by the specified loading. Over all of the xy plane, $\Delta w_0 = 0$ applies.
3. Lifting surface with specified camber and angle of attack (boundary-value problem of the second kind).— The condition $\Delta u_0 = 0$ holds over the xy plane except for the region occupied by the wing. On the wing the relation $w = f(x,y)$ is given, the function $f(x,y)$ being determined by the given camber, twist, and angle of incidence. Over all of the xy plane, $\Delta w_0 = 0$ applies.
4. Symmetrical wing with specified pressure distribution (boundary-value problem of the second kind).— The

condition $\Delta w_0 = 0$ holds over all of the xy plane except for the region occupied by the wing. On the wing the relation $u = f(x,y)$ is given, the function $f(x,y)$ being determined by the specified pressure distribution. Over all of the xy plane, $\Delta u_0 = 0$ applies.

In all cases, induced velocity u is related to pressure coefficient C_p by the relation

$$C_p = -\frac{2u}{V_0}$$

Unsteady state.— The steady-state boundary conditions have been given in the most general terms possible. The unsteady-state conditions will be limited to a more restricted type of problem, namely, cases wherein the airfoil is assumed to experience at $t=0$ either an abrupt change in angle of attack without pitching or starts to travel at the instantaneous velocity V_0 and angle of attack α . In this way the transient variation of load distribution and airfoil characteristics can be calculated for unit angle-of-attack change. Similar methods can treat unit rate of pitching, or deflection of aileron, as well as the effects produced when the airfoil enters a gust of given structure. The use of solutions of such problems in connection with operational methods is well known in applied mathematics. Applications of these operational methods to aerodynamics have been given by R. T. Jones (references 5 and 6) for incompressible fluid theory and by Heaslet and Lomax (reference 7) for supersonic flow.

If the rectangular coordinate system x', z', t' associated with equation (2) is considered to be fixed, the airfoil moves in the negative x' direction and the free-stream velocity is zero. A simple distortion of the time axis is also introduced to simplify the differential equation. Figures 1(a) and 1(b) aid in the visualization of the

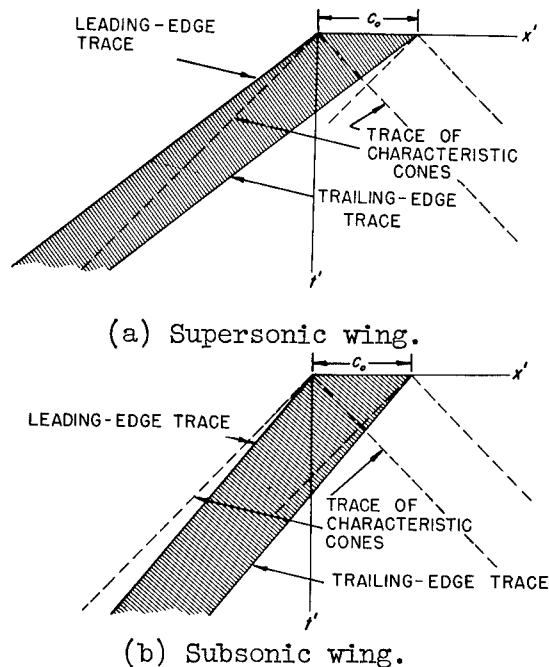

Figure 1.— Diagram for use in determining boundary conditions in two-dimensional unsteady motion.

problems involved. The airfoil section is assumed to lie initially on the x' axis with leading edge at the origin and trailing edge at the point $x' = c_0$. As time progresses the airfoil sweeps across a portion of the $x't'$ plane, the leading edge traversing the line $x' = -M_0 t'$ while the trace of the trailing edge is the line $x' = c_0 - M_0 t'$. The region bounded by these lines and the line $t' = 0$ is that swept by the airfoil. The characteristic cones of the differential equation cut the $x't'$ plane along lines inclined at $\pm 45^\circ$ to either axis. If the airfoil experiences an angle-of-attack change α without pitching, the "area" swept over by the wing must yield $w = -V_0 \alpha$. On the other hand, if the airfoil enters a gust of constant vertical velocity w_0 , the region over which the modification of w is effective is restricted to the region occupied simultaneously by the airfoil and the gust. If, for example, the edge of the gust is fixed along the t' axis, this axis will form the right-hand boundary of the region over which the change in boundary conditions occurs. A statement of these boundary conditions may be put in the following form:

1. Lifting surface undergoing abrupt change or starting from rest with given velocity.— The condition $\Delta u_0 = 0$ holds over all of the $x't'$ plane except for the region swept across by the airfoil. In this latter region, the relation $w = f(x', t')$ is given, the function $f(x', t')$ being determined by the modification in airfoil angle of attack, pitching velocity, aileron deflection, or by the gust structure. Over all of the $x't'$ plane, $\Delta w_0 = 0$ applies.

The expression for pressure coefficient is

$$c_p = \frac{-2}{V_0^2} \left(\frac{\partial \phi}{\partial t'} + V_0 \frac{\partial \phi}{\partial x'} \right)$$

$$= \frac{-2}{V_0 M_0} \frac{\partial \phi}{\partial t'}$$

Solution of Boundary-Value Problems

General treatment.— The use of Green's theorem in the solution of second-order partial differential equations leads one to the consideration of certain particular solutions of the given equations.

Because of the physical importance as well as the mathematical applicability, attention has been centered on the use of a so-called fundamental solution or source potential. Thus, in the subsonic case, the potential at the point x, z of a unit source located at the point ξ, ζ and applicable to equation (A), table I, is the logarithmic function

$$\varphi(x, z) = \frac{1}{2\pi} \ln r_A = \frac{1}{2\pi} \ln \sqrt{(x-\xi)^2 + \beta^2(z-\zeta)^2} \quad (3)$$

while for equation (C) the potential at x, y, z of the unit source at ξ, η, ζ is

$$\varphi(x, y, z) = \frac{-1}{4\pi r_C} = \frac{-1}{4\pi \sqrt{(x-\xi)^2 + \beta^2[(y-\eta)^2 + (z-\zeta)^2]}} \quad (4)$$

Here and elsewhere we have $\beta^2 = |1-M_0^2|$ where the bars indicate that absolute values are to be taken.

The application of these potential functions to the solution of boundary-value problems in subsonic linearized flow is well known. Supersonic theory, however, introduces added complications when the fundamental solutions are considered and, although methods have been established, the mathematical techniques are of comparatively recent origin. The principal difficulty lies in the integration of higher-ordered singularities that appear in the three-dimensional analysis. Hadamard (reference 4) resolved these difficulties and thus avoided the more specialized approach of Volterra (reference 8). It would appear, however, that a more direct method of derivation stems from Marcel Riesz's use of fractional integration. (See, in this connection, references 9 and 10.) The oddness or evenness of the number of dimensions still involves considerable differences but the final solutions are easily applied.

In two-dimensional supersonic flow, the potential at the point x, z of a unit source located at the point ξ, ζ is defined as follows:

$$\begin{aligned} \varphi(x, z) &= 0 \text{ for } (x-\xi)^2 < \beta^2(z-\zeta)^2 \\ \varphi(x, z) &= -\frac{1}{2\beta} \text{ for } (x-\xi)^2 \geq \beta^2(z-\zeta)^2 \end{aligned} \quad (5)$$

In three dimensions, the source potential is

$$\varphi(x, y, z) = \frac{-1}{2\pi r_D} = \frac{-1}{2\pi \sqrt{(x-\xi)^2 - \beta^2 [(y-\eta)^2 + (z-\zeta)^2]}} \quad (6)$$

at all points for which the radical is real and is zero elsewhere.

These functions are directly applicable to equations (B) and (D) of table I. Equations (E) and (F) are, of course, special mathematical cases of equations (A) and (D) for which M_0 is 0 and $\sqrt{2}$, respectively.

By means of the various source potentials, it is now possible to present solutions of the differential equations in terms of the prescribed boundary conditions. These conditions are assumed to be given in the $z=0$ plane and subscripts u and l shall again denote conditions at $z=0+$ and $z=0-$, respectively. The general solutions appear as follows:

Equation (A), $M_0 < 1$,

$$\varphi(x, z) = \frac{1}{2\pi\beta} \int_{-\infty}^{\infty} \left[\ln(r_A)_{\zeta=0} \left(\frac{\partial\varphi_u}{\partial z} - \frac{\partial\varphi_l}{\partial z} \right) - (\varphi_u - \varphi_l) \left(\frac{\partial}{\partial\zeta} \ln r_A \right)_{\zeta=0} \right] d\xi \quad (7)$$

Equation (B), $M_0 > 1$

$$\begin{aligned} \varphi(x, z) &= -\frac{1}{\beta} \int_{-\infty}^{x-\beta z} \frac{\partial\varphi_u}{\partial z} d\xi \quad \text{for } z > 0 \\ &= -\frac{1}{\beta} \int_{-\infty}^{x+\beta z} \frac{\partial\varphi_l}{\partial x} d\xi \quad \text{for } z < 0 \end{aligned} \quad (8)$$

Equation (C), $M_0 < 1$

$$\varphi(x, y, z) = \frac{-1}{4\pi} \int_{-\infty}^{\infty} \int_{-\infty}^{\infty} \left[\left(\frac{1}{r_C} \right)_{\zeta=0} \left(\frac{\partial\varphi_u}{\partial z} - \frac{\partial\varphi_l}{\partial z} \right) - (\varphi_u - \varphi_l) \left(\frac{\partial}{\partial\zeta} \frac{1}{r_C} \right)_{\zeta=0} \right] d\xi d\eta \quad (9)$$

Equation (D), $M_0 > 1$

$$\varphi(x, y, z) = -\frac{1}{2\pi} \int_{\tau} \int \left[\left(\frac{1}{r_D} \right)_{\zeta=0} \left(\frac{\partial \varphi_u}{\partial z} - \frac{\partial \varphi_l}{\partial z} \right) - (\varphi_u - \varphi_l) \left(\frac{\partial}{\partial \zeta} \frac{1}{r_D} \right)_{\zeta=0} \right] d\xi d\eta \quad (10)$$

In the last equation, the range of integration is confined to that portion of the $z=0$ plane that lies within the Mach forecone of the point x, y, z , that is, within the half-portion of the right circular cone

$$(x-\xi)^2 - \beta^2 [(y-\eta)^2 + (z-\zeta)^2] = 0$$

lying upstream of the point x, y, z . The semivertex angle μ of this cone is the Mach angle and is given by the relation

$$\mu = \arcsin \frac{1}{M_0} = \arccot \beta$$

The symbol $\int_a^{x_0}$ was introduced by Hadamard and denotes the "finite part" of the integral. As in the case of Cauchy's principal value, an improper integral is reduced by a prescribed technique to a finite and unique value. By definition (see also reference 11),

$$\int_a^{x_0} \frac{A(x) dx}{(x_0-x)^{3/2}} = \int_a^{x_0} \frac{A(x)-A(x_0)}{(x_0-x)^{3/2}} dx - \frac{2A(x_0)}{(x_0-a)^{1/2}} \quad (11)$$

In the two-dimensional supersonic case, the solution for the velocity potential is expressed as the integral of a distribution of source potentials. In all other cases, both the source potential and its derivative appear in the integrand, this latter expression being identified with the doublet potential.

Nonlifting case (symmetrical wing, boundary-value problem of the first kind.— Equations (7), (8), (9), and (10) are applicable directly to the calculation of the potential function corresponding to a

symmetrical wing. The relation $\phi_u = \phi_l$ follows from the condition $w_u = w_l$. Moreover, if $\frac{dz_u}{dx}$ denotes the local slope of the upper surface of the wing,

$$\frac{1}{V_0} \frac{\partial \phi_u}{\partial z} = - \frac{1}{V_0} \frac{\partial \phi_l}{\partial z} = \left(\frac{dz_u}{dx} \right)$$

and the solutions of the various equations are expressed in terms of source distributions alone.

For example, equation (10) becomes

$$\phi(x, y, z) = - \frac{V_0}{\pi} \int_{\tau} \int \frac{dz_u}{dx} \frac{d\xi d\eta}{\sqrt{(x-\xi)^2 - \beta^2 [(y-\eta)^2 + z^2]}} \quad (12)$$

where the finite part sign is dropped since the integral is proper. This equation was given by Puckett in reference 3.

The pressure coefficient on the surface of the wing is

$$C_p = - \frac{2}{V_0} \left(\frac{\partial \phi}{\partial x} \right)_{z=0}$$

Lifting case (boundary-value problem of the first kind).— From the condition $w_u = w_l$ we have $\Delta w_0 = 0$ and the integrands in equations (7), (9), and (10) are expressed solely in terms of doublet distributions, while equation (8) yields the result that conditions on either side of the wing have no effect on the other side.

Taking equation (10) as an example, the solution under the prescribed conditions is

$$\phi(x, y, z) = - \frac{1}{2\pi} \int_{\tau} \int (\phi_u - \phi_l) \frac{\beta^2 z d\xi d\eta}{\left\{ (x-\xi)^2 - \beta^2 [(y-\eta)^2 + z^2] \right\}^{3/2}} \quad (13)$$

where

$$\phi_u - \phi_z = \int_{-\infty}^x \Delta u_0(\xi, \eta) d\xi$$

A more direct evaluation of perturbation velocity u can be obtained from the alternate expression

$$u = -\frac{1}{2\pi} \int_{\tau} \int \frac{\Delta u_0(\xi, \eta) \beta^2 z \, d\xi \, d\eta}{\left\{ (x-\xi)^2 - \beta^2 [(y-\eta)^2 + z^2] \right\}^{3/2}} \quad (14)$$

Similar expressions exist for equations (7) and (9).

Lifting case (boundary-value problem of the second kind).— This type of boundary condition cannot be solved directly by means of the formulas which have been presented but resolves always into the required solution of an integral equation. In three-dimensional subsonic wing theory, the method of solution depends usually on some modification of Prandtl's lifting-line theory although, more recently, lifting-surface theories by Falkner (reference 12) and Cohen (reference 13) have been applied successfully.

In the case of three-dimensional supersonic-wing theory, sources, sinks, and doublets have been utilized in two ways in the solution of lifting-surface problems. The first of these methods was given by Evvard (references 14 and 15) and is particularly powerful when one of the leading edges of the wing is of the supersonic type, that is, when the velocity component of the free stream normal to the edge is greater than the speed of sound. A second method of solution was presented in reference 16 for the important case of wings with subsonic leading edges, provided the flow field about the wing is of the conical type introduced by Busemann (reference 17). The essential feature of this method is the use of differential lifting elements carrying a constant load and designed for use in conical flow fields. The solution consists of determining the distribution of loading over these elements so that the resultant induced vertical velocity at any point on the lifting surface satisfies the local boundary condition. When approached from this standpoint, the problem again requires the solution of an integral equation but the equation is of the form

$$w(x) = \int_a^b \frac{f(x_1) dx_1}{x_1 - x} \quad (15)$$

and is thus well known from low-speed airfoil-section theory. Inversions of this equation have been provided by Allen (reference 18) and von Mises and Friedrichs (reference 19).

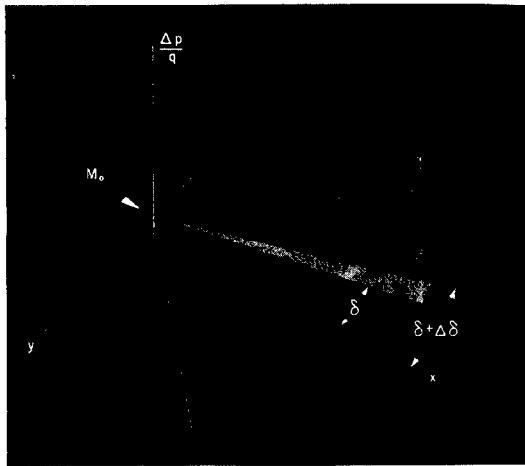

Figure 2 shows the elemental lifting surface to be used. The sides of the element extend back from the tip of the Mach cone, making angles δ and $\delta+\Delta\delta$ with the positive x axis or free-stream direction. The vertical velocity induced at the point $x, y, 0$ by the element will be a function of δ , $\Delta\delta$, and $\frac{y}{x}$ or, changing the notation, θ , $\Delta\theta$,

Figure 2.— Lifting surface element carrying constant load.

and ω where

$$\theta = \beta \tan \delta$$

$$\theta + \Delta\theta = \beta \tan (\delta + \Delta\delta)$$

$$\omega = \beta \frac{y}{x}$$

Denoting the gradient of this vertical velocity with respect to θ by $\frac{\partial w_{z=0}}{\partial \theta}$, it follows that

$$\frac{\partial w_{z=0}}{\partial \theta} = \lim_{\Delta\theta \rightarrow 0} \frac{w(\theta + \Delta\theta, \omega) - w(\theta, \omega)}{\Delta\theta}$$

where $w(\theta, \omega)$ and $w(\theta + \Delta\theta, \omega)$ are the velocities induced by right-triangular lifting surfaces with constant loading and with vertex angles equal to δ and $\delta + \Delta\delta$, respectively. The velocities induced by the constantly loaded surface are determined directly from equation (13). The results of these calculations yield the following expressions:

For $\omega < \theta$

$$\frac{\partial w_{z=0}}{\partial \theta} = - \frac{C\beta}{2\pi V_0} \int_{-1}^{\omega} \frac{\sqrt{1-\omega_1^2}}{\omega_1(\omega_1-\theta)^2} d\omega_1 \quad (16a)$$

and for $\omega > \theta$

$$\frac{\partial w_{z=0}}{\partial \theta} = - \frac{C\beta}{2\pi V_0} \int_1^{\omega} \frac{\sqrt{1-\omega_1^2}}{\omega_1(\omega_1-\theta)^2} d\omega_1 \quad (16b)$$

where

$$C = \frac{V_0^2}{2} \frac{\Delta p}{q}$$

The term $\frac{\Delta p}{q}$ is the load coefficient and is equal to the difference between pressure coefficients on the lower and upper surface of the wing,

$$\frac{\Delta p}{q} = \frac{p_l - p_u}{q} = C_{p_l} - C_{p_u}$$

Nonlifting case (boundary-value problem of the second kind).— In the previously discussed lifting case, the induced vertical-velocity field of a constantly loaded element was calculated. An analogous type of element can also be developed for use in the determination of nonlifting wings with prescribed pressure distributions. It is apparent that differential expressions similar to equations (16a) and (16b) must be derived which establish the induced field of the x component of perturbation velocity for a conical-flow element with constant vertical velocity. From equation (12), the following expressions result:

For $\omega < \theta$

$$\frac{\partial C_p}{\partial \theta} = \frac{2\lambda}{\beta\pi} \int_{-1}^{\omega} \frac{\omega_1 d\omega_1}{(\omega_1-\theta)^2 \sqrt{1-\omega_1^2}} \quad (17a)$$

and for $\omega > \theta$

$$\frac{\partial C_p}{\partial \theta} = \frac{2\lambda}{\beta\pi} \int_1^\omega \frac{\omega_1 d\omega_1}{(\omega_1 - \theta)^2 \sqrt{1 - \omega_1^2}} \quad (17b)$$

where pressure coefficient C_p and surface slope λ are

$$C_p = -\frac{2u}{V_0}, \quad \lambda = \frac{w_0}{V_0}$$

The application of equations (17a) and (17b) to the determination of a thickness distribution supporting a given pressure distribution consists of determining λ as a function of θ such that the desired pressure results. The essential simplification of the method is brought about by the use of elements which lead to single integral equations of standard form.

APPLICATIONS

Yawed Triangular Lifting Surface

Consider a yawed, triangular flat plate with subsonic leading edges such as is indicated in figure 3. Relative to the x axis or free-stream direction, the sides of the triangle make the angles δ_0 and δ_1 so that the total vertex angle is $\delta_0 + \delta_1 = 2\Delta$. The quantities θ_0 , θ_1 , and ω are also introduced where

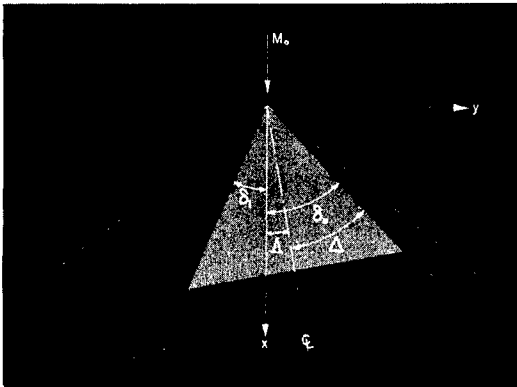

$$\theta_0 = \beta \tan \delta_0$$

$$\theta_1 = \beta \tan \delta_1$$

$$\omega = \beta \frac{y}{x}$$

Figure 3.- Yawed triangular flat-plate lifting surface with subsonic leading edges.

The vertical induced velocity at any point on the wing can be found from equations (16a) and (16b), provided the distribution of the loading factor C is known. Setting $C=C(\theta)$, the downwash is given by the expression:

$$w_{z=0} = -\frac{\beta}{2\pi V_0} \left[\int_{-\theta_0}^{\omega} C(\theta) d\theta \int_1^{\omega} \frac{\sqrt{1-\omega_1^2}}{\omega_1(\omega_1-\theta)^2} d\omega_1 + \int_{\omega}^{\theta_1} C(\theta) d\theta \int_{-1}^{\omega} \frac{\sqrt{1-\omega_1^2}}{\omega_1(\omega_1-\theta)^2} d\omega_1 \right] \quad (18)$$

Since the lifting surface is flat, the function $C(\theta)$ must be found such that $w_{z=0}$ is independent of ω for $-\theta_1 < \omega < \theta_0$. The integral equation can be greatly simplified by integrating the ω_1 variation by parts and then taking the partial derivative of both sides of the equation with respect to ω . In this manner, equation (18) reduces to

$$0 = \frac{\partial}{\partial \omega} \frac{\sqrt{1-\omega^2}}{\omega} \int_{-\theta_1}^{\theta_0} \frac{C(\theta) d\theta}{\omega-\theta} + \frac{1}{\omega^2 \sqrt{1-\omega^2}} \int_{-\theta_1}^{\theta_0} \frac{C(\theta) d\theta}{\omega-\theta} \quad (19)$$

which becomes

$$0 = \frac{\partial}{\partial \omega} \int_{-\theta_1}^{\theta_0} \frac{C(\theta) d\theta}{\omega-\theta} \quad (20)$$

The solution of equation (20) can be written

$$\frac{1}{\theta} C(\theta) = \frac{A + \sum_{i=1}^n \frac{B_i}{(\theta+\lambda_i)}}{\sqrt{(\theta+\theta_1)(\theta-\theta_0)}}, \quad -\theta_1 < \lambda_i < \theta_0 \quad (21)$$

and, if the integrated loading of the wing is finite

$$C(\theta) = \frac{A\theta+B}{\sqrt{(\theta+\theta_1)(\theta-\theta_0)}} \quad (22)$$

Substitution of equation (22) into equation (18) yields the two relations

$$w_{z=0} = \frac{\beta}{2V_0} [AH_1(\theta_0, \theta_1) + BH_2(\theta_0, \theta_1)] \quad (23)$$

and

$$w_{z=0} = \frac{\beta}{2V_0} [-AH_1(\theta_1, \theta_0) + BH_2(\theta_1, \theta_0)] \quad (24)$$

where

$$H_1(\theta_1, \theta_0) = \int_1^{\theta_1} \frac{d\omega_1}{\omega_1 \sqrt{(1-\omega_1^2)(\omega_1-\theta_1)(\omega_1+\theta_0)}} \quad (25)$$

and

$$H_2(\theta_1, \theta_0) = \int_1^{\theta_1} \frac{d\omega_1}{\omega_1^2 \sqrt{(1-\omega_1^2)(\omega_1-\theta_1)(\omega_1+\theta_0)}} \quad (26)$$

Equations (25) and (26) may be integrated by the standard methods for elliptic integrals and, after substituting into equations (23) and (24) and solving for A and B, we have

$$A = -\frac{V_0 w_{z=0}}{\beta E'} (\theta_0 - \theta_1) \sqrt{\frac{2G}{\theta_0 + \theta_1}} \quad (27)$$

and

$$B = -\frac{V_0 w_{z=0}}{\beta E'} 2\theta_0 \theta_1 \sqrt{\frac{2G}{\theta_0 + \theta_1}} \quad (28)$$

where

$$G = \frac{1 + \theta_0 \theta_1 - \sqrt{(1-\theta_0^2)(1-\theta_1^2)}}{\theta_0 + \theta_1} \quad (29)$$

and E' is the complete elliptic integral of the second kind with modulus $\sqrt{1-G^2}$.

The load distribution over the wing can now be calculated from equations (22), (27), and (28). It follows that

$$\frac{\Delta p}{q} = \frac{2C(\theta)}{V_0^2} = \frac{2\alpha}{\beta E^*} \sqrt{\frac{2G}{\theta_0 + \theta_1}} \left[\frac{(\theta_0 - \theta_1)\theta + 2\theta_0\theta_1}{\sqrt{(\theta_1 + \theta)(\theta_0 - \theta)}} \right] \quad (30)$$

Typical load distributions over a yawed wing are shown in figure 4 for $\beta \tan \delta_1 = 0.6$ and for $\beta \tan \delta_0$ equal to 0, 0.3, 0.6, and 0.9.

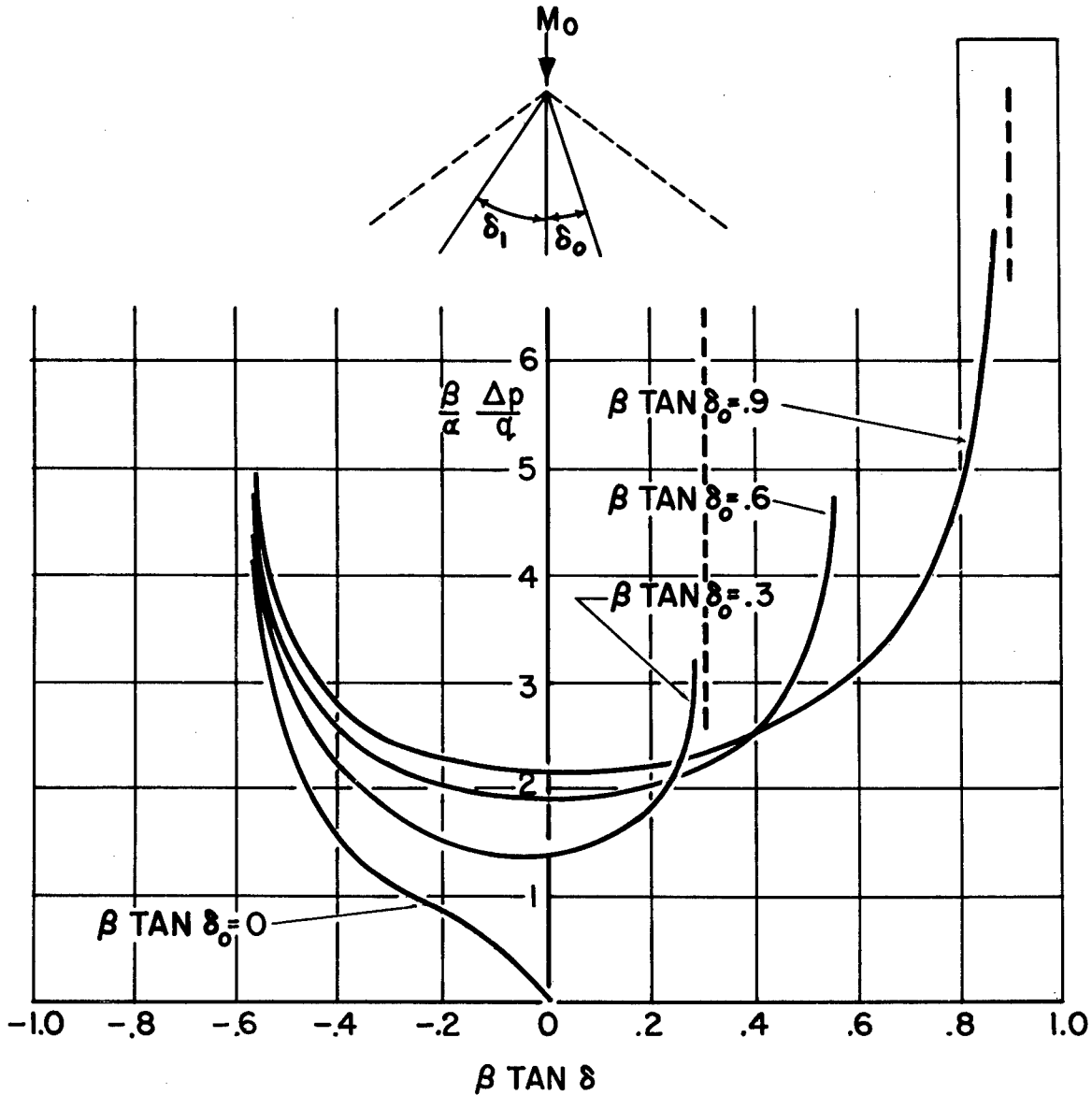

Figure 4.- Angle-of-attack load distribution over yawed triangular plan form, $\beta \tan \delta_1 = 0.6$.

Integration of equation (30) over the surface of the triangular wing determines for lift coefficient the expression

$$C_L = \frac{2\alpha\pi}{E^*} \cos\Lambda \sqrt{\frac{G \tan \Delta}{\beta}} \quad (31)$$

where Λ is sideslip angle and 2Δ is the angle between the leading edges. Equation (31) was derived for wings with subsonic leading edges and supersonic trailing edge and consequently is valid only for cases for which

$$\begin{aligned} \mu + \Lambda &< 90^\circ \\ \Delta + \Lambda &< \mu \\ \Delta - \Lambda &> 0 \end{aligned} \quad (32)$$

Downwash Behind Triangular Wing in Supersonic Flow

The second application will show how doublet distributions may be employed in the calculation of downwash in the wake of an unyawed triangular wing with subsonic leading edges. The expression for the velocity potential will be given in general form, but in order to avoid detailed analysis the value of downwash is determined only along the center line in the plane of the wing.

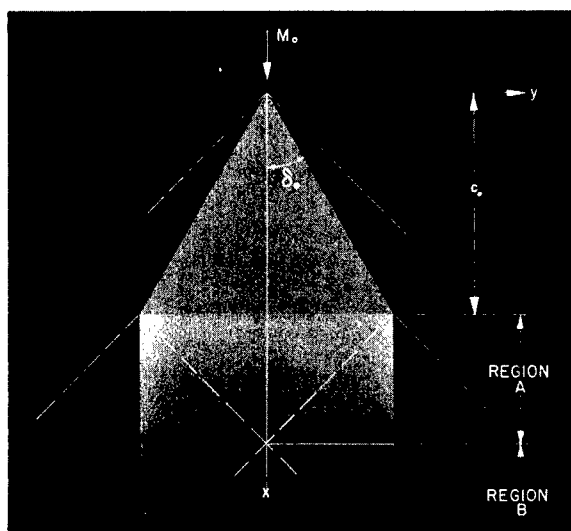

A plan view of the wing and wake is shown in figure 5. The load distribution over the wing is found from equation (30), after setting $\theta_0 = \theta_1$, to be

$$\frac{\Delta p}{q} = \frac{4\theta_0^2 \alpha x}{E^* \beta \sqrt{\theta_0^2 x^2 - \beta^2 y^2}} \quad (33)$$

Figure 5.- Triangular wing and wake together with regions used in calculating downwash.

where E'_0 has the modulus $\sqrt{1-\theta_0^2}$. Moreover

$$\phi = \int_{-\infty}^x u \, dx$$

so that the jump in potential $\phi_u - \phi_l$ on the surface of the wing is

$$\phi_u - \phi_l = \frac{2\alpha V_0}{E'_0 \beta} \sqrt{\theta_0^2 x^2 - \beta^2 y^2} \quad (34)$$

and for points in the wake is

$$\phi_u - \phi_l = \frac{2\alpha V_0}{E'_0 \beta} \sqrt{\theta_0^2 c_0^2 - \beta^2 y^2} \quad (35)$$

where c_0 is the root chord of the wing. Since the wing and its wake form a discontinuity surface for the perturbation velocity potential and since for all points on this surface

$$\frac{\partial \phi_u}{\partial z} = \frac{\partial \phi_l}{\partial z}$$

it follows from equation (10) that the velocity potential at an arbitrary point x, y, z is given by the relation

$$\phi(x, y, z) = \frac{1}{2\pi} \int_{\tau} \int \int (\phi_u - \phi_l) \left(\frac{\partial}{\partial \xi} \frac{1}{r_D} \right)_{\xi=0} d\xi d\eta \quad (36)$$

where τ is that portion of the wing and wake forward of the Mach forecone from the point x, y, z and $(\phi_u - \phi_l)$ is given by equations (34) and (35).

The value of the downwash aft of the wing and along the x axis will be calculated from equation (36), thus

$$w = \left[\frac{\partial}{\partial z} \varphi(x, y, z) \right]_{\substack{z=0 \\ y=0}}$$

is to be determined. In carrying out these calculations, it is necessary to consider two segments of the x axis behind the wing:

Region A extends from the trailing edge to the point where the trailing Mach cones from the tips of the wing intersect the x axis and thus includes values of x satisfying the inequality

$$c_0 \leq x \leq c_0(1+\theta_0)$$

Region B includes values of x for which

$$c_0(1+\theta_0) \leq x$$

The final expressions for downwash in the two regions are found, after some manipulation, to be

$$\begin{aligned} \text{Region A: } \frac{w}{w_0} &= 2 \frac{E_2 - (1-k_2^2)K_2}{\pi E'_0 k_2} + \frac{E'_0 - \theta_0}{E'_0} \\ &\quad - \frac{2}{\pi E'_0} \int_0^{k_2} \frac{K-E}{k^2(1+\theta_0 k)} dk \end{aligned} \quad (37)$$

$$\text{Region B: } \frac{w}{w_0} = \frac{2E_1}{\pi E'_0} + \frac{2}{\pi E'_0} \int_0^{k_1} \frac{K-E}{k+\theta_0} dk \quad (38)$$

where

w_0 induced vertical velocity on the wing

K complete elliptic integral of the first kind

K_1, K_2 complete elliptic integral of the first kind with moduli k_1, k_2 , respectively

E complete elliptic integral of the second kind

E_1, E_2 complete elliptic integral of the second kind with moduli k_1, k_2 , respectively

$$k_1 = \frac{c_0 \theta_0}{x - c_0}$$

$$k_2 = \frac{x - c_0}{c_0 \theta_0}$$

Figure 6 shows the variation of $\frac{w}{w_0}$ along the x axis for various values of the parameter $\theta_0 = \beta \tan \delta_0$. The asymptotic values at $x = \infty$ are also indicated and can be shown to agree with the values of downwash at infinity for a wing with the same span load distribution in incompressible flow. The discontinuity in downwash at the trailing edge is a characteristic property of supersonic-type trailing edges.

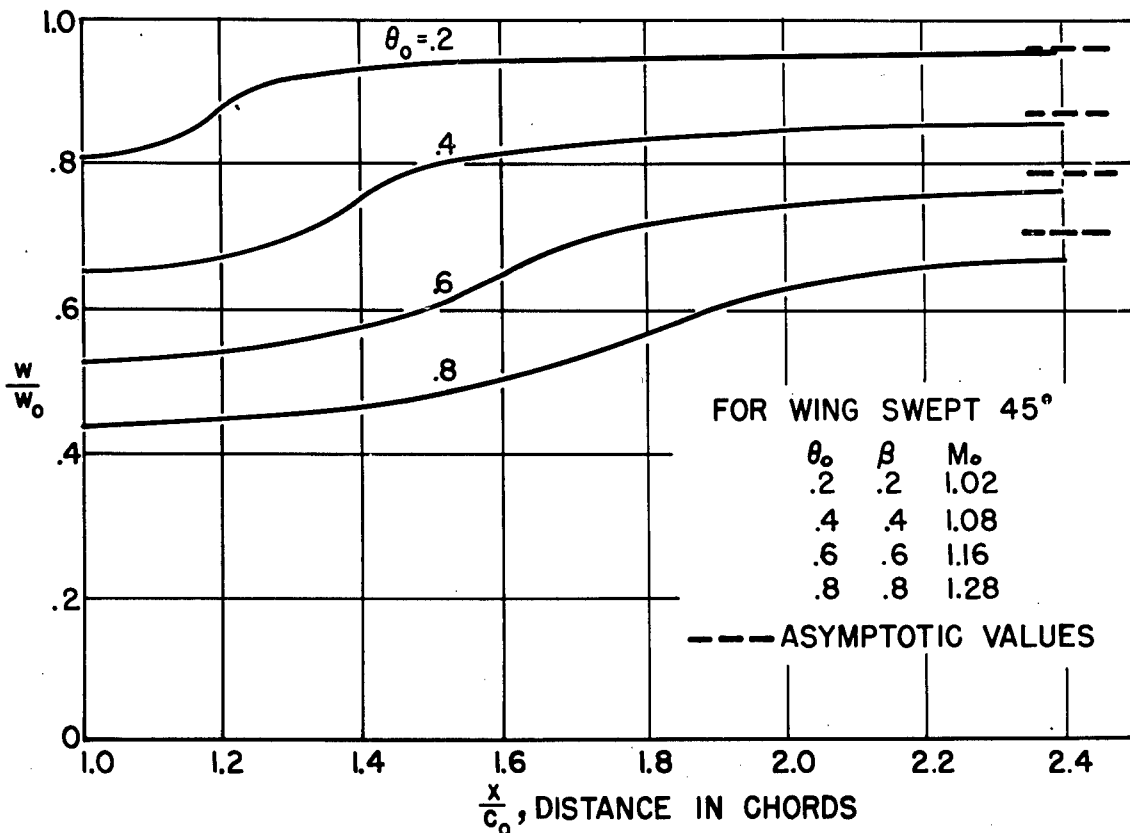

Figure 6.- Variation of downwash on x axis behind a triangular wing plotted as a function of distance in chord lengths.

Denoting downwash at this point by w_t , Lagerstrom and Graham (reference 20) have shown that

$$\frac{w_t}{w_0} = \frac{E'_0 - \theta_0}{E'_0} \quad (39)$$

A more detailed development of the results shown in figure 6 has been given in reference 21.

Two-Dimensional Unsteady Lift Problems

It has already been pointed out that, in the case of unsteady motion in a two-dimensional compressible-flow field, the linearized partial-differential equation for the perturbation velocity potential can be transformed into the same form that has been considered in solving steady-state problems in supersonic wing theory. This immediately indicates the possibility that for certain types of boundary-value problems in the unsteady case an analogy can be established with three-dimensional lifting-surface problems.

As an example, let us consider an airfoil that has been flying at supersonic speed and then experiences at $t'=0$ an abrupt angle-of-attack change without pitching. Since the angle-of-attack change is assumed to take place at $t'=0$, it can be assumed that previous to this time the induced velocities of the wing are zero and only subsequent perturbations are to be calculated. Throughout the swept area in the $x't'$ plane (fig. 1) the vertical induced velocity w is constant and equal to $-V_0\alpha$. Elsewhere in the $z'=0$ plane there is no discontinuity in the value of pressure, that is, $\frac{\partial\phi}{\partial t'}$ is continuous at $z'=0$.

Suppose now that the area is a wing plan form and that the free stream is directed along the t' axis. The characteristic cones of the unsteady problem become the Mach cones of the steady-state problem, and the Mach number of the free stream is $\sqrt{2}$ since the characteristic lines in the figure are inclined 45° to the axes.

Moreover, the induced vertical velocity is $\frac{\partial\phi}{\partial z'}$ and the perturbation velocity in the free-stream direction is $\frac{\partial\phi}{\partial t'}$. A correspondence can thus be established between the unsteady problem and a three-dimensional lifting-surface problem.

As outlined, the boundary-value problem is one of the second kind, that is, w is specified on the wing and $\Delta u = \Delta w = 0$ off the wing. In our particular example, however, the edges of the wing are of the supersonic type and no interaction exists between the two surfaces of the lifting plate so that pressures on either side can be calculated by the methods used for symmetrical nonlifting wings. Thus, from equation (12), for $z' > 0$

$$\varphi(t', x', z') = \frac{V_0 \alpha}{\pi} \int_{\tau} \int \frac{dt'_1 dx'_1}{\sqrt{(t' - t'_1)^2 - (x' - x'_1)^2 - z'^2}} \quad (40)$$

and for all z'

$$\varphi(t', x', z') = -\varphi(t', x', -z')$$

The expressions for the indicial load coefficient $\frac{\Delta p}{q}$ are as follows:

Region A (between lines $x' = t'$, $t' = 0$, and $x' = c_0 - M_0 t'$)

$$\frac{\Delta p}{q} = \frac{4\alpha}{M_0} \quad (41a)$$

Region B (between lines $x' = -t'$, $x' = t'$, and $x' = c_0 - M_0 t'$)

$$\frac{\Delta p}{q} = \frac{4\alpha}{\sqrt{M_0^2 - 1}} \left[\frac{1}{\pi} \arccos \frac{M_0 x' + t'}{x' + M_0 t'} + \frac{\sqrt{M_0^2 - 1}}{\pi M_0} \left(\frac{\pi}{2} + \arcsin \frac{x'}{t'} \right) \right] \quad (41b)$$

Region C (between lines $x' = -M_0 t'$ and $x' = -t'$)

$$\frac{\Delta p}{q} = \frac{4\alpha}{\sqrt{M_0^2 - 1}} \quad (41c)$$

The growth of $\frac{\Delta p}{q\alpha}$ with time, as obtained from equations (41a), (41b), and (41c), is shown in the portion of figure 7 designed "supersonic." At $t'=0$ the loading jumps to the value $\frac{4\alpha}{M_0}$ and is constant along the entire chord. This value persists throughout the previously denoted Region A and thus, with advancing time, moves rearward along the chord, leaving the trailing edge at $t' = \frac{c_0}{M_0+1}$. Over the forward portion of the chord the familiar Ackeret type of steady-state loading becomes effective, spreading back from the leading edge and occupying the entire chord length after $t' = \frac{c_0}{M_0-1}$. Previous to $t' = \frac{c_0}{M_0+1}$ a transition region between the two types of constant loading exists, and subsequent to this time this transition region moves aft and leaves the trailing edge at $t' = \frac{c_0}{M_0-1}$.

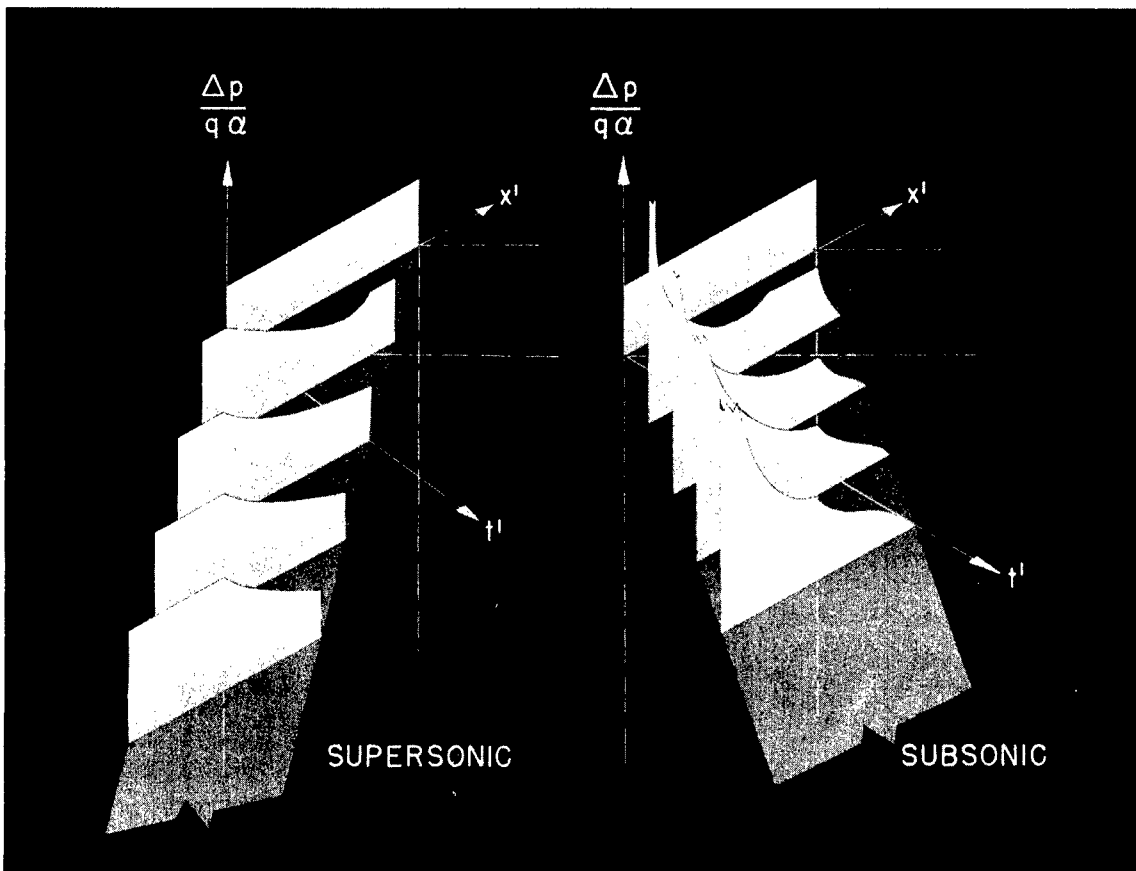

Figure 7.- Pressure distributions on wing undergoing sudden angle-of-attack change at $t'=0$.

For purposes of comparison, the growth with time of the angle-of-attack indicial load coefficient for subsonic flight is also shown in the part of figure 7 entitled "subsonic." Since in this case the

lifting-surface analogue involves subsonic leading and trailing edges, the analysis requires the solution of a boundary-value problem of the second kind. The method of Evvard (reference 15) was used to obtain the results shown. It is to be noted that the expression

$$\frac{\Delta p}{q} = \frac{4\alpha}{M_0}$$

holds at $t^*=0$ for all values of Mach number.

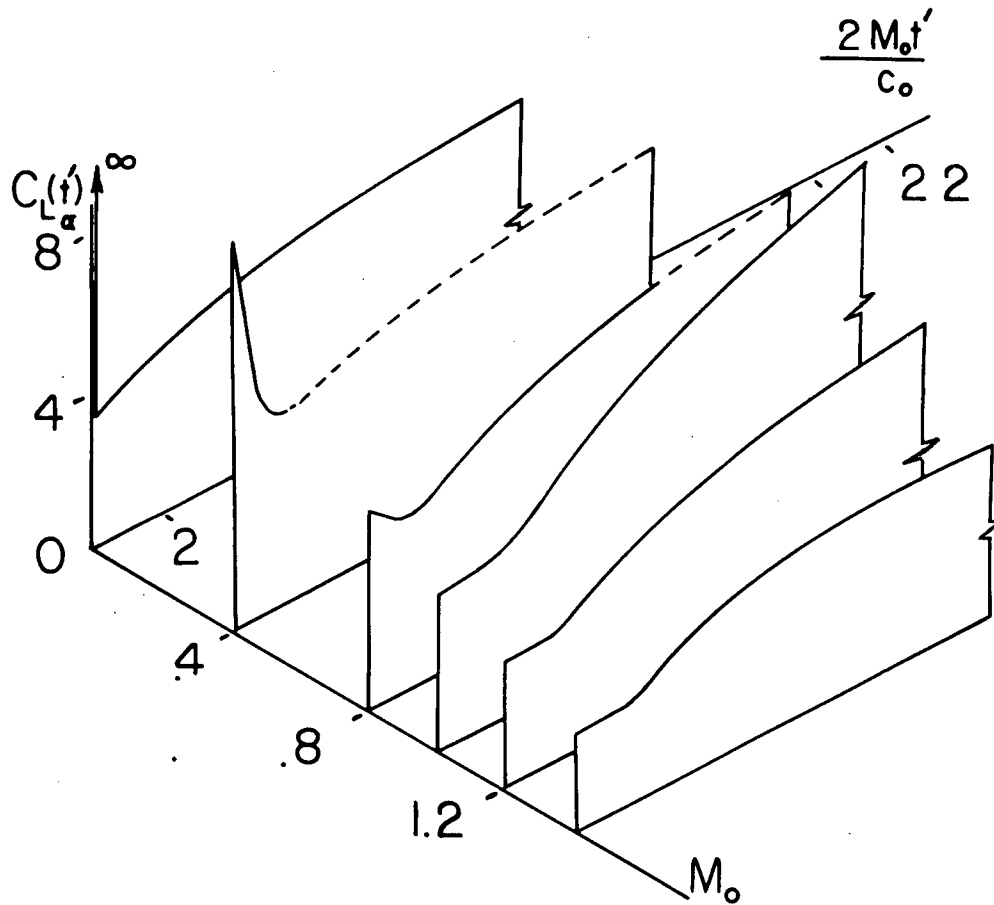

Figure 8.- Indicial lift-curve slope for Mach numbers between 0 and 1.4 shown to time required to travel 12 half-chord lengths.

Figure 8 shows the variation of the indicial lift function $C_{L\alpha}(t^*)$ defined by the relation

$$C_{L\alpha}(t^*) = \frac{1}{c_0 \alpha} \int_0^{c_0} \frac{\Delta p}{q} dx \quad (42)$$

as a function of Mach number and half-chords s traveled by the airfoil. The curve at $M_0=0$ was first studied by Wagner (reference 22) and R. T. Jones (reference 6). Since the starting value is $\frac{4}{M_0}$, $CL_\alpha(t')$ must initially be infinite. Immediately afterward, however, it assumes the value π and then rises to the asymptotic value 2π . At a Mach number of 0.4 the starting value of $CL_\alpha(t')$ is 10 followed by a decrease for the time required to travel approximately one-half chord length and finally a steady rise takes place to the asymptotic value $\frac{2\pi}{\sqrt{1-M_0^2}}$. At $M_0=0.8$ the behavior is similar.

The dashed portions of the curves were determined from the known variations of the functions and were not calculated explicitly. The asymptotic values of CL_α consistent with the Prandtl-Glauert correction become so high, however, with increasing Mach number that the assumptions of small perturbation theory are undoubtedly invalidated near $M_0=1$ for sufficiently large values of s . The initial portions of the subsonic curves shown in the figure are, however, valid results of the theory. The nature of the indicial lift function is somewhat different at supersonic Mach numbers in that the beginning portions of the curves are flat. The curves rise afterwards, however, in a finite time to their steady-state value. From equations (41a), (41b), and (41c) the expressions for $CL_\alpha(t')$ are easily calculated for $M_0 \geq 1$ and are as follows:

First time interval $0 < t' < \frac{c_0}{1+M_0}$

$$CL_\alpha(t') = \frac{4}{M_0} \quad (43a)$$

Second time interval $\frac{c_0}{1+M_0} < t' < \frac{c_0}{M_0-1}$

$$CL_\alpha(t') = \frac{4}{\pi} \left[\frac{1}{M_0} \left(\frac{\pi}{2} + \arcsin \frac{c_0 - M_0 t'}{t'} \right) + \frac{1}{\sqrt{M_0^2 - 1}} \arccos \frac{t' + M_0 c_0 - t' M_0^2}{c_0} \right. \\ \left. + \frac{1}{M_0 c_0} \sqrt{t'^2 - (c_0 - t' M_0)^2} \right] \quad (43b)$$

Third time interval $\frac{c_0}{M_0-1} < t'$

$$C_{L\alpha}(t') = \frac{4}{\sqrt{M_0^2-1}} \quad (43c)$$

Some of the above results, along with further developments involving the entrance at supersonic speed of an unrestrained airfoil into a gust, have been given in reference 7.

Swept-Back Wings at $M_0=1$

We turn now to the special form of the basic differential equation for the case $M_0=1$. As given in table I, equation (E), the velocity potential satisfies Laplace's equation

$$\Phi_{yy} + \Phi_{zz} = 0$$

in two dimensions. The boundary conditions need, therefore, to be given along strips normal to the free-stream direction. Equation (7) expresses the solution of the equation in terms of two-dimensional sources, sinks, and doublets where now

$$\ln r_A = \ln \sqrt{(y-\eta)^2 + (z-\zeta)^2}$$

The proposed problem is the determination of the angle-of-attack load distribution over a swept-back lifting plate, the leading edges will be assumed straight lines while the trailing edge will, for the time being, be left arbitrary. The nature of the wing

is thus indicated somewhat arbitrarily in figure 9(a).

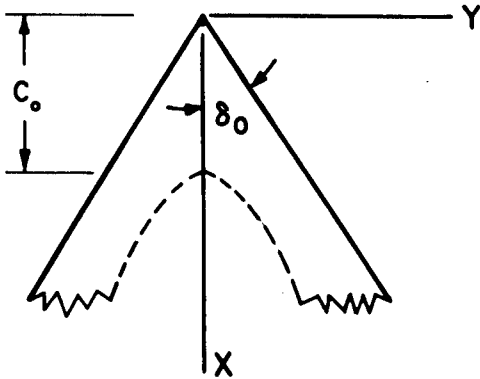

(a) Plan form with arbitrary trailing edge.

$M_0 = 1$

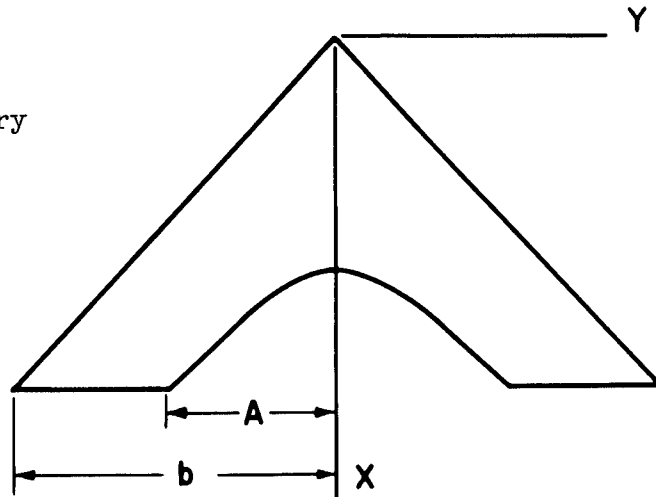

(b) Plan form satisfying Kutta-Joukowski condition.

Figure 9.— Swept-back wings for analysis at $M_0=1$.

Denoting the semivertex angle by δ_0 so that the equations of the leading edges are

$$y = \pm x \tan \delta_0 = \pm mx \quad (44)$$

it follows from equation (7) that since

$$\frac{\partial \phi_u}{\partial z} = \frac{\partial \phi_l}{\partial z}$$

the velocity potential is given by the relation

$$\varphi(x,y,z) = \frac{z}{2\pi} \int_{-mx}^{mx} \frac{\Delta\varphi_0(x,\eta)}{(y-\eta)^2+z^2} d\eta \quad (45)$$

where

$$\Delta\varphi_0(x,y) = \int_{mx}^y \Delta v_0(x,\eta,0) d\eta$$

It is then possible, after integrating equation (45) by parts and imposing the condition that $\Delta\varphi_0(x,y) = 0$ at $\eta = \pm mx$, to calculate the derivative of φ with respect to z and thus obtain for w_0 , induced vertical velocity on the wing, the expression

$$w_0 = \frac{-1}{2\pi} \int_{-mx}^{mx} \frac{\Delta v_0(x,\eta)}{y-\eta} d\eta \quad (46)$$

This integral equation is to be solved for Δv_0 , the velocity w_0 being assumed constant on the wing and equal to $-V_0\alpha$ where α is angle of attack. The load distribution can then be calculated from this solution by means of the relation

$$\frac{\Delta p}{q} = \frac{2}{V_0} \Delta \frac{\partial\varphi_0}{\partial x} = \frac{2}{V_0} \frac{\partial}{\partial x} \int_{mx}^y \Delta v_0(x,\eta) d\eta \quad (47)$$

The remainder of the analysis can best be divided into two parts: The first case treating values of x between 0 and c_0 , the second dealing with the remaining values of x on the wing.

Case I: $0 \leq x \leq c_0$.— Since the leading edges of the wing are of subsonic type, singularities in pressure occur at these edges so that the required solution of equation (46) is of the form

$$\Delta v_0(x,y) = \frac{A+By}{\sqrt{m^2x^2-y^2}} \quad (48)$$

Substitution into equation (46) and use of the fact that $\Delta\phi_0(x,y)$ is an even function of y leads to the result $A=0$, $B=-2w_0$. Hence

$$\Delta\phi_0(x,y) = -2w_0 \sqrt{m^2 x^2 - y^2} \quad (49)$$

and

$$\frac{\Delta p}{q} = \frac{-4w_0 m^2 x}{V_0 \sqrt{m^2 x^2 - y^2}} = \frac{4\alpha m^2 x}{\sqrt{m^2 x^2 - y^2}} \quad (50)$$

Case II: $c_0 \leq x$. Let the equation of the trailing edge be

$$y = a(x) \quad \text{or} \quad x = a^*(y) \quad (51)$$

Using in equation (46) the fact that

$$\Delta v_0(x,y) = -\Delta v_0(x,-y)$$

the expression for w_0 becomes

$$w_0 = \frac{-1}{2\pi} \int_0^{a(x)} \frac{2\eta \Delta v_0 d\eta}{y^2 - \eta^2} - \frac{1}{2\pi} \int_{a(x)}^{mx} \frac{2\eta \Delta v_0 d\eta}{y^2 - \eta^2} \quad (52)$$

If, on the surface of the wing, $\Delta\phi_0(x,\eta)$ is known, then, in the wake, the discontinuity in the velocity potential is $\Delta\phi_0[a^*(\eta),\eta]$ since no contribution to the jump in potential is made past the trailing edge. It follows that if on the wing

$$\Delta v_0(x,\eta) = f(x,\eta^2) \quad (53)$$

then, in the wake

$$\Delta v_0(x, \eta) = \left[\Delta \frac{\partial \phi_0(x, \eta)}{\partial x} \frac{\partial a^*}{\partial y} + \Delta \frac{\partial \phi_0(x, \eta)}{\partial \eta} \right]_{x=a^*(\eta)} \quad (53)$$

$$= \frac{V_0}{2} \frac{\Delta p[a^*(\eta), \eta]}{q} \frac{\partial a^*}{\partial y} + f[a^*(\eta), \eta^2] \quad (54)$$

Substituting equations (53) and (54) into equation (52) and introducing the Kutta condition that loading at the trailing edge is zero, we get the modified integral equation

$$w_0 = -\frac{1}{2\pi} \int_0^{a^2} \frac{f[a^*(\sqrt{\sigma_1}), \sigma_1]}{\sigma - \sigma_1} d\sigma_1 - \frac{1}{2\pi} \int_{a^2}^{m^2 x^2} \frac{f(x, \sigma_1)}{\sigma - \sigma_1} d\sigma_1 \quad (55)$$

where the variables σ, σ_1 now replace y^2, η^2 , respectively. The function

$$f(x, \sigma) = 2w_0 \sqrt{\frac{\sigma - a^2(x)}{m^2 x^2 - \sigma}} \quad (56)$$

satisfies equation (55) and it remains now to determine $a(x)$ so that pressure is zero at the trailing edge. But from equation (53)

$$\Delta \phi(x, y) = 2w_0 \int_{mx}^y \sqrt{\frac{y_1^2 - a^2(x)}{m^2 x^2 - y_1^2}} dy_1$$

and thus

$$\frac{\Delta p(x, y)}{q} = 4\alpha \left[-k' \frac{da}{dx} F(k, \psi) + mE(k, \psi) + \frac{y}{x} \sqrt{\frac{y^2 - k'^2 m^2 x^2}{m^2 x^2 - y^2}} \right] \quad (57)$$

where $k' = \frac{a}{mx}$ and $E(k, \psi), F(k, \psi)$ are incomplete elliptic integrals with modulus $k = \sqrt{1 - k'^2}$ and argument $\psi = \arcsin \frac{1}{k} \sqrt{1 - \frac{y^2}{m^2 x^2}}$

At the trailing edge $y=a(x)$ and

$$\frac{\Delta p}{q} = 4\alpha \left(-k' \frac{da}{dx} K + mE \right)$$

where the elliptic integrals are now complete. If load coefficient is set equal to zero, the differential equation

$$\frac{da}{dx} = \frac{m^2 x E}{a K} \quad (58)$$

where $k = \sqrt{1 - \frac{a^2}{m^2 x^2}}$, follows.

The integration of equation (58) leads to the shape of the trailing edge for which the Kutta condition is satisfied. Figure 9(b) shows the plan form of the wing. It can be shown that the slope of the extended trailing edge approaches the slope of the leading edge.

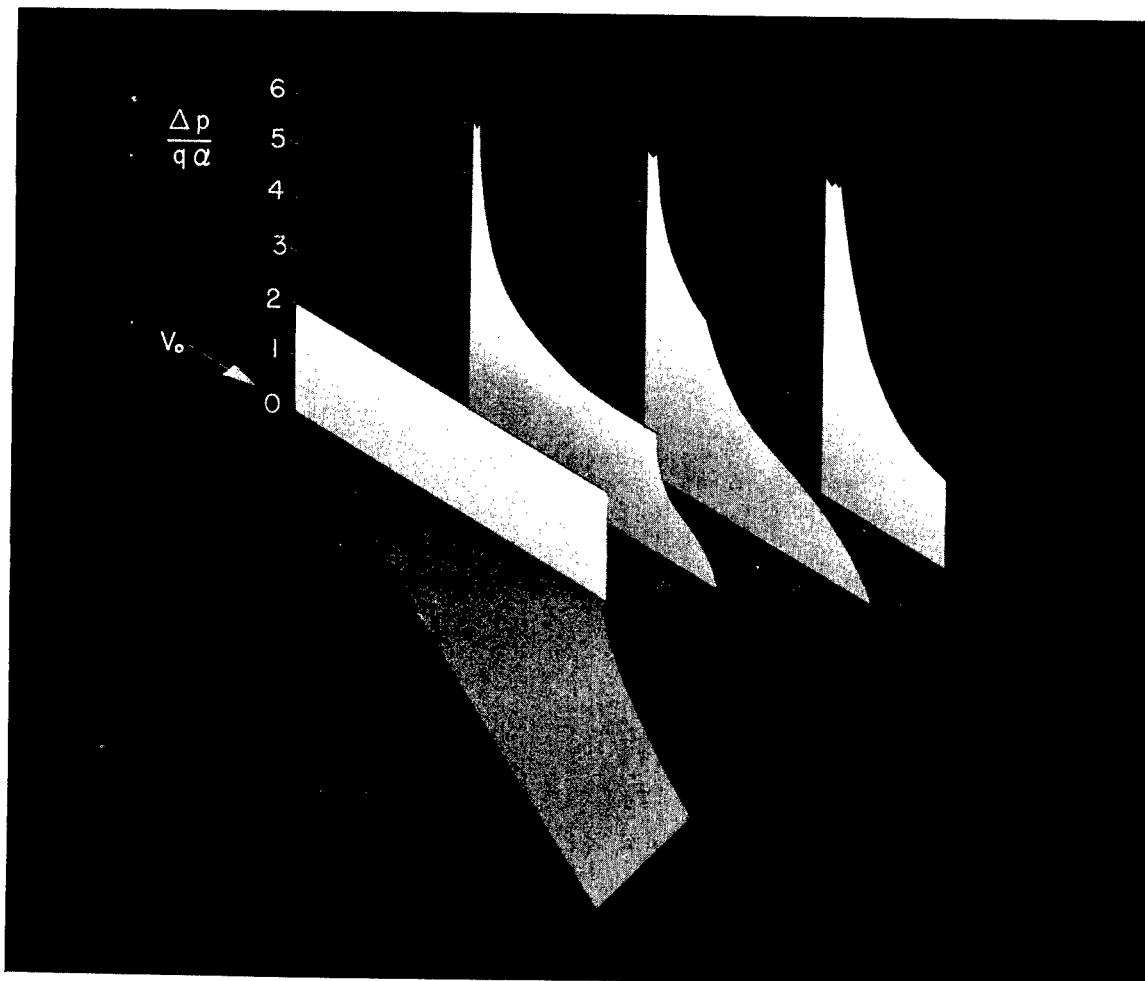

Figure 10.— Load distribution over swept-back plan form at $M_0=1$.

In figure 10 the load distribution is shown at three spanwise stations for the case when the wing is cut off along a line normal

to the free-stream direction. Over the center section of the wing the Ackeret type of distribution exists. The remaining sections have discontinuities in slope of the loading at the point where the chord line is cut by the Mach cone arising at the trailing edge of the root chord. This behavior of the loading has been noted elsewhere for swept-back wings at higher Mach numbers. (See, e.g., reference 23.)

Lift coefficient C_L of the wing is given by the expression

$$C_L = \frac{1}{S} \int_{-b}^b dy \int_{L.E.}^{T.E.} \frac{\Delta p}{q} dx$$

where S and b are, respectively, area and semispan of the wing and the first integral extends from the leading edge to the trailing edge. This equation may be rewritten as

$$C_L = \frac{2}{SV_0} \int_0^b \Delta\phi(T.E., y) dy \quad (59)$$

where $\Delta\phi(T.E., y)$ is the jump in potential at the trailing edge and thus equal to the circulation function $\Gamma(y)$. The following results are obtained:

$$\Gamma(y) = 2mV_0c_0\alpha, \quad 0 \leq y \leq A$$

$$\Gamma(y) = 2V_0\alpha b \left[E(k, \psi) - (1-k^2)F(k, \psi) \right], \quad A \leq y \leq b \quad (60)$$

where $k = \sqrt{1 - \frac{A^2}{b^2}}$ and A is the lateral distance to the inboard

tip of the wing. (See fig. 9(b).)

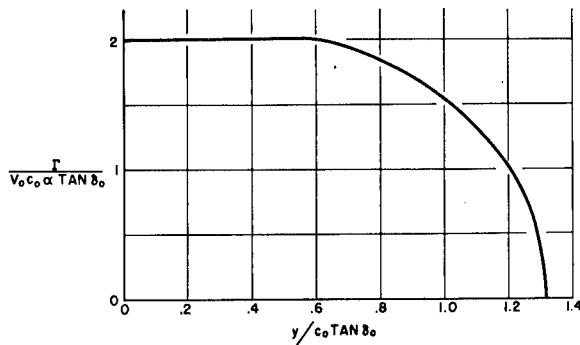

Figure 11.- Spanwise distribution of circulation for swept-back wing at $M_0=1$, $b=1.325 c_0 \tan \delta_0$ and $AR=4.57 \tan \delta_0$.

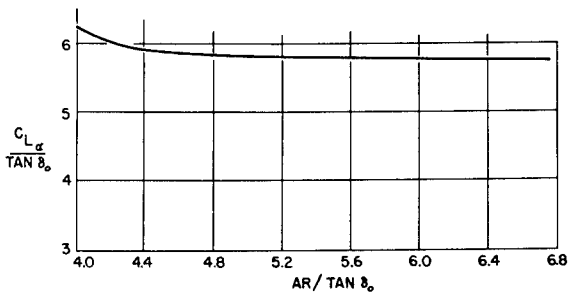

Figure 12.- Lift-curve slope as a function of aspect ratio for swept-back wing at $M_0=1$.

In figure 11 the value of $\frac{\Gamma}{V_0 c_0 \alpha \tan \delta_0}$ is plotted as a function of $\frac{y}{c_0 \tan \delta_0}$ for a wing with semispan $b=1.325 c_0 \tan \delta_0$ and aspect ratio $AR=4.57 \tan \delta_0$. Results of the integration of equation (59) are shown in figure 12 where $\frac{C_{L\alpha}}{\tan \delta_0}$ is plotted as a function of $\frac{AR}{\tan \delta_0}$.

The methods presented here can be applied to the case of the swept-back wing with tips cut off parallel to the free stream. In this case a Mach cone originates not only at the trailing edge of the root chord but also at the intersection of the leading and the lateral edges. On the portion of the wing downstream of this Mach cone, the load distribution is modified so that an abrupt discontinuity exists at the Mach cone and negative loading is effective over this part of the wing. A similar effect on this type of swept-back wing has also been noted at higher Mach numbers in reference 23.

Ames Aeronautical Laboratory,
National Advisory Committee for Aeronautics,
Moffett Field, Calif.

APPENDIX

List of Important Symbols

a_0	speed-of sound in free stream
A	lateral distance to inboard tip of swept wing (See fig. 9)
AR	aspect ratio
b	semispan
c_0	chord length (two dimensions) root chord (three dimensions)
$C, C(\theta)$	load distribution factor introduced in equation (16)
C_L	lift coefficient
$C_{L\alpha}$	lift-curve slope
$C_{L\alpha}(t')$	indicial lift function
C_p	pressure coefficient $\left(\frac{p-p_0}{q}\right)$
E	complete elliptic integral of the second kind with modulus k
E', E'_0	complete elliptic integrals of the second kind with moduli $\sqrt{1-G^2}, \sqrt{1-\theta_0^2}$, respectively
E_1, E_2	complete elliptic integrals of the second kind with moduli k_1, k_2 , respectively
$E(k, \psi)$	$\int_0^\psi \sqrt{1-k^2 \sin^2 \varphi} \, d\varphi$
$F(k, \psi)$	$\int_0^\psi \frac{d\varphi}{\sqrt{1-k^2 \sin^2 \varphi}}$
G	parameter defined in equation (29)
k_1	$\frac{c_0 \theta_0}{x-c_0}$
k_2	$\frac{x-c_0}{c_0 \theta_0}$

K	complete elliptic integral of the first kind with modulus k
K_1, K_2	complete elliptic integrals of the first kind with moduli k_1, k_2 , respectively
m	$\tan \delta_0$
M_0	free-stream Mach number
p	local static pressure
p_0	free-stream static pressure
q	free-stream dynamic pressure $\left(\frac{1}{2}\rho_0 V_0^2\right)$
r_A	$\sqrt{(x-\xi)^2 + \beta^2(z-\zeta)^2}$
r_C	$\sqrt{(x-\xi)^2 + \beta^2[(y-\eta)^2 + (z-\zeta)^2]}$
r_D	$\sqrt{(x-\xi)^2 - \beta^2[(y-\eta)^2 + (z-\zeta)^2]}$
s	distance traveled in half-chords
S	area of wing
t	time
u, v, w	perturbation velocity components parallel to x, y, z axes, respectively
$\Delta u_0, \Delta w_0$	jump in value of u, w at the z=0 plane
V_0	velocity of free stream
x, y, z	Cartesian coordinates
x', z', t'	coordinates introduced in equation (2)
α	angle of attack in radians,
β	$\sqrt{ 1-M_0^2 }$
$\frac{\Delta p}{q}$	load coefficient $\left(C_{p_l} - C_{p_u}\right)$

Δ	semivertex angle of yawed triangular wing
δ	angle between lifting element and x axis
δ_0, δ_1	angles between leading edges of yawed triangle and x axis
$\theta, \theta_0, \theta_1$	$\beta \tan \delta, \beta \tan \delta_0, \beta \tan \delta_1$
Λ	sideslip angle of yawed triangle
μ	Mach angle $\left(\arcsin \frac{1}{M_0} \right)$
ξ, η, ζ	Cartesian coordinates
ρ_0	free-stream density
τ	region of integration in equation (10)
φ	perturbation velocity, potential
ω	$\beta \frac{y}{x}$
\int	sign denoting "finite part" of integral

Subscripts

u	subscript denoting value of variable on upper surface of wing
l	subscript denoting value of variable on lower surface of wing

REFERENCES

1. Prandtl, L.: General Considerations on the Flow of Compressible Fluids. NACA TM No. 805, 1936.
2. Schlichting, H.: Airfoil Theory at Supersonic Speed. NACA TM No. 897, 1939.
3. Puckett, Allen E.: Supersonic Wave Drag of Thin Airfoils. Jour. Aero. Sci., vol. 13, no. 9, Sept. 1946, pp. 475-484.
4. Hadamard, Jacques: Lectures on Cauchy's Problem in Linear Partial Differential Equations. Yale University Press, 1923.

5. Jones, R. T.: Operational Treatment of the Nonuniform-Lift Theory in Airplane Dynamics. NACA TN No. 667, 1938.
6. Jones, R. T.: The Unsteady Lift of a Wing of Finite Aspect Ratio. NACA Rep. No. 681, 1940.
7. Heaslet, Max. A., and Lomax, Harvard: Two-Dimensional Unsteady Lift Problems in Supersonic Flight. NACA TN No. 1621, 1948.
8. Volterra, V.: Leçons sur L'Intégration des Équations Différentielles aux Dérivées Partielles. Paris, Hermann et Fils. 1912, pp. 43-53.
9. Baker, Bevan B., and Copson, E. T.: The Mathematical Theory of Huygens' Principle. Oxford, Clarendon Press, 1939.
10. Fremberg, Nils Erik: A Study of Generalized Hyperbolic Potentials. Lund University, 1946.
11. Heaslet, Max. A., and Lomax, Harvard: The Use of Source-Sink and Doublet Distributions Extended to the Solution of Arbitrary Boundary Value Problems in Supersonic Flow. NACA TN No. 1515, 1948.
12. Falkner, V. M.: The Calculation of Aerodynamic Loading on Surfaces of Any Shape. R. & M. No. 1910, British A.R.C., 6997, 1943.
13. Cohen, Doris: A Method for Determining the Camber and Twist of a Surface to Support a Given Distribution of Lift. NACA TN No. 855, 1942.
14. Esvard, John C.: Distribution of Wave Drag and Lift in the Vicinity of Wing Tips at Supersonic Speeds. NACA TN No. 1382, 1947.
15. Esvard, John C.: Theoretical Distribution of Lift on Thin Wings at Supersonic Speeds. (An Extension). NACA TN No. 1585, 1948.
16. Heaslet, Max. A., Lomax, Harvard, and Jones, Arthur L.: Volterra's Solution of the Wave Equation as Applied to Three-Dimensional Supersonic Airfoil Problems. NACA TN No. 1412, 1947.
17. Busemann, A.: Infinitesimal Conical Supersonic Flow. NACA TM No. 1100, 1947.

18. Allen, H. Julian: General Theory of Airfoil Sections Having Arbitrary Shape or Pressure Distribution. NACA Rep. No. 833, 1943.
19. von Mises, Richard, and Friedrichs, Kurt O.: Fluid Dynamics, Brown University Press, 1942. pp. 125-128.
20. Lagerstrom, P. A., and Graham, Martha E.: Downwash and Sidewash Induced by Three-Dimensional Lifting Wings in Supersonic Flow. Douglas Aircraft Co., Inc., Rep. SM-13007, Apr. 1947.
21. Heaslet, Max. A., and Lomax, Harvard: The Calculation of Downwash Behind Supersonic Wings With an Application to Triangular Plan Forms. NACA TN No. 1620, 1948.
22. Wagner, Herbert: Über die Entstehung des Dynamischen Auftriebes von Traflügeln. Z.f.a.M.M., Bd. 5, Heft 1, Feb. 1925, S. 17-35.
23. Cohen, Doris: The Theoretical Lift of Flat Sweptback Wings at Supersonic Speeds. NACA TN No. 1555, 1948.