

# REPORT DOCUMENTATION PAGE

Form Approved  
OMB No 0704-0188

Public reporting burden for this collection of information is estimated to average 1 hour per response, including the time for reviewing instructions, searching existing data sources, gathering and maintaining the data needed, and completing and reviewing the collection of information. Send comments regarding this burden estimate or any other aspect of this collection of information, including suggestions for reducing this burden, to Washington Headquarters Services, Directorate for Information Operations and Reports, 1215 Jefferson Davis Highway, Suite 1204, Arlington, VA 22202-4302, and to the Office of Management and Budget, Paperwork Reduction Project (0704-0188), Washington, DC 20503

<b>1. AGENCY USE ONLY (Leave blank)</b>		<b>2. REPORT DATE</b> 17Oct1996	<b>3. REPORT TYPE AND DATES COVERED</b> FINAL REPORT	
<b>4. TITLE AND SUBTITLE</b> ILARTS Imaging Sensor for Day/Night Aircraft Approach and Landing			<b>5. FUNDING NUMBERS</b>	
<b>6. AUTHOR(S)</b> John L. Lowrance and Stephen R. Smith				
<b>7. PERFORMING ORGANIZATION NAME(S) AND ADDRESS(ES)</b> Princeton Scientific Instruments, Inc. 7 Deer Park Drive, Monmouth Junction NJ 08852			<b>8. PERFORMING ORGANIZATION REPORT NUMBER</b> TR-96-015	
<b>9. SPONSORING/MONITORING AGENCY NAME(S) AND ADDRESS(ES)</b> Naval Air Warfare Center, Aircraft Division Lakehurst, NJ 08733-5083 TPC: Ralph Smith, Code 4.8.1.3			<b>10. SPONSORING/MONITORING AGENCY REPORT NUMBER</b>	
<b>11. SUPPLEMENTARY NOTES</b> SBIR Contract: N68335-96-C-0095				
<b>12a. DISTRIBUTION/AVAILABILITY STATEMENT</b>			<b>12b. DISTRIBUTION CODE</b>	
<b>13. ABSTRACT (Maximum 200 words)</b> <p>Television cameras utilized by aircraft carrier Landing Signal Officers (LSO) need to provide good imagery, day and night, under conditions where the aircraft is illuminated by ambient light but the aircraft's bright landing lights are on, resulting in intra-scene dynamic range of <math>\sim 10E6</math>. These TV cameras provide the LSO with glide-slope and lineup information, and also view deck operations, approaches, and launches. This application, vital to aircraft carrier operations, needs a television image sensor and camera system to replace the Image Isocon based cameras which are no longer manufactured. The television image sensor affording the necessary dynamic range is the Charge Coupled Device (CCD). Their high quantum efficiency and low readout noise make CCDs competitive at low illumination levels with intensified image sensors and provide superior performance at moderate and high light levels. The conclusion of this Phase I study is that a camera based on back illuminated CCD technology can match and in some cases exceed the benchmark Image Isocon camera performance in the demanding ILARTS application.</p>				
<b>14. SUBJECT TERMS</b> télévision, night vision, CCD image sensors			<b>15. NUMBER OF PAGES</b>	
			<b>16. PRICE CODE</b>	
<b>17. SECURITY CLASSIFICATION OF REPORT</b>	<b>18. SECURITY CLASSIFICATION OF THIS PAGE</b>	<b>19. SECURITY CLASSIFICATION OF ABSTRACT</b>	<b>20. LIMITATION OF ABSTRACT</b>	

FINAL REPORT  
SBIR Phase I, Topic N94-1544

**ILARTS IMAGING SENSOR FOR DAY/NIGHT  
AIRCRAFT APPROACH AND LANDING**

Princeton Scientific Instruments, Inc.  
7 Deer Park Drive  
Monmouth Junction, NJ 08852

Report No. TR-96-015

Contract N68335-96-C-0095  
Naval Air Warfare Center Aircraft Division  
Lakehurst, NJ 08733-5083

October 17, 1996

20000907 110

# TABLE OF CONTENTS

- I. OVERVIEW
- II. THE PROBLEM
- III. PERFORMANCE AND LIMITATIONS OF PRESENT SYSTEM --  
GENERAL DISCUSSION
- IV. PERFORMANCE AND LIMITATIONS OF PRESENT SYSTEM --  
LABORATORY OBSERVATIONS
- V. IMPROVED CENTERLINE CAMERA -- DISCUSSION
  - a. Detector
  - b. Optics Design
  - c. Signal Processing
- VI. IMPROVED CENTERLINE CAMERA -- PROPOSED DESIGN
  - a. Custom CCD Sensor
  - b. Camera Optics
  - c. Signal Processing
  - d. Configuration
  - e. Possible Extensions to System
  - f. Cost Considerations

## VII. TABLES AND FIGURES

Table 1. Wide Dynamic Range Imager

Figure 1. Internal Structure of Typical SIT Tube

Figure 2. Measurements of Image Spreading

Figure 3. Spectral Responses of CCD and S-20 Detectors

Figure 4. Signal-to-Noise Ratio of Image Isocon

Figure 5. Relative Spectral Intensities of Moonlight and Starlight Illumination

Figure 6. Relative Responses of CCD and S-20 Sensors in Moonlight and in Starlight

Figure 7. Signal-to-Noise Ratios of CCD and Image Isocon Detectors

Figure 8. Cross-section of DSRC Back-Illuminated CCD Detector Technology

Figure 9. Architecture of Frame Transfer CCD Imager

Figure 10. Cross-section of Buried Anti-Blooming Drain Structure

Figure 11. Ratio of Blooming Drain Current to Signal Current

Figure 12. Quantum Efficiency of DSRC Back-Illuminated CCD Detector

Figure 13. Configuration Sketch

Figure 14. Block Diagram of CCD Camera

## **I. OVERVIEW**

The ILARTS System is used on board aircraft carriers to obtain and distribute television camera video images of various aircraft-related operations, including launch, recovery, and flight deck operations. While other cameras are used to monitor operations on the flight deck, this report is concerned mainly with the performance requirements of the center-line cameras, which are mounted below the deck and image a fixed field of view directed along the nominal glide path for aircraft on landing approach. The center line cameras provide information on aircraft types and sizes, and on their positions relative to the angle-deck centerline and the glide slope. They must operate both during daytime and at night. At night, it is especially important that they provide the best possible images to the Landing Signal Officer, and to various other command and technical centers.

The centerline cameras are also used, especially at night, as aids in verifying status of landing gear, hook and hanging ordnance. For this reason, low-light-level performance is critical in judging the efficacy of the cameras, and will be the starting point for the following analyses and proposals.

This proposal considers the advantages of CCD sensor technology for the centerline camera application. Requirements are analyzed and discussed for the sensor, the optics, and the electronics elements of the overall system, and a specific proposal is made for a system which should offer excellent performance, technical simplicity, and low cost.

## **II. THE PROBLEM**

In the ILARTS application, it is important to see with reasonable fidelity the understructure of an approaching aircraft, which is illuminated only by weak ambient sources (moon or star light), or by glare or reflected light coming from the carrier or from scattering in the atmosphere around the carrier or the aircraft. An analysis and complete characterization of actual illumination levels would be extremely difficult, given their great variability. It is sufficient to say that it is desired that the centerline cameras provide usable images down to as low a light level as possible.

Systems designed for high sensitivity in low-light-level (LLL) imaging often have difficulty in imaging high-intensity point sources which may be present in an otherwise low-intensity field of view (FOV). During night-time operations, the under carriage and other weakly-illuminated features of the image of an approaching aircraft may be hidden by the relatively bright light coming from its own navigation or approach lights. As the aircraft gets closer and closer, the integrated flux level contributed by these lights may increase to very high levels, while the illumination levels of the structures which must be viewed remains constant. The flux from the point sources may be diffused or spread in the image plane by atmospheric scattering, by undesired reflection, scattering, or diffraction within the optics, or by optical or electronic spreading within the image detector. The result may be that the light from a point source spreads over a large portion of the entire image area, obscuring the image system's view of the structural detail.

## Critical Challenges

Sensitivity is often quoted as the decisive performance parameter for a LLL sensor. However, it is accepted in the field that other measures are more useful. For example, the output signal level, and hence the sensitivity, of any system may be increased by changing the gain of some final amplifier stage. However, if the front end of the system is photon-limited, so that the detected image consists of only a modest number of single-photoelectron events, no amount of increase in gain or output sensitivity can improve the information content of the image -- all that results is a brighter scintillation pattern, and not an increase in the ability to perceive the underlying structure in the image.

Generally, human perception of structure in a visual field has been shown to require a minimum peak signal-to-rms noise ratio of approximately 5:1 at each discernable point in the image. Thus, signal to noise ratio (SNR) as a function of illumination level is usually a better measure of system performance than is sensitivity.

As will be argued below, the SNR of candidate systems for the present LLL application depends above all on the optical entrance aperture area and transfer efficiency (i.e., on the number of photons captured per second from a given source) and the detector quantum efficiency (i.e., the number of signal photoelectrons created per captured photon). The product of these two basic parameters determines the number of signal electrons per pixel in any given situation. Shot noise, which is equal to the square root of the number of signal electrons, then sets a fundamental limit on the SNR ratio which the system can then achieve. The first challenge is to acquire the signal at each pixel with maximum SNR. Only then can one hope to display the maximum amount of information. (Signal processing and display challenges will be discussed below.)

Given the problem of bright lights in the FOV, and that of widely varying general illumination levels, the ideal detector for the centerline camera system must not only achieve near quantum-limited SNR at low light levels, but must do so over a wide range of intensities. The FOV may have a very low general level of illumination on a moonless night, or any higher level up to full sunlight conditions. Within a FOV containing generally low illumination levels, the image of a weakly-illuminated aircraft undercarriage may be superposed on the "skirts" of the signal produced by a bright point source. These requirements imply that the ideal system must have an extremely wide dynamic range, and that this wide dynamic range must be achieved not solely through slow system adjustments, such as changing acceleration voltages or iris settings, but must be available instantaneously, on an intra-scene basis.

With bright lights in an otherwise dimly-illuminated FOV, image-spreading problems may be produced by both the optics and the detector. Multiple reflections within the optics may produce ghost images. Scattering from aperture-defining edges, or by inhomogeneities within the glass or the anti-reflection coatings of the glass elements, may cause a point image to spread significantly. Even within the detector, light may scatter and be detected at locations remote from the position of the image of a point source. In addition, photoelectrons or secondary charges produced by the detection of the incident photons may spread in space. All these effects must be considered in addressing the

centerline camera design problem. Careful lens design (for example, minimizing the number of glass-air interfaces in the optical train and providing for effective anti-reflection coating over the entire range of wavelengths to which the detector is sensitive) is necessary, and the choice of detector may be influenced by internal optical considerations.

A final fundamental consideration for the centerline camera system follows from the observation that the most important use of the information which it generates involves real-time visual observation of the image as presented on a television monitor. Due to its own dynamic range limitations, and to the perceptual characteristics of human sight, no TV monitor can hope to present all the information contained in even a moderately wide dynamic range image. In standard television image processing, it is standard to use non-linear processing to improve the perceived image at the monitor. (For example, the voltage signal presented to the monitor may be made proportional to the square root of the sensor signal level, rather than to its value directly.) More innovative signal processing is clearly desirable in the present application, where there may be wide variations in the levels and ranges of intensities present in a given image, and even an independent variation in the parts of the overall range of intensities which convey the most important structural information.

### **III. PERFORMANCE AND LIMITATIONS OF PRESENT SYSTEM -- GENERAL DISCUSSION**

The centerline cameras presently used in the ILARTS system use silicon intensifier tube (SIT) technology. These vacuum tube detectors, also known as silicon electron bombardment induced-response (SEBIR or SiEBIR) tubes, provide front-end gain through a high-voltage acceleration of the photoelectrons followed by the generation of multiple electron-hole pairs in a silicon solid-state diode target by each photoelectron. This gain, together with the low noise of the amplification stage inherent in the vacuum gain process, provides high sensitivity and near single-photon detection capability. However, the semitransparent cathode technology used in these vacuum imagers limits the peak quantum efficiency (QE) to ~20%, which in turn limits the number of detected photoelectrons, and hence the signal-to-noise ratio, at any given level of illumination. Further, in comparison with the high-QE silicon CCD detector technology which will be proposed below, the SIT tube's photocathode is insensitive at near-IR wavelengths in the range of 650 to 850 nanometers, and thus suffers a further penalty in effective QE.

There are other limitations inherent in the SIT technology which are important to the centerline camera operation. The detector can be damaged by high intensity levels at either the photocathode or the silicon target structure. As a result, the SIT tube depends on reducing the acceleration voltage and stopping down the external iris whenever there is either a bright small object in the FOV or the general illumination increases beyond specified levels. Two undesirable effects follow -- (1) the detector reduces its gain when an unusually bright spot appears in the FOV, and no longer offers high sensitivity for viewing dimly-illuminated structure at other locations in the FOV and, (2) at any illumination level, no matter how high, the high photoelectron gain, modest QE, and iris-limited photon rate combine to give an objectionable level of quantum noise in the image.

The SIT tube is also inherently subject to internal optical problems. Figure 1 shows the internal structure of a typical SIT tube. Achieving reasonable QE with the semitransparent cathode requires that a substantial percentage (typically 50%) of the incident flux pass through the cathode plane into the image compartment. This light may scatter back to the photocathode and produce a diffuse general background signal which drastically increases the background noise and limits the dynamic range for regions outside the image of a bright point source.

#### **IV. PERFORMANCE AND LIMITATIONS OF PRESENT SYSTEM -- LABORATORY OBSERVATIONS**

A laboratory system was set up to simulate the optical conditions appropriate to the centerline camera operation. Using green LED's, a bar pattern was illuminated at levels approximating that of an airplane's undercarriage under full moon night-time conditions, or below. Small LED's were also set up to simulate the navigation lights on an airplane's rudder and wingtips, and could be powered at levels to simulate the centerline camera's illumination for airplane ranges from 2 kilometers down to approximately 20 meters. Other LED's were used to create an extended source which could produce an intensity at the camera location comparable to that of various bright objects. Finally, an extremely bright incandescent fiber-optic source was used to simulate the intense illumination which the centerline camera might experience if other landing or taxi lights were turned on while the aircraft was in the camera's FOV.

Laboratory observations confirmed that the present ILARTS SIT-tube based system shows the gain reduction, scattered illumination, and image-spreading problems described above, and that it has a relatively small intra-scene dynamic range. Undesirable gain reduction (and iris stopdown) occurred at intensities clearly of interest in field situations. Images of bright point sources spread over large portions of the monitor display, and could easily hide the information content of an otherwise clear image of the weakly-illuminated bar chart.

For comparison, several CCD camera systems were set up to view the same laboratory scene as the SIT-tube system. All the cameras were fitted with lenses which gave similar fields of view, and used the same  $f$ /number, as the SIT camera.

Signal-processing electronics for the camera signals were modified to allow up to 60-fold increase in gain, and sufficient DC offset that an oscilloscope or TV monitor display could be used to look for image detail structure over an extremely wide range of optical intensities. Using these electronics, it was confirmed that the SIT system had a limited dynamic range and a relatively low SNR at high levels of illumination. Further, it was demonstrated that the signal from the CCD cameras, which would be expected to have a much greater dynamic range, contained much more information than could be displayed on the monitor at any one setting of the controls. (See the discussions below on non-linear signal processing opportunities.)

CCD cameras used in the laboratory testing included a new Panasonic 1/3" format camera, which we understood was being used for some field tests relative to ILARTS. This industrial-grade camera

uses a relatively small CCD chip and hence required a short focal length, therefore small acceptance aperture, lens. Also, an older RCA CCD camera was tested, which used a modestly larger CCD. With the longer focal length lens required to give the same FOV, the RCA camera should have been significantly more sensitive than the Panasonic. Unfortunately, differing electronic gains and noise levels in the two cameras prevented confirming the expected differences in SNR.

The Panasonic CCD image sensor was the standard front-illuminated interline-transfer variety. Images of bright point sources with this camera showed considerably more spreading and objectionable radial artifacts than were found in images acquired with the RCA sensor, which was a frame-transfer CCD device. These observations reinforced the initial presumption that the optimum choice for the centerline camera application is a frame-transfer, back-illuminated CCD.

A detailed investigation was made to determine the causes of the spreading evident in images of a small, extremely bright, source in the FOV. This spreading, which could completely obscure a weak background image in the SIT system, was present to a much lesser extent in the setups using cameras with CCD sensors. An experiment was conducted to determine whether the image spreading in the RCA back-illuminated CCD camera was caused by the sensor, or by the camera lens.

Figure 2 shows the relative signal level as a function of position in the "wings" of the CCD image of an extremely bright source, over more than 5 orders of magnitude. The solid circles show the signal as a function of position along the CCD scan line passing through the center of the image. To determine if this spreading was caused by the image sensor or by the optics, a scan was made across the same image plane with a simple silicon photodiode detector preceded by a small aperture. The open circles and squares in Figure 2 show the excellent agreement between this data and that from the CCD. (The peak broadening for the photodiode data is due to the size of the aperture.) This agreement demonstrates that, even with the low-flare commercial lens used in this test, image spreading is due primarily, if not entirely, to the optics rather than the CCD detector. Although the CCD system already behaves better than the SIT tube in terms of image spreading, it was concluded that optics designed for lowest possible flare can provide a significant further reduction in image spreading ("flare") problems in the centerline camera application.

## V. IMPROVED CENTERLINE CAMERA SYSTEM -- DISCUSSION

As indicated in the preceding discussions, there are several fundamental areas in which improvements are required relative to the performance of the present SIT-tube based centerline camera technology. Any new camera system design must consider the following items, from the beginning:

- Acceptance Aperture Area
- Detector Quantum Efficiency
- Detector Spectral Response
- Detector and Readout Noise Characteristics
- Optical Transfer Efficiency
- Optical and Electronic Image Spreading

## Signal Processing Techniques

No "magic solution" exists in any one, or even in any two, of these independent areas. They all need to be considered in the design effort.

The present SIT-tube system's performance is considerably poorer than that of the previously used, but no longer available, Isocon vacuum tube imaging technology. The physical reasons for this were explored fully in the Phase I SBIR Proposal. Without repeating the arguments of the Proposal, it can be said that there is no area of detector performance in which the SIT tube is preferable to the Isocon for the present application. All of the advantages, and all of the disadvantages, of the semitransparent cathode, vacuum tube, physics, are present in both devices. Further, the intrascene dynamic range of the SIT tube is extremely limited.

In addition to the fact that theoretical arguments show that the Isocon tube performance exceeds that of the SIT tube, there is practical experience showing that Isocon system performance was not only better, but in general was adequate to the Navy centerline camera (or Landing Signal Officer's) needs. Given this, the analysis presented in the following sections compares the performance of the recommended CCD-based technology with that of Isocon's rather than SIT tubes.

As a starting point, it may be observed that the peak QE of a CCD detector can be more than four times higher than that of the SIT or Isocon tubes, which employ semitransparent photocathodes. (Typical figures might be 80% or greater compared to a maximum of 20% for S-20 photocathodes.) Further, the broader spectral response of the CCD allows an even greater advantage for most natural sources of illumination.

Relative to the S-20 photocathode spectral response of the Isocon (and SIT) tubes used previously, the solar spectrum is relatively rich in the red end of the visible region, and also in the near IR. The vacuum sensors thus miss a large fraction of the photons which are detectable by CCD image sensors. Figure 3 shows the two spectral responses, while Figure 4 indicates the relative spectral contents of moonlight and of sunlight. In broad terms, ten times as many photoelectrons are generated in a CCD illuminated by the solar (or moonlight) spectrum as by an S-20 photocathode. On a moonless night, the even richer long wavelength spectral content of the night sky, makes the spectrum-generated QE advantage of the CCD even greater -- approximately fifty-fold.

Because of their electron multiplication gain processes, the Isocon and SIT vacuum tube technologies offer extremely low noise amplification at the lowest light levels. Noise floors can be 1 photoelectron per pixel at normal temperatures and readout rates. Although the use of on-chip amplification at the output of a CCD sensor photoarray allows for minimal capacitance, and hence much lower noise floors than would be possible with off-chip preamplification, CCD readout noise floors are in the range of 20 to 40 photoelectrons at broadcast video bandwidths.

It is important to stress that the noise advantage of the vacuum tube sensors disappears above very low illumination levels. This is because of the lower effective QE, which results in a significantly

lower number of photoelectrons generated per pixel during an exposure time. The shot noise in the signal, which is equal to the square root of the number of photoelectrons, must be added quadratically to the readout noise, and give a clear advantage to CCD detectors at all but the lowest integrated intensity levels. As will be shown below, a properly-designed CCD detector system will perform better than the Isocon or SIT-tube based systems at any intensity which is adequate to give a visually useful image.

Given the assumed use of a CCD detector in a future ILARTS centerline camera system, the first major consideration is sensor area. For a given FOV and focal ratio, the acceptance aperture of an optical system is proportional to the image sensor area. This is because the FOV and chip size determine the focal length. A larger chip implies a longer focal length and, at fixed focal ratio, a larger acceptance aperture. For the centerline camera, a balanced design must make effective use of the available aperture in the flight deck, with further increases in chip size balanced off against sensor technology and cost considerations.

It is clear that improved optics can significantly reduce ghost images, flare, and stray light problems compared to the present system. Properly-chosen CCD technology can essentially eliminate any problem with image spreading in the focal plane.

With optimal CCD and optics designs, a new system can offer not only excellent sensitivity, but also an extremely wide intrascene dynamic range. In order to make use of the information available from the sensor, new and innovative processing techniques must be developed and applied to the signal before sending the final image to the LSO's monitor.

The following subsections will discuss detector, optics, and signal processing requirements in more detail.

#### **V-a. Detector**

As the preceding paragraphs have stressed, it is absolutely critical in striving for low light level performance not to use a sensor whose area is smaller than the optimum, since a smaller chip leads to a smaller acceptance aperture, fewer photons and photoelectrons, and thus a lower signal-to-noise ratio in the detected image.

The next consideration in choosing a CCD is quantum efficiency and spectral response. The most common CCD technology involves front illumination and interline transfer. Front illumination refers to the fact that light enters the photosensitive pixel volume through the face of the silicon wafer on which all of the photolithographically-produced layers were created. The result is a chip that is inexpensive to manufacture, but that has undesirably low QE. This is caused by blockage and absorption of radiation in the structures overlying the photosites in the silicon chip. Interline transfer implies that the charge packets are read out along CCD "bucket brigade" storage registers which lie between each line of photosites. This also has negative implications for sensitivity.

The preferred type of CCD chips for low light level applications are thinned, back-illuminated devices. In this technology, the electronic structures are processed from one side of the silicon substrate, in whatever complexity is desired. After processing is essentially complete, the processed side of the silicon substrate is mounted on a backing plate, and the original silicon substrate thickness at the opposite face is etched away. The resulting sensor is extremely thin and, when illuminated from the thinned side, can have nearly 100% effective photosensitive area. It also captures many more photoelectrons from a given illumination source, due to lowered absorption in the reduced-thickness surface layer. Peak QE's of these devices can be as high as 90%, compared to 30 or 40% for a typical front-illuminated device.

Back illumination and high QE and fill factor also require that the image information not be read out on an interline basis. Rather, the entire frame from an exposure is shifted during the vertical blanking period to a two-dimensional CCD storage register located on the chip abutting the image area. (This is illustrated schematically in Figure 9.) The pixels of this stored image are read out sequentially while the next frame is being exposed. Since the image area's pixels remain sensitive to light as a frame is shifted into the storage area, these "frame transfer" devices must be shuttered off during the vertical shifting from A to B, to prevent a bright source in the FOV from generating a vertical streak in the image as it is moved into the storage register. This shuttering is implemented in commercial cameras using a rotating disc with open and opaque areas, synchronized with the vertical blanking of the video signal.

Because of the much-reduced density and complexity of structures overlying the sensitive layer of back-illuminated devices, compared to the standard low-cost technologies, problems with back-scattering or diffraction-induced spreading of light between pixels are essentially eliminated. This is an important advantage of the frame transfer devices in the centerline camera application.

A bright point source of light in an otherwise dimly-illuminated FOV may, of course, heavily oversaturate the stored charge capacity of an individual pixel. In the earliest CCD devices, this excess charge leaked into adjacent pixels, creating a "blooming" of high-intensity regions of an image. Current CCD technology uses antiblooming drains for excess charge at each photosite, and is generally quite effective at eliminating blooming. The particular CCD technology which will be discussed below is exceptionally effective.

For the present application, where the final output is to a television monitor, standard CCD technologies can give excellent spatial resolution and contrast, or modulation transfer functions (MTF), without any special requirements which must be met.

Low readout noise has become quite standard for CCD image sensors used in challenging applications. RMS figures of 20 to 40 electrons may be routinely achieved.

The following paragraphs present a quantitative analysis of the performance to be expected of a CCD chip optimized for the centerline camera application. In terms of low light level performance, the key advantage of the CCD is its high QE and broad spectral response.

## Sensitivity of CCD Camera Compared to Image Isocon

The benchmark for the centerline camera in terms of demonstrated acceptable performance is the ILARTS cameras made with Image Isocon television camera tubes, which are no longer manufactured. Therefore it is appropriate to compare the anticipated performance of a CCD image sensor based camera with this Image Isocon camera to assess the efficacy of the design in meeting the ILARTS requirements. The Image Isocon had two important attributes: (1) readout noise that was near the quantum shot noise limit, and (2) saturation characteristics such that bright lights in the field of view did not result in excessive electronic blooming (flare) in the video image.

As discussed in other sections of this report, the Sarnoff CCD design selected for this design study has excellent intrascene dynamic range saturation characteristics, with a linear dynamic range that exceeds the Image Isocon and saturates with very little blooming. The key remaining question then is: How does its low light level signal to noise ratio compare to that of the Image Isocon?

Figure 4 shows the signal to noise ratio of the RCA C21093A Image Isocon. This 3 inch diameter tube had a 36 mm diagonal image area. One notes a ratio of peak-to-peak signal to RMS noise current of 20 dB at a photocathode illumination of  $3.5 \times 10^{-4}$  lumens per square foot and a video bandwidth of 4.2 MHz. For the 36 mm diagonal with 3 x 4 aspect ratio image area, the image area is 6.22 square cm, or 0.0067 square foot. Thus the photocathode illumination in the above case is  $2.3 \times 10^{-6}$  lumens. A lumen is equal to  $1.47 \times 10^{-3}$  Watts at the 550 nm peak of the standard luminosity curve. This is also equal to  $4.11 \times 10^{15}$  photons per second at this wavelength. Using these figures one can show that the Image Isocon's signal to noise ratio very closely matches the function

$$S/N = k * ((Q_e)(\#photons/pixel))^{1/2}$$

for values of quantum efficiency,  $Q_e = 0.1$  and electron multiplier noise factor, "k" = ~0.7. This is within the square root of 2 of shot noise limited theoretical performance, that can only be improved by increased  $Q_e$  over a broader spectral range.

Figure 5 shows the spectral content of night sky radiation, and also the spectrum of moonlight (which is essentially the same as that of sunlight). Figure 3 gives the spectral response of the S-20 photocathode employed on the Image Isocon and the spectral response of a state-of-the-art back illuminated CCD with an anti-reflection coating. The products of these spectral responses curves and the radiation curves, shown in Figure 6 highlight the suitability of the silicon back illuminated CCD detector for nighttime imaging applications, where the ambient illumination is rich in the red and near infrared.

The back illuminated CCD produces ~10 times the number of signal photoelectrons that the Image Isocon's S-20 photocathode produced under moonlight, which is spectrally equivalent to sunlight. And in the red-rich moonless night sky case the factor is ~50. This is the primary reason that the proposed CCD can produce low light level imaging equal to or better than the Image Isocon.

To be rigorous about this comparison of sensitivity, one must also include the relative size of the image format in both cases. At the same optical focal ratio, the number of photons incident on the image plane is proportional to the area of the image plane. Recalling that the 3 inch Image Isocon had an image area that was 6.22 square cm., this comparison assumes that the CCD image raster is also this area. While CCDs have been made this large for scientific imaging applications, the image area of CCDs used in commercially available television cameras is usually much smaller. This is because the manufacturing costs of the CCD and the camera lenses are then also much smaller. In the ILARTS application the performance of the camera is important to the safety of personnel and aircraft, therefore camera cost tradeoffs are made on a quite different basis. We have assumed for this design study that the CCD focal plane is 2.4 square cm. which is 40% of the area of the 3" Image Isocon. In this case the back illuminated CCD would produce ~4 times the number of signal photoelectrons that the Image Isocon produced under moonlight conditions, at the same optical focal ratio and field of view. Figure 7 compares the signal to noise ratio of the Image Isocon and back illuminated CCD as a function of exposure level for both moonlight and night sky illumination spectral conditions. The S/N of the CCD is plotted for a readout noise of 20, 30 and 40 electrons per pixel rms. One notes that the back illuminated CCD provides a significantly higher S/N for all exposure levels where the S/N is greater than 5, the threshold where images become useable to the observer.

#### V-b. Optics Design

As was stressed above, the fundamental key to achieving the best possible system SNR is collecting and detecting as many photons as possible. For the optics, this implies that the acceptance aperture should cover most of the area available in the window/housing assembly mounted in the flight deck. This window is nominally a rectangle 0.9 inches high by several inches wide. Below an optical acceptance diameter of 0.9 inches, system acceptance increases quadratically with diameter. Much above 0.9 inches, it increases only linearly. A reasonable balance of cost suggests an acceptance diameter in the range of 2 inches.

We assume that, for any focal length, the lens which is required for the centerline camera system will have a focal ratio of f/1.4. (This is an aggressive, but fairly commonly achieved, focal ratio for camera lens designs.) With a fixed FOV of 11 by 15 degrees, the optical acceptance aperture is then determined by the detector size.

The system proposed outlined below assumes the following parameters:

Field of View	11 x 15 degrees
Detector Size	18 x 13.5 mm
Focal Length	70 mm
Focal Ratio	f/1.4

The nominal lens acceptance diameter is then 2.0 inches. Mounting behind the 0.9 inch window gives an acceptance area of 11 square centimeters, roughly half the nominal area.

For comparison, the small CCD chip used in the Panasonic camera which was used in the lab experiments was only 4.8 x 3.6 mm. At the same FOV, this implies a focal length of 19 mm, and an f/1.4 lens of this focal length has an acceptance aperture area of only 1.4 square centimeters. This reduction, of almost a factor of 8 in area, illustrates the importance of having a relatively large detector for use in the optics design.

With the lens focal length and focal ratio fixed, the system designer needs optimal transmission and minimal generation of stray light from bright point sources in the FOV. These considerations argue first for a minimum number of optical elements in the lens, and especially the minimum number of glass/air interfaces. In this respect, any system which uses relay lenses in addition to its primary lens is highly suspect.

Partial reflections from the polished surfaces of the lens elements must be reduced by anti-reflection coatings. In order to take advantage of the IR sensitivity of CCD detectors, these coatings (and the lenses themselves) must be designed to cover a wider range of wavelengths than standard visible-light imaging lenses.

Multiple reflections from the lens surfaces will, in general, form "ghost" images somewhere within, in front of, or behind the lens elements. Although it is not normally an important consideration in lens design, the present application requires that these images not be located near the focal plane of the system. This requirement may usually be accommodated in the lens design process, as long as it is clearly understood from the beginning. (In some cases, tilting the lens relative to the line joining the centers of the FOV, the lens, and the image, can be used to move a bothersome ghost image outside the sensitive area of the detector.)

Finally, there is the complex problem of low-level spreading of the optical energy from a bright point source, which ideally would be contained entirely within a small spot in the image plane. For the TV systems considered here, the fundamental aperture diffraction limit is not a concern. More practical problems, such as inhomogeneities in optical glasses or coating layers, or microstructure resulting from imperfect polishing, may require higher than usual standards at all steps in lens fabrication.

Light scattering can also occur within a complex optical system whenever the incident rays strike any defining edge in the lenses, field stops, or mechanical structures. Careful attention must be paid to these effects throughout the optical design process. It is usually possible to design a system in which there is a single defining field stop. This stop can then be designed for minimum scattering. For example, it can be made extremely thin, so that there is minimum scattering from the small edge thickness, by making it an evaporated film, rather than a metal diaphragm. In extreme cases, it may even be useful to "apodize" the field stop, by blurring the edge of the evaporated film from which it is fabricated, in order to reduce diffraction effects.

The purpose of the discussions of the preceding paragraphs is not to finalize a lens design, but simply to stress the importance of a careful (presumably custom) lens design for the intended application. In summary, optimum system performance requires that we consider the following in the optics

design process:

Avoid the use of relay optics

Minimize the number of optical elements, and especially of glass/air interfaces

Use wide-band VIS/IR antireflection coatings

Check and modify initial lens designs to control the positions of ghost images

Control glass uniformity, polishing standards, coating materials and structure, etc., beyond the level normally required, in order to minimize scattering within the body of the lens

Design the lens and its supporting structures to control the number and nature of all apertures which intercept the incident rays which contribute to the image, within or in the vicinity of the active sensor area.

### **V-c. Signal Processing**

While the intrascene dynamic range required of the centerline camera is very high, and the range of general scene illumination varies greatly under varying conditions, the TV monitor on which the image is displayed has an extremely small dynamic range.

The CCD camera system detailed in the following Section may offer a dynamic range greater than 30,000:1. Depending on viewing conditions, a video monitor's dynamic range may be between 10:1 and 100:1. As was confirmed in the laboratory, using customized electronics, the CCD image signal may contain much more information than can be displayed on the monitor using standard signal processing. Innovative, non-linear processing techniques which go far beyond the usual automatic control of gain and iris settings will greatly enhance the performance of the proposed new system.

In broad terms, we believe that non-linear analog signal compression should occur early in the video electronics chain, and that the signal should then be digitized for flexible processing. Then, the modified digital image would be converted back into an analog RS170 signal for transmission to the monitors. (Of course, a future viewing system might take advantage of the digital video signal, and offer improved performance at the monitor end.)

Analog signal compression allows quantum-limited sensitivity at the low end of the intensity range, without allowing the shot noise present at high intensities to dominate the final range of output signal levels. (A square-root processor, for which the output of an amplifier stage is made proportional to the square root of its input, produces a signal in which equal steps in voltage correspond to equal increments in terms of rms shot noise. Then the noise introduced by digitizing such a signal can be made less than the shot noise throughout the intensity range.

Analog non-linear compression may be accomplished at video bandpasses using either "square-rooter" modules or customized multiple-breakpoint diode arrays in the feedback circuit of a video amplifier. After compression, digitizing the signal to the level of perhaps 12 bits can be accomplished at video pixel rates, and still represent the entire range of input signals. (Without compression,

digitizing a signal with a dynamic range of 30,000:1 would require 16 bits, and would be difficult to accomplish at standard video rates.)

Once the signal has been acquired in the digital domain, there are many ways to process the information content to increase its visibility on the final monitor. Edges may be enhanced by spatial filtering (using either local differentiation or "unsharp masking" subtraction of local average intensities from individual pixel values). The transfer function relating raw or processed digital images values to RS170 voltages may be modified with infinite flexibility simply by reloading values in a 12 bit in/ 8-bit out look up table (LUT) immediately prior to the conversion back to analog voltages. LUT techniques can be used to emphasize any desired portion of the intensity range, and constitute a powerful generalization of the standard brightness/contrast (and "gamma," or power law exponent) controls.

The digital system which is used to process the wide-dynamic-range system can, of course, be controlled manually. Or it could use the information present in the image to automatically control its own parameters (and even the iris of the lens). For example, "histogram processing," in which a histogram of pixel values is generated from an image and used to control the LUT values, could be used. In this way, one might hope to use the available display dynamic range to present the most important regions of the picture with highest contrast. (A description of histogram processing follows. However, while such processing can be extremely useful, great care will have to be exercised in applying it to nighttime centerline camera images, where small areas of extremely high intensity and modest areas of low intensity must be viewed against a field of generally even lower (and uninteresting) intensity.

It is an advantage of the digital signal processing concept that the system can be configured with great flexibility. Manual control could be exercised over extremely wide ranges of parameters. Automatic processing with a range of algorithms could be implemented, tested under field conditions, and modified simply by changes in the camera software.

### **Description of Histogram Processing (from Sarnoff Research Center)**

Sarnoff's Imaging Systems Laboratory has been developing real time DSP hardware for digital video image processing. Contrast enhancement using adaptive nonlinear gray scale mapping techniques have been used to maximize the information content in visible and medium wave infrared (MWIR) displayed video. Our systems do not transform the data within the DSP block but alternatively load a look up table (LUT) during vertical blanking resulting in both a reduction in cost and complexity and a flexibility to load non-adaptive LUTs. By examining the incoming video's gray scale distribution and employing techniques such as Histogram Equalization (HE), Histogram Projection (HP) and Histogram Plateau Equalization (PE) the entire display gray scale space can be optimally exploited for each incoming frame. Alternatively, static LUTs can be loaded to invert the video, provide gamma transfer functions (H&D curves), contrast stretch using logarithmic mappings or do bit plane slicing for image segmentation.

A histogram is a discrete function which maps a digital image with gray levels in the range  $[0, L-1]$  by the number of pixels occupying that gray level. Loosely speaking, the value of the histogram at that gray level represents the probability of occurrence at that brightness and gives a global representation of the image. By calculating the Cumulative Distribution Function (CDF) which represents the probability that the pixel will be at or below that gray level, the function, which ranges from  $[0, 1]$ , can be scaled for any display dynamic range required and can be matched with any dynamic range input device. The HE routine generates a complete histogram to perform the mapping while an HP routine generates a binary histogram which puts a one at any gray level locations where there are any pixels at that brightness level and a zero where there are no pixels at that brightness. The benefit of using Histogram Projection is when the contrast of a small target on a uniform background needs to be enhanced. The background distribution and the small target distribution are considered equally in the Projection routine while the Histogram Equalization routine will enhance the contrast in proportion to the size of the object and enhance the detail of the background much more than the small target. The Plateau Equalization routine sets plateau levels that clip the histogram strength offering a compromise between HP and HE.

## **VI. IMPROVED CENTERLINE CAMERA SYSTEM -- PROPOSED DESIGN**

In the following, we present a specific proposal, based on an analysis of systems requirements in the three critical areas discussed above -- sensor, optics, and signal processing.

The CCD sensor proposed is, first of all, a custom device, whose size is chosen to maximize the use of the available window aperture. Standard commercial-application CCD chips are much smaller. To compromise the most basic performance driver, photon rate, on the altar of commercial availability is simply not reasonable, given the critical nature of the centerline camera application.

With size fixed, we have chosen the CCD technology (back-illuminated, thinned, buried transfer anti-blooming gates). This technology offers high sensitivity, low noise, wide dynamic range, and extremely effective anti-blooming protection. It thus addresses all the important performance areas discussed previously.

### **VI-a. Custom CCD Sensor**

David Sarnoff Research Center (DSRC, previously RCA's Sarnoff Laboratory) has been at the forefront of CCD development from the beginning. DSRC's fabrication technology, and their business interest in high-performance military and aerospace sensor fabrication make them an attractive candidate for manufacturing the proposed sensors. As a particular strength for the centerline camera application, DSRC has a proprietary technique for achieving an extremely high level of antiblooming capability. Their "buried channel" devices have an overload capacity of  $>50,000$  times the full-well saturation signal levels. Combined with the wide dynamic range of the proposed sensor, the DSRC CCD can provide virtually complete protection against charge-spreading blooming

effects in the detector.

The following paragraphs describe the proposed sensor technology. Table 1 summarizes the proposed design parameters and expected performance levels. It should be stressed that all of the CCD technology assumed in this design has been proven. The proposal is merely to apply existing technology to a design optimized for the ILARTS centerline camera operation.

**It is important to note that this large area, low noise, high quantum efficiency CCD and a system employing this low light, wide dynamic range camera will find a number of military and industrial applications. This will insure the "commercial success," which has become an important aspect of the SBIR program.**

### Approach

The proposed imager is based on Sarnoff's back illuminated CCD technology incorporating three level polysilicon gates, buried blooming drains, and whole wafer thinning. These technologies have been in successful production for more than 10 years. Back illumination offers 100 percent optical fill factor (no blind areas within the pixel) and high quantum efficiency over the visible and near IR spectrum. Back illumination also provides a lower level of optical flare than top illuminated imagers having repetitive structure capable of scattering light.

Buried drain blooming control, invented at Sarnoff, is capable of containing optical overloads greater than 50,000 times while not significantly reducing imager sensitivity.

### Back Illuminated Structure

Figure 8 is a cross-sectional view of Sarnoff's back-illuminated structure. The silicon-substrate thinning process is carried out on the entire 4-inch diameter wafer after all high temperature fabrication steps are completed. Thinning is stopped when the desired substrate thickness of approximately 12  $\mu\text{m}$  is reached. Whole-wafer thinning versus single device thinning gives lower cost per device. When thinning is complete, the back surface of the wafer is ion implanted to give a thin, low-resistivity p+ layer. The implanted p+ layer is then furnace annealed. This results in high quantum efficiency across the visible spectrum. Quantum efficiency is more uniform across the imager using furnace anneal than can be achieved by other methods. Laser anneal, for example, which heats the implanted back surface with a scanned laser, produces streaks of varying sensitivity. This results in a non-uniform displayed image.

After back-surface anneal, a transparent glass substrate is laminated with a transparent adhesive to the optical input side of the thinned wafer to provide mechanical support. After lamination, metal definition is completed. There are no high temperature steps in the process after the metal deposition, allowing the use of low resistivity aluminum bus connections on the imager. This allows higher clock

rates and larger image formats than are possible with a refractory metal bus process.

### **Imager Architecture**

The proposed frame transfer imager architecture is shown in Figure 9. The illuminated A-register is used for image detection and transfer of charge to the B-register during the vertical blanking period. The B-register is shielded from light and used for temporary field storage during readout. The C-register is the horizontal readout register which reads one line at a time from the image field stored in the B-register. The signal is sensed by a floating diffusion electrometer stage followed by an on-chip buffer amplifier having a readout noise floor of  $< 25$  rms electrons/pixel.

The nominally 22.5 mm diagonal A-register has a 3:4 aspect ratio with 488 lines of vertical resolution. The lines are read out in two, interlaced fields to match RS-170 video. The interlace imager is chosen because progressive scan at the imager and interlace at the display would result in undesirable motion artifacts. This design choice is based on the present landing system display. If at a future time the display is required to operate in the progressive scan mode the imager design could be modified to operate with progressive scan readout.

The imager will have between 600 and 1000 horizontal elements. The exact number of pixels will be chosen based on the tradeoff between resolution and sensitivity. The A and B registers each have 244 CCD stages. The center of the vertical pixel is moved vertically by one half pixel height on alternate odd and even fields. This is accomplished by changing the voltage applied to the A-register transfer gates on alternate fields. This serves to move the pixel centroid on alternate fields to produce 2:1 imager interlace.

The output amplifier will use a floating diffusion stage with on-chip buffer amplifier. The floating diffusion capacitance and buffer transistor noise floor will be optimized to give readout noise for a dark field  $< 25$  rms electrons

### **Blooming Control**

The buried blooming drain structure is a unique Sarnoff design capable of containing extremely high optical overloads without image blooming while at the same time causing very little loss of desired signal charge. Blooming drains which not use the buried approach remove a significant amount of desired signal charge, as well as the unwanted overload charge. They thus reduce low light level sensitivity.

A cross-sectional view and channel-potential diagram for the buried anti-blooming drain structure is illustrated in Figure 10. The excess charge is removed via an N+ anti-blooming drain that runs

parallel to the vertical CCD transfer channels. The N- channel stop barrier sets the barrier potential on either side of the anti-blooming drain so that excess charge spills preferentially across the channel stop to the blooming drain rather than spreading up and down the CCD channel. The N+ blooming drain region is connected to an external bias voltage. To reduce loss of signal to the blooming drains, a P-type region is implanted under the blooming drains and barriers. This buried region reduces the size of the depleted region resulting from the reverse-biased drains, and therefore reduces the probability of losing useful signal charge.

Figure 11 is a plot showing the fraction of signal charge collected by the blooming drain as function of wavelength. This characteristic was measured, for a 12  $\mu\text{m}$  thick substrate, by comparing the reset drain signal current with the blooming drain as a function of wavelength for uniform illumination. As can be seen, over the visible spectrum, the shield keeps the blooming drain loss to less than 4.5 percent.

### **Quantum Efficiency**

Figure 12 is a plot of quantum efficiency versus wavelength measured for a Sarnoff, thinned back illuminated 512 x 512 CCD array with and without antireflective coatings. Quantum efficiency can be further improved by the addition of antireflective coating to the air-glass interface as well as to the silicon-lamination-adhesive interface. It is also possible to increase response for wavelengths longer than 700 nm by increasing the thickness of the thinned substrate.

### **VI-b. Camera Optics**

The ERIM study of the ILARTS mission and the laboratory experiments carried out in this Phase I study emphasize the problems related to trying to see the wheels and underside of aircraft as they approach the aircraft carrier for a landing. As is shown in Figure 2, laboratory experiments have verified that flare in the optics is the dominant source of the halo "wings" around bright point sources in the field of view of a CCD-based camera with good anti-blooming capability. The flare in even a high-quality commercial lens is made intolerable in the ILARTS situation by the bright lights appearing near the dimly illuminated region of interest, the undercarriage of the aircraft. The problem is analogous to trying to make out the details of an oncoming vehicle in spite of the glare/flare of its headlights.

Given the importance of the lens and other optical elements in the performance of the camera under ILARTS viewing conditions, it is important that the Phase II work statement include the design and fabrication of an optically fast lens with flare reduction as a primary design criterion. It should also be noted that the elimination of the relay lens currently employed in ILARTS will also reduce the optical flare.

Our optical consultant, prior to retirement, was the chief optical designer for Perkin Elmer's California Division. He has made several suggestions regarding the optical design approach and manufacturing processes that will minimize flare. Recently we found a star tracker lens that employs the same low flare optical design our consultant recommended. Preliminary test of this lens show

a factor of at least 5 less flare than the best commercial lens we have used in the Phase I laboratory experiments. This is very encouraging and leads to the optimism that a custom designed lens can reduce the flare by at least an order of magnitude over what has been employed in the past.

From the manufacturing standpoint it is important to coat the lenses with anti-reflection coatings that are effective over the spectral band where the illumination and image sensor overlap. Referring back to Figure 6, this band extends from the blue into the near IR. Most commercial lens are not coated with the near IR in mind because of the visible spectral band is the primary interest. It is also important to move the edges of the optical elements out of the beam of light so as to eliminate light scattering from these surfaces. Aperture stops should be as thin as possible for the same reason. Finally, one wants to minimize the number of lens elements and glass to air surfaces in the optical design.

One option for innovative low-flare lens design is the so-called "monocentric" lens design. In these lenses, all surfaces are spherical, and the centers of curvature of all the surfaces lie at the same point in space. Essentially, the lens becomes a multi-layer crystal ball structure. In simplistic terms, it has a  $2\pi$  radian FOV, since it images equally from all directions. Ghost images are well controlled, and there are minimal problems with diffraction from defining apertures. The design, however, necessarily implies a curved focal plane which may not be tolerable. We are exploring both the monocentric concept and modifications which might be better options for our application.

#### **VI-c. Signal Processing**

As was discussed previously, we envisage using an analog non-linear signal compression stage early in the signal processing sequence, to make optimum use of the signal-to-noise ratio in the amplitude range available, and to allow digitization at video rates using an acceptable number of bits in the ADC.

Flexible, programmable, digital signal processing would be used to allow exceptionally wide-range control of the usual parameters of brightness, contrast, and gamma to provide the Landing Signal Officer the best possible visual access to the wide dynamic range of the image acquired by the CCD. This control could be exercised manually, or under partial or full electronic control. (It is likely that automatic control would be used for certain of the crudest parameters -- gain and iris setting, for example -- but a more flexible approach to such techniques as histogram-based signal processing is required in order to provide the ability to optimize the system based on future field experience.)

Certain other aspects of the proposed electronics are discussed in the following section, on Configuration. These include RS170 output, vs future higher-definition, conceivable digital outputs. The basic camera concept proposed could, of course, support any such future options.

#### **VI-d. Configuration**

Figure 13 is a configuration drawing showing the proposed Centerline Camera in position below

the existing folding mirror. In addition to the mirror, the rotating shutter (required for frame transfer CCD's when used with bright sources), the single lens assembly, the CCD, and the electronics compartment are all indicated. The assembly is simple and compact. No relay lenses are required to fit into the available space. The camera electronics will be packaged along with the lens and CCD sensor in a single housing that will be considerably smaller than the existing SIT-tube camera.

The CCD detector will be mounted on a simple thermoelectric cooler operating at a modest  $\Delta T$  to keep the dark current low enough that the dark current shot noise will not degrade the camera signal to noise ratio. The CCD portion of the camera housing will be hermetically sealed to eliminate condensation that might otherwise form on the cooled surfaces. Heat from the thermoelectric hot junction can be removed simply by convection. The CCD camera should require no maintenance except for periodic cleaning of the window.

Figure 14 is a block diagram of the camera. Adjustments of the camera gain, transfer function and iris will be made via remote control from the LSO Hutch or controlled automatically by the camera's signal processing system. The existing ILARTS centerline camera generates a standard RS-170 analog video signal. Based on past experience with the Image Isocon television cameras, the spatial resolution afforded by the broadcast standards for monochrome television are adequate for the ILARTS mission. These are:

60 interlaced fields/sec,  
256 lines per field,  
Horizontal Resolution 320 lines  
4 MHZ video bandwidth.

It would be possible in designing the CCD and the camera electronics to incorporate more pixels in the CCD horizontal lines than would be necessary to fully exploit the 4 MHZ bandwidth. This would allow higher horizontal resolution to be an option of the user, by increasing the bandwidth of the video signal exiting the camera. This option could be exercised when there is sufficient illumination that the added noise associated with wider bandwidth will not significantly degrade the video image.

It also seems prudent to design into the engineering test cameras that will be built and evaluated in Phase II, a digital video output as well as the RS-170 analog output. This digital output will be available for experiments involving digital transmission of video from the cameras to the display monitors.

There is considerable effort within the broadcast television industry to develop what is called "High Definition Television" which will have at least twice the spatial resolution of current broadcast television. The standards being developed for High Definition TV will, it appears, involve digital transmission of the television signal and some form of bandwidth compression based on less frequent updating of area of the image that are not changing. This will involve sophisticated image processing within the television receiver. It does not appear, based on the

Phase I study and laboratory simulations of the ILARTS centerline camera situation, that high resolution is a significant advantage. Certainly, sensitivity should not be reduced to gain higher spatial resolution.

#### **VI-e. Possible Extensions to System**

The basic CCD technology described above can provide an extremely effective centerline cameras system. It offers superb low-light-level performance, with low noise, exceptionally wide dynamic range, and flare and blooming. With the signal processing techniques which can be applied, it will present a drastically improved image to the LSO aboard ship.

Future evolutions may be made in the area of signal processing, based on experience and, perhaps, on advances in available processing power. One additional possibility might be discussed as the proposed effort advances -- that is the potential value of color CCD imagery. At night, it is probably best to use all of the available photons in the image of the undercarriage to present a low noise, high contrast monochrome image. During the day, however, a similar large-area color CCD chip might be used together with a color monitor. The second chip might work through the same lens as the first, and could be behind a beam splitter which "steals" perhaps 10% of the available light. It could then be used in the day, when photon numbers do not limit system performance. Further, at night, it might be able, with intelligent processing, to track the positions of the navigation and other lights on an approaching aircraft. Intelligent image processing on these positions could yield information on position and attitude, rates of change and extrapolated values for position and attitude coordinates, and even on the color of attitude-indicating lights on the plane.

The potential value of adding a second, color, camera to the centerline system would have to be discussed in detail before making a decision on the idea. However, the fundamental simplicity of CCD sensors, and the low level of complexity of support electronics, make such a concept relatively easy to implement if the value should be agreed.

#### **VI-f. Cost Considerations**

In the broadest terms, the relatively simple sensor and support implied by the use of CCD technology implies low systems cost, low support cost, and easy maintenance of a CCD-based ILARTS system. Although this report recommends development of custom realizations of sensor, optics, and electronics system elements, the basic simplicity of the technology is still present, with the implied low cost.

The most fundamental premises of this Report are:

(1) the performance level of any new centerline camera technology should not be limited by a requirement to use off-the-shelf components. In particular, the importance of acceptance aperture to photon-statistical limits on system signal-to-noise ratios argues that sensor selection should not

be limited to the available technologies or, most importantly, to available sizes; and

(2) the performance of an optimized CCD-based centerline camera system can meet all system requirements, and greatly exceed the performance of all past (Isocon or SIT-based) systems.

These assumptions justify the proposal to base a new system on a custom-designed suite of back-illuminated CCD sensor, optics, and electronics.

The proposed large-area back-illuminated CCD chip would represent an advance in the state of the art of available CCD sensors for general low light level applications. As a result, it would have more general application within the military, and also strong commercialization potential in the spirit of SBIR funding programs. Both of these considerations could be used to justify considering the finding of chip development costs from a broader perspective than just the ILARTS program needs. In any case, the number of ILARTS cameras which will ultimately be deployed on Navy ships is sufficient to justify the development costs.

**It is important to note that this large area, low noise, high quantum efficiency CCD and a system employing this low light, wide dynamic range camera will find a number of military and industrial applications. This will insure the "commercial success," which has become an important aspect of the SBIR program.**

#### **Relative Cost of PSI CCD camera system and FLIR Systems Dual Sensor/Image Fusion camera system**

There is little argument that a television camera employing a single back illuminated CCD is fundamentally less complicated and less expensive to manufacture and maintain compared to a dual-sensor-fused-image camera system made up of two cameras, one employing a back illuminated CCD and the other a cryogenically cooled infrared focal plane array.

First of all there is the cost of the IR camera. The combining/fusing of these two video images, each having a different number of pixels per line and lines per raster, into a composite image requires considerable high speed digital electronics. And the cryogenic cooling required for the infrared detector has a finite life and will require servicing and periodic replacement. CCD cameras contain no components or subsystems with limited life and require only routine maintenance other than occasional cleaning of the optical window in the deck.

While the development cost of the FLIR Systems dual sensor/image camera is being underwritten by their contract with DARPA for an airborne system, one must consider the production and maintenance cost of the more than 100 cameras that the Navy plans to purchase under the VISION program. One can expect the more complicated dual sensor/image fusion camera systems to cost 3 to 4 times the cost of the single CCD camera described in this Phase

I study. And the maintenance and logistic expense makes the total difference in program cost even greater. Cost is important from the SBIR commercialization viewpoint as well.

Given this very large difference in the fundamental cost of the two approaches, the much higher cost of a dual sensor camera system can only be justified if the mid-infrared band sensitivity is required to fulfill the centerline camera job. Given that the Image Isocon cameras, which performed acceptably as centerline cameras, were not even very sensitive in the red, much less the mid-IR, there appears to be no real need for infrared imaging in order to perform the VISION centerline camera job. And it is the conclusion of this Phase I study that a camera based on a back illuminated CCD can match and in under most illumination conditions exceed the performance of the Image Isocon in this application.

**TABLE I. Wide Dynamic Range Imager**

<u>Specification</u>	<u>Nominal Parameters</u>
Imager Architecture	Frame Transfer
Imager Format (interlaced)	640 (H) x 488 (V-
Readout/Scan	2:1 Vertical Interlace
Pixel Size	28 $\mu\text{m}$ (H) x 56 $\mu\text{m}$ (V)
Image Diagonal	22.5 mm
Optical Fill Factor	100 %
Overload Capability <sup>1</sup>	> 50,000 X
Readout Amplifier Noise	< 25 Elec. RMS/Pixel
Saturation Level <sup>2</sup>	> 1,000,000 electrons
Dynamic Range	> 91 dB (35,000:1)
Horizontal MTF <sup>3</sup>	> 58 %

<sup>1</sup> With shutter to eliminate vertical transfer smear.

<sup>2</sup> Linear to 150,000 e, then compressed gain to  $10^6$  e.

<sup>3</sup> Broad-band (400 - 1,000 nm, assumed flat spectrum) at Nyquist sampling limit.

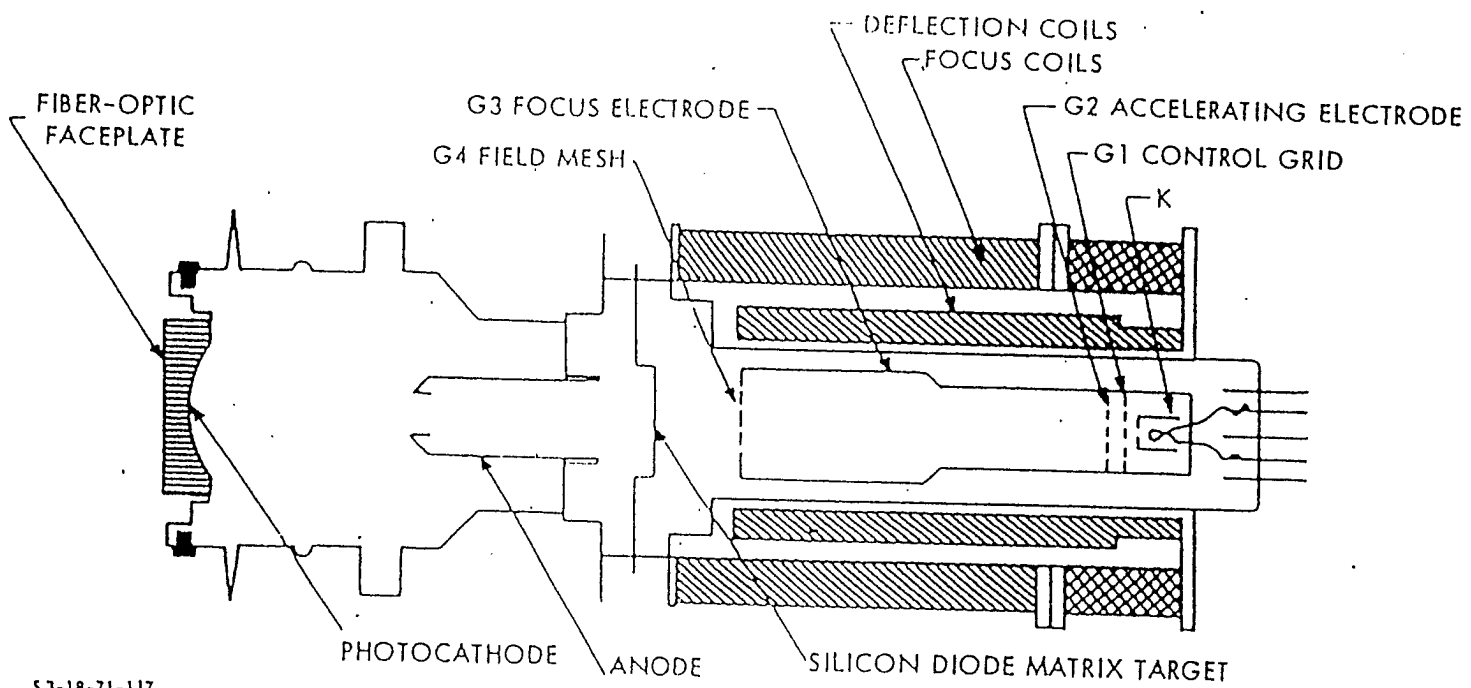

53-18-71-117

Figure 1. Internal Structure of Typical SIT Tube.

"Landing Light" -- CCD and UDT Detector Signal Levels vs Position,  
 28 mm f/2.8 lens (combined data for 0.5 and 0.1 mm UDT photodiode  
 apertures, scaled to area)

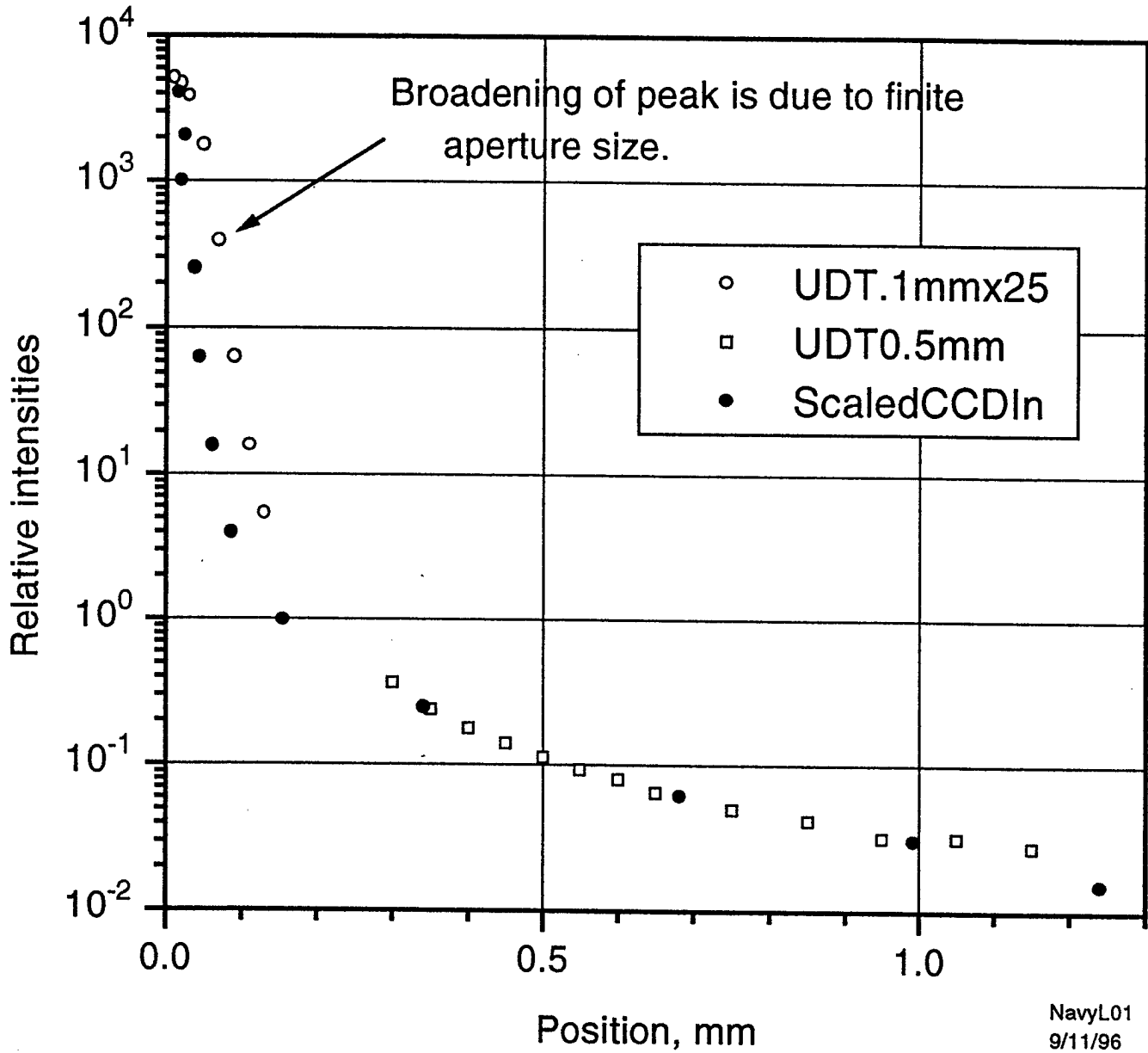
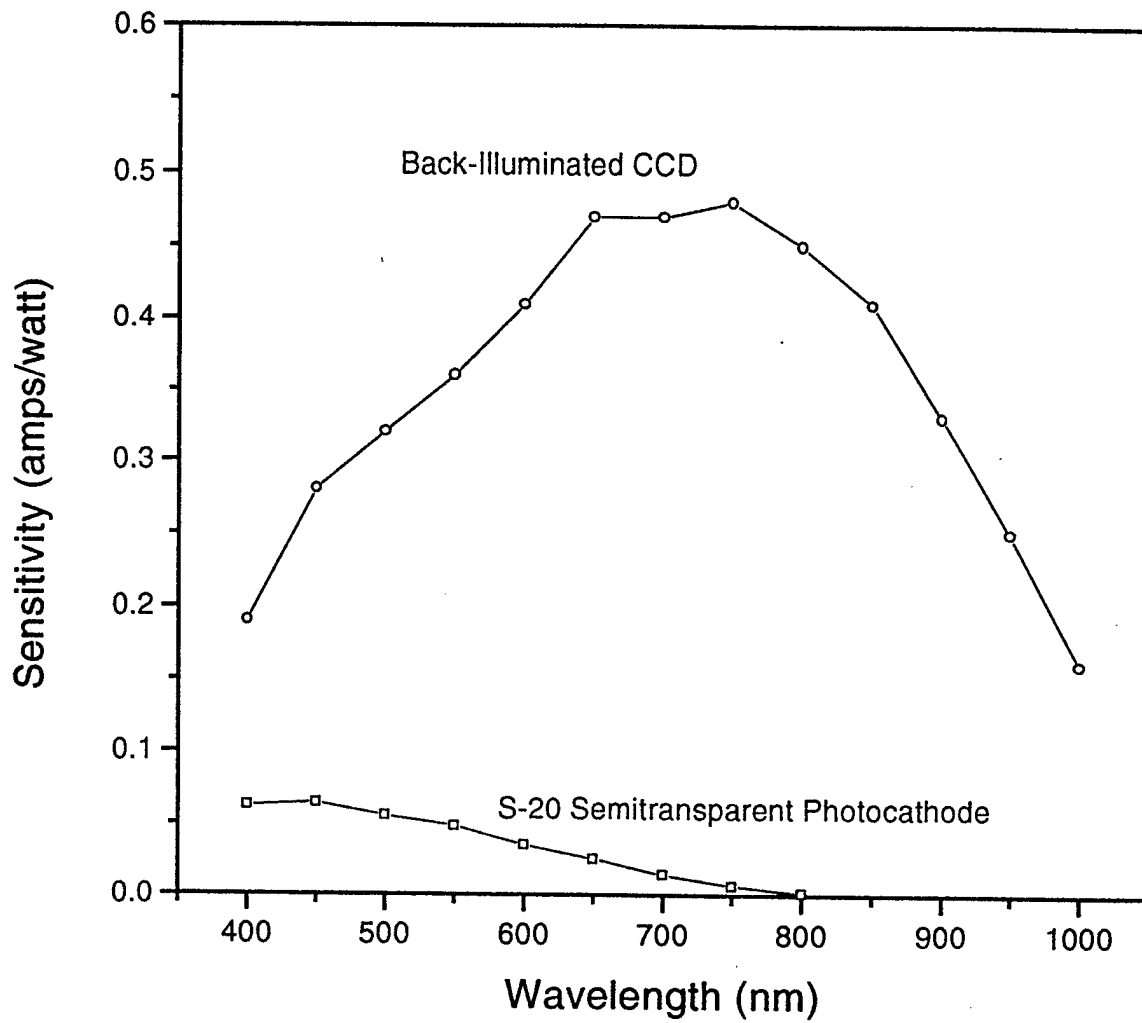

Figure 2. Measurements of Image Spreading. These data show that the image spreading is optical, and not due to CCD blooming. Note: 1 mm corresponds to 15% of the horizontal field of view of the 4.84 x 6.45 mm CCD detector.



NavyL03

Figure 3. Spectral Responses of CCD and S-20 Detectors.

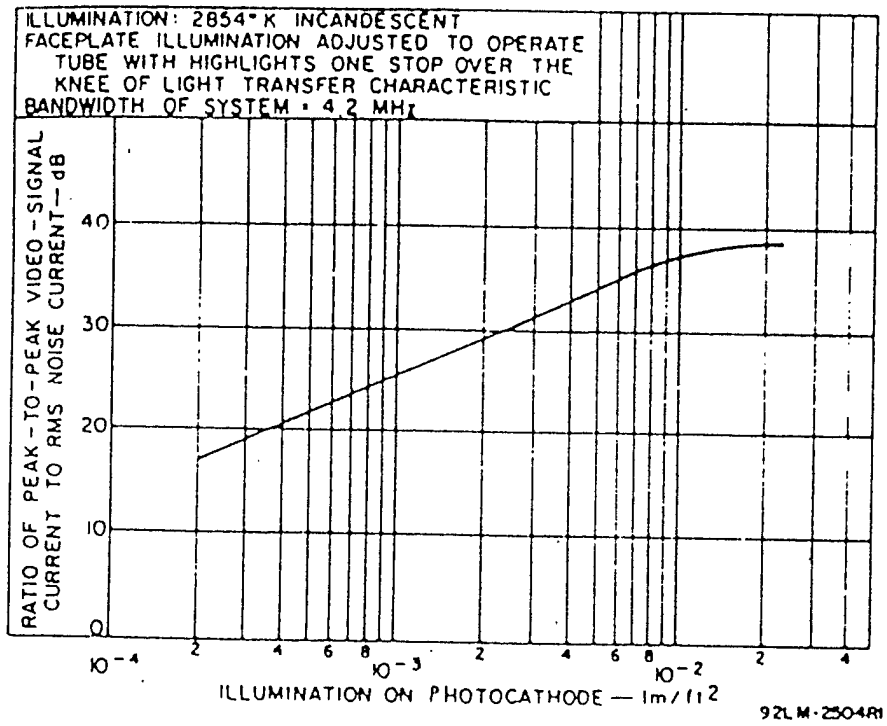
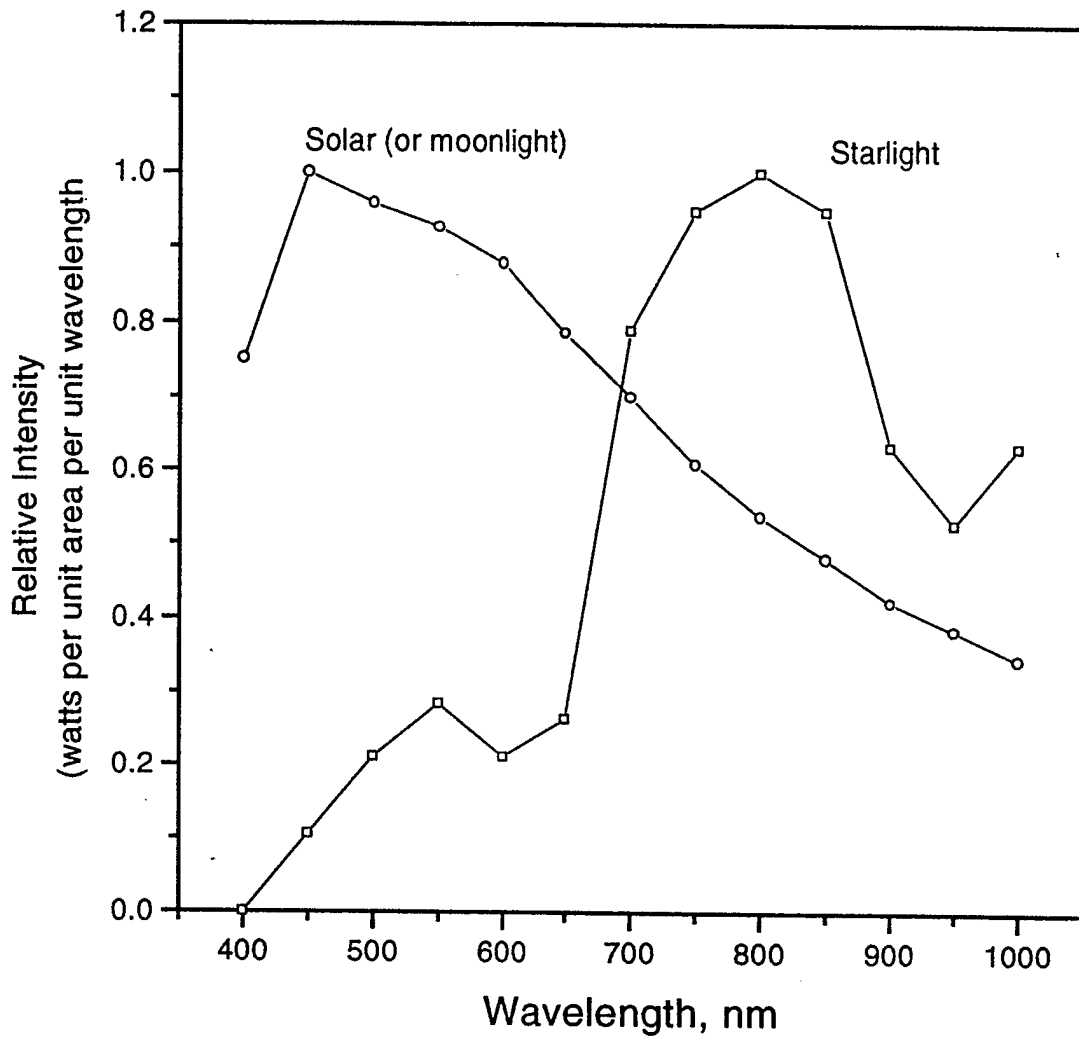

Figure 4. Signal-to-Noise Ratio of Image Isocon



NavyL03

Figure 5. Relative Spectral Intensities of Moonlight and Starlight Illumination. Each curve has been normalized to unity at its peak.

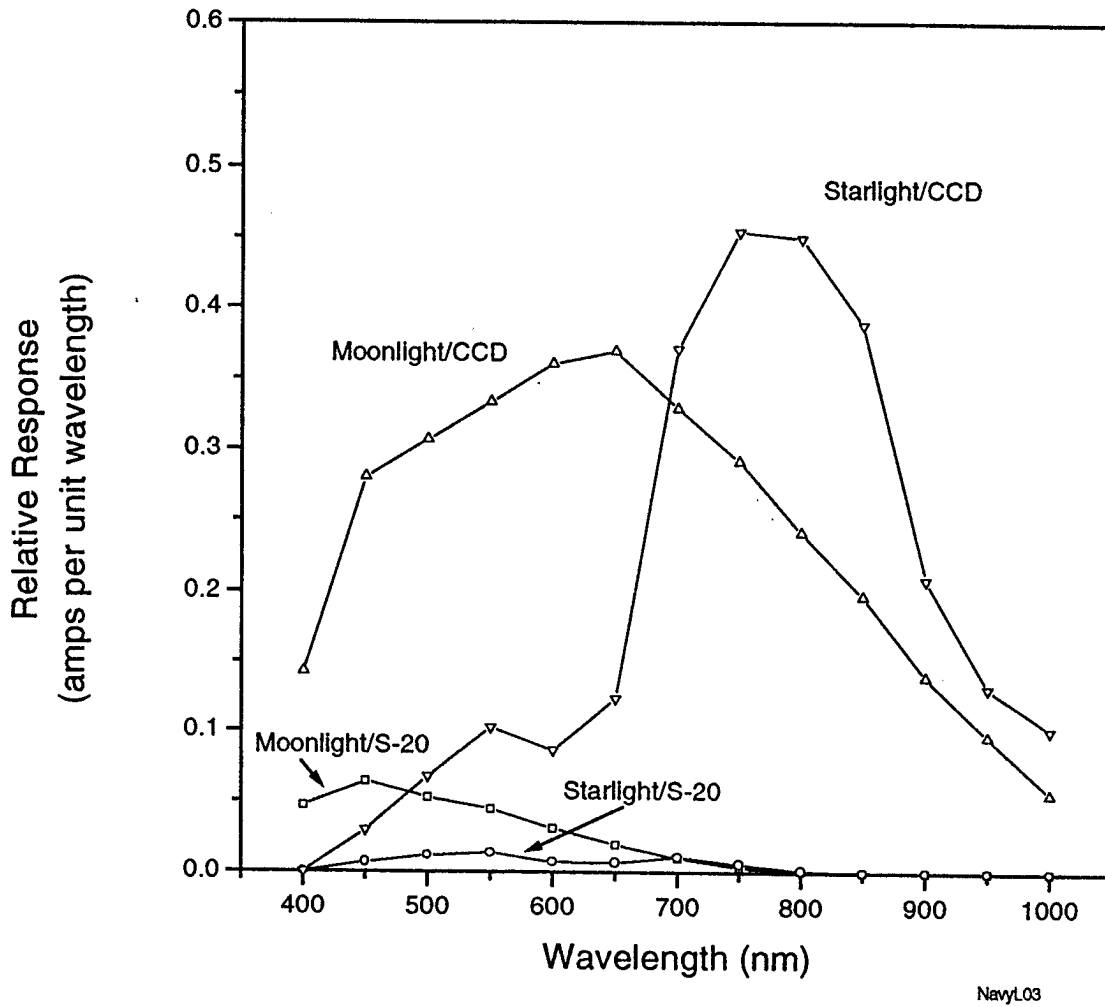

Figure 6. Relative Responses of CCD and S-20 Sensors in Moonlight and in Starlight. (The products of the curves of Figures 3 and 5.)

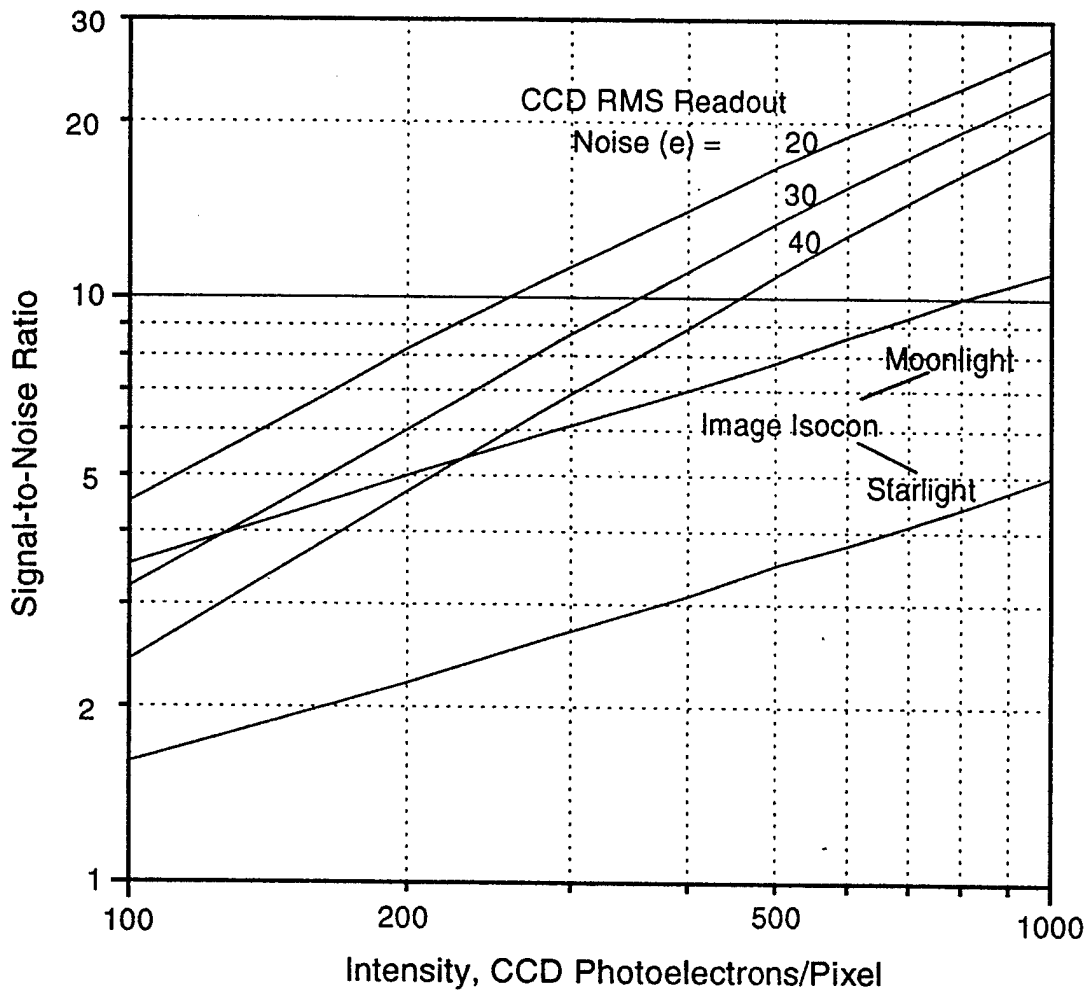

Figure 7. Signal-to-Noise Ratios of CCD and Image Isocon Detectors.

NavyL03

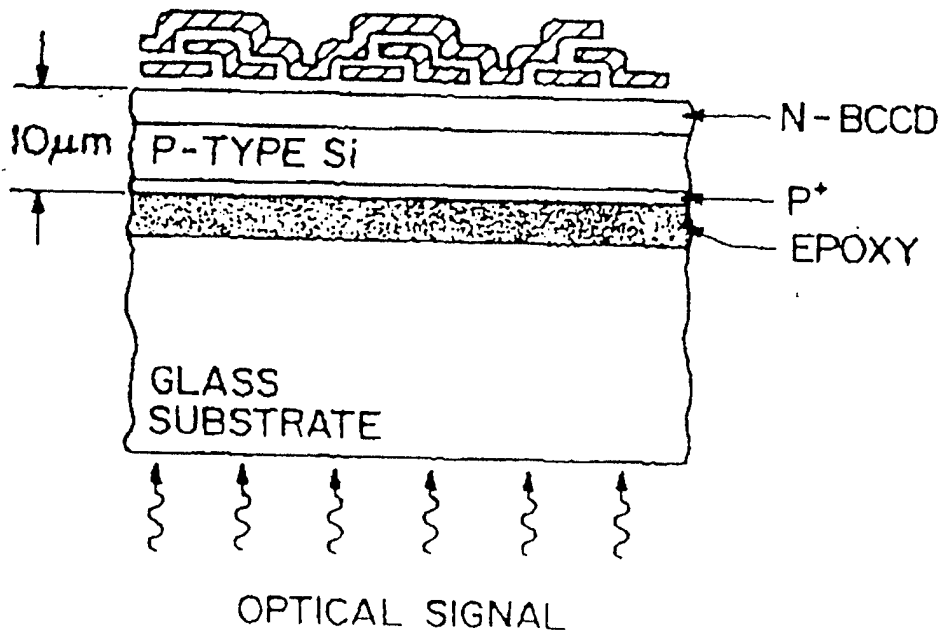

Figure 8. Cross-section of DSRC Back-Illuminated CCD Detector Technology.

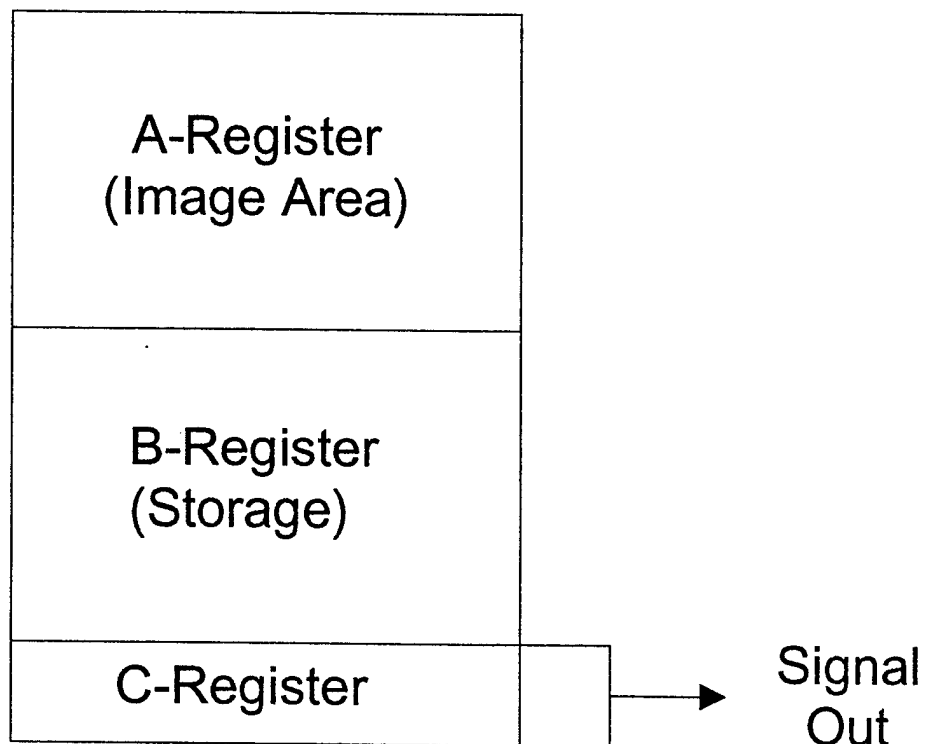

Figure 9. Architecture of Frame Transfer CCD Imager.

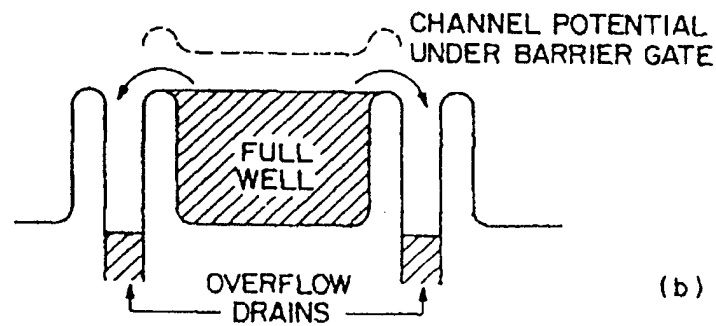
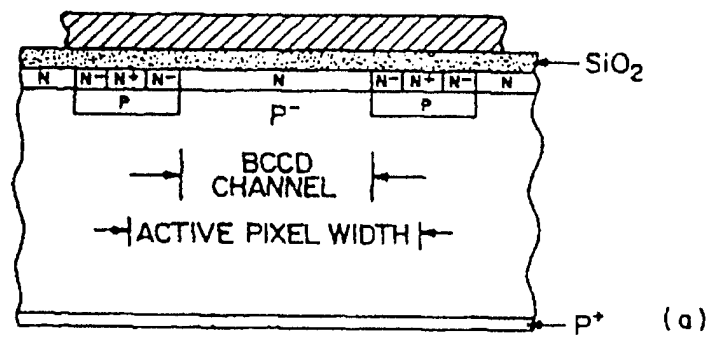

Figure 10. Cross-Section of Buried Anti-Blooming Drain Structure.

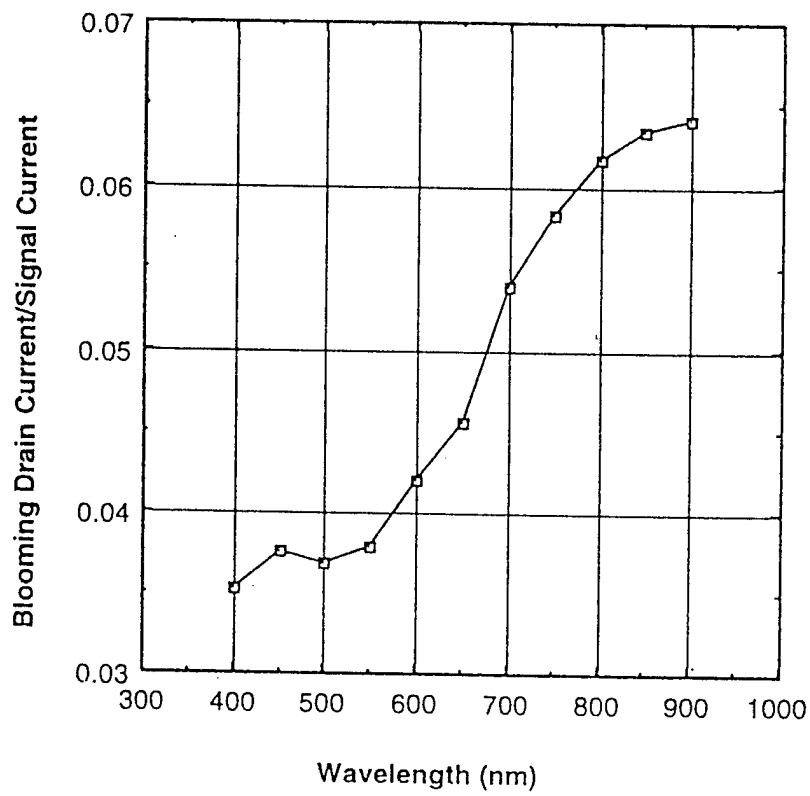

Figure 11. Ratio of Blooming Drain Current to Signal Current.

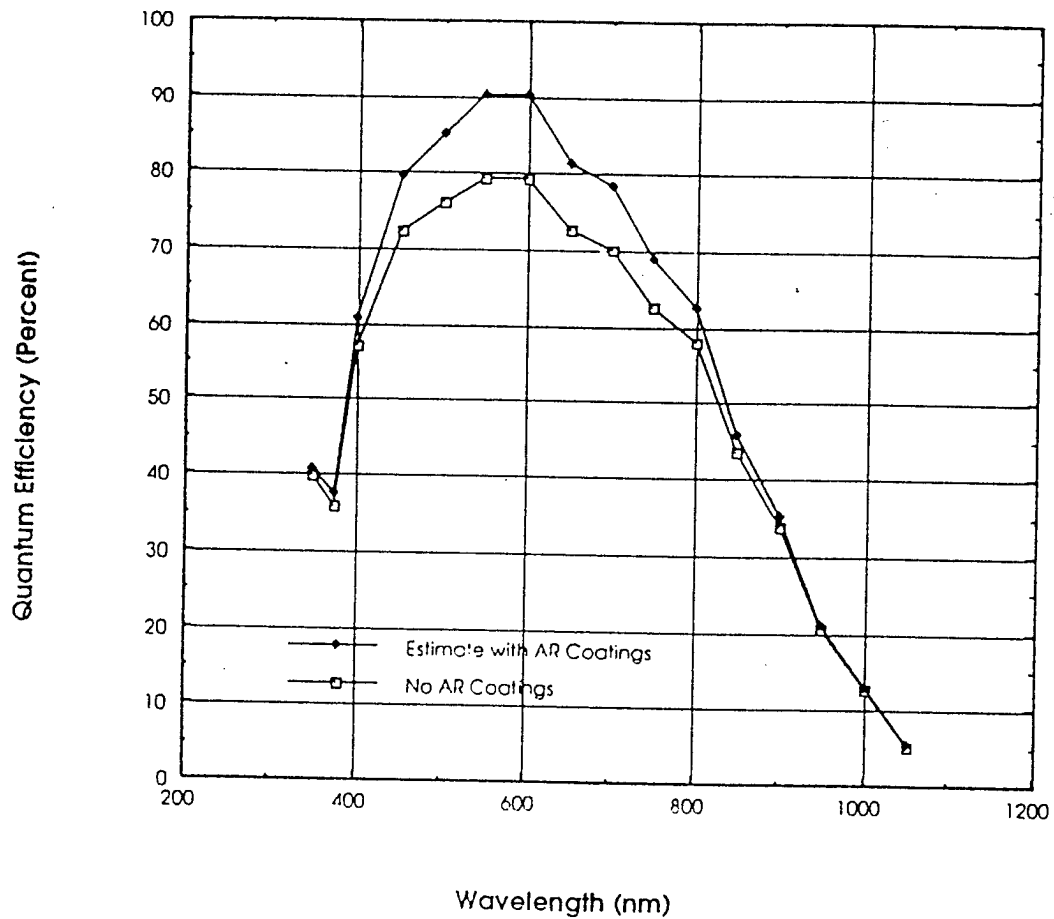

Figure 12. Quantum Efficiency of DSRC Back-Illuminated CCD Detector.

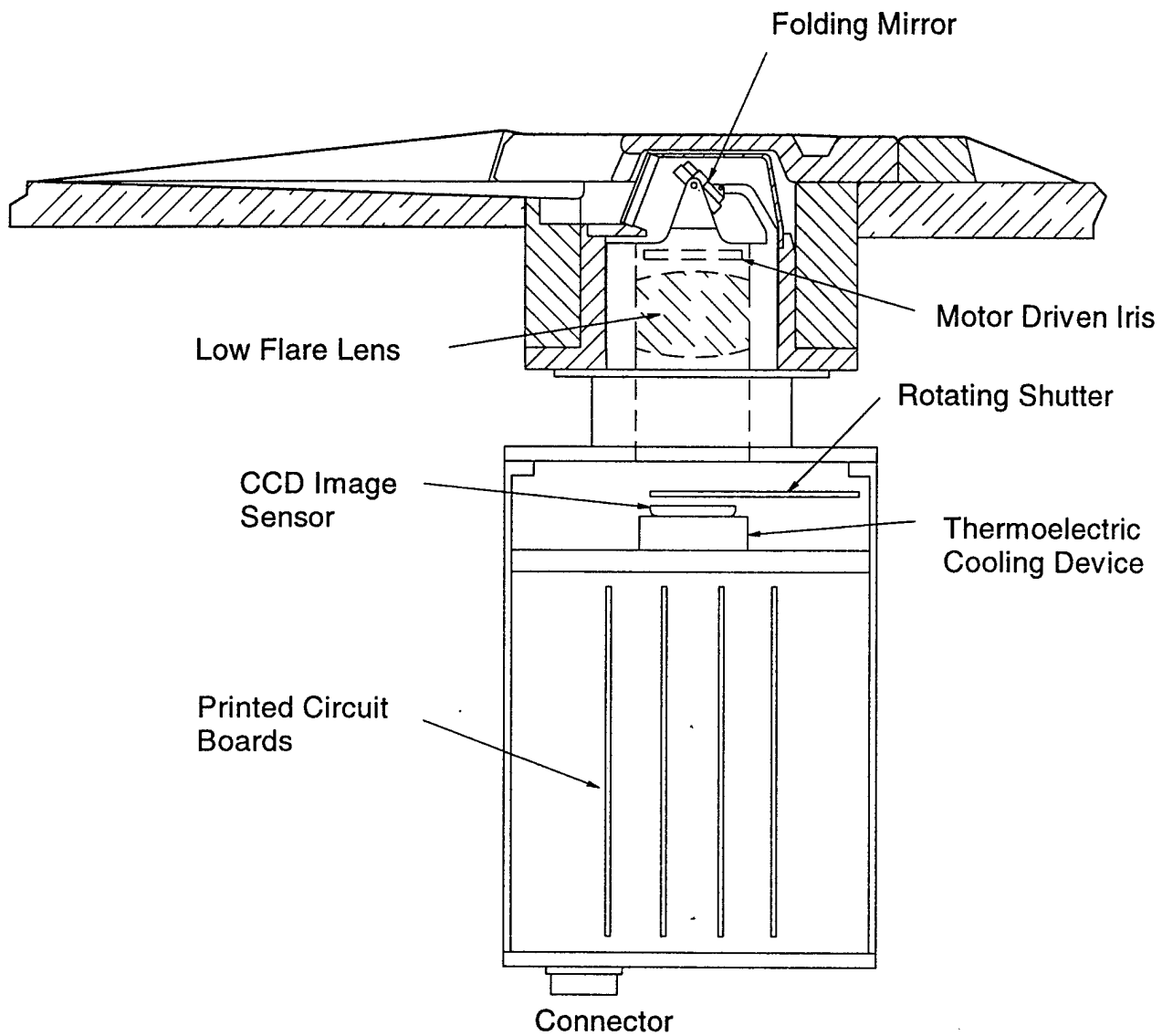

Figure 13. Configuration Sketch. Conceptual layout of proposed ILARTS CCD centerline camera.

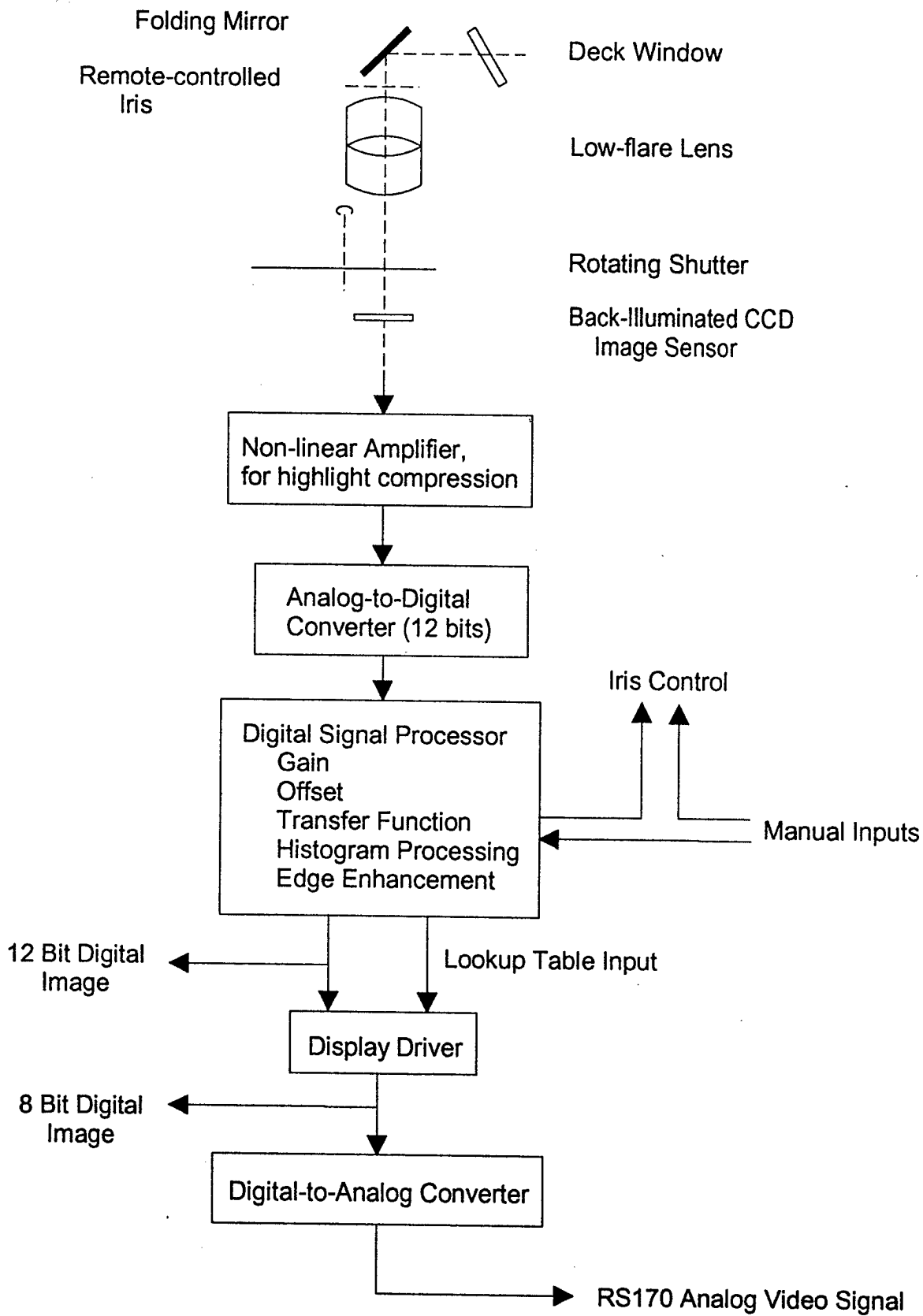

Figure 14. Block Diagram of CCD Camera.