

AFRL-ML-WP-TR-2000-4121

**AUTOMATED SURFACE PROCESSING OF
LARGE AIRCRAFT -- PHASE 0**



WILLIAM J. RAFFERTY

**SOUTHWEST RESEARCH INSTITUTE -- DAYTON
P.O. BOX 31009
DAYTON, OHIO 45437**

JUNE 2000

FINAL REPORT FOR 06/01/1999 - 06/30/2000

APPROVED FOR PUBLIC RELEASE; DISTRIBUTION UNLIMITED

**MATERIALS AND MANUFACTURING DIRECTORATE
AIR FORCE RESEARCH LABORATORY
AIR FORCE MATERIEL COMMAND
WRIGHT-PATTERSON AIR FORCE BASE OH 45433-7750**

DTIC QUALITY INSPECTED 4

20001004 038

NOTICE

Using Government drawings, specifications, or other data included in this document for any purpose other than Government procurement does not in any way obligate the U.S. Government. The fact that the Government formulated or supplied the drawings, specifications, or other data does not license the holder or any other person or corporation; or convey any rights or permission to manufacture, use, or sell any patented invention that may relate to them.

This report is releasable to the National Technical Information Service (NTIS). At NTIS, it will be available to the general public, including foreign nations.

THIS TECHNICAL REPORT HAS BEEN REVIEWED AND IS APPROVED FOR PUBLICATION.



BARNARD T. GHIM, MAJ USAF
Project Engineer
Coatings Technology Integration Office
Logistics Systems Support Branch
Systems Support Division

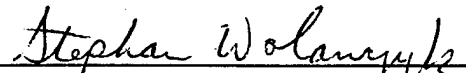

STEPHAN M. WOLANCZYK
Acting Chief
Logistics Systems Support Branch
Systems Support Division

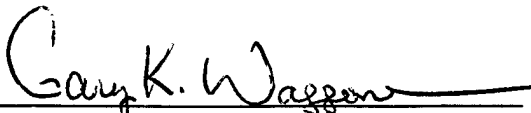

GARY K. WAGGONER
Chief
System Support Division
Materials & Manufacturing Directorate

Do not return copies of this report unless contractual obligations or notice on a specific document requires its return.

REPORT DOCUMENTATION PAGE			Form Approved OMB No. 0704-0188
Public reporting burden for this collection of information is estimated to average 1 hour per response, including the time for reviewing instructions, searching existing data sources, gathering and maintaining the data needed, and completing and reviewing the collection of information. Send comments regarding this burden estimate or any other aspect of this collection of information, including suggestions for reducing this burden, to Washington Headquarters Services, Directorate for Information Operations and Reports, 1215 Jefferson Davis Highway, Suite 1204, Arlington, VA 22202-4302, and to the Office of Management and Budget, Paperwork Reduction Project (0704-0188), Washington, DC 20503.			
1. AGENCY USE ONLY (Leave blank)	2. REPORT DATE JUNE 2000	3. REPORT TYPE AND DATES COVERED FINAL REPORT FOR 06/01/1999 - 06/30/2000	
4. TITLE AND SUBTITLE AUTOMATED SURFACE PROCESSING OF LARGE AIRCRAFT -- PHASE 0		5. FUNDING NUMBERS C F42620-96-D-0042	
6. AUTHOR(S) WILLIAM J. RAFFERTY			
7. PERFORMING ORGANIZATION NAME(S) AND ADDRESS(ES) SOUTHWEST RESEARCH INSTITUTE -- DAYTON P.O. BOX 31009 DAYTON, OHIO 45437		8. PERFORMING ORGANIZATION REPORT NUMBER	
9. SPONSORING/MONITORING AGENCY NAME(S) AND ADDRESS(ES) MATERIALS AND MANUFACTURING DIRECTORATE AIR FORCE RESEARCH LABORATORY AIR FORCE MATERIEL COMMAND WRIGHT-PATTERSON AFB, OH 45433-7750 POC: MAJOR BERNARD T. GHIM, AFRL/MLSSO, 937-255-0943		10. SPONSORING/MONITORING AGENCY REPORT NUMBER AFRL-ML-WP-TR-2000-4121	
11. SUPPLEMENTARY NOTES			
12a. DISTRIBUTION AVAILABILITY STATEMENT APPROVED FOR PUBLIC RELEASE, DISTRIBUTION UNLIMITED.		12b. DISTRIBUTION CODE	
13. ABSTRACT (Maximum 200 words) Southwest Research Institute, acting on behalf of the Air Force Coating Technology Integration Office (CTIO), has conducted a technology review program to identify new systems for the surface processing of large aircraft. The project was to develop a simple, low cost paint stripping system concept to reduce depot flow time, reduce ALC personnel exposure to the extremely hazardous work environment, and reduce man-hours and lost time due to injuries.			
14. SUBJECT TERMS Depaint tools/systems, cable suspended carrier, enhanced aerial lift concept, tripod manipulator, power assist wand		15. NUMBER OF PAGES 77	
		16. PRICE CODE	
17. SECURITY CLASSIFICATION OF REPORT UNCLASSIFIED	18. SECURITY CLASSIFICATION OF THIS PAGE UNCLASSIFIED	19. SECURITY CLASSIFICATION OF ABSTRACT UNCLASSIFIED	20. LIMITATION OF ABSTRACT SAR

TABLE OF CONTENTS

EXECUTIVE SUMMARY..... i

1.0 INTRODUCTION..... 1

2.0 BACKGROUND..... 1

3.0 APPROACH..... 2

4.0 RESULTS..... 3

5.0 DISCUSSION/RECOMMENDATIONS..... 5

APPENDIX Final Presentation Given February 22, 2000

EXECUTIVE SUMMARY

Title:	Automated Surface Processing of Large Aircraft – Phase 0
AF Customer:	Ogden, Oklahoma City and Warner-Robins Air Logistics Centers
Report Period:	June 1999-June 2000

1.0 Introduction

Southwest Research Institute, acting on behalf of the Air Force Coatings Technology Integration Office (CTIO), has conducted a technology review program to identify new systems for the surface processing of large aircraft. This project was to develop a simple, low cost paint stripping system concept to reduce depot flow time, reduce ALC personnel exposure to the extremely hazardous work environment, and reduce man-hours and lost time due to injuries.

2.0 Approach

The Integrated Process and Product Development (IPPD) method was selected to guide this project to ensure that the customer requirements would drive the final solution. All three USAF ALCs (OO-ALC, OC-ALC, and WR-ALC) and the Boeing Aerospace Support Center in San Antonio, Texas were visited to collect baseline requirements information. The two technologies originally selected for review by this program were NIST's RoboCrane® cable operated Stewart platform and the Grey Pilgrim LLC's EMMA® serpentine manipulator. Upon further investigation, the EMMA manipulator proved not mature enough in development to meet the desired demonstration schedule. The design team was then tasked to locate and/or develop additional concepts. A "Value Stream Map" was developed for the depaint process at Hill AFB to better understand the processes involved and to develop a strategy that could best reduce flow-time. Multiple "brainstorming sessions" and industry research efforts were conducted. Four final concepts were selected as being potentially viable. These four were then assessed for their ability to meet the customer requirements by using James Gregory Associates' IPPD software to score and compare their potential.

3.0 Results

The final four concepts consist of two carriers (systems that bring the operator close to the aircraft) and two manipulators (devices that assist the operator in performing his tasks once located near the aircraft). The two carrier concepts are the **RoboCrane®**, a cable suspended carrier, based on a Stewart platform geometry, that yields great maneuverability and control while remaining very rigid; and the **Enhanced Aerial Lift**, a concept that applies intelligent control to the joints of an aerial lift (cherry picker) to allow for intuitive coordinate motion. The two manipulator concepts are the **Tripod Manipulator** (patent pending), a high payload to weight manipulator based on parallel link technology; and a **Power Assist Wand**, an intuitively controlled telescoping wand which actively reacts to the blast force and is counterbalanced to offset the weight of the blast hose/nozzle. The IPPD software calculated that all four concepts show good desirability and manageable risk, and are therefore worthy of further development. Each of the concepts offers unique benefits and advantages to the respective ALCs. Thus, they should not be considered as interchangeable solutions.

4.0 Conclusions/Recommendations

Although there are several commercial and DoD-developed depaint tools/systems available today; many of them fall short in satisfying the customer's requirements. The depaint customer, therefore, needs additional aids to improve an ergonomically difficult and labor intensive task. This program focused on listening to the depaint customer and subsequently identifying concepts that should meet the customer's requirements set. For this reason, it is recommended that all four of the presented concepts be further developed for a depainting demonstration. This recommendation to proceed with all four of the concepts is due to the unique needs of each of the ALCs. The four concepts provide solutions to location specific problems and could dramatically expand the "tool box" of the depaint customer. It is also recommended that simulations be developed to assist in developing strategies to increase trigger time and decrease flow-time using these new technologies. Finally, these concepts offer a new opportunity to explore other nozzles/multi-nozzle/blast pressures/stand-off distances that would not otherwise be practical in a completely manual process.

1.0 INTRODUCTION

AFRL identified a technical requirement to evaluate emerging and alternative technologies for their ability to meet customer requirements in the surface processing of large aircraft. The responsibility for project management for this effort was tasked to the Air Force Coatings Technology Integration Office (CTIO). This project addressed establishing a simple, low cost stripping system concept to reduce depot flow time, reduce ALC personnel exposure to the extremely hazardous work environment, and reduce man-hours and lost time due to injuries.

2.0 BACKGROUND

Surface processing of large aircraft (i.e., C-130, C-141, K/C-135, C-5) at the USAF Air Logistic Centers (ALC) during Programmed Depot Maintenance (PDM) requires multiple "on aircraft" processes including washing, depainting, inspection, surface prep, and painting. These processes are labor intensive, subject personnel to undue strain, and require extensive stands, fixtures, man-lifts, or overhead stacker cranes to allow access to the surfaces of the aircraft. Automated manipulators and carrier systems, when used to access large aircraft surfaces, have the potential not only to reduce the physical strain placed on a worker but also to improve the quality and productivity of a process. These improvements, and a reduction in aircraft flow-time during PDM, can be realized by the capability of automated systems to control and carry multiple process tools beyond what a single operator is capable of handling.

Past Department of Defense (DoD) programs in automating "on aircraft" processes have had limited success. The systems have been physically large, dedicated for specific facilities, processes, and aircraft, and have attempted a high degree of automation to eliminate the "man in the loop." This high level of automation added extensively to the system's cost and complexity, and was a main driver in the development of new technology. There is a need in the DoD for simpler, more flexible types of "man in the loop" automation, designed to assist and increase a worker's productivity, reduce aircraft flow-time, and improve the ergonomics/quality of the processes. Recent developments in advanced automated manipulator and carrier systems have the potential to provide simple, low-cost approaches for use with large aircraft that can be implemented to assist and enhance a worker's capabilities rather than replace him with a totally automated process.

As a part of on-going efforts to improve paint and repaint operations throughout the Air Force, the Materials and Manufacturing Directorate of Air Force Research Laboratory (AFRL/ML) sponsored a Paint/Repaint Manipulator Workshop on January 12-14 1999, hosted by Southwest Research Institute in San Antonio, Texas. The workshop brought together Air Force and Industry organizations that conduct paint/repaint operations, manipulator technology suppliers and government R&D personnel. There was a general consensus that a paint/repaint demonstrator program, with a different approach from previously programs of the past would be of high interest. Such an approach should use the following philosophy: significantly reduce capital investment requirements (low automation hardware costs); reduce dependence on sensing and software (put the operator in the loop rather than autonomous operation); use multiple repaint devices/methods in the same facility with the potential for simultaneous operation to improve throughput; and emphasize durability/resiliency in the automated system design and operational concept that minimizes scheduled/unscheduled downtime. It was decided that such a program should be a multi-phase

effort with the Coatings Technology Integration Office (CTIO) sponsoring the first phase, Phase 0. The summary of the efforts of Phase 0 is the subject of this final report.

3.0 APPROACH

Unlike previous programs that have attempted to automate "on aircraft" processes, it was decided that the customer requirements would drive this program. The Integrated Process and Product Development (IPPD) method was chosen to guide this effort. IPPD is a management approach that addresses salient life-cycle design, development, fabrication and support issues from the outset. During the last couple of years, AFRL has made considerable progress in adapting industry-proven IPPD methods and tools to better quantify affordability in terms of *best value* trades among performance, producibility, cost and associated risks.¹ James Gregory Associates, Inc. was contracted by AFRL to facilitate the application of the IPPD method to this program. A detailed explanation of the IPPD system can be found at www.jamesgregory.com or by contacting James Gregory Associates, Inc., 4615 Hilton Corporate Drive, Columbus, OH 43232-4151.

As the first step in the process, an Integrated Product Team (IPT) was formed to define the requirements. All three USAF ALCs (OO-ALC, OC-ALC, and WR-ALC) and the Boeing Aerospace Support Center in San Antonio, Texas were visited to collect baseline requirements information. This information was then compiled using the James Gregory Associates' IPPD software. See Table 1, Constructed Requirements Set. The requirements were broken down to 5 major categories: Flow-time, Performance, Multi-Use, Unit Cost and Operating & Support (O&S) Cost. Each of these categories was then further broken down into subcategories. Each subcategory was defined, priority assigned, unit of measure established, objective, lower threshold and upper threshold values established. Although the aircraft and facilities between the four sites differed, there were consistent requests for the new system. Each ALC emphasized flow-time, improved ergonomics and 100% real time visualization. The Constructed Requirements Set in Table 1 is the consolidation of all the requirements requested by the customers.

The two technologies originally selected for review by this program were the NIST's RoboCrane® cable operated Stewart platform and the Grey Pilgrim LLC's EMMA® serpentine manipulator. Their selection by the USAF precipitated from an open technology review hosted at SwRI in January of 1999. Upon further investigation during this project, the EMMA® manipulator proved not mature enough in development to meet the desired demonstration schedule. The EMMA® manipulator in its current state was too heavy and lacked tool-path-control needed for the depaint application. Additionally, this technology failed to meet many of the customer requirements such as ease of use and 100% real time visual operation. The design team was then tasked to locate and/or develop additional concepts. A "Value Stream Map" was developed for the Depaint Process at Hill AFB to better understand the processes involved and to develop a strategy that could best reduce flow-time. See Figure 1. Multiple "brainstorming sessions" and industry research efforts were conducted. See Table 2 for a list of industries reviewed for technologies applicable to the depaint process.

Four final concepts were selected as being potentially viable. These four were then assessed for their ability to meet the customer requirements by using the IPPD software to score and

¹ IPPD for S&T Quick Reference, James Gregory Associates, Inc., 1999.

compare their potential.

4.0 RESULTS

The final four concepts consist of two carriers (systems that bring the operator close to the aircraft) and two manipulators (devices that assist the operator in performing his tasks once located near the aircraft). The concepts are as follows:

Carriers:

RoboCrane®

A cable suspended carrier based on a Stewart platform geometry that yields great maneuverability and control while remaining very rigid. This rigidity is achieved through the six parallel members in tension while the innovative replacement of telescoping members with cables allows for a large work volume. The platform has great application for large facilities servicing large aircraft. Potentially much less expensive and flexible than currently used stackers. The potential benefits include increased ability to access the upper portions of very large aircraft and to carry a very large payload. Potential impact on the depaint process is the possible application of new depaint processes that have heavy equipment requirements. The disadvantage of this technology is its limited ability to reach the underside of the aircraft. Impacts in the Value Stream include decreased material movement times during the prep, depaint and deprep activities. See Figure 2.

Enhanced Aerial Lift

This concept applies intelligent control to the joints of an aerial lift (cherry picker) to allow for coordinate motion. The operator will be able to make natural, direct movements of the basket through a single input device versus the current multiple individual joint controls. Hardening and basket ergonomic improvements are also a facet of this concept. The potential benefits include reduced training, reduced movement time, reduced ground movements, and reduction in inadvertent collisions with the subject aircraft. Impact on the depaint process is in the potential in reducing overall production flow-time. The disadvantage of this system is the cost of the required modifications to existing aerial lifts to permit smooth operation. Impacts in the Value Stream include decreased material movement times during the prep, depaint and deprep activities. See Figure 3.

Manipulators:

Tripod Manipulator (Patent Pending)

A high payload to weight manipulator based on parallel link technology. This very rigid yet light structure has great advantages over commercially available serial manipulator or "robots" for this depaint application. The prismatic links are formed into a tripod configuration. By coordinating the extension of these three links, three degrees of freedom in space are achieved. The operator would control the position of the single or multiple blast nozzles remotely via a joystick. Since remote control is inherent in the design, this approach allows removing the operator from the blast environment. The potential benefits include the ability to gang nozzles, remove the operator from the blast environment, and remove the loads the operator must burden. Potential impacts on the depaint process are the ergonomic and environmental improvements resulting in reduced injury down time and the potential reduction in production flow-time. The disadvantage of the system is the complexity and expense of the additional equipment. Impact in the Value Stream occurs in the decreased material movement during the depaint activities. See Figure 4.

Power Assist Wand

An intuitively controlled, telescoping wand that actively reacts to the blast force and is counterbalanced to offset the weight of the blast hose/nozzle. This ergonomic assist tool overcomes the difficulties of compensating for a variable reaction force of the blasting/spraying by constraining the force to always act through a universal joint or gimbal which is rigidly mounted to the support structure. A motorized telescoping member then allows the operator to compensate for the proper standoff distance to the substrate. The operator provides input through an instrumented handle to control a motor to either extend or retract the telescoping member to maintain the desired position of the mounted spray/blast nozzle. The gimbal allows yaw and pitch to be manually adjusted by the operator. A counter weight at the opposite end of the device is used to compensate for the weight of the spraying equipment. The invention transfers the weight to the support structure. The potential benefits include the ability to gang nozzles and remove the loads the operator must burden. Impacts on the depaint process are the ergonomic improvements resulting in reduced injury down time and the potential reduction in production flow-time. The disadvantage of the system is the requirement of additional equipment. Impact in the Value Stream occurs in the decreased material movement during the depaint activities. See Figure 5. (SwRI has filed an invention disclosure on this concept)

The four concepts were then evaluated against the requirements by estimating the concept's potential performance. It should be noted that this is a reduced set of requirements as compared to the constructed requirements set as listed in Table 1. Some of these requirements could not be evaluated during this conceptual stage of the program, but are to be considered in later phases when they can be properly estimated. See Table 3 for the reduced requirements set. The results of the scoring of the four concepts are presented in Tables 4-7. These tables show the scores for the major requirements of Flow Time, Performance, Multi-Use, and Health.

Table 8 shows the calculated customer satisfaction index (CSI) and the associated risk factor for each concept. The CSI reflects the extent to which a given technology is expected to satisfy or has satisfied the requirements. The risk factor is the probability of failure in meeting the requirements. It should be noted that in Table 5, the RoboCrane® concept was scored at 50% for the "percent coverage" requirement for consistency with the scoring approach of the other concepts. In the final presentation in Appendix A, the score was estimated at 80% due to the assumption that it would be used with other equipment. This was presented during the final presentation.

Figure 6 shows the graphical representation of the results in Table 8, in the form of "radar charts". All four concepts show good desirability and manageable risk. Any of the four are considered good candidates for continued development. Each of the concepts offer unique benefits and advantages and should therefore not be considered as interchangeable solutions.

5.0 DISCUSSION/RECOMMENDATIONS

Although there are several commercial and DoD-developed depaint tools/systems available today; many of them fall short in satisfying the customer's requirements. The depaint customer, therefore, needs additional aids to improve an ergonomically difficult and labor intensive task. This program focused on listening to the depaint customer and subsequently identifying concepts that should meet the customer's requirements set. For this reason, it is recommended that all four of the presented concepts be further developed for a depainting demonstration. All four showed good customer satisfaction versus risk as illustrated in the radar charts of Figure 6. This recommendation to proceed with all four of the concepts is due to the unique needs of each of the ALCs. The four concepts provide solutions to location specific problems and could dramatically expand the "tool box" of the depaint customer. It is also recommended that simulations be developed to assist in developing strategies to increase trigger time and decrease flow-time using these new technologies. Finally, these concepts offer a new opportunity to explore other nozzles/multi-nozzle/blast pressures/stand-off distances that would not otherwise be practical in a completely manual process.

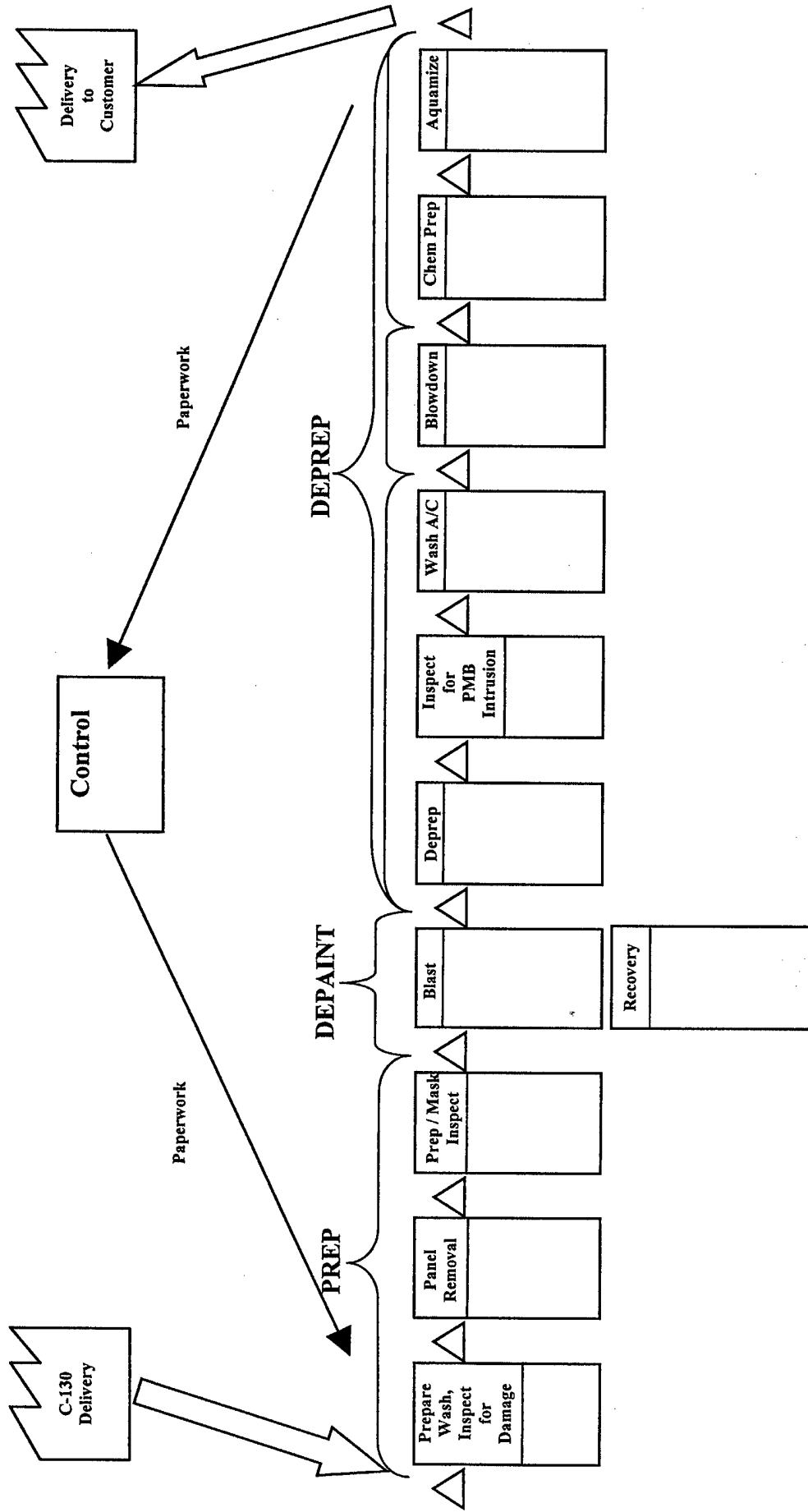

Figure 1. Value Stream Map: C-130 Depaint, Hill AFB, October 25-28, 1999

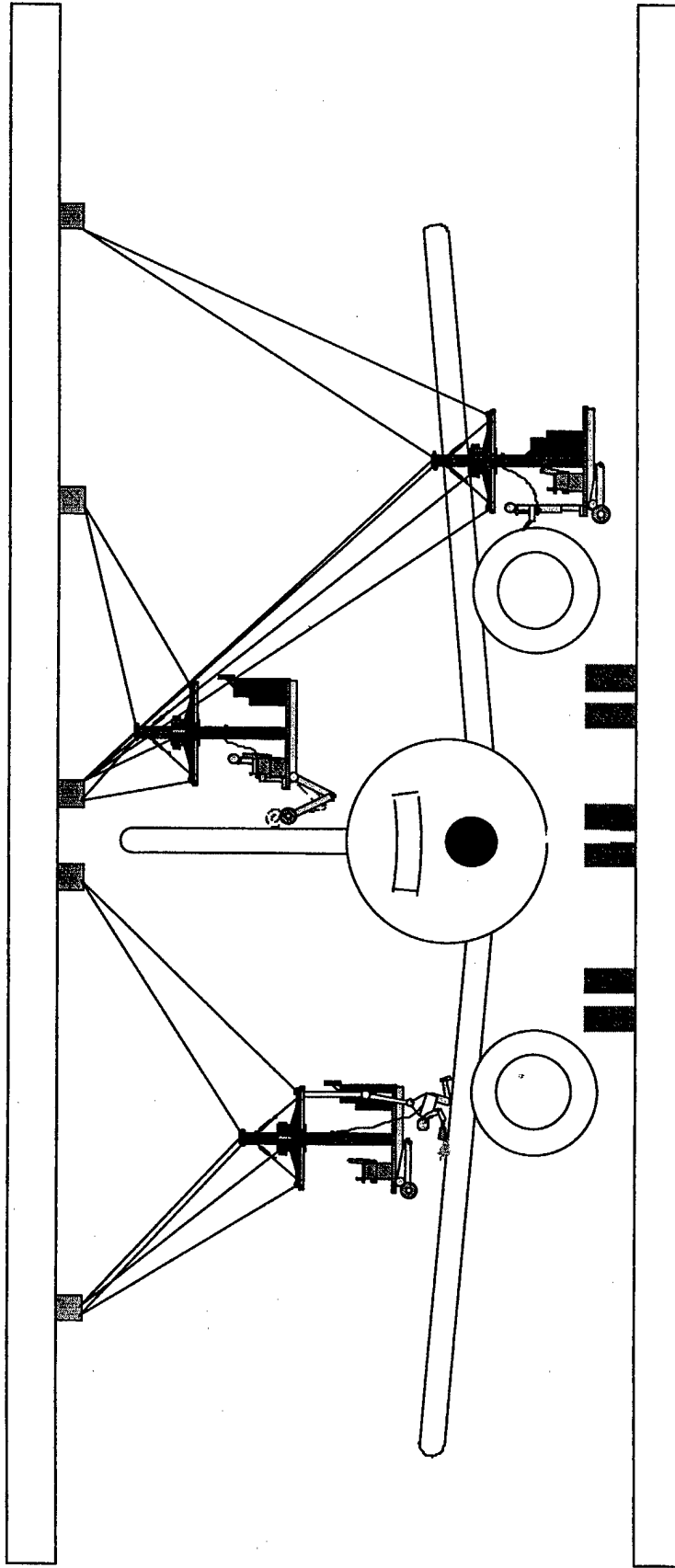

Figure 2. RoboCrane® Concept

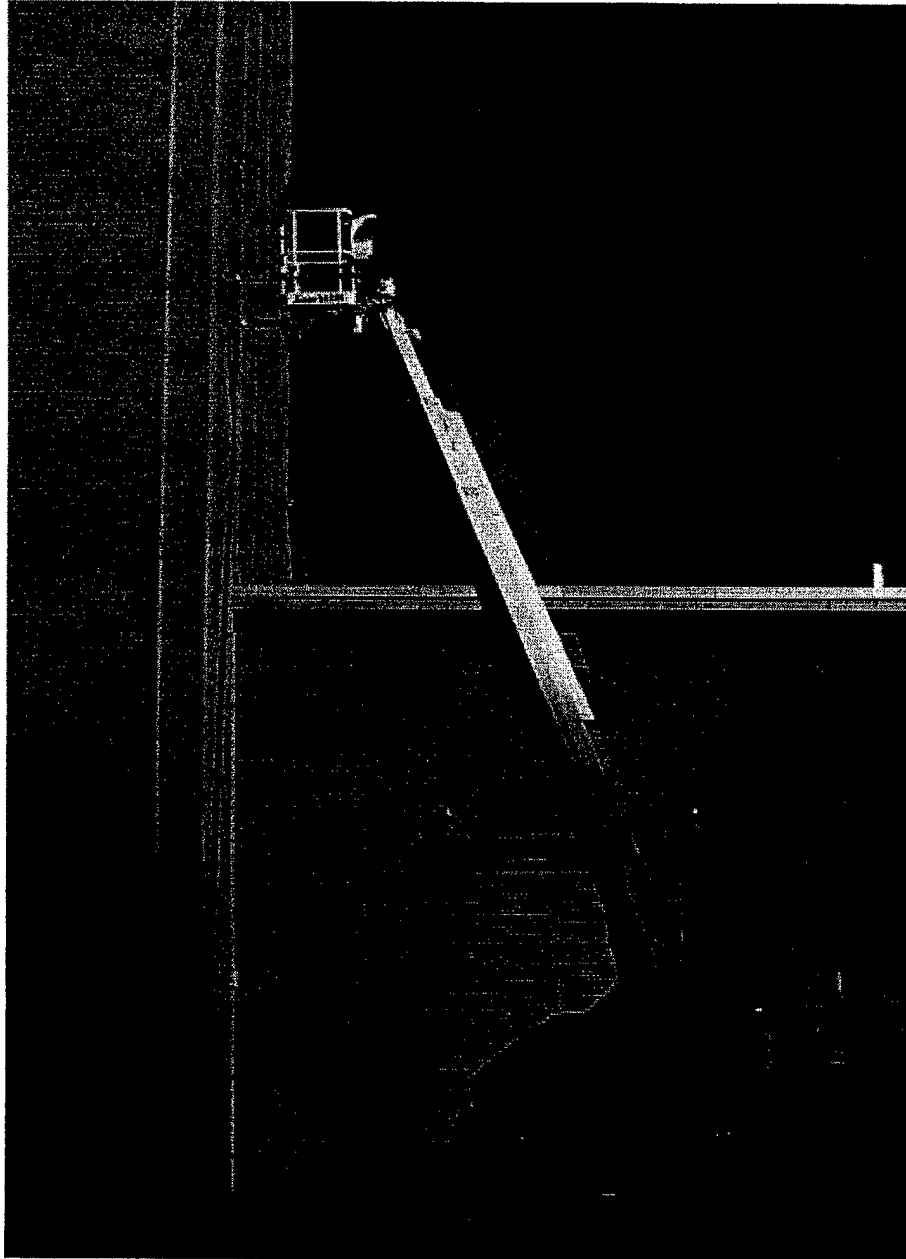
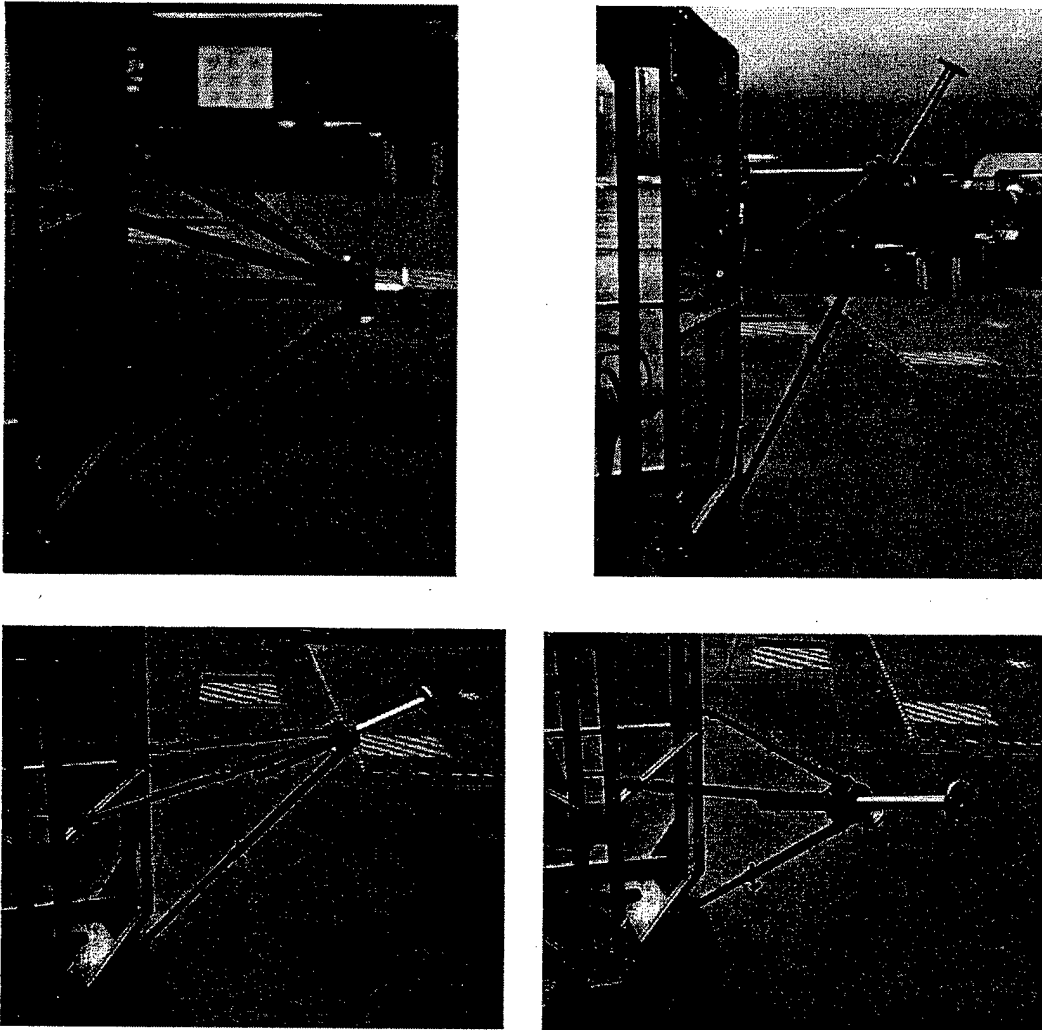

Figure 3. Enhanced Aerial Lift Concept



**Figure 4. Tripod Manipulator Concept
(Patent Pending)**

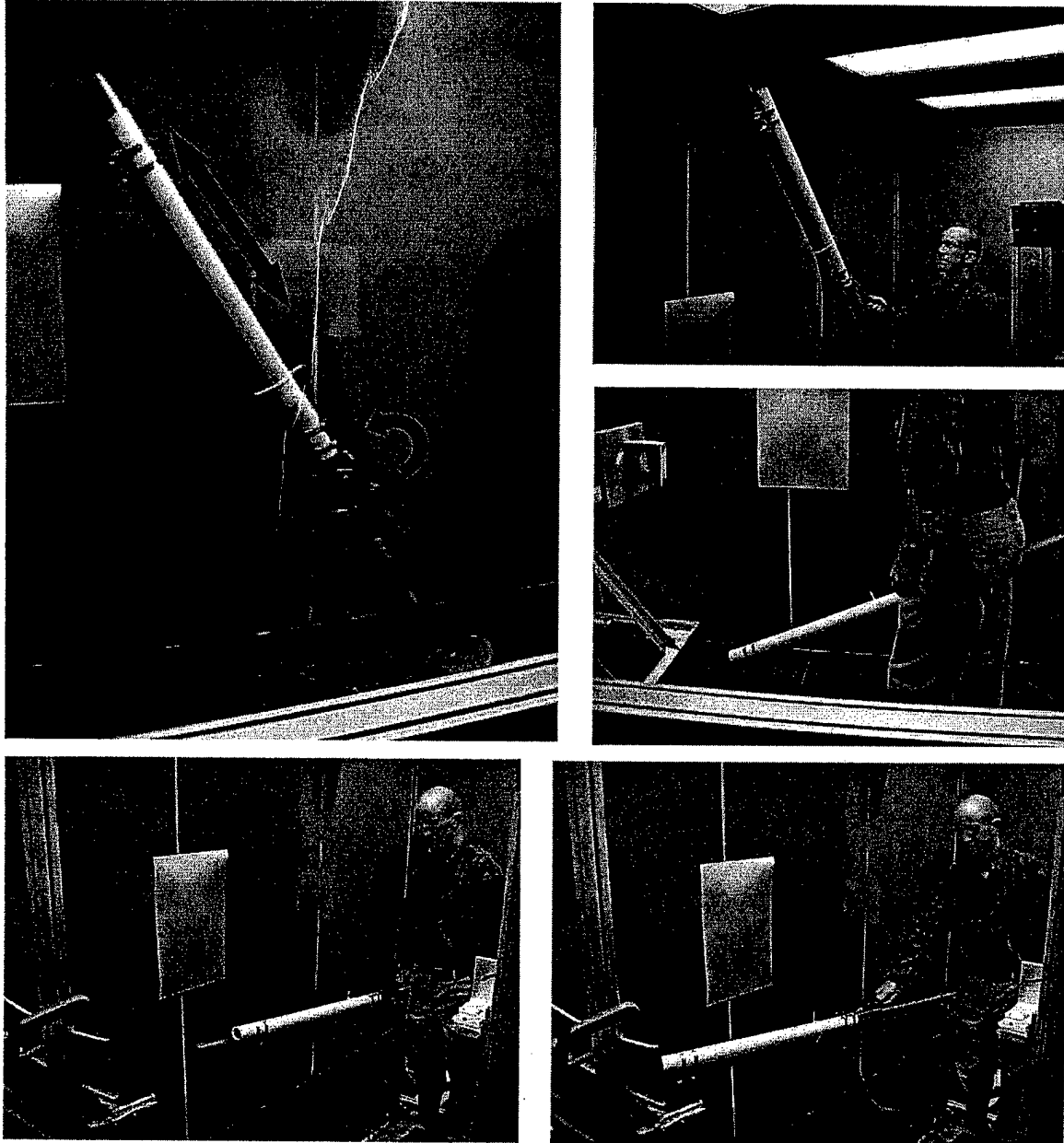

Figure 5. Power Assist Wand Concept

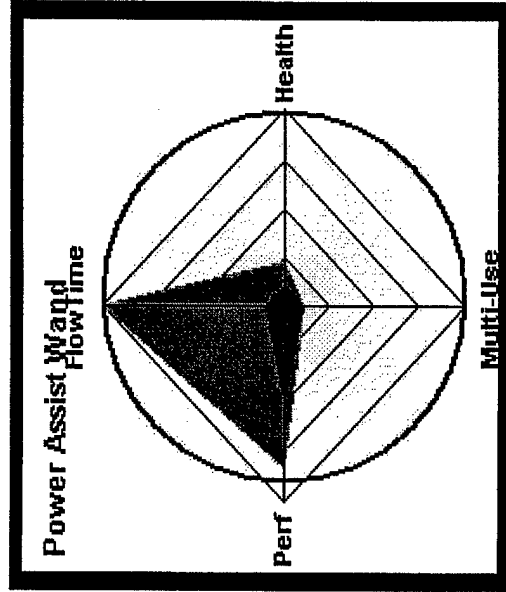
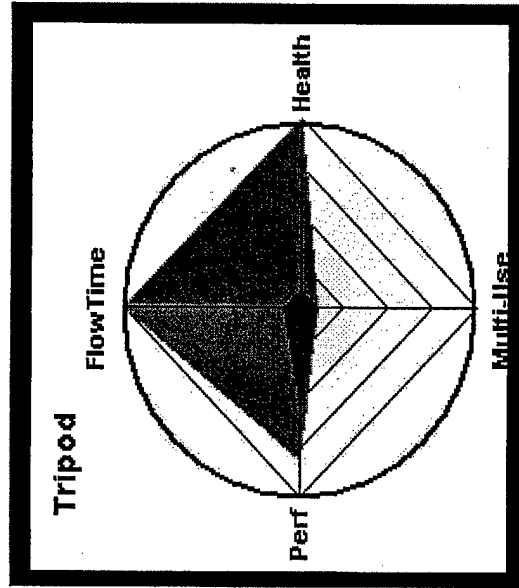
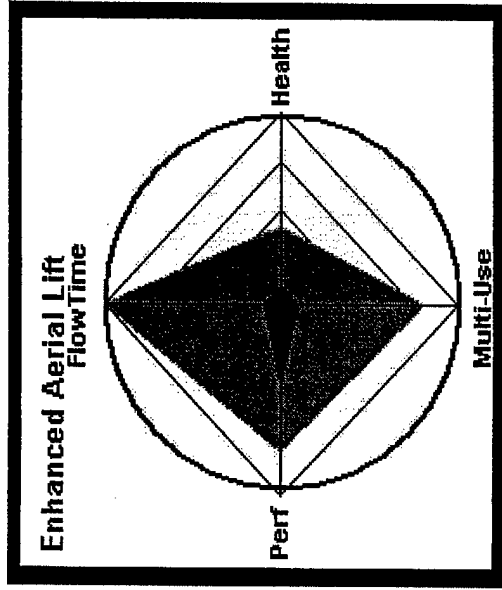
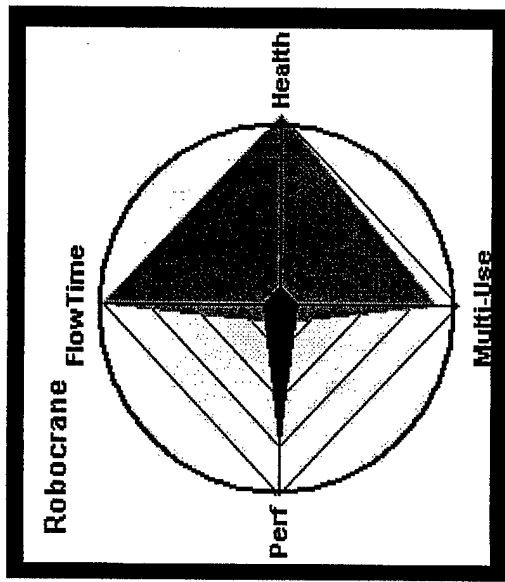

Figure 6. Resulting Radar Charts from the IPPD Software

Table 1. Constructed Requirements Set

Req#	Customer	Requirement	Priority	How Measured	Objective	Lower Threshold	Upper Threshold	Type	Req# Definition/Explanation
Category: 1 - Flow Time									
10	Constructed	Elapsed Aircraft Flow Time in the Depaint Process	High	Days	6	N/A	6	FlowTime	The total elapsed time the aircraft is in the depaint facility due to the paint-stripping operation.
11	Constructed	Elapsed Aircraft Flow Time in the Depaint Process-E3	High	Days	7	N/A	12	FlowTime	The total elapsed time the aircraft is in the depaint facility due to the paint-stripping operation.
Category: 2 - Performance									
20	Constructed	Coverage	High	% of Surface Area	100	80	N/A	Perf	Square Feet depainted divided by Total Square Feet, using the same technology, to be depainted. (Manipulator vs. manual touch-up.) Must be able to do under the wings, the belly, cargo ramp door, pylons, engine GEC, horizontal, beaver tail.
21	Constructed	Quality - Touch up	High	Hours of Rework	0	N/A	1	Perf	The average number of hours of rework on the aircraft due to the paint-stripping process.
22	Constructed	Quality - Damage	High	Hours of Repair	0	N/A	0.5	Perf	
23	Constructed	Durability	Medium	Duty Cycle (hours)	120	24	N/A	Perf	24 hrs/day, 7 days/wk
24	Constructed	Real-time visual	High	Percent of time operators have adequate visual control	100	100	N/A	Perf	Ability to see operation so as to avoid losing control of manipulator and causing damage, perhaps.
25	Constructed	Reliability	High	MTBF (hours)	2600	1000	N/A	Perf	The mean time between failures for the paint-stripping system (equipment). Must also be simple - low complexity.
26	Constructed	Maintainability	High	MTTR (Hours)	1	N/A	4	Perf	The time required to perform unplanned repair procedures per manipulator system. Must be maintained in-house by organic labor.
27	Constructed	Operational Complexity	High	Scale 1-5	1	N/A	2	Perf	5=Highly Complex, 3=Medium Complexity, 1=Simple
Category: 2 - Performance (Applies to C-130)									
27	Constructed	Routine Maintenance	High	MTBM (Hours)	20	10	N/A	Perf	Mean time between routine maintenance of the applicator
Category: 3 - Multi-Use, Flexibility, Compatibility									
30	Constructed	Multi-Use Capability	High	No of Process Types Supported	8	5	N/A	Multi-Use	The number of different process types that can be supported (e.g. washing, stripping, media recovery, search painting, parts pick/place, scuff sanding, no picking, masking) without having to move the aircraft.
31	Constructed	Flexibility	Medium	No of Aircraft Types Supported	8	8	N/A	Multi-Use	Ability to de-paint other type of aircraft.
32	Constructed	Facility Compatibility	High	Scale 1 = Yes, 0 = No	1	1	N/A	Multi-Use	Doesn't prevent using facility for any other type of aircraft. Limited to general maintenance and scuff sanding. Don't limit facility electrical classification. Maintain Class 1 Division 1 rating.
Category: 4 - Unit Cost									
40	Constructed	Unit Cost	High	M-Dollars		N/A	N/A	Unit Cost	The cost of the actual manipulator system, including set-up, warranties, initial training, etc.
41	Constructed	Facility Mod Requirement	Medium	M-Dollars		N/A	N/A	O&S	Includes structural modifications (e.g. roof structure to support a crane, added space, equipment rooms, height, clearance, reinforcement, etc.) Time to install and maintain.
42	Constructed	Process Equipment	Medium	M-Dollars		N/A	N/A	Unit Cost	Depends on economic analysis. Any and all additional costs for auxiliary equipment (e.g. media recovery, storage hoppers, etc.) required by the manipulator system.
43	Constructed	Installation and Checkout Time	High	Days		N/A	N/A	Unit Cost	
Category: 5 - O&S Cost									
50	Constructed	O&S Cost - Over 10 Years	High	M-Dollars		N/A	N/A	O&S	The total Operation and Support cost of the manipulator over a ten-year period. (Linked to costs below)
52	Constructed	Hours of Training per Operator	Medium	k-Dollars		N/A	N/A	O&S	Number of hours of training required per operator per year.
53	Constructed	Labor Cost	Medium	\$/Aircraft		N/A	N/A	O&S	Applies to labor cost to prep & depaint the aircraft and strip the paint, including manual touch-up. Does not include overhead costs such as recurring training, or cost of rework.
54	Constructed	Material Cost	Medium	\$/Aircraft		N/A	N/A	O&S	The cost of the actual materials to accomplish the paint-stripping job, including media, masking and prep or damage materials, shipping, transfer, storage and loss.
70	Constructed	Last Time due to Injuries	High	k-Dollars		N/A	N/A	O&S	Total work-hours lost per year due to on-the-job injuries associated with the paint-stripping operation.
Category: 6 - Environmental									
60	Constructed	Environmental Impact	High	k-Dollars	225	N/A	455	Environmental	The average annual cost in environmental preventive and waste management operations due to the paint-stripping process.
61	Constructed	Industrial Waste water Treatment	Medium	Dollars/Aircraft	0	N/A	5700	Environmental	The cost of waste water and paint chip sludge treatment and disposal.
Category: 7 - Health									
70	Constructed	Reduce Operator Stress	High	Percent	100	70	N/A	Health	
71	Constructed	Exposure to HazMat	High	Percent Reduction of Operator Hours per aircraft	100	50	N/A	Health	The total number of hours all operators are exposed to hazardous materials during an average paint stripping operation.

Table 2. Technology Search Areas

Brainstorming

SwRI, Boeing, NIST and GreyPilgrim

Industry Search

- Robotics
- Conventional Cranes/Gantry Cranes
- Lifting Devices
- High Pressure Water
- Water Tank Depaint
- Ship Building
- Ship Painting
- Ship Depainting
- Hydraulic Manipulators
- Master/Slave Devices
- Coordinated Motion Equipment
- Large Manufacturing Systems
- Wheel Chair Companies
- Ergonomic Companies
- Surface Crawlers
- Large Scale Manipulators
- Open Loop Depaint Systems
- Closed Loop Depaint Systems
- Under Water Manipulators
- Man-Machine Interface
- Fire Fighting Equipment

Table 3. Reduced Requirements Set

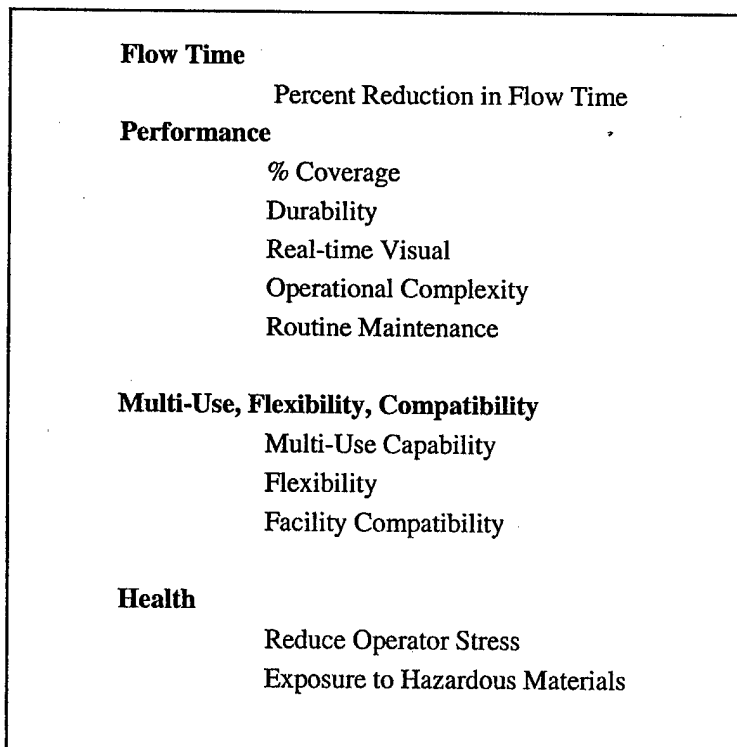
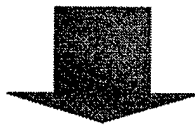
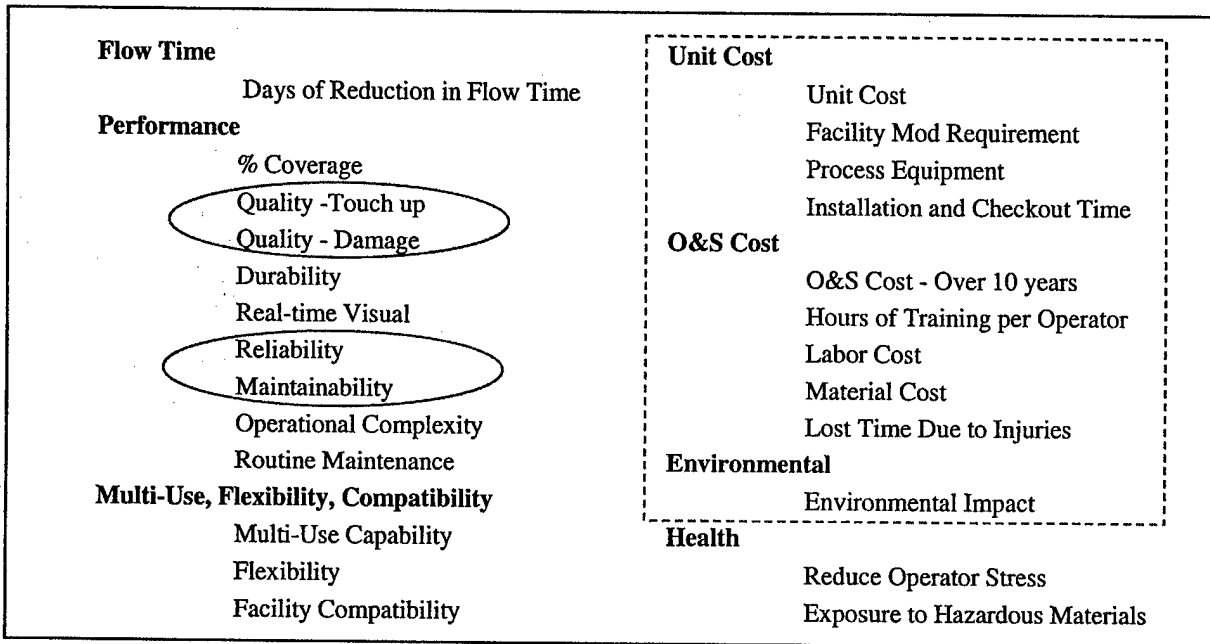

Table 5. Scoring Results of the Performance Requirement

DMP Scorecard: New_Perf		Perf												Perf Satisfaction Index		Total Perf Zeta	
		(20) Coverage			(23) Durability			(24) Real-time Visual			(27) Operational Complexity						
Technology Alternative ↓	Weight ↑	5.0		3.0		5.0		4.0		2.0		μ	σ	d	z		
		μ	σ	μ	σ	μ	σ	μ	σ	μ	σ						
1 Robocrane		50	0.99865	29	0.31697	100	0.00000	1	0.02275	50	0.00069			0.000	0.73791		
Desirability for Robocrane		0.000		0.547		1.000		1.000		1.000							
2 Enhanced Aerial Lift		80	0.50000	37.5	0.01539	100	0.00000	1	0.02275	50	0.00069			0.772	0.41657		
Desirability for Enhanced Aerial Lift		0.500		0.615		1.000		1.000		1.000							
3 Power Assist Wand		80	0.50000	100	0.15545	100	0.00000	1	0.00000	200	0.00007			0.824	0.48083		
Desirability for Power Assist Wand		0.500		0.929		1.000		1.000		1.000							
4 Tripod		80	0.50000	75	0.20725	100	0.00000	1	0.02275	200	0.00007			0.808	0.51813		
Desirability for Tripod		0.500		0.826		1.000		1.000		1.000							

Table 6. Scoring Results of the Multi-Use Requirement

DMP Scorecard: New_Flexibility		Multi-Use													
		(30) Multi-Use Capability				(31) Flexibility				(32) Facility Compatibility				Multi-Use Satisfaction Index	
Constructed		μ	σ	μ	σ	μ	σ	μ	σ	μ	σ	μ	σ	d	z
Technology Alternative		4.0		6.0		4.0									
1	Robocrane	7	0.00000	8	0.00000	1	0.00000							0.875	0.00000
	Desirability for Robocrane	0.648		1.000		1.000									
2	Enhanced Aerial Lift	6.5	0.00000	8	0.00000	1	0.00000							0.808	0.00000
	Desirability for Enhanced Aerial Lift	0.500		1.000		1.000									
3	Power Assist Wand	3	0.00000	8	0.00000	1	0.00000							0.000	0.00000
	Desirability for Power Assist Wand	0.000		1.000		1.000									
4	Tripod	3	0.00000	8	0.00000	1	0.00000							0.000	0.00000
	Desirability for Tripod	0.000		1.000		1.000									

Table 8. Final Scorecard

DMP Scorecard - Cont: New_Afford	Constructed	Requirement Type				Affordability (CSI, ζ_T)
		FlowTime	Health	Multi-Use	Perf	
		5	6	3	4	
		ζ	ζ	ζ	ζ	
1	Robocrane	0.00000	0.00000	0.00000	0.73791	0.000 0.52189
	Desirability for Robocrane	1.000	1.000	0.875	0.000	
2	Enhanced Aerial Lift	0.00000	0.04448	0.00000	0.41657	0.699 0.36938
	Desirability for Enhanced Aerial Lift	1.000	0.415	0.808	0.772	
3	Power Assist Wand	0.00000	0.04448	0.00000	0.48083	0.000 0.40863
	Desirability for Power Assist Wand	1.000	0.221	0.000	0.824	
4	Tripod	0.00000	0.00003	0.00000	0.51813	0.000 0.40438
	Desirability for Tripod	1.000	1.000	0.000	0.808	

APPENDIX
FINAL PRESENTATION
GIVEN FEBRUARY 22, 2000

Large Aircraft Depaint Manipulator Initiative

Materials and Manufacturing Directorate of the Air Force Research Laboratory

Technology Provider Briefing

Concept Review

Bill Rafferty

Program Manager

Southwest Research Institute
National Institute of Standards and Technology

Southwest Research Institute
6220 Culebra Road
P.O. Drawer 28510
San Antonio, Texas 78228-0510

Phone: (210) 522-5865
Fax: (210) 522-5885
Email: WRafferty@SwRI.edu

Large Aircraft Depaint Manipulator Initiative

AGENDA

- 9:00 - 9:30 Coffee
- 9:30 - 10:00 Introduction and Background
- 10:00 - 11:00 Technology Briefing
- 11:00 - 12:00 Technology Demos in High Bay
- 12:00 - 1:00 Question and Answer
Lunch in High Bay
- 1:00 - 1:30 Personal time
- 1:30 - 1:45 Overview of the IPPD Process
- 1:45 - 2:30 Results of Scoring
Phase I
- 2:30 - 3:30 Question and Answer
- 3:30 - 5:00 Optional tour of other NIST
Projects
Optional repeat of any of the
above activities for latecomers



Goals....

- **Objective:** *Establish a simple, low cost stripping system concept to reduce depot flow time, reduce ALC personnel exposure to the extremely hazardous work environment, and reduce man-hours and lost time due to injuries.*

- **Goals:**
 - Develop a set of tools to multiply the effectiveness of the operator
 - Focus on flowtime, cost and ergonomic improvements

- **Approach:**
 - Let the customer requirements drive the solution (IPPD)
 - Keep operator in loop
 - Use demonstrated technologies
 - Reliable/durable/maintainable hardware
 - Low customer (capital investment & operating) costs

Problem Definition

Process/Application

Solution

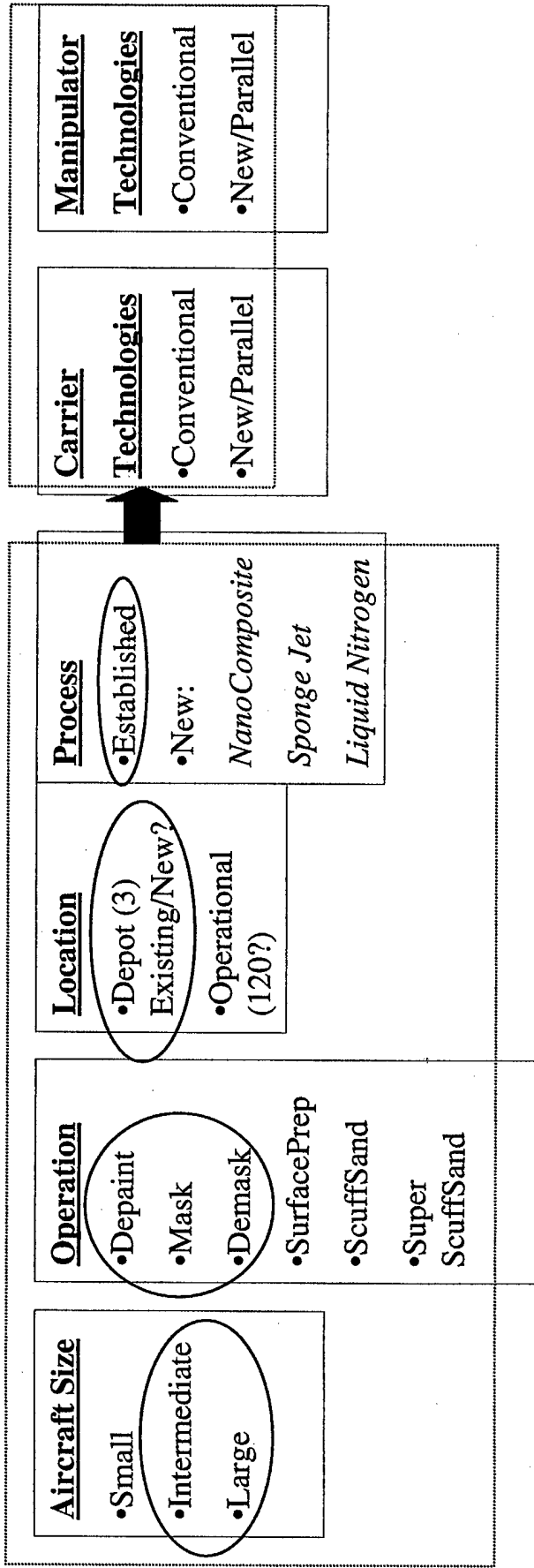

Requirements

Flow Time	Unit Cost
Days of Reduction in Flow Time	Unit Cost
Performance	Facility Mod Requirement
% Coverage	Process Equipment
Quality - Touch up	Installation and Checkout Time
Quality - Damage	O&S Cost
Durability	O&S Cost - Over 10 years
Real-time Visual	Hours of Training per Operator
Reliability	Labor Cost
Maintainability	Material Cost
Operational Complexity	Lost Time Due to Injuries
Routine Maintenance	Environmental
Multi-Use, Flexibility, Compatibility	Environmental Impact
Multi-Use Capability	Health
Flexibility	Reduce Operator Stress
Facility Compatibility	Exposure to Hazardous Materials



Constructed Requirements



Aircraft Depaint Manipulator Unit

Value Stream Map

C-130 Depaint, Hill AFB, Oct. 25-28, 1999

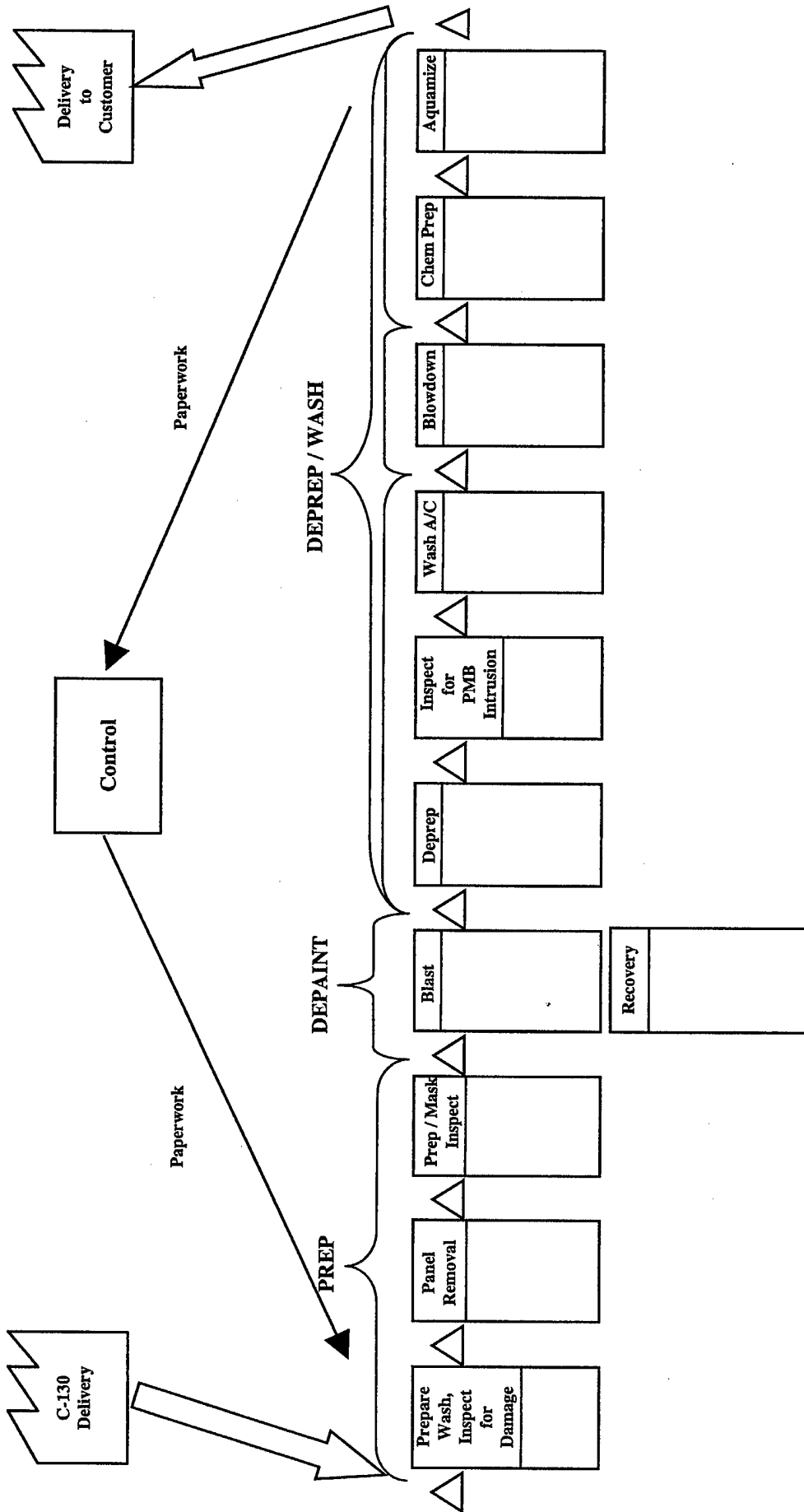

Cycle Time for Depaint Process

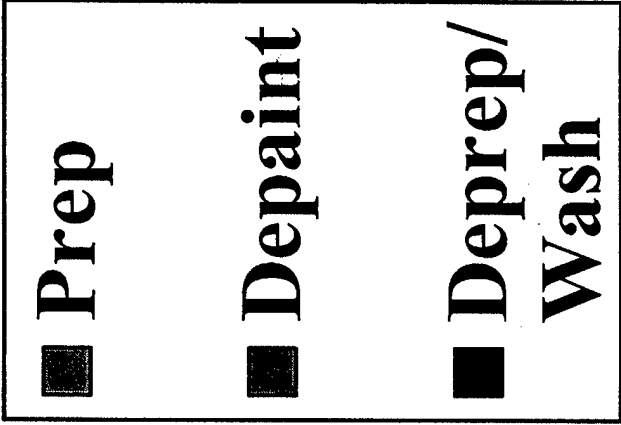
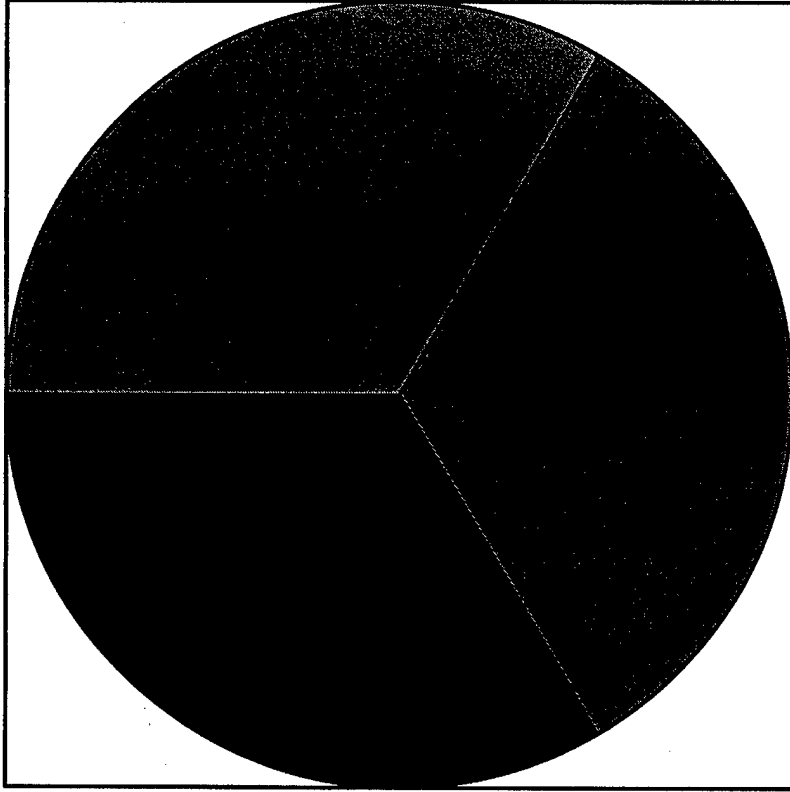

Technology Search Areas

Brainstorming

(SwRI, Boeing, NIST and GreyPilgrim)

Industry Search

- Robotics
- Conventional Cranes/Gantry Cranes
- Lifting Devices
- High Pressure Water
- Water Tank Depaint
- Ship Building
- Ship Painting
- Ship Depainting
- Hydraulic Manipulators
- Master/Slave Devices
- Coordinated Motion Equipment
- Large Manufacturing Systems
- Wheel Chair Companies
- Ergonomic Companies
- Surface Crawlers
- Large Scale Manipulators
- Open Loop Depaint Systems
- Closed Loop Depaint Systems
- Under Water Manipulators
- Man-Machine Interface
- Fire Fighting Equipment

Depaint Manipulator Initiative

Carriers (Macro-Manipulator)

GOAL

Shrink the apparent size of large aircraft through faster, easier and safer positioning of the operator around the airframe for the entire depaint process

APPROACH

- Improve access for masking and demasking
- Improve access for depaint process
- Allow attachment of depaint micro-manipulator
- Ensure safety of both airframe and operator
- Allow use in existing hangar facilities

Ergonomic Aspects (Micro-Manipulator)

GOAL

Assist operator in performing depaint process and improve operator ergonomics

APPROACH

- Augment operator's skills
- Improve process quality/speed
- Increase "trigger time"
- Minimize operator fatigue
- Enable multiple nozzles
- Safety of airframe/operator
- Address off-aircraft parts

Spectrum of Micro-Manipulator Options

Degrees of Freedom: 0 - 3

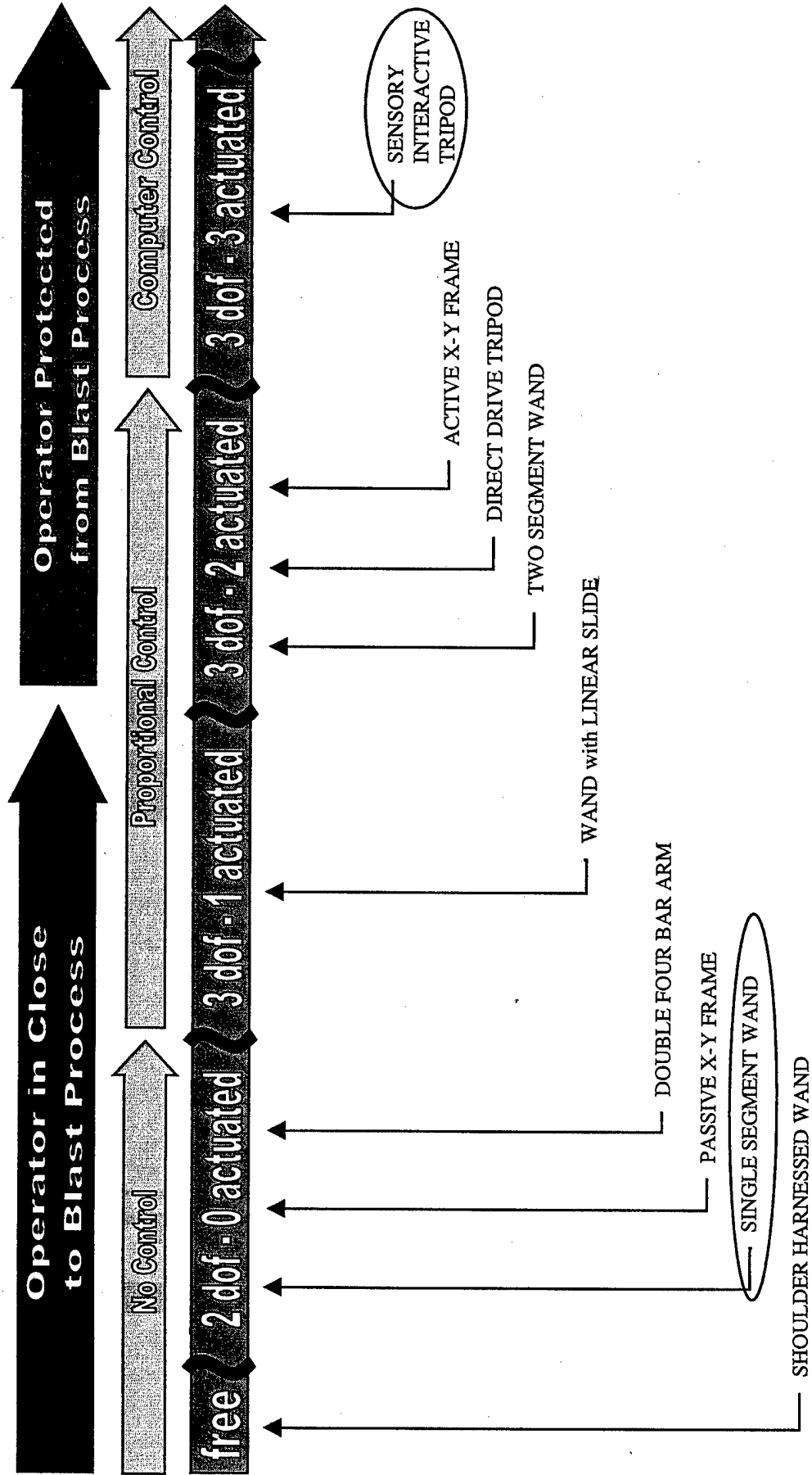

Small Aircraft Dependent Manipulator

Spectrum of Micro-Manipulator Options

Degrees of Freedom: 4 - 6 (and beyond)

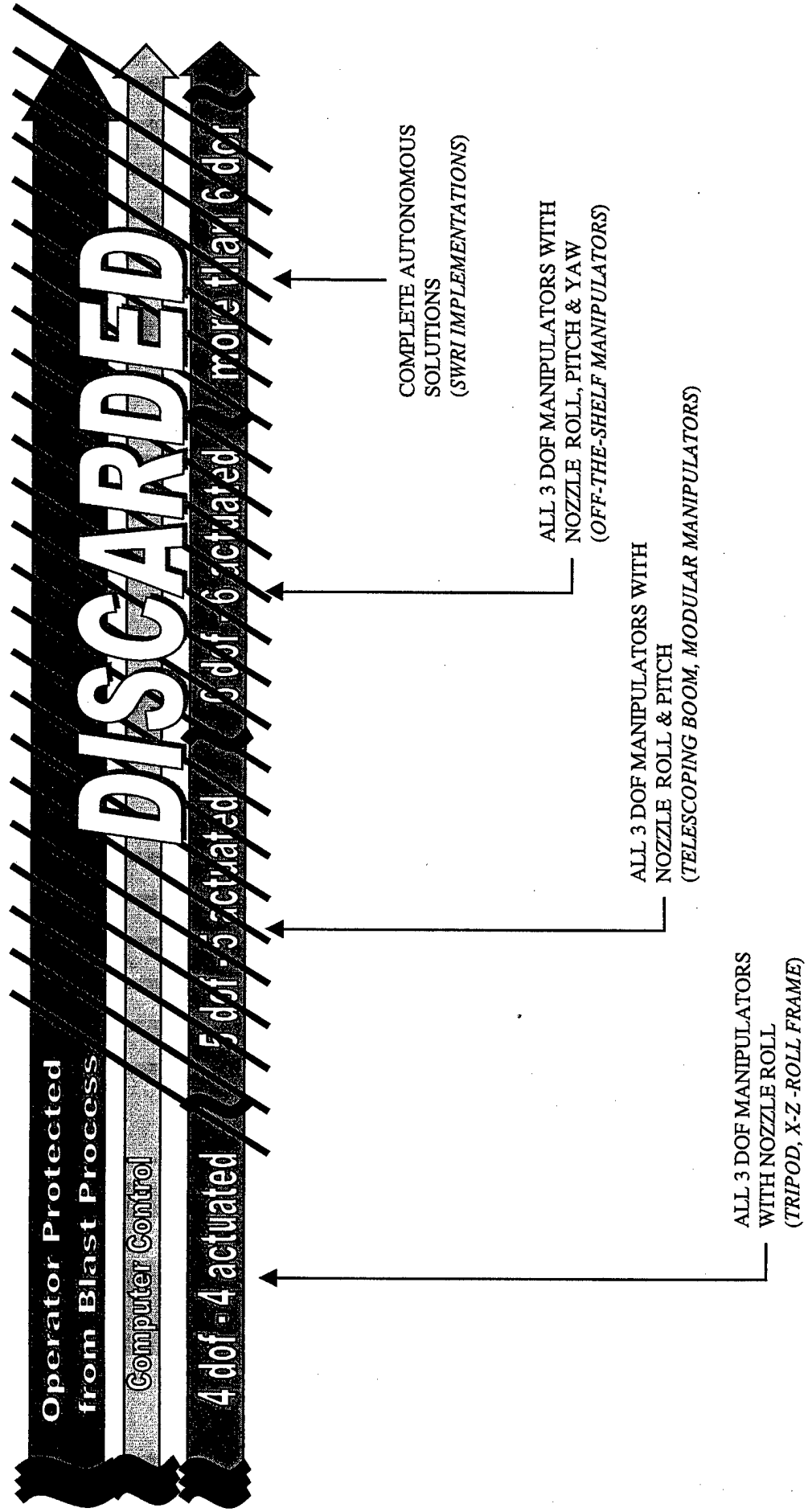

Operator Protected from Blast Process Computer Control

System Concept Brainstorming Summary

2 Carrier Concepts

2 Manipulator Concepts

RoboCrane

Macro-Manipulator Concept

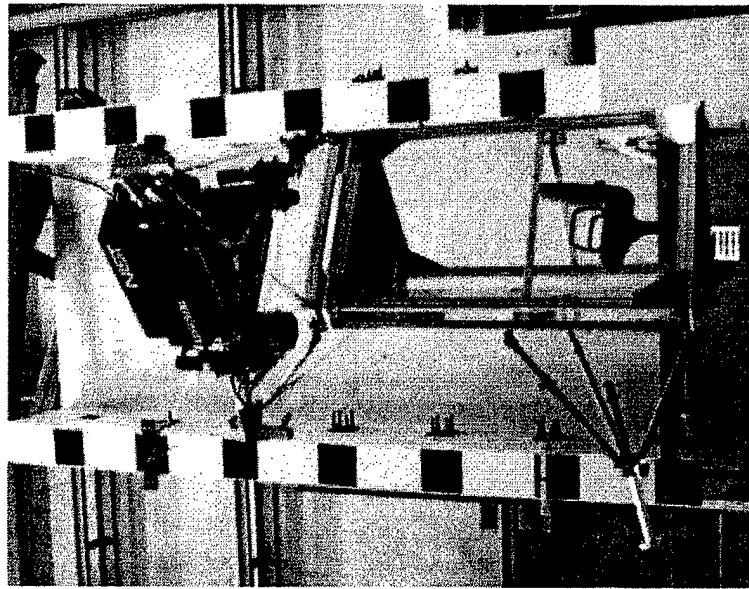

See RoboCrane Video

PRO

- Modular/Relatively Cheap
- Easily scalable in size, mounting configuration
- High payload/weight ratio
- Full 6 d.o.f. joystick control
- Straight line motion inherent
- Stand-off control and surface following available
- Collision avoidance safeguards available
- Positions personnel without scaffolding or other ground based equipment
- Ideal for masking access to elevated surfaces
- Operator can wield hand tools, wands, inspection equipment, ...
- Power Failure Mode: No motion

CON

- Existing technology, but not yet commercially available

See Video



Facility Mounted RoboCrane

Proposed Hangar Configuration

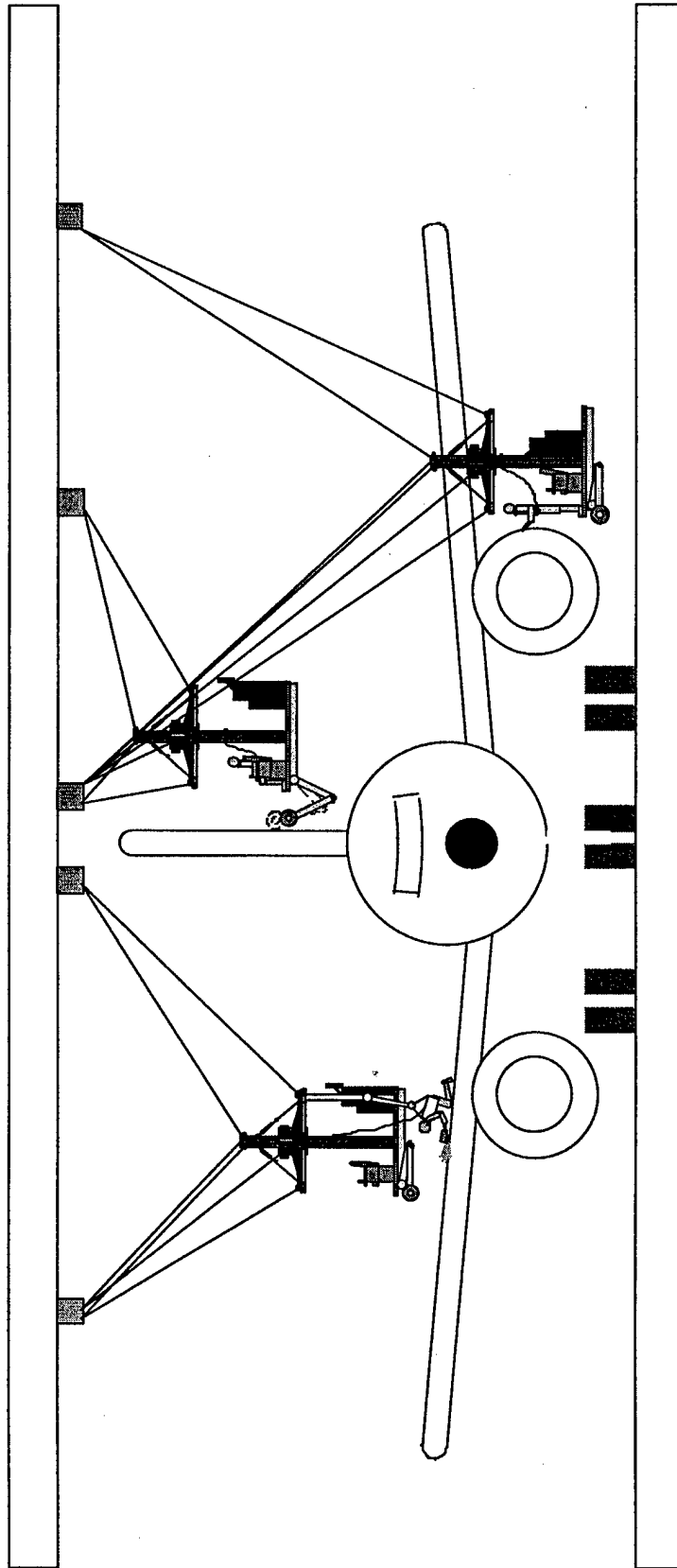

Aircraft Depaint Manipulator

Facility Mounted RoboCrane

Proposed Hangar Configuration

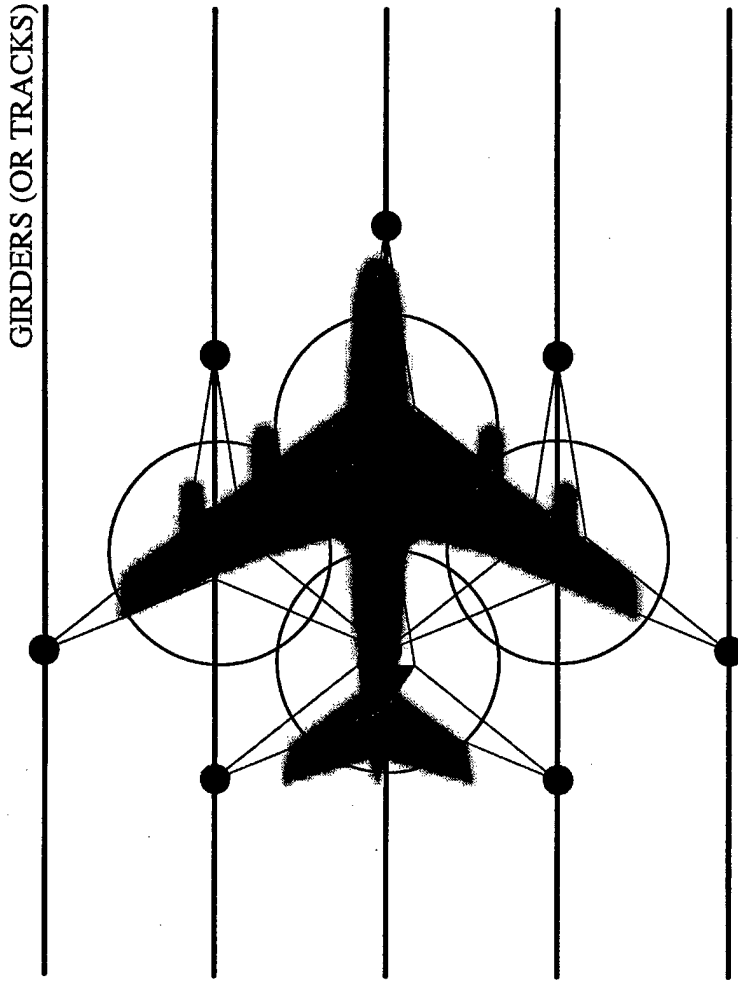

- Mounting to ceiling
 - Simple girder clamps work well
 - Several interleaved platforms
 - Static mounting points are configured for aircraft position
 - Systematic mounting points may cover multiple aircraft placements
 - Tracks allow sliding and nesting of work volumes - max flexibility
- Scalable paradigm
 - Pattern can be repeated in all directions for larger facilities
 - Relative positions can vary from sparse to dense

Coordinated Control Aerial Lift

Macro-Manipulator Concept

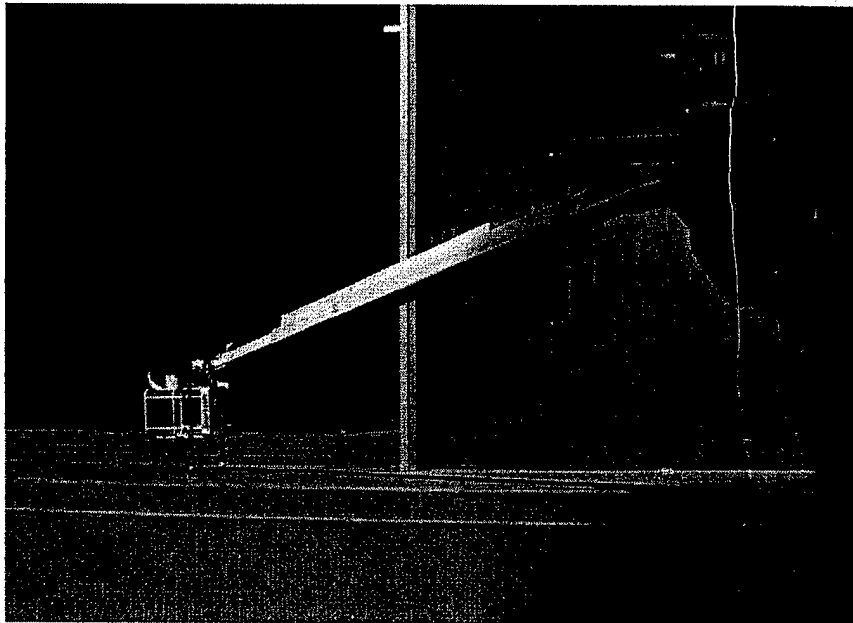

See NIST/Navy Aerial Lift Video

Aerial Lift Department Manipulator Job

See Video



Aircraft Depaint Manipulator Unit

NIST/Snorkel Inc. - Enhanced Aerial Lift

Overview of Two Projects

First project (ship hull stripping 1995) Navy Mantech funded

- Joint project between NIST and Snorkel (major manufacturer)
 - NIST/Snorkel CRADA established 3/1/95
 - Cooperative Research and Development Agreement
 - Snorkel provided aerial lift & technical support
 - NIST developed, implemented, demonstrated control system

Second project (ship hull painting 1999) Navy ManTech funded

- Goal is continuous, coordinated motion between Enhanced Aerial Lift and painting micro-manipulator
- Continuing NIST/Snorkel CRADA (3/1/95 to present)
- Further refinement of control (smooth motion)
- R&D of component technologies (e.g. digital sensors)

NIST/Snorkel Inc. - Enhanced Aerial Lift

Program Accomplishments

Enhanced control for off-the-shelf Snorkel aerial lift

- X,Y,Z motion of the bucket via single intuitive joystick
- Coordinated motion always referenced to bucket
 - X, Y, Z reference rotates as operator rotates bucket
- Collision avoidance sensors for standoff distance and speed
 - Stop or limit speed when bucket is near object/surface
 - Distance & speed operator selectable
- Programmed paths if desired (both forward and reverse)

Retrofit of minimum aerial lift components

- Implementation of low cost, off-the-shelf control components
- Original mechanical and hydraulic components maintained
- Implementation of position sensors at joints
- Implementation of industrial, solid state micro-controllers
- Single intuitive joystick replaces multiple joysticks & switches

NIST/Snorkel Inc. - Enhanced Aerial Lift

Current Work

- Continuous, coordinated control between Enhanced Aerial Lift & paint micro-manipulator
- Refinement of smooth motion control
 - Improved base swing joint (NIST & Snorkel)
 - Improved bucket rotate joint (NIST & Snorkel)
- R&D of component technologies
 - Absolute digital linear position sensor
 - Patent pending
 - Low cost, high resolution, solid state reliability
- NIST continues demonstrations of Enhanced Aerial Lift
- Integration of technologies into Snorkel product line

Coordinated Control Aerial Lift

Macro-Manipulator Concept

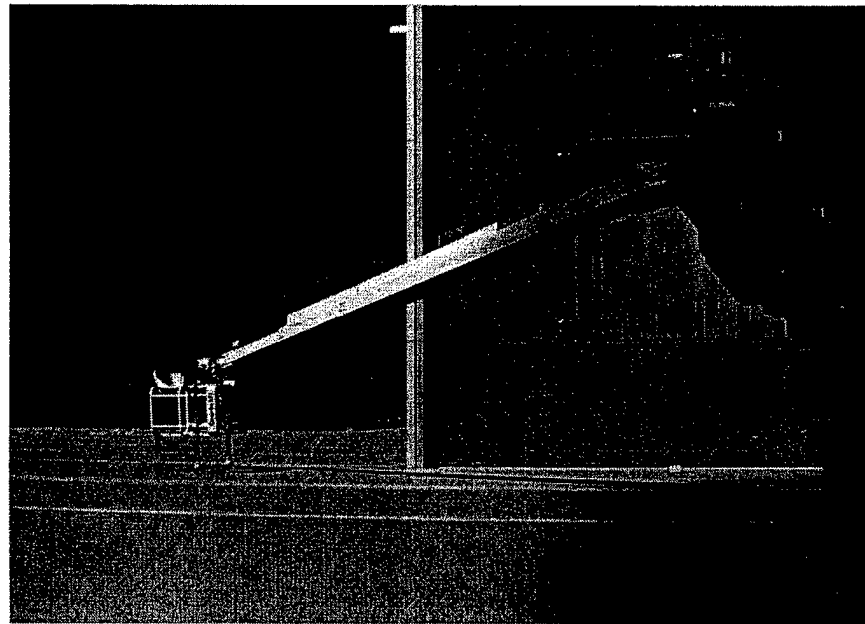

PRO

- Proven commercial equipment
- Operator familiarity
- Advanced control system coordinates joints
- Intuitive single joystick operation means less reliance on base vehicle to reposition operator
- Cartesian, cylindrical and surface following modes available
- Computer enforced operating limits
- Collision avoidance available
- Leverages Navy sponsored tech development
- Existing demos available
- Power Failure Mode: No motion

CON

- Bouncy at long reaches
- Must navigate around ground obstacles
- Not designed to be media proof

See NIST/Navy Aerial Lift Video



This slide contains confidential and proprietary information which is the intellectual property of NIST. Do not disclose or disseminate.

Tripod Manipulator

Micro-Manipulator Concept

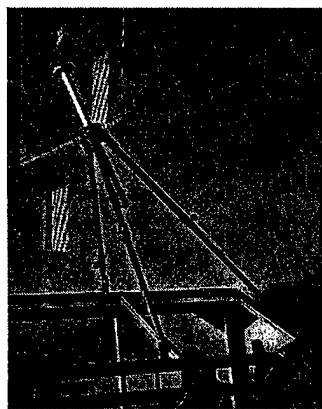
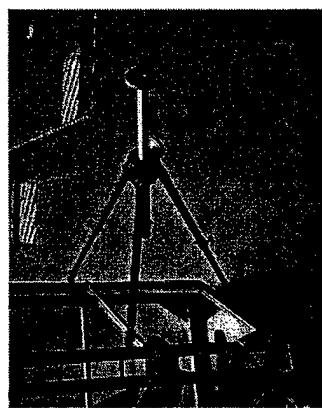
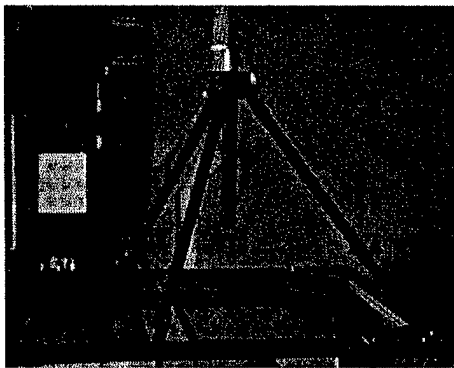
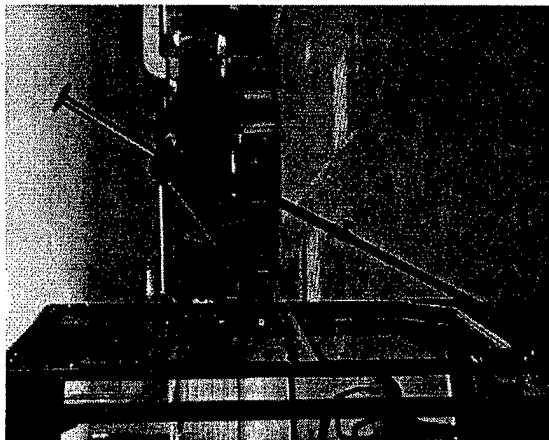

PRO

- Simple/Cheap/Modular/Reliable
- Easily scalable in size with same actuators
- High payload/weight ratio
- Extremely rigid configuration
- Configurable for both aerial and floor versions

Confidential Department Manipulator

Tripod Manipulator

Control Options

<u>Control Option:</u>	<u>Pros:</u>	<u>Cons:</u>
No Control	<ul style="list-style-type: none"> • Allows simple tool stand-off in front of personnel cab • Easily reconfigurable to allow assorted tool positions and orientations • Power not required 	<ul style="list-style-type: none"> • No independent motion, all process motion must derive from macro-manipulator (no patches)
Direct Control	<ul style="list-style-type: none"> • Joystick control • No sensors or computer • Electric, pneumatic, or hydraulic actuation • Nozzle orientation control optional • Power Failure Mode: No motion 	<ul style="list-style-type: none"> • Smaller workvolume than fully controlled tripod • No straight line motion (shallow arcs) • No collision avoidance or standoff control • No operator assist modes available
Coordinated Control	<ul style="list-style-type: none"> • Intuitive joystick control • Straight line motion inherent • Stand-off control and surface following available • Collision avoidance and anti-dwell safeguards • Other operator assist modes available (velocity, nozzle direction, indexing, rastering...) • Nozzle orientation control available • Power Failure Mode: No motion 	<ul style="list-style-type: none"> • Computer and sensors required



This slide contains confidential and proprietary information which is the intellectual property of NIST. Do not disclose or disseminate.

Tripod Manipulator

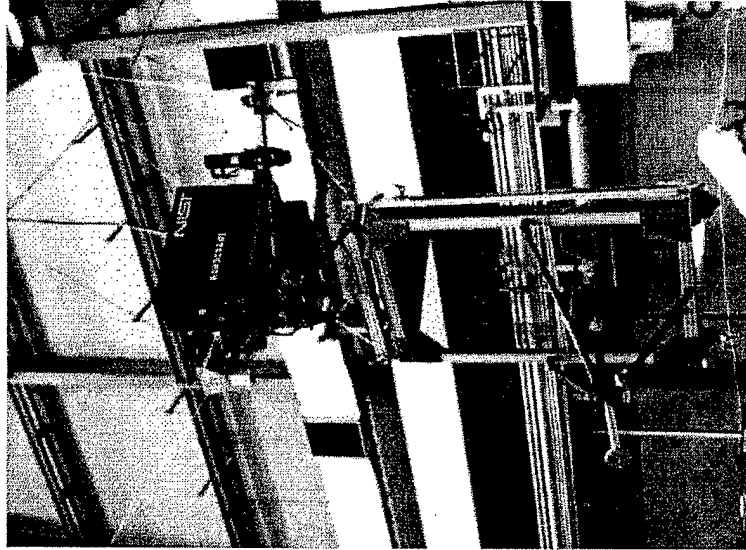
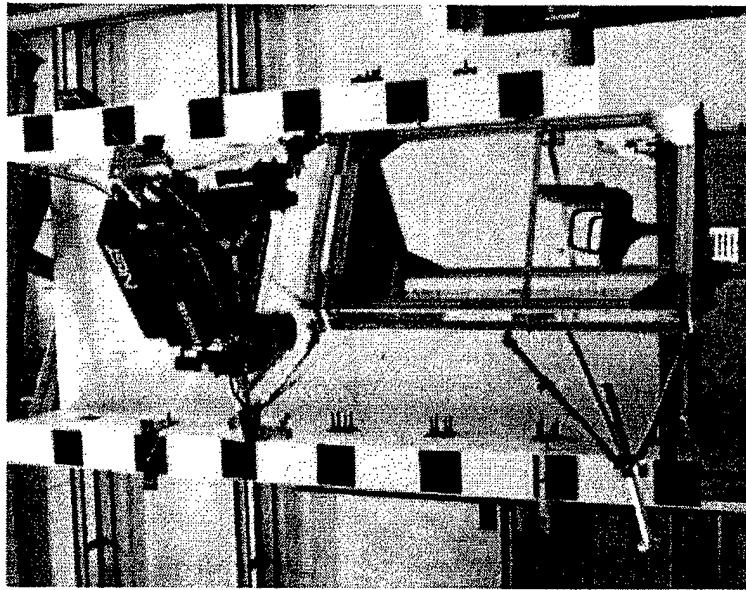

Aircraft Depaint Manipulator

Improved Work Environment

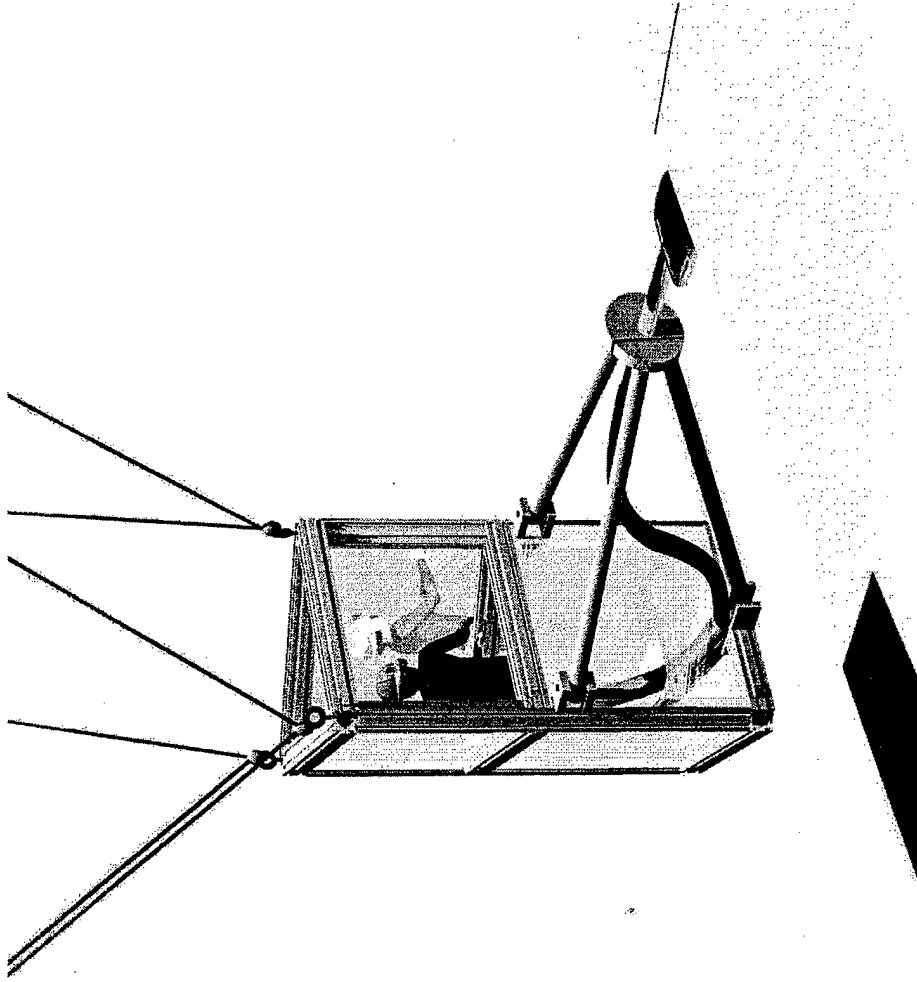

United States Aircraft Department Manipulator

Power Assist Wand



Manual Positioners

Shoulder Harnessed Wand

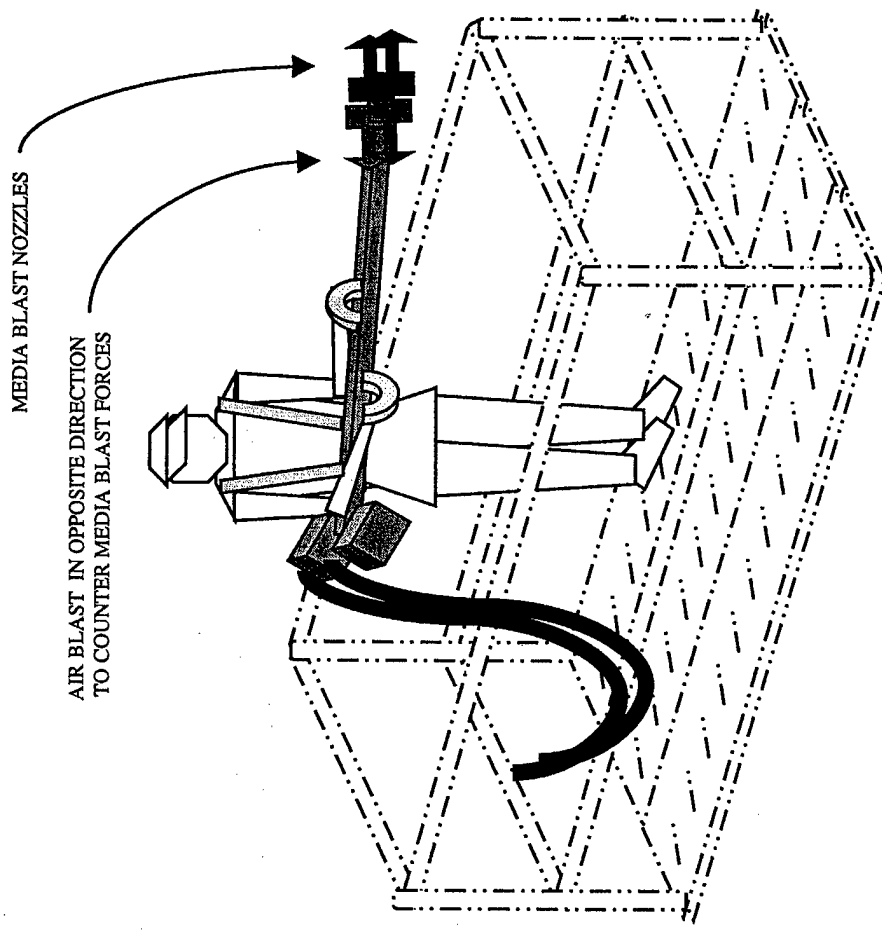

PRO

- Intuitive to use, based on weed whacker model
- Can go anywhere current wands go

CON

- Air blast to counter media nozzle reaction forces is completely experimental
- Operator fatigue
- Not practical for more than two ganged nozzles

Manual Positioners

Single Segment Wand

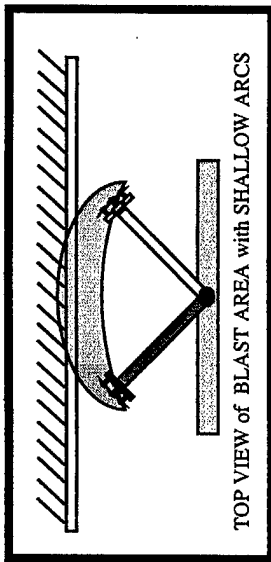

Degrees of Freedom: 2 Actuated Axes: 0

PRO

- Single (straight or bent) arm pivots at universal joint in rear
- Passively counterweighted for gravity
- All reaction forces directed through joint
- Workvolume can be improved with addition of indexable linear slide

CON

- X, Y motions form arcs
- Arc motions constrain nozzle angles
- Stand-off distance impossible to maintain
- Counterweights increase inertia, add to fatigue
- Relatively small workvolume

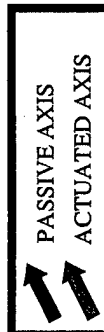
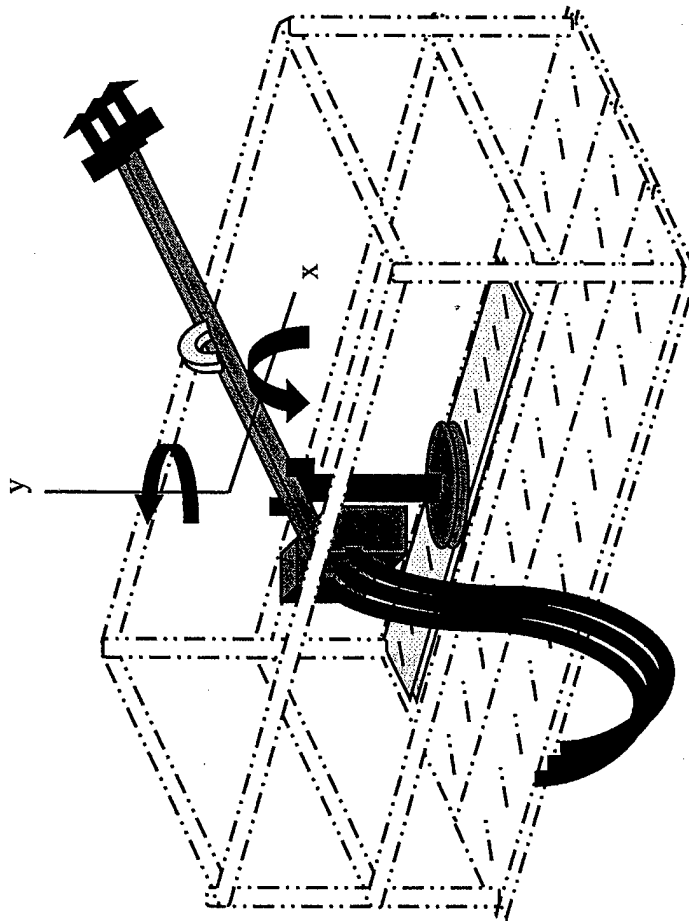

Manual Positioners

Single Segment Wand (with horizontal linear slide)

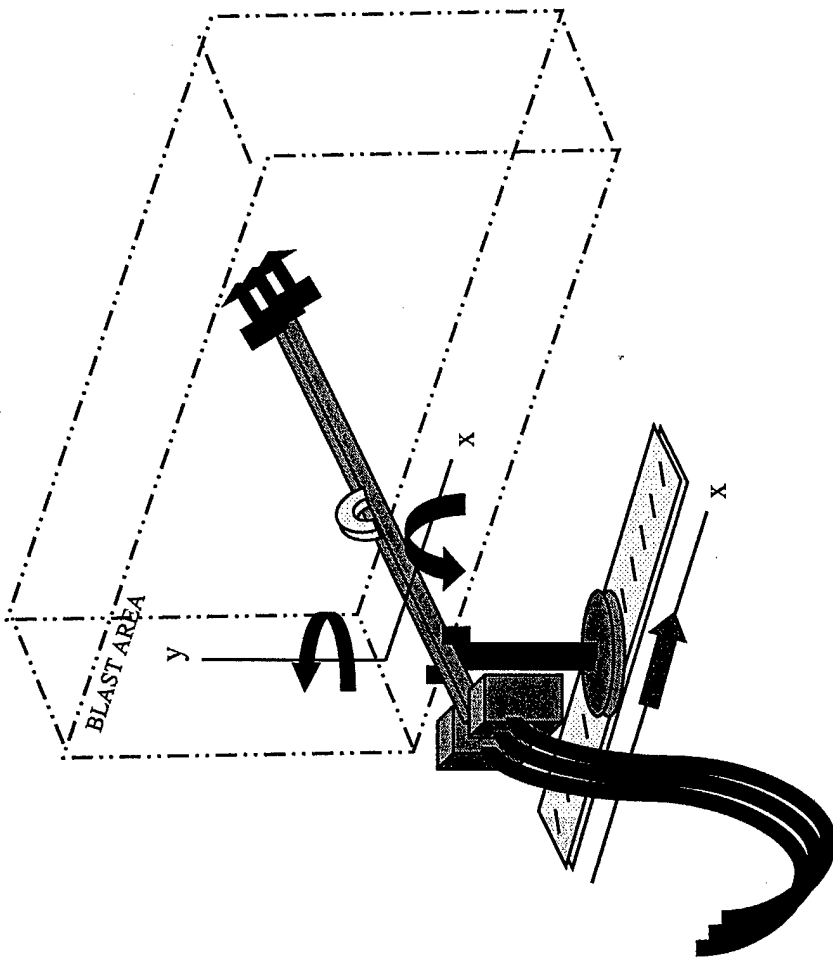

Degrees of Freedom: 3 Actuated Axes: 0 or 1

PRO

- Linear slide increases workvolume over Single Segment Wand
- Slide can be indexable or actuated

CON

- Linear slide cannot be passive due to variable direction of nozzle reaction forces

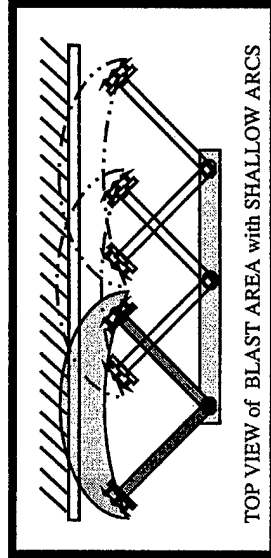

Manual Positioners

Single Segment Wand (with telescoping reach)

Degrees of Freedom: 3 Actuated Axes: 1

PRO

- Telescoping reach allows straight line motion of blast nozzles
- Work volume can be further improved by adding a linear slide

CON

- Telescoping reach cannot be passive due to nozzle reaction forces

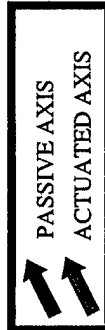
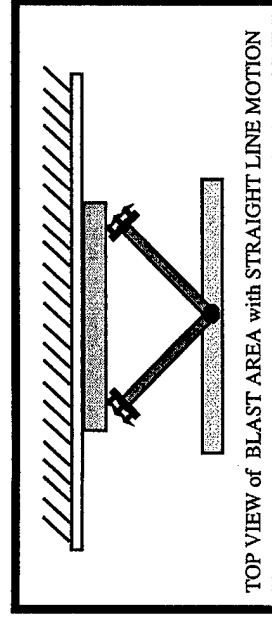
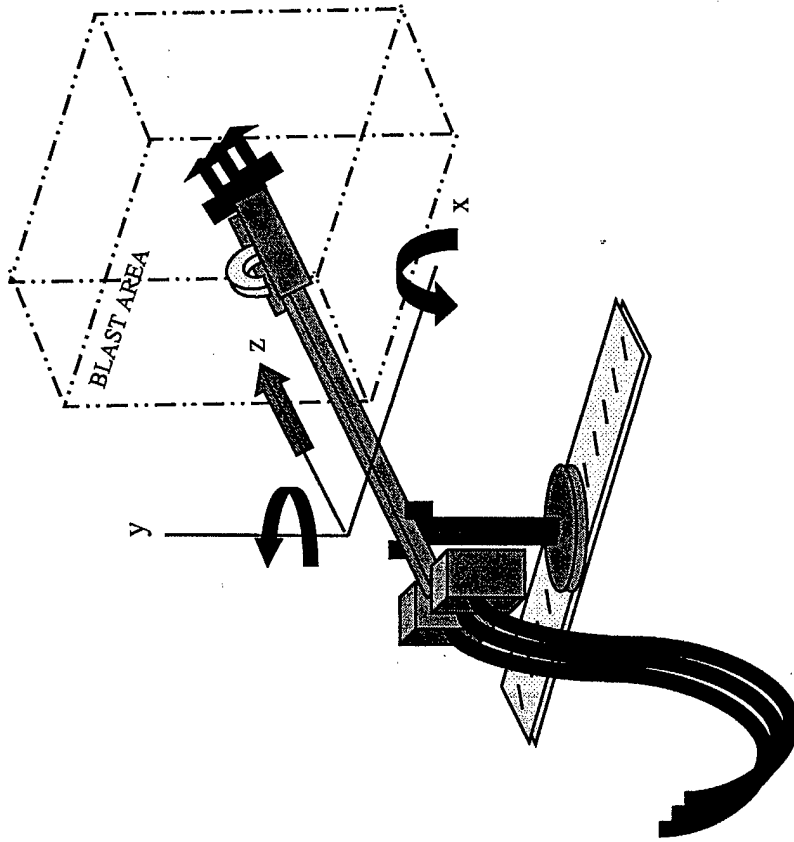

Manual Positioners

Two Segment Wand

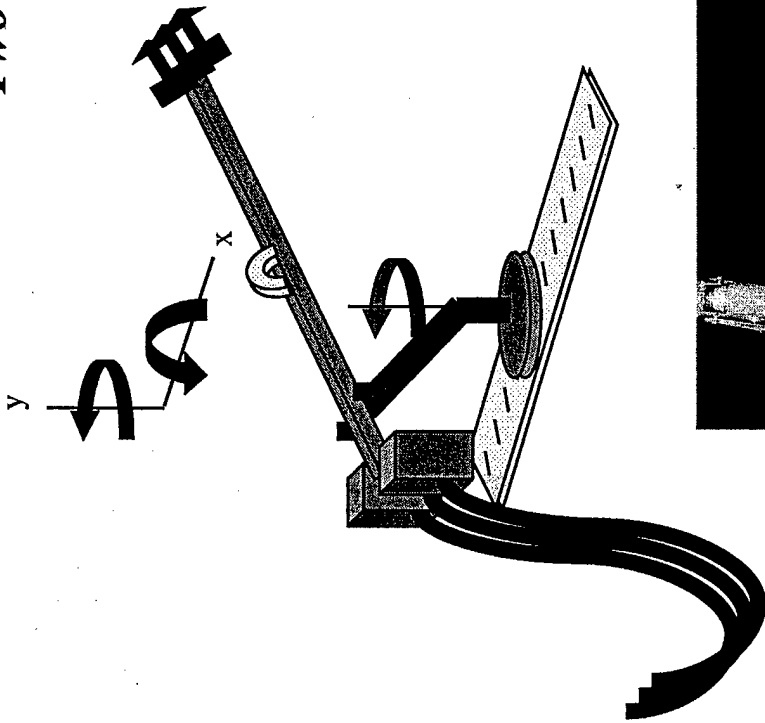

Degrees of Freedom: 3 Actuated Axes: 1

PRO

- Two (straight or bent) arms allows greater and more intuitive workvolume
- Straight line motion possible
- Stand-off distance maintainable
- Still passively counterweighted for gravity
- Workvolume can be further improved with addition of indexable linear slide

CON

- Arc motions effect nozzle angles
- Counterweights increase inertia, add to fatigue
- Workvolume is limited

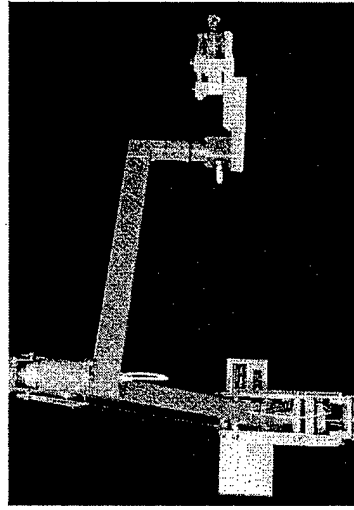

Aircraft Depaint Manipulator

Manual Positioners

Double Four Bar Arm

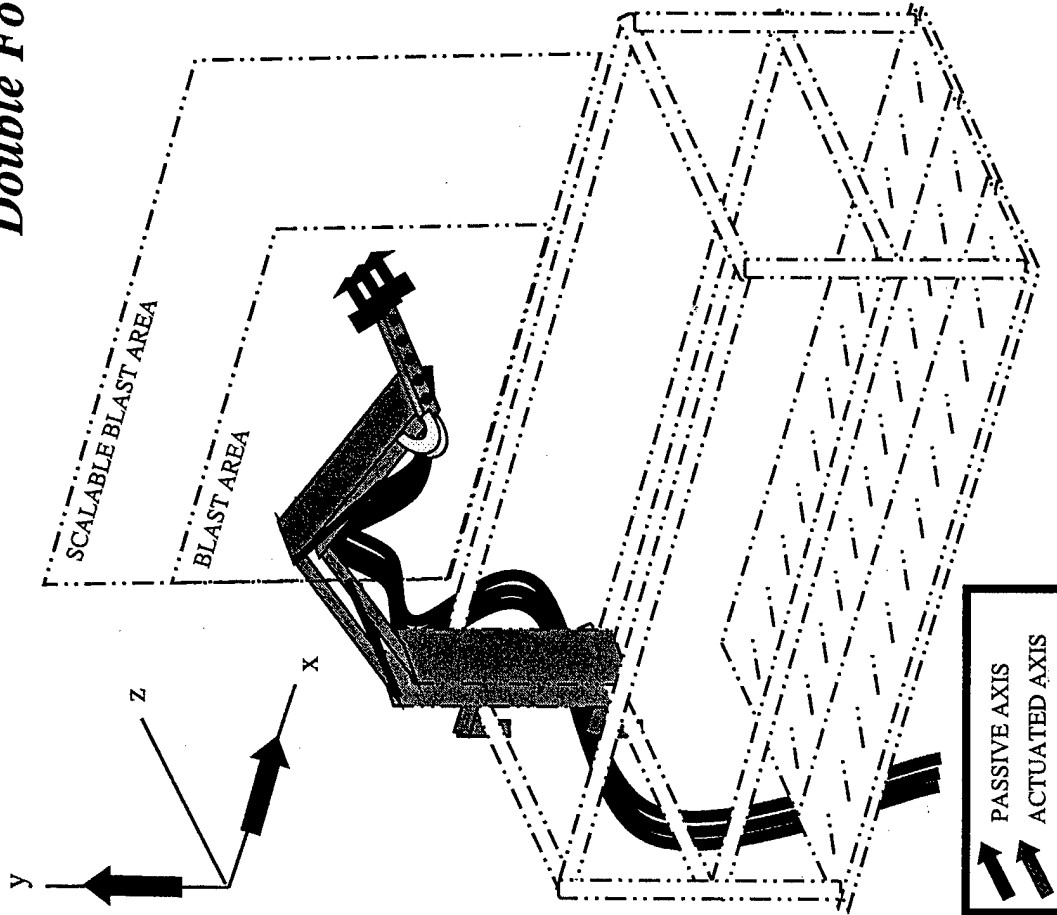

Degrees of Freedom: 2 Actuated Axes: 0

PRO

- Intuitive straight line motions in x-y plane
- Stand-off distance maintainable and indexable
- Passively compensated for gravity
- Attaches to RoboCrane or Aerial Lift basket
- Scalable configuration and reversible mounting
- Upgradable to actuated system with master/slave or joystick input
- Based on commercial equipment

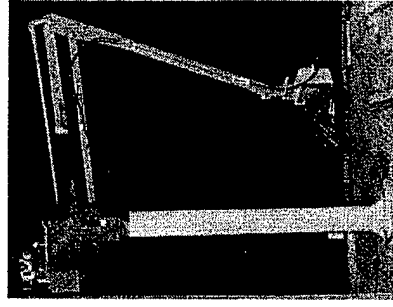
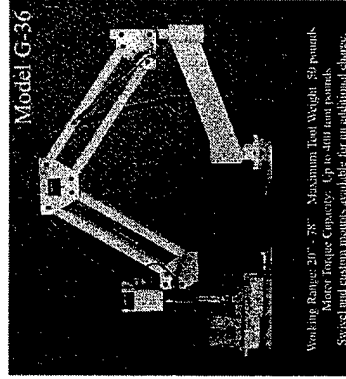

Aircraft Department Manipulator Unit

Manual Positioners

Passive X-Y Frame

Degrees of Freedom: 2 Actuated Axes: 0

PRO

- Intuitive straight line motions in x-y plane
- Stand-off distance maintainable and indexable
- Passively counterweighted for gravity
- Attached to RoboCrane or Aerial Lift basket
- X-Y frame is below operator line of site
- Upgradable to actuated system with master/slave or joystick input
- Based on existing equipment

CON

- Larger structure than arm based approaches

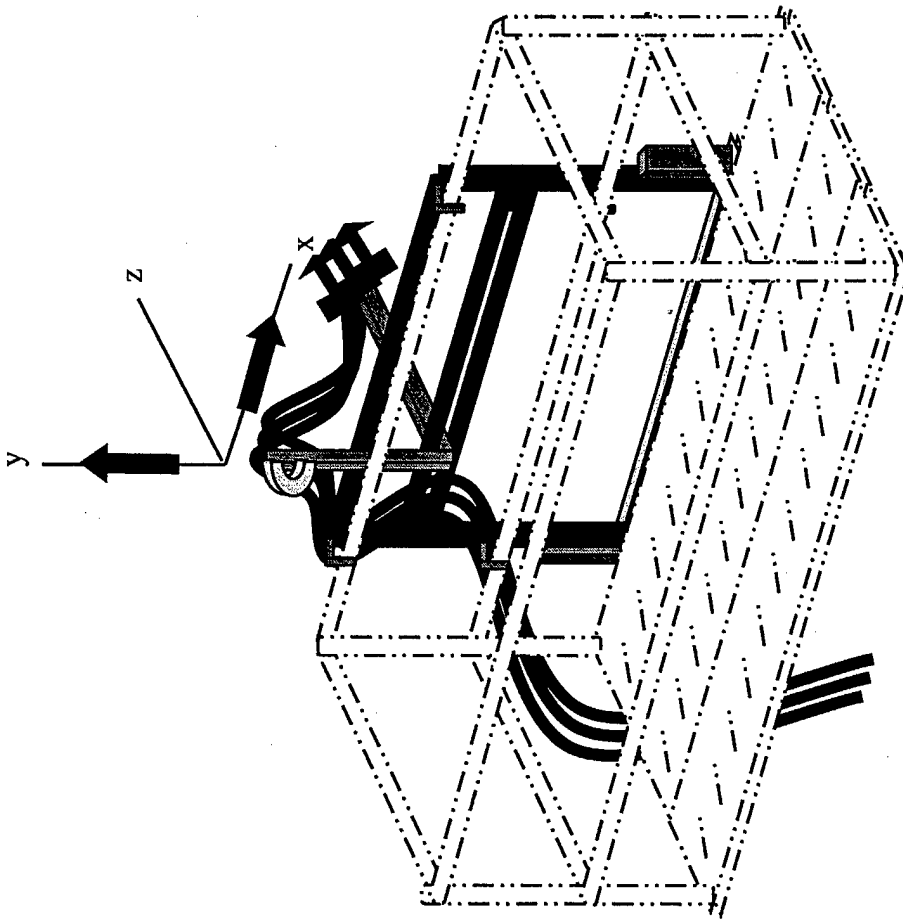

Power Assist Wand

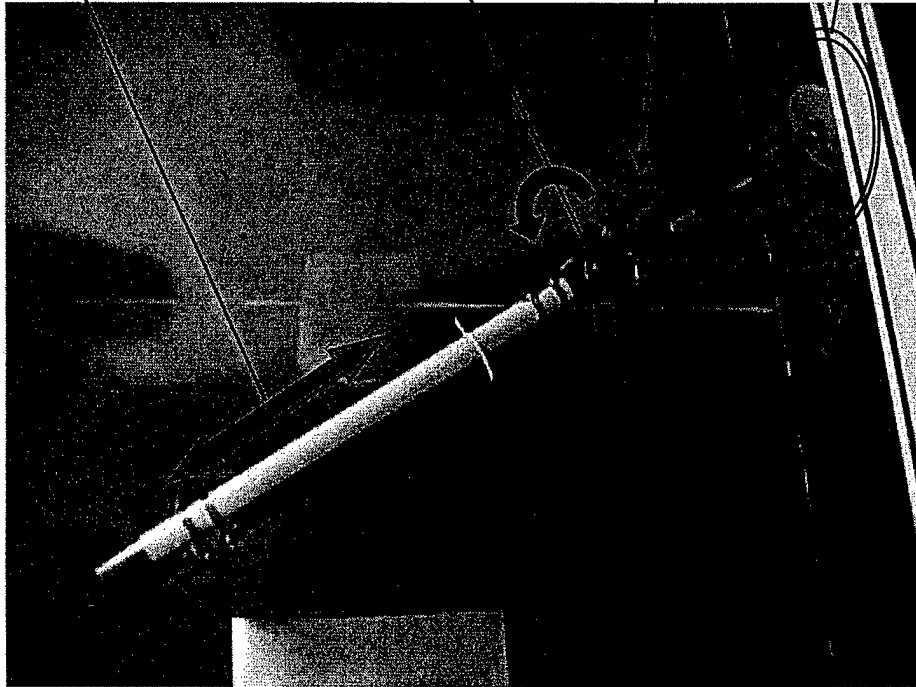

Active Telescoping Member

- This member will be actively positioned via a small explosion-proof electric motor. By controlling this direction, the user will not feel the reaction forces from the blast hose.
- Ganging of nozzles possible
- *Options:* Standoff sensor could maintain a required standoff distance

Unpowered Universal Joint

- Simple/Cheap/Reliable
- Intuitively positioned by operator (manually)

Easy to Use Handle/Position Control

- Simple/Cheap/Reliable
- Intuitively controlled by operator

Compensation Weight

- Simple/Cheap/Reliable
- Provides gravity compensation of the blast hose

Power Assist Wand

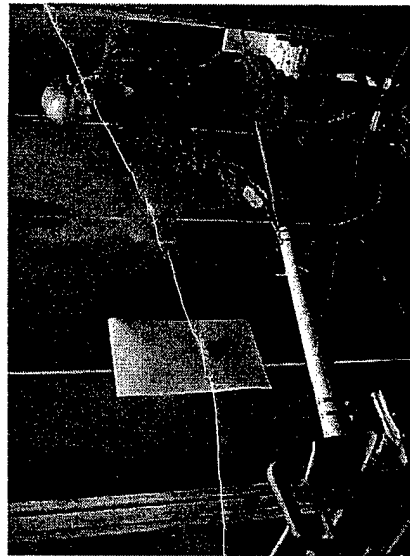
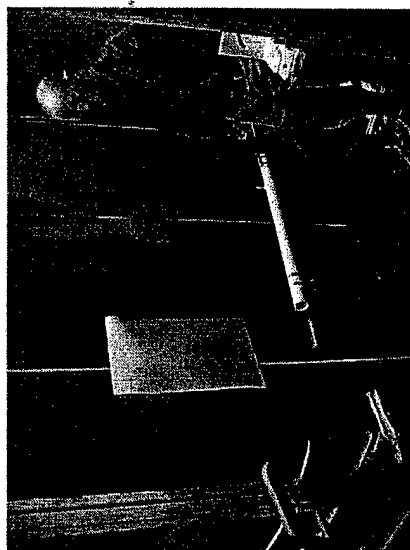
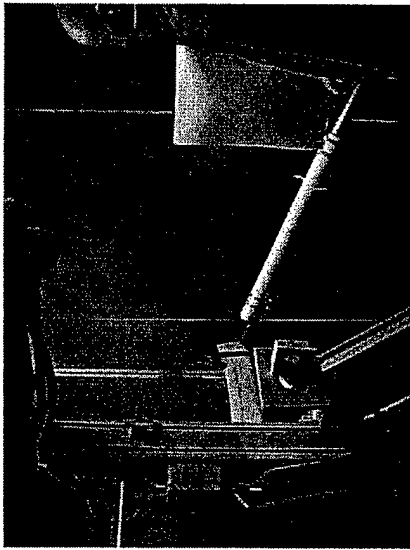
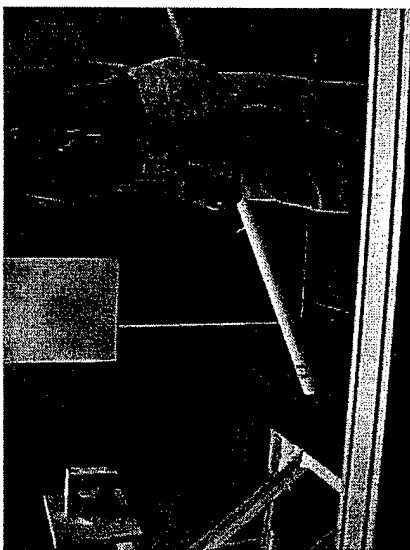

Copyright © 1997 by Department of Manufacturing Technology

Power Assist Wand

PROs

- Improved Ergonomics
- Increases the users reach without moving (workable patch area increases from 4 square feet to 16 square feet or more).
- Greatly Reduces Fatigue for Overhead Operations
- Simple/Cheap/Reliable
- Provides gravity & reaction force compensation
- Ganging of nozzles possible
- Intuitively positioned by operator (manually)
- Intuitively controlled by operator
- Options: Standoff sensor to maintain standoff distance

CONs

- Does not maintain a specific angle of attack to the surface. (but is within tolerance of the T.O.)
- Must be hard mounted to a carrier

Technology Demonstrations

Small Department Manipulator

Requirements

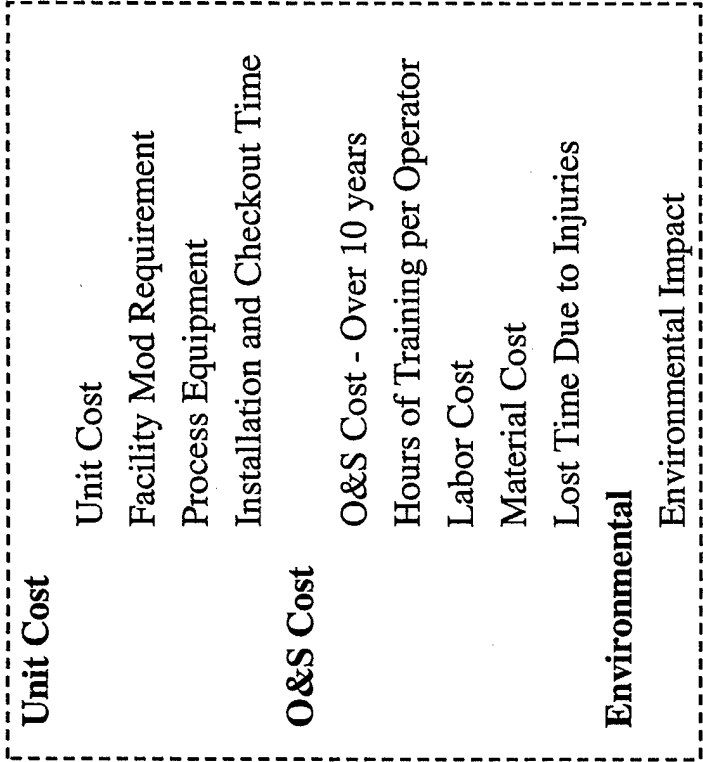
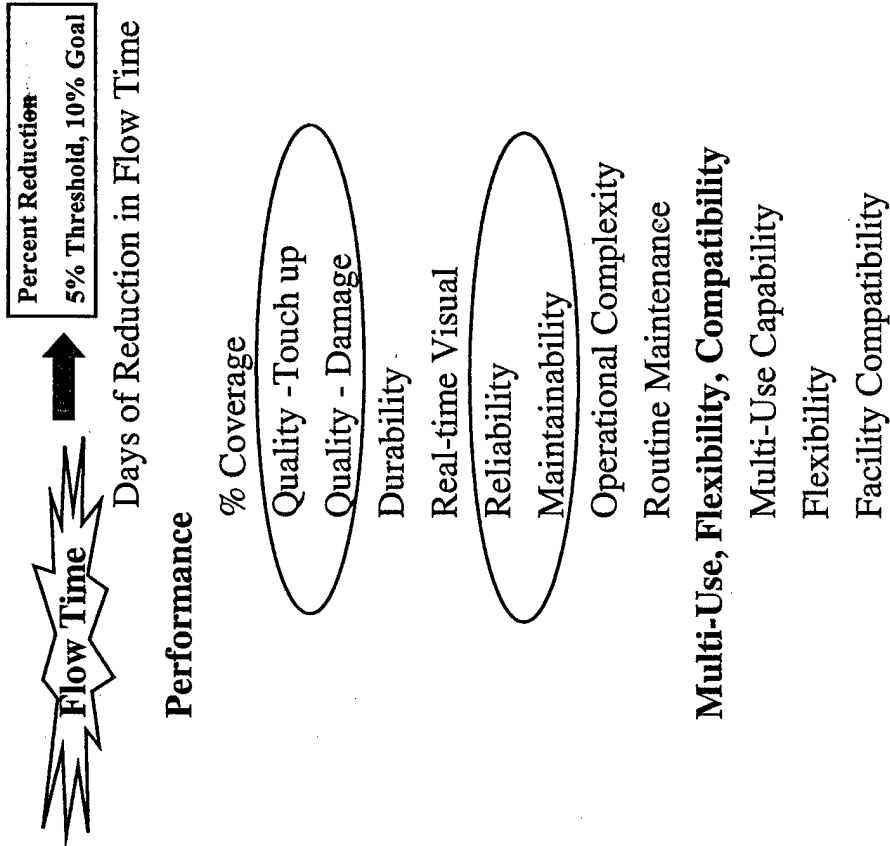

Health

- Reduce Operator Stress
- Exposure to Hazardous Materials



4 Major Requirements Considered

Flow Time

Percent Reduction in Flow Time

Performance

% Coverage

Durability

Real-time Visual

Operational Complexity

Routine Maintenance

Multi-Use, Flexibility, Compatibility

Multi-Use Capability

Flexibility

Facility Compatibility

Health

Reduce Operator Stress

Exposure to Hazardous Materials



Flow Time

DMP Scorecard: New_Flow_Time		FlowTime										Total FlowTime Zeta		
Constructed		(10) Elapsed Aircraft Flow Time in the Depart Process										FlowTime Satisfaction Index		
Weight →		1.0												
Technology Alternative ↓		μ	σ										d	ζ
1	Robocrane	10	0.00000										1.000	0.00000
	Desirability for Robocrane	1.000												
2	Enhanced Aerial Lift	10	0.00000										1.000	0.00000
	Desirability for Enhanced Aerial Lift	1.000 *												
3	Power Assist Wand	9.5	0.00000										1.000	0.00000
	Desirability for Power Assist Wand	1.000												
4	Tripod	9.5	0.00000										1.000	0.00000
	Desirability for Tripod	1.000												



Performance

DMP Scorecard: New_Perf		Perf											
		(20) Coverage		(23) Durability		(24) Real-time Visual		(27) Operational Complexity		(27) Routine Maintenance		Perf Satisfaction Index	
Technology Alternative	Weight	μ	σ	μ	σ	μ	σ	μ	σ	μ	σ	d	ζ
		1	Robocrane	80	0.50000	29	0.31697	100	0.00000	1	0.02275	50	0.00069
	Desirability for Robocrane	0.500		0.547		1.000		1.000		1.000			
2	Enhanced Aerial Lift	80	0.50000	37.5	0.01539	100	0.00000	1	0.02275	50	0.00069	0.772	0.41657
	Desirability for Enhanced Aerial Lift	0.500		0.615		1.000		1.000		1.000			
3	Power Assist Wand	80	0.50000	100	0.15545	100	0.00000	1	0.00000	200	0.00007	0.824	0.48083
	Desirability for Power Assist Wand	0.500		0.929		1.000		1.000		1.000			
4	Tripod	80	0.50000	75	0.20725	100	0.00000	1	0.02275	200	0.00007	0.808	0.51813
	Desirability for Tripod	0.500		0.826		1.000		1.000		1.000			



Multi-Use

DMP Scorecard: New_Flexibility		Multi-Use											
Technology Alternative	Weight	(30) Multi-Use Capability			(31) Flexibility			(32) Facility Compatibility			Total Multi-Use Zeta		
		μ	σ	ζ	μ	σ	ζ	μ	σ	ζ	μ	σ	ζ
1 Robocrane	7	0.00000	8	0.00000	1	0.00000	0.875	0.00000	0.808	0.00000	0.000	0.00000	
Desirability for Robocrane	0.646				1.000								
2 Enhanced Aerial Lift	6.5	0.00000	8	0.00000	1	0.00000	0.000	0.00000	0.000	0.00000	0.000	0.00000	
Desirability for Enhanced Aerial Lift	0.500				1.000								
3 Power Assist Wand	3	0.00000	8	0.00000	1	0.00000	1.0	0.00000	1.0	0.00000	1.0	0.00000	
Desirability for Power Assist Wand	0.000				1.000								
4 Tripod	3	0.00000	8	0.00000	1	0.00000	0.000	0.00000	0.000	0.00000	0.000	0.00000	
Desirability for Tripod	0.000				1.000								

Constructed

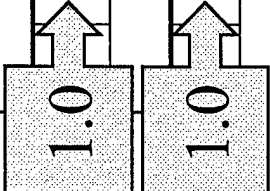

Health

DMP Scorecard: New_Health		Health											
Constructed	Weight	(70) Reduce Operator Stress					(71) Exposure to HazMat					Health Satisfaction Index	Total Health Zeta
		5.0		3.0		5.0		3.0		d	z		
		μ	σ	μ	σ	μ	σ	μ	σ				
1	Technology Alternative	100	0.00000	100	0.00000	100	0.00000	100	0.00000	1.000	0.00000		
	Desirability for Robocrane	1.000		1.000		1.000		1.000					
2	Enhanced Aerial Lift	80	0.02275	75	0.02275	75	0.02275	75	0.02275	0.415	0.04448		
	Desirability for Enhanced Aerial Lift	0.371		0.500		0.500		0.500					
3	Power Assist Wand	75	0.02275	56	0.02275	56	0.02275	56	0.02275	0.221	0.04448		
	Desirability for Power Assist Wand	0.260		0.168		0.168		0.168					
4	Tripod	100	0.00000	100	0.00000	100	0.00000	100	0.00000	1.000	0.00000		
	Desirability for Tripod	1.000		1.000		1.000		1.000					



Composite Scores

DMP Scorecard - Con't: New_Afford		Requirement Type												Affordability			
Constructed	Weight	FlowTime			Health			Multi-Use			Perf			(CSI, ζ_T)			
		5	3	4	5	3	4	5	4	5	5	5	0.902	0.43361			
Technology Alternative	→																
Robocrane		0.00000	0.00000	0.00000	0.00000	0.00000	0.00000	0.00000	0.56846								
Desirability for Robocrane		1.000	1.000	1.000	0.875	0.758											
Enhanced Aerial Lift		0.00000	0.04448	0.00000	0.00000	0.41657											
Desirability for Enhanced Aerial Lift		1.000	0.415	0.772	0.808												
Power Assist Wand		0.00000	0.04448	0.48083	0.00000	0.643											
Desirability for Power Assist Wand		1.000	0.221	0.824	0.000	0.931											
Tripod		0.00000	0.00003	0.51813	0.00000	0.000											
Desirability for Tripod		1.000	1.000	0.808	0.000												



Radar Score Charts

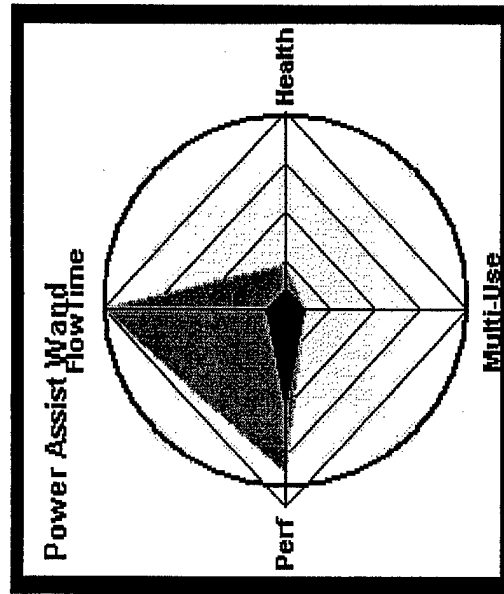
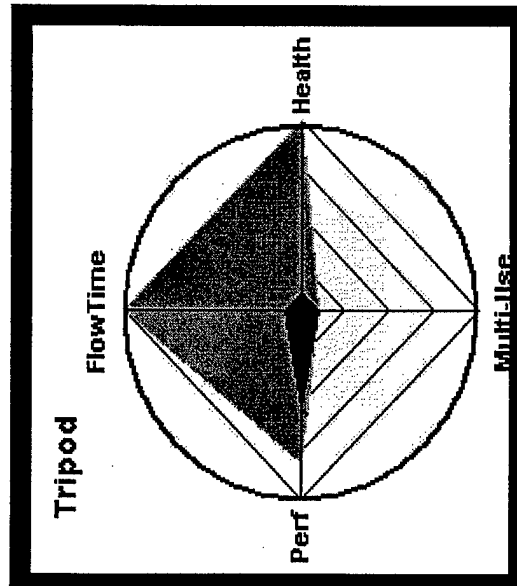
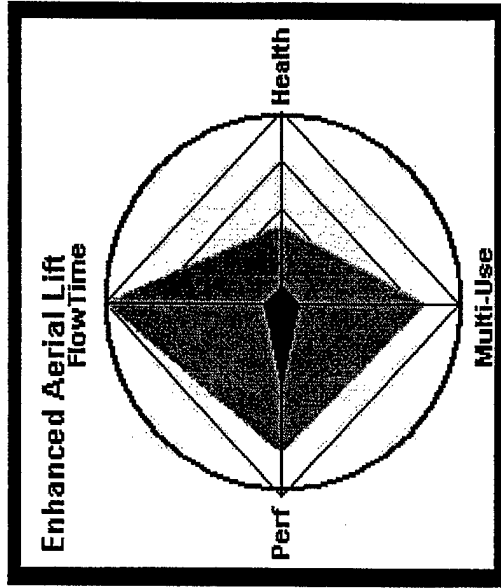
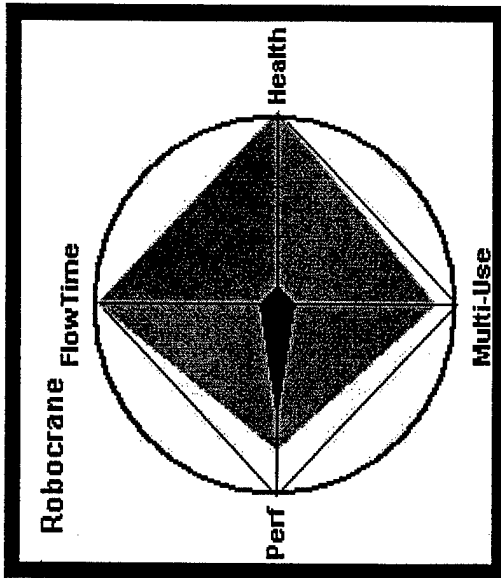

Adding more “Tools” to the “Tool Box”

Phase I

- Build and demo all four prototypes tailored for depaint - **Phase I**
- Build simulation to develop best strategy to increase trigger time and decrease flow time - **Phase I**
- Explore other nozzles/multi-nozzle/blast pressures/ stand-off requirements previously not possible due to ergonomic issues (focus on exploiting current facilities) - **CTIO**

Phase II

- Develop simulation using customer specific data to assist in selecting optimum set of tools (consider aircraft/facility/current equipment, work load, available personnel)
- Develop Production Hardware

Potential Demo Scenario

Targeted Surfaces of Aircraft

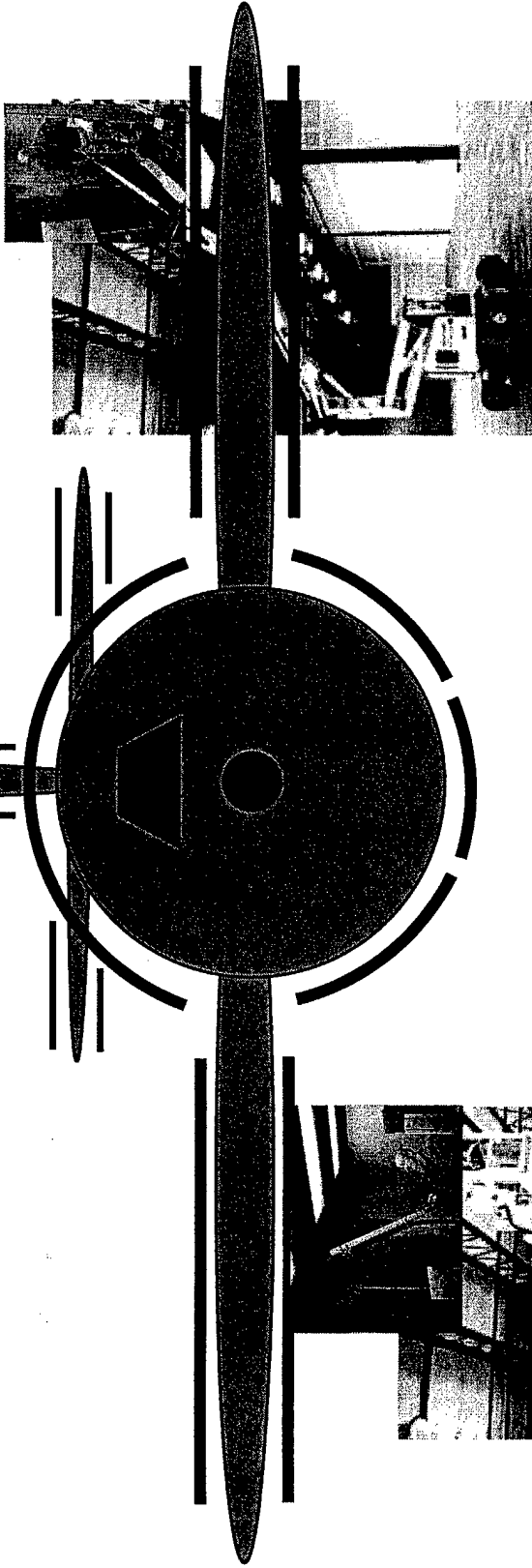

Aircraft Department Manipulator

Potential Demo Scenario

Targeted Surfaces of Aircraft

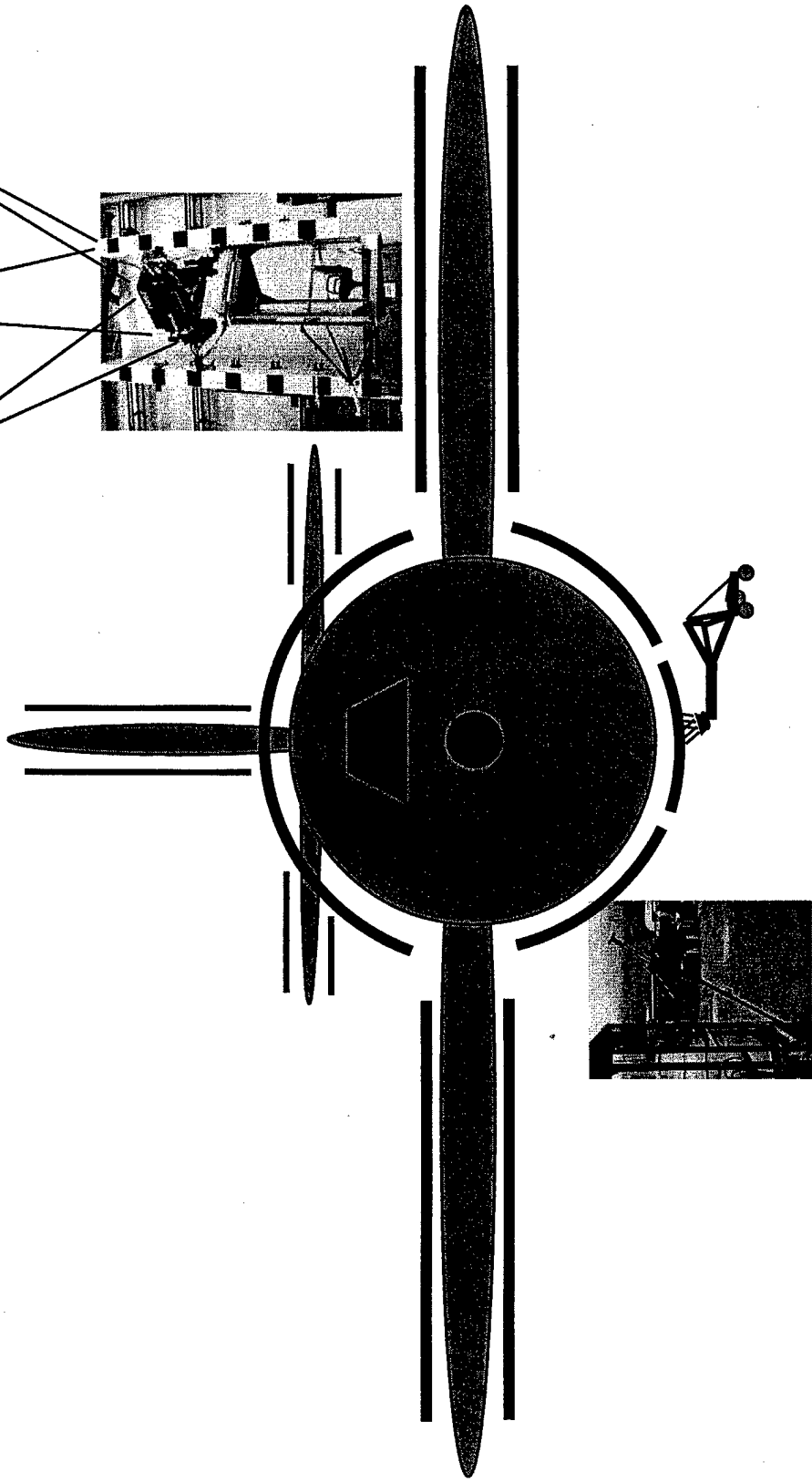

Air Force Research and Development Command, Wright-Patterson Air Force Base, Dayton, Ohio

Question & Answers



Health Department Manipulator