

Scientific and Technical Report

Final Report

By Satoru Simizu, R. T. Obermyer, and S. G. Sankar

ACL-CR-413

March 2000

Prepared by

Advanced Materials Corporation
700 Technology Drive
P. O. Box 1950
Pittsburgh, PA 15230-2950

Under contract

DAAL01-98-C-0080

STEVE MURRILL
AMSRL-SE-E
ALC, MD 20783

DISTRUBUTION UNLIMITED

AMC QUALITY INSPECTED 4

20001017 076

The findings of this report are not to be construed as an official Department of the Army position unless so designated by other authorized documents.

Citation of manufacturer's or trade names does not constitute an official endorsement or approval of the use thereof.

Destroy this report when it is no longer needed. Do not return it to the originator.

Table of Contents

- 1. Introduction..... 3
- 2. Design and Construction of SpectroImager II 4
 - 2.1. Acousto-Optic Tunable Filter 4
 - 2.2. Liquid Crystal Variable Retarder 7
 - 2.3. InGaAs Focal Plane Array Camera..... 9
 - 2.4. Lens Optics 11
 - 2.5. Improved Lens Optics..... 15
 - 2.6. Control and Imaging Software..... 22
- 3. Test Results..... 24
 - 3.1. Spatial Resolution..... 24
 - 3.2. Spectral Performance 27
 - 3.3 Polarization Analysis 31
 - 3.4 Outdoor Scenes 33
- 4. Specifications..... 35

Attachment: SpectroImager II – Technical Manual

1. Introduction

Advanced Materials Corporation has designed and constructed a spectro-polarimetric imaging system under contract with the Department of the Army (DAAL01-98-C-0080). The unit, which we will hereafter refer to as SpectroImager II, is a versatile spectro-polarimetric video imaging system that operates in the short wave infrared region between 900 nm and 1700 nm. It is an integrated imaging system with complete electronic control and interfaced with a standard PC. The software is user-friendly and allows easy access to the basic control parameters (filter wavelength, acoustic power level, sensitivity, retardance, etc.). In addition, it provides various data acquisition modes such as spectral data, spectrally filtered images, and real time image processing. In this Final Report, we will review the design and performance of the system and give an outline of steps for further improvement.

The basic configuration of SpectroImager II is shown schematically in Fig. 1.1. At the heart of the system is the acousto-optic tunable filter (AOTF) that provides efficient, polarization-specific light filtering. The range and resolution of the AOTF depend on the crystal and transducer design. In SpectroImager II, it is optimized for 800 ~ 1800 nm to cover the range of the InGaAs imaging array (900 ~ 1700 nm). The FWHM spectral resolution is 61 cm^{-1} .

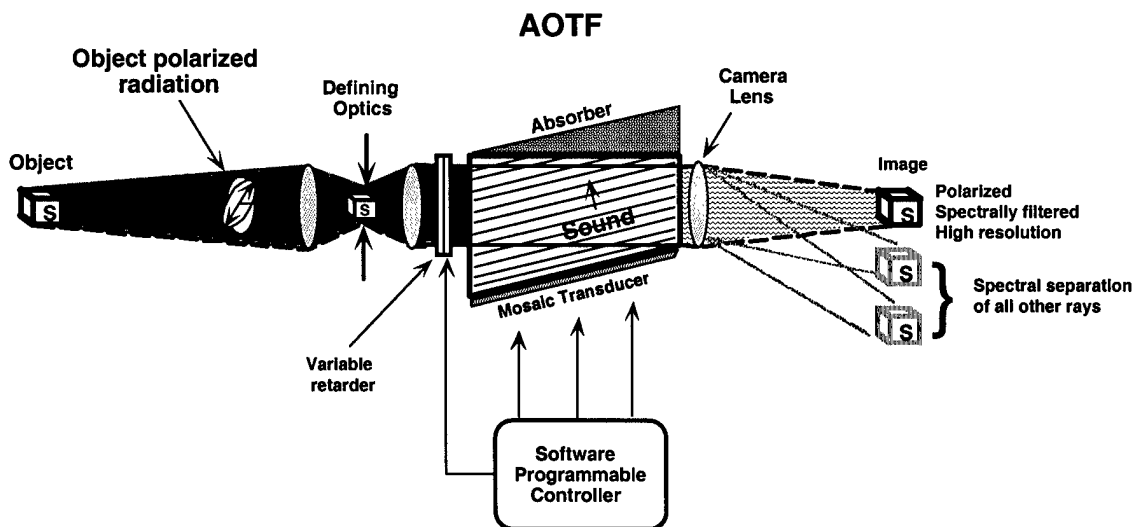

Fig. 1.1. Operation principle of SpectroImager II. The spectroscopically filtered polarized image forms on the focal plane array. The polarization state is controlled by the variable liquid crystal retarder. The control is electronic and interfaced with a standard PC.

Because the AOTF is polarization specific, the polarization state of light can also be analyzed. SpectroImager II includes a liquid crystal variable retarder (LCVR) for polarization control. This arrangement allows, in addition to the linear polarization, analysis of circular and elliptical polarization.

SpectroImager II acquires spectrally filtered images up to 30 frames per second. The AOTF has a fast access time of less than 30 μ sec, allowing rapid acquisition of spectral data. The software provides convenient methods to examine the spectral as well as polarimetric contents of the objects while displaying their images in real time. The visible version was developed with support from the Department of Defense under SBIR (DAAB07-95-C-M042, Lawrence Mizerka, 703-704-3666) and STTR (DAAH01-97-C-R227, Hugh C. Carson, 205-876-7215) programs. The short wave infrared version with further software enhancements has been completed under the present contract.

2. Design and Construction of SpectroImager II

2.1. Acousto-Optic Tunable Filter

SpectroImager II employs an acousto-optic tunable filter (AOTF) for spectral filtration. The AOTF allows rapid and flexible acquisition of spectrally filtered images. We have designed the TeO₂-based AOTF so that it will ideally match with the spectral range of the InGaAs camera. The basic performance data for the AOTF is summarized in Table 2.1.

Table 2.1. Specifications: Acousto-optic tunable filter (NEOS Technology, Melbourne, FL).

Material	TeO ₂			
Acoustic Mode:	Shear wave			
Acoustic Aperture Size:	15 mm			
Optical Aperture:	15 mm			
Spectral Range:	0.9 ~ 1.8 μ m			
Transmission:	95 % at 1.55 μ m and 1.5 W			
Resolution:	61 cm ⁻¹ FWHM (3.9 nm @ 0.8 μ m, 19.9 nm @ 1.8 μ m)			
Access Time:	30 μ sec			
Deflection Angle:	4.2°			
Tuning Relationship:	Wavelength (μ m)	Acoustic Frequency (MHz)	Acoustic Power (Watt)	
			100 % transmission	50 % transmission
	0.8	61.2	0.43	0.11
	1.0	49.0	0.68	0.17
	1.8	27.2	2.20	0.55

The AOTF was fabricated, for specifications provided by Advanced Materials Corporation, by NEOS Technologies (Melbourne, FL). Our test indicates that this AOTF shows much improved rf-matching performance over the earlier AOTF with a similar acoustic aperture. Figure 2.1 compares the power reflection ratio of the present AOTF with the earlier version of the AOTF with segmented transducers. The tests were conducted at 1 watt power input. With the new AOTF, the reflected power is less than -10 dB (10 % or less) for most of the operating range of 27 to 60 MHz. In contrast, the reflected power ratio to the transmitted power is -5 dB with the older technology. This improvement is largely due to the new single transducer design. In the previous AOTF, the transducer was split into three segments in order to provide adequate impedance matching with the transmission line.

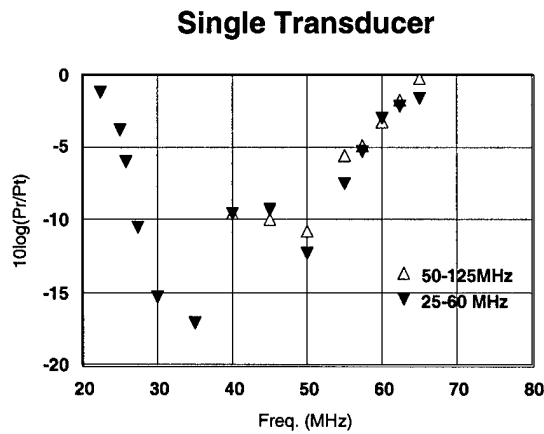

(a)

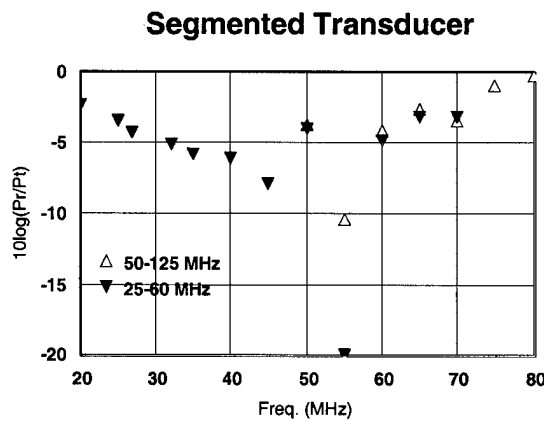

(b)

Fig. 2.1. Reflected power from the transducer of two AOTFs. (a) Presently produced single transducer AOTF. (b) Older AOTF with a three-segment transducer.

However, it has been difficult to eliminate the interference among the three segments that degrades the quality of the filtered image. Recently, NEOS has succeeded in implementing the design that achieves good impedance match for a large single transducer.

The transmission curve measured by NEOS at 1.55 μm is shown in Fig. 2.2. It closely matches the theoretical curve with side lobes at -12.6 dB and -14.6 dB.

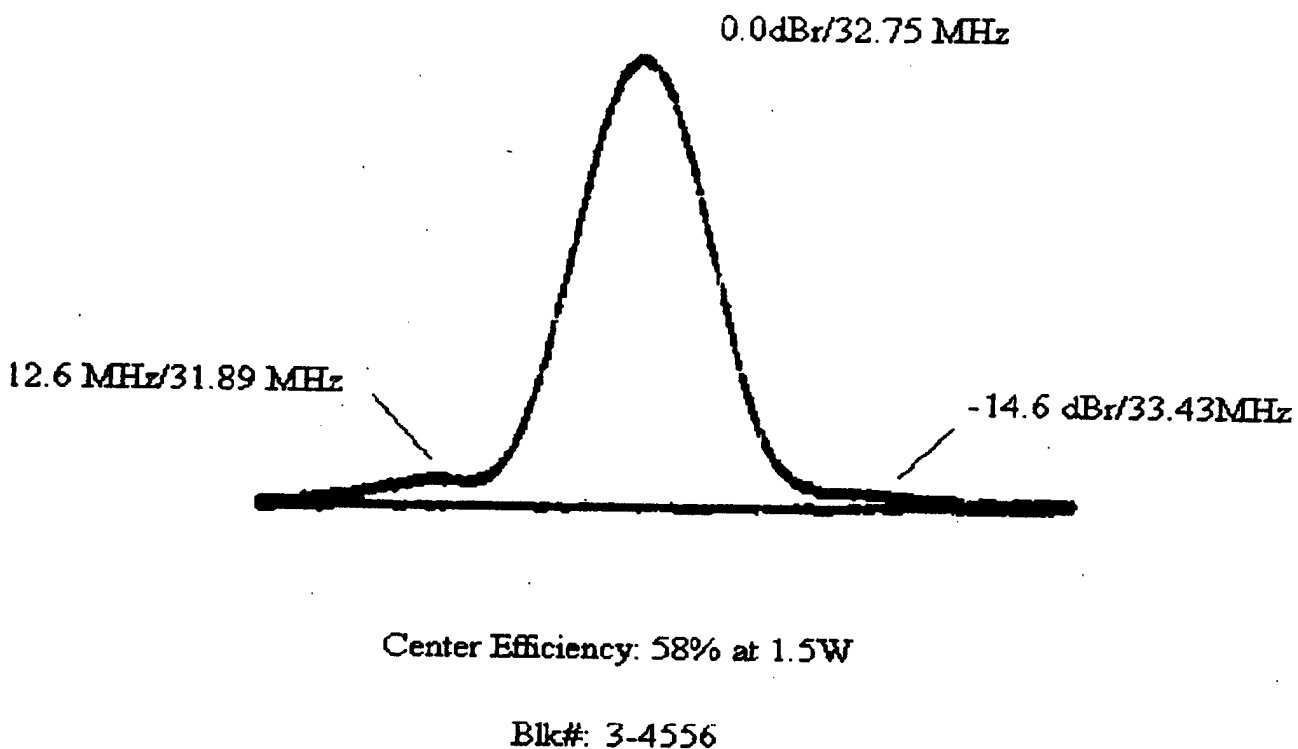

Fig. 2.2. The transmission curve of the AOTF at 1.55 μm .

2.2. Liquid Crystal Variable Retarder

SpectroImager II incorporates a variable liquid crystal retarder (LCVR) for polarization control. The properties of the LCVR are summarized in Table 2.2. It can provide up to a full wave of retardation over our target range of 900 ~ 1700 nm. The tuning is electronic and software driven. The only major limitation is its relatively slow response time. It is slowest when the electric field that aligns the nematic liquid crystal is removed, requiring about 20 msec for complete settling.

Figure 2.3 shows the retardance of the LCVR at 1064 nm as a function of the applied voltage. (Actually, a voltage with alternating polarity [2 kHz] is used in order to avoid depolarization of the liquid crystal.) The maximum retardation is about 1800 nm and thus can provide a full wave of retardation for the maximum wavelength of 1700 nm.

The LCVR gives a small residual retardance of ~70 nm even at the maximum applied voltage. This amounts to 0.07 in wave at 1000 nm. The effect of this small retardance on the light intensity measured by the imaging system is usually very small. For example, when an incident light to the LCVR is linearly polarized, a retardation of 0.07 in wave causes a rotation of 13° in the polarization plane. This rotation, however, results in loss of intensity of only 2.5% for the ray filtered by the AOTF (analyzer). If necessary, this residual retardance can be removed by adding a compensator plate. However, this will slightly reduce the light throughput.

We selected the manufacturer's standard antireflection coating range of 900 ~ 1250 nm in order to insure timely delivery of the device. We tested the throughput of the device for the range of 920 ~ 1700 nm and compared it with another device with an AR coating for the range of 650 ~ 950 nm. The results are summarized in Table 2.3. The selected device gives satisfactory results. Note that the throughput is partially limited by the aperture of the device.

Table 2.2. Properties: Liquid crystal variable retarder (Meadowlark Optics, Frederick, CO).

Retarder Material:	Nematic liquid crystal
Substrate Material:	Optical quality synthetic fused silica
Optimal AR Coating Range:	900 ~ 1250 nm
Retardance Range:	70 ~ 1800 nm
Retardance Uniformity:	2 % rms variation over clear aperture
Beam Deviation:	2 arc min.
Reflectance:	0.5 % per surface
Temperature Range:	10 ~ 50° C
Typical Response Time:	4 ~ 22 msec

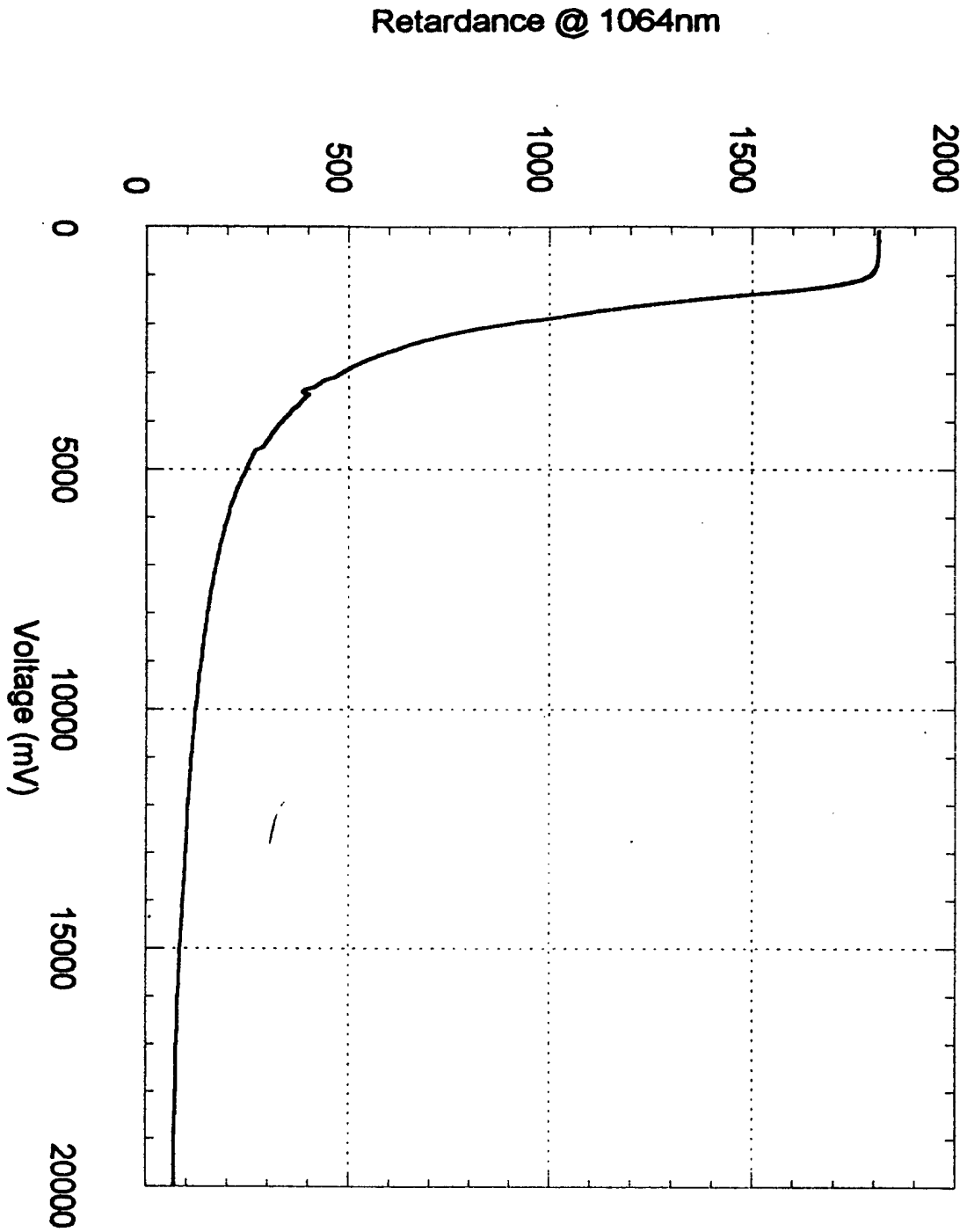

Fig. 2.3. The tuning curve for the liquid crystal variable retarder (Meadowlark Optics). Retardance is shown in nm.

Table 2.3. Throughput of the LCVR. The device that is optimized for 900 ~ 1250 nm gives better results than the one optimized for 650 ~ 950 nm and is satisfactory for the entire spectrum range of interest.

Wavelength (nm)	Retarder Spectrum Range (AR Coating Range)	
	900 ~ 1250 nm	650 ~ 950 nm
920	.83	.81
940	.84	.79
1000	.84	.77
1200	.81	.72
1300	.81	.67
1400	.78	.60
1600	.79	.53
1700	.78	.49

2.3. InGaAs Focal Plane Array Camera

SpectroImager II's camera system is an area scan camera based on a 320 x 240 pixel InGaAs focal plane array. A PCI bus based frame grabber converts its 12 bit digital video output (or RS170 analog output) into a frame. The camera operates at ambient temperature and has a range of 900 ~ 1700 nm. The manufacturer's specifications are summarized in Table 2.4.

The manufacturer of the camera (Sensors Unlimited, Inc., NJ) experienced a problem in reliable production of the InGaAs array. Figure 2.4 shows an image of a heated soldering iron taken with this camera. Radiation from the heated element is clearly seen. The image contains isolated bright spots. These are defective pixels with a very shallow well.

Figure 2.5 shows an image of a resolution chart taken by the SU320 InGaAs camera. The resolution chart was illuminated by an incandescent lamp and placed at a distance of 2.3 m. The focal length of the camera lens is 135 mm. The resolution is about 1 mm and corresponds to ~0.4 mrad. At the camera's focal plane, this translates into ~50 μm . This indicated that the image resolution is limited by the pixel size of the array (40 μm) as designed.

Table 2.4. Specifications: NIR Area Camera

FPA Type:	InGaAs photodiode array
Format:	320 x 240 pixels
Pitch:	40 μm
Optical Fill Factor:	100 %
Spectral Response:	0.9 to 1.7 μm
Quantum Efficiency:	>70 % from 1.0 to 1.6 μm
Mean Detectivity, $D^*(\lambda_{pk})$:	$>10^{12}$ $\text{cm}\sqrt{\text{Hz}/\text{W}}$ ($\lambda_{pk} = 1.5 \mu\text{m}$, 16 msec exposure, no lens)
Uniformity (pixels with $D^* > \frac{1}{2} D^*_{\text{mean}}$):	98 %
Full Well Capacity:	$>10^7$ electrons
Digitization:	12 bit
Electronic Readout Noise:	< 2000 equivalent photoelectrons
Pixel Rate:	6.1 MHz
FPA Temperature:	18° C
Video Output:	12 bit digital and RS170
Frame Rate:	30 Hz (RS170)

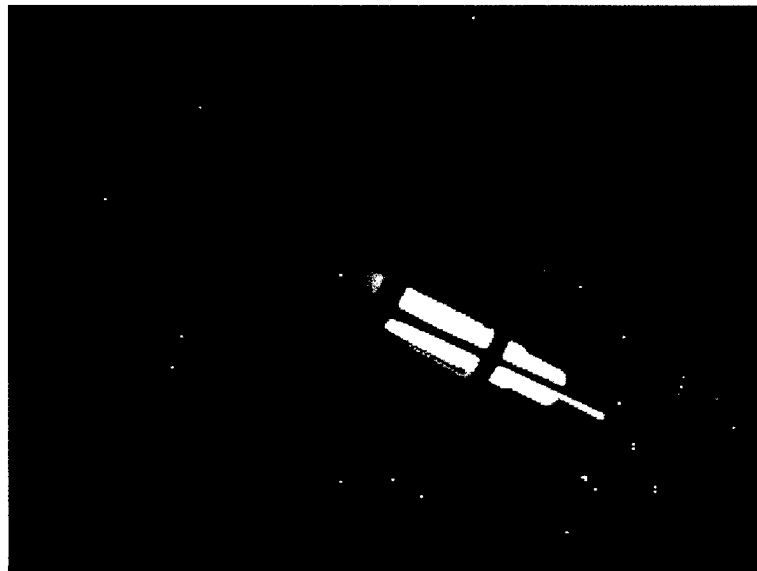

Fig. 2.4. An image of a heated soldering iron taken by the SU320-1.7 InGaAs camera. Isolated bright spots are defective pixels.

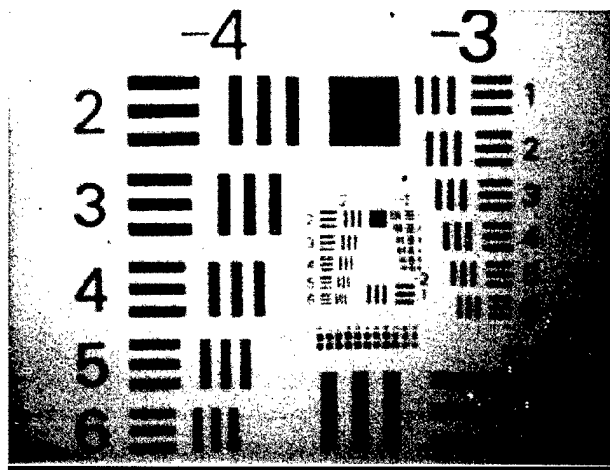

Fig. 2.5. A resolution chart placed at a distance of 2.3 m from the camera and illuminated by an incandescent lamp.

2.4. Lens Optics

The lens system was initially constructed from commercially available camera lenses in order to avoid high cost of custom lenses. This approach was quite successful in our previous efforts in the $0.5 \sim 1 \mu\text{m}$ range.^{1,2} However, the commercial lenses that are optimized for the visible ranges turned out to be more problematic in the short wave infrared range of $1 \sim 1.7 \mu\text{m}$. In this section, we will describe the design principles and the original design that is based on commercial camera lenses. We will describe the final optics design in the following section.

The lens configuration of SpectroImager II is illustrated in Fig. 2.6. The front optics consists of two lenses and a slit. The front lens is a motorized zoom lens of $8 \sim 80 \text{ mm}$ focal length and $f/1.2$. The image at the focal plane of this lens is limited to about 4° by a slit so that the filtered and unfiltered light will not overlap in the final image plane of the camera.

¹S. G. Sankar, S. Simizu, C. J. Thong, and R. T. Obermyer, "Non-Cooperative Combat Identification Using Multispectral Imaging," Final Report, AMSEL-NV-TR-205, September 1997, Contract Number: DAAB07-95-C-M042.

²S. Simizu, R. T. Obermyer, C. J. Thong, S. G. Sankar, L. Denes, M. Gottlieb, B. Kaminsky, and M. Hebert, "Spectro-Polarimetric Video Image Processing System," Final Report, March 1998, Contract Number: DAAH01-97-C-R227.

The image at the slit is seen through a collimating lens of 135 mm. The light travels through the retarder and the AOTF and splits into two orders of filtered light and unfiltered light (see Fig. 2.6). The camera's axis is aligned so that only the selected filtered ray falls on the imaging array. The separation angle between the filtered ray and the unfiltered ray is 4.2° . This is also the basic limit for the field of view of the imaging system. The focal length of the camera lens is set at 135 mm so that this angle will match with the array size of 9.6 mm. This restriction only applies to the direction to which the ray is diffracted by the AOTF (vertical, in our design).

The arrangement of Fig. 2.6 allows flexibility in the optics design to suit particular applications within the basic limitations of the AOTF-based system. The standard configuration described above is designed for observation of objects at a distance between 1.5 m and infinity. By using a zoom lens with the minimum focal length of 8 mm, the field of view can be extended to 61° . However, the image quality suffers considerably because the AOTF introduces a fixed amount of blur when measured by the number of imaging pixels (about 3). This amounts to 0.76° when the front lens is zoomed out to 8 mm. This tradeoff of the image quality and the field-of-view is summarized in Table 2.5. The zoom lens is motorized for ease of operation. The front zoom lens may be replaced by a macro zoom lens if close up operation is needed.

The optics and the camera are housed in an environmental camera enclosure (EH5729, Pelco, Clovis, CA). Its outside dimensions are 8.6" w x 6.2" h x 29" l. We removed the front glass of the enclosure because it cuts off the light throughput significantly. The camera's mounting rail was split into two parts. The front rail holds all the optical components except for the camera and its lens. The camera is mounted on the rear rail that is designed to rotate freely about the axis at the center of the AOTF. With this arrangement, the camera position can be easily aligned with the filtered ray that is separated from the unfiltered ray by only 4.2° . The adjustment is made using a set-screw against a spring loaded lock.

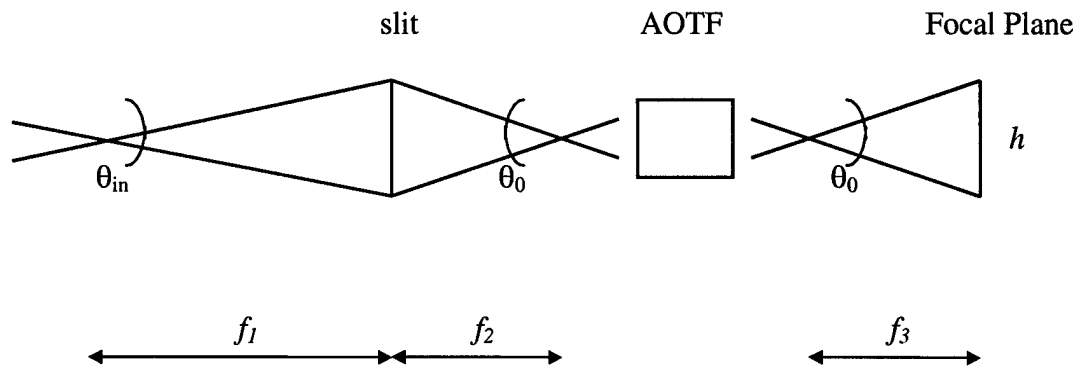

f_1	f_2	f_3
8 ~ 80 mm	135 mm	135 mm

Fig. 2.6 Lens configuration of the AOTF camera system.

Design constraints:

AOTF deflection angle (θ_0):	73 mrad (4.2°)
AOTF blur (θ_b):	~1 mrad (0.057°)
Focal Plane Array (320 x 240 pixels):	$w = 12.8$ mm $h = 9.6$ mm
Pixel size:	$s = 40$ μ m

Design equations:

$h/2 = f_3 \tan (\theta_0/2)$	$f_3 = 130$ mm
$\Delta f = \Delta f_3 + (f_3/f_2) (\Delta f_1 + \Delta f_2)$ (focal length shift)	f_3/f_2 must be small $f_2 = 130$ mm
$f_1 \tan (\theta_{in}/2) = f_2 \tan (\theta_0/2)$	f_1/f_2 dictates θ_{in} (field-of-view)
$\Delta\theta_{res} = (f_2/f_1)\theta_b$ $= (f_2/f_1)(s/f_3)$	AOTF induced blur pixel size limited resolution

Fig. 2.7. Basic optics design relationship. The deflection angle (4.2°) of the AOTF and the array size of the camera determine the focal length of the camera lens. Other lenses are selected based on the needs in the application. In the actual implementation, lenses with $f_2 = f_3 = 135$ mm were selected.

Table 2.5 Field-of-view vs. blur tradeoff ($f_2, f_3 = 135$ mm)

θ_{in} (field-of-view)	f_1	Image blur
62°	8 mm	1.0° (17 mrad)
44°	12 mm	0.65° (11 mrad)
18°	30 mm	0.26° (4.5 mrad)
9.2°	60 mm	0.13° (2.3 mrad)
6.9°	80 mm	0.10° (1.7 mrad)
4.6°	120 mm	0.064° (1.1 mrad)

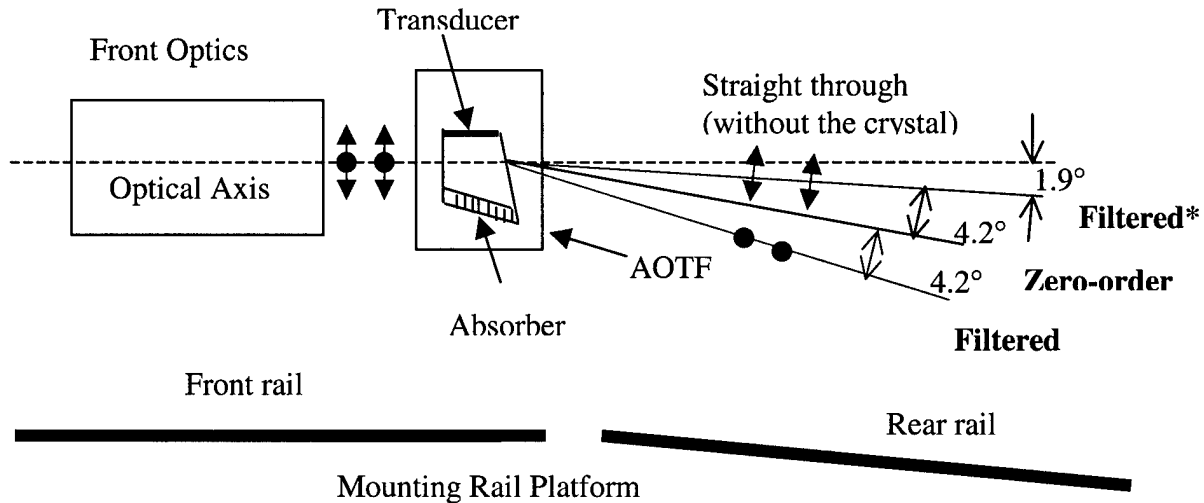
Side View (Not to scale)

*Desired diffracted ray, to be captured by the camera.

Fig. 2.8 Mounting of the optical components. The rear rail that holds the camera rotates about the center of the AOTF so that the camera can be aligned with the desired filtered ray. Note that the AOTF serves as a polarization analyzer. As the horizontally polarized (ordinary) ray passes through the AOTF, it is converted to vertically polarized (extraordinary) ray, which is spatially separated from the unfiltered ray and the horizontally polarized (ordinary) ray as shown.

2.5. Improved Lens Optics

The optics described in the previous section turned out to be problematic in the $1 \sim 1.7 \mu\text{m}$ range. There are basically two problems: chromatic aberrations and reflections from the lens surface. The chromatic aberrations cause loss of focus when the filtering wavelength is changed. Excessive reflections result in not only lower light throughput but also stray light that interferes with the filtered light. In this section, we will summarize our findings and actions taken to complete this work.

Two main problems we found with the initial version of the optics are:

- 1) Systematic “glare” problem in the form of half-ring that was consistently present in the images with the intensity of the same order of magnitude. This is seen in Fig. 3.1.

- 2) The imager can not maintain the focus during the computer-controlled scans in the design wavelength range of 0.9 ~ 1.7 μm .

Moreover, the anti-reflection coatings on the lenses do not work in the SWIR range, thus considerably decreasing the optical system throughput and overall image quality. The light throughput goes down to 70 % at 1.7 μm per camera lens. The combined effect for the three lenses is a 34 % throughput. We recognized these as potential problems at the design stage but were unable to quantify the degree of the difficulty because the detailed optical design parameters were unavailable.

Chromatic aberrations and/or reflection problems can be decreased by three ways:

- a) using off-the-shelf optical components with a proper combination;
- b) using camera lenses designed for the SWIR;
- c) using custom designed and manufactured optical components according to our specifications.

We explored all three approaches with the results presented below.

a) Off-the-shelf doubles and negative elements

We modeled optical system using OSLO Light v.5.1 optical design software in order to explore for the proper combination of off-the-shelf lenses. We first analyzed a typical doublet (Melles Griot 01LAO139, achromatic doublet, diameter 30 mm, focal length (f): 140 mm). This lens is optimized for the visible range and its shift in the focal length is similar to that of camera lenses.

As can be seen in Fig. 2.9a, the relative chromatic shift in the visible range ($\Delta f/f$) for this corrected lens amounts to only 0.15%. However, changing the working wavelength range to 0.9 ~ 1.7 μm , the chromatic focal shift increases to 1.8 % as shown in Fig. 2.9b. This is more or less a common characteristic of any lenses that are designed for the visible range.

One possible choice for the lens is an LAI series from Melles Griot. These are glass doublet lenses and available for 10 ~ 190 mm focal length with $F/2.0 \sim 3.8$. (Example: 06LAI009, diameter 25 mm, $f = 80$ mm). These doublets are used for laser diode manipulation. Their operation between 780 nm and 1550 nm is diffraction limited. Special antireflection coatings with less than 0.25% reflectance are available for 1300 nm and 1550 nm bands. Spherical aberration, coma, astigmatism, and sphero-chromatism have been well corrected. However, pure chromatic aberration has been left uncorrected. The chromatic focal shift for 06LAI009 lens in the range 0.9 ~ 1.7 μm is shown at Figure 2.10, which indicates the value of $\Delta f/f \approx 1.5\%$.

We examined how this chromatic shift may be reduced by introducing a negative lens element. We tried to correct chromatic aberrations by inserting a negative lens after the

positive doublet in a way that the effective focal length (EFL) for the system of two lenses would be 130 mm, which is the requirement for the camera lenses. One of the possible choices is 018-0180 lens (diameter 25 mm, $f = -150$ mm). The chromatic focal shift for such combination is shown in Figure 2.11. It brings the value of chromatic focal shift to 1.4%. Combination of the same positive lens with several others negative lenses like 01LQS007, 012-0170, 015-0230, NSPC025, NSBC025 effectively gives nearly the same value of chromatic focal shift. Thus this method is not effective to achieve necessary correction in the range of $.9 \sim 1.7 \mu\text{m}$.

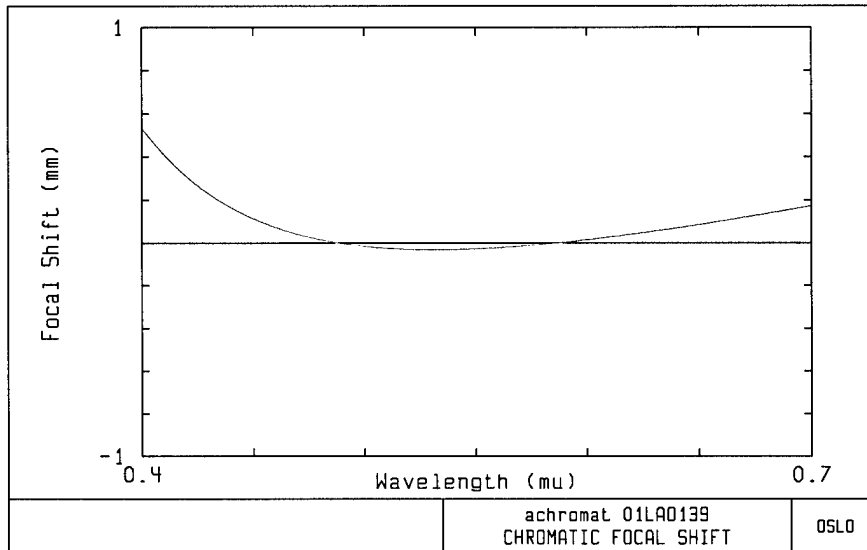

(a)

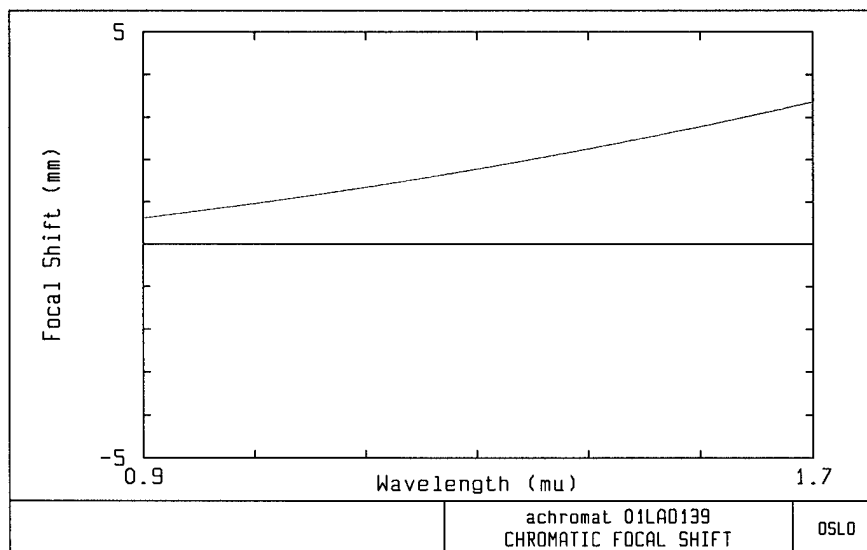

(b)

Fig. 2.9 Chromatic focal shift for Melles Griot achromat doublet 01LA0139 lens in the range of (a) $0.4 \sim 0.7 \mu\text{m}$ and (b) $0.9 \sim 1.7 \mu\text{m}$. (Note the different vertical scale.)

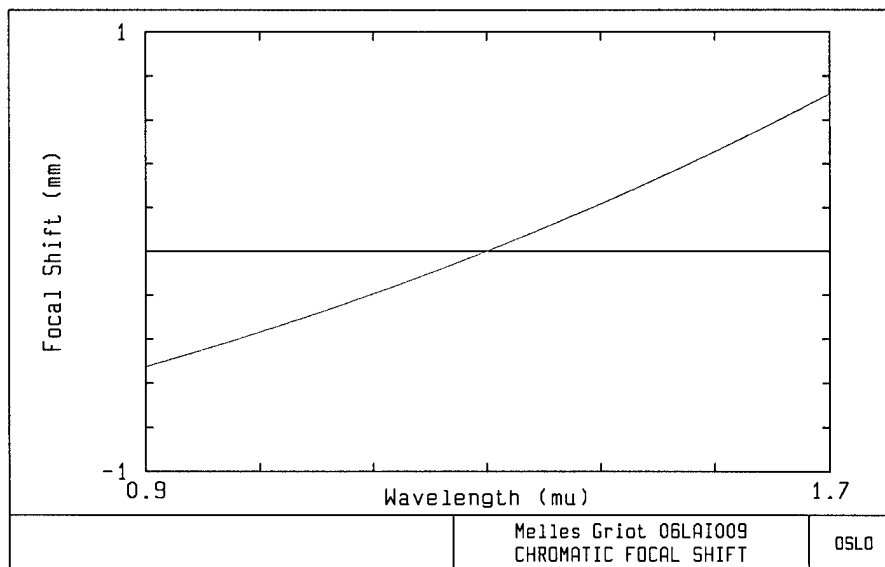

Fig. 2.10 Chromatic focal shift for Melles Griot 06LAI009 lens.

b) Search for chromatically corrected off-the-shelf lenses.

We explored the information database available to us looking for lenses with chromatically corrected aberrations in the desired wavelength range. The only lens that nearly satisfy our requirements is lens 9821 being manufactured by Italian company Optec and being sold in USA by Richter Enterprises. It is chromatically corrected in the 0.9 ~ 1.7 μm range and has focal length of 100 mm with F/1.4. The diameter of the lens is 120 mm and its physical length is 145 mm. The current list price is \$5,295. Using three of these lenses, the cost of the lens system will be \$16,000. Aside from its high cost, this lens is still not ideal for the present application. The focal length is about 30 % too short for the ideal match with the imaging array and the lens diameter is unnecessarily large. (The optical aperture of the AOTF limits the useful F-number to about 6.) Such large and long lenses will not fit into the current camera enclosure. Its incorporation will require re-designing of the optical train and the enclosure.

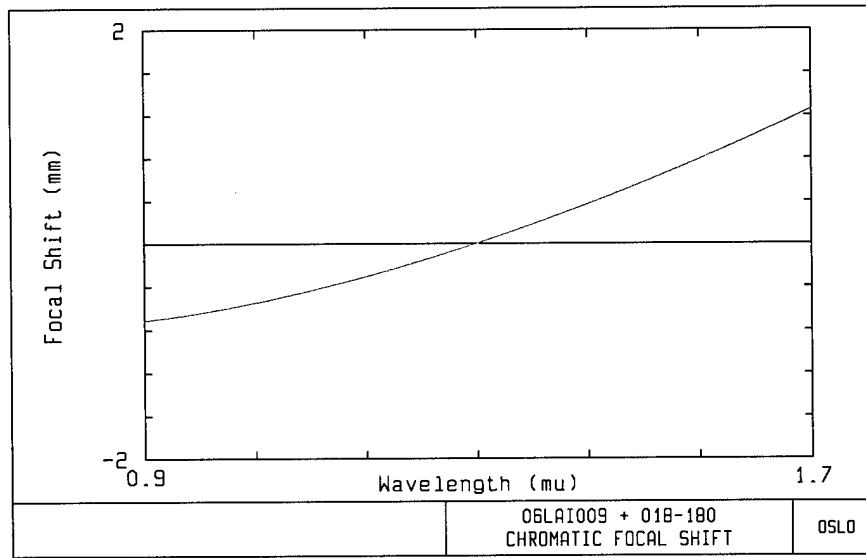

Fig. 2.11. Chromatic focal shift for combination of 06LAI009 and 018-0180 lenses.

c) Custom design and manufacturing of lenses.

We studied the possibility of custom design and manufacturing of chromatically corrected lenses according to our specifications. We contacted several companies and received feedback regarding availability and estimated costs. We asked for glass doublet with focal length of 135 mm, diameter 30 mm, chromatically corrected in the range of 0.9 ~ 1.7 μm . Several companies indicated that such design and manufacturing is available. Optimax Systems, Inc., Ontario, NY (tel. 716-265-1020) and optical designer Chris Cotton (tel. 716-624-4233) estimated the job at about \$1,200 per doublet. Design and delivery time is about 5 weeks. Kreischer Optics, Ltd (McHenry, IL, tel. 815-344-4220) quoted the job as \$790 per doublet with 8-week delivery. The latter company also sent to us some preliminary specifications showing that the chromatic focal shift for such a doublet as 0.9%, which may be considered to be relatively good (but less than optimal).

Table 2.6 summarizes possible methods of chromatic aberration correction along with estimated values of chromatic focal shift per component and the costs. Use of the off-the-shelf lens doublet for SWIR offers only a slight improvement for the chromatic aberration. However, its use increases the throughput of the whole optical system significantly because it can be AR coated for the desired range. This is advantageous in improving the light throughput and reducing the background. The use of the SWIR camera lens is very expensive; its size and focal length is not an ideal match with the present design. The custom designed doublet may be a reasonable choice if a fund is available for its implementation. This method should significantly reduce the chromatic aberrations and increase throughput of the system.

Table 2.6 Methods of Chromatic Aberration Correction

Method	Chromatic focal shift per lens	Estimated material cost
Regular camera lenses (visible)	~2.3 %	\$500 (fixed focal lenses)
Off-the-shelf doublet for SWIR (NOT chromatically corrected)	1.5 %	\$600
Correction by negative elements (for the above lens)	1.4 %	\$900 – 1100
Custom designed and manufactured doublets	0.9 %	\$2,500
SWIR corrected camera lens	0.2 %	\$16,000

In completing the present contract, under the approval from ARL, we implemented the option to use the catalogue lens (doublet) which is AR coated for 1.3 μm . The final parameters are listed in Table 2.7.

Table 2.7. The lenses used for the SpectroImager II. All the lenses are Melles Griot LAI series glass doublet AR coated for 1300 nm.

Lens	Front	Collimating	Camera
Focal length	145 mm	100 mm	145 mm
Diameter	40 mm	30 mm	40 mm

2.6. Electronic Control System

A schematic diagram in Fig. 2.12 shows the basic electronic control flow. The AOTF controller that is proprietary to AMC consists of a 12-bit D/A converter, four voltage controlled oscillators (VCOs), a mixer, a 3-bit programmable attenuator, and a one-watt wide band power amplifier. The four VCOs cover the frequency range of 25 ~ 100 MHz. Because each VCO is controlled independently, multiple spectral bands may be generated by turning on several VCOs, simultaneously.

The LCVR is controlled by a 2 kHz square wave. Its retardance changes as a function of the amplitude of the square wave. The amplitude is set using a 16-bit D/A converter. A custom built circuitry converts this dc voltage into a 2 kHz square wave.

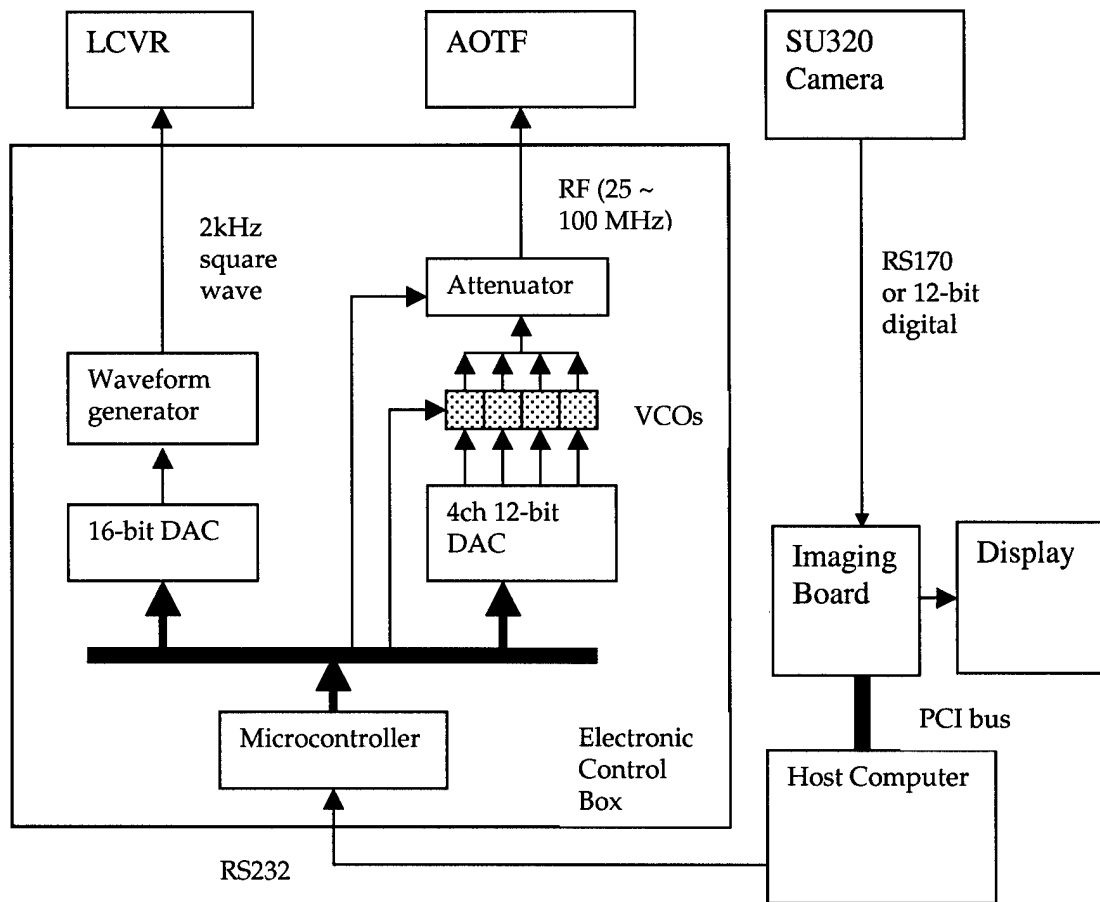

Fig. 2.12. Schematic diagram of computer control of SpectroImager II. The AOTF and LCVR controls are integrated into a single Electronic Control Box, which is connected to the host computer through a standard serial interface (RS232).

Both electronic controllers are integrated into the Electronic Control Box, which is in turn connected to the host computer through the serial interface (RS232). In an earlier version of the system, these drivers were each controlled from a dedicated digital I/O card. This means that the host computer must have two expansion slots and two separate parallel cables must run between the computer and the control boxes. The integrated control box with a standard serial interface simplifies the system installation. It also opens up a way for mobile applications.

We selected Matrox Corona PCI board for the frame grabber (Corona, Matrox Electronic Systems, Dorval, Quebec, Canada). This board accepts both analog and digital (up to 24 bits of RS-422) video inputs. A true color (24 bits) display output is integrated on the board and can serve as the host computer's VGA display adapter. Thus the system can be operated with a single monitor with all the color capability of the imaging software. With the 4 MB video memory, the maximum display resolution is 800 x 600 pixels for 24 bit true color display and 1600 x 1200 pixels for 8-bit (256) color display.

The host computer is a Dell Dimension V400 (Dell Computer Co., Austin, TX), which is based on the 400 MHz Pentium II processor. It has 64 MB of SDRAM and is equipped with Base 10/100 Ethernet controller for network connection. In addition to a 3.5", 1.44 MB floppy disk drive, the computer has an internal 100 MB Zip drive and a 8.4 GB hard disk drive. The monitor's size 17" nominal (16" viewable) with .26 dpi resolution. The operating system is Windows NT 4.0.

2.6. Control and Imaging Software

SPIImager software is the main tool for control and data acquisition using the SpectroImager. This software allows easy access to the basic control parameters (filter wavelength, acoustic power level, sensitivity, retardance, etc.). Each control is based on standard Windows graphic user interface. In addition, SPIImager provides convenient methods for acquiring spectral and polarimetric data as well as for saving and inspecting image files. Several real time image processing methods are also implemented.

The software was developed under Windows NT 4.0 using Borland C++ 5.02 and Matrox Imaging Library 5.12. The software previously developed under a 16-bit Windows environment was upgraded to 32 bit codes.

Several new features were added to the system control software. They include:

- 1) background subtraction
- 2) automatic and manual contrast control
- 3) frame integration (accumulate)
- 4) opening and editing of inspection windows
- 5) real time inspection of each pixel value
- 6) improved user interface for automatic scanning

The background image is taken with the AOTF turned off. This image is then stored in memory and subtracted (pixel-by-pixel) from each acquired image. This feature is very useful in enhancing the performance of the camera because the effect from stray light and variation in the dark current can be eliminated. (See Section 3 for examples.)

The image can be further enhanced in real time by increasing the contrast. This is simply a multiplication of a constant factor to each pixel of the image. The multiplicative factor may be set manually or determined automatically by scanning through the image data for the maximum pixel value prior to the multiplication operation.

The wavelength may be scanned automatically for the user selected range and step. The scan is synchronized with the image acquisition so that the spectral data may be easily acquired. The scan may be either in a constant wavelength or wavenumber step. A similar scan may also be performed for retardation at a fixed wavelength.

The user can open a rectangular inspection window for which the system reports the average pixel value. A mouse is used for specifying the position and the size of the inspection window. Up to seven windows may be opened simultaneously.

During the automatic scan of the wavelength, the system calculates the average pixel value for all the inspection windows. The results are saved in a text format file and displayed graphically. The rectangle that shows the window is in color and is matched with the color of the line that graphically shows the spectral results. The data, however, are not corrected for throughput of the AOTF and other components, sensitivity of the camera, or the spectral variation of the light source. Such a conversion is straightforward if a standard reflector is in the same view. The user can open an inspection window for that reflector together with windows for the objects of interest. All the obtained curves can be scaled by the reference curve.

More details on the software functions and operation instructions are found in the attached Technical Manual.

3. Test Results

3.1. Spatial Resolution

Figure 3.1 shows images of a resolution chart taken by SpectroImager II with the original optics system that was constructed from off-the-shelf camera lenses. The chart was placed at 1.8 m away from the camera's front lens. It was illuminated by an incandescent lamp. The image (a) was taken at 1200 nm. The image suffers from stray light in a ring shape. This is caused by the scattering of light in the lenses of the front optics. It disappears when the aperture of the front zoom lens is narrowed. However, for many cases, the iris of the zoom lens must be opened fully in order to collect sufficient amount of light.

Most of the stray light was eliminated when the camera lenses were replaced by doublets that are AR-coated for 1.3 μm . The result is shown in Fig. 3.2a. The image resolution is enhanced further by numerically subtracting the background contribution and increasing the contrast. This image processing can be applied in real time as shown in Fig. 3.2b.

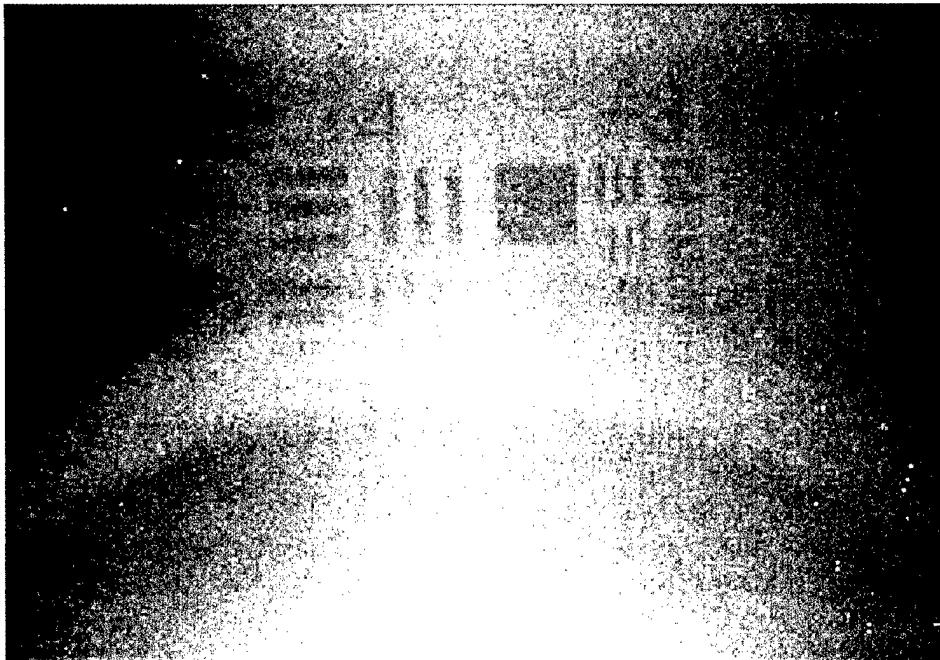
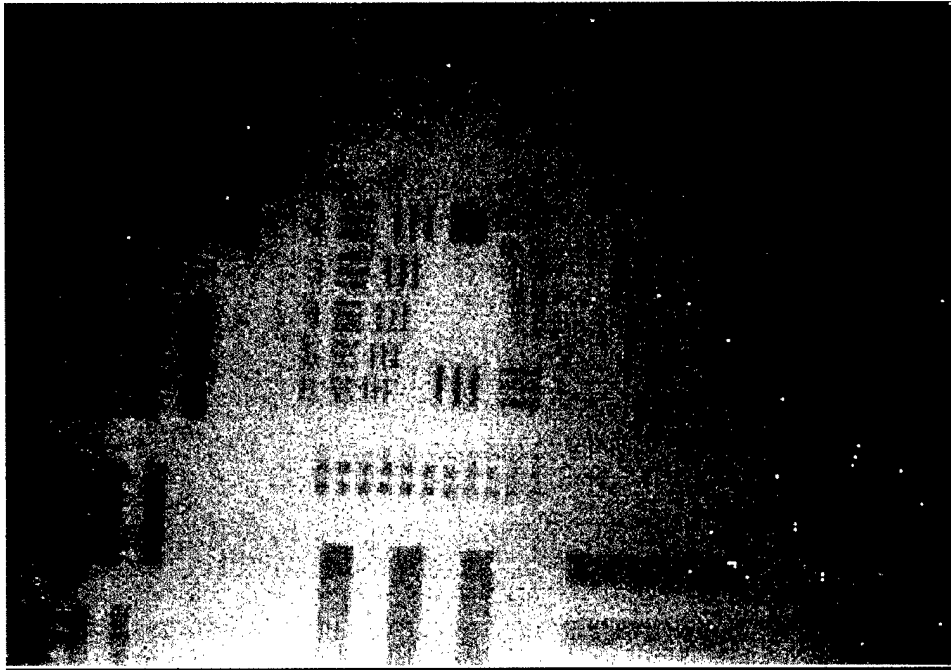
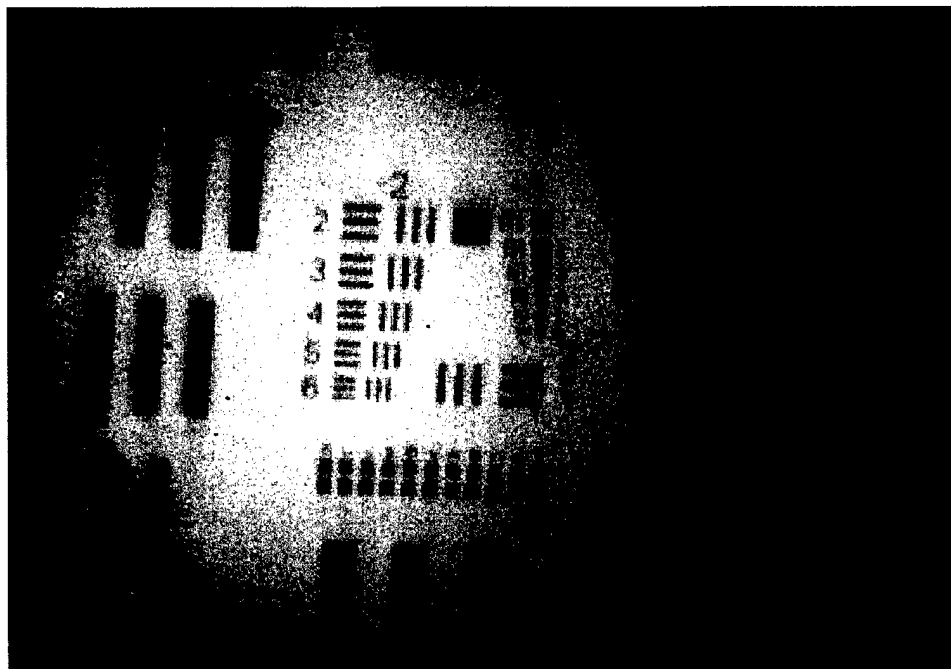

Fig. 3.1 An image of an illuminated resolution chart at a distance of 1.8 m taken at 1200 nm with the original optics. A ring shaped glare and smearing from the unfiltered image are problematic.



(a)



(b)

Fig. 3.2 Images of a resolution chart at a distance of 2.2 m taken at 1200 nm with the improved optics. The glare is much reduced. (a) Raw image (b) After background subtraction and contrast enhancement.

Close inspection of Fig. 3.2b reveals that there is a significant blur in the vertical direction. In the horizontal direction, the chart can be resolved to $\sim 1/5$ (about 0.8 mm line spacing). However, in the vertical direction the resolution is only to $\sim 2/6$ (about 1.4 mm). This additional blur is introduced by the AOTF and was expected to amount to 1 mrad (see Table 2.5). Because the focal length of the lens on the camera (f_3) is 145 mm, the 1 mrad blur results in a blur of $145 \text{ mm} \times 0.001 = 145 \mu\text{m}$ on the focal plane or 3 ~ 4 pixels. The actual observed blur is $1.4 \text{ mm} / 2.2 \text{ m} \times (f_1/f_2) \times f_3 = 130 \mu\text{m}$ on the image plane as expected. The horizontal blur corresponds to $0.8 \text{ mm} / 2.2 \text{ m} \times (f_1/f_2) \times f_3 = 76 \mu\text{m}$ on the image plane. This is comparable with the pixel size of $40 \mu\text{m}$.

The spatial resolution of the SpectroImager II is summarized in Table 3.1. The result agrees well with the expected resolution from theoretical analysis.

Table 3.1. Image resolution of the SpectroImager II. See Fig. 2.7 for the calculation formula.

Direction	Field-of-view	Resolution	Expected Resolution	No. of Pixels	Pixel Size
Horizontal	61 mrad (3.5°)	0.36 mrad (0.02°)	0.2 mrad (0.01°)	320	40 μm
Vertical	46 mrad (2.6°)	0.64 mrad (0.04°)	0.7 mrad (0.04°)	240	40 μm

3.2. Spectral Performance

In some cases, the spectrally filtered image in the SWIR range gives a dramatic effect because of the strong absorption of light. Figure 3.3 shows an image of three sample bottles taken at 1200 nm with a resolution chart in the background. The leftmost bottle contains water and the middle bottle's content is methanol. Unlike in the visible ranges, they are opaque because both liquids absorb light strongly at this wavelength. Only the rightmost bottle that contains acetone remains transparent.

Figure 3.4 shows an image of sample bottles that contain varieties of liquid in front of a screen that is illuminated from behind by an incandescent lamp. Each bottle is about 10 mm in diameter and placed 1.6 m away from the camera. These images were taken at 1000, 1180, and 1200 nm with the background subtraction and contrast enhancement functions enabled. The liquid samples are from the left, methanol, acetone, water, ethanol, and toluene. Although they are all transparent in the visible range, they show varied degree of absorption in the short wave infrared range. Thus, they appear in various shades that change as a function of the filter wavelength.

The raw intensity data as measured by the camera's InGaAs sensing array are shown in Fig. 3.5 for three samples along with the data for the background screen. The wavelength was scanned automatically from 800 nm to 1800 nm with a 20 nm step. The background intensity falls off rapidly at wavelengths shorter than 950 nm. There is virtually no sensitivity at 900 nm. The cut off is more gradual at the longer wavelength limit. The absolute limit appears to be about 1750 nm. The camera's usable range is thus between 920 ~ 1720 nm. This is in line with the specification of the InGaAs camera manufacturer.

We calculated the absorption factor by taking the ratio of the transmitted light intensity for each liquid sample to that of the background. The results are shown in Fig. 3.6. Water shows first absorption band at ~950 nm. It shows a transmission band at 1000 ~ 1100 nm but remains highly absorbent at 1150 nm and beyond. Acetone is more transparent in the investigated range but shows strong absorption bands at 1160 nm and 1390 nm.

The camera's lens system shows a rather large spectral shift in its focal length. This is because the lenses are not corrected for the chromatic aberrations. It can be focused at any given wavelength but cannot maintain the focus for the entire spectral range. This defocusing may be acceptable as long as the object is large in the view or the switching of the filter band is for a relatively small step. Obviously, this problem needs to be addressed in the next level of development. The necessary steps are already discussed in the previous section.



Fig. 3.3. An image taken at 1200 nm. Three sample bottles contain from the left, water, methanol, and acetone. Only acetone remains transparent at this wavelength.

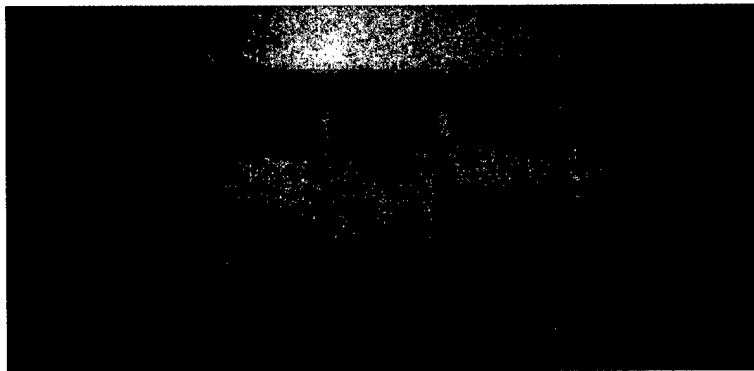

(a) 1000 nm



(b) 1180 nm

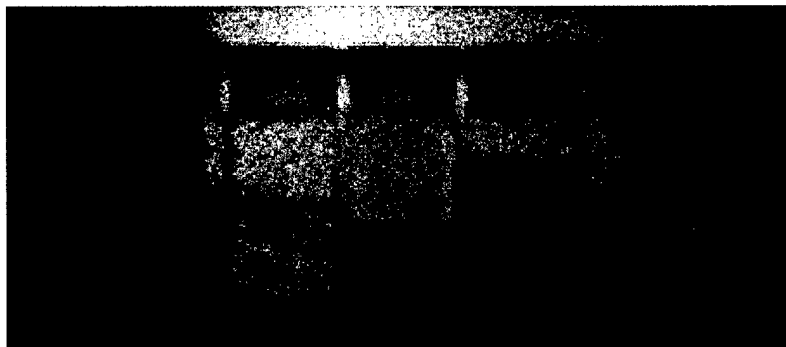

(c) 1200 nm

Fig. 3.4. Bottles containing various solutions: The samples are, from left, methanol, acetone, water, ethanol, and toluene.

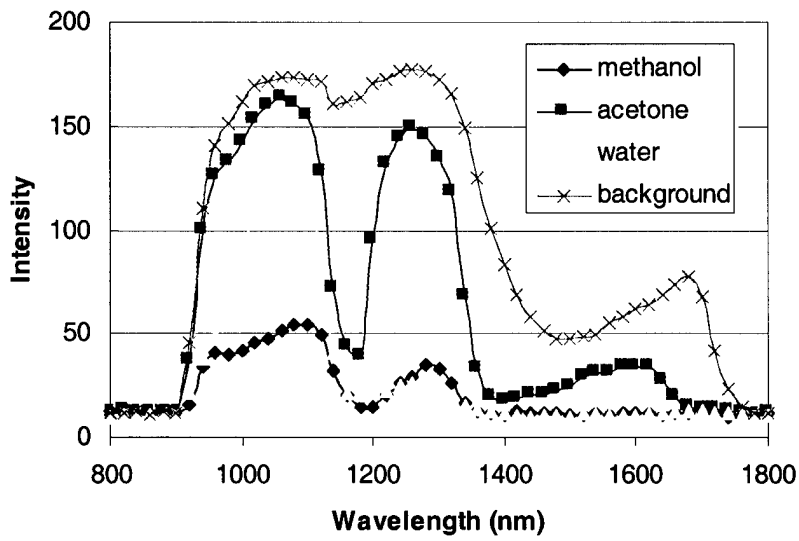

Fig. 3.5. Raw spectral data obtained by SpectroImager II.

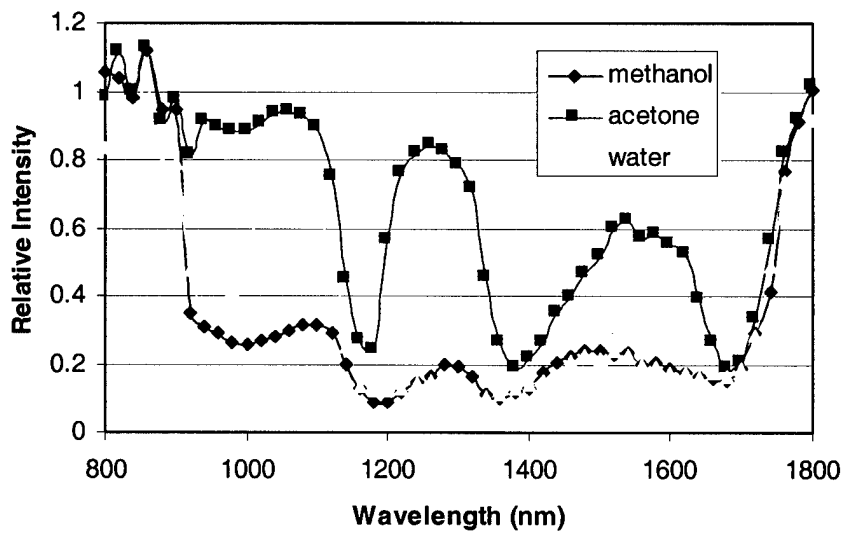
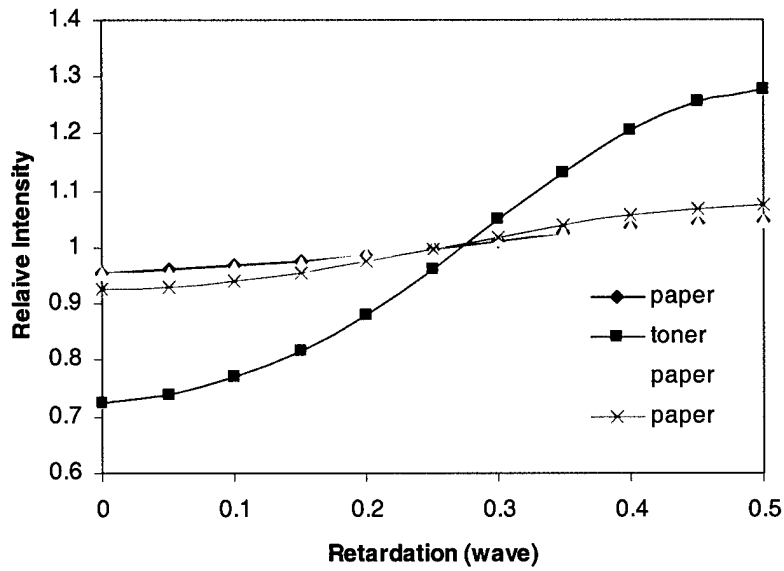

Fig. 3.6 Relative spectral changes for three of the objects in the image of Fig. 3.2.

3.3 Polarization Analysis

We investigated the capability of the polarization analysis by scanning the scene that is illuminated with an oblique angle. Such a light tends to be polarized. Figure 3.7 shows one such example. In the case shown in Figure 3.7a, a xerographic copy of a resolution chart was illuminated by an incandescent lamp with about 45 degree angle with the normal direction of the paper. The camera's axis is also aligned with 45 degree angle so that the camera will capture a light reflected with 90 degree angle from the source. The AOTF was set to 1200 nm. Figure 3.7a shows that the intensity of the reflected increases as the retardation of the light changes from zero to half wave. This indicates that the reflected light is vertically polarized as expected. When the optical phase is retarded by half wave, the direction of polarization rotates by 90 degrees and becomes horizontal. Because the AOTF is designed to serve as a horizontally oriented linear polarizer (see Fig. 2.8), the intensity of the light increases as the direction of polarization rotates to the horizontal direction from the vertical. The figure shows reflections from four different areas. The degree of polarization is high (about 28 %) when the light is reflected by an area cover by toner. In contrast, the degree of polarization is only 5 ~ 8 % for the light reflected by the white paper surface.

When the same scene is illuminated from the top, the retardation scan reveals that the light is polarized horizontally as expected. As shown in Fig. 3.7b, the intensity of light decreases as the direction of polarization rotates because the reflected light is originally horizontally oriented and rotates to the vertical direction as the retardation increases. The degree of polarization is small in this case because the illumination angle is shallow (less than 30 degrees). Still the light reflected from toner is more strongly polarized (9 %) as opposed to the reflection from the white paper surface (2 ~3 %).



(a)

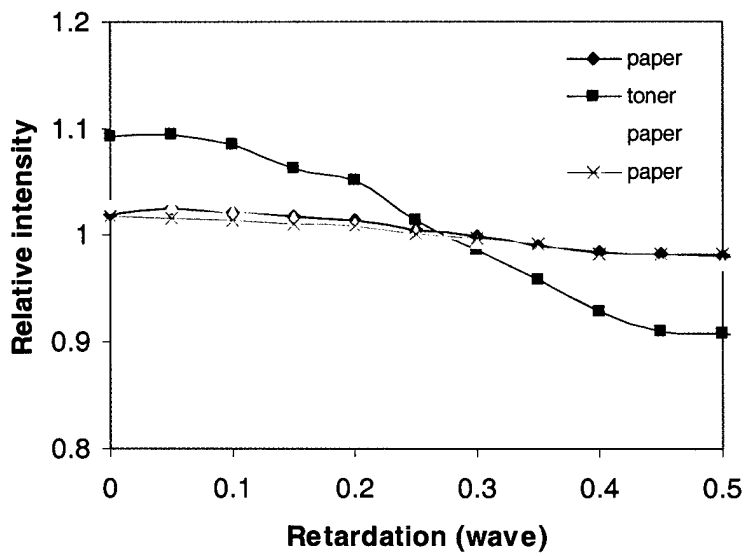

(b)

Fig. 3.7. Analysis of degree of polarization of reflected light at 1200 nm. (a) Scene illuminated from the side; (b) illuminated from the top.

3.4 Outdoor Scenes

We tested SpectroImager II for its ability to capture scenes in natural outdoor scenes. All the data were acquired by setting the camera system in an indoor laboratory, aiming the camera to the outdoor scenes through a regular window glass. Generally, acquisition of images of outdoor scenes is much more difficult because of less amount of light available in the SWIR range and increased absorption due mostly to water vapor. A typical image is shown in Fig. 3.8. This image was taken in a sunny afternoon for houses about 200 m away. They are facing south and their walls are light colored. The image was taken at 1200 nm with an exposure time of 16 msec. While the scene is recognizable, the image is noisy because of the low signal of the filtered light. The signal output consists of three parts: filtered light (actual signal); stray light; and dark current. The breakdown is summarized in Table 3.2a. Adjusting the optical aperture reduces the stray light contribution. However, the noise is actually dominated by the dark current contribution. The system can benefit from a cooled InGaAs array. Enhancement of detectivity of the InGaAs array by cooling has been demonstrated.³ However, such an imaging array is still not available commercially.



Fig. 3.8. An image of houses at a distance of ~200 m. Taken at 1200 nm with an exposure time of 16 msec.

³ Marshall J. Cohen and Gregory H. Olsen, "Room Temperature Camera for NIR Imaging," SPIE 1993 OE/Aerospace Sensing Symposium, Orlando, FL, 20-24 April 1993.

Table 3.2 Breakdown of the sensor output in 12-bit pixel values (4095 maximum). The pixel value is an average over 225 pixels (15 x 15).

- a) Scene: a white wall of a house facing south about 200 m away in a sunny afternoon.
Exposure time: 16 msec.

Aperture	Filtered light at 1200 nm	Stray light	Dark current
Fully open	14	25	776
Half open	14	14	776

- b) Scene: a white sheet of paper on the lab wall at a distance of 5 m. Illuminated by an incandescent lamp about 0.6 m away. Exposure time: 16 msec.

Aperture	Filtered light at 1200 nm	Stray light	Dark current
Fully open	723	1250	837
Half open	679	589	837
¼ open	657	176	837

When an adequate amount of light is available as in the laboratory, the dark current noise is not a serious problem. As shown Table 3.2b, the filter light (signal) gives about 40 % of the output when the aperture is properly adjusted. The dark current noise is about 1 pixel value (or 0.025%) when averaged over 225 pixels. Therefore, the signal fluctuation attributable to dark current is only 0.2 % of the signal. However, when sampled over the entire array, non-uniformity gives rise to a standard deviation of ~40 pixel values for the averaged (dark current) output value. Without correction to this effect, the error will amount to 6 % of the signal. In addition, the stray light contributes to the non-uniformity of the background. For this reason, the background needs to be subtracted pixel-by-pixel for any quantitative analysis.

4. Specifications

SpectroImager II:

Spectral Filtering:	TeO ₂ AOTF
Spectral Range:	900 ~ 1700 nm (limited by the imaging array)
Spectral Resolution:	61 cm ⁻¹
Spectral Band Access Time:	30 µsec
Spatial Resolution (IFOV):	0.6 mrad, vertical (limited by AOTF induced blur) 0.4 mrad, horizontal (pixel resolution)
Field of View:	46 mrad (2.6°), vertical 61 mrad (3.5°), horizontal
Front Optics:	145 mm, F/3.6, AR coated for 1.3 µm (or Motorized zoom lens: 8 ~ 80 mm, f/1.2)
Camera:	InGaAs 320 x 240 pixels 12-bit digital and RS170 output
Retarder:	Variable liquid crystal retarder (see Table II for details) 0.45 ~ 1.8 µm
Camera System Dimensions:	9" x 7" x 32" (tripod mount)
Control Electronics:	
AOTF Control:	25 ~ 100 MHz, 1 Watt (computer controlled frequency and attenuation, up to four simultaneous frequencies)
LCVR Control:	2 kHz square wave, amplitude: 0 ~ 20 V (computer controlled)
Interface:	Serial (RS232)
Frame Grabber:	PCI plug-in card, 4 MB video memory
Digital Interface:	RS422, maximum 24 bits
Analog Inputs:	4 channel RS170 inputs
Control Computer:	Windows NT 4.0, Pentium II 450 MHz
Display Monitor	17" SVGA
Software:	Functions include: Manual control Acquisition of spectrally filtered images Rapid spectral and retardation scan Real time image processing and enhancement

SpectroImager II

TECHNICAL MANUAL

Release Date: March 8, 2000

Advanced Materials Corporation
700 Technology Drive
P. O. Box 2950
Pittsburgh, PA 15230-2950

Phone: (412) 268 5649
Fax No: (412) 268 3300
e-mail: amc@advanced-material.com
web: <http://www.advanced-material.com>

Table of Contents

1. Introduction	3
2. Camera System.....	4
2.1 Components Specifications	5
2.2 Function and Performance Characteristics.....	6
3. Hardware Setup	11
3.1 Physical Connections	11
3.2 Alignment Procedure.....	13
4. System Software.....	17
4.1 Running SPImager	17
4.2 Obtaining Spectrum of an Object using SPImager	22
4.3 Retardation Scan	27
4.4 Calibration Data File	27
Appendix A. Electronic Control Box	29
A1. Communication Interface	29
A2. Frequency Synthesizer Circuit	32
Theory of Operation	32
Circuit Operation.....	32
A3. LCVR Control	38

1. Introduction

This technical manual describes the principles, operation, methods of adjustment and maintenance of the SpectroImager II, a multi-spectral imaging system with polarization control. This system is based on the acousto-optic tunable filter (AOTF) that features high-speed tuning over a wide range of wavelengths, simultaneous discrimination of multiple wavelengths, electronically variable resolution, no moving parts, and computer controlled operation. These features are unattainable with any other competing technology, such as spectrometers, interferometers, interference filters and liquid crystal tunable filters. SpectroImager II is also equipped with a liquid crystal variable retarder (LCVR) in order to control the polarization state of the light. By combining the AOTF and LCVR, the circular and elliptical polarization may be analyzed as well as the linear polarization.

The unmatched versatility in acquisition of complete spectral signatures, together with the use of custom designed advanced image processing functions makes the SpectroImager II a valuable tool in a variety of spectrum-based imaging applications. These applications include but are not limited to:

- Identification of 'friend-or-foe'
- Geological and agricultural survey
- Investigation of biological tissues
- Machine vision and industrial control
- Environmental monitoring
- Security system

The integrated system is designed to be user-friendly, with only simple set up work necessary. Upon delivery of the system, the user is urged to check that all the components and accessories (listed in Sections 2.1 and 2.2) are in place. The user should then read Section 3 for instructions on how to set up the system. All the required software packages are already loaded and are ready to run. Detailed operating instructions are given in Section 4. The design details of the Electronic Control Box are included in Appendix A.

2. Camera System

The camera system consists of a front lens (145 mm, F/3.6), an aperture slit, a collimating lens (100 m, F/3.3), a TeO₂ AOTF, a SW infrared camera with a 145 mm lens (F/3.6), and a liquid crystal variable retarder. Anti-reflection coating is applied to the surfaces of all the optical elements in order to minimize reflection. The control components include the electronic control box, imaging board, and a host computer for data acquisition, processing and display.

Current performance characteristics of the system are:

Spectral range:	900--1700 nm
Spectral resolution:	61 cm ⁻¹
Best spatial resolution:	1.4 mrad @ 1200 nm (at full zoom)
Rate of image capture:	max. 30 fps
Random access time:	30 μsec
Field of view:	3.5° (horizontal), 2.6° (vertical)
Physical dimensions:	7" x 9" x 32"
(optics, AOTF and camera only)	

The spectro-polarimetric imaging system is shown schematically in Fig. 2.1. A visible version of this camera system is equipped with a zoom lens at the front in order to control the field of view. At this point, an appropriate zoom lens is not available for the .9 ~ 1.7 μm range. A slit is placed at the image plane of this front zoom lens so as to limit the size of this image. The collimating optics matches the incoming ray with the aperture of the LCVR and AOTF. The LCVR control the polarization state of the light. The AOTF

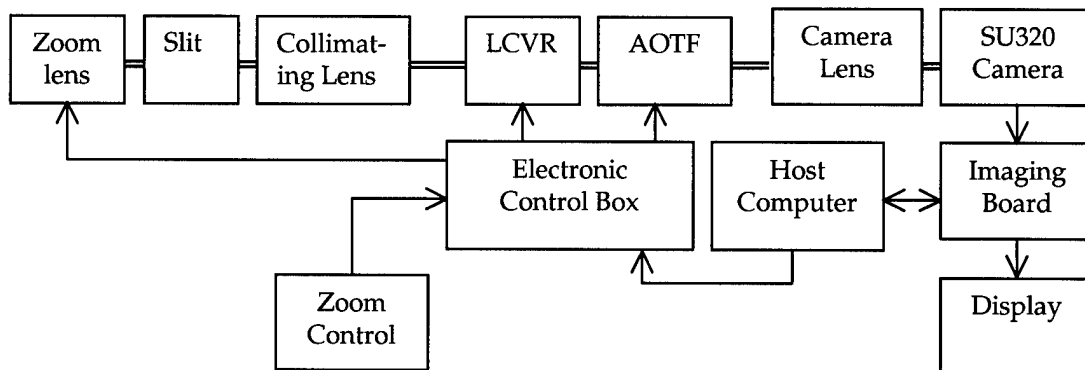

Fig. 2.1. Block diagram of the SpectroImager II camera system. (Zoom lens is for the visible camera only.)

then separates spatially the filtered and unfiltered rays. It also serves as a linear polarization analyzer. The lens that is attached to the camera is aligned to the filtered ray. The focal length of this lens (135 mm) is selected to match the 4.2 ° field of view of the camera with the size (9.6 mm) of the focal plane array of the camera. The imaging board, Electronic Control Box, host computer and the display complete the system. The zoom lens is motorized and can be remotely controlled. Functions and performance of each part are described below.

2.1 Components Specifications

The following components are included in the integrated system:

- An enclosed, tripod-mountable platform on which the following elements are mounted: (1) A 145 mm, F/3.6 AR-coated doublet, (2) An image size defining slit, (3) A 100 mm F/3.3 AR-coated doublet for collimation, (4) LCVR assembly, (5) An AOTF assembly, (6) A 145 mm, F/3.6 AR-coated doublet for the camera, and (7) A SU320-1.7RT SW infrared camera.

(In order to reduce background contributions due to stray light, the original camera lens based optics was replaced by the above components. A part of this manual may refer to a motorized zoom lens. The zoom capability is not currently available.)

- An electronic control box with a front zoom control box and a 12V wall mount power supply. The front zoom control box allows for remote control of the zoom, focus and aperture settings of the motorized front zoom lens. (The motorized zoom lens is available only for the visible range.)
- A Dell Dimension PC, with the imaging board already installed. Software packages required to run the system are also already loaded.
- A computer monitor, a keyboard, and a mouse.
- A power supply for the SU320 camera.
- Assorted cables.

2.2 Function and Performance Characteristics

The function and performance characteristics of the components are described below:

Acousto-Optic Tunable Filter (AOTF)

The AOTF crystal is housed in an aluminum box with windows. The RF drive signal from the Electrical Control Box is to be connected to the SAM connector on the box. The specifications of this filter are summarized in Table 2.1.

Table 2.1. Specifications: Acousto-optic tunable filter (AOTF).

Material	TeO ₂			
Acoustic Mode:	Shear wave			
Acoustic Aperture Size:	15 mm			
Optical Aperture:	15 mm			
Spectral Range:	0.9 ~ 1.8 μm			
Transmission:	95 % at 1.55 μm and 1.5 W			
Resolution:	61 cm^{-1} FWHM (3.9 nm @ 0.8 μm , 19.9 nm @ 1.8 μm)			
Access Time:	30 μsec			
Deflection Angle:	4.2°			
Tuning Relationship:	Wavelength (μm)	Acoustic Frequency (MHz)	Acoustic Power (Watt)	
			100 % transmission	50 % transmission
	0.8	61.2	0.43	0.11
	1.0	49.0	0.68	0.17
	1.8	27.2	2.20	0.55

Liquid Crystal Variable Retarder

This liquid crystal device with a 1" aperture provide a convenient means to control the polarization state of the light. The amount of retardation is controlled by the amplitude of a 2 kHz square wave. This control signal is applied via an SMB connector. The specification of this device is given in Table 2.2. Its tuning relationship is given in Fig. 2.2.

Table 2.2. Properties: Variable liquid crystal variable retarder (Meadowlark Optics, Frederick, CO).

Retarder Material:	Nematic liquid crystal
Substrate Material:	Optical quality synthetic fused silica
Optimal AR Coating Range:	900 ~ 1250 nm
Retardance Range:	70 ~ 1800 nm
Retardance Uniformity:	2 % rms variation over clear aperture
Beam Deviation:	2 arc min.
Reflectance:	0.5 % per surface
Temperature Range:	10 ~ 50° C
Typical Response Time:	4 ~ 22 msec

Electronic Control Box

The control box has three functions: control of the zoom lens, AOTF, and LCVR. The zoom lens control is made manually with three toggle switches that each control zoom, focus, and iris.

The AOTF and LCVR are both digitally controlled through a serial communication interface (RS232). Details of the control commands are described in Appendix A. The provided control software (SPIImager.exe) allows access for all the controls with graphical user interface. They will be described in Section 4. The AOTF control consists of four voltage-controlled oscillators, a mixer, and a 3-bit programmable attenuator. The amplitude and frequency for the AOTF control signal radio frequency is controlled by the input tuning voltage, which is set digitally via a 12-bit D/A converter. The four channels are independently addressable from the host computer. The outputs may be mixed to obtain simultaneous multiple pass-bands.

When the VCO is controlled from the host computer, the VCO control voltage can be set within 3 μ sec with a slew rate of ~ 2 volt/ μ sec. The response time of the AOTF is basically limited by the size of the AOTF crystal and the velocity of the acoustic wave and is typically ~ 20 μ sec (0.015 m \div 700 m/sec).

The liquid crystal variable retarder (LCVR) is controlled by a 2 kHz square wave. Its retardance changes as a function of the amplitude of the square wave. The amplitude is set using a 16-bit D/A converter. A custom built circuitry converts this dc voltage into a 2 kHz square wave.

See Appendix A for a full description of the Electronic Control Box.

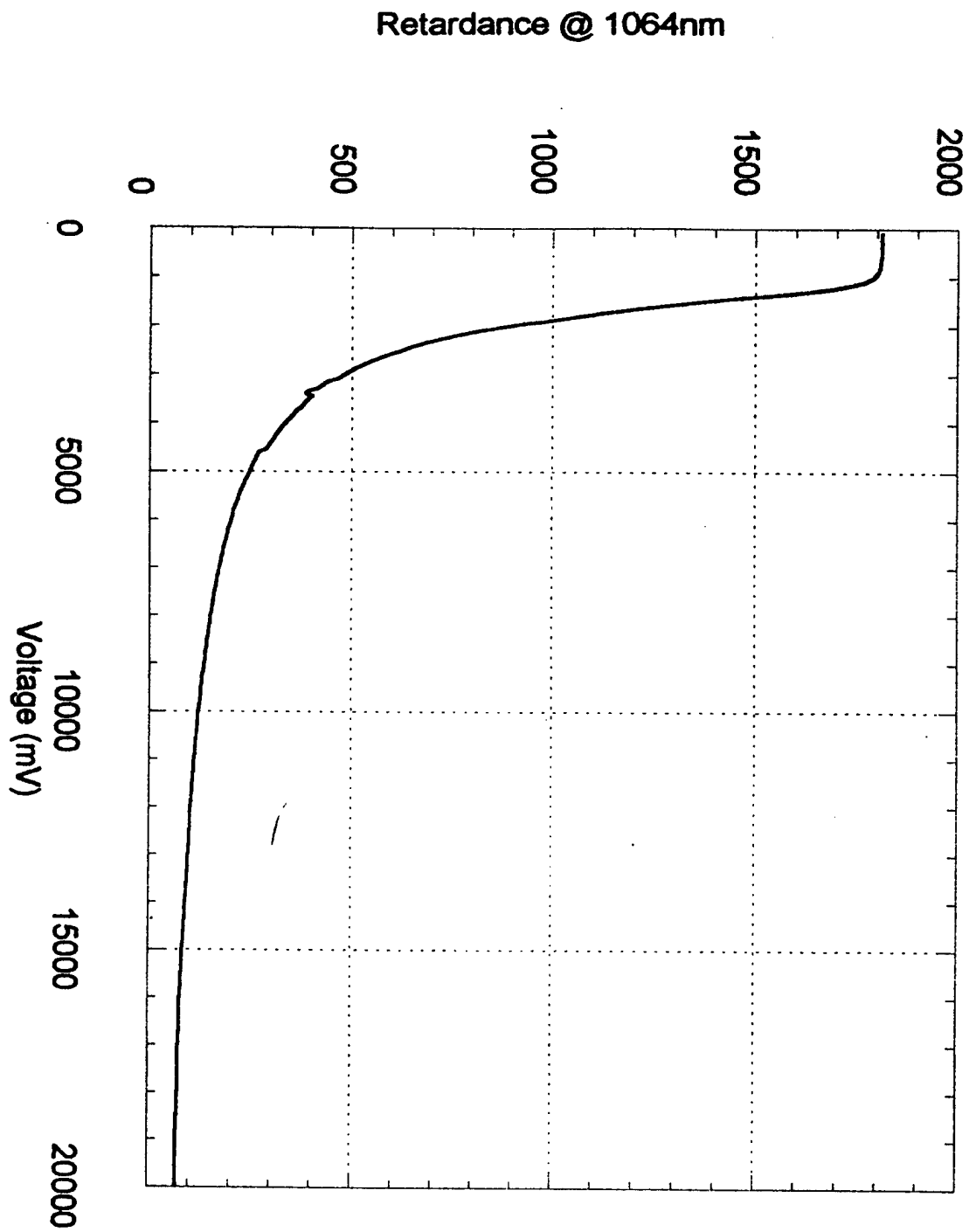

Fig. 2.2 Tuning curve of the liquid crystal variable retarder. See Section 4.4 for the calibration method used by SPImager.

Host Computer

A Dell Dimension, which is based on a 400 MHz Pentium II processor, serves as a host computer for the SpectroImager. Matrox Corona imaging board is installed to the PCI expansion slot in this computer for frame grabbing and image processing. The computer runs under Windows NT ver. 4.0. The data acquisition and imaging software SPImager was developed using Matrox Imaging Library ver. 5.12 and Borland C++ ver. 5.02.

SW Infrared Camera

SpectroImager II's camera system is an area scan camera based on a 320 x 240 pixel InGaAs focal plane array (SU320-1.7RT-D, Sensors Unlimited Inc., Princeton, NJ). The camera has a 12-bit digital video output and an RS170 analog output. The camera operates at ambient temperature and has a range of 900 ~ 1700 nm. The manufacturer's specifications are summarized in Table 2.4.

The array contains several bad pixels. They are noticeable as isolated bright spots against a dark background.

Table 2.4. Specifications: NIR Area Camera

FPA Type:	InGaAs photodiode array
Format:	320 x 240 pixels
Pitch:	40 μm
Optical Fill Factor:	100 %
Spectral Response:	0.9 to 1.7 μm
Quantum Efficiency:	>70 % from 1.0 to 1.6 μm
Mean Detectivity, $D^*(\lambda_{pk})$:	$>10^{12}$ $\text{cm}\sqrt{\text{Hz}/\text{W}}$ ($\lambda_{pk} = 1.5$ μm , 16 msec exposure, no lens)
Uniformity (pixels with $D^* > \frac{1}{2} D^*_{\text{mean}}$):	98 %
Full Well Capacity:	$>10^7$ electrons
Digitization:	12 bit
Electronic Readout Noise:	< 2000 equivalent photoelectrons
Pixel Rate:	6.1 MHz
FPA Temperature:	18° C
Video Output:	12 bit digital and RS170
Frame Rate:	30 Hz (RS170)

Matrox Corona Imaging Board

This PCI color imaging board features versatile interface options including a four-channel analog input and 24 bit RS422 digital interface. Non-standard video format can be accepted by using a proper setup file. The maximum acquisition rate is 45 MHz for analog and 30 MHz for digital input. The board has 4 Mbytes of on-board memory and a VGA display control section. The board serves as the host computer's VGA display adapter. The maximum display resolution the board supports is 800 x 600 at 24 bit true color, 1152 x 864 at 16 bit high color and 1600 x 1200 at 8 bit (256) color.

The default analog input is input 1, which corresponds to the red BNC connector of the supplied cable. The digital interface for the Corona is a separate ISA plug-in card with a high density 70-pin male connector. The provided 80-conductor cable connects to the camera's DB-37 connector.

3. Hardware Setup

This section deals with the layout and the physical connections among the various hardware components of the SpectroImager. Generally, the setup only requires connecting cables. If the optics-AOTF-camera assembly is out of alignment, perform the adjustment by following the step-by-step procedure in Section 3.2.

3.1 Physical Connections

The physical layout and connections among the various components of the Multispectral AOTF Imager system are shown schematically in Fig. 3.1.1.

In addition to power cables and peripheral connections, check for the cables listed in Table 3.1. **Note that the computer monitor is to be connected to the imaging board (Matrox Corona).** Matrox Corona is the computer's VGA display board. The native VGA display adapter on the mother board is disabled.

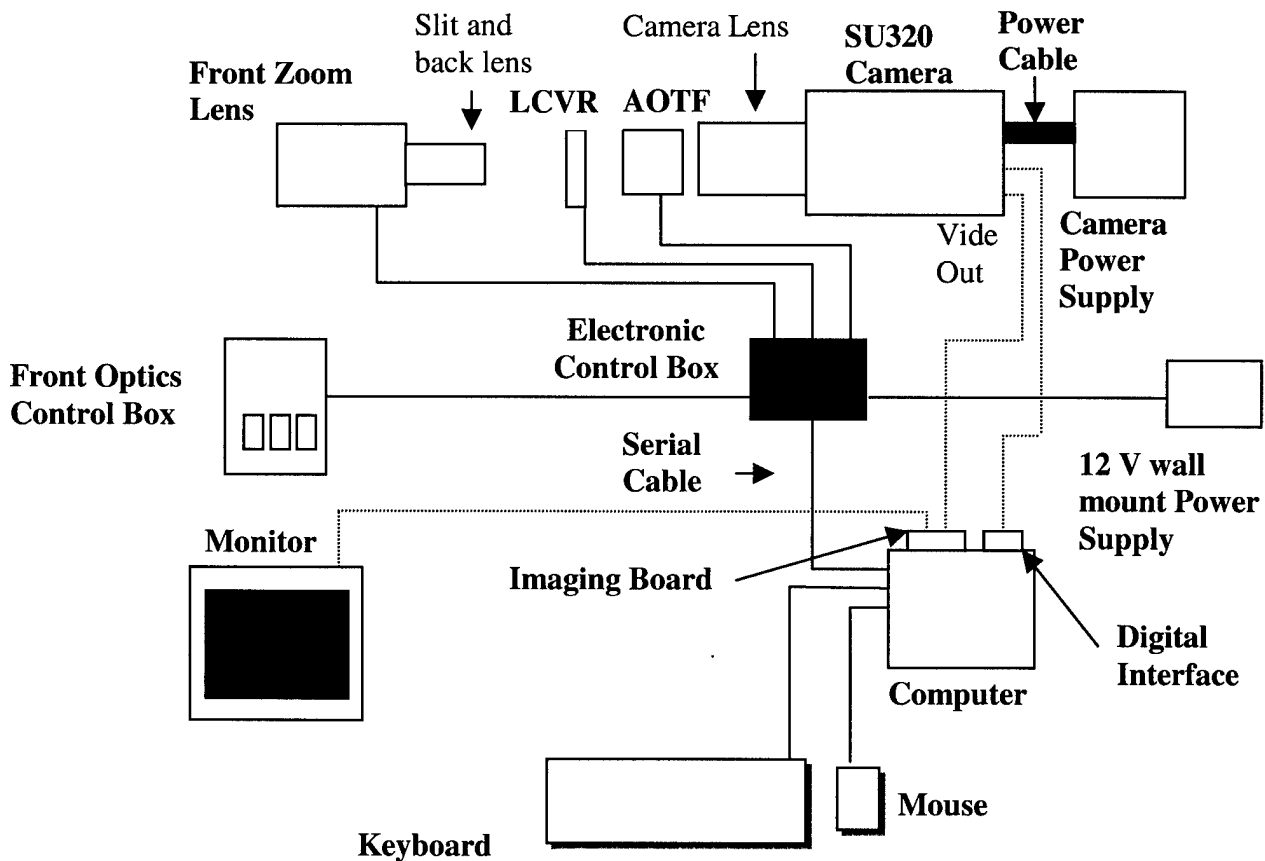

Fig. 3.1. Physical layout and connections among the various components of the system.

Table 3.1. Interconnection Cables

Connection (1-2)	Connector 1	Cable	Connector 2
Zoom – Electronic Control Box	Hardwired	Multi-conductor	8-pin Weathertight
Zoom control – Electronic Control Box	Hardwired	Muliti-conductor	6-pin Weathertight
AOTF – Electronic Control Box (RF amplifier)	SMA	Coaxial	SMA
LCVR – Electronic Control Box	SMB	Coaxial	BNC
Computer (COM1) – Electronic Control Box	DB9	Multi-conductor	DB9
Power supply – Electronic Control Box	Hardwired	Multi-conductor	DIN
SU320 camera (analog out) – Imaging Board (Matrox Corona)	BNC	Coaxial (RED)	DB44
SU320 camera (digital out) – Imaging Board (Digital interface)	DB37	Shielded 80 pin cable	SCSI-2 80-pin
Computer monitor – Imaging Board (Matrox Corona)	Hardwired	Multi-conductor	DB15 (VGA)
SU320 camera – Power supply	Locked connector	Multi-conductor	Locked connector

3.2 Alignment Procedure

Objective

For the system to work properly, the optical train must be properly aligned. The objective of the alignment exercise is to accomplish the following goals: (1) The front zoom lens forms an image where the slit is located. This is already made at the factory and normally there is no need for further adjustment. (2) The collimating lens correctly collimates the ray from the image formed at the slit. The aperture of this lens should be fully open. (Visible version only.) (3) The optical axis of the collimating lens is aligned vertical to the input face of the AOTF. This is important because the tuning characteristics of the AOTF is affected by the angle of the incidence of the ray. The AOTF crystal is designed so that the so-called “parallel tangent” condition is satisfied when the incident ray is normal to the crystal face. (4) The camera lens is positioned such that its optical axis is parallel to the diffracted (filtered) ray.

The aligned configuration of the various elements is shown in Fig. 3.2 below. The user should use this figure as a guide and follow the step-by-step procedure below.

Side View (Not to scale)

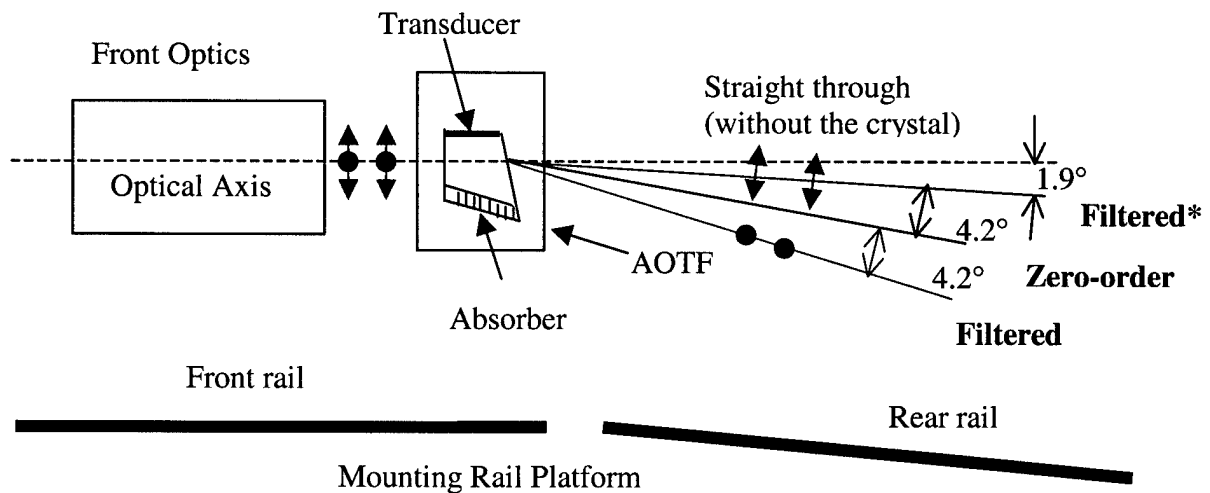

*Desired diffracted ray, to be captured by the camera.

Fig. 3.2. Alignment of the Optics. Note that the AOTF serves as a polarization analyzer. As the horizontally polarized (ordinary) ray passes through the AOTF, it is converted to vertically polarized (extraordinary) ray, which is spatially separated from the unfiltered ray and the horizontally polarized (ordinary) ray as shown.

Top View (Not to scale)**Side View (Not to scale; Tilt exaggerated for illustration)**

Fig. 3.3 Relative positioning of various elements in the aligned configuration.
Alignment Procedure

1. With cover open, carefully remove the AOTF assembly and cabling. Secure the AOTF assembly in a safe place.
2. Using ruler, caliper and Fig. 3.2 above, perform a quick adjustment of the front optics and the back zoom lens so that their optical axes coincide and are parallel to the mounting platform. Note that the camera is deliberately set upside down so that the final image is right side up.
3. Aim the camera to a target at least 2 m away from the camera's front optics. If necessary, add an adapter ring to focus the image. A resolution chart on the wall illuminated by an incandescent lamp will be convenient.
4. Power up the camera and the Electronic Control Box. Turn on the computer and the monitor. Run the control program by double clicking on the SPImager icon.
5. Select File-Start to see the image from the camera. The image captured by the camera should now appear in a display window on the screen. Adjust the tilt angle of the camera so that the edge of the image that is limited by the slit is visible in the display. If necessary, adjust aperture at the camera or the exposure time (a thumb-

wheel at the back of the camera sets the exposure time.)

6. The back lens of the front optic is already adjusted at the factory to the infinity. Make sure that the holder ring is screwed in all the way. Adjust the focus of the camera lens to get a sharp image of the **slit edge**. This is to make assure that the camera lens is focused on the image plane in the front optic that control the camera's field of view. Adjust the focus of the front lens so that you can have a sharp image of the object.
7. Put the AOTF assembly and cabling back onto its position on the mounting platform. The side labeled "INPUT" should face the back lens of the front optics. Adjust the orientation of the AOTF housing so that the crystal face is normal to the optical axis. Because the light is now refracted down by 6.1° , the image will not be seen on the display.
8. Connect the Electronic Control Box and the AOTF assembly. Power up the Electronic Control Box. From SPImager program, select Control-RF Control. RF Control dialog box will appear. Using the mouse, select a wavelength which gives a reasonably bright image on the screen (a good value is ~ 1200 nm) by clicking on the horizontal scroll bar.
9. At this point, the filtered image will only partially fill the display. (See Fig. 3.4.) Move the camera up slightly ($\sim 1.9^\circ$) so that the filtered image fills the display window. The system is designed so that the image will slightly overfill the image plane.

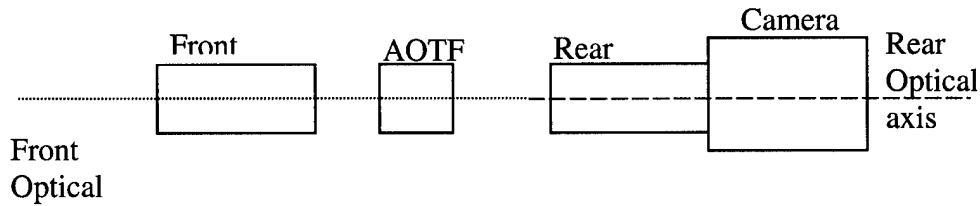
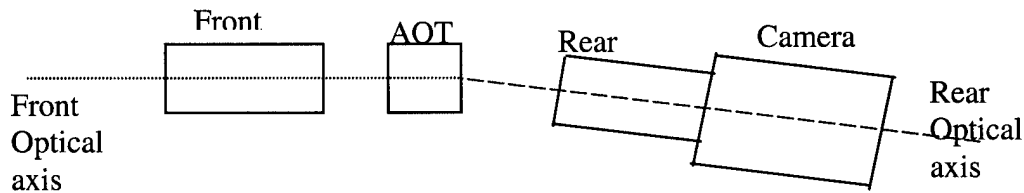
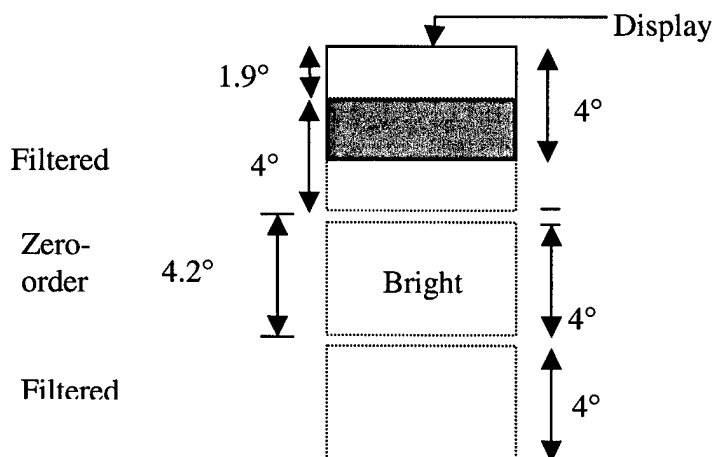

Fig. 3.2.2. Relative positions of the 3 images after passing through the AOTF when the camera is aligned to see the straight through light. Only the top half of the upper filtered image (shaded region) is inside the display window and is visible.

Make sure that the aperture of the camera is open. Adjusting this aperture will reduce the stray light. The exposure can also be adjusted by exposure time control. This is accessible from the rear of the camera.

4. System Software

The SPImager is the primary tool for image data control and acquisition using the SpectroImager. SPImager lets the user display (and save in tiff files) live video from the camera on to the computer monitor, display and inspect image files acquired previously, and control electronically the RF output to the AOTF as well as the control voltage to the LCVR. Numerical image enhancement methods such as background subtraction and contrast enhancement may be performed in real time. SPImager was developed under Windows NT 4.0 using Borland C++ ver. 5.02 and Matrox Imaging Library ver. 5.12.

Operating Tips

Before running SPImager.exe, make sure that:

1. All the components are properly connected (See Section 3.1).
2. The computer and monitor are turned on.
3. The power for the Electronic Control Box is turned on. (This is easy to forget.)
4. The power for the camera is turned on.
5. Select an appropriate display setting. A resolution of 1024 x 768 with 16 bit color should work well for most cases.

4.1 Running SPImager

To run this program, simply double click on the SPImager icon. The program may respond with an error message that spimager.cal file is missing. The text file spimager.cal contains the calibration data for the control box, AOTF, and LCVR. This file must reside in the working directory. (If you are using the original components, you can run the code without this calibration file because the SPImager uses the default values that are appropriate for those components. More details for this file is given in Section 4.3.) Click OK.

- (1) A setup dialog box will appear so that the user can select the digital/analog interface and the communication port for the serial interface. The computer is configured at the factory to use the COM1 port.
- (2) The third option (File) is available for image input in order to load a previously acquired image file to the main window. The user can then inspect the pixel values and adjust contrast of the image.
- (3) The main window and Image Control Dialog open. The main window has two parts: 640 x 480 image display and a graph area where the spectral data are displayed. Initially, both the image and the graph areas are empty.

Image File Functions:

- (1) To display live video from the camera: Select File-Start

- (2) To freeze image from the camera: Select File-Stop
- (3) To save image currently displayed on the screen: Select File-Save. A dialog box will appear. Enter filename with *.tif extension; the image file will be saved in tiff format. At the same time, camera setting data will be saved in imagelog.txt file. This file can be checked by selecting File-Data log-Image Files. (Or with any text editor.) If no directory information is included in the filename, the file is saved in the current working directory.
- (4) If "raw image" option is selected in the File Name Select dialog box, additional two files will be saved with file names of *-raw.tif and *-bg.tif, where * is the root file name you selected for the image file. (If accumulate option is selected, the numerically integrated (after background subtraction) image file will be selected as *-acc.tif instead of *-raw.tif.)
- (5) To display image acquired previously: Select File-From File. Then enter (or select) the image filename. The image will be displayed in a separate window. Up to four image files may be opened simultaneously. (If "File" is selected as image input at Set Up, the image will be displayed in the main window.)
- (6) Pixel value at a position indicated by a mouse cursor will be shown at the lower left corner of the main window. Note that the pixel value is that of the raw image even when image processing functions such as background subtraction are activated. For the digital image, the value will be in 12 bit (0 ~ 4095) while for the analog image, it will be in 8 bit (0 ~ 255).

Image Control Functions:

- (1) To magnify the image on the main window: Select Image-Zoom. The options are x2, x4, and unzoom (x1). This zooming function applies to the image in the main window. Separate control buttons are available for the extra windows that open for showing the previously acquired image from file. (The inspection window does not work correctly when the view is zoomed up.)
- (2) To magnify the intensity of the image data through the digitizer LUT (look up table). (This function is currently disabled in order to avoid confusion with the software gain described below. Since both gain controls are a numerical process, the result is essentially the same.)
- (3) To reopen Image Control Box: Select Image-Image Control

Image Control Dialog Box:

Several advanced image enhancement functions may be accessed from this dialog box:

- (1) **To subtract background:** Check Subtract Background box. The background image in this case is an image acquired with the AOTF turned off. Background contribution due to stray lights and scattering as well as non-uniformity in the array's black level can be removed by selection this option.
- (2) **To re-acquire background image:** Click on Reset button. The background image is acquired once when the Subtract Background box is checked. The same background

image is used for each subsequent image processing. The background image will be updated when Reset button is clicked.

- (3) **To adjust contrast:** Check Enhance Contrast box. Auto and manual modes are available. Click on the appropriate radio button. In auto mode, the program scan through each newly acquired image file (if background subtraction mode is selected, the background is subtracted first) and determines the appropriate gain (multiplication factor) automatically. However, since the multiplication factor (gain) is selected for each image, the video image may appear to flicker if the image contain noisy pixels that change the multiplication factor each time. In manual mode, the user can select the gain between 1/16 to 255 using a scroll bar.
- (4) **To accumulate frames:** Check "Accumulate." With this option checked, the SPImager accumulates (adds) pixel values after first subtracting the background value. (Because of the relatively high background, the accumulate is not very useful without the background subtraction.) This is made pixel-by-pixel for each frame. Accumulation takes place in background and the result will be shown when the specified number of frames are accumulated. In this mode, the contrast enhancement applies to the accumulated image.

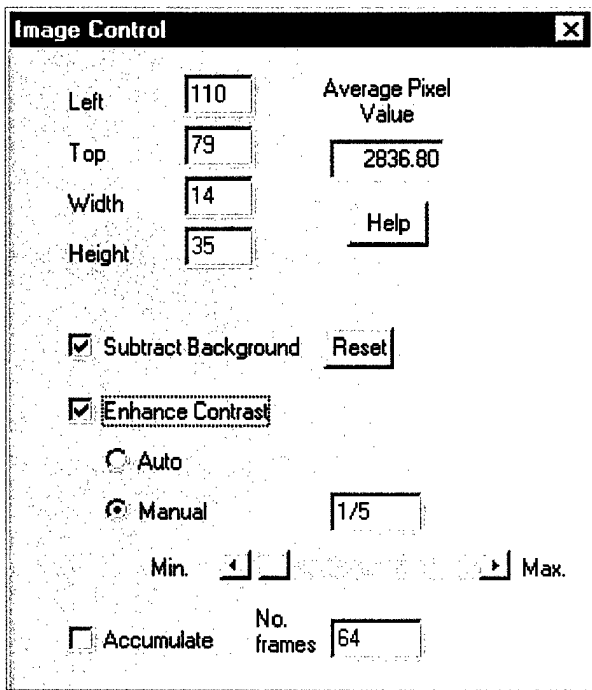

Fig. 4.1. Image Control dialog box.

Gain and Exposure Control

The camera has a built-in exposure control that sets the exposure time between 0.1 ~ 16 msec in 8 steps. Because of the limited sensitivity, the camera should be normally set at its maximum exposure time (switch position 7 or F).

The camera's gain is fixed, but the frame grabber (Matrox Corona) has a built-in look-up table (LUT) that can be used to change the system gain. However, this function is currently disabled to avoid causing confusion to the user. The user controls the system gain through the image control dialog box as described above.

With the digital interface, the pixel values are in 12-bit (0 ~ 4095) while with the analog interface, the frame grabber digitizes the signal to 8-bit (0~255) values. In terms of the pixel value, the digital interface gives 16 times higher gain. When the SPImager is running at normal mode without contrast enhancement, the gain is set to 1/16 so that the display will saturate at the same time for both digital and analog interfaces.

Note that the gain here means the ratio of the pixel value in the display buffer (always 8 bit) to that in the acquired image buffer (12 bit in digital and 8 bit in analog). The gain setting only affects the image display and saved display image file. Raw image files, background files, and the spectral data (averaged pixel values for the inspection windows) are not affected by the gain setting.

Opening Inspection Windows:

Up to seven rectangular windows may be opened to determine the average pixel values in that window. One of those window has a focus and the position, size and the pixel values for that window will be reported continuously on the edit boxes in the Image Control dialog box. These windows will also be used for collecting data while scanning the AOTF or LCVR control values.

- (1) To open a window: Move the cursor of the mouse to where you want to have a corner of the window. Press the left button and drag the mouse while keeping the button down. Release the button where you want to have the diagonally opposite corner. Click the right button to select. Clicking on the left button will cancel the selection. (Hint: it may be easier if you do this while the camera is stopped because you can see better the outline of the rectangle.)
- (2) To delete the window: Hold <control> key while clicking on the rectangle you want to delete.
- (3) To change the focused window: Hold <shift> key while clicking on the rectangle on which you want to have a focus.
- (4) The position and size of the window may be specified more precisely from the edit windows on the Image Control Dialog Box. Edit the value and press <enter>.

Controlling AOTF and LCVR:

Three separate control dialog boxes are available for the AOTF and LCVR control.

- (1) To open AOTF Control dialog box: Select Control-RF Control. The filter wavelength and the attenuator setting can be selected from this dialog box using the scroll bars. One of the four VCOs will be automatically selected to generate the frequency to give the selected filter wavelength.
- (2) To open Advanced AOTF Control dialog box: Select Control-RF Advanced. This dialog box allows individual control of all four VCOs. Multiple filter bands may be opened by enabling multiple VCOs. However, the control must be given in the control voltage (in unsigned 12 bit value, 0 - 4095). The corresponding RF frequency and the filter wavelength will be shown in the edit box. (Currently, the image data log file (imagelog.txt) are not notified on the status of the Advanced AOTF Control. When using this control and saving the image, the user must edit imagelog.txt manually to indicated the correct status.)
- (3) To open LCVR Control dialog box: Select Control-LCVR Control. The user specify the retardation in waves (1/4 wave, half wave etc.) using a scrollbar. If the wavelength selected by AOTF Control changes, the LCVR control automatically select a new control value so that the retarder will be set to the correct retardation for the new wavelength. Radio buttons are also available to set the retardation to the zero, 1/4, and 1/2 wave. Edit boxes show the control voltage (in mV, 0 - 20000), the retardation in wave, and the wavelength.

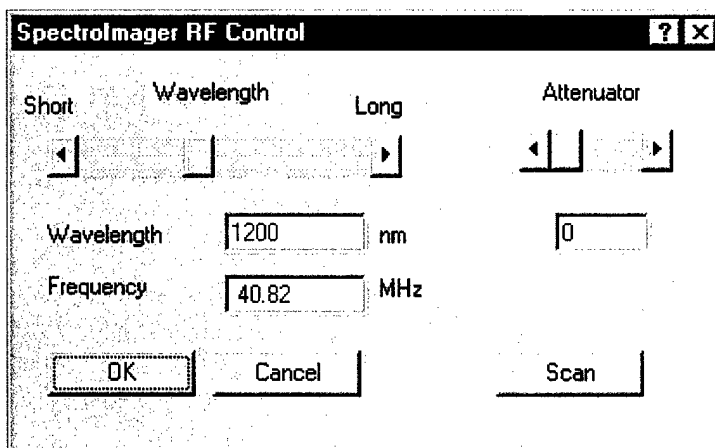

Fig. 4.2. RF Control dialog box.

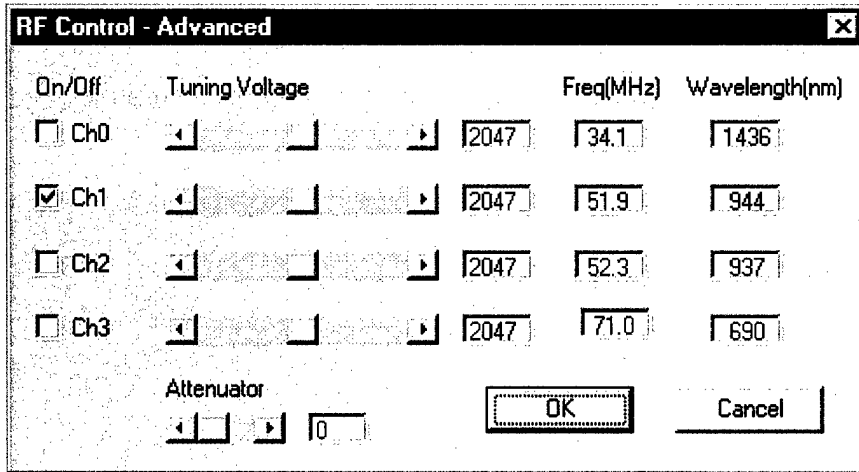

Fig. 4.3. Advanced RF Control dialog box.

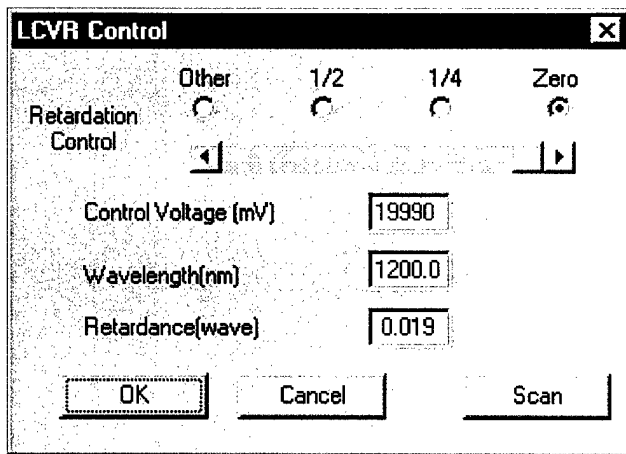

Fig. 4.4. LCVR Control dialog box.

4.2 Obtaining Spectrum of an Object using SPlmager

The SPlmager gives a simple method to acquire spectral data of any object in the scene. Two scan modes are available: constant wavelength step and constant wavenumber step. A maximum of 100 steps may be specified for a single scan. The spectral data are saved in a text file (*-info.txt) and image files may be also saved for each step. A log file

scan.txt is also created to serve as an index for the scan records. The scan speed is approximately 30 msec per step if no images are saved. If both raw and display images are saved, the scan speed may go down to about 70 msec per step. The spectral data are displayed graphically after the scan. The display images will also be shown on separate image windows in order to allow the user visual comparison of the scanned images.

To obtain spectral data, perform the following steps:

- (1) Set up the camera and aim it to the scene of interest.
- (2) Open windows for the particular objects of interest in the scene. (See "Opening Inspection Windows" above.) Up to seven windows may be opened. The SPImager calculates an average pixel value in the selected windows. If an object of known reflectivity is available in the scene, open a window for that so that it will serve as a standard for converting the intensity data to reflectivity.
- (3) Open RF Control dialog by selecting Control-RF Control from the menu. Click on Scan button. Scan Control Dialog will appear.
- (4) Following the above steps, the Scan Control is automatically set for Spectrum scan (Retardation scan will be explained in the next section.). The user can select either constant wavenumber steps or constant wavelength steps using the radio button. The user can specify the wavenumber (or wavelength) at the beginning and the end of the scan as well as the step.
- (5) The image files are saved for each scan step in an image size (320 x 240 pixels). Analog image may be saved as an enlarged format (640 x 480). Check the box to select this option. No images will be saved if the "Save image files" box is unchecked. In this case, SPImager automatically creates a file name for the scan record.
- (6) Click on "Begin" button when the setting is completed. If "save image files" option is selected, "Image File Selection" dialog will appear. Enter a root name that will identify the scan. SPImager will automatically add the wavenumber (or wavelength) at which the image is acquired and .tif extension. For example, if the root name is tmp, and the scan begins at 12500 wavenumber, the first image file name will be tmp12500.tif. The image files will be saved in the current working directory unless the root name contains subdirectory strings. (**Warning: Files with a duplicated name will be overwritten.**) Click OK. The scan will begin immediately.
- (7) When the scan is finished, a message box will appear announcing the completion of the scan. It also reports the number of data points taken and the elapsed time. A typical scan speed is 30 msec per step if no images are saved. Click OK.
- (8) If the images are saved, the user may choose to review them. To display them, choose yes to "Want to see the Image?" message box. Up to 4 additional windows will open to display the scanned images. If there are more images, another message box will appear to prompt the user to choose either to overwrite on the first window or to stop displaying.
- (9) A graph will be now drawn on the graph area to show the results of the scan. The color of the line in the graph is matched with the color of the inspection window for easy identification. The spectral data are also saved in a text format file, *-info.txt, where * stands for the image file name you selected (not including the wavenumber

- or wavelength). If no images are saved, SPSImager creates a file name automatically based on the date and time (e.g., 200003041601-info.txt.)
- (10) The user can choose to display the graph with the background subtracted. Also, the graph can be shown after scaling with the curve that corresponds to the inspection window that has a focus. If the object in the (selected) inspection window has a spectrally flat response, the scaled curves will show correct spectral response of the object. Select Graph on the menu and set or reset the subtraction and scaling option.
- (11) Check *-info.txt by selecting File-Data log-Scan Data (or any text editor such as notepad). Notepad opens scan.txt that keeps a list of all the scans. Using the notepad's file/open function, open the *-info.txt file. An example of this file is shown below. Although the file already shows all the relevant parameters that can be automatically collected, it is a good idea to add comments so that all the important experimental conditions will be documented. This file may be imported to a spreadsheet program such as Lotus 123 and Microsoft Excel for further processing.

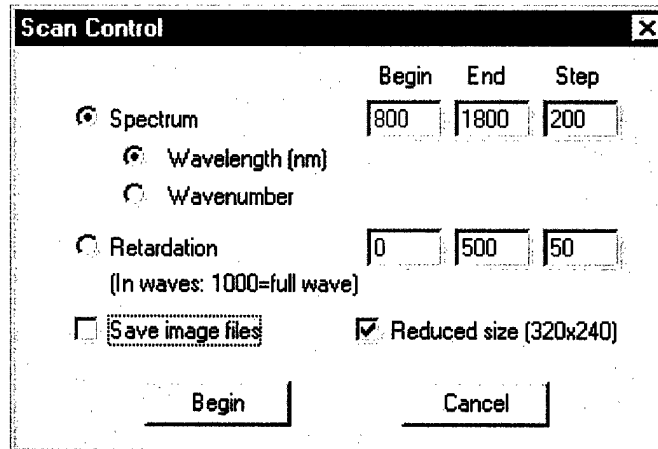

Fig. 4.5. Scan Control dialog box.

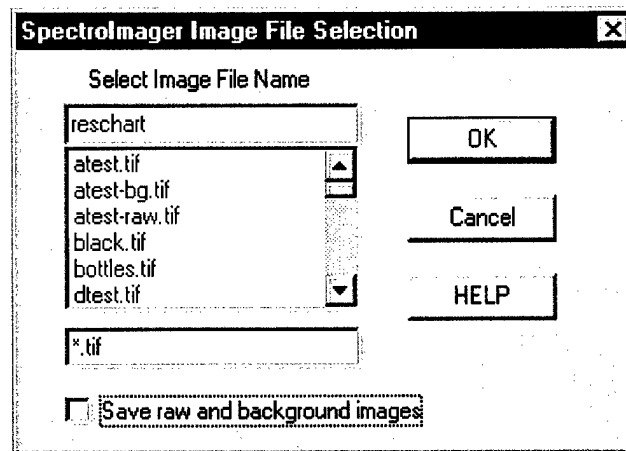

Fig. 4.6. Image File Selection Dialog Box

Tue Jan 25 14:56:53 2000[time stamp]

Image files: reschartxxxx.tif [Actual name: reschart0800.tif etc.]

Raw Image files: Not saved.

Camera Interface: Digital (12 bit)

Gain: Not enhanced.

Background: Not subtracted.

Scan type: Wavelength(nm), Retarder set at: 0.000000 (in wave)

Window(0): (34, 42)-(59, 69) [location of window #0]

Window(1): (123,185)-(141,199) [location of window #1]

Window(2): (202, 75)-(220, 94) [location of window #2]

sets: 3 points: 6 [6 data points were taken between 800 and 1300 nm.]

800.000 2182.95 2790.08 2052.19

1000.000 2431.49 3317.68 2289.98

1200.000 2627.38 3575.50 2483.67

1400.000 2537.42 3326.86 2396.44

1600.000 2461.89 3259.27 2318.26

1800.000 2272.51 2866.17 2139.59

Background 2177.83 2783.27 2047.07

[Average intensities are shown for each of the three windows at a given wavelength.

Background values were taken by turning off the AOTF.]

Fig. 4.6. An example of the scan data saved in reschart-info.txt. Texts in red italic (and in square brackets) are comments added for explanation and do not appear in the actual file.

```
Thu Feb 03 15:41:50 2000
btest1.tif: Digital, Gain: 1/16
Background: Not subtracted.
Raw image file: Not saved.
Background image file: Not saved.
Wavelength:1200.000000, Attenuation:0, Retardance(in wave):0.000000

Thu Feb 03 15:44:03 2000
btest2.tif: Digital, Gain: 1/16
Accumulate ON, No. frames: 2
Background: subtracted.
Raw image file: Not saved.
Background image file: Not saved.
Wavelength:1200.000000, Attenuation:0, Retardance(in wave):0.000000

Thu Feb 03 15:44:27 2000
btest3.tif: Digital, Gain: 1/16
Accumulate ON, No. frames: 2
Background: subtracted.
Raw image file: btest3-raw.tif
Background image file: btest3-bg.tif
Wavelength:1200.000000, Attenuation:0, Retardance(in wave):0.000000

Thu Feb 03 15:45:57 2000
btest4.tif: Digital, Gain: 1/4
Background: subtracted.
Raw image file: Not saved.
Background image file: Not saved.
Wavelength:1200.000000, Attenuation:0, Retardance(in wave):0.000000

Thu Feb 03 15:47:08 2000
btest5.tif: Digital, Gain: 1/3
Background: subtracted.
Raw image file: btest5-raw.tif
Background image file: btest5-bg.tif
Wavelength:1000.000000, Attenuation:0, Retardance(in wave):0.000000

Thu Feb 03 15:55:41 2000
btest6.tif: Analog, Gain: 1
Background: Not subtracted.
Raw image file: Not saved.
Background image file: Not saved.
Wavelength:1000.000000, Attenuation:0, Retardance(in wave):0.000000
```

Fig. 4.7. An example of imagelog.txt. This file is updated automatically when an image is saved.

At the end of the scan, if the user selects, up to 4 additional windows will open in order to display the scanned images. If more images need to be shown, the user is prompted to choose either to overwrite the first window or to stop displaying. This message box may be hidden under the newly opened windows. Select 'SImager' on the window's task bar. The task bar is also convenient in quickly scanning through the image windows.

4.3 Retardation Scan

The amount of retardation may be scanned just as the wavelength (or wavenumber). To perform retardation scan, follow the same steps as for the spectral scan. Note that the Scan Control dialog box can also be accessed from the LCVR Control dialog box by clicking on Scan button. The only difference is that the retardation scan is pre-selected if accessed from the LCVR Control dialog.

The amount of retardation is to be specified in wave, 1000 being equal to a full-wave retardation. For example, to scan from zero wave retardation to half wave retardation in a step of 1/10 of wave, enter 0, 500, and 100, respectively in the Begin, End, Step edit box.

4.4 Calibration Data File

The calibration data for the SPIImager are saved in a spimager.cal and are read by the SPIImager at start up. This is a text format file and may be modified by the user if the calibration data changes. The data consists of three parts: calibration data for the electronic control box, tuning curve for the AOTF, and tuning curve for LCVR. Each part begins with a single line comment. Meaning of each parameter will be explained below:

Calibration data for the Electronic Control Box:

The electronic control box actually has two separate controls for the AOTF and LCVR. Only the AOTF control needs calibration data; the LCVR is controlled by varying the amplitude of a 2 kHz square wave. This amplitude is set accurately by a 16 bit DAC and an operational amplifier whose offset is carefully adjusted to zero at the factory. In contrast, the AOTF is controlled by varying the frequency of RF signal. The frequency is set by four VCOs. While the voltage applied to the VCO is accurately set by a four-channel 12-bit DAC, the tuning curve of the VCO varies from sample to sample. Without calibration for each VCO, the maximum error in frequency may exceed a few percent. The calibration curve for each VCO is defined by a linear function:

$$f = f_0 + V / a$$

where f is the output frequency in MHz and V is the input voltage in 12-bit unsigned value (0-4095). The calibration constants f_0 and a are determined for each of four VCOs and listed in spimager.cal.

The SPIImager uses three VCOs (ch0, ch1 and ch3) to cover the entire frequency range of 24 ~ 100 MHz. In order to switch one VCO to another without discontinuity, crossover frequencies are also specified. Switching between ch0 and ch1 is made at f_1 and switching between ch1 and ch3 is made at f_2 . (Ch2 is not used.)

Calibration Data for AOTF:

The tuning curve for the AOTF is given by the following equation:

$$f = \left(c + \frac{d}{\lambda - \lambda_0} \right) \frac{1}{\lambda}$$

where f (in MHz) is the frequency of the acoustic wave and λ is the wavelength of the transmission band (in μm). Constants c , d , and λ_0 define the tuning relationship and given in the calibration data file (spimager.cal). In addition to these three constants, the calibration data file also specifies the minimum wavelength λ_{min} , maximum wavelength λ_{max} and the default wavelength λ_{mid} .

Calibration for Freq. Generator AMC#3(ARL) tested 5-21-99
 159.15, 101.72, 100.53, 71.44 [*Constant a for ch0, ch1, ch2, and ch3*]
 21.25, 31.78, 31.91, 42.35 [*Constant f₀ for ch0, ch1, ch2, and ch3*]
 43.66, 63.10 [*Crossover frequency f₁ and f₂*]
 Calibration for SW AOTF S/N:1135 5-17-99(tentative)
 48.98, 0.0, 0.0 [*Constants c, d, and λ₀*]
 800.0, 1200.0, 1800.0 [*λ_{min}, λ_{mid}, and λ_{max}*]
 Calibration for LCVR 99-025(for SW) 2-25-99(tentative).
 530.3, -0.1084, 0.959, 1341.0, 0.885, 0.0 [*Constants r₀, r₁, r₂, r₃, r₄, and r₅*]

Fig. 4.8. Calibration data file spimager.cal consists of three parts: calibration data for the electronic control box, tuning curve for the AOTF, and tuning curve for LCVR. Texts in red italic (and in square brackets) are comments added for explanation and do not appear in the actual file.

Calibration Data for LCVR:

The relationship between the retardance ϕ (in nm) of the LCVR and the amplitude of the control voltage input v (in volt) is approximated by the following equation:

$$\phi = \frac{r_0 + r_1 \lambda}{v^{r_2}} + \frac{r_3}{e^{v/r_4}} + r_5$$

where λ is the wavelength of the light. Calibration constants r_0 , r_1 , r_2 , r_3 , r_4 , and r_5 are given in the calibration data file.

Appendix A. Electronic Control Box

A1. Communication Interface

The communication interface of the electronic control box is completely passive and does not transmit any data. No data flow control is implemented. At power up, it expects 8 bit, no parity, 1 stop bit data at 9600 baud rate. The baud rate may be changed by sending a proper command (see the command summary).

The communication interface is controlled by MC68HC05MC4 micro-controller. The conversion to and from the RS232 signal to the CMOS logic signal is made by MC145407 driver chip. (The implemented control code does not transmit any data although the hardware is capable of data transmission in both ways.) The micro-controller decodes the control command and the associated operand and pushes out data to the 8-bit data bus from Port C. The I/O lines on Port A are used for data bus control.

Interfacing with the DACs and other components is achieved with the help of a 8-bit data latch DM74LS373. Four of these chips are used with a control line assigned for each chip. In the case of the 16 bit DAC (AD669), the eight most significant bit inputs are connected to the data latch and the eight least significant bit inputs are directly connected to the data bus. Three bytes of the data for the frequency generator board are all latched into the three 8-bit data latch chips.

Commands:

The following three commands are implemented for electronic control of the SpectroImager II from the host computer through its serial communication port: AOTF control, LCVR control, and baud rate selection. The commands are all in a single character (case-sensitive), which is followed by an operand of a fixed byte size. The syntax is summarized below:

Control Commands Summary.

A: AOTF control Command

Function:

Sets the voltage on the selected channel of the 4-channel DAC, enable any of the four VCOs, and set the 3-bit attenuator. These three functions are implemented in one command. The voltage output of the 4-channel DAC is set by a 12-bit unsigned integer (0 ~ FFF(hex)).

Syntax: *Almn*

The interface expects three more bytes of data after receiving command A.

Table A1. AOTF Control command operand.

Data byte	Bit	Comment	
1 st byte (<i>l</i>)	D11 (MSB)	12-bit DAC setting	
	D10		
	D9		
	D8		
	D7		
	D6		
	D5		
	D4		
2 nd byte (<i>m</i>)	D3		
	D2		
	D1		
	D0 (LSB)		
	Not used		
	Not used		
	DS1 (MSB)		Channel select
	DS0 (LSB)		
3 rd byte (<i>n</i>)	E3 (ch3)	VCO enable High: VCO on Low: VCO off	
	E2 (ch2)		
	E1 (ch1)		
	E0 (ch0)		
	Not used		
	A2 (MSB)	Attenuator setting	
	A1		
	A0 (LSB)		

L: LCVR Control Command*Function:*

Sets the amplitude of the 2 kHz LCVR control signal. The control range of 0 ~ 20 V is set by a 16 bit unsigned integer (0 ~ FFFF (hex)).

Syntax: *Lij*

The interface expects a two-byte data (16-bit unsigned integer) after receiving the command **L**.

R: Communication Rate Command*Function:*

Sets the data communication rate to a new value.

Syntax: Rk

The value *k* sets the baud rate according to the following table.

Table A2: Baud Rate Selection Table

<i>k</i> (decimal)	<i>k</i> (hex)	Baud Rate
0	0	125,000
1	1	62,500
2	2	31,250
3	3	15,630
4	4	7,813
5	5	3,906
6	6	1,953
7	7	976.6
8	8	41,670
9	9	20,830
10	A	10,420
11	B	5,208
12	C	2,604
13	D	1,302
14	E	651.0
15	F	325.5
16	10	31,250
17	11	15,630
18	12	7,813
19	13	3,906
20	14	1,953
21	15	976.6
22	16	488.3
23	17	244.1
24	18	9,615 (default)
25	19	4,808
26	1A	2,404
27	1B	1,202
28	1C	601.0
29	1D	300.5
30	1E	150.2
31	1F	75.12

A2. Frequency Synthesizer Circuit

The RF drive box designed by Advanced Materials Corporation (AMC) is a computer controlled oscillator system containing four oscillators providing coverage over a frequency range of 25 MHz through 100 MHz. Each oscillator can be individually controlled and up to four frequencies can be mixed together. The amplitude of the final waveform can be attenuated with up to eight .5 dB steps. The circuit is an integral part of the electronic control box. The power required is DC 12 volts @ 500 milliamps. A one watt RF amplifier is attached to the housing of the electronic control box allowing direct drive connection to the AOTF.

Theory of Operation

The heart of the RF synthesizer unit is comprised of four voltage controlled oscillators (VCO) manufactured by Mini-Circuits. The present unit uses the following modules:

- VCO #1: 25 - 50 MHz (Mini Circuits POS-50)
- VCO #2: 37.5 - 75 MHz (Mini Circuits POS-75)
- VCO #3: 50 - 100 MHz (Mini Circuits POS-100)

Two of VCO #2 are used in channels 1 and 2. VCO #1 is used in channel 0 and VCO #3 is at channel 3.

A 12-bit representation of a voltage is sent from the computer (controlled via software) to the synthesizer unit over the serial communication port and the (internal) 37-conductor ribbon cable. These 12 bits are presented to a quad digital to analog converter (D/A). Other bits from the computer control the selection of the specific D/A, chip operation commands, individual VCO selection and attenuation of the final waveform. The analog voltage created at the output of a particular D/A is amplified 1.4 times by a high slew rate, non-inverting, quad operational amplifier. This voltage is used to "tune" the VCO modules. As the tuning voltage rises the frequency produced also rises. The output of the VCO modules is fed to a 4-circuit passive combiner, then to an 8-step, .5 dB digital attenuator and finally to the output SMA connector to the amplifier.

The overall operation of the system is shown schematically in Fig. A.1. The physical layout of the circuit board is shown in Fig. A.2.

Circuit Operation

Power Section

Power is provided via a 12-volt DC source. Terminals J7 and J8 provide power connections for the RF amplifier. U14 is a DC-DC converter that creates the +15 and -15 volts required for other circuit elements. U15, a 5-volt positive regulator produces the

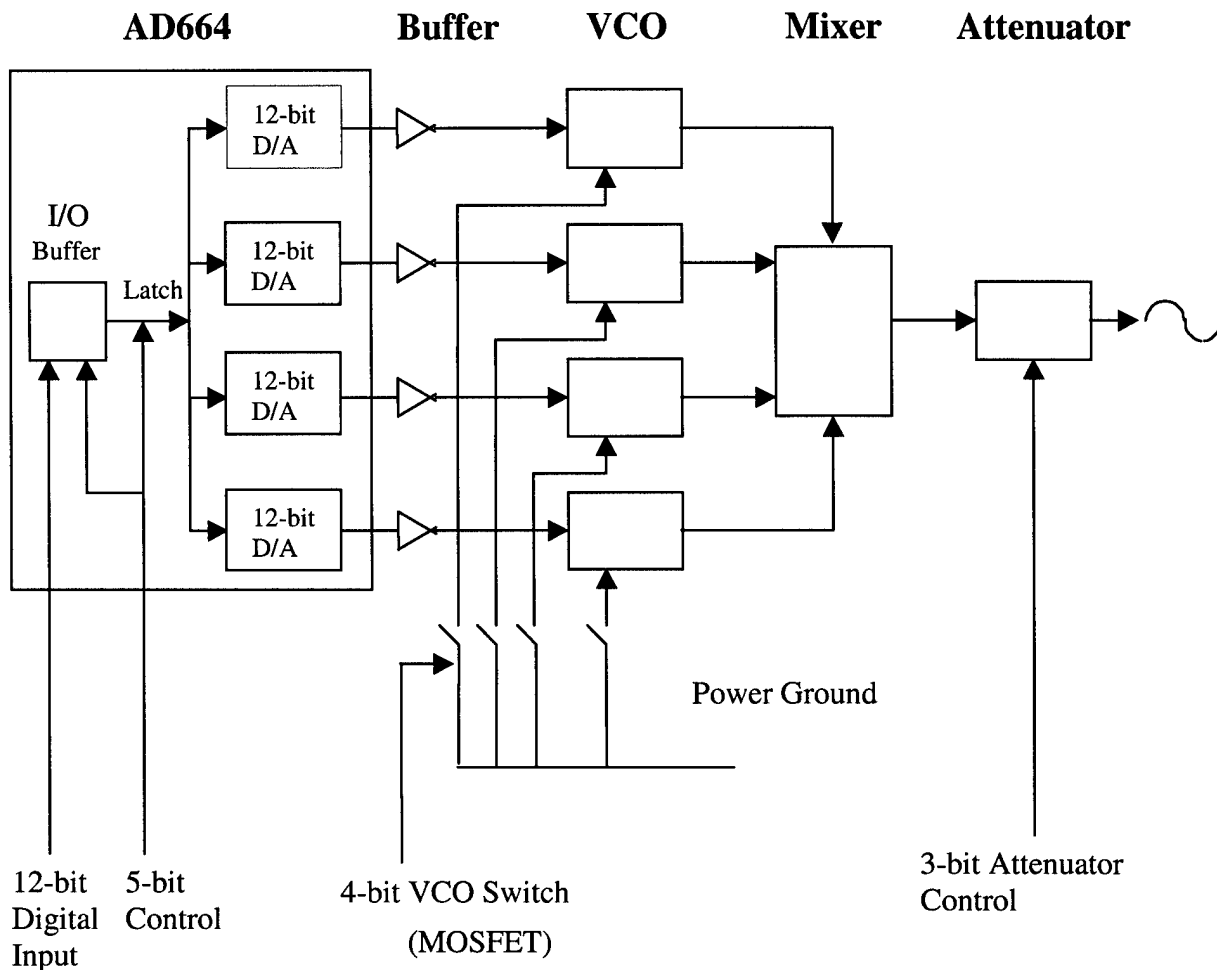

Fig. A1. A schematic of the rf drive section.

digital logic supply voltage. C9 and C12 are included to ensure proper operation for U15. J5 and J6 are points where this voltage source is available for external devices.

Voltage Reference U-6

The full-scale output voltage of the D/A (U4) is determined by the reference voltage applied at pin #1. An Analog Devices AD 587 is used to provide a stable +10 volt reference from the +15 volt source provided by U14. More precise voltage output could be achieved by using the “trim” pin on U6. Consult the AD587 data sheet for examples.

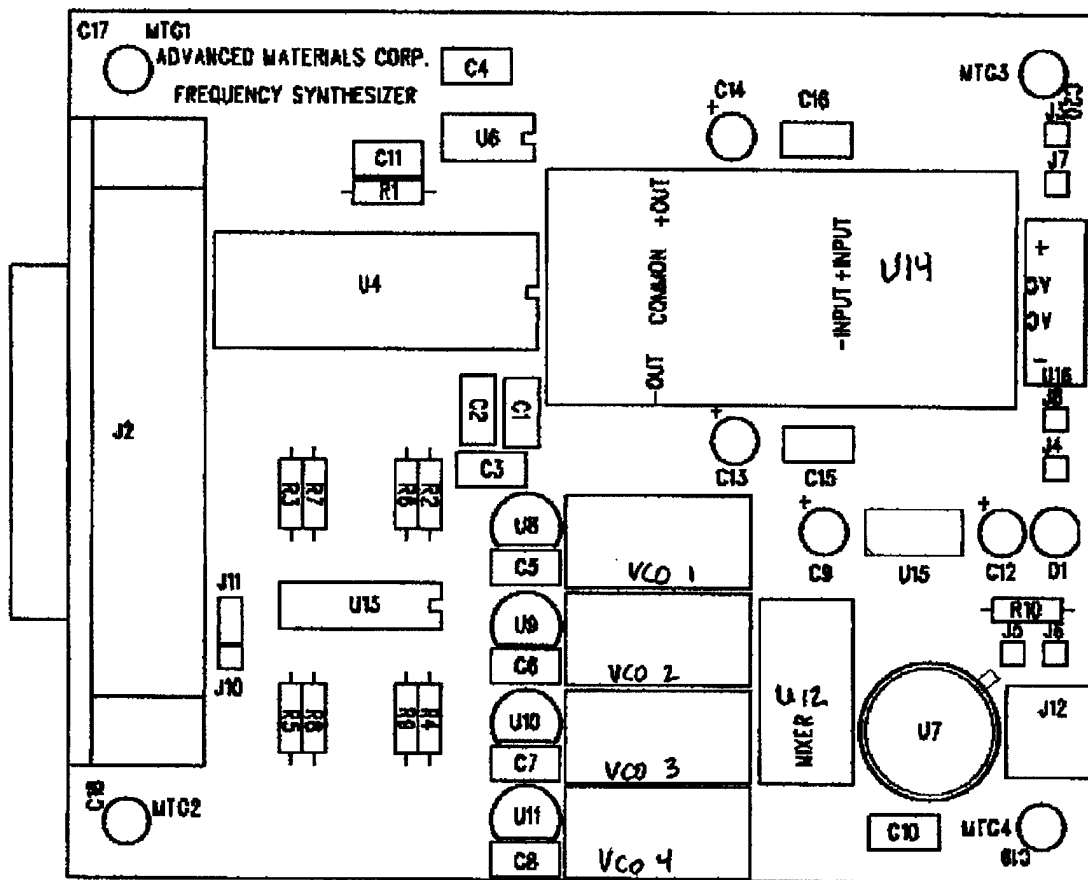

Fig. A2. Physical layout of the RF Drive circuit board.

Quad Digital to Analog Converter (D/A) - U-4

The 28-pin Analog Devices AD664JN-UNI is used to convert the 12 bit voltage representation into an analog voltage that can be used to "tune" the VCO modules. The IC contains 4 independent voltage output D/A converters and is unipolar, going from 0 volts to the reference voltage (10 volts in this application). The 12 bits are presented to pins 9 through 20 with pin 9 being the data bit 0 or the least significant and pin 20 being data bit 11 or the most significant bit. Reset for all the converters occurs on power up and is determined by the R/C network of R1 and C11. Selection of a particular converter is determined by the two-bit pattern appearing at pins 5 and 6. Pin 5 is the least significant bit (DS0) and pin 6 the most significant (DS1). The outputs for converters one through four are at pins 27, 28, 2 and 3. Chip select, latching and read operations are determined at pins 4, 23 and 22 respectively. There is an exact set of voltage states that must occur at a particular sequence for these operations to occur. This is taken care of

within the AMC software. A complete explanation can be found in the expanded data sheet for the AD664.

Analog and digital grounds appear at pins 7 and 24 with supply voltages of +5, +15 and -15 connected to pins 21, 25 and 26. Although the output of each converter is unipolar, a bipolar supply along with a +5 volt logic supply is required. Capacitors C2, C3 and C1 decouple noise from these supplies to ground.

Ribbon Cable Pin Assignments

A 37-conductor ribbon cable connects the synthesizer board with the main interface board. The assignments are shown in Table A3.

Quad Operational Amplifier U-13

An OP-467 Quad Operational Amplifier is used to amplify the output of each D/A to cover the full tuning range of the VCO. Feedback pairs consisting of (R2,R6), (R3,R7), (R4,R9) and (R5,R8) are connected in a non-inverting configuration and by their respective values of 39.2 ohms and 100k ohms, providing a gain of about 1.39. This amplifies the maximum 10 volt signal from the D/A to about 14 volts. Outputs from the D/A are connected to the amplifier inputs at pins 3, 5, 10 and 12 with the op amp outputs being pins 1, 7, 8 and 14. The +15 volt supply is attached to pin 4, analog ground at pin 11. C4 is the decoupling capacitor for this device.

VCO's and Switching FET's

This design covers a frequency range of 25 MHz to 100 MHz. Four VCO modules can be controlled by the D/A converters (the tuning voltages) and can be enabled by sending a high state (+5 volts) on pins 28, 27, 26 or 25 of the 37 pin connector. This turns on FET's U8, U9, U10 and U11 (ZVN4306A) completing the ground path for the VCO. As previously mentioned, VCO's ch1 and ch2 slots are chosen to be the same part but any combination of the VCO modules will work as long as the 100 MHz frequency limit is not exceeded. Pin 1 of each VCO module is connected to the +15 volt supply and capacitors C5, C6, C7 and C8 provide the decoupling for these devices. RF output on each module is on pin 2, tuning voltage (connected to the appropriate op amp section) is connected to pin 8, and pins 3, 4, 5, 6 and 7 are connected together and to the drain of the switching FET.

Four Circuit Combiner U-12

The RF outputs of the four VCO modules are connected to pins 7, 8, 1 and 2 (channels 0, 1, 2 and 3 of the VCOs, respectively). The combiner is Mini Circuits # PSC-4-1, a

Table A3. Interconnects between the interface board and the frequency board.

Connector Pin Number (DB37-female)	Schematic Name	Function
37	D0	Bit 0 (LSB)
36	D1	Bit 1
35	D2	Bit 2
34	D3	Bit 3
33	D4	Bit 4
32	D5	Bit 5
31	D6	Bit 6
30	D7	Bit 7
10	D8	Bit 8
9	D9	Bit 9
8	D10	Bit 10
7	D11	bit 11 (MSB)
6	D12	Channel select LSB (bit 0)
5	D13	Channel select MSB (bit1)
4	D14	RD (always 5V)
3	D15	CS
29	D16	LS
28	D17	VCO ch0 enable
27	D18	VCO ch1 enable
26	D19	VCO ch2 enable
25	D20	VCO ch3 enable
24	D21	Attenuator bit 0 (LSB)
23	D22	Attenuator bit 1
22	D23	Attenuator bit 2 (MSB)
21		Digital Ground
20		N/C
13		-15 V
12		Common
11		+15 V
2		Analog Ground
1		+12 V

passive 0 degree device. The combination of the inputs (or sum of the inputs) appears on pin 4, which then goes to the digital attenuator. Ground pins 3, 5 and 6 are tied together and connected to digital ground.

Digital Step Attenuator U-7

The amplitude of the output waveform can be controlled by a series of eight .5 dB steps. Three bits control the attenuation. Pin 2 is the LSB, pin 3 the next bit and pin 1 the MSB. These control bits are found at pins 24, 23 and 22 of the 37-pin cable connector. Pin 4 is the input to the device and pins 5 through 10 are tied together and to digital ground. Pin 12 is connected to +5 volt digital supply with C10 providing the decoupling for the device. Pin 11 is the output signal.

Output connector J1

The attenuated RF signal from pin 11 of U-7 is connected to J1, a female SMA connector. This connector is mated to a one watt RF amplifier.

A3. LCVR Control

16-bit DAC and Bipolar Voltage Outputs

The 16 bit data are converted into an analog voltage in the range of 0 – 10 V by U1 (AD669). This uni-polar voltage is converted into bi-polar voltages (up to ± 5 V) by U11 (A and B). The positive and negative voltages are then fed to a P-channel (Q2) and N-channel (Q3) enhancement type MOSFET pair with common drains. By switching the MOSFETs alternately, a square wave of with a controlled amplitude is generated.

2 kHz Square Wave Oscillator and the Voltage Switch

A 2 kHz square wave is generated using an LM555 timer. This signal is applied to the gates of the P-channel, N-channel MOSFET pair; when the signal is high the N-channel MOSFET conducts and the voltage at the drain becomes negative; when the signal is low, the P-channel MOSFET conducts, bringing up the drain to the positive voltage.

Amplifier

The voltage at the common drain is amplified by U12 (OPA445AP) which is in a standard inverting configuration. The amplifier is powered from +24 V and –24 V and its gain is set so that the maximum amplitude is 20 V.

Power Sections

+7 volt and –7 volt are produced by U13 and U14, respectively in order to give adequate supply voltage for U11. The DC to DC converter circuits provide +24 V and –24 V for the amplifier U12.

Adjustments

The circuits may need to be adjusted in order to minimize the glitches in the control signal and to set the duty cycle of the square wave close to 50 %. Before starting the procedure, connect the electronic control box to the host computer and connect the output of the LCVR control (BNC connector) to an oscilloscope. Use of an appropriate DC voltmeter at the output is helpful in determining the dc component. At power on, you should observe 2 kHz square wave with an amplitude of 20 V.

1. Reduce the amplitude to 0 (using SPIImager). Adjust R18 so that the DC voltage is zero at the output.

2. Set the amplitude to 20000 mV (maximum). Adjust R 22 so that the duty cycle is 50 %. (At 50 % duty cycle, the DC voltage at the output should remain less than 10 mV for the entire range of the amplitude.)
3. Set the amplitude to 1000 mV. Observe the waveform with an oscilloscope. Minimize the glitch signals associated with switching by adjusting R33 and C48.
4. Check the variation of the DC level as the amplitude is varied. Repeat Step 2 if necessary.