

# NAVAL POSTGRADUATE SCHOOL

## Monterey, California



### THESIS

MINE BURIAL IN THE SURF ZONE

by

Wayne L. Plager

September 2000

Thesis Advisor:  
Co-Advisor:

Thomas G. Muir  
Edward B. Thornton

Approved for public release; distribution is unlimited

REPORT DOCUMENTATION PAGE			Form Approved OMB No. 0704-0188	
Public reporting burden for this collection of information is estimated to average 1 hour per response, including the time for reviewing instruction, searching existing data sources, gathering and maintaining the data needed, and completing and reviewing the collection of information. Send comments regarding this burden estimate or any other aspect of this collection of information, including suggestions for reducing this burden, to Washington headquarters Services, Directorate for Information Operations and Reports, 1215 Jefferson Davis Highway, Suite 1204, Arlington, VA 22202-4302, and to the Office of Management and Budget, Paperwork Reduction Project (0704-0188) Washington DC 20503.				
1. AGENCY USE ONLY (Leave blank)	2. REPORT DATE Sep 2000	3. REPORT TYPE AND DATES COVERED Master's Thesis		
4. TITLE AND SUBTITLE: Mine Burial in the Surf Zone			5. FUNDING NUMBERS	
6. AUTHOR(S) Plager, Wayne L				
7. PERFORMING ORGANIZATION NAME(S) AND ADDRESS(ES) Naval Postgraduate School Monterey, CA 93943-5000			8. PERFORMING ORGANIZATION REPORT NUMBER	
9. SPONSORING / MONITORING AGENCY NAME(S) AND ADDRESS(ES) Office of Naval Research			10. SPONSORING / MONITORING AGENCY REPORT NUMBER	
11. SUPPLEMENTARY NOTES The views expressed in this thesis are those of the author and do not reflect the official policy or position of the Department of Defense or the U.S. Government.				
12a. DISTRIBUTION / AVAILABILITY STATEMENT Approved for public release; distribution is unlimited			12b. DISTRIBUTION CODE	
ABSTRACT The volumetric rate of scour and burial of a MK-83 mine by waves in the swash and surf zone were measured in two experiments. The beach was near planar with a 1:40 slope and mean grain size of 0.2 mm. The deep water significant wave height was about 2 m with peak periods of 13 sec. An Acoustic Doppler Velocimeter recorded orbital velocities of the waves. Three dimensional scour was measured manually and with video. Volumetric rate of scour over time relative to the volume of the mine was as high as 1 during the first hours of mine deployment. Maximum scour volume occurred at 6 hours after deployment and the scour changed from removal to fill after this time. The Shields parameter as a measure of total shear stress experienced by the sand bed was an order of magnitude greater than that required to initiate sediment transport. The mine was completely buried after 24 hours in the surf zone to a depth of 10 cm below the surface of the sand bed.				
14. SUBJECT TERMS Mine Burial, Scour, Surf Zone			15. NUMBER OF PAGES 66	
			16. PRICE CODE	
17. SECURITY CLASSIFICATION OF REPORT Unclassified	18. SECURITY CLASSIFICATION OF THIS PAGE Unclassified	19. SECURITY CLASSIFICATION OF ABSTRACT Unclassified	20. LIMITATION OF ABSTRACT UL	

NSN 7540-01-280-5500

Standard Form 298 (Rev. 2-89)  
Prescribed by ANSI Std. Z39-18

THIS PAGE INTENTIONALLY LEFT BLANK

**Approved for public release; distribution is unlimited**

**MINE BURIAL IN THE SURF ZONE**

Wayne L. Plager  
Lieutenant Commander, United States Navy  
B.S., Iowa State University, 1988

Submitted in partial fulfillment of the  
requirements for the degree of

**MASTER OF SCIENCE IN PHYSICAL OCEANOGRAPHY**

from the

**NAVAL POSTGRADUATE SCHOOL  
September 2000**

Author:

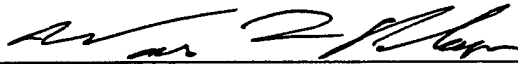

Wayne L. Plager

Approved by:

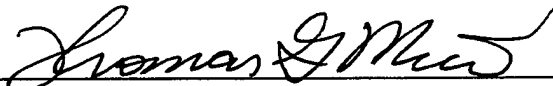

Thomas G. Muir, Thesis Advisor



Edward B. Thornton, Thesis Co-Advisor

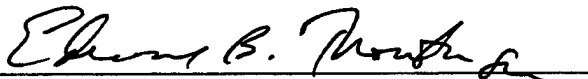

Roland W. Garwood Jr., Chairman  
Oceanography Department

THIS PAGE INTENTIONALLY LEFT BLANK

## ABSTRACT

The volumetric rate of scour and burial of a MK-83 mine by waves in the swash and surf zone were measured in two experiments. The beach was near planar with a 1:40 slope and mean grain size of 0.2 mm. The deep water significant wave height was about 2 m with peak periods of 13 sec. An Acoustic Doppler Velocimeter recorded orbital velocities of the waves. Three dimensional scour was measured manually and with video. Volumetric rate of scour over time relative to the volume of the mine was as high as 1 during the first hours of mine deployment. Maximum scour volume occurred at 6 hours after deployment and the scour changed from removal to fill after this time. The Shields parameter as a measure of total shear stress experienced by the sand bed was an order of magnitude greater than that required to initiate sediment transport. The mine was completely buried after 24 hours in the surf zone to a depth of 10 cm below the surface of the sand bed.

THIS PAGE INTENTIONALLY LEFT BLANK

## TABLE OF CONTENTS

I.	INTRODUCTION.....	1
A.	MINE BURIAL IN THE SURF ZONE.....	1
B.	BACKGROUND.....	2
C.	RESEARCH MOTIVATION AND OBJECTIVES.....	3
D.	OUTLINE .....	4
II.	THEORY.....	7
A.	MINE BURIAL PROCESSES .....	7
B.	SCOUR BURIAL. ....	8
C.	PREVIOUS STUDIES .....	10
III.	EXPERIMENT SETUP.....	13
A.	LOCATION .....	13
B.	TEST ARTICLE. ....	14
C.	INSTRUMENTATION.....	16
D.	SECOND EXPERIMENT SETUP .....	18
IV.	RESULTS.....	21
A.	PRELIMINARY EXPERIMENT.....	21
B.	SECOND EXPERIMENT. ....	28
C.	DATA ANALYSIS OF THE SECOND EXPERIMENT.....	31
V.	ENVIRONMENT .....	37
A.	PREVAILING CONDITIONS.....	37
B.	SHIELDS PARAMETER.....	38
C.	BEACH PROFILE.....	40
VI.	CONCLUSIONS.....	41
A.	SUMMARY.....	41
B.	FURTHER RESEARCH. ....	42
	APPENDIX. SCOUR PLOTS .....	45
	LIST OF REFERENCES .....	49
	INITIAL DISTRIBUTION LIST .....	51

THIS PAGE INTENTIONALLY LEFT BLANK

## ACKNOWLEDGMENTS

The author wishes to gratefully acknowledge the financial support from the Office of Naval Research, Code 322W and Dr. Douglas Todoroff.

The author would like to thank Professor Thomas G. Muir and Prof Edward B. Thornton for their guidance, assistance and patience during the work in performing this investigation. Without the support of both Prof. Muir and Prof. Thornton this work would not have been possible.

The author would like to thank his wife, Angela K. Plager for her support on the home front throughout the entire thesis.

**THIS PAGE INTENTIONALLY LEFT BLANK**

## I. INTRODUCTION

### A. MINE BURIAL IN THE SURF ZONE

Detection and prediction of mine burial in shallow water is an increasingly important topic for US military forces. The complex environment that constitutes the surf zone and very shallow water areas presents a formidable challenge to Mine Countermeasures (MCM) operations. One of the most difficult problems faced by MCM forces is the burial of mines into a sand or silt bottom by environmental forces such as wave or tidal action. Typically mines standing proud above the seabed are capable of detection by several different types of sensors, especially sonar, and to some extent lasers, and optical systems. Once a mine has become buried the detection probabilities decline dramatically. The only system currently operational that has any ability to detect mines buried below the seabed is the marine mammal (Renwick et al 1997). The marine mammal systems incorporate primarily trained dolphins for mine detection and marking, but they are cumbersome and expensive and cannot operate in the very shallow water of the surf zone. The ability to predict the rate of burial would provide MCM forces important information concerning the optimal timeframe to search for recently deployed mines.

The mechanisms that are primarily responsible for the burial of mines in the surf zone are poorly understood due to the chaotic and nonlinear nature of the air-sea-shore interface. This creates great difficulty in attempting to model or predict how quickly and to what extent a mine will be buried in sediment. Ongoing research conducted for the Office of Naval Research (ONR) into various individual mechanisms for mine burial hopes to address the shortfall in modeling and prediction of mine burial (Brandes 1999).

One goal of this type of research would be to produce a tactical decision aid for the war fighter. Such a decision aid would be able to at least predict with some degree of accuracy a rough idea of the probability of burial and a corresponding time frame for the burial process. Further goals involve assisting physicists and engineers in developing buried mine detection systems.

## **B. BACKGROUND**

The strategic need for MCM in shallow water was recognized before the Gulf War but that conflict emphasized the evolving nature of mine warfare. The white papers "... From The Sea" and "Forward ... From the Sea" by the Chief of Naval Operations (1992 and 1994 respectively) placed an unprecedented emphasis on warfare in littoral areas. Even though the littorals encompass as small part of the world geographically they contain over 80 percent of the world's capital cities and nearly all of the marketplaces for international trade (CNO 1992). The operational concepts that evolved from this strategy are spelled out in "Operational Maneuver from the Sea" (OMFTS) by the Commandant of the Marine Corps (1996). Maneuver warfare includes the movement between land and sea, especially rapid movement from ship to objective. Objectives in the full spectrum of conflict include not just purely military objectives, but also operations other than war such as to evacuate noncombatants, assist disaster victims and protect relief workers. "Because of their relative low cost and pervasiveness, mines have become a cheap means of limiting the mobility of ships and landing craft in the contested littoral regions." (CMP, 1996) Today's Navy-Marine Corps team is transitioning from dedicated MCM forces to organic MCM forces. Dedicated MCM forces were designed to respond to

specific threats, primarily in the bipolar world of the Cold War, and these forces are often home ported far from potential crisis areas. Organic MCM forces will forward deploy with carrier battle groups and amphibious readiness groups and be capable of responding to a wide range of threats presented by operating in the littorals. The force commander will require surveillance, intelligence and reconnaissance of the battle space to optimize the deployment of the MCM assets. (ONR report, "Naval MCM in the Littorals")

### **C. RESEARCH MOTIVATION AND OBJECTIVES**

Primary motivation for this thesis is the difficult problems facing the MCM forces that would be tasked to reconnoiter a potential area of operations. A potential adversary would be able to deploy a wide array of mine types and minefield obstacles to counter an amphibious operation. Mine types can range from crude moored mines in the water column dating from World War I; to sophisticated modern bottom influence sea mines designed with stealthy shapes and made primarily of non-ferrous materials. With such a wide-ranging threat, the Navy is developing a series of organic sensors to detect and classify mines. It is impossible for any one system or sensor to counter all of the possible threats. Establishing a capability to accurately locate mines and mark them for avoidance or clearing in the littorals is still being developed. New technologies such as Laser Detection and Ranging (LIDAR) and autonomous vehicles, such as the Remote Minehunting System (RMS), will be deployed from ships and helicopters to search the shallow water and surf zones. Knowledge of the environmental conditions that can either hinder or enhance the MCM effort in support of the transition from sea to land by operational forces needs to be improved.

The purpose of this research was to conduct several real world experiments in the surf zone with a simulated naval mine to determine actual rates of burial and to compare with theoretical models. ONR report, "Background Information on VSW and Surf Zone Concepts, Capabilities and Challenges in Support of Expeditionary Mine Warfare" defines the Surf Zone (SZ) as the high water mark to 10 feet of water depth. There is very little experimental data available concerning mine burial in the SZ and this area clearly could benefit from further investigation. In addition, there are few models that deal with the wave-induced forces that are primarily responsible for mine burial in the SZ.

The ocean engineering field does have extensive literature concerning scour around structures, including pipelines and vertical piles, but very little of it concerns wave action on the shoreline. The bulk of the information on scour concerns steady state currents in deeper water. The goal of the ocean engineer is to prevent scour or to plan for the ultimate depth of scour around a structure; for this reason, the scour research contains very little on the rate of scour. In addition, the timescales involved with scour around structures are measured in years, whereas the timescales for mine burial in the surf zone are in hours and days.

#### **D. OUTLINE**

The outline for this thesis consists of six main sections. The second section discusses the theoretical background concerning scour of sand and sediment from around an object due to wave and current action. The theory section primarily concerns itself with the theory of wave-induced forces on the sand bed upon which a bottom laid mine rests. Experiment setup is the third section and details the location of the tests, the test

article utilized, and the instrumentation used to conduct the tests. Results of the experiments are described in the fourth section where the amount of scour and rates of burial that the test article actually experienced while in the surf zone on a sloping sand beach. Discussion of the environmental forces that were measured and their effects on the actual results are contained within the fifth section. Conclusions and recommendations comprise the sixth and final section, which includes remarks about future research and lessons learned from this effort.

THIS PAGE INTENTIONALLY LEFT BLANK

## II. THEORY

### A. MINE BURIAL PROCESSES

Mine burial is complex and is dependent upon a wide variety of factors. This section will discuss some of the mechanisms and processes behind mine burial, and will focus in detail upon the scour, which is primarily responsible for mine burial in the surf zone with sand bottoms. When a mine is deployed, one of the primary considerations for whether it will bury itself is the type of seafloor encountered by the mine. Rock, coral, and heavy gravel bottoms will not permit mine burial, but sand, mud, silt, and bottoms that consist of mixture of these sediments will allow mines to bury. Depth of water and the prevailing current and wave conditions are significant factors in determining subsequent burial; deep-water areas (greater than 200 feet in depth) will be less able to support mine burial since wind, wave, and tidal effects are all greatly diminished (USN Hydrographic Office, 1957). Mines are most likely to bury in shallow water areas with bottom sediments.

The three major types of mechanisms that lead to mine burial are impact burial, scour, and bedform migration. Impact burial occurs when the mine is initially deployed either from aircraft or vessels and falling through the water column at a velocity sufficient to cause partial or complete burial upon impact into bottom sediment type with properties that allow burial. Impact burial is most common in soft, muddy sediments (Mulhearn, 1996). Scour burial is the result of sediment transport by current, tides, or waves in the vicinity of the mine creating a scour pit into which the mine can settle. Once the mine has settled below the level of the sediment, infilling by sediment transport will often cover the mine completely. Bedform migration, or the bedload sediment

transport, is the movement of sediment along the seafloor. Undulations or ripples that are flow-induced deviations from a flat bed can move in the direction of the prevailing current direction (Soulsby, 1997).

Secondary mechanisms that influence mine burial include liquefaction, shakedown, and biological activity. Liquefaction burial results when the bearing strength of the sediment is insufficient to support the mine and the sediment collapses due to external forces, typically water pressure fluctuations. The imparted pore pressures on the sediment by waves or tides cause grain contact in the sediment to be lost and the sediment shear strength approaches zero as the sediment becomes fluid (Brothers, 1998). Shakedown burial is a process where the mine settles into the bottom sediment through a rocking motion. Oscillatory lateral forces generated by waves acting in concert with the erosion of the underlying sediment due to the flushing action of the water trapped underneath the mine cause the rocking motion (Lott, 1999). Biological burial is caused by a variety of organisms, which take advantage of the cover and protection afforded by the mine lying on an otherwise exposed seabed. Many of these organisms, such as crabs, will excavate underneath the mine case and cause settling of the mine.

## **B. SCOUR BURIAL**

General scour is a result of interaction between the dynamic forces created by waves and currents acting upon the sediment type, both in size and density, which constitute the bottom. General scour affects a large area while local scour is classified as the scour that is generated by an object that is within the flow of water and sediment. The necessary and essential conditions for general scour to occur is when the actual water velocity exceeds the critical velocity required for sediment transport, with the critical

velocity dependent upon the sediment characteristics. There must be sufficient capacity of the current and waves to transport sediment. The amount of sediment removed from the area exceeds the amount of sediment deposited into the area. (Herbich, 1984)

Local scour occurs when an object is placed into the water column and the presence of the object disrupts the flow regime, locally accelerating the current flow. The main scouring force is a primary vortex, which forms in front of an object with respect to the current. As the velocity increases a pressure gradient is established creating a vertical fluid jet, which descends along the upstream face of the obstruction. Secondary turbulence associated with the separation vortex, along with the fluid accelerating to pass around the object, help to maintain the transport of sediment that is initiated by the primary vortex. The pressure gradient at the rear of the obstruction creates an imbalance of forces that tend to lift the sediment out of the scour pit. Downstream of the obstruction is a turbulent wake vortex plume that transports sediment away from the scour pit. Over time scour equilibrium can be achieved, as the volume of material removed from the local scour pit is equal to the volume of sediment that is introduced into the scour pit by global scour of the far field. (Herbich, 1984)

When a mine is placed on the sea floor, typically the local scour pit formed around that part of the mine resting on the bottom is shaped as a steep-sided inverted frustum or truncated cone (Lott, 1999). Small scour pits form around the extremities of the mine, and as these small scour pits enlarge, they may merge to form a scour pit surrounding the entire mine shaped like an elliptical bowl whose major axis is perpendicular to the current flow (Whitehouse, 1998). If the prevailing current, or the orbital velocities, created by wave action are great enough, the scour pit will continue to

enlarge until the remaining bearing surface under the mine lacks the compression strength to support the mine, and settling of the mine will occur. Subsequent depositions of transported sediment can infill the scour pit burying the mine.

### **C. PREVIOUS STUDIES**

Research into mine burial was initially conducted after the Korean War reinvigorated interest in mine warfare. Several experiments with MK-36 dummy mines were performed in 1952 off the Scripps pier in water ranging from 9 to 23 meters in depth. The mine located in 9-meters of water was buried sometime between 11 and 28 days after deployment. Several more experiments were performed by these researchers but all involved mines in deeper water. These experiments are the basis for continuing work on modeling scour with a vortex lattice simulation. (Inman and Jenkins, 1996)

Other research conducted in the United States during the early 1950's included a study by Lubnow in 1952 in the Gulf of Mexico near Pensacola Bay with MK-39 mines in 9-12 meters of water on a hard sand bottom with the mines burying up to 75% of the mine case in 8 weeks. McMaster, Garrison and Hicks in 1954 placed a mine in 11 meters of water on a fine sand bottom in Nantucket Sound, which was partially buried after 54 days to a depth of 33 cm. These and other studies in deeper water led the U.S. Hydrographic Office to state: "Complete burial in less than 30 days on a sand bottom is concluded to be quite unusual." (USN Hydrographic Office, 1957)

More recent studies have been conducted by both the Australian government and NATO. Mulhearn (1993) performed an experiment with a dummy mine located on a sandy bottom in 25 meters of water near Sydney, Australia. After 57 days the mine had buried itself to a maximum depth of 40% of the mine case due to scour. The NATO

command in charge of mine warfare research NG3 Subgroup 31 conducted an experiment in 1997 to validate existing mine burial models. The research area was in the North Sea off the coast of The Netherlands with bathymetry ranging from 13.5-23 meters using Dutch Burial Registration mines instrumented to record the burial depth. Over an 11-day period the mines were buried to a depth of 38 cm by scour compared to their 48 cm diameter. (Brothers, 1998)

From these studies, it is possible to predict that the scour around a mine placed in the surf zone will be more severe than in deeper water and will be of a much shorter time frame found in earlier studies. One of the goals of this experiment is to provide a more detailed picture of scour as it occurs. In the past, many studies were not able to monitor the mines during the experiments, and the results were simply what were observed once the mines were eventually recovered. In several cases, the mines were completely buried, and even though their locations were known, it was still impossible to recover them.

THIS PAGE INTENTIONALLY LEFT BLANK

### III. EXPERIMENT SETUP

#### A. LOCATION

Experiment location was primarily determined by ease of access. The Naval Postgraduate School is located in Monterey, California and is directly adjacent to the Del Monte Beach on Monterey Bay. Del Monte beach is located on the south shore of the Monterey Bay facing north and is somewhat protected from the prevailing winds and waves from the west. Waves incident to the Del Monte beach tend to be narrow-banded in frequency and direction owing to the strong refraction as they pass over the Monterey Bay Submarine canyon, and protection by Point Pinos headland and approach the beach at near normal incidence resulting in weak longshore currents. The mean beach slope is 1:40 and the mean grain size is 0.2 mm. The beach is subjected to diurnal and semidiurnal tides with mean tides of 2 meters.



Figure 1 US Geographic Survey Chart of Southern Monterey Bay with Sonar Bathymetry From [Ref USGS]

The Naval Postgraduate School (NPS) maintains the right to use of the Del Monte beach but the general public does have access to Del Monte beach. This mandated that before instituting a series of experiments in view of the public, permission should be obtained from the City of Monterey and an environmental impact statement be prepared. Coordinating through the Public Works Department (PWD) at NPS an environmental exclusion was granted by Mr. Frank Vogl, Environmental Coordinator for the PWD for the placement of the test article in the surf zone. With the approval of the Public Works Officer, heavy equipment from Public Works was placed at our disposal. Mr. Robert Yeasted, Shop Superintendent for PWD was of invaluable help in providing the use of a backhoe and a skilled operator. Prior to the first experiment it became obvious that placement of the 1000-pound test article would necessitate the use of some form of heavy machinery to not only place the shape in the surf zone but also to remove it after the experiment.

Scheduling of the experiments was primarily governed by the tides. For the experiment location to be as far out into the surf zone as possible, a negative tide would be required. For data collection purposes the lowest tide should be as early in the day as possible to collect as much data as possible during the hours of daylight. The assistance of the NPS Public Works as previously discussed was necessary and their backhoe drivers were available Mondays through Thursdays which eliminated Fridays and weekends.

## **B. TEST ARTICLE**

The item under test for the experiment was an inert MK-83 ~~shape~~. The 1000-pound shape is an exact simulation of a MK-83 general-purpose bomb in dimensions and

weight. The shape is 206 cm long and 35 cm in diameter with two standard shackles for attachment to a 16-inch bomb rack. The shape was also equipped with a small fitting to support an eyebolt that was screwed into the nose cavity of the shape where normally the fusing and arming device would be installed. The aft section of the main body of the shape also had an eyebolt attached to the mounting bracket normally used for the installation of stabilizing fins. Both of these fittings were of great benefit in handling the shape. For the purposes of this test the shape was painted bright yellow for high visibility. To allay any fears that we were transporting what appears to be a large bomb, the shape is also appropriately labeled with large black lettering stating that it is, in fact, inert. The MK-83 is in widespread use by the US military for deployment from fixed wing aircraft. The US Navy and Marine Corps employs the weapon from both tactical carrier based assets such as the F/A-18 Hornet and land based aircraft such as the P-3 Orion. When deployed for use in the mine role, the weapon becomes the MK-63 Destructor, which is a bottom mine designed for use against ships, submarines and landing craft. To convert the MK-83 bomb to the MK-63 Destructor requires the fitting of an actuation device in the nose of the weapon in place of the standard fuse and arming mechanism. The actuation device can be of the magnetic, acoustic or pressure type, or a combination of the different types. Because it is designed as a bottom mine with the potential for burial in sediment either from impact or subsequent settling, both pressure and acoustic sensor can be attenuated by burial; the most common type of actuator used is of the magnetic variety.

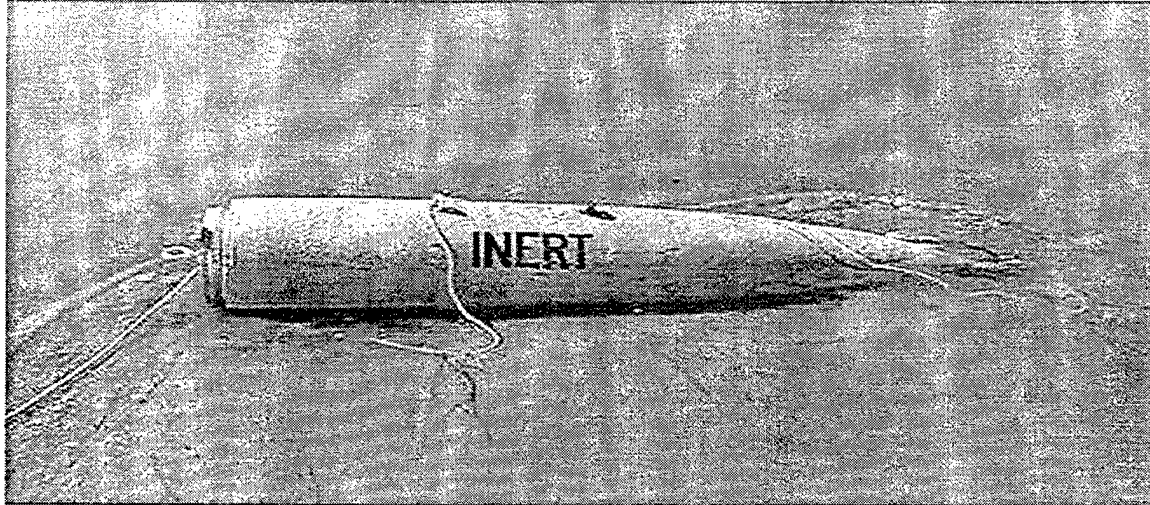

Figure 2 MK-83 inert shape deployed in the surf zone simulating a MK-63 Destructor

Transporting the MK-83 shape to the Del Monte beach test site proved to be challenging due to the soft sand and the combined weight of the shape and the custom built tow trailer. Using a John Deere Gator, a small all terrain 6-wheel vehicle with 4-wheel drive powered by an 9 horsepower engine, it was possible to tow the trailer and shape down to the test site, but transporting the combination up from the beach on the return trip proved impossible without the help of a suitable tow vehicle. Using the standard shackles attached to the shape for handling purposes, it was possible to lift the shape from the trailer with chains attached to the bucket of the backhoe. Initial fears of backhoe being unable to maneuver in the wet sand on the edge of the surf zone proved to be unfounded.

### **C. INSTRUMENTATION**

Detailed knowledge of the surf conditions was required to be able to quantify the forces exerted on the sand bed and upon the test shape. Primarily the velocities of the water and entrained sediments in all three directions were required. The hydrostatic

pressure of the water column that is exerted on the sand bed and the height of that water column are important variables in determining the scour around an object. To fulfill these requirements, a Sontek Acoustic Doppler Velocity (ADV) instrument was mounted onto a test stand to collect data. The Sontek ADV is a three-beam acoustic instrument that is capable of measuring velocity components. In addition, the ADV measures pressure, temperature, compass heading, pitch and roll, signal strength, signal correlation and time code for the logging the data. The battery-powered unit consists of two modules, the sensor module that is connected to the data collection and battery pack module via an umbilical cable. Data is collected and logged at a rate of 4 Hertz.

The ADV was mounted on a pipe test stand jettied several meters into the sand bed directly adjacent to where the shape was to be placed. (Figure 3) After the completion of the experiment, the ADV data was downloaded onto a PC into separate ASCII time series files.

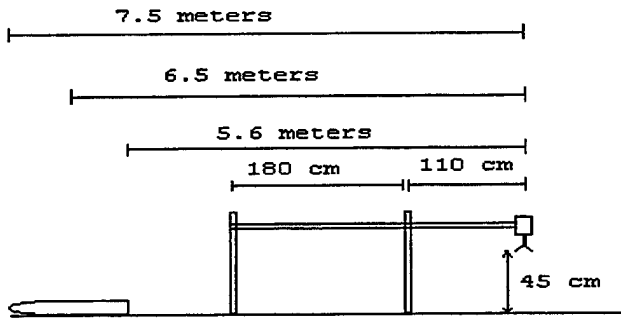

Figure 3 Test Stand Construction and Dimensions including MK-83 shape location on 22 May 2000

A Sony Digital video camcorder mounted in an underwater camera housing was used to collect video and still imagery. Underwater photography was required during the high tide phases when the shape was completely submerged. The video data was

downloaded via an I-Link cable from the Sony camcorder to a MoTo video card installed into a PC. Using the MoTo video card and software it was possible to capture short segments of video from which still images could be saved as JPG files.

To determine the depth of the scour while the shape was deployed, multiple measurements referenced to the shape itself were obtained to determine both the extent and the depth of the scour around the shape. Due to the large weight of the shape, it never exhibited any tendency to roll or displace itself laterally during the experiments. Using the fore and aft eyebolts and the shackles on top of the shape for consistent reference, it was possible to make measurements at the same points at different times.

#### **D. SECOND EXPERIMENT SETUP**

Improvements were made in collecting data based on the experience of the first experiment. Measuring the extent and the depth of scour was not enough to determine a total volumetric rate of scour. To determine volumetric scour rate, the depth of scour at numerous data points around the shape and the profile of the scour area has to be measured and not just the lateral extent. While the tide was still low and the shape was nearly exposed on the beach, it was relatively easy to take extensive measurements of the profile of the scour area and the depth at several points around the shape. To facilitate the taking of accurate measurements, a 1-meter by 0.5-meter sheet of white Plexiglas with a 35-cm diameter cutout for placement against the shape was utilized. With a 10 cm grid drawn on the Plexiglas sheet it was possible to place it in the water perpendicular to the shape and to partially imbed it into the sand. Once in place, a tracing of the scour profile could be drawn onto the sheet. Using different color waterproof grease pencils, several profiles at different locations along the shape were produced during a single data

collection foray into the surf zone. Once back on the beach proper, the profile measurements were transcribed from the Plexiglas sheet onto the data collection sheets at 10-cm intervals. This technique was effective when the surf was not breaking on top of the shape location. When waves were breaking, the size of the rigid Plexiglas sheet made it difficult to handle in the water as it tended to driven sideways into the shape instead of perpendicular.

The first experiment demonstrated that the large iron mass of the shape did not appreciably affect the magnetic compass of the Sontek ADV. For the second experiment it was decided to place the ADV closer to the shape to provide more accurate readings of the velocity field of the surf without being too close to the shape where the readings would be affected by the presence of the shape. For this reason the instrument stand was reversed with the ADV mounted on the stand on the side adjacent to the shape location. Both the instrument stand and the shape were placed parallel to the beach. The test stand was at about LLW, 113meters from the fence behind the beach and directly in front of the Del Monte beach laboratory for NPS for both experiments, in an effort to minimize variables from one experiment to the next.

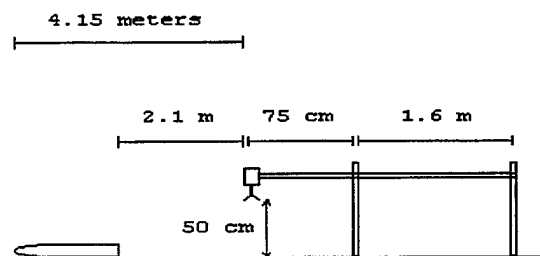

Figure 4 Instrument test stand dimensions for the 2 Aug experiment

**THIS PAGE INTENTIONALLY LEFT BLANK**

## IV. RESULTS

### A. PRELIMINARY EXPERIMENT

During the 22–23 May 2000 experiment, the instrumentation stand was installed by 0810 and 15 minutes was allowed for the ADV to obtain a compass reading prior to placement of the MK-83 test shape. This was due to concerns that the large mass of steel in the shape's casing and close proximity to the Sontek ADV would alter the magnetic compass contained in the ADV. The MK-83 shape was placed parallel to the shoreline into the surf zone at extreme low tide of minus 0.06 meters, which occurred at 0823. This location was about 40 meters seaward from the high water mark from the preceding high tide of 1.55 meters.

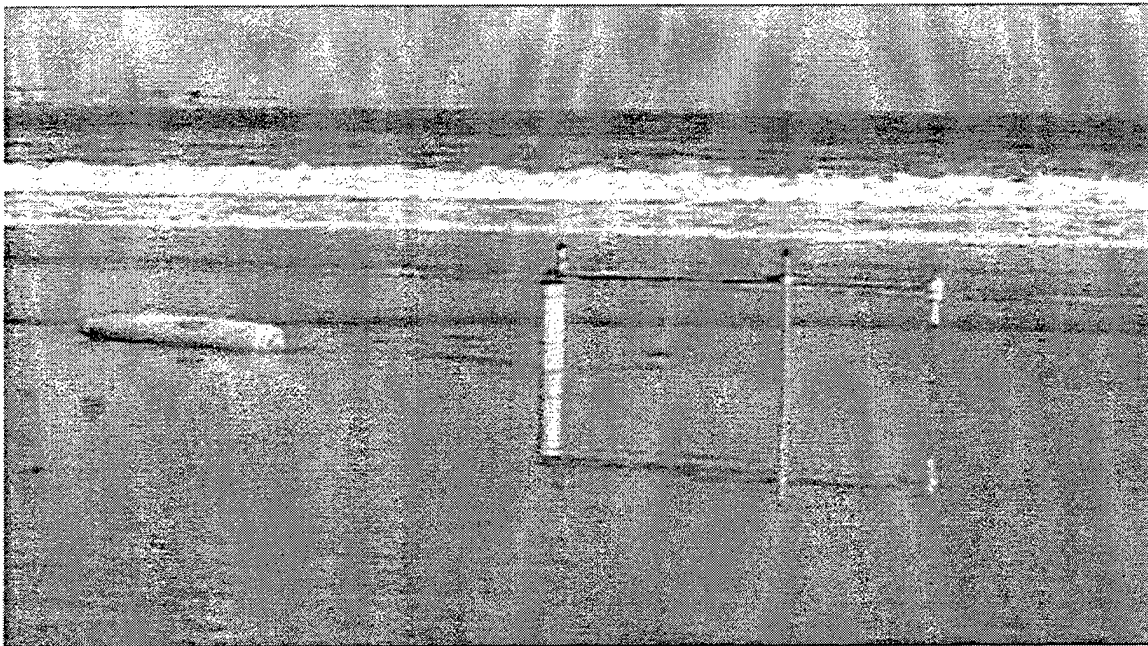

Figure 5 Test Stand with Sontek ADV and MK-83 test shape to left of stand - 22 May 2000, 0845

With the shape standing fully proud above the sand bed and the swash from the incoming waves extending several meters inland from the shape, the initial scour began

to develop. Data collection began with an initial videotaping of the instrument stand and layout of the shape and measurements of the scour area and depth.

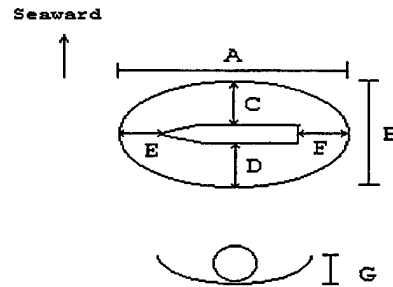

Figure 6 Diagram of MK-83 Shape with General Outline of Scour Formation and Dimensional Designation For Data Collection

Table 1 Scour survey results for 22-23 May experiment.

Time	Major Axis A	Minor Axis B	Distance C	Distance D	Distance E	Distance F	Depth G
0900	247 cm	66 cm	16 cm	15 cm	10 cm	31 cm	6 cm
0930	266 cm	95 cm	30 cm	30 cm	30 cm	30 cm	13 cm
1000	266 cm	95 cm	30 cm	30 cm	30 cm	30 cm	16 cm
1100	326 cm	215 cm	90 cm	90 cm	60 cm	60 cm	18 cm
1200	336 cm	250 cm	85 cm	130 cm	55 cm	75 cm	20 cm
1300	376 cm	260 cm	130 cm	95 cm	75 cm	95 cm	20 cm
1400	336 cm	235 cm	100 cm	100 cm	60 cm	70 cm	20 cm
1500	331 cm	235 cm	100 cm	100 cm	60 cm	65 cm	20 cm
1600	326 cm	255 cm	110 cm	110 cm	55 cm	65 cm	20 cm
1700	316 cm	250 cm	100 cm	115 cm	50 cm	60 cm	20 cm
1800	321 cm	250 cm	105 cm	110 cm	55 cm	60 cm	20 cm
1900	321 cm	235 cm	100 cm	100 cm	50 cm	65 cm	20 cm
23 May							
0630	356 cm	255 cm	110 cm	110 cm	75 cm	75 cm	23 cm
0730	271 cm	195 cm	80 cm	80 cm	30 cm	35 cm	24 cm
0830	241 cm	115 cm	40 cm	40 cm	15 cm	20 cm	25 cm

The general outline of the scour area is displayed in Figure 6, with the dimensions labeled for reference in Table 1, which lists the survey results for the 22-23 May experiment. For this first experiment, the data collection plan was to physically survey the extent of

the scour every hour and to videotape the MK-83 shape for later analysis. Extra data were collected during the early stages of the experiment for several reasons. With the tide out, the shape was easily accessible for detailed data collection with little trouble from breaking surf. Second, the area of scour surrounding the shape grows quite rapidly after placing the shape in the surf zone. Additional data on this aspect of the scour rate would be useful in the final analysis.

Qualitative observations during the first stages of the scour development were that the area of the beach affected by the disturbance in the normal flow of water created by the shape was small initially, but grew rapidly to its ultimate dimensions. Thirty minutes after shape deployment, the scour extended laterally less than half the diameter of the shape and the shape had sunk 6 cm into the sand bed. Thirty minutes later the scour had doubled to nearly a full diameter from the shape (~30 cm), and the shape had settled appreciably, with the depth more than doubling to 13 cm. The rate of scour at this stage was geometric in nature but could not be sustained for an extended period. Over the next hour the tide rose slowly with the ADV on the instrument stand just being struck by the tops of the waves at 1030, or two hours into the experiment, indicating that the maximum depth of water over the shape was on the order of 35 centimeters. Surprisingly the shape was nearly half buried at this point in the experiment as it settled into the sand bed to 18 cm by 1100, only two-and-half hours after deployment. By this time the extent of the scour around the shape was fully developed and would not increase much beyond 1-meter from the shape or three times the shape diameter.

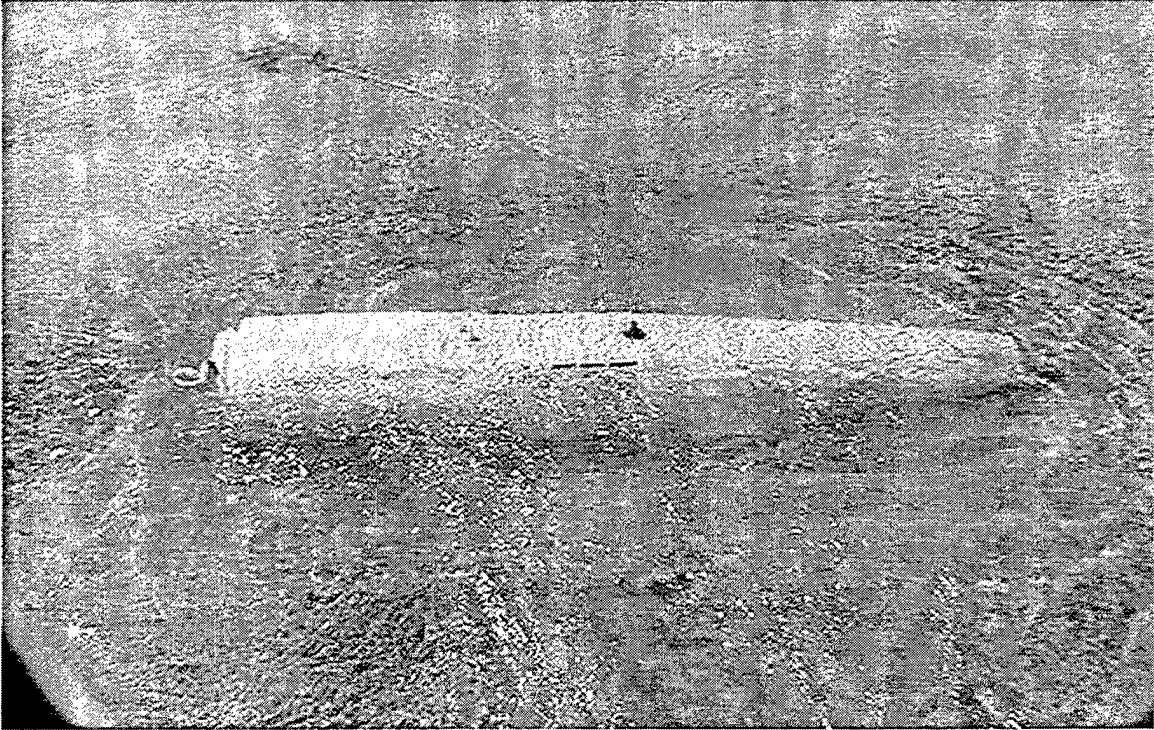

Figure 7 Extent of Scour, 1030 22 May 00

After 1100 the area and depth of the scour continued to grow but at a slower rate than previously. As the tide continued to rise the area around the shape would be partially filled and then re-excavated. This was most evident on the seaward side of the shape, where sand would have a tendency to fill in and then erode towards the mid-body of the shape. The apparent cause was the juncture of the vortices formed on both ends of the shape. Waves breaking seaward of the shape created a prevailing flow of water and sediment towards the seaward side of the shape. This can be seen in the data listed in Table 1 as the minor axis grows to a maximum of 260 cm at 1300 and then decays and vacillates between 235 cm and 255 cm over the course of the afternoon. During this time frame, the shape was typically supported at both ends and in the middle with some sand being completely excavated from underneath the shape in the first meter of the thick body section and from under the conical section of the nose. (See Figure 8) The depth of the

water space between the shape and the underlying sand bed in these gaps ranged from 2 to 4 cm. These spaces underneath the shape would persist for an hour or more before being filled-in. During this period, there seemed to be little pattern to the appearance or disappearance of the scour underneath the shape. The depth of the shape did not change greatly with the appearance of the scour holes underneath the shape, but one would have to conclude that this is certainly a mechanism for the scour to cause the complete burial of the shape. The shape retained its upright orientation throughout the experiment and did not exhibit any rocking or rolling motion, both of which could be mechanisms that would cause the shape to settle into a scour hole. Rolling has been identified in deeper water scenarios, where direct, more constant currents prevail.



Figure 8 MK-83 Shape - Scour on seaward side with scour hole under after body - 1330 22 May 00

High tide occurred at 1550, height 1.1 meters, with some of the incoming wave trains breaking directly over the instrument stand and the shape. Conducting manual

surveys of the scour were difficult during these conditions. With waves breaking directly overhead, the scour around the shape exhibited the greatest depth, with a hole underneath the first one-meter of the body of the shape extending 5 cm below the shape. During this period, the area of the scour was close to the maximum extent observed. The turbulent water created large quantities of suspended sediment in the water with the surface of the sand bed fully liquefied and highly mobile, causing the scour around the shape to fluctuate between further scour and being filled. This condition prevailed for the remainder of the afternoon. The landward side of the shape was nearly fully exposed while the seaward side of the shape was filled in along the mid-body section with a scour hole under the after-body. (Figures 9 and 10.)

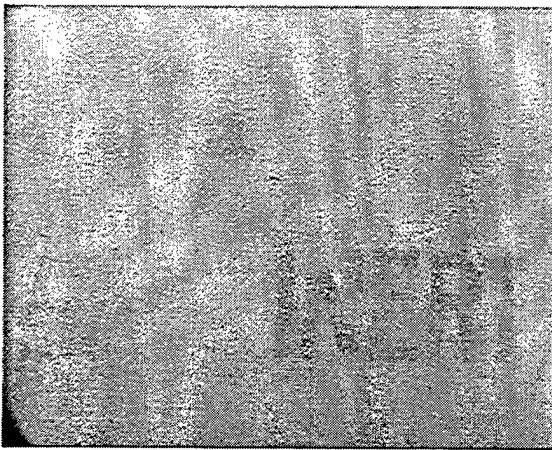

Figure 9 MK-83 Scour on Landward side – mid-body section 1600 – 22 May 00

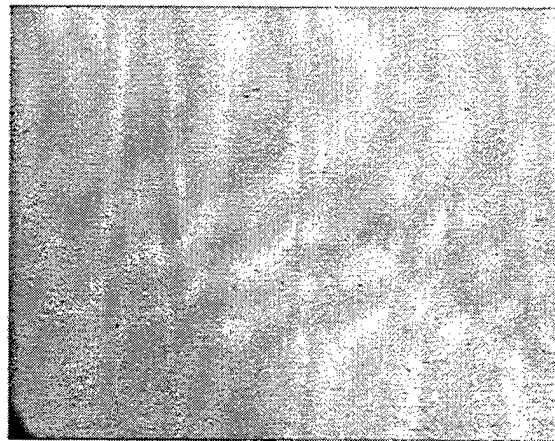

Figure 10 MK-83 - Scour on Seaward side - mid-body section looking aft - 1600 - 22 May 00

The video was not usable after 1900 due to the low light and the amount of sediment in the water column. Scour measurements were taken until the hours of darkness prevented any measurements, primarily due to safety concerns with entering the surf zone at night in close proximity to the test stand.

On 23 May 00 at 0630, the shape remained proud of the surface but had settled deeper into the sand bed overnight. It rapidly became apparent that the outgoing tide was causing the existing scour hole to be filled in. As the swash from the incoming waves passed over the shape there was noticeable scour under the nose section of the shape and the back wash flowing back down the beach face was filling in the surrounding scour area. With only 10 cm of the shape exposed above the beach face the shape was exhibiting markedly less influence over the flow field of the swash, and this can be seen in the much smaller major and minor axis data as low tide approached on 23 May. (See Figure 11 for photo taken at 0800.)

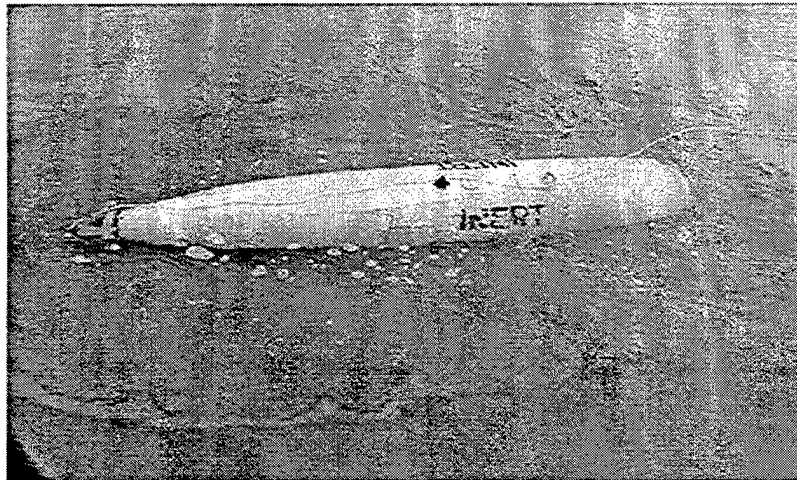

Figure 11 MK-83 Shape Extent of Scour - 0800 - 23 May 00 - One half hour prior to shape retrieval; note the scour around the nose section and the fill around the after body.

Unfortunately the logistics for removal of the instrument stand and the recovery of the shape from the surf zone were already set in motion. It would have been desirable to observe the completion of the burial of the shape but the only opportunity to remove the shape from the surf zone came once a day, as only at extreme low tide could the backhoe reach the test site to perform the retrieval. Even though the shape was not completely buried in the 24-hour run of the experiment, good data were collected.

## **B. SECOND EXPERIMENT**

The second experiment was conducted on 2-3 Aug 00 at the same location as the first experiment. High water mark from the preceding nights high tide of 1.9 meters was 60 meters from the instrument stand. The high water mark also coincided with a small sand berm formation on the beach. To be consistent as possible the shape was again placed in the surf zone parallel to the beach and the incoming waves. In both cases the shape was pointed west.

Extreme low tide of negative 0.24 meters was at 0706 on 2 Aug, with placement of the shape into the surf zone at 0755. Initially the shape was just being exposed to the swash when it was placed on the sand bed. These conditions were similar to the first experiment and the resulting scour in the first hour was consistent with the first experiment.

Data collection for the second experiment differed from the first in that the goal was to obtain more detailed manual survey information concerning the depth of the scour at various points around the shape. Additional data was desired on the profile of scour and not just the lateral extent and depth. The profile was necessary to provide a more complete picture of the volume of sand being scoured from around the shape and the

subsequent filling of the scour as the shape was completely buried. As discussed in the instrumentation section a rigid Plexiglas sheet was used to trace out (in situ) the profile of the scour at various points along the shape. The depth and profile of the scour relative to the shape could be measured back on dry land with a greater degree of precision than trying to measure a large number of data points in the surf zone. Data for the extent and depth of the scour were collected the same as the in the first experiment and is presented in the same format in Figure 12 and in Table 2.

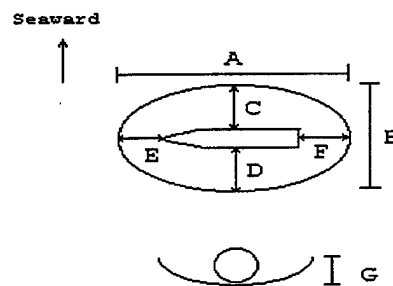

Figure 12 Diagram of MK-83 Shape with General Outline of Scour Formation and Dimensional Designation For Data Collection

Table 2 Scour survey results for 2-3 Aug experiment.

Time	Major Axis A	Minor Axis B	Distance C	Distance D	Distance E	Distance F	Depth G
0900	256 cm	75 cm	20 cm	20 cm	20 cm	30 cm	15 cm
1000	296 cm	195 cm	80 cm	80 cm	30 cm	60 cm	18 cm
1100	306 cm	215 cm	90 cm	90 cm	45 cm	55 cm	19 cm
1200	306 cm	230 cm	95 cm	100 cm	50 cm	50 cm	19 cm
1300	306 cm	235 cm	100 cm	100 cm	50 cm	50 cm	20 cm
1400	326 cm	270 cm	110 cm	125 cm	55 cm	65 cm	23 cm
1500	321 cm	255 cm	100 cm	120 cm	55 cm	60 cm	23 cm
1600	341 cm	240 cm	90 cm	115 cm	70 cm	65 cm	25 cm
1700	351 cm	245 cm	110 cm	100 cm	75 cm	70 cm	25 cm
1800	346 cm	255 cm	115 cm	105 cm	70 cm	70 cm	25 cm
3 Aug							
0630					Total	Burial	45 cm

The most notable difference between the two experiments is that the shape was completely buried in the second experiment, 10 cm below the surface of the sand after 22 hours of being deployed. This effectively terminated the experiment negating the need for the planned second day of data collection. This was somewhat of a surprising development since the amount of scour observed during the day on 2 Aug was quite similar to the patterns observed during the first experiment. The depth of the scour and the resulting settling of the shape into the sand bed were greater than that on 22 May. The extent of the scour was nearly the same. Initial stages of scour development during the first hour of the experiment were similar to that observed previously, with the scour growing rapidly in extent, and the depth of the scour doubling from the first half hour to the hour mark. As in the first experiment, the scour around the shape achieved somewhat of stable condition in depth with the extent of the scour fluctuating around an average value. In both cases this occurred during the high tide in the afternoon.

The qualitative observations of the scour for the first experiment can nearly be duplicated for the second experiment. The behavior of the scour field around the shape was not significantly different from one experiment to the next. There were of course some quantitative differences between the two, but in the overall scheme, the magnitudes of these differences were relatively minor. For this reason it would be appropriate at this point to discuss the data analysis performed upon the more detailed manual survey data collected during the second experiment and the results that were achieved from processing the data.

### C. DATA ANALYSIS OF THE SECOND EXPERIMENT

Using the detailed manual surveys from the 2-3 Aug experiment it was possible to construct a three-dimensional surface graph of the observed scour. From these graphs it is possible to get a reasonable estimate of the volume of scour around the shape and the manner in which the volume changed over time. A 3-D array of evenly spaced grid points was obtained using Delaunay triangulation. This produces a set of triangles connecting the data points such that no data points are contained within any triangle. (Hanselman, 1998) A representative plot of the resulting triangles using the scour data from 0900 on 2 Aug is shown in Figure 13.

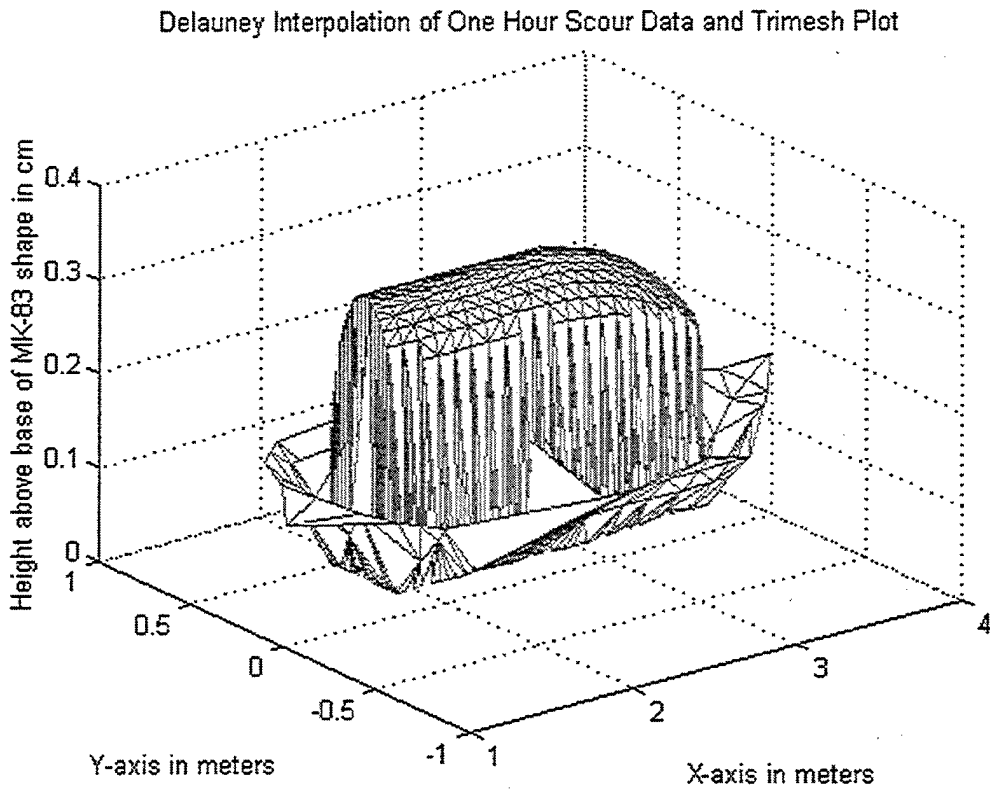

Figure 13 Trimesh Plot of Interpolated Data for Scour after One Hour

Cubic interpolation was used to interpolate the Delaunay triangulation to create interpolated points on a rectangular grid. The resulting surface plot of the scour around the shape after being in the surf zone for one hour is shown in Figure 14. Included is the MK-83 shape since the measurements of the scour are all relative to the shape itself, and the scour field is related to the size of the shape.

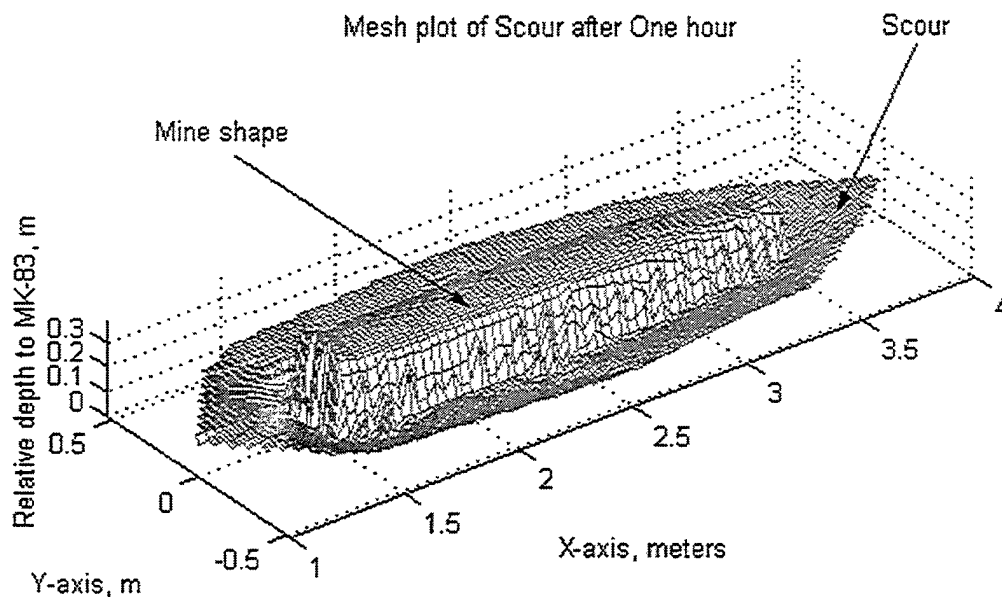

Figure 14 Surface plot of MK-83 Shape and Scour after One Hour of Deployment on 2 Aug 00

The three-dimensional surface plots provide a better means of visualizing the amount of scour around the shape and are more quantitative than photographs alone. This is especially true during the latter stages of both experiments when a single photograph of suitable quality was not available to illustrate the amount of scour present around the shape. As the water depth increased and the breaker line approached the test

location, the resulting turbidity and reduced visibility necessitated close-up videotaping of the shape and scour. Downloading a number of images from a video survey produced a montage of photos of the scour, but the array of photos from each survey was difficult to assemble in a meaningful way for reader consumption. These photos were nonetheless very useful in providing data for comparison with the manual surveys and to provide additional data points, since the scour was measured relative to the shape and all the dimensions of the shape were well known. Using only the photo surveys to calculate the total volume of scour would have been extremely difficult. To demonstrate that the resultant plots were in agreement with the actual measured scour conditions, a photograph from the 2 Aug experiment (depicting the entire scour field after three hours of deployment) is shown in Figure 16. Which can be compared to the Matlab generated surface plot of the scour field using the manual survey data, Figure 15. The two are similar in appearance, particularly considering the lack of perspective in the Matlab generated plot.

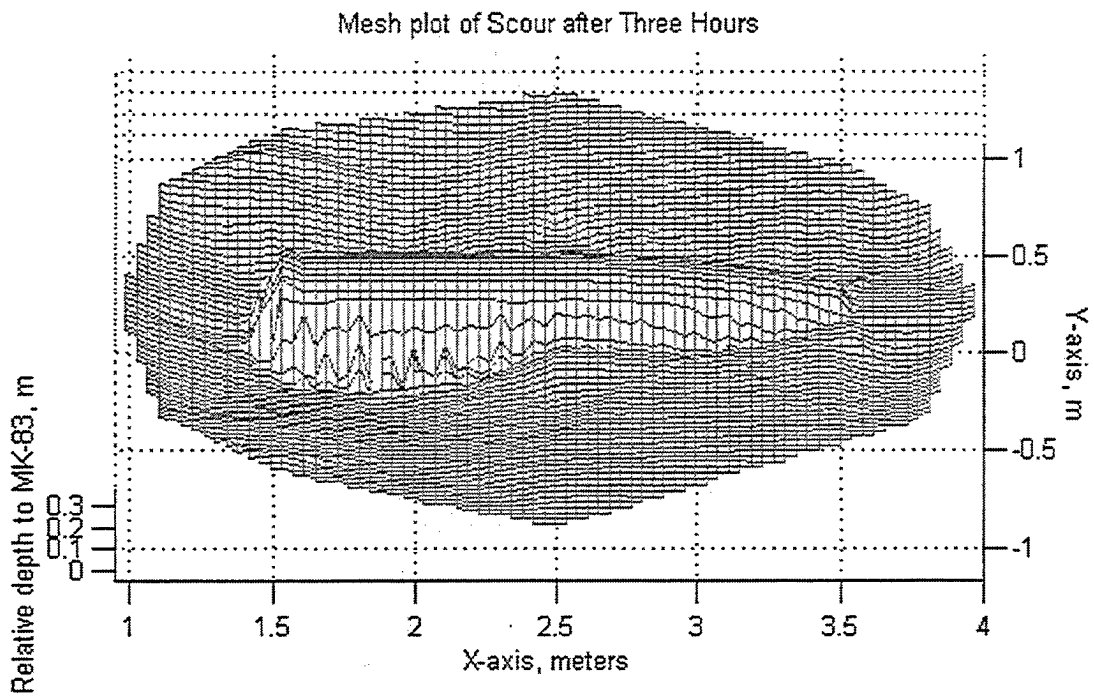

Figure 15 Surface plot of MK-83 Shape and Scour after Three Hours of Deployment on 2 Aug 00



Figure 16 Photo of MK-83 and Scour after Three Hours of Deployment on 2 Aug 00

The volume of sand removed by scour versus time relative to the volume of the MK-83 shape was calculated from surface plots of the scour pit. The scour produced by an object is directly related to the size of the object. The total volume of the MK-83 shape is 0.1622 cubic meters; the scour volume relative to the volume of the shape is displayed in Figure 17. The data gaps between 3 and 7 hours were due to the high sediment content in the water column during these times, which made both measurements and especially photography very difficult. Despite the limited data points, the data still provide a reasonable picture of what occurs to a mine as it becomes buried.

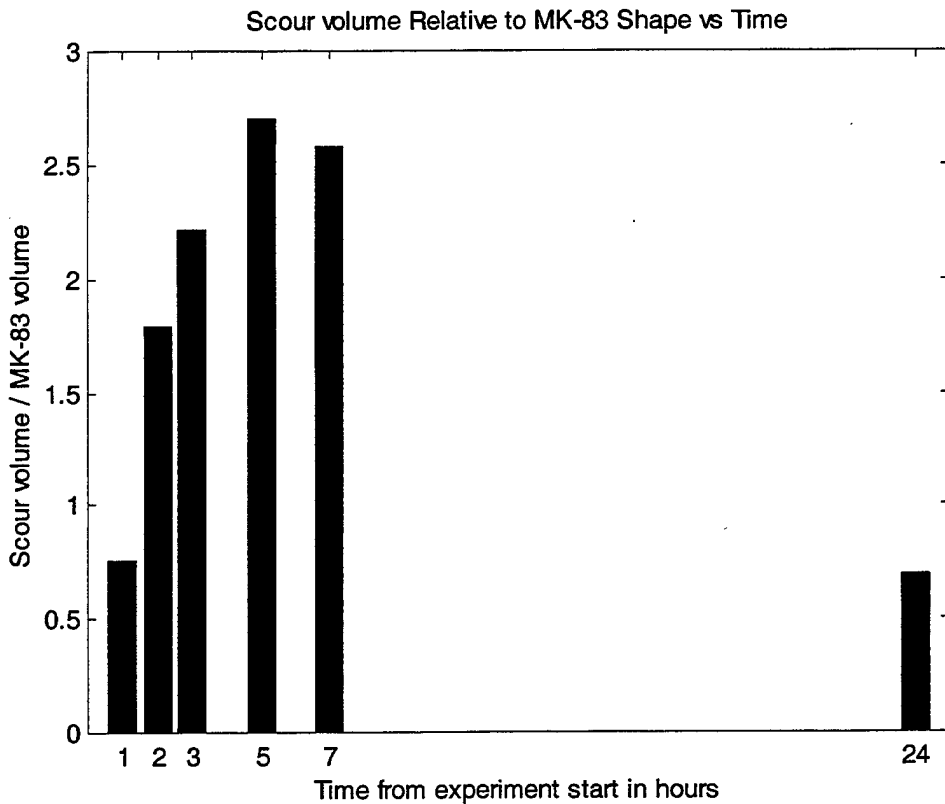

Figure 17 Scour Volume Relative to MK-83 Volume versus Time in Hours

The volumetric rate of scour divided by the MK-83 volume was calculated as the difference in scour volume between consecutive measurements divided by the time

interval between the measurements and is shown in Figure 18. The highest volumetric rates of change are to be found during the initial stages (hours one and two) of the deployment, with the rates decaying rapidly as the elapsed time increased.

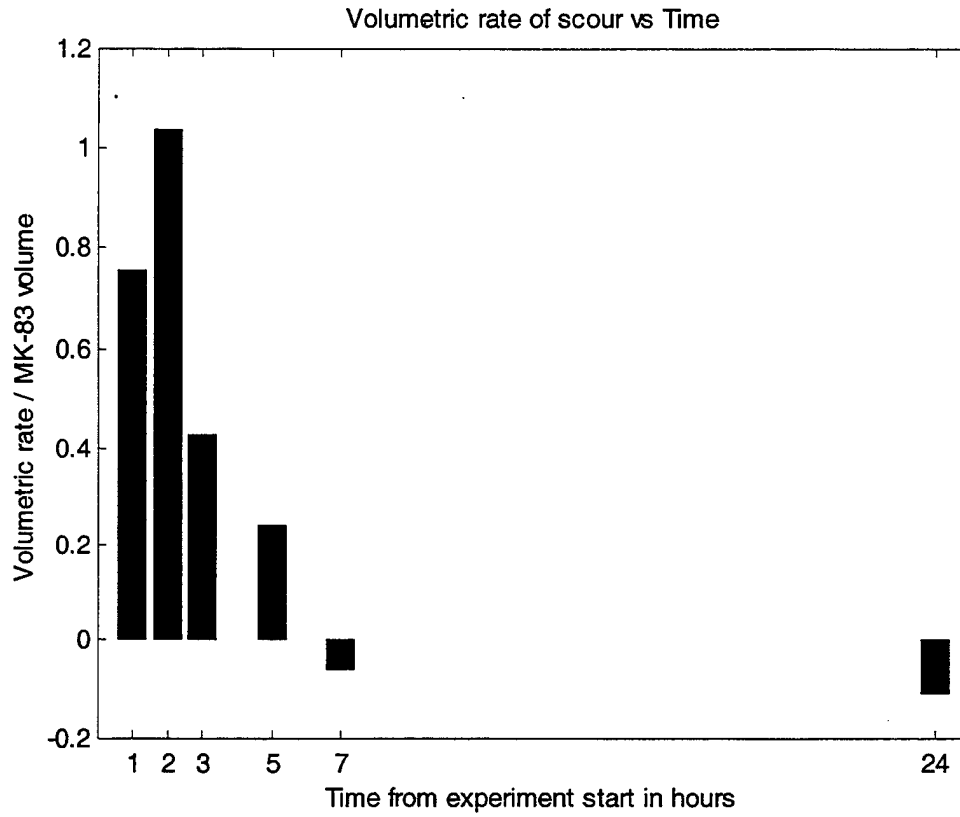

Figure 18 Volumetric Rate of Scour over Time

## V. ENVIRONMENT

### A. PREVAILING CONDITIONS

Standard meteorological data from Station 46042, a 3-meter discus buoy maintained by the National Oceanic and Atmospheric Administration (NOAA) is available from the National Data Buoy Center (NOAA, 2000). Station 46042 is located in the center of Monterey Bay approximately 30.5 nautical miles to the northwest of the experiment site on Del Monte beach. This buoy provided useful information on the prevailing swell conditions at the mouth of Monterey Bay, similar to data that is available to a mine warfare planner.

Table 3 Averaged meteorological data for Wave Height, Period and Direction

Date	Significant Wave Height	Dominant Wave Period	Average Wave Period	Mean Wave Direction
22 – 23 May 2000	2.3 meters	9.5 seconds	6.7 seconds	315 degrees
2 – 3 Aug 2000	1.7 meters	13.1 seconds	7.7 seconds	225 degrees

The average data for the twenty-four hour periods covered by the experiments is presented in Table 3. Significant wave height is the average of the highest one-third wave heights. Dominant wave period is the period with the maximum wave energy and the average wave period is the average for all waves during each 20-minute period. Mean wave direction corresponding to the energy of the dominant wave period is given in degrees referenced to true North.

The 22-23 May experiment experienced the slower rate of scour, with the mine not completely buried after 24 hours but experienced the higher significant wave height of the two experiments. Prevailing swell direction was from the northwest. The Del Monte beach experiment location is sheltered from the west and southwest directions

by the Monterey peninsula and is exposed to wind and wave action from the northwest. During the 2-3 Aug experiment the significant wave height was less than during the first experiment but the dominant and average wave periods were both longer. However, the prevailing direction was from the southwest, which means that the Monterey peninsula refracted the waves before the waves broke onto Del Monte beach.

## B. SHIELDS PARAMETER

The Shields parameter is a measure of the total shear stress on the sand bed relative to the restoring force of gravity acting on the sand grains, and is often used in scour research. The best representation of the forces exerted by the 3-D velocity field data collected by the Sontek ADV on the sand bed is the Shields parameter. The Shields parameter is defined (Soulsby, 1997) as:

$$\theta = \frac{1/2 \times f_w \times U_w^2}{g \times (\rho_s / \rho - 1) \times D_{50}}$$

$\theta$  = Shields parameter

$f_w$  = Friction factor - 0.1

$U_w^2$  = Total magnitude of the water velocity squared ( $x^2 + y^2 + z^2$ )

$g$  = Force of gravity 9.81 meter/second

$\rho_s$  = Density of sand - 2650 kg/m<sup>3</sup>

$\rho$  = Density of seawater - 1027 kg/m<sup>3</sup>

$D_{50}$  = Sand grain average diameter - in mm - 1.5 mm for fine sand

The Shields parameter along with the root-mean-squared (RMS) pressure from the sensor on the ADV for the 22-23 May experiment is depicted in Figure 15. The pressure measurement clearly shows the tidal signature. The Shields parameter does not show much influence due to the tide. During the first high tide at 1530 the Shields parameter increases, but actually declines during the high tide at 0100 on 23 May. Orbital velocities of water particles in the water column due to waves decrease in magnitude with

increasing water depth. The decline of the Shields parameter during the high tide at 0100 is most likely due to this type of attenuation.

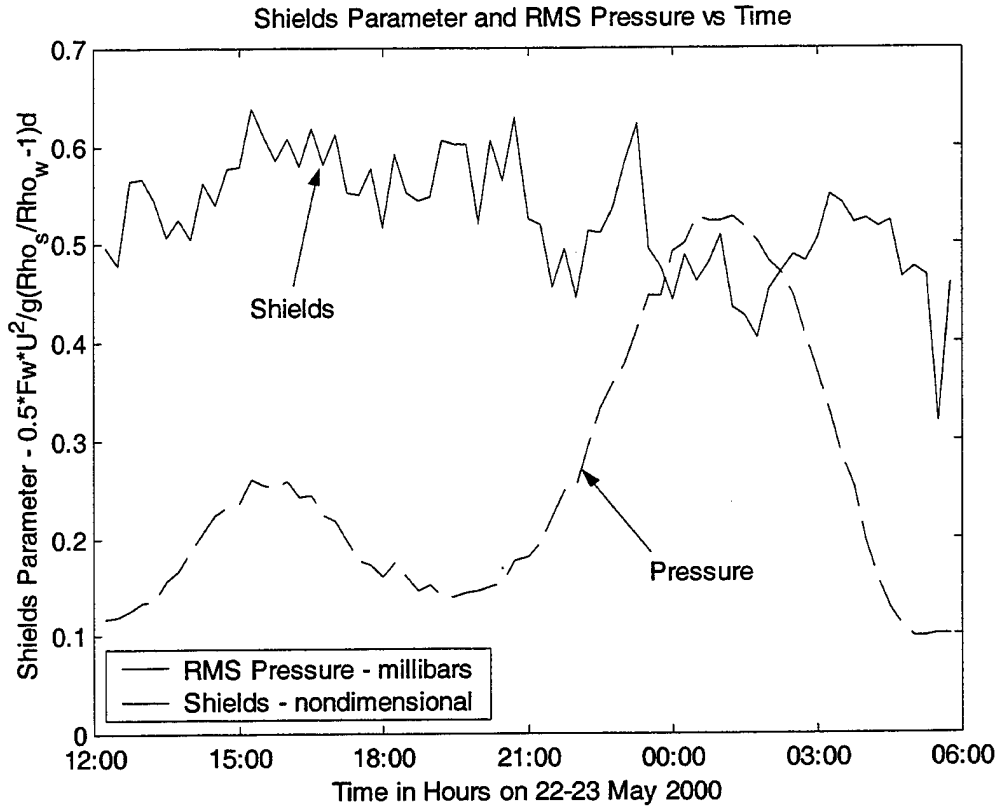

Figure 19 Shields Parameter and RMS Pressure versus Time for 22-23 May 2000

The critical value for the initiation of sediment transport is approximately 0.04. The critical Shields parameter was exceeded by an order of magnitude throughout the experiment. During the low tide portions of the experiments, when the ADV was unable to record data, the swash on the beach was more than sufficient to cause scour as is evident in the volumetric scour rate during the first hours of the experiment. The Shields parameter was not appreciably different during the 2-3 Aug experiment. The greater tidal excursions on 2-3 Aug meant that the ADV was only able to record during the high tides,

when it was submerged, with a data record of less than 7 hours. This data set is not presented, as the longer data record from 22-23 May is more illustrative.

### **C. BEACH PROFILE**

During the experiments, the overall beach profile changed. The experiment stand was used as a reference level to measure elevation changes of the beach at the experiment location. The vertical pipes supporting the test stand exhibited minimal scour around them, (less than 3 cm) and this scour appeared to have no effect on the level of the sand bed under the test stand. The beach elevation decreased by 10 cm on 22-23 May and 15 cm on 2-3 Aug. Both experiments were performed during similar tidal ranges that were greater than normal for the Del Monte beach.

## VI. CONCLUSIONS

### A. SUMMARY

The experiment was successful in determining the volumetric rate of scour for a mine deployed in the surf zone. A MK-83 mine deployed into a surf zone with a sand bed can be expected to be completely buried. The time frame for complete burial, depending upon conditions, will be on the order of one day. Based upon the measurements made during this experiment, with a mine deployed on an exposed beach during a low tide, it can be expected that in the first 2 – 3 hours, the mine may create a relative volumetric scour rate of up to 1 times the volume of the mine per hour. The rapid initial scour rate may decrease during the rising tide and the mine may experience the maximum amount of scour shortly after the semi-diurnal high tide at 6-hours from deployment. After this time the scour changes from removal to fill and the mine with the accompanying scour pit will slowly be filled until the mine is completely buried one day after deployment. The Shields parameter did not change significantly over time, and actually decreased with increasing water depth. The mine initially resting on the flat sand bed accelerates the prevailing flow field and begins to create a scour pit. As the mine settles deeper into the scour pit the flow field is altered by the changing profile presented by the mine and its associated scour pit. The evolving geometry of the combination of scour pit and mine has a greater effect on volumetric scour rates than changes in the prevailing flow velocity.

It is important to realize that this research constitutes an initial effort to produce data that can be used to validate mine burial prediction or forecasting models. Data that was generated during and after the Korean War are being used today in some mine burial

models that are useful in deeper water environments. None of the mine burial models that have been developed to predict scour are designed for use in the very shallow water environment (Lott, 1999). Much of the existing experimental data for mine burial does not include a record of the complete burial and the effects of scour during the burial. Most of the models used to simulate mine burial do not simulate scour as a time dependant process. More advanced models are being developed to use a time stepped simulation of scour which could take advantage of the results that are presented here.

## **B. FURTHER RESEARCH**

Conducting experiments in the surf zone is a very challenging proposition. Manual surveys of the scour surrounding the shape were very useful, but at times it was either quite difficult to gather accurate data or impossible to gather data at all due to the prevailing surf conditions. Visibility was also a factor when videotaping or photographing. As the depth and the turbidity of the water increased with the advancing of the breaker line due to the incoming tide, the ability to obtain clear photographs declined. A frame with a remotely operated camera with lights to record the scour and depth of the mine would be a possible improvement.

There still remains the problem of accurately measuring the scour pit surrounding the mine. Rotating sonars are presently used to scan small-scale morphology to obtain 3-D images of bed forms. However, the sonars must be completely submerged and bubbles due to breaking waves degrade the signal, limiting their application in the surf zone. Of more immediate help in measuring the scour pit around a mine in the surf zone would be a series of reference rods or poles jetted into the sand in a grid around the mine.

The reference rods could be used to measure the scour profile relative to the mine, and also any overall beach subsidence or infilling.

The results reported here should be useful in providing information for further research into mine burial in the very shallow water regime that includes the surf zone. Improving the current mine burial prediction models will require more research into the effects of scour and other burial mechanisms. Validation of mine burial prediction software could be accomplished in a shorter time period by using test mines in the very shallow water and surf zone regime, thus making validation tests more efficient and cost effective.

**THIS PAGE INTENTIONALLY LEFT BLANK**

## APPENDIX. SCOUR PLOTS

The following plots are the complete time series of 3-D computer generated plots depicting the scour around the mine.

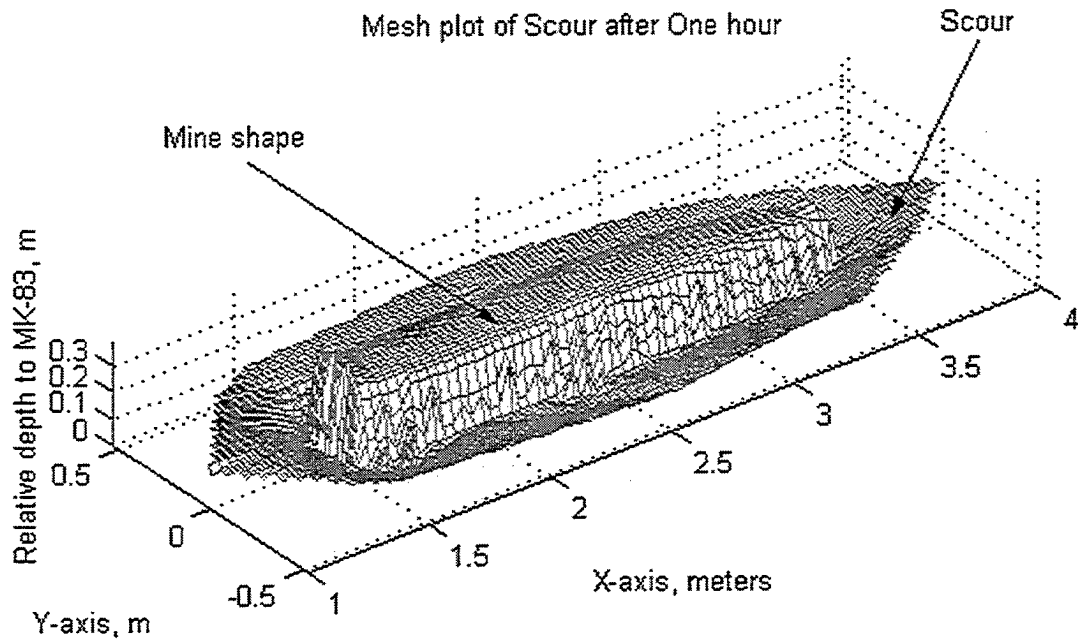

Mesh plot of Scour after Two hours

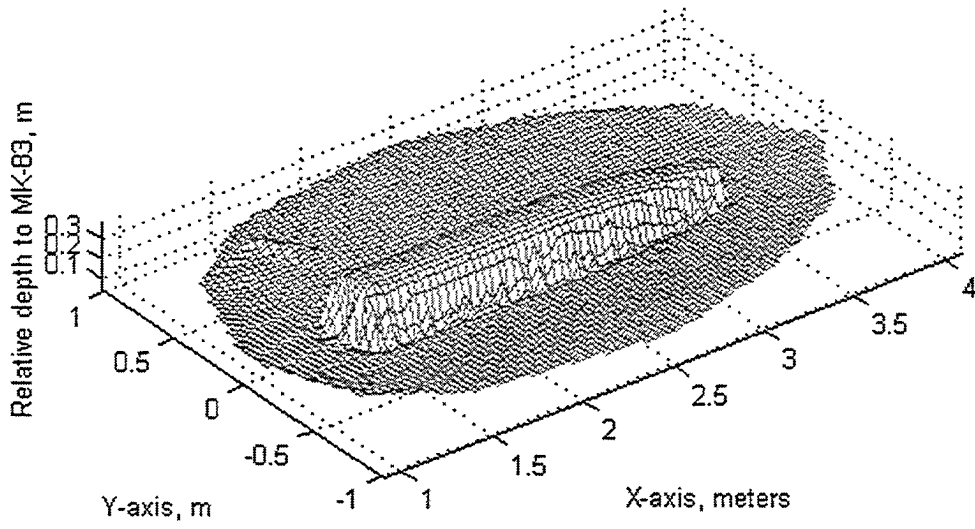

Mesh plot of Scour after Three Hours

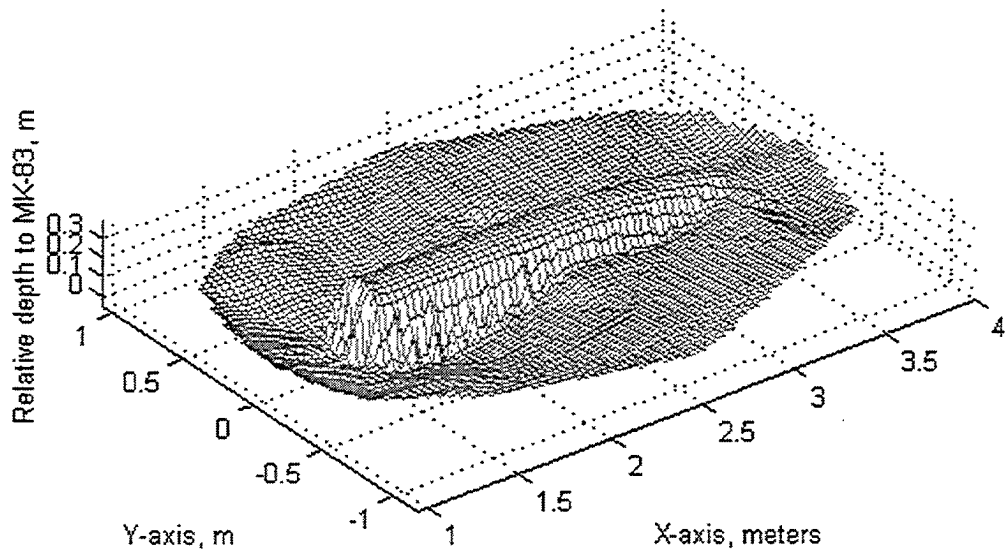

Mesh plot of Scour after five hours

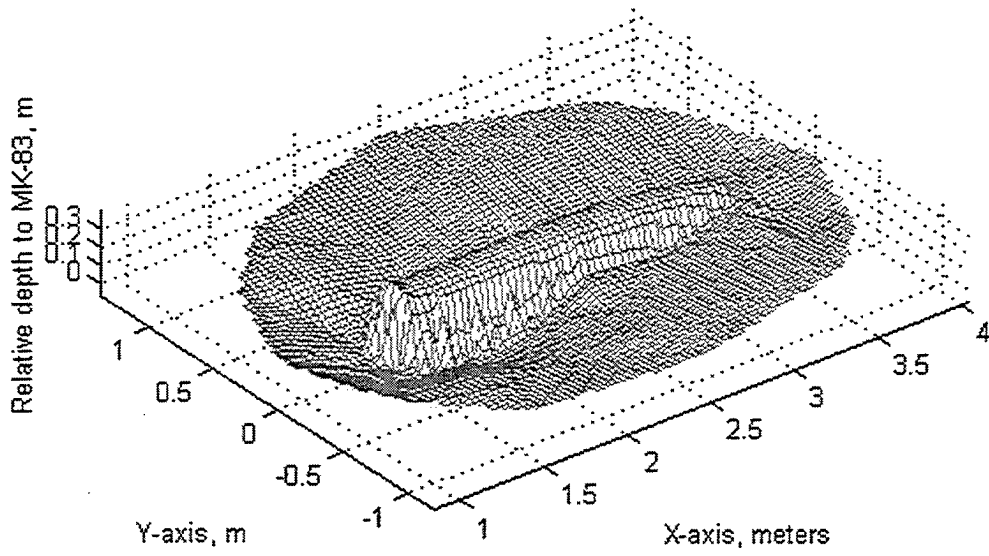

Mesh plot of Scour after Seven hours

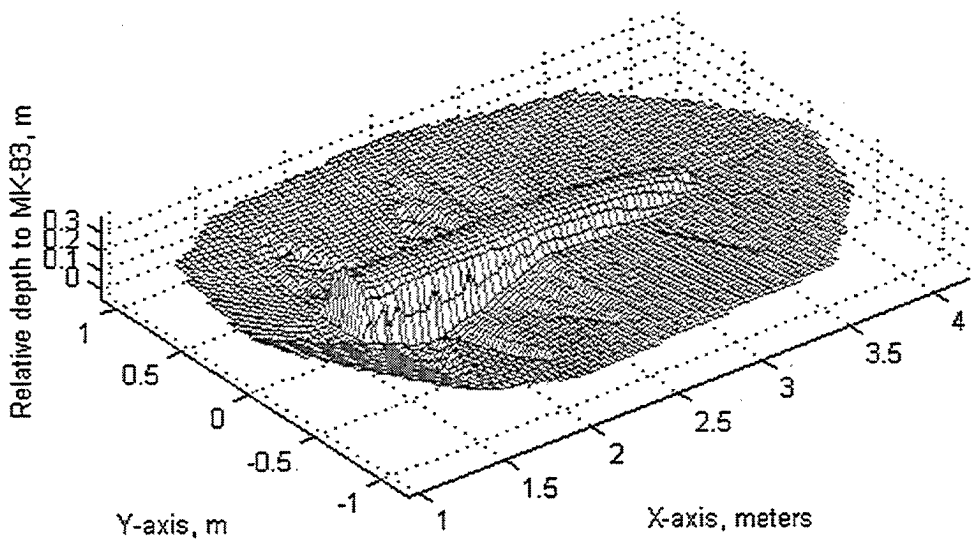

Mesh plot of Scour after 24 hours

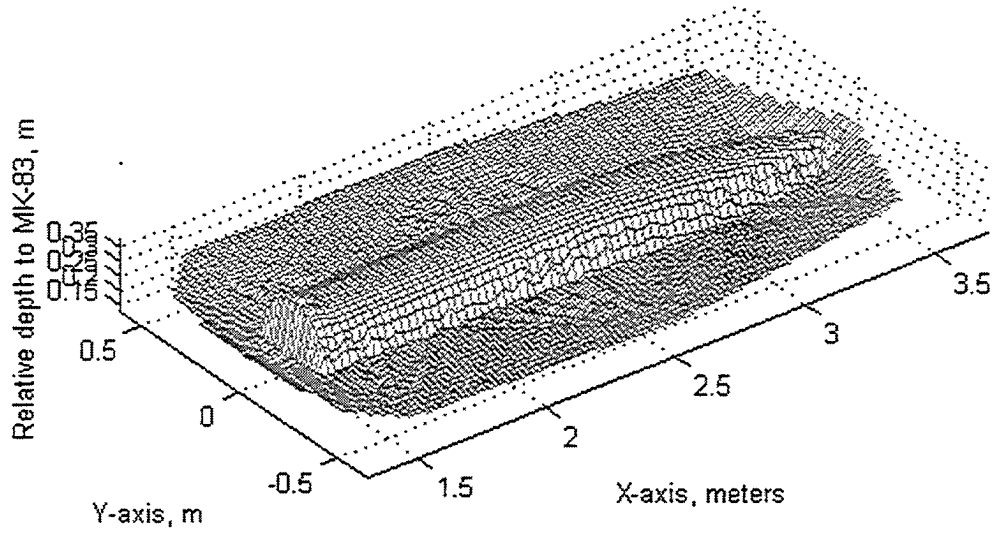

## LIST OF REFERENCES

Brandes, H.G., "Mine Burial Due to Wave-Induced Liquefaction and Other Processes", Proceeding of the Ninth (1999) International Offshore and Polar Engineering Conference, Brest, France, May 30-June 4, 1999

Department of the Navy, ... *From the Sea: Preparing the Naval Service for the 21st Century*, Washington, DC: U. S. Government Printing Office, September 1992.

Department of the Navy, *Forward... From the Sea*, Washington, D. C., September 1994.

DERA, UK, *Validation of Mine Burial Prediction Models using Recent Trials Data*, Brothers, R.J., 1998

Hanselman, Duane and Littlefield, Bruce, *Mastering Matlab 5 A Comprehensive Tutorial and Reference*, Prentice-Hall, 1998

Herbich, John B., and others, *Seafloor Scour; Design Guidelines for Ocean Founded Structures*, Marcel Dekker, Inc., NY, 1984

Scripps Institution of Oceanography, Center for Coastal Studies, SIO Reference Series No. 96-13, *A Chronology of Ground Mine Studies and Scour Modeling in the Vicinity of La Jolla*, D.L. Inman and S.A. Jenkins, August 1996

Maritime Operations Division Aeronautical and Maritime Research Laboratory, Australia, DSTO-TR-0290, *A Mathematical Model for Mine Burial by Mobile Underwater Sand Dunes*, Mulhearn, P.J., 1996

Materials Research Laboratory DSTO, MRL Technical Note No. MRL-TN-632, *Experiment on Mine Burial by Scour*, P.J. Mulhearn, 1993

Naval Research Center, Stennis Space Laboratory, MS, In Preparation, Lott, Daniel, *Modeling Mine Burial Processes: A Review*, 1999

National Oceanic and Atmospheric Administration, "National Data Buoy Center", [[http://www.ndbc.noaa.gov/station\\_page?\\$station=46042](http://www.ndbc.noaa.gov/station_page?$station=46042)] Aug 2000

Office of Naval Research, *Background Information on VSW and Surf Zone Concepts, Capabilities and Challenges in Support of Expeditionary Mine Warfare*, Office of Naval Research, 1999, [available online at [http://www.onr.navy.mil/sci\\_tech/ocean/info/VSWSZMCM/BAKGRND.htm](http://www.onr.navy.mil/sci_tech/ocean/info/VSWSZMCM/BAKGRND.htm)]

Office of Naval Research, *Naval MCM in the Littoral*, Office of Naval Research, 1999, [available online at [http://www.onr.navy.mil/sci\\_tech/ocean/baa/MCM.html](http://www.onr.navy.mil/sci_tech/ocean/baa/MCM.html)]

U.S. Marine Corps Headquarters, *Operational Maneuver from the Sea*, Headquarters Marine Corps, January, 1996 [available on www at <http://192.156.75.102/omfts.htm>]

Renwick, D., R. Simmons, S. Truver, "Marine Mammals are a Force Multiplier", *Proceedings*, Vol. 123:8, pp. 52-55, 1997

Soulsby, Richard, *Dynamics of Marine Sands*, Thomas Telford Publications, 1997

U.S. Geographic Survey, *Geographic Reference Image*, U.S. Geographic Survey, 1999, available online at <http://TerraWeb.wr.usgs.gov/TRS/projects/MontereySonar>

U.S. Navy Hydrographic Office, *Application of Oceanography to Mine Warfare*, Hydrographic Office, 1957

Whitehouse, R.J.S., *Scour at Marine Structures*, Thomas Telford Publication, 1998

## INITIAL DISTRIBUTION LIST

1. Defense Technical Information Center ..... 2  
8725 John J. Kingman Road, Suite 0944  
Ft. Belvoir, VA 22060-6218
  
2. Dudley Knox Library ..... 2  
Naval Postgraduate School  
411 Dyer Road  
Monterey, CA 93943-5101
  
3. Director Submarine Warfare (N87)..... 2  
2000 Navy Pentagon  
Washington, DC 20350-2000
  
4. Curricular Officer METOC/USW Code 35 ..... 1  
Naval Postgraduate School  
Monterey, California 93943-5002
  
5. Dr. James V. Sanders, Code PH/Sd ..... 2  
Department of Physics  
Naval Postgraduate School  
Monterey, California 93943-5002
  
6. Dr. Thomas G. Muir ..... 2  
Department of Physics  
Naval Postgraduate School  
Monterey, California 93943-5002
  
7. Dr. Edward B. Thornton ..... 2  
Department of Oceanography  
Naval Postgraduate School  
Monterey, California 93943-5002
  
8. LCDR Wayne L. Plager ..... 2  
503 Bruner Hill Rd.  
Louisville, KY 40243