

# NAVAL POSTGRADUATE SCHOOL Monterey, California



## THESIS

**SINKING A BODY WITH BUBBLES IN CLOSED  
AND OPEN ENVIRONMENTS**

by

Carl W. DeGrace

December 2000

Thesis Advisor:  
Second Reader:

Bruce Denardo  
Ashok Gopinath

**Approved for public release; distribution is unlimited**

**DTIC QUALITY INSPECTED 4**

**20010124 063**

# REPORT DOCUMENTATION PAGE

Form Approved OMB No. 0704-0188

Public reporting burden for this collection of information is estimated to average 1 hour per response, including the time for reviewing instruction, searching existing data sources, gathering and maintaining the data needed, and completing and reviewing the collection of information. Send comments regarding this burden estimate or any other aspect of this collection of information, including suggestions for reducing this burden, to Washington Headquarters Services, Directorate for Information Operations and Reports, 1215 Jefferson Davis Highway, Suite 1204, Arlington, VA 22202-4302, and to the Office of Management and Budget, Paperwork Reduction Project (0704-0188) Washington DC 20503.

1. AGENCY USE ONLY	2. REPORT DATE December 2000	3. REPORT TYPE AND DATES COVERED Master's Thesis
--------------------	---------------------------------	---

4. TITLE AND SUBTITLE Sinking a Body with Bubbles in Closed and Open Environments	5. FUNDING NUMBERS
--	--------------------

6. AUTHOR(S) DeGrace, Carl W.	
----------------------------------	--

7. PERFORMING ORGANIZATION NAME(S) AND ADDRESS(ES) Naval Postgraduate School Monterey CA 93943-5000	8. PERFORMING ORGANIZATION REPORT NUMBER
---	--

9. SPONSORING/MONITORING AGENCY NAME(S) AND ADDRESS(ES)	10. SPONSORING/MONITORING AGENCY REPORT NUMBER
---	--

11. SUPPLEMENTARY NOTES  
The views expressed in this thesis are those of the authors and do not reflect the official policy or position of the Department of Defense or the U.S. Government.

12a. DISTRIBUTION/AVAILABILITY STATEMENT Approved for public release; distribution is unlimited.	12b. DISTRIBUTION CODE
---	------------------------

13. ABSTRACT (*maximum 200 words*)  
The presence of bubbles in a liquid decreases the average density, and thus decreases the buoyant force on a floating body. Competing with the decrease in buoyancy is an upward drag due to the bubble motion and entrained liquid. This thesis presents investigations of the critical average density required to sink a buoyant body in water with bubbles in closed and open environments. A *closed* environment is where bubbles fill the container, in which case there is expected to be little if any upward flow of water at the body. An *open* environment is where the bubbles exist over a small cross-sectional area compared to the total cross-sectional area of the container, which models the effect of a methane eruption from the ocean floor. In this case, a substantial upward flow of water is entrained in the region of the bubbles, and a downward flow consequently occurs outside this region. Experiments for both closed and open environments are reported, where the average specific gravity of the body is varied. The closed environment data significantly deviate from a quantitative theory, and the open environment data are not in accord with a qualitative theory. Possible explanations for these deviations are offered.

14. SUBJECT TERMS: Water, Density, Specific Gravity, Volume Fraction, Bubbles, Buoyancy, Non-Newtonian Fluid	15. NUMBER OF PAGES 56
	16. PRICE CODE

17. SECURITY CLASSIFICATION OF REPORT Unclassified	18. SECURITY CLASSIFICATION OF THIS PAGE Unclassified	19. SECURITY CLASSIFICATION OF ABSTRACT Unclassified	20. LIMITATION OF ABSTRACT UL
---	--	---	----------------------------------



Approved for public release; distribution is unlimited.

# SINKING A BODY WITH BUBBLES IN CLOSED AND OPEN ENVIRONMENTS

Carl W. DeGrace  
Lieutenant, United States Navy  
B.S., United States Naval Academy, 1994

Submitted in partial fulfillment of the  
requirements for the degree of

**MASTER OF SCIENCE IN  
APPLIED PHYSICS**

from the

**NAVAL POSTGRADUATE SCHOOL  
December 2000**

Author:



Carl W. DeGrace

Approved by:



Bruce Denardo, Thesis Advisor

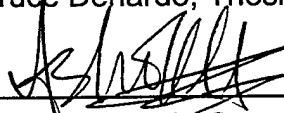

Ashok Gopinath, Second Reader

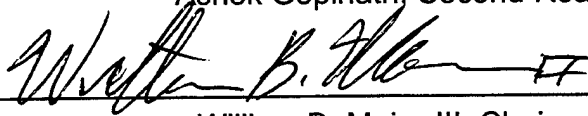

William B. Maier III, Chairman  
Department of Physics



## ABSTRACT

The presence of bubbles in a liquid decreases the average density, and thus decreases the buoyant force on a floating body. Competing with the decrease in buoyancy is an upward drag due to the bubble motion and entrained liquid. This thesis presents investigations of the critical average density required to sink a buoyant body in water with bubbles in closed and open environments. A *closed* environment is where bubbles fill the container, in which case there is expected to be little if any upward flow of water at the body. An *open* environment is where the bubbles exist over a small cross-sectional area compared to the total cross-sectional area of the container, which models the effect of a methane eruption from the ocean floor. In this case, a substantial upward flow of water is entrained in the region of the bubbles, and a downward flow consequently occurs outside this region. Experiments for both closed and open environments are reported, where the average specific gravity of the body is varied. The closed environment data significantly deviate from a quantitative theory, and the open environment data are not in accord with a qualitative theory. Possible explanations for these deviations are offered.



## TABLE OF CONTENTS

I. INTRODUCTION .....	1
II. THEORY .....	5
III. APPARATUS.....	11
A. AIR FEED SYSTEM.....	12
B. MANIFOLD DESIGN .....	14
C. VOLUMETRIC BUBBLE GENERATOR.....	16
D. CLOSED ENVIRONMENT .....	18
E. OPEN ENVIORNMENT.....	21
IV. EXPERIMENTS .....	23
A. SPECIFIC GRAVITY OF BODY.....	23
B. DETERMINATION OF BUBBLY WATER DENSITY .....	25
C. CLOSED ENVIRONMENT.....	26
D. OPEN ENVIRONMENT.....	30
V. CONCLUSIONS AND FUTURE WORK.....	35
A. CONCLUSIONS .....	35
B. FUTURE WORK.....	37
APPENDIX . NON-NEWTONIAN EFFECTS OF BUBBLY LIQUIDS.....	41
LIST OF REFERENCES .....	45
INITIAL DISTRIBUTION LIST .....	47



## I. INTRODUCTION

Archimedes' principle states that the buoyant force on a floating or submerged body in a gravitational field equals the weight of the fluid displaced by the body. The condition for floating is that the density of the fluid be greater than the average density of the body, as long as the body is not shaped similar to a canoe or bowl, which can displace more fluid than its volume. The introduction of bubbles into the liquid reduces the average density of the fluid. For bubbles that are uniformly distributed and small compared to the size of the body, the body may be expected to sink when the average density of the fluid is less than the average density of the body. However, there is an upward drag on the body due to the rising bubbles and the entrained liquid. It is thus not clear whether the introduction of bubbles can make a floating body sink, or, if the body does sink, to what extent the average density of the fluid must be reduced from that of the body.

The possible sinking due to bubbles has been given as an explanation for the demise of some ships as a result of methane eruptions from the ocean floor (McIver, 1982). A "buoyancy bomb" has also been suggested, in which an underwater vehicle mines a methane hydrate deposit and uses the methane to sink a floating target (Stumborg, 2000). However, apart from the recent thesis of Pringle (2000), we have not found any report of quantitative investigations of this phenomenon.

A relevant aspect of the sinking of a body due to bubbles is the cross-sectional area over which the bubbles are generated compared to the cross-sectional area of the container of the liquid. Two limiting cases are a *closed environment*, where the bubbles are generated uniformly over the cross-section of a container, and an *open environment*, where the cross-sectional area of the liquid is much greater than that of the bubbles which would occur, for example, in the ocean. In a closed environment, there is expected to be no large-scale non-uniformities in the flow, which implies little if any upward flow of liquid and thus no upward drag on a body due to the liquid. In an open environment, large-scale circulation of the liquid will occur, where the liquid rises in the region of the bubbles, and falls outside this region. This is expected to produce a significant upward drag on a body in the bubble region, and thus require a greater amount of bubbles to sink the body.

Experiments by Pringle showed that a floating spherical body in a closed environment can indeed be made to sink with bubbles, and that a simple theory accounted for the critical average density at which a body just sinks as long as the specific gravity of the body is not less than 0.94. Otherwise, the critical density of the fluid was less than predicted.

One objective of this thesis was to substantially improve the apparatus used by Pringle, and to thereby obtain more accurate data. Another objective was to modify the apparatus so that an open environment experiment could be performed, and to contrast the data with that from the closed environment.

The organization of the thesis is as follows. Chapter II includes the theory that predicts the critical average density of bubbly water at which a spherical body is predicted to sink. This theory can be shown to be equivalent to that of Pringle, but our derivation is simpler. The apparatus is described in Ch. III, where substantial modifications of Pringle's apparatus are detailed. The results of measurements, and a comparison with the theory, are presented in Ch. IV. Concluding remarks and suggestions for future work are made in Ch. V.

Pringle's results suggested that the critical average fluid density as a function of the average ball density has a discontinuity in slope at a specific gravity of 0.94, and that this could be a non-Newtonian effect of bubbly water. Our initial research involved an extensive search of the literature to ascertain whether any such behavior had been observed or predicted. The result was negative. The details of this search are given in the Appendix. Our experimental results do not conclusively confirm Pringle's discontinuity in slope, although they do not rule out the possibility.

THIS PAGE INTENTIONALLY LEFT BLANK

## II. THEORY

The *critical density* of bubbly water is the density at which the ball just sinks. We experimentally determine the critical density by first measuring the height  $h_0$  of water when no bubbles are present [Figure 2.1(a)], where the volume  $V_0$  and cross-sectional area  $A$  are related by  $V_0 = h_0A$ . The mass of water is then  $M = \rho_w V_0 = \rho_w A h_0$ , where  $\rho_w$  is the density of water. When bubbles are present, it is instructive to first consider the simple case in which the ball is not present. The mass of the water is now expressed as  $M = \rho A h$ , where  $\rho$  is the average density of the bubbly water, neglecting the density of air compared to water, and  $h$  is the height of the bubbly water. Equating the two expressions for  $M$  yields

$$\rho = \frac{h_0}{h} \rho_w, \quad (2.1)$$

which is obvious because the density is inversely proportional to the height.

When the ball is present and is just sinking [Figure 2.1(b)], there is a "shadow" devoid of bubbles directly above the ball. We assume that this region is that which is directly above the ball. The volume of the region is  $V_s = \pi R^3/3$ , where  $R$  is the radius of the ball. Due to the fill hole, the volume  $V_b$  of the ball is slightly greater, approximately 1.2%, than  $4\pi R^3/3$ . The volume of the region with bubbles is  $Ah - V_b - V_s$ . The mass of the water is thus now expressed as  $M = \rho(Ah - V_b - V_s) + \rho_w V_s$ , where  $\rho$  is the average density of bubbly water, again

neglecting the density of air compared to water. Equating this expression to the expression  $M = \rho_w V_0 = \rho_w A h_0$ , and solving for the bubbly water density, yields

$$\rho = \frac{1 - V_s/V_0}{h/h_0 - (V_b + V_s)/V_0} \rho_w, \quad (2.2)$$

which allows the critical density of the bubbly water to be determined from measured quantities. For the simple case in which the ball is not present ( $V_b = V_s = 0$ ), Equation (2.2) correctly reduces to Equation (2.1). Because  $V_b$  and  $V_s$  are small for our experiment, we could approximate Equation (2.2). This does not simplify the calculations, however, so we will deal with the exact expression.

To determine the theoretical value of the critical density, we assume that the bubbles are uniformly distributed over the volume outside the ball and shadow region, which is in accord with our observations. The equilibrium condition corresponding to Figure 2.1(b) is that the weight of the ball and the shadow region is balanced by the buoyant force:  $(\rho_b V_b + \rho_w V_s)g = \rho(V_b + V_s)g$ , where  $\rho_b$  is the average density of the ball and  $g$  is the acceleration due to gravity. Solving for the bubbly water density yields

$$\rho = \frac{\rho_b V_b + \rho_w V_s}{V_b + V_s}. \quad (2.3)$$

That is, the critical density is just the weighted average of the densities of the ball and shadow region. A graph of the specific gravities  $\rho/\rho_w$  vs.  $\rho_b/\rho_w$  is shown in Figure 2.2. Because the volume of the ball is approximately  $V_b = 4\pi R^3/3$  and the volume of the shadow region is  $V_s = \pi R^3/3$ , the ordinate intercept  $V_s/(V_b + V_s)$  is approximately  $1/5$ . Due to the shadow effect, the density of bubbly water required to sink the ball is *greater* than the density of the ball. This occurs because the shadow region effectively exerts a downward force on the ball relative to the situation in which bubbles filled the entire liquid. In fact, the relationship (2.3) can be alternatively derived from this perspective (Pringle, 2000).

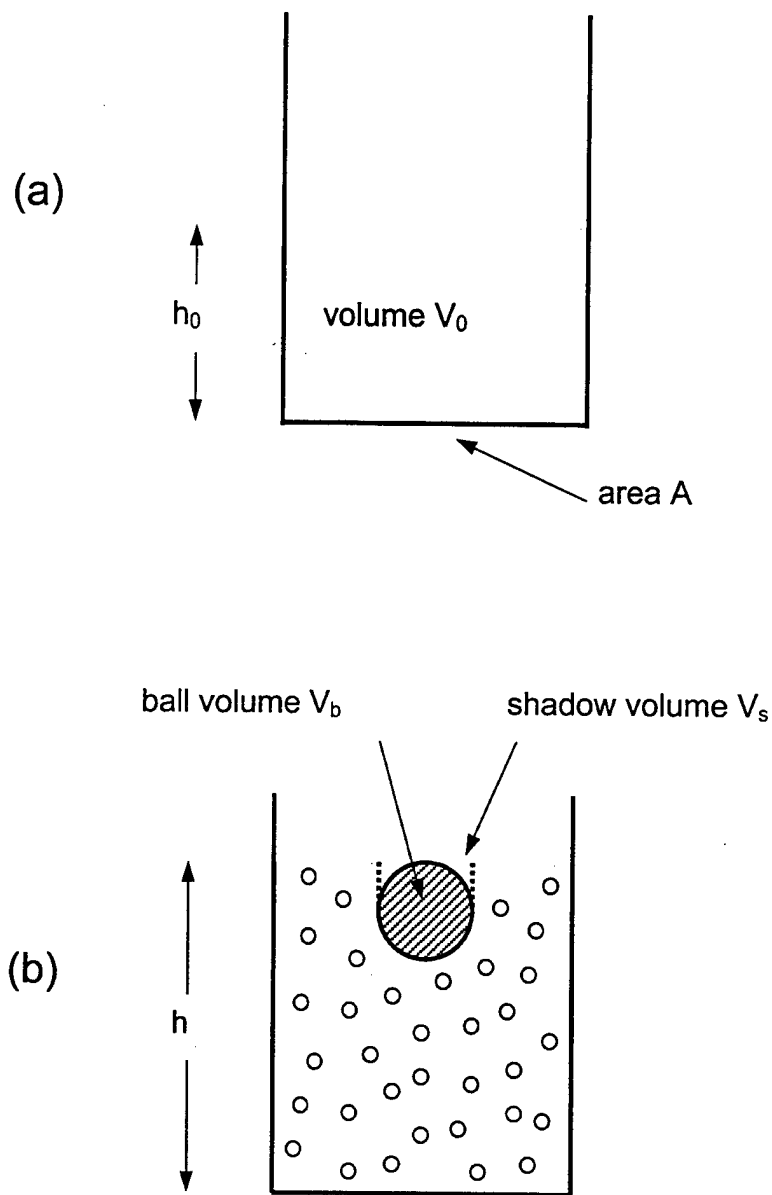

Figure 2.1. Geometry of the system for (a) no bubbles and no ball, (b) bubbles and ball at the critical condition when the ball just sinks. Compared to the actual system, the bubbles in (b) have a substantially exaggerated diameter and a greatly reduced number.

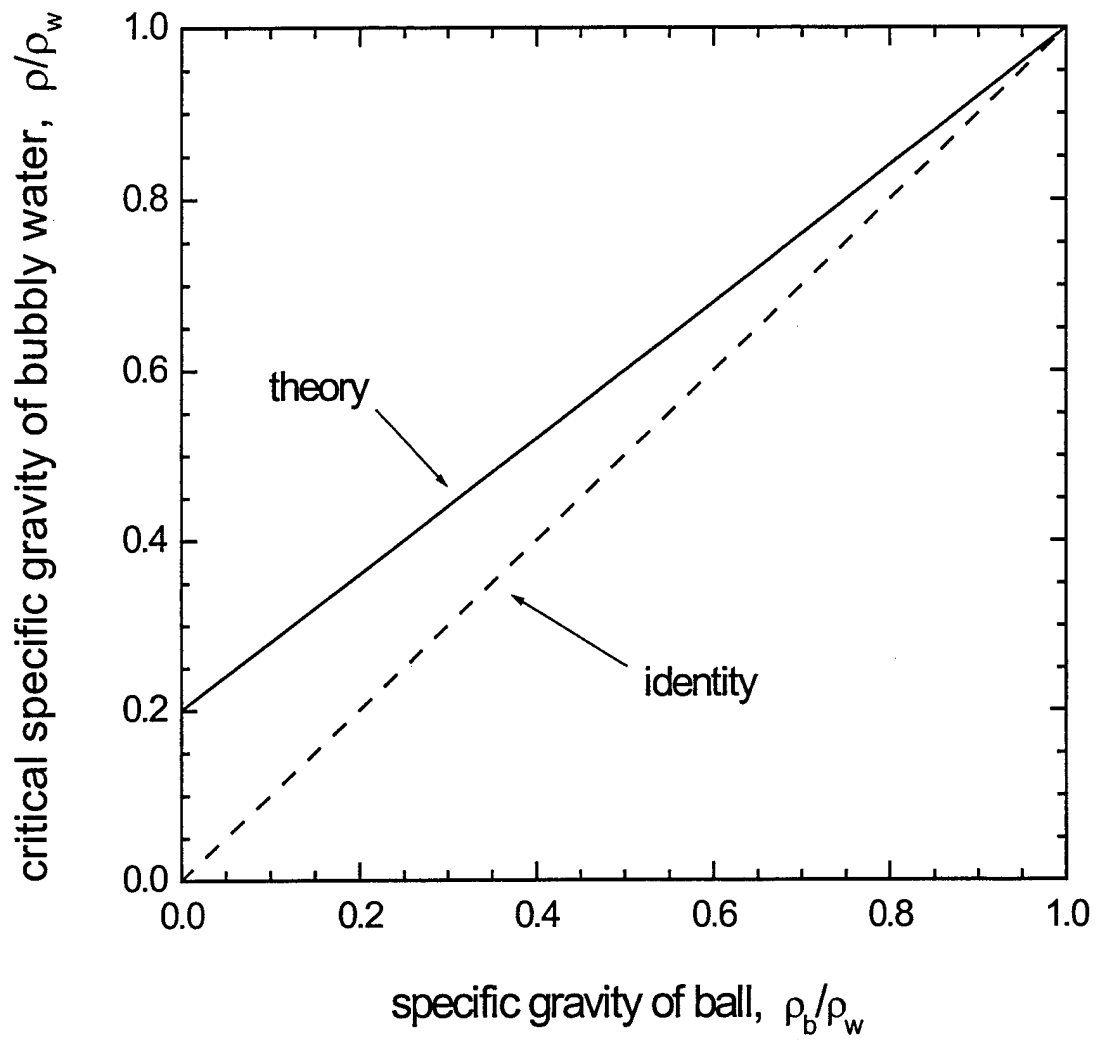

Figure 2.2. Theoretical specific gravity of bubbly water required to just sink a floating ball, as a function of the specific gravity of the ball.

THIS PAGE INTENTIONALLY LEFT BLANK

### III. APPARATUS

In this chapter we describe the design and construction of the apparatus used to produce a volume of bubbly water. As shown in Figure 3.1, the main components of the apparatus for the closed environment experiment are a cylindrical acrylic chamber and an array of bubble diffusers. The diffusers are connected to a pressurized air supply system through a manifold and a series of control valves, and generate a controllable volume of air bubbles. Figure 3.2 shows a body that has been sunk due to bubbles for a closed environment.

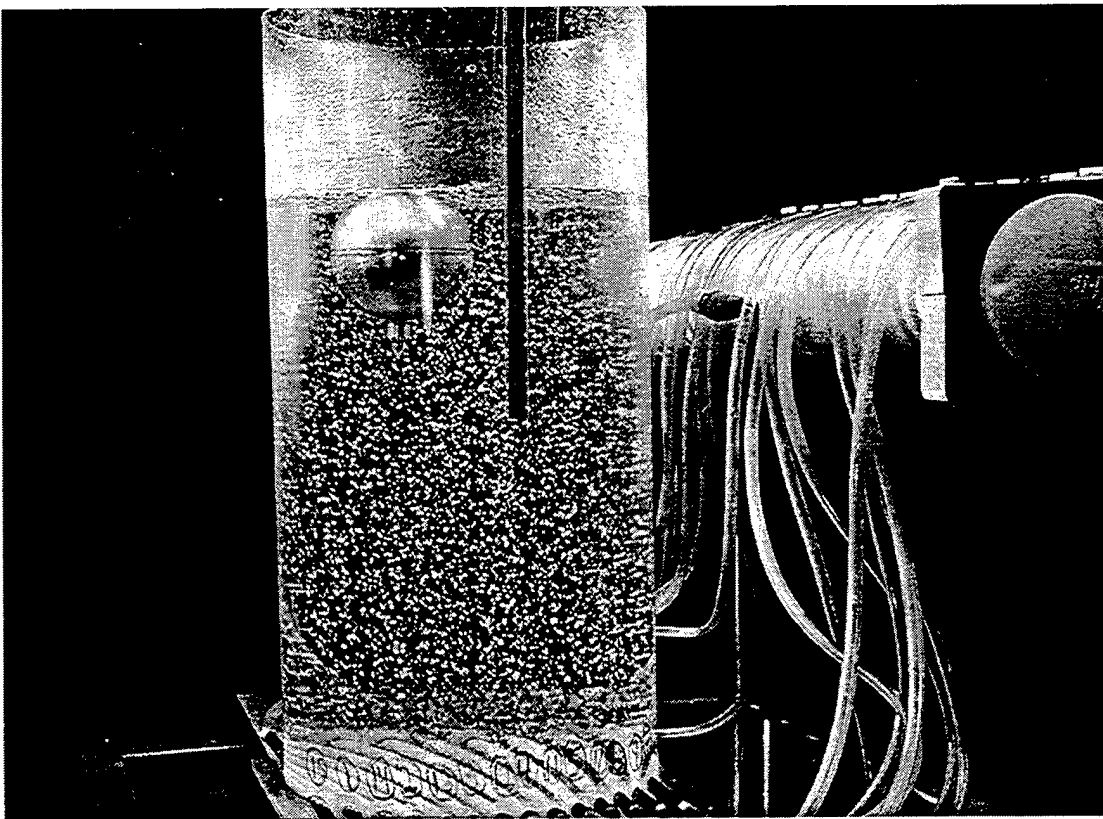

Figure 3.1. Main components of the apparatus for the closed environment experiment: a cylindrical acrylic chamber, an array of 15 bubble diffusers, and a manifold to provide evenly distributed air flow to the diffusers. Also shown is the buoyant body, which was employed throughout the thesis. For the open environment experiment, nearly all of the cylinder is detached and the bottom is immersed in the large tank below.

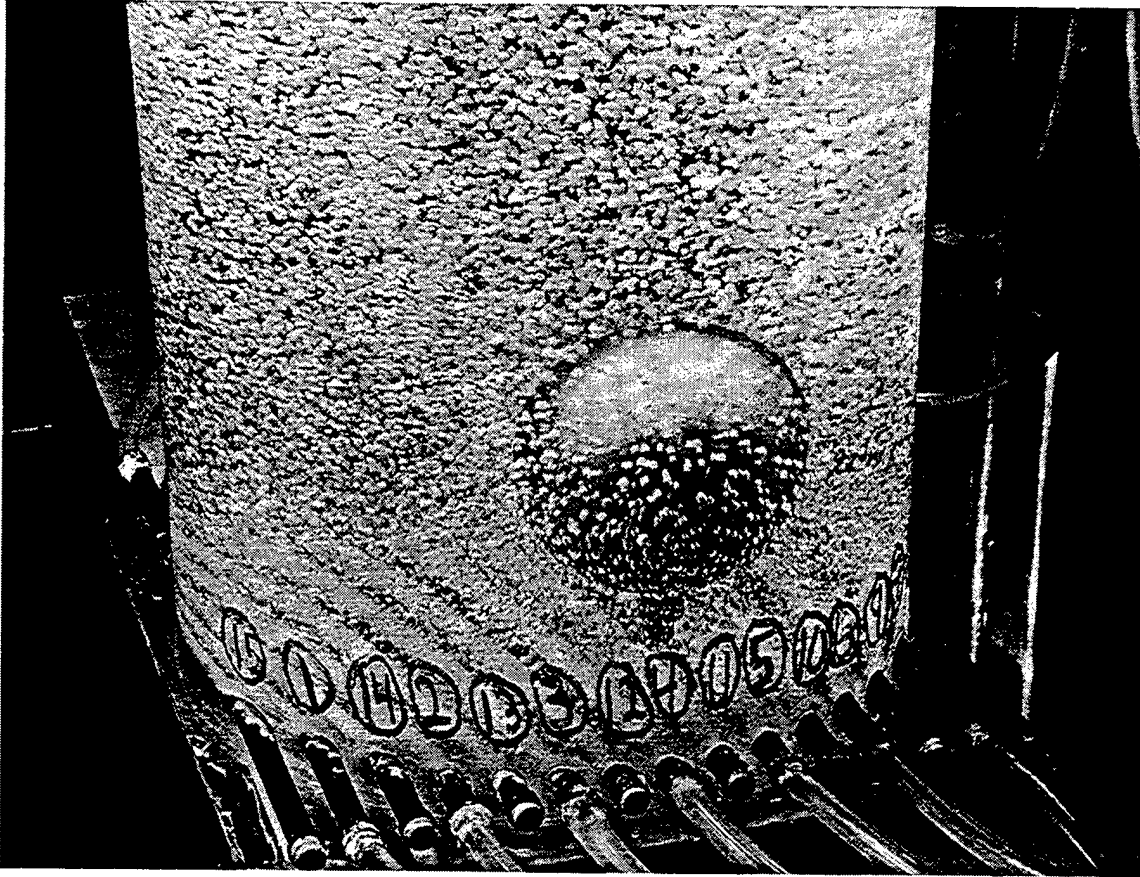

Figure 3.2. The body has been sunk due to bubbles for the closed environment case.

## A. AIR FEED SYSTEM

A schematic of the feed system is shown in Figure 3.3. Accurate control of the volume flow rate to the diffusers was important. Previous research by Pringle (2000) utilized nitrogen from a pressurized cylinder as a gas supply. Due to the higher gas flow rates anticipated being needed for study of the open environment, the decision was made to use pressurized air from the building air supply provided from a large compressor and reservoir. This also turned out to be very useful for the closed environment, because it allowed us to carefully and

patiently gather much data, which would have required many cylinders of nitrogen. Prior to use of this air source, significant modifications had to be made before the air was usable. Due to an extreme water and debris content, a heavy-duty in-line combination pressure regulator/filter was installed to provide filtration and regulation of the compressed air source. The Speedaire model 4Z029A was selected and purchased from Grainger Industrial Supply. The unit was mounted on the wall next to the air inlet and piped in. A 50-foot length of standard air hose was used to connect the air filter/regulator to the apparatus control valve. Overall gas flow rate was controlled with a Matheson 3/8" control valve in conjunction with an inline flow meter.

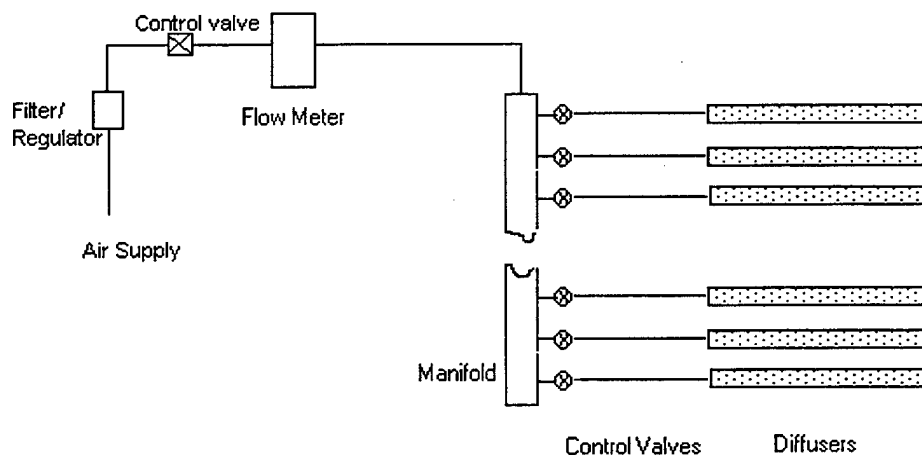

Figure 3.3. Schematic of the gas feed system. There are 15 diffusers.

The flow meter used was a Sierra Instruments Model 826 Hi-Flow Meter with Display. This meter allowed for the precise measurement of the air mass flow over the range of 0 – 175 LPM required for the experiment. Prior to the use of the Model 826 from Sierra Instruments, a Model 100-13 Flo-Sensor (40 – 200 LPM) from McMillan Company was utilized. It was replaced by the flow meter from Sierra Instruments after the McMillan flow meter showed insufficient repeatability. After its replacement, further investigation revealed that the McMillan flow meter was giving flow readings off by as much as 20% at flow rates greater than 120 LPM.

Clear Tygon tubing (0.3125-inch ID) connected the air source to individual diffuser control valves through a manifold (locally fabricated), and also connected the individual diffusers to the control valve outlets.

## **B. MANIFOLD DESIGN**

In Pringle's research, balancing of the diffuser control valves was found to be critical in the stability of the generation of bubbles. Even a small deviation from a perfect balance could set up substantial turbulent flow in the chamber or localized upward or downward flow regimes that caused the buoyant body to sink prematurely or later depending on the direction of flow. In order to provide this balancing, precise control of the airflow to each diffuser must be obtained. It quickly became evident that the manifold utilized in Pringle's research was unsuitable for precise data measurement. We were unable to balance the flow

rate between diffusers to provide a uniform flow rate across the chamber due to the manifold's use of simple gate valves that could not be throttled precisely enough. In order to provide the control necessary, multi-turn needle valves were required.

A new manifold was constructed using a 28-inch long piece of 4-inch diameter PVC pipe with end-caps glued on. Fifteen 4-inch flow meters (Cole-Parmer 2000 series 1-10 LPM) were attached to the pipe as shown in Figure 3.4. Each individual flow meter was attached using a 1/4-inch flare x 1/8-inch NPT male connector to a 1/4-inch swivel nut valve connector and then to another 1/4-inch flare x 1/8-inch NPT male connector which was screwed into a 1/4-inch hole drilled into the PVC pipe. A 1/2-inch street elbow was inserted in the back end of the manifold to allow the air supply hose to be attached (Figure 3.5).

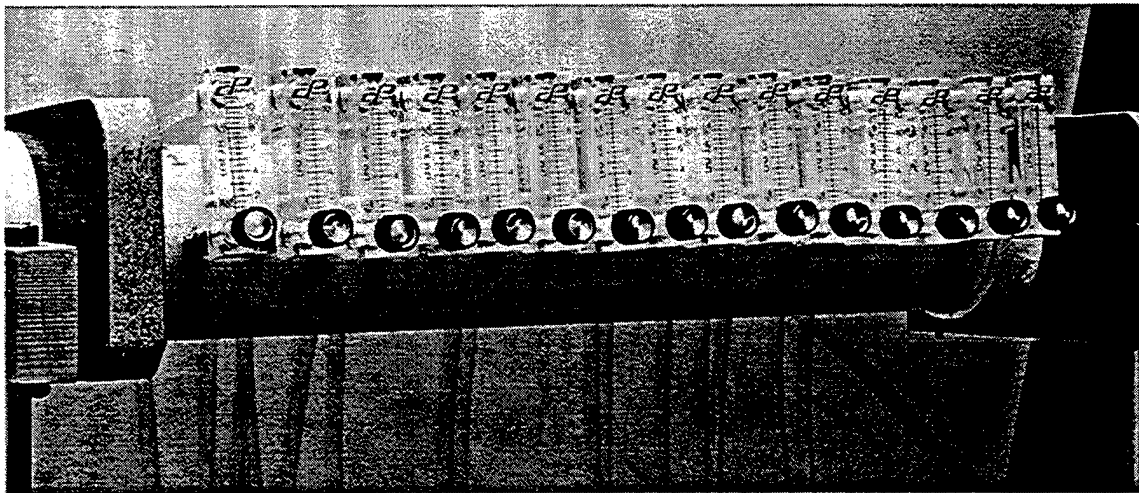

Figure 3.4. Front view of manifold showing 15 flow meters and individual control valves attached to 4" diameter PVC pipe.

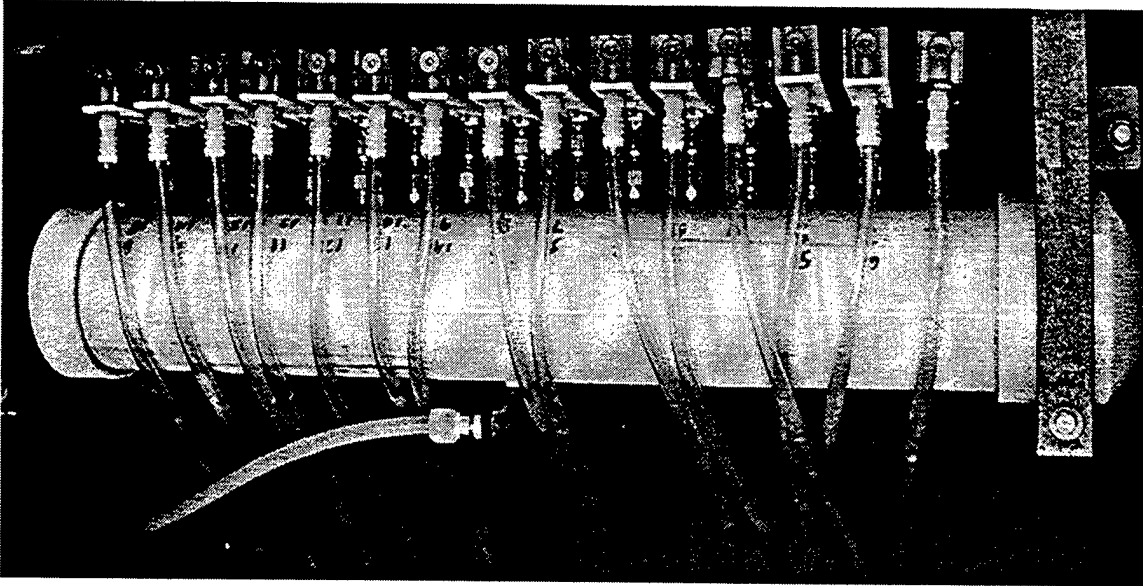

Figure 3.5. Top view of manifold showing mounting of flow meters and inlet and outlets for air supply.

### C. VOLUMETRIC BUBBLE GENERATOR

The selection of the bubble making devices was made in prior research completed by Pringle. That selection was made taking into consideration three primary criteria: the bubbles must be much smaller than the buoyant body yet large enough so that direct absorption of the gas into the fluid is inhibited; there must be a constant and diffused flow of bubbles to ensure a uniform distribution over the cross-sectional area of the chamber, reducing possible fluid turbulence; and the diffusers must be sufficiently robust to physically withstand a large volumetric flow of air over extended periods. The device that provided the most uniform bubble field, with small diameter bubbles and little turbulence, was a set of aquarium diffusers (Regent PL-T714). The diffusers are hollow porous tubes capped at one end and with an air inlet at the other. The dimensions of the diffusers

are 36 cm in length, 1.0 cm in diameter and a wall thickness of 1.0 mm.

Fifteen diffusers were strategically positioned to give the most uniform cross-sectional flow pattern possible. The diffusers were inserted through the chamber holes (Figure 3.6). The portion of the diffusers that extended outside of the chamber was made water and air tight through the use of heat shrink tubing, silicon sealant, and a rubberized cyanoacrylate glue called IC-2000 (BSI Adhesives).

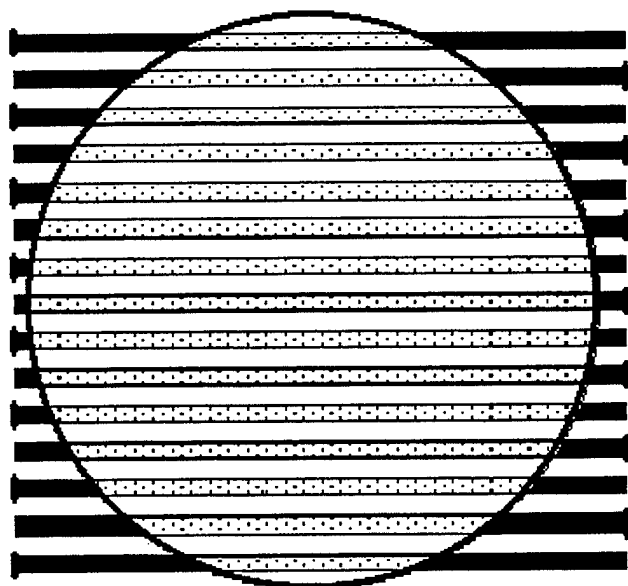

Figure 3.6. Top view of the bubbly water chamber and diffuser arrangement.

## **D. CLOSED ENVIRONMENT**

For the closed environment experiment, the bubbly water exists in an acrylic tube that is sealed at the bottom and open at the top. The tube has inner diameter 30.6 cm, height 60 cm, and wall thickness 3.175 mm. The water depth in the absence of bubbles is maintained at 400 mm from the horizontal plane passing through the centers of the diffusing tubes. This allows for a roughly 180 mm increase in height resulting from the introduction of the bubbles.

The chamber's cylindrical shape was selected to minimize the wall surface area for a given volume and thus minimize the surface drag of the bubbles on the walls of the chamber. The cylindrical shape also provided no corners that might needlessly complicate the bubble flow pattern. The diameter of the chamber was chosen to be as large as conveniently possible compared to the diameter of the buoyant body. The chamber height allows for a uniform mixing of the bubbles ensuring an equal distribution of the small air bubbles over the cross-sectional area of the chamber. The clear acrylic material facilitates viewing and photography of the bubbles and the buoyant body. A 30 cm steel rule was attached with heavy-duty clear cellophane tape along the inside of the chamber to allow for measurement of the change in height of the fluid as the bubbles are introduced.

Holes of diameter 0.7 cm were drilled 3 cm from the bottom of the chamber to allow 15 bubble-generating diffusers to penetrate the cylinder. The holes were placed such that the diffusers were evenly spaced and parallel to

each other. A 6 mm thick acrylic plate, 33 cm square, was glued to the bottom of the tube. Once the diffusers were inserted into the holes, the plate effectively created a chamber that was both water and air tight below the water line.

Surprisingly, it became evident during the experiment that the bubble flow was sensitive to deviations of the orientation of the cylinder. When the cylinder was not situated in a nearly perfectly vertical position, different bubble flow velocities were noted on opposing sides of the cylinder. Only after careful alignment and the use of an adjustable platform to level the apparatus were we able to alleviate the non-uniform flow patterns.

While floating in the chamber, the density ball had the tendency to drift out of the center of the column of bubbles generated and press against the sides of the acrylic where unknown boundary effects could come into play. Therefore, a device was constructed to contain the ball near the center of the bubble column. The device, shown in Figure 3.7, was constructed from a 1/4-inch thin sheet of plexiglass which was cut into a Y shape and two small holes were drilled 80 mm apart from each other 70 mm from the center out along each leg. Through each of these holes, a 28-inch long piece of 1/16-inch diameter stainless steel rod was inserted and allowed to hang into the water creating a hexagonal containment cage for the ball.

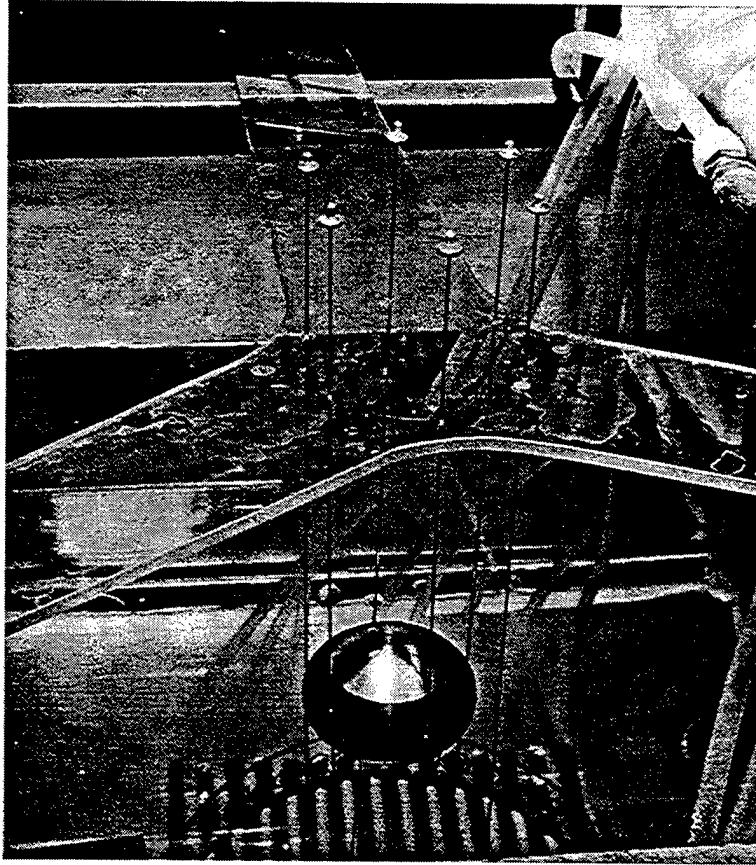

Figure 3.7. Device constructed to contain ball to center of bubble column.

Additionally, reading the height of the fluid became difficult as bubble flow was increased in the chamber due to the collection of bubbles at the surface masking the meniscus line of the fluid. The reading of this measurement was critical to accurate data taking. A small device was constructed to facilitate this reading. It was made from a 12-inch long piece of 1-inch diameter clear acrylic tubing sliced in half lengthwise. The bottom end was capped and small holes were drilled 1 inch apart along both sides of the tube. The holes were small enough to prevent bubbles from entering the cavity but large enough for fluid to

flow in. Black tape was used to provide a suitable background for the reading of the surface height. When a height measurement was required, the half-cylinder device was placed along the inside of the chamber next to the steel ruler about one cm deep into the fluid. The device, shown in Figure 3.8, provided a small cavity filled with water and free of bubbles that showed the meniscus line of the fluid allowing an accurate height measurement to be taken.

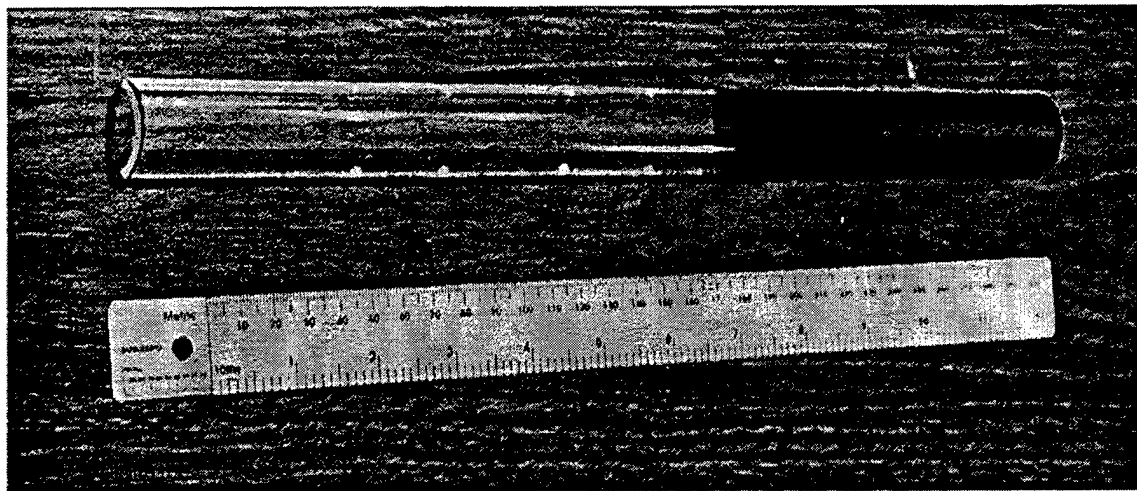

Figure 3.8. The half-cylinder device constructed to facilitate measuring of change in height of fluid.

## E. OPEN ENVIRONMENT

In order to collect data on the effects of bubbly water on a body in an open environment such as the ocean, the bubbly water chamber had to be modified. The acrylic cylinder was carefully cut with a band saw approximately 3 inches above its base. The top portion of the cylinder was removed and the base was

placed at the bottom of a tank measuring 29 inches wide by 29 inches long and 24 inches deep. The bubble-generating base was placed in the center of the bottom of the tank as shown in Figure 3.9, lead bricks were placed on the corners to hold it in place, and the tank was filled with water to a depth of 40 cm above the height of the center of the diffusers and in order to provide a column of bubbles in the tank. Once again the containment cage was necessary to confine the density ball to the center of the bubble column. Otherwise, the flow due to the open environment would cause the ball to move to the boundary.

The closed environment configuration can be restored by using heavy-duty clear cellophane tape to reattach the cylinder. If this is done carefully, little if any leaking occurs. We found it necessary to reattach the cylinder during the course of our experiments.

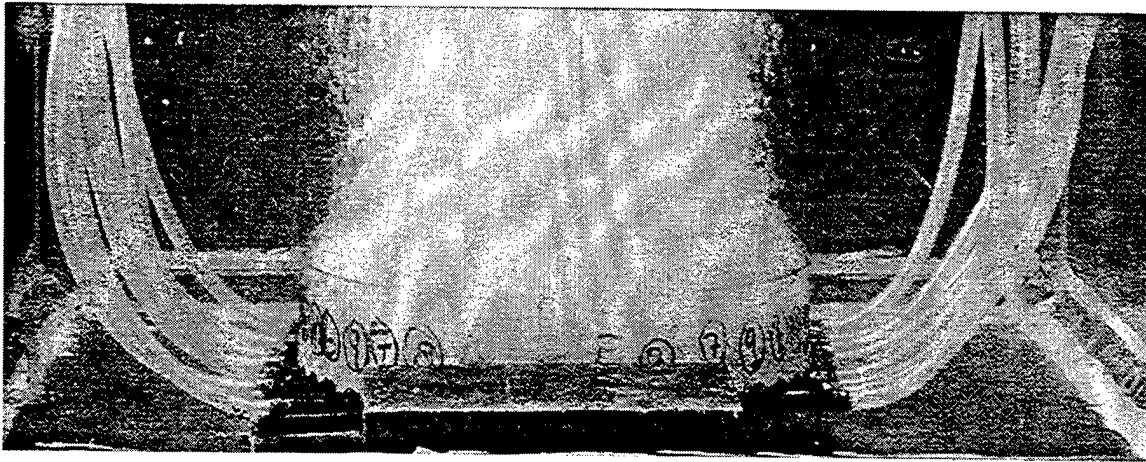

Figure 3.9. Bubble generating base immersed in tank to provide bubble column for open environment experiment. Shown in front is a lead brick that holds down the base.

## IV. EXPERIMENTS

Our objective in the experiment is to make a buoyant body sink by adding bubbles, to gather the data needed to use Equation (2.2) to calculate the density of the fluid when this occurs, and to compare the data to the theoretical prediction (Equation 2.3).

### A. SPECIFIC GRAVITY OF BODY

We required a buoyant body that was much larger relative to the bubbles so that we could treat the effects of the bubbly water on the object as those of a homogenous fluid. We selected a commercially available “density ball”, which is a hollow, stainless steel, 101.3 mm diameter sphere with a removable plug (Cenco Scientific Co. cat. #76595N). Liquid can be added or removed to vary the ball’s mass and thus its average density. Tap water was used in this experiment.

We obtain an accurate value of the volume of the ball by a variation of Archimedes’ method (weighing a body in and out of water). Sufficient liquid is added to the ball such that it will sink in water. We then place a container of water on a digital balance (AND Electronic Balance FX-2000), and “zero” the balance. The ball is suspended by string from a support and is totally immersed in the water without touching the container. We record the reading  $m$  of the scale. The buoyant force  $mg$  equals the weight  $\rho_w V_{\text{ball}}g$  of the displaced water. Taking the buoyancy of air into account,  $\rho_a = 0.0012 \text{ grams/cm}^3$  must be

subtracted from  $\rho_w$  so the volume of the ball is  $V_b = m/(\rho_w - \rho_a) = 557.6 \text{ cm}^3$ . The advantage of this method over Archimedes' method is that the suspension of the body from an elevated balance is avoided. Various ball masses and corresponding specific gravity values are displayed in Table 5.1.

specific gravity of ball	mass of ball (grams)
1.00	555.9
0.99	550.4
0.98	544.8
0.97	539.2
0.96	533.7
0.95	528.1
0.94	522.5
0.93	517.0
0.92	511.4
0.91	505.8
0.90	500.3
0.89	494.7
0.88	489.1
0.87	483.6
0.86	478.0
0.85	472.4
0.84	466.9
0.83	461.3
0.82	455.7
0.81	450.2
0.80	444.6
0.79	439.0
0.78	433.5
0.77	427.9
0.76	422.3
0.75	416.8
0.74	411.2
0.73	405.6
0.72	400.1
0.71	394.5
0.70	389.0

Table 5.1. Ball mass, as measured by a balance, as a function of average specific gravity of the ball. The volume of the ball is  $557.6 \text{ cm}^3$ . The specific gravity is based on the density of water at  $20^\circ \text{ C}$ :  $0.99821 \text{ grams/cm}^3$ . The masses in the table are the actual masses minus the mass  $0.67$  grams corresponding to the buoyancy of air.

## B. DETERMINATION OF BUBBLY WATER DENSITY

As explained in Chapter II, if air bubbles of total volume  $\Delta V$  are introduced into the water, the average density is  $\rho = (h_0/h)\rho_w$ . The ability to accurately determine the density of the bubbly water was critical to our experiment and a method that consistently provided a means to accurately determine the density was required.

A standard means of determining the density of bubbly water is to measure the initial height  $h_0$  of the water level in the chamber with no bubbles, and the change in height  $\Delta h$  when the bubbles are turned on and steady state has been reached. If the container has uniform cross-sectional area the average density of the bubbly water can be determined from Equation (2.2).

It was noticed through careful observation that for lower flow rates, bubbles were only produced on the top portion of the diffuser rod, and as the flow rate was increased, bubble production occurred further down the diameter of the rod thereby varying the starting height of the bubble column. This was taken into account by assuming a linear increase in the column height of one diffuser diameter throughout the flow range of 0 to 170 LPM (liters per minute).

We found that we were able to accurately measure the change in height only after the diffusers were in perfect balance; that is, the flow rate per unit length was identical from one diffuser to the next. As mentioned in Chapter IIIB, when slightly out of balance the bubble flow became very turbulent, eddies were observed within the volume of bubbly water and the surface took on a boiling like

appearance. We were then unable to measure the change in height with any sort of precision, therefore careful adjustment of the individual diffuser flow valves had to be made in order to bring the system into balance. Upon completion of this, the bubble flow became uniform throughout, eddies completely disappeared, and the surface became level.

The ability to accurately measure the change in height allowed us to use Equation (2.2) to determine the density of the bubbly water. Using the half-cylinder device discussed in Chapter IIID, the value  $\Delta h$  of the bubbly water was read directly from the apparatus at the point at which the density ball was observed to sink.

### **C. CLOSED ENVIRONMENT**

For the main part of the experiment, we determine the average density of the bubbly water required to sink the ball. We select an amount of liquid in the ball such that it floats in the water. We place the ball in the closed environment chamber, slowly increase the flow rate  $Q$ , and record the  $\Delta h$  value for which the ball sinks below the surface. We then use this value to calculate the density of the bubbly water and compare this to the ball's average density, which is determined as the total mass (including liquid inside) divided by the volume of the ball. The entire process is then repeated for a different value of the average density of the ball. Using Table 5.1, the specific gravity of the ball was varied within a range of 0.99 down to 0.74 and the average critical density of the fluid

required to sink the ball was determined at various points along this range.

Bubbles sticking to the lower half of the ball effectively lower the ball's average density, which make the ball neutrally buoyant at a higher airflow rate than expected. The number of bubbles sticking to the surface of the ball was reduced to nearly zero by machine polishing the ball and thoroughly cleaning it with isopropyl alcohol prior to each trial. Latex gloves were taken when handling the ball to prevent any fingerprints on the surface.

When the top of the ball is tangent to the surface of the fluid, there exists a shadow above the ball in which there are no bubbles. For low flow rates, we observe that the shadow has a uniform circular cross-sectional area that extends vertically from the equator of the ball to the surface of the fluid. Once the ball is sunk the "plume" bulges outward. The absence of bubbles above the ball could not be eliminated, so we incorporated estimations of this effect into the theory (Ch. II).

The criterion we set for determining the sinking of the ball was that it remains below the surface of the water for roughly 50% of the time. This benchmark was necessary to define the sinking of the ball because as the fluid density approached the density of the ball, because the ball tended to "loiter" in a volume of bubbly water just below the surface of the water rather than sinking directly to the bottom and would occasionally pop to the surface due to turbulence. Occasionally, during this loitering phase, the ball would subtly break the surface of the water.

Figure 5.1 shows the results of an experiment to determine the critical average fluid density (at which the ball just sinks). We can “zoom in” on the data by plotting the deviation of the critical average fluid density from the density of the ball, which is shown in Figure 5.2. The critical fluid density is seen to be significantly greater than the density of the ball, which is represented by the identity line in the graph, but less than the theoretical prediction. This may be a result of a competing upward force on the ball caused by rising bubbles impacting on the bottom surface of the ball, or by an upward drag due to the flow of bubbles or a local flow of water.

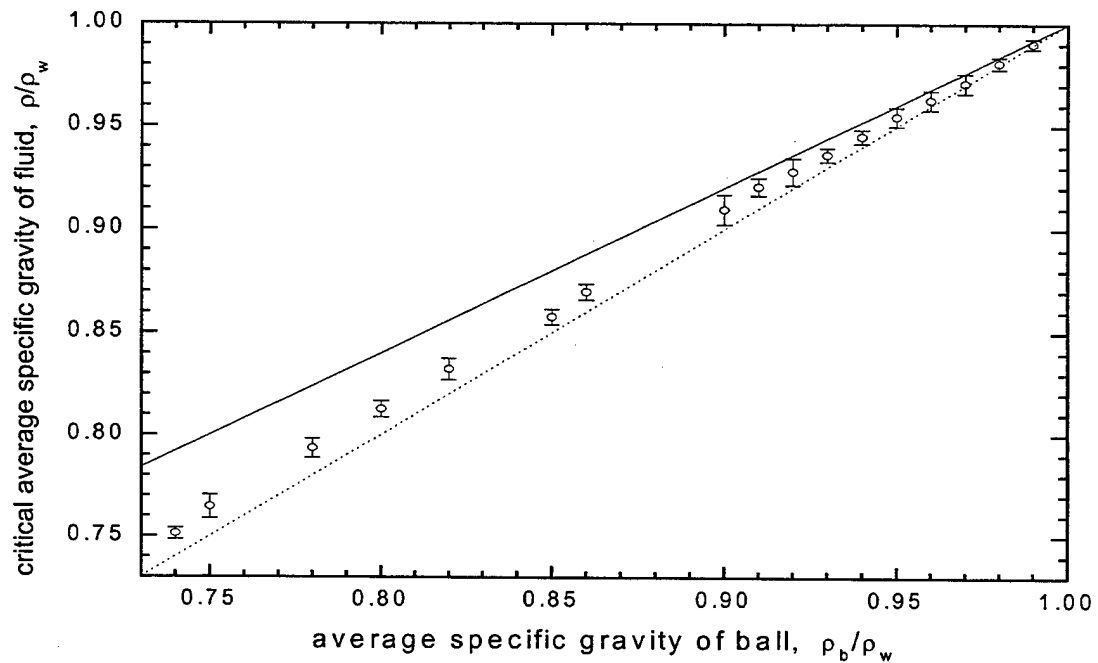

Figure 5.1. The fluid density at which the ball just sinks below the surface is significantly *greater* than the density of the ball, which is represented by the dotted identity line in the graph, but significantly less than the theoretical specific gravity of the bubbly water required to sink the ball, which is plotted as a solid line.

The observed increasing deviation of the critical density from the theory at higher flow rates may be due to the fact that the bubbles tend to flow up and around the ball, decreasing the volume of the shadow region above the ball that was taken into account by the theory.

Figure 5.1 does not appear to show the abrupt transition in the slope that was apparent in Pringle's graph (Pringle, 2000). However, Figure 5.2 shows that such a transition in the slope may be present. If the transition does exist, further research is required to ascertain whether or not it is caused by a change in fluid properties of the water as it shifts from a Newtonian to a non-Newtonian fluid, as hypothesized by Pringle (refer to the Appendix).

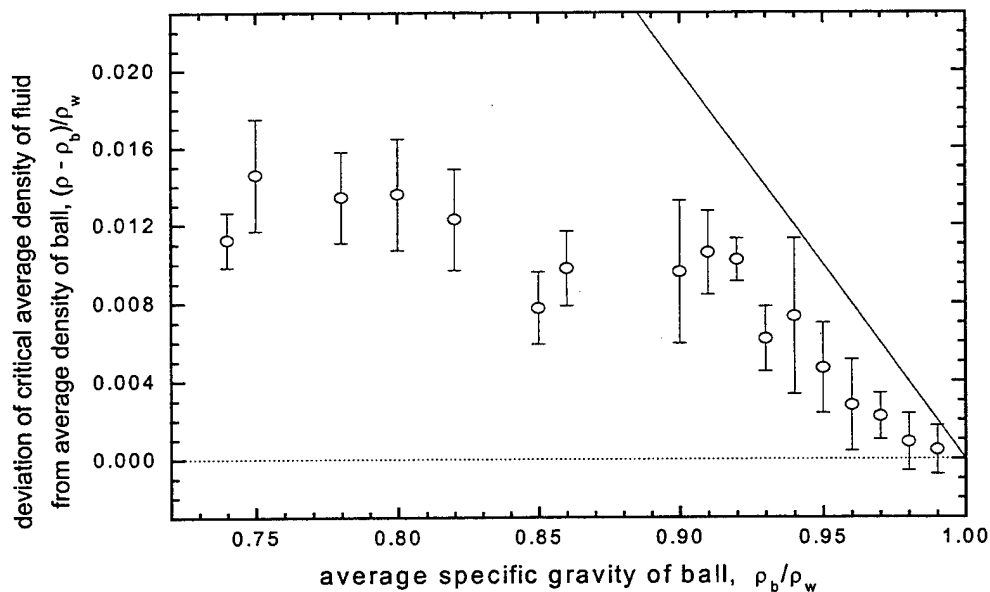

Figure 5.2. The deviation in the specific gravity of the fluid from the specific gravity of the ball versus the average specific gravity of the ball.

## D. OPEN ENVIRONMENT

Upon completion of the closed environment experiment we turned to the study of the open environment system. The top portion of the acrylic cylinder was removed and the bubble-generating base was immersed in the large tank as described in Chapter III. The open environment differed greatly from the closed environment. While the closed environment prevented circulation and large-scale flows into or out of the bubble column, the open environment did not. Without the cylinder enclosing the bubble column, small bits of paper placed in the tank revealed that there was a great deal of circulation occurring as rising bubbles entrained water, causing a substantial upward flow of water in the bubble column. The entrained water was carried to the surface where it continued to flow out in a radial direction from the bubble column, down near the sides of the tank and then back to the base of the bubble column to re-enter the flow at points along the column. As the flow rate was increased, the circulation increased as well. The liquid flow entering the bubble column squeezed the column in giving it an hourglass shape as seen in Figure 5.3. Because the hydrostatic pressure increases more quickly with depth in the bubble-free region, the resultant difference in pressure also contributes to the hourglass shape.

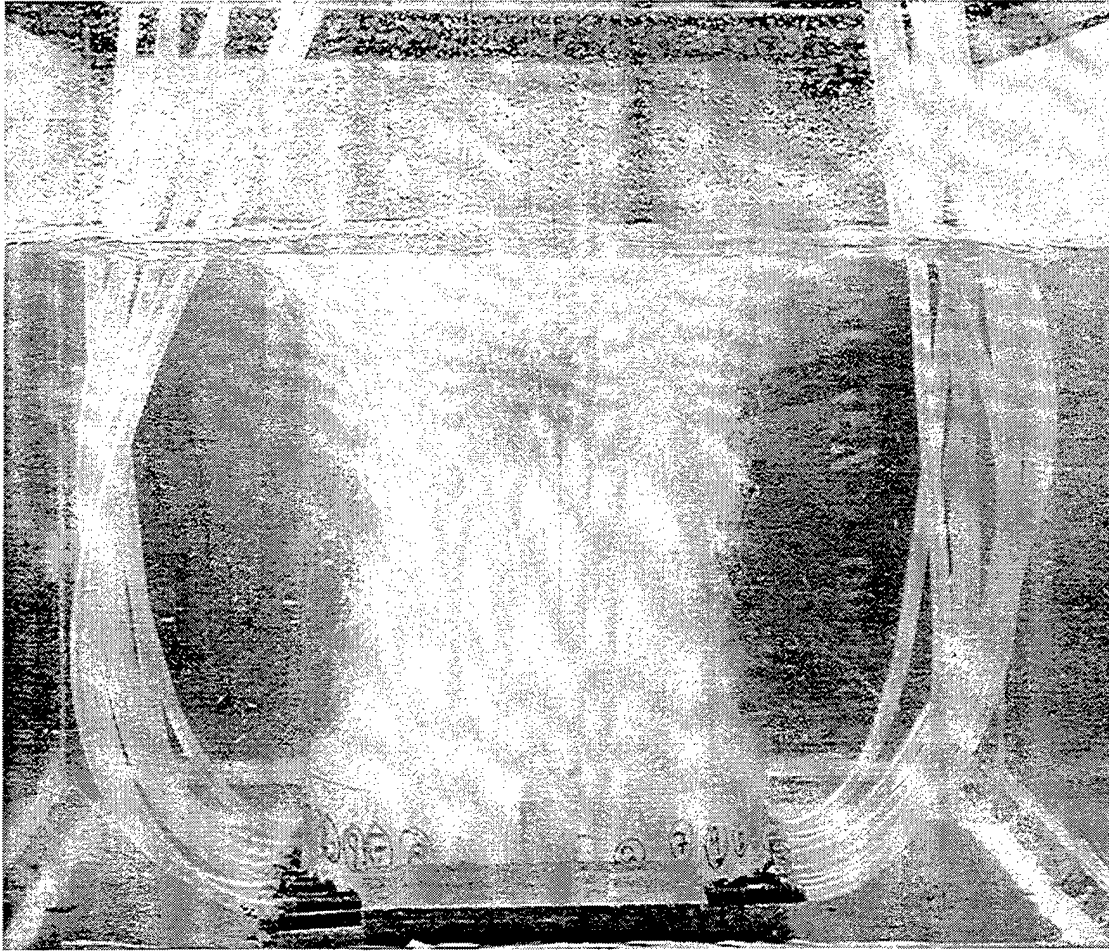

Figure 5.3. Bubbles generated in an open environment. Fluid flow into the bubble column compresses the bubble column at the center giving it an hourglass shape. The ball is visible near the surface.

To quantify the behavior of the ball in the open environment, we measured the vertical location of the ball for varying flow rates, for three different densities of the ball. The ball was filled with the required amount of liquid to adjust the ball's density to the appropriate value. The ball was then placed within the containment cage and centered over the bubble generator. The depth of the top of the ball above (negative values) or below (positive values) the surface of the water was measured for incremental values of the flow rate. This was crudely

done by placing a ruler, by hand, next to the ball and measuring its depth from the surface of the water from the side of the tank.

Figure 5.4 shows the graph of the flow rate versus the depth of the top of the density ball for three different specific gravities of the ball. Also plotted, as filled-in symbols, are the corresponding flow rates that the ball with the same specific gravity would have sunk at in the closed environment system. This graph surprisingly shows that for the same specific gravity, the ball requires *less* bubble flow in the open environment to sink below the surface than what is required in the closed environment. Figure 5.4 also shows that once the critical flow rate necessary to sink the ball was achieved, the ball rapidly sinks to a level a few centimeters below the water surface, gradually sinking to a lower level as the flow rate was increased until a saturation point was reached where the ball would not sink any lower even with increased flow rates. The ball would not sink below a point approximately halfway down the bubble column. This is evidently due to upward drag caused by the circulation of entrained water. The ball continues to sink until it reaches an equilibrium point where the competing force of the upward drag of bubbles and water, together with the buoyant force, equals the weight of the ball. Even at the maximum flow rate (170 LPM) of the apparatus, we were unable to sink the ball beyond the midway point.

Regarding the observation that the ball sinks at a flow rate that is less than that required in the closed environment, it is possible that the entering water flow due to the circulation causes the bubble column to squeeze in, thereby decreasing the volume that the bubbles are contained in and lowering the

average density of the fluid below the ball causing the ball to sink sooner than expected. In addition, the upward component of the drag may be small in this case because the ball is at the surface, where the flow fans out horizontally.

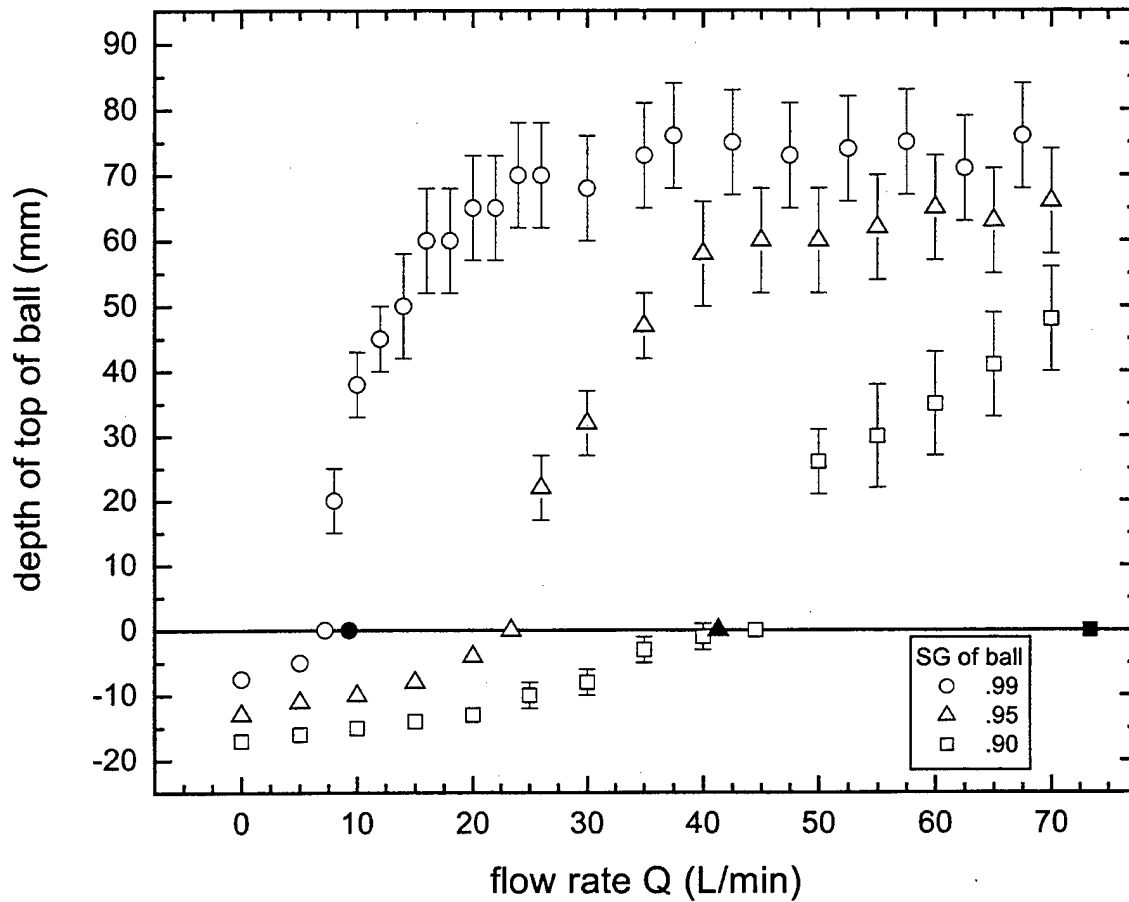

Figure 5.4. Depth of ball vs. flow rate for three selected specific gravities of the density ball. Filled-in (black) symbols indicate the flow rate the ball would have sunk in the closed environment.

THIS PAGE INTENTIONALLY LEFT BLANK

## V. CONCLUSIONS AND FUTURE WORK

### A. CONCLUSIONS

In our experimental investigations we showed that the introduction of air bubbles into a liquid decreases the average density, and thus decreases the buoyant force on a floating body. We investigated the critical average density required to sink a buoyant body in water with bubbles. A theory of the critical density for sinking was developed, and predicted that the average fluid density is greater than the ball density for sinking.

In the closed environment experiment, our research revealed that while the fluid density at which the ball just sinks below the surface of the water is *greater* than the density of the ball as predicted, it does not agree completely with our theory predicting the fluid density at which the ball should sink. We believe that these deviations are due to attributes of the bubbly flow that are difficult to quantify. Two specific attributes were identified. First, we neglected to take into account the effects of the bubbles impinging on the ball and the drag they caused, mainly because of the difficulty in determining their effect. Second, our theory made the assumption that the shadow above the ball has a uniform circular cross-sectional area that extends vertically from the equator of the ball to the surface of the fluid at all flow rates. Our observations made during the experiment indicate that at the higher flow rates the bubbles tended to flow up and around the ball, decreasing the volume of the shadow region above the ball.

Both of these effects will contribute to the fluid requiring a lower critical average density to sink the ball than predicted by the theory. This may explain the deviation of the data from theory, especially for the higher flow rates.

The open environment experiment dramatically revealed the complexity of the system. Constructing an apparatus that modeled an accurate open environment such as the ocean, and being able to gather precise data from it, proved to be very challenging. The lack of an enclosure for the bubble column such as the acrylic cylinder used in the closed environment experiment prevented us from being able to accurately measure the average density of the bubbly water in the column, in contrast to the closed environment experiment. Future work will require some other method for measuring the density of a bubbly flow in order to acquire precise data as was taken in the closed environment experiment.

We measured the height of the ball in relation to the surface of the water for varying flow rates for three different values of the specific gravity of the ball. The data show that for the same specific gravity, the ball requires less bubble flow in the open environment to sink than what is required in the closed environment. That is, the critical average density of the fluid required to sink the ball is greater. This is surprising because the upward drag due to the substantial entrained flow of water in an open environment is expected to cause the critical density to be less (i.e., greater flow rate). We believe the main cause of this is the large amount of circulation flow that occurred in the open environment as opposed to the closed environment. It is possible that the entering water flow

due to the circulation squeezes the bubble column, thereby decreasing the volume that the bubbles are contained in and lowering the average density of the fluid below the ball causing it to sink sooner than expected. We discovered that the ball continues to sink until it reaches an equilibrium point where the competing force of the upward flow of bubbles and entrained water, together with the buoyancy, equals the weight of the ball. Even at very high flow rates, the ball would not sink beyond a point about midway down the column where the vertical component of the upward flow was greatest as opposed to the upper portion of the column, where the vertical component of the flow was less as the flow changed direction and spread out horizontally across the surface of the tank.

## **B. FUTURE WORK**

This research would benefit from substantial further study. This thesis concentrated on the investigation of the bounded case where bubbles are generated uniformly over the cross-section of a container and the obtaining of publishable data.

Preliminary data from the open environment experiment showed that a smaller flow rate was required to sink the body than was needed in the closed environment experiment. Follow-on research could refine this data and lead to conclusions concerning the open environment. Future work might also include data and observations taken in a much larger tank than the one used, in order to better approximate the conditions found in the ocean. In this case, it may be that

the hourglass effect is reduced or nearly eliminated, which may resolve whether or not the lowering of the density due to this effect is playing an important role in the sinking of a body.

The possible transitional region in the slope of the data, where the two-phase flow may shift from a Newtonian to a non-Newtonian fluid, should be further investigated to confirm the speculation that it is indeed a change of fluid characteristics.

Another interesting observation was made that merits further investigation. While conducting the closed environment experiment without the containment cage, it was witnessed that the ball had a propensity to be propelled in a circular motion around the edge of the acrylic cylinder. We coined the term "bubble propulsion" to describe the circular motion displayed by the ball. The phenomenon occurs for a substantial range of flow rates, and the velocity at which the ball moved around the circumference of chamber increased as the volume of air supplied into the chamber was increased. The ball did not seem to favor movement in either direction, clockwise or counter-clockwise. To test this, we allowed the ball to begin movement in one direction, then forcibly stopped it and then allowed it to continue. The ball would continue motion in the opposite direction about the same amount that it would continue in the same direction it was previously moving. It was not immediately apparent whether this was caused by a boundary effect along the wall or some other effect. To probe whether or not the boundary plays a fundamental role, an experiment could be done in which the ball is tethered by a string whose other end is attached to a

swivel. If the effect continues to occur when the ball is not near the boundary, then the boundary is evidently not important.

A possible explanation for the bubble propulsion phenomenon is that the movement of the ball causes a slight increase in the bubble density in front of the ball and a slight decrease in back. Because the hydrostatic pressure increases more rapidly with depth for the decreased bubble density, an imbalanced pressure may develop that propels the ball in the direction of motion. Note that this effect is a spontaneous dynamic instability.

THIS PAGE INTENTIONALLY LEFT BLANK

## APPENDIX: NON-NEWTONIAN EFFECTS OF BUBBLY LIQUIDS

In research conducted by Pringle (2000), the plot of the specific gravity of the ball vs. the specific gravity of the fluid showed an abrupt transition in the slope occurring between 0.93 and 0.94 specific gravity of the ball. Pringle noted that the abrupt transition might be due to a change from Newtonian to non-Newtonian behavior of the fluid-air mixture. In an effort to explore this possibility, background research was conducted and references found that characterized Newtonian and non-Newtonian fluids. Results of these findings are summarized in this appendix to provide background information on the subject for possible further research.

Newtonian fluids, which include air, water, oils, alcohols, and many others, are characterized by the friction being described with sufficient accuracy by a linear relation between the shear stresses and the rate of strain. Specifically, a simple linear relationship is valid in laminar parallel flow and this relationship defines the shear viscosity:

$$\mu = \frac{\tau}{\frac{\partial v}{\partial y}},$$

where  $\mu$  is the shear viscosity,  $\tau$  is the shear stress, and  $v$  is the velocity.

This relationship implies three facts:

- 1) The shear stress action at the actual time on an arbitrarily chosen fluid particle depends only on the momentary state of motion of the particle. Its

motion at other times does not affect the shear stress occurring at the time.

2) The shear stress at a certain point depends only on the shear rate and therefore on the velocity gradient at this point.

3) The local shear stress is directly proportional to the shear rate.

Fluids exist that do not have these Newtonian properties and therefore do not have a linear relationship between shear stress and rate of strain. Molten plastics, polymer solutions, dyes, suspensions, and blood, for example, behave in certain circumstances in a way different from what one would expect for a Newtonian fluid. (Bohme, 1987)

For low values of particle volumetric concentration, suspensions of spherical particles are approximately Newtonian, and the ratio between the viscosity of the mixture and the viscosity of the fluid can be expressed as a function of the mixture's void fraction  $\alpha$ . Most non-Newtonian suspensions have a limiting viscosity  $\eta$  at high rates of shear, which can be related to the viscosity of the suspending fluid and the particle concentration.

The bubbly flow pattern is characterized by a suspension of discrete bubbles in a continuous liquid. Bubbly mixtures in laminar flow are Newtonian at low values of  $\alpha$  and the effective viscosity is given by:

$$\mu = \mu_f(1 + \alpha).$$

However, this equation is valid only for values of  $\alpha$  below about 0.05. At higher bubble concentrations the mixture rapidly becomes non-Newtonian, exhibiting a yield stress, and a decreasing apparent viscosity with increasing shear rate. To the extreme, foams exhibit considerable rigidity at high void fractions, and the bubbles behave like the atoms in a crystal. In an extensive search of literature on non-Newtonian behavior of bubbly liquids, we found no mention of any effect that causes a discontinuity in the derivative of a quantity as the void fraction is varied.

The speed with which coalescence of the bubbles occurs is particularly sensitive to impurities, even in minute quantities. Velocity gradients and turbulence tend to increase the rate at which small bubbles collide, thus promoting agglomeration, but also have the effect of tearing apart the bigger bubbles. The transition from bubbly flow to slug flow occurs approximately at 10 percent void fraction for "pure" liquids although bubbly flow has been reported at 60 percent void fraction in tap water. At the other extreme there exist foaming agents that allow bubbly flow to persist up to virtually 100 percent void fraction. In our experiment, very little coalescence of the bubbles was observed to occur. The only exception to this was when a small amount of surfactant (Kodak Photo-Flo) was added to the water in an effort to reduce the amount of foam collecting at the surface of the cylinder, which hampered the reading of the water level. The result was that at higher flow rates, the bubbles tended to coalesce into larger bubbles causing turbulence and a boiling effect in the water. (Wallis, 1969)

THIS PAGE INTENTIONALLY LEFT BLANK

## LIST OF REFERENCES

Bohme, Gert, *Non-Newtonian Fluid Mechanics*, Elsevier Science Publishers, pp. 46-47, 1981.

Lide, David R., *Handbook of Chemistry & Physics*, 74<sup>th</sup> ed., pp 8.18-34, CRC Press Inc., 1994.

McIver, Richard D., "Role of Naturally Occurring Gas Hydrates in Sediment Transport," *American Association of Petroleum Geologists*, Bulletin, 66:789, 1982.

Joint USAEC-Euratom Research and Development Program Report NYO-3114-12, *Bubbly Flow in Straight Pipes*, by P.E. Meyer and G.B. Wallis, Thayer School of Engineering, Dartmouth College, Hanover, New Hampshire, pp. 2-3, 15, November 1965.

Pringle, L. B., *Experimental Investigation of Sinking a Buoyant Body in Water with Bubbles*, Master's Thesis, Naval Postgraduate School, Monterey, California, June 2000.

Rowe, Mary M. and Gettrust, J. F., "Methane Hydrate Content of Blake Outer Ridge Sediments," New York Academy of Science International Conference on Natural Gas Hydrates, 1993.

Stumborg, Michael F., "Buoyancy Bomb" Power Point Presentation, Naval Surface Warfare Center, Dahlgren Virginia, March 2000.

Turner, J.C.R., "On Bubble Flow in Liquids and Fluidized Beds," *Chemical Engineering Science*, v. 21, pp. 971-974, 1966.

Wallis, G. B., *One-dimensional Two Phase Flow*, pp. 263-264, 27, McGraw-Hill Inc., 1969.

Whalley, P.B., 1987, "Boiling, Condensation, and Gas-Liquid Flow," Oxford University Press, pp. 15-25.

THIS PAGE INTENTIONALLY LEFT BLANK

## INITIAL DISTRIBUTION LIST

1. Defense Technical Information Center ..... 2  
8725 John J. Kingman Rd., STE 0944  
Ft. Belvoir, Virginia 22060-6218
2. Dudley Knox Library ..... 2  
Naval Postgraduate School  
411 Dyer Rd.  
Monterey, California 93943-5101
3. Physics Department..... 2  
Naval Postgraduate School  
833 Dyer Road  
Monterey, CA 93943-5002
4. Professor Bruce Denardo, Code PH/Db ..... 5  
Department of Physics  
Naval Postgraduate School  
Monterey, CA 93943-5002
5. Professor Ashok Gopinath, Code ME/Gk ..... 1  
Department of Mechanical Engineering  
Naval Postgraduate School  
Monterey, CA 93943-5146
6. Engineering & Technology Curricular Office, Code 34 ..... 1  
411 Dyer Road  
Naval Postgraduate School  
Monterey, California 93943-5101
7. Carl DeGrace..... 2  
24 Thames Street  
Newport, RI 02840