

---

# Spintronics

---

20010320 120

JASON  
MITRE

---

# Spintronics

---

Study Leader:  
Robert Westervelt

Contributors Include:

Kenneth Case  
William Dally  
Alvin Despain  
Douglas Eardley  
Norval Fortson  
Jonathan Katz  
Will Happer  
William Nierenberg  
Malvin Ruderman  
Jeremiah Sullivan

February 2001

JSR-99-115

Approved for public release; distribution unlimited.

JASON  
The MITRE Corporation  
1820 Dolley Madison Boulevard  
McLean, Virginia 22102-3481  
(703) 883-6997

# REPORT DOCUMENTATION PAGE

*Form Approved*  
OMB No. 0704-0188

Public reporting burden for this collection of information estimated to average 1 hour per response, including the time for review instructions, searching existing data sources, gathering and maintaining the data needed, and completing and reviewing the collection of information. Send comments regarding this burden estimate or any other aspect of this collection of information, including suggestions for reducing this burden, to Washington Headquarters Services, Directorate for Information Operations and Reports, 1215 Jefferson Davis Highway, Suite 1204, Arlington, VA 22202-4302, and to the Office of Management and Budget, Paperwork Reduction Project (0704-0188), Washington, DC 20503.

<b>1. AGENCY USE ONLY (Leave blank)</b>		<b>2. REPORT DATE</b> February 5, 2001	<b>3. REPORT TYPE AND DATES COVERED</b>	
<b>4. TITLE AND SUBTITLE</b>  Spintronics			<b>5. FUNDING NUMBERS</b>  13-988534-A4	
<b>6. AUTHOR(S)</b>  Robert Westervelt, et al.				
<b>7. PERFORMING ORGANIZATION NAME(S) AND ADDRESS(ES)</b>  The MITRE Corporation JASON Program Office 1820 Dolley Madison Blvd McLean, Virginia 22102			<b>8. PERFORMING ORGANIZATION REPORT NUMBER</b>  JSR-99-115	
<b>9. SPONSORING/MONITORING AGENCY NAME(S) AND ADDRESS(ES)</b>  Defense Advanced Research Projects Agency 3701 North Fairfax Drive Arlington, Va. 22203-1714			<b>10. SPONSORING/MONITORING AGENCY REPORT NUMBER</b>  JSR-99-115	
<b>11. SUPPLEMENTARY NOTES</b>				
<b>12a. DISTRIBUTION/AVAILABILITY STATEMENT</b>  Approved for Public Release - Distribution Unlimited			<b>12b. DISTRIBUTION CODE</b>  Distribution Statement A	
<b>13. ABSTRACT (Maximum 200 words)</b>  This is a presentation of the JASON summer study on Spintronics done at DARPA's request in 1999.				
<b>14. SUBJECT TERMS</b>			<b>15. NUMBER OF PAGES</b>	
			<b>16. PRICE CODE</b>	
<b>17. SECURITY CLASSIFICATION OF REPORT</b>  Unclassified	<b>18. SECURITY CLASSIFICATION OF THIS PAGE</b>  Unclassified	<b>19. SECURITY CLASSIFICATION OF ABSTRACT</b>  Unclassified	<b>20. LIMITATION OF ABSTRACT</b>  SAR	

# Spintronics

---

## Introduction

DARPA Spintronics

JASON 1999

This is a presentation of the JASON summer study on Spintronics done at DARPA's request in 1999. Bob Westervelt was the study leader and a number of JASONS participated in the study.

## Workshop Participants

---

David Awschalom	Univ. California Santa Barbara
Berry Jonker	Naval Research Laboratory
Tom McGill	DSRC/Caltech
Michael Roukes	Caltech
Stuart Parkin	IBM Almaden
Jon Slaughter	Motorola
Richard Osgood	DSRC/Columbia
Ivan Schuller	Univ. California San Diego
Darryl Smith	DSRC/Los Alamos
Stuart Wolf	DARPA

DARPA Spintronics

JASON 1999

A one-day workshop was held at the summer study on July 13, 1999. Six experts on topics in spintronics gave presentations: David Awschalom from the University of California, Santa Barbara, Berry Jonker from the Naval Research Laboratory, Tom McGill from the DSRC and Caltech, Michael Roukes from Caltech, Stuart Parkin from IBM Almaden, and Jon Slaughter from Motorola. The DSRC was very helpful to the study and a number of participants visited from the DSRC and local institutions: Richard Osgood from the DSRC and Columbia University, Ivan Schuller from the University of California, San Diego, and Darryl Smith from the DSRC and Los Alamos National Laboratory. Stuart Wolf of DARPA played an important role in helping to organize the workshop and study.

## Outline

---

- Spintronics - overview
- Magnetic Random Access Memory (MRAM)
- Spin lifetimes in semiconductors
- Spin injection in semiconductors
- Materials
- Applications
- Summary and conclusions

DARPA Spintronics

JASON 1999

An outline of this talk is shown above. We start with an overview of spintronics, then move on to specific topics. Magnetic Random Access Memory is a new technological development which combines metal magnetic elements with semiconductor readout to make nonvolatile memory chips. Spin lifetimes in semiconductors and spin transport have been recently studied using optical generation and detection of polarized electrons. Spin injection from polarized conductors could be very useful in the creation of spinelectronic devices. Special materials have possible use in spintronics. A number of possible applications of spintronics are presented. The talk is ended with a summary and list of conclusions.

## Spintronics Overview

---

- Giant magnetoresistance (GMR)
  - GMR disk drive heads
- Magnetic random access memory (MRAM)
  - IBM, Motorola with DARPA support
- Spin lifetimes in semiconductors
  - long lifetimes (>100 ns) in GaAs
- Spin transport in semiconductors
  - long distances (>100  $\mu\text{m}$ ) in GaAs

DARPA Spintronics

JASON 1999

This slide presents an overview of spintronics research.

Giant magnetoresistance was discovered about ten years ago in layered metal systems. They show large (>10%) changes in resistance when a weak applied magnetic field (~10 Oe) is applied. Giant magnetoresistance heads have taken over most of the computer hard disk drive industry, because they provide superior performance at low cost.

Random access memory chips based on magnetic tunnel junctions or giant magnetoresistance elements have been developed by IBM and by Motorola recently with DARPA support. They provide nonvolatile memory at high density and could have applications in the relatively near term.

Long spin lifetimes, to above 100 nsec, have been observed in n-type GaAs at low temperatures, and long spin transport distances, to above 100  $\mu\text{m}$ , have been measured. These could make possible new types of applications.

## Spintronics Overview (cont.)

---

- Spin injection into semiconductors
  - interfaces important
- Spintronics materials
  - InAs/GaSb/AlSb superlattices
  - (Ga,Mn)As ferromagnetic semiconductors
- Possible applications
  - magnetic random access memory
  - magnetic field sensors
  - spin field effect transistors
  - quantum state based electronics
  - quantum computers

DARPA Spintronics

JASON 1999

Spin injection from magnetically polarized electrical contacts into semiconductors could enable new spin-based devices. Experimental work looks promising, but is limited at present by interfaces which relax spin. Further work is needed to understand and reduce spin relaxation in injection. InAs/GaSb/AlSb superlattices permit spin splitting in zero applied magnetic field and may have applications in spintronics.

A ferromagnetic semiconductor (Ga,Mn)As has been demonstrated with Curie temperatures to 110°K. Ferromagnetic semiconductors may ease spin injection by eliminating the ferromagnetic metal to semiconductor interface.

Spintronics may make possible a range of new applications. MRAM chips are well along the path to useful devices, and may reach the market in the near future. Giant magnetoresistance and other spintronic devices provide sensitive magnetic field sensors at relatively low cost, and could find uses in addition to hard disk drive heads. Spin effect transistors have been demonstrated, and may find specialized applications. New approaches to electronic devices and circuits based on quantum effects and quantum states often are sensitive to spin state, and the control of spins could be important for this entire field. Spins are natural candidates for Q-bits of future experimental implementation of quantum computer devices. Although quantum computer experiments are at a very early stage, the theory is more advanced and often uses spins as the fundamental element.

## Giant Magnetoresistance (GMR)

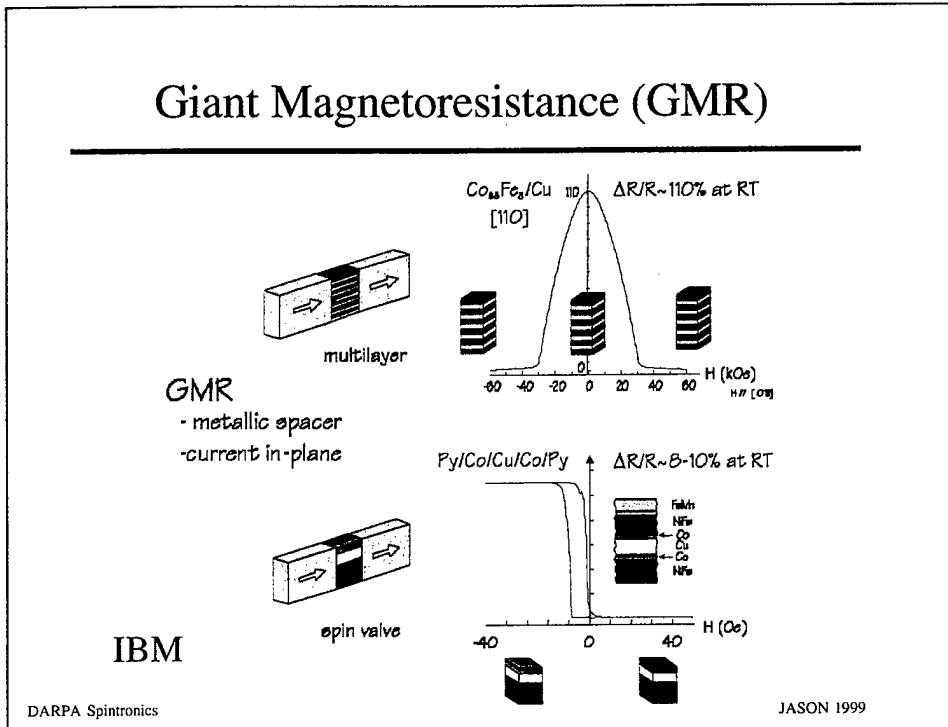

Giant magnetoresistance was discovered about ten years ago in layered metal systems. They show large ( $>10\%$ ) changes in resistance when a weak applied magnetic field ( $\sim 10$  Oe) is applied.

The figure illustrates two examples:

Multilayer giant magnetoresistance  $\text{Co}_{95}\text{Fe}_5/\text{Cu}$  stacks show a 110% increase in resistance near  $H = 0$  when the alignment of the magnetization alternates between layers, as indicated by the red and blue color coding. At about  $H = 30$  kOe, the magnetization aligns and the resistance increase is destroyed.

A giant magnetoresistance structure shown below shows a 8 to 10% increase in resistance for a 10 Oe increase in magnetic field, as the alignment of the top magnetic layer reverses direction, indicated by the red and blue color coding. The polarization of the lower layer is pinned by the magnetic substrate, as shown.

Giant magnetoresistance heads have had a strong effect on the computer hard disk drive industry, because they provide superior performance at low cost.

## Magnetic Random Access Memory

---

IBM and Motorola have developed non-volatile MRAM with DARPA support

MRAM based on magnetic tunnel junctions or giant magnetoresistance

**advantages -**

non-volatile

fast read and write (to ~10ns)

cell size ~ DRAM

low voltage

DARPA Spintronics

JASON 1999

With DARPA support since 1996, IBM and Motorola have developed magnetic random access memory chips (MRAM). These combine semiconductor readouts with magnetic elements using giant magnetoresistance or magnetic tunnel junctions (MTJ). The advantages of this approach are that MRAM is nonvolatile - the magnetic state is retained even with no applied power - they have fast read and write times projected to reach values ~10 ns in about 5 years, their cell size is small - comparable to DRAM, and they can be operated with relatively low voltages. In addition, MRAM is comparatively insensitive to radiation damage.

## MRAM Architecture

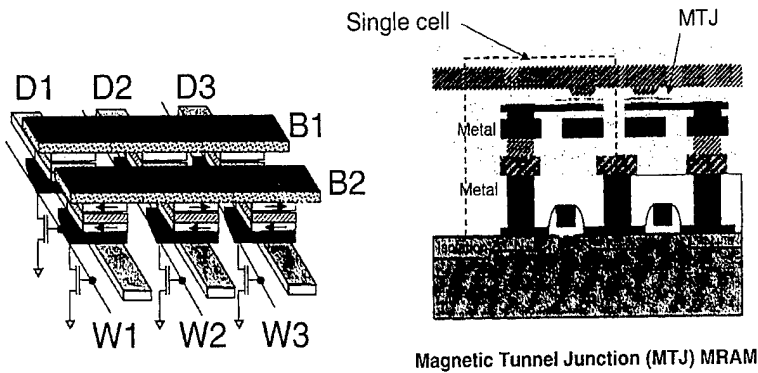

Motorola

DARPA Spintronics

JASON 1999

This slide illustrates one MRAM architecture developed by Motorola.

A sketch of the three dimensional structure is shown in the left figure. Two sets of conductors - the digit lines D1, D2 and D3 and the bit lines B1 and B2 - are used to write bits on individual sites, and a set of word lines W1, W2, and W3 are used to randomly read out individual sites.

A sketch of a cross section of the memory chip is shown on the right, showing the location of the magnetic tunnel junctions (MTJ) which magnetically store the bits. The lower parts of the chip can be made using CMOS technology, and the magnetic parts added by specialized processing afterward.

## Magnetic Tunnel Junction (MTJ)

---

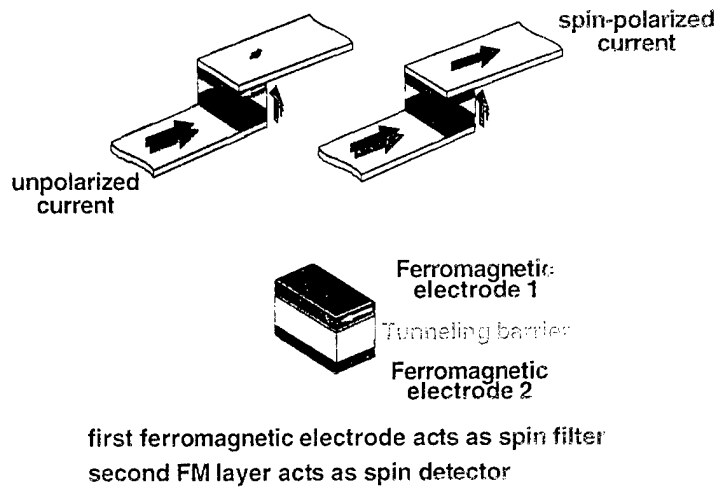

DARPA Spintronics

JASON 1999

Magnetic tunnel junctions use magnetic polarization of two ferromagnetic metal layers to control the current through a tunneling barrier, as indicated in the figure. The first ferromagnetic layer acts as a spin filter to determine the preferred polarization of electrons tunneling into the second ferromagnetic layer which acts as a spin detector.

## MRAM Program Mode

MTJ Memory Cell with Xtor.

Cell Write is accomplished by applying orthogonal currents through the Digit line and Bit line. The intersection of these fields switches the free layer.

Motorola

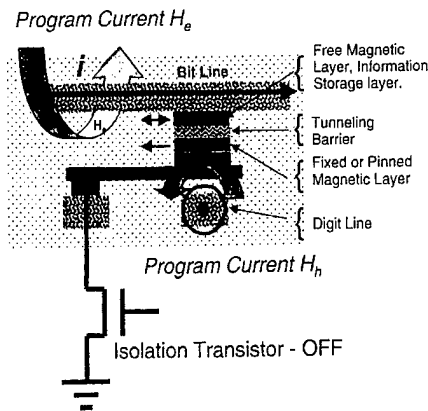

DARPA Spintronics

JASON 1999

This slide illustrates how a bit is written in a magnetic tunnel junction MRAM. The magnetic tunnel junction consists of two ferromagnetic metal layers joined by an insulating tunnel junction. As indicated, the top ferromagnetic layer is free, in the sense that the direction of its magnetization can be easily changed by a small magnetic field. The bottom ferromagnetic layer is fixed, in the sense that its magnetization is pinned and requires a much larger magnetic field to flip. The conduction of the MTJ depends on whether the magnetization of the top and bottom ferromagnetic layers is aligned or opposing.

The bit is written onto an individual MTJ by passing a current through both a bit line and a digit line, creating magnetic fields as indicated in the figure. Their amplitude is adjusted to flip the direction of magnetization in the free ferromagnetic layer to the desired direction while leaving the magnetization of the fixed layer unchanged. During this process the isolation transistor is turned off.

## Read Mode Signal Path

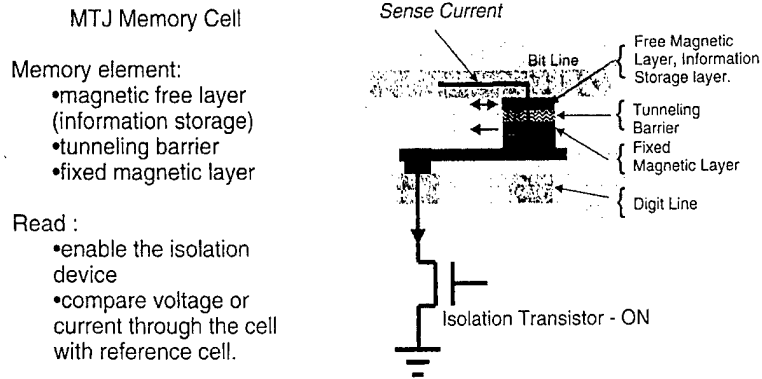

Motorola

DARPA Spintronics

JASON 1999

This slide illustrates how a stored bit can be read out.

The bit is read out by passing a current through the desired memory element by turning on the isolation transistor. The resulting voltage (or current) is compared with a reference site to determine whether the bit is a 0 or a 1. Reading is nondestructive to the stored bit and can be repeated many times.

In summary, the development of MRAM technology is fairly advanced. Developmental MRAM chips with 1M bits are predicted this year by Honeywell, and smaller chips have already been produced. The advantages of MRAM - nonvolatile storage and relatively small cell size - are attractive for applications. Additional work is needed on a number of issues in manufacturing in order to bring MRAM into production. If these potential problems are solved, it seems possible that MRAM may appear in the market relatively soon.

## MRAM Magnetic Tunnel Junction Device

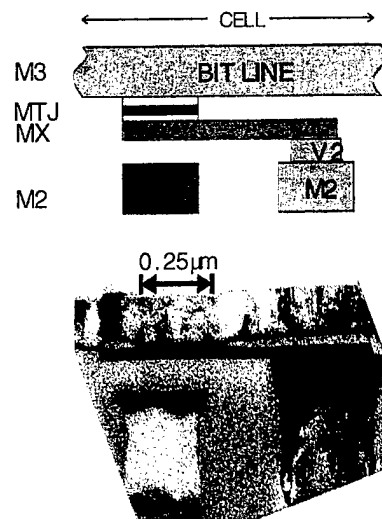

IBM

DARPA Spintronics

JASON 1999

This figure shows a schematic drawing and a transmission electron micrograph of a MRAM magnetic tunnel junction device developed by IBM. As indicated the size of the magnetic tunnel junction (MTJ) and word line are about 0.25 microns, comparable to feature sizes in current CMOS memory. The MX line connects the magnetic tunnel junction to one of its leads.

## Optical Studies of Electron Spin in GaAs

---

- Optical pumping and detection
  - spins oriented by circularly polarized light
  - orientation detected by
    - circular polarization of photoluminescence
    - Faraday rotation
- Long spin lifetimes in n-type GaAs
  - $T_2 > 100$  nsec
  - spin transport  $> 100\mu\text{m}$
- Possible applications
  - quantum information storage
  - spin-transport devices

DARPA Spintronics

JASON 1999

At the spintronics workshop David Awschalom described recent measurements of electron spin lifetimes and transport in GaAs and other materials which use optical methods to create and sense spin polarization.

Optical pumping and detection can be used to create polarized spins and sense the orientation of spins at later times. A short pulse of circularly polarized light creates polarized electrons and holes in a semiconductor like GaAs. The orientation of the electrons can be sensed later by measuring the circular polarization of photoluminescence as the created carriers recombine. The Faraday rotation of light can also be used to measure the polarization of electron spins, even when few holes are present.

Awschalom and coworkers found that n-type GaAs displayed relatively long lifetimes for electron spin, up to  $T_2 > 100$  nsec at low temperatures, and found that electron spins could be transported for distances as long as  $>100 \mu\text{m}$ . In neutral GaAs the spin relaxation time is much shorter, due to the recombination of photoexcited electron hole pairs. However in n-type GaAs the photo excited holes recombine with electrons from donors, leaving behind a polarized electron gas in which spin relaxation occurs much more slowly.

Spin polarized electrons in semiconductors may find applications in information using quantum effects and states, or in new spin-transport devices.

## Optical Spin Orientation and Detection

Optical transitions between valence and conduction bands

Spin orientation by excitation with circularly polarized light:

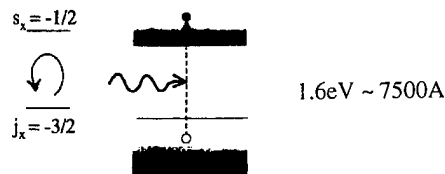

Spin detection by circular polarization of photoluminescence:

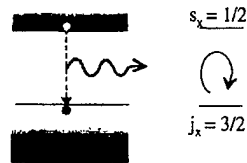

DARPA Spintronics

JASON 1999

This slide describes the creation and detection of polarized electron spins by circularly polarized light.

As illustrated in the top figure, absorbed circularly polarized light creates an electron-hole pair with polarized spin. Short light pulses can create polarized electrons by this mechanism.

In the bottom figure the detection of spin polarization by photoluminescence is shown. This method works for short times before both electrons and holes created by the excitation pulse recombine.

## Pump-probe Studies of Spin Precession

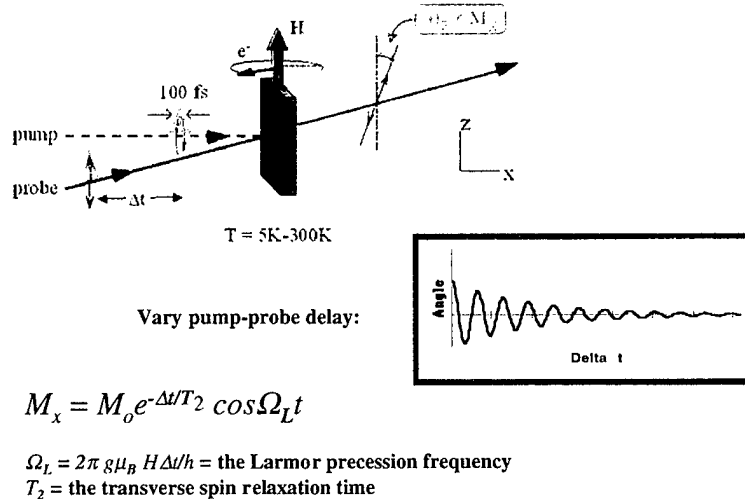

DARPA Spintronics

JASON 1999

This slide illustrates the use of Faraday rotation to detect spin polarization. This method works for doped material at times longer than the excited carrier lifetime in pure material and was used by Awschalom et al. to study electron spin polarization in n-type GaAs.

Electron-hole pairs are created in a slab of semiconductor material by using a short 100 fsec pulse of circularly polarized light as a pump. A short pulse of polarized light is passed through the sample as a probe at a time  $\Delta t$  later. An applied magnetic field  $H$  causes electron spins to precess, as illustrated. Faraday rotation of the probe pulse of light measures the magnetization  $M_x$  as illustrated by the graph. For simple cases  $M_x$  decays exponentially with a characteristic relaxation time given by  $T_2$  the transverse spin relaxation time. Although many spins are created in the sample by the pump light pulse, their motion is called coherent, because these spins tend to precess together, and one can examine the motion of single spins as in magnetic resonance.

## Benefit of n-type Doping: Reduced Electron-hole Spin Relaxation

Holes that are left in valence band after excitation normally are major source of excited electron spin relaxation.

But holes are filled quickly by extra conduction electrons that are present due to n-doping.

Result: Holes are no longer left to relax the spins of the optically excited electrons.

Allows  $T_2 > 1$  nsec at room temperature and  $> 100$  nsec in bulk GaAs at 5K.

2D electron gas:  $\text{Zn}_{0.8}\text{Cd}_{0.2}\text{Se}$  10.5nm quantum well

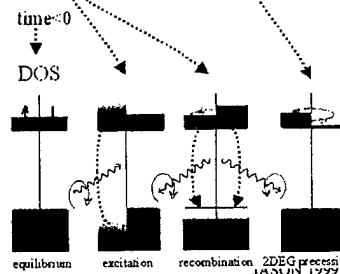
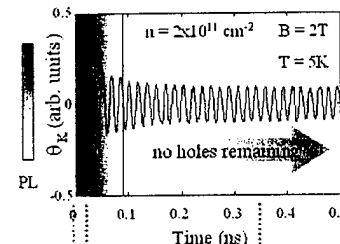

DARPA Spintronics

N-type doping reduces spin relaxation by electron-hole recombination.

After a pump pulse of light creates electron-hole pairs with polarized spin, this polarization is destroyed by recombination. However in n-type material the excess holes are rapidly filled by recombination with electrons from the doping. The figure illustrates this effect for a ZnCdSe quantum well with electron density  $n = 2 \times 10^{11} \text{ cm}^{-2}$  in a magnetic field of 2 T at temperature 5 K. After the recombination in about 0.1 nsec most excited holes are gone, and the electron spin can exist for much longer times, as shown.

Doping permits spin relaxation times  $T_2 > 1$  nsec for n-type bulk GaAs at room temperature and  $T_2 > 100$  nsec at 5 K.

## Dependence of $T_2$ on n-type Doping

Phys. Rev. Lett. 80, 4313 (1998).

50  $\mu\text{m}$  thick  
Si-doped GaAs

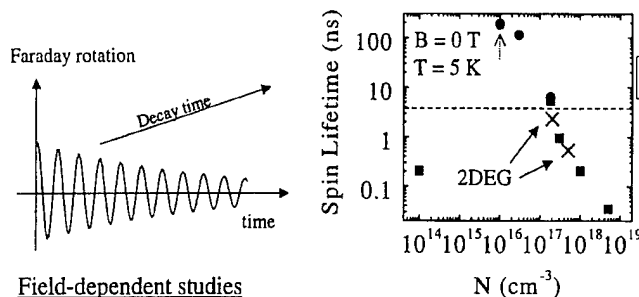

Field-dependent studies

$$M_x(\Delta t, B) = M_0 e^{-\frac{\Delta t}{T_2}} \cos\left(\frac{g\mu_B B \Delta t}{\hbar}\right) \quad \text{scan delay or magnetic field}$$

DARPA Spintronics

JASON 1999

This slide shows the effect of donor density  $N$  on spin lifetime measured for n-type GaAs at low temperatures. The main features of the spin relaxation data are understood.

The short  $T_2$  at low doping (the isolated point at the left of the graph) can be caused by holes excited in weakly doped material. The spin of excited holes relaxes very rapidly by spin orbit coupling, and the conduction electron spin then rapidly relaxes by electron-hole coupling.

For doping levels above  $10^{16} \text{ cm}^{-3}$ , there are enough free electrons in the conduction band to fill these holes rapidly and eliminate this source of spin relaxation. The lifetime is 3 orders of magnitude longer at  $N = 10^{16} \text{ cm}^{-3}$  than at  $N = 10^{14} \text{ cm}^{-3}$ .

The decrease in spin lifetime with increasing doping level above  $n = 10^{16} \text{ cm}^{-3}$  is due in large part to the D'Yakanov-Perel (DP) relaxation mechanism discussed in slide 20. These higher electron densities are above the metal transition. At 5 K the charge carriers near the Fermi energy increase in energy as  $N$  increases. Because the DP spin relaxation rate rapidly increases with energy, as shown in slide 17,  $T_2$  falls off rapidly with increasing  $N$ .

# Study Long $T_2$ : Resonant Spin Amplification

## Synchronous Pumping

Set  $B$  such that integral number of Larmor periods take place between excitation pulses.

Spin polarization will build up if many pump pulses occur before spins relax.

If  $B$  varied, there will be sharp resonance peaks of width  $\Delta B$  determined by  $T_2$ :  $\Delta B = \hbar / (2\pi g \mu_B T_2)$

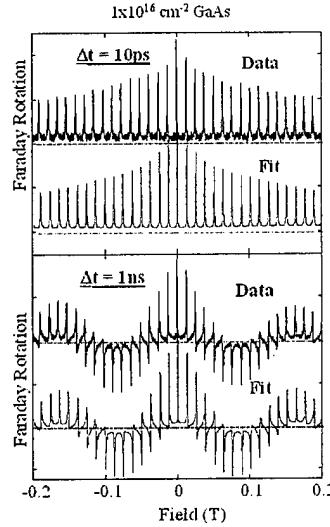
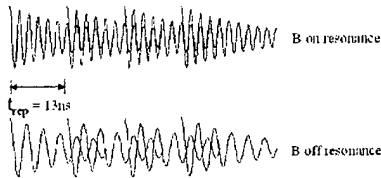

DARPA Spintronics

JASON 1999

Resonant spin amplification can be used to study long spin relaxation times  $T_2$ . As illustrated in the figure at the lower left, repetitive pumping light pulses can resonantly increase the electron spin density when the time interval  $t_{rep}$  between pump pulses equals an integer number of cycles of spin precession. When the times do not match, then later pump pulses can help depolarize the electron spins. The effect is a sharp increase in Faraday rotation of the probe light pulse at magnetic fields which produce precession rates which give resonance, as illustrated by the data and theory fits shown on the right. For a short delay  $\Delta t = 10$  psec between pump and pulse the peaks all have the same sign, while for a longer delay  $\Delta t = 1$  nsec the sign of the peaks oscillates due to the precession in spin direction during the delay. The agreement between data and theory fits supports this interpretation.

## Sources of Spin Relaxation for Electrons

---

- Dependence of  $g$ -factor on electron energy
  - GaAs:  $g = -0.44 + 6.3 E(\text{eV})$
  - Energy dependence spreads Larmor frequencies.
- Spin-orbit splitting in conduction band
  - Crystals like GaAs with no inversion symmetry ( $k$  to  $-k$ ) can have spin splitting and effective internal field  $B_{\text{int}}$
- Collisions with impurities or phonons
  - spin-orbit coupling mixes energy bands - causes spin flip during a collision
- Hyperfine coupling to nuclei: localized electrons

**First 3 each dominates over some range of T, B.**

DARPA Spintronics

JASON 1999

A number of sources of spin relaxation can be important for electrons in GaAs and other semiconductors.

Because the mass of electrons in semiconductors is not the same as the free electron mass, and because the energy bands are not simply parabolic, the  $g$  factor of electron spins has a value other than two and varies with electron energy  $E$ . The expression for GaAs is given above. The energy dependence of  $g$  causes a spread in Larmor frequencies for electron spins in experiment, and limits the coherence of a gas of precessing electron spins.

For materials like GaAs with no inversion symmetry in the lattice the electron energy need not be the same for wavevectors  $k$  and  $-k$ . As a result the energies of electron spin states can differ even in zero applied magnetic field, creating an effective internal field  $B_{\text{int}}$ .

Collisions with impurities or phonons can be coupled with spin flips by spin-orbit coupling, inducing spin relaxation. Hyperfine coupling between electrons and nuclei can induce spin relaxation, particularly for localized electrons.

The first three mechanisms can dominate spin relaxation over some range of temperature and magnetic field.

## D'Yakanov-Perel' (DP) Spin Relaxation

---

When the conduction band has no inversion symmetry, as in GaAs, the electron Hamiltonian is:  $H = p^2/2m + \alpha m^{-1}(2mE_g)^{-1/2}(\sigma \cdot \kappa)$  where  $\kappa_x = p_x(p_y^2 - p_z^2)$  and cyclically  $x, y, z =$  crystal axes

The second term in  $H$  describes an effective internal field  $B_{\text{int}}$ . The Larmor precession of angular frequency  $\Omega_{\text{int}}$  about  $B_{\text{int}}$  will change randomly after each collision with impurities or phonons, leading to a spin-relaxation rate:  $(1/T_2)_{DP} = (\Omega_{\text{int}})^2 \tau_c$  where  $\tau_c$  is the time between collisions.

**Note that  $(1/T_2)_{DP}$  rises rapidly with electron energy, scaling as  $(kT)^3$ .**

DARPA Spintronics

JASON 1999

D'Yakanov-Perel (DP) spin relaxation is important for electron spins in GaAs.

Time reversal symmetry in the Hamiltonian describing electron motion causes the energy of quantum states to be the same when both wavevector  $k$  and spin state are reversed. For materials with inversion symmetry the energy is also the same as the wavevector is reversed without flipping the spin. These two conditions imply the energy of the two spin states must also be equal.

However, in materials like GaAs without inversion symmetry, the energies of the spin states may not be the same, even in zero applied magnetic field, and the electrons follow a Hamiltonian of the form given above.

The second term in the Hamiltonian describes an effective internal field  $B_{\text{int}}$  which is oriented according to the direction of motion of the electron. Larmor precession of the spin at angular frequency  $\Omega_{\text{int}}$  about  $B_{\text{int}}$  which changes with electron motion as the electron collides with impurities or phonons. The resulting spin relaxation rate  $1/T_2$  is given by the expression above, where  $\tau_c$  is the relaxation time for the electron momentum.

Note that the resulting spin relaxation rate rises rapidly with electron energy and temperature.

## Dependence of $T_2$ on Excited Electron Density and Temperature

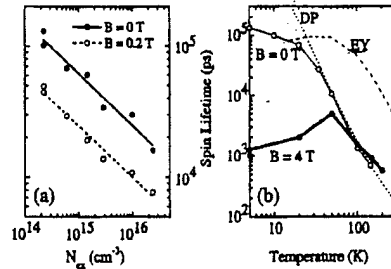

FIG. 4. (a)  $T_2^*$  vs  $N_{ex}$ . Solid lines are power-law fits to  $T_2^* \sim N_{ex}^{-0.4}$ . Data are taken at 5 K. (b)  $T_2^*$  vs temperature for  $n = 10^{16}$  at  $B = 0$  and 4 T and  $N_{ex} = 2 \times 10^{16} cm^{-3}$ . Dotted lines are DP and EY predictions.

Phys. Rev. Lett. 80, 4313 (1998)

**DP:** D'Yakanov, Perel' relaxation -  $B_{int}$  due to conduction band asymmetry  
**EY:** Elliot, Yafet relaxation - spin orbit in collisions with impurities  
 $\Delta g$  spread produces negligible broadening at fields below 0.1T

DARPA Spintronics

JASON 1999

Many of the features of the spin lifetime vs. temperature shown in the right figure are understood. The  $B = 0$  data (open circles) fit the D'Yakanov-Perel (DP) model very well above 30 K where this model's strong dependence on electron energy (see previous slide) is expected to make it the dominant relaxation mechanism. Below 30 K, the Elliot -Yafet (EY) mechanism is expected to dominate in shortening the lifetime, as shown by the dashed line in the figure. The down turn shown in the EY lifetime at low temperatures reflects the corresponding reduction in electron mobility.

In fact, the EY relaxation rate together with a related electron-electron collision rate seem to predict somewhat shorter spin lifetimes than those observed below 10 K. The far shorter spin lifetime shown in the data at  $B = 4$ T (black circles) below 60 K is due in part to the dependence of the electron  $g$  factor on energy (see slide 17) which broadens the resonance at large fields.

The dependence of the spin lifetime on the density  $N_{ex}$  of excited electrons created by the laser pulse, shown in the left figure, is not understood yet.

The clear message in this slide is that the spin relaxation time near room temperature in GaAs will be very short,  $< 1$  nsec, because the DP relaxation mechanism becomes so strong. Very high magnetic fields tend to mitigate the DP relaxation but not enough at attainable fields. Hope for longer spin relaxation times in semiconductors at room temperature will be in materials with a center of symmetry, for which the DP effect is absent.

## Lateral Transport of Spin Coherence

---

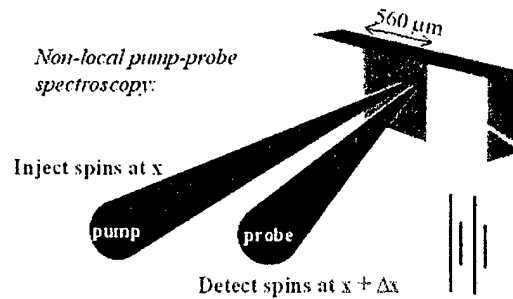

DARPA Spintronics

JASON 1999

The transport of electron spin through space is important for many possible applications. Spin transport was studied using optical techniques by Awschalom and coworkers using the method illustrated above. An n-type GaAs crystal was equipped with two electrical contacts, and a voltage applied between the contacts was used to move electrons. A focussed pump light beam was used to create electrons at one location  $x$  and the Faraday rotation of a focussed probe light pulse was used to detect the polarization at a different position  $x + \Delta x$ . By moving the relative position of the two light beams the transport of polarized spins via electron motion can be studied.

## Lateral Transport of Spin Coherence

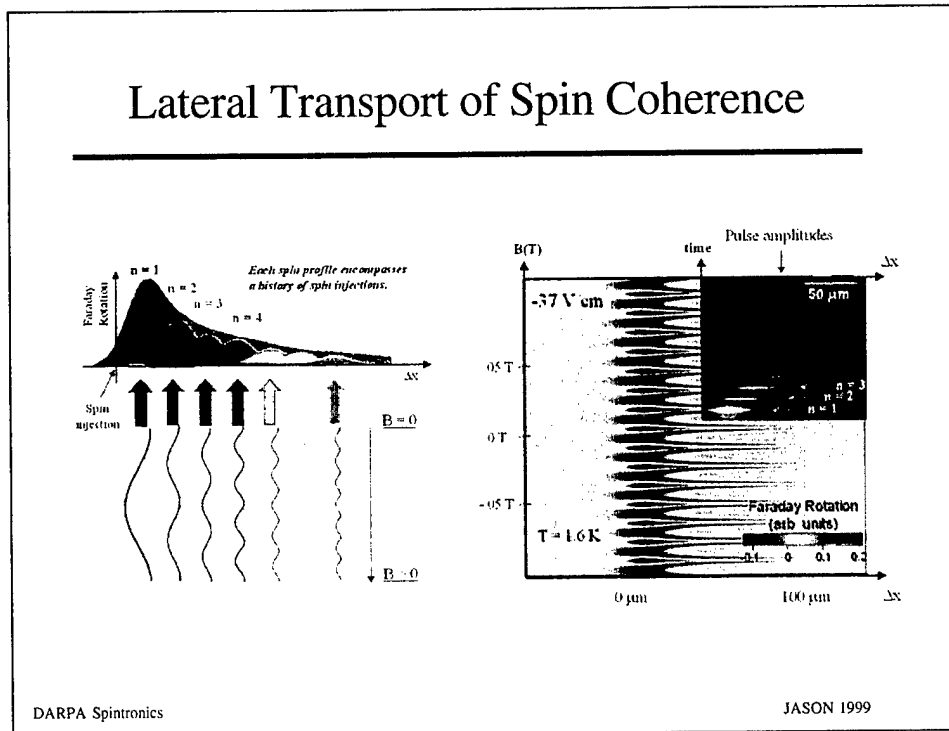

DARPA Spintronics

JASON 1999

The figure on the left illustrates what happens when the pump light is pulsed repetitively at a rapid rate for different applied magnetic fields  $B$ . As the excited electrons move laterally through the crystal their spins precess in the applied magnetic field. Early (high  $n$ ) pulses create spins which move longer and precess by a greater angle, as indicated. The total signal observed has contributions from a number of different pump pulses. For larger magnetic fields the precession is more rapid, and relatively greater precession occurs for earlier pump pulses due to the greater time interval before measurement with the probe pulse.

Data obtained using this technique is shown on the right for a n-type GaAs crystal. The large figure is a raster plot of the observed Faraday rotation vs. position of the probe light pulse and magnetic field. Resonant spin amplification (see slide 16) is observed for a wide range of positions up to shifts  $\Delta x \sim 100 \mu\text{m}$ , indicating that polarized spin transport occurs over these distances. The sharpness of the amplified peaks become sharper with greater positional shifts, because the precessional angle increases at greater times. Using Fourier transforms, the motion of spins created by separate pump pulses can be separated, and the resulting pulse amplitudes for different pump pulses is shown vs. position and time in the inset figure. This clearly shows the motion of groups of electron spins caused by an applied electric field which pulls the electron charge along.

## Spin Injection and Spin Accumulation

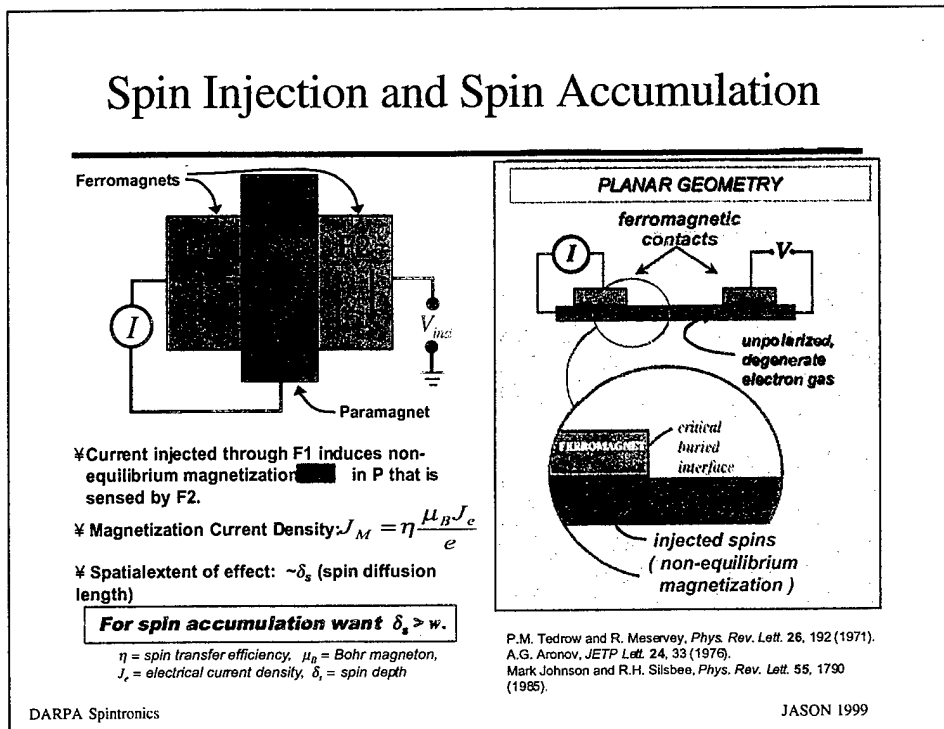

In the workshop Michael Roukes and Berry Jonker described work on spin injection into semiconductors. Placement of polarized electron spins in semiconductors by electrical means is potentially simpler and more effective in many applications than optical pumping.

The slide illustrates the ideas of spin injection and spin accumulation. In the left figure a slab P of paramagnetic material is sandwiched between two ferromagnetic electrical contacts F1 and F2. The orientation of spins in the ferromagnets indicated by arrows may be parallel or antiparallel. An external current source drives a current from F1 through P. Some spins also pass into F2, the amount depending on their relative polarization compared with F2. The number of spins accumulated in F2 builds up until their electrons have sufficient charge to prevent additional spins from accumulating. This added charge builds up an induced voltage  $V_{ind}$  as shown. For spin injection and accumulation to occur, the spin polarization must be maintained both during injection from F1 to P, during the transport through the width  $w$  of P, and in accumulation in F2 from P.

The right figure illustrates a planar geometry in which a degenerate electron gas inside a semiconductor provides the paramagnetic material, and two ferromagnetic contacts on the surface provide the injector and accumulator.

Electrical spin injection and spin accumulation have potential advantages because they allow manipulation of spin integrated semiconductor circuits without optical access. But unwanted relaxation of spin has provided difficulty for semiconductors.

## Expected Effects of Spin Injection

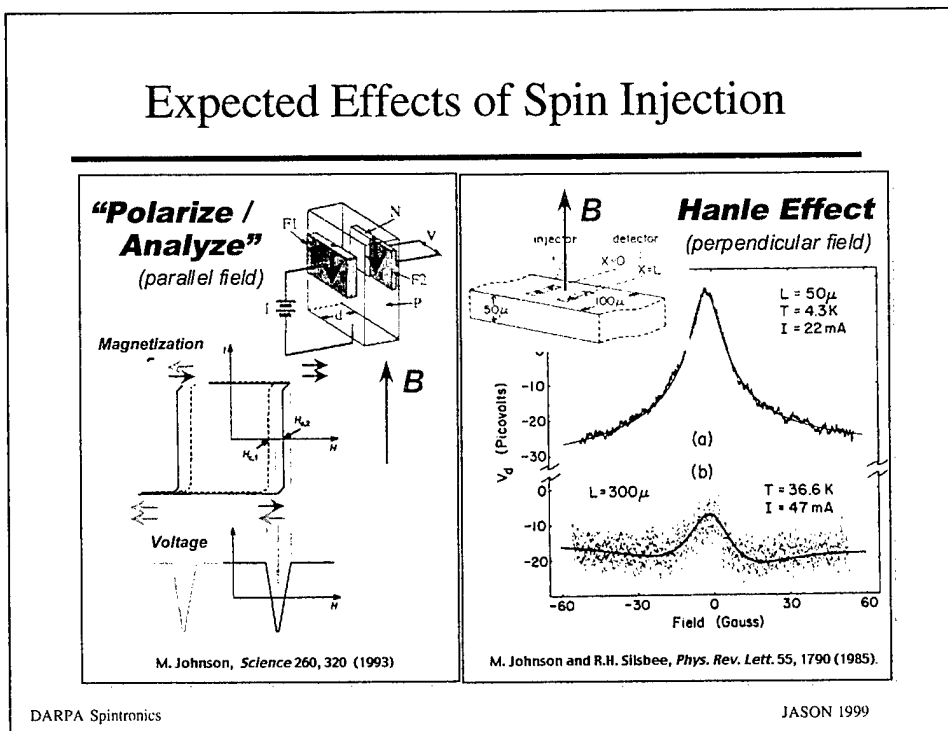

This slide illustrated expected effects of spin injection and accumulation on the electrical properties of the devices.

On the left the magnetization orientation of the two ferromagnetic slabs is illustrated as blue and red arrows for a range of applied magnetic field  $B$ . As a consequence of their fabrication the two ferromagnetic slabs switch polarization at different  $B$ , as shown in the middle part of the figure. Over most of the field range the two polarizations are parallel, and the induced voltage is relatively high, as illustrated in the bottom part of the figure. But at fields where the two polarizations are opposite, the accumulated charge is reduced, and a dip occurs in the induced voltage as shown.

Experimental observations of these effects in semiconducting devices have been made difficult by Hall effects on microscopic length scales induced by small ferromagnetic structures and currents.

On the right is an example of the Hanle effect which occurs in electron gases in planar samples for perpendicular magnetic fields. For this experimental data a metal layer was used for the planar device rather than a semiconductor. Experiments to extend this approach to semiconductors are underway in Roukes' group.

Spin injection in semiconductors could provide important approaches for new spintronics devices, but their implementation has been slowed somewhat by unwanted spin relaxation at interfaces and for transport in the semiconductor.

## Inducing Spin Polarization in a 2DEG

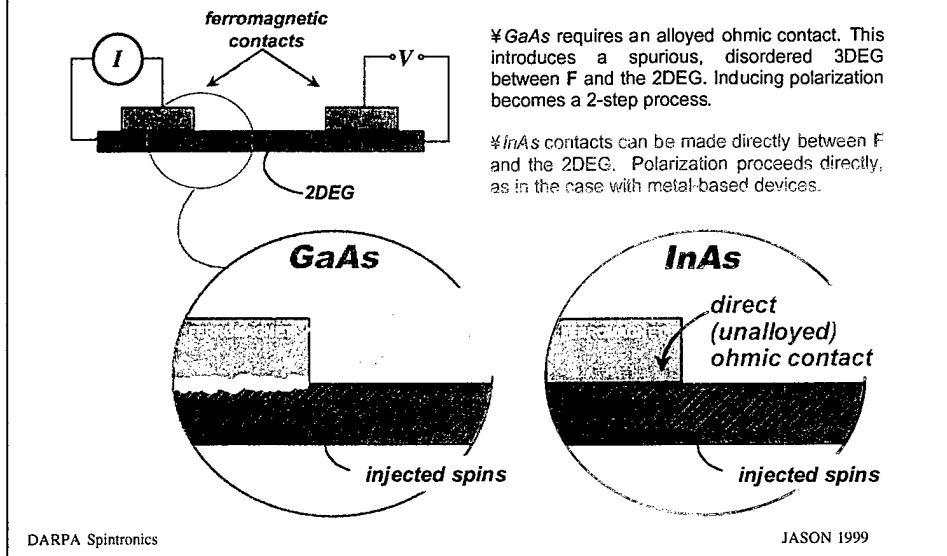

Inducing spin polarization in a two dimensional electron gas (2DEG) inside a semiconductor poses special problems.

For GaAs electrical contact between a ferromagnetic metal contact and the 2DEG requires a diffused ohmic contact. This type of contact induces a three dimensional electron gas (3DEG) between the ferromagnet and the 2DEG. In experiments this typically relaxes spin polarization.

For InAs direct unalloyed ohmic contacts between the ferromagnetic metal and the 2DEG are possible, as for metal samples, simplifying the process of spin injection and possibly favoring the maintenance of spin polarization.

## Local Hall Fields

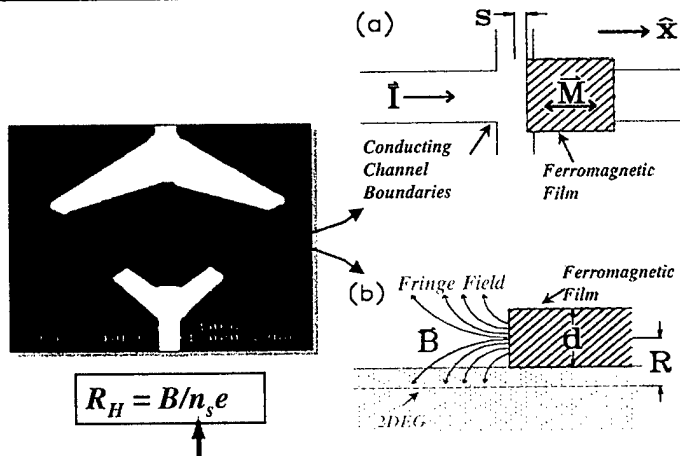

F.G. Monzon, Mark Johnson, and M.L. Roukes, *Appl. Phys. Lett.* 71, 3087 (1997)

DARPA Spintronics

JASON 1999

Local Hall fields in semiconductor samples with ferromagnetic metal contacts can mimic the injection of polarized spins. In the workshop Roukes presented experiments on InAs devices with ferromagnetic metal contacts which demonstrate the effects of local Hall fields. The SEM photo above illustrates a device with the two arc-shaped ferromagnetic metal contacts connected to the outside world by vee-shaped leads. A conducting 2DEG channel is defined in the InAs as indicated.

A local Hall field is produced by the fringe field from the ends of the ferromagnetic film, as illustrated in the drawing. This fringe field has a perpendicular component at the 2DEG and produces a Hall voltage for passing currents due to the orbital motion of electrons rather than their spin. Roukes has shown that the effects of local Hall fields are often difficult to separate from the injection of polarized spin, and that care is required in the analysis of data for spin injection into semiconductors.

## InAs/GaSb/AlSb Devices

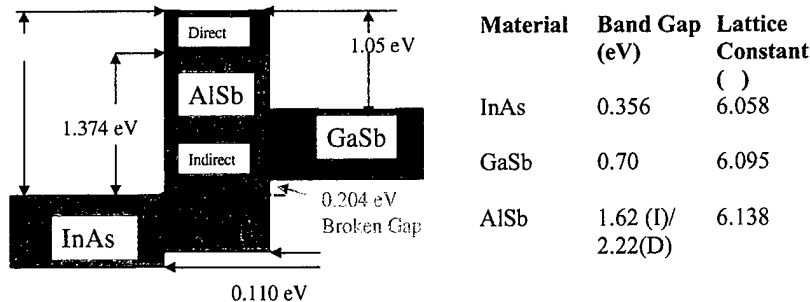

- InAs Very High Electron Mobilities
- No Barrier Between n-InAs and Metals
- Unusual Band Lineups-Gives Lots of Unique Devices
- Mn Doping
- InAs Superconductor

T. McGill  
Caltech

DARPA Spintronics

JASON 1999

At the workshop Tom McGill described work on materials systems for spintronics. As illustrated above, layered InAs/GaSb/AlSb materials have interesting properties which may enable new devices.

The bandgaps and band edges of InAs, AlSb, and GaSb illustrated in the figure at left are quite different and permit many approaches to device design. Layered structures with relatively few defects are possible, because the lattice constants are similar.

InAs can have very high electron mobilities, and permits contacting by metals directly as discussed above.

Mn doping can be used in this material system to explore magnetic semiconductor materials (Ga,Mn)Sb and (Ga,Mn)As (see below).

Superconducting InAs devices have been made via the proximity effect with a metal superconductor.

## Asymmetric Superlattice

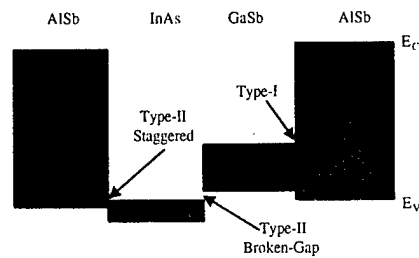

- AlSb/InAs/GaSb superlattice with highly asymmetric design
- Removal of Kramer's degeneracy results in spin splitting.
- Spin Splitting of lowest conduction subband exceeds 20 meV at  $k_{\parallel} = 0.05 (2\pi/a)$

T. McGill  
Caltech

DARPA Spintronics

JASON 1999

McGill described how an asymmetric superlattice can produce spin splitting of the conduction band in zero field. The structure consists of an asymmetric InAs/GaSb well with AlSb barriers, and is illustrated by the diagram at left. For symmetric structures Kramer's degeneracy ( $E(k, \text{spin up}) = E(k, \text{spin down})$ ) follows from time reversal symmetry ( $E(k, \text{spin up}) = E(-k, \text{spin down})$ ) and inversion symmetry ( $E(-k, \text{spin down}) = E(k, \text{spin down})$ ). For asymmetric structures the second relation does not hold, and spin splitting is possible.

Calculations of an asymmetric AlSb/InAs/GaSb superlattice of this form show spin splitting in the lowest conduction band of more than 20 meV at  $k = 0.05(2\pi/a)$ .

Spin splitting in zero applied magnetic field could be useful for spintronics devices.

## Ferromagnetism in (Ga,Mn)As

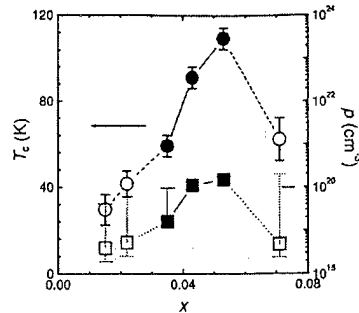

- Samples are ferromagnetic at low T.
- By applying appropriate strain, the easy axis of magnetization can be made to be in-plane or perpendicular to plane.
- $T_C$  up to 110 K
- Ferromagnetism caused by RKKY (carrier mediated) interaction.

DARPA Spintronics

JASON 1999

A ferromagnetic semiconductor (Ga,Mn)As has been produced with Curie temperature up to  $T_C = 110$  K, as shown in the graph of  $T_C$  vs. Mn fraction  $x$ . The transition temperature increases with Mn concentration up to  $x = 0.05$ . Because Mn is a dopant, the hole concentration also increases with Mn fraction, up to about  $10^{20} \text{ cm}^{-3}$ , as shown on the right axis of the graph.

Ferromagnetic semiconductors could ease problems found in spin injection using metal ferromagnets on semiconductors, and they offer new approaches to designing spintronic devices.

## Applications

---

- magnetic random access memory (MRAM)
  - IBM, Motorola, Honeywell
- sensitive magnetic field sensors
- magneto-optical components based on semiconductors
- spin dynamics important for electronics based on quantum states
- quantum computer designs often based on spins for Q-bits - experiments only just beginning

DARPA Spintronics

JASON 1999

This slide gives examples of possible applications for spintronics.

MRAM memories which combine metal layers with semiconductor electronics have been developed in research at IBM, Motorola, and Honeywell. They provide nonvolatile storage in MRAM chips projected to reach ~1Mbit in 1999. The ability to manufacture these chips in quantity needs to be addressed, but with success they may find use in the near future.

Spintronics devices can provide sensitive magnetic field sensors in compact packages at low cost. Roukes has demonstrated the use of submicron sized local Hall effect sensors with noise  $\sim 300$  spins/Hz<sup>1/2</sup>.

Spintronics has been proposed as a way to make magneto-optical components based on semiconductor devices (Datta and Das, 1990).

New electronic devices and circuits use quantum states; spin is important, more so in some cases than others. For Coulomb blockade devices electron charge quantization is central, but transport is often incoherent. Here spin relaxation in transport is not important. In electron interferometers the phase of the wavefunction is central, and for these cases spin relaxation in transport is important even though the electron charge may give the signal.

Spin states are often chosen to be Q-bits in theoretical quantum computer models. Although the theory has become quite advanced and encouraging, experiments in this subject are only just beginning. Spintronics could provide a natural approach to implementing quantum computers and related circuits.

## Summary and Conclusions

---

- Magnetic random access memory MRAM
  - advantages and possible use
- Long spin lifetimes ( $>100$  ns) and transport distances ( $>100$   $\mu\text{m}$ ) in GaAs
  - possible use of spins in sensors and devices
  - far less long lived than electron charge
- Spin injection can enable new devices
  - experiments important for understanding relaxation
- New materials for spintronics
  - spin splitting and magnetic semiconductors
- Spins natural Q-bits for quantum computers
  - experiments just starting, far behind theory

DARPA Spintronics

JASON 1999

Summary and Conclusions. The development of magnetic random access memory has proceeded very well recently, due in part to DARPA support of IBM and Motorola. MRAM chips provide nonvolatile memory and can potentially be made in large sizes in the not too distant future. They are a strong support for spintronics research.

Long spin lifetimes ( $T_2 > 100$  nsec) and transport distances ( $> 100$   $\mu\text{m}$ ) have been demonstrated in n-type GaAs and other semiconductors using optical means. These lifetimes and transport distances are long enough to permit the design of spin-based electronic devices. On the other hand these lifetimes and distances are far less than can be achieved with electron charge, so the domain of new spin based electronics will need to be chosen carefully.

Spin injection in semiconductors can enable new devices not using optics, and enable new types of microelectronic devices using spin and quantum states. Experiments are needed to better understand spin relaxation at metal ferromagnet-semiconductor interfaces and in spin transport.

New materials can provide spin splitting in zero magnetic field and semiconductor ferromagnets, with possible spintronic applications.

Spins are natural Q-bits for theoretical quantum computer designs which have become quite advanced. Although quantum computer experiments are just starting and are far behind theory, spins in spintronic devices could be a good way to approach this problem.

## Summary and Conclusions (cont.)

---

- Spintronics beyond GMR and MRAM will need research on basics of spin relaxation and transport
  - spin lifetimes, transport, and injection in semiconductors
- Spintronic materials should receive continued research.
- Spintronic devices need to be developed.
  - quantum state electronic devices and circuits
  - quantum computers?

DARPA Spintronics

JASON 1999

The next phase of research in spintronics may change somewhat in character from present and near term applications like giant magnetoresistance (GMR) heads for disk drives and magnetic random access memory (MRAM), to more fundamental investigations of spin relaxation and transport in semiconductor devices.

Spintronic materials have received much attention and impressive progress has been made recently, for example the development of ferromagnetic semiconductors GaMnAs. Such new materials could have important benefits for spintronics and their investigation should continue to be pursued.

New types of spintronic devices need to be developed. Although the potential benefits of spin-based electronics in certain areas are clear, applications will need the study of particular device designs which may combine microelectronic devices in semiconductors with magnetic materials in new ways. Devices should be developed and studied in the areas of quantum state electronics, including both charge and spin, and in experimental implementations of quantum computer components.

## DISTRIBUTION LIST

Director of Space and SDI Programs  
SAF/AQSC  
1060 Air Force Pentagon  
Washington, DC 20330-1060

CMDR & Program Executive Officer  
U S Army/CSSD-ZA  
Strategic Defense Command  
PO Box 15280  
Arlington, VA 22215-0150

Superintendent  
Code 1424  
Attn Documents Librarian  
Naval Postgraduate School  
Monterey, CA 93943

DTIC [2]  
8725 John Jay Kingman Road  
Suite 0944  
Fort Belvoir, VA 22060-6218

Dr. A. Michael Andrews  
Director of Technology  
SARD-TT  
Room 3E480  
Research Development Acquisition  
103 Army Pentagon  
Washington, DC 20301-0103

Dr. Albert Brandenstein  
Chief Scientist  
Office of Nat'l Drug Control Policy  
Executive Office of the President  
Washington, DC 20500

Dr. H. Lee Buchanan, III  
Assistant Secretary of the Navy  
(Research, Development & Acquisition)  
1000 Navy Pentagon  
Washington, DC 20350-1000

Dr. Collier  
Chief Scientist  
U S Army Strategic Defense Command  
PO Box 15280  
Arlington, VA 22215-0280

D A R P A Library  
3701 North Fairfax Drive  
Arlington, VA 22209-2308

Dr. Martin C. Faga  
President and Chief Exec Officer  
The MITRE Corporation  
A210  
202 Burlington Road  
Bedford, MA 01730-1420

Mr. Frank Fernandez  
Director  
DARPA/DIRO  
3701 North Fairfax Drive  
Arlington, VA 22203-1714

Mr. Dan Flynn [5]  
Program Manager  
DI/OT/SAB  
DI/OTI/SAG  
5 S 49 NHB  
Washington, DC 20505

Dr. Paris Genalis  
Deputy Director  
OUSD(A&T)/S&TS/NW  
The Pentagon, Room 3D1048  
Washington, DC 20301

Dr. Lawrence K. Gershwin  
NIO/S&T  
2E42, OHB  
Washington, DC 20505

General Thomas F. Gioconda [5]  
Assistant Secretary for Defense  
US Department of Energy  
DP-1, Room 4A019  
Mailstop 4A-028  
1000 Independence Ave, SW  
Washington, DC 20585

Mr. Lee Hammarstrom  
National Reconnaissance Office  
14675 Lee Road  
Chantilly, VA 20151

## DISTRIBUTION LIST

Dr. Theodore Hardebeck  
STRATCOM/J5B  
Offutt AFB, NE68113

Mr. David Havlik  
Manager  
Weapons Program Coordination Office  
MS 9006  
Sandia National Laboratories  
PO Box 969  
Livermore, CA94551-0969

Dr. Helmut Hellwig  
Deputy Asst Secretary  
(Science, Technology and Engineering)  
SAF/AQR  
1060 Air Force Pentagon  
Washington, DC 20330-1060

Dr. Robert G. Henderson  
Director  
JASON Program Office  
The MITRE Corporation  
1820 Dolley Madison Blvd  
McLean, VA 22102

J A S O N Library [5]  
The MITRE Corporation  
Mail Stop W002  
1820 Dolley Madison Blvd  
McLeaan, VA 22102

Mr. O' Dean P. Judd  
Los Alamos National Laboratory  
Mailstop F650  
Los Alamos, NM 87545

Dr. Bobby R. Junker  
Office of Naval Research  
Code 111  
800 North Quincy Street  
Arlington, VA 22217

Dr. Martha Krebs  
Director  
Energy Research, ER-1, Rm 7B-058  
1000 Independence Ave, SW  
Washington, DC 20858

Lt Gen, Howard W. Leaf, ( Retired)  
Director, Test and Evaluation  
HQ USAF/TE  
1650 Air Force Pentagon  
Washington, DC 20330-1650

Dr. George Mayer  
Scientific Director  
Army Research Office  
4015 Wilson Blvd  
Tower 3, Suite 216  
Arlington, VA 22203-2529

Dr. Thomas Meyer  
DARPA/DIRO  
3701 N. Fairfax Drive  
Arlington, VA 22203

Dr. Julian C. Nall  
Institute for Defense Analyses  
1801 North Beauregard Street  
Alexandria, VA 22311

Major General John S. Parker  
U.S. Army Medical Research and Material  
Command  
504 Scott Street  
Ft Detrick, MD 21702-5012

Dr. Ari Patrinos [5]  
Associate Director  
Biological and Environmental Research  
SC-70  
US Department of Energy  
19901 Germantown Road  
Germantown, MD 207874-1290

Dr. Bruce Pierce  
Ballistic Missile Defense Org  
BMDO/TO  
7100 Defense Pentagon  
Room 1E108  
Washington, DC 20301-7100

Mr. John Rausch [2]  
Division Head 06 Department  
NAVOPINTCEN  
4301 Suitland Road  
Washington, DC 20390

## DISTRIBUTION LIST

Records Resource  
The MITRE Corporation  
Mail Stop W115  
1820 Dolley Madison Blvd  
McLean, VA 22102

Dr. Fred E. Saalfeld  
Director  
Office of Naval Research  
800 North Quincy Street  
Arlington, VA 22217-5000

Dr. Dan Schuresko  
Chief  
Advanced Technology Group/  
Community Management  
Washington, DC 20505

Dr. John Schuster  
Submarine Warfare Division  
Submarine, Security & Tech  
Head (N875)  
2000 Navy Pentagon Room 4D534  
Washington, DC 20350-2000

Dr. Richard Spinrad  
US Naval Observatory  
Naval Oceanographers Office  
3450 Massachusetts Ave, NW  
Washington, DC 20392-5421

Dr. Michael A. Strosio  
US Army Research Office  
P. O. Box 12211  
Research Triangle Park, NC 27709-2211

Dr. George W. Ullrich [3]  
ODUSD(S&T)  
Director for Weapons Systems  
3080 Defense Pentagon  
Washington, DC 20301-3080

Dr. David Whelan  
Director  
DARPA/TTO  
3701 North Fairfax Drive  
Arlington, VA 22203-1714

Dr. Linda Zall  
Central Intelligence Agency  
DS&T/OTS  
Washington, DC 20505

Dr. Peter D. Zimmerman  
Science Advisor  
ACDA  
320 21st Street, NW  
Washington, DC 20451

## DISTRIBUTION LIST

Mr. John Rausch [2]  
Division Head 06 Department  
NAVOPINTCEN  
4301 Suitland Road  
Washington, DC 20390

Records Resource  
The MITRE Corporation  
Mail Stop W115  
1820 Dolley Madison Blvd  
McLean, VA 22102

Dr. Fred E. Saalfeld  
Director  
Office of Naval Research  
800 North Quincy Street  
Arlington, VA 22217-5000

Dr. Dan Schuresko  
Chief  
Advanced Technology Group/  
Community Management  
Washington, DC 20505

Dr. John Schuster  
Submarine Warfare Division  
Submarine, Security & Tech  
Head (N875)  
2000 Navy Pentagon Room 4D534  
Washington, DC 20350-2000

Dr. Richard Spinrad  
US Naval Observatory  
Naval Oceanographers Office  
3450 Massachusetts Ave, NW  
Washington, DC 20392-5421

Dr. Michael A. Stroschio  
US Army Research Office  
P. O. Box 12211  
Research Triangle Park, NC 27709-2211

Dr. George W. Ullrich [3]  
ODUSD(S&T)  
Director for Weapons Systems  
3080 Defense Pentagon  
Washington, DC 20301-3080

Dr. David Whelan  
Director  
DARPA/TTO  
3701 North Fairfax Drive  
Arlington, VA 22203-1714

Dr. Peter D. Zimmerman  
Science Advisor  
ACDA  
320 21st Street, NW  
Washington, DC 20451