

CLEAR FOR OPEN PUBLICATION

28 Jun 08

PUBLIC AFFAIRS OFFICE
NAVAL AIR SYSTEMS COMMAND

H. Howard

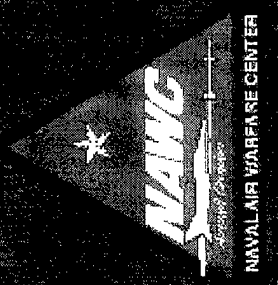
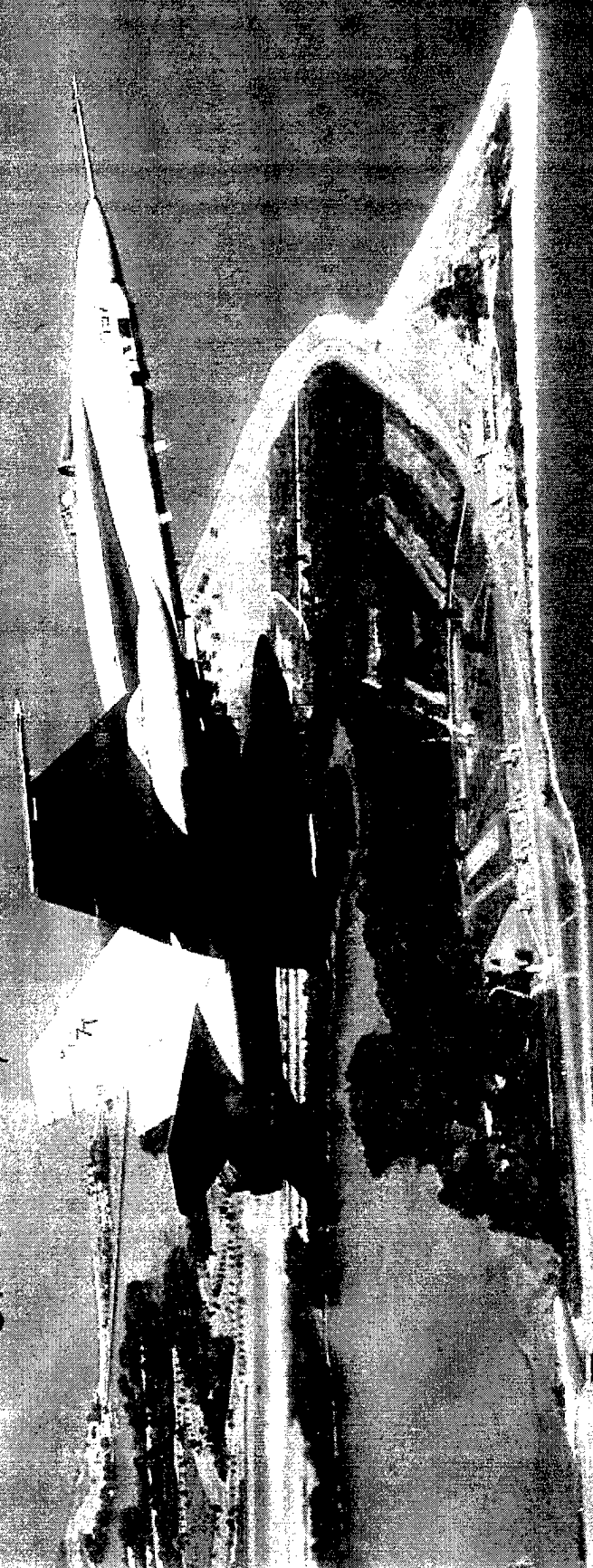

DISTRIBUTION STATEMENT A
Approved for Public Release
Distribution Unlimited

20010330 116



Mission

“The Dynamic Avionics Measurement Branch at the NAWC-AD conducts developmental test and evaluation (DT&E) of Navy aircraft and their avionics systems. These systems include radars (fighter/attack, sea surveillance, and AEW), Navigation (IFF, GPS, and INS), communications (voice and data link), reconnaissance systems, antenna systems, forward looking infrared systems and ASW systems. Also included are electronic support measures (ESM) systems, electronic intelligence (ELINT) systems, radar warning receivers, missile warning systems, communications receivers, and antenna patterns. Additionally, NAWC-AD has the mission to conduct performance testing of ECM and ECCM avionics systems including aircraft signature measurements (RCS), radar and communication Jammer-to-Signal (J/S) ratio measurements, Chaff and decoy measurements.”



Dynamic Measurement Capabilities

	Avionics	Electronic Warfare (EW)	Radar Cross Section (RCS)
Measurement Capabilities	Antenna Pattern Navigation Reconnaissance Radar Navigation Communication Reconnaissance Antenna Patterns	ESM (Airborne Receiver Performance) Jammer Techniques Receiver Sensitivity Jammer Duty Cycle Threat Warning Direction of Arrival Accuracy	Whole Body & Doppler Signature Measurements Down Range & ISAR Measurements Jammer-to-Signal Ratio Chaff & Decoy Measurement
Flight Test Systems	Real-Time Telemetry Link Real-Time Avionics Workstation	Automated Emitter Simulation Local Site Remote Site Mobile Assets Radar and Communication Simulation Automated Control	Advanced Dynamic Aircraft Measurement System (ADAMS) Waveform Data Processing System (WDPS) Real-Time RCS Engineering Workstation Dynamic Flight Programming & Control Signature Data Library



Infrastructure

- ❖ **Flight Test Area**
 - Chesapeake Ranges
 - Offshore Ranges
- ❖ **Range Control Center**
- ❖ **Range Instrumentation Tracking Systems**
 - Time Space Position Information (TSPi)
- ❖ **Real-Time Telemetry Processing System**



Flight Test Areas

Controlled Flight Environment

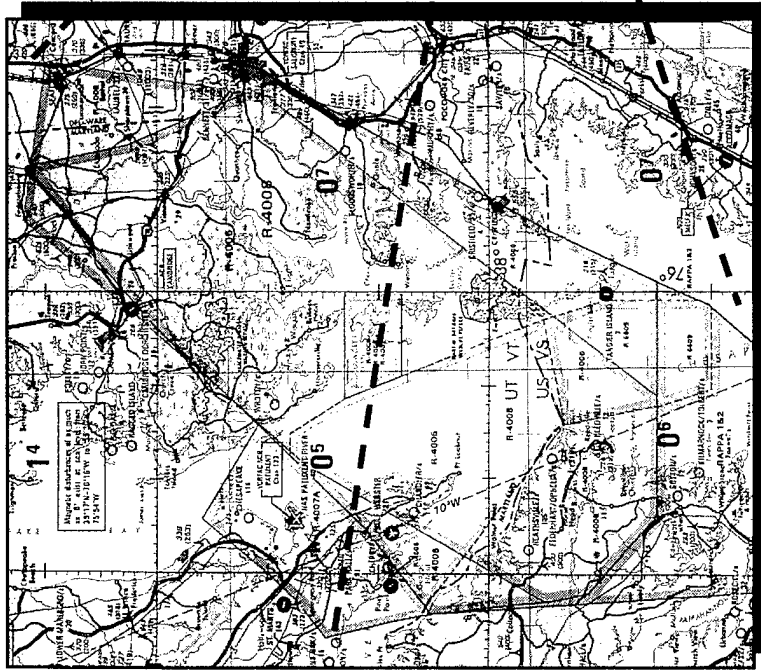

Chesapeake Ranges
Restricted Areas R-4002/5/6/7/8
2,400 square miles
Surface to 80,000 feet

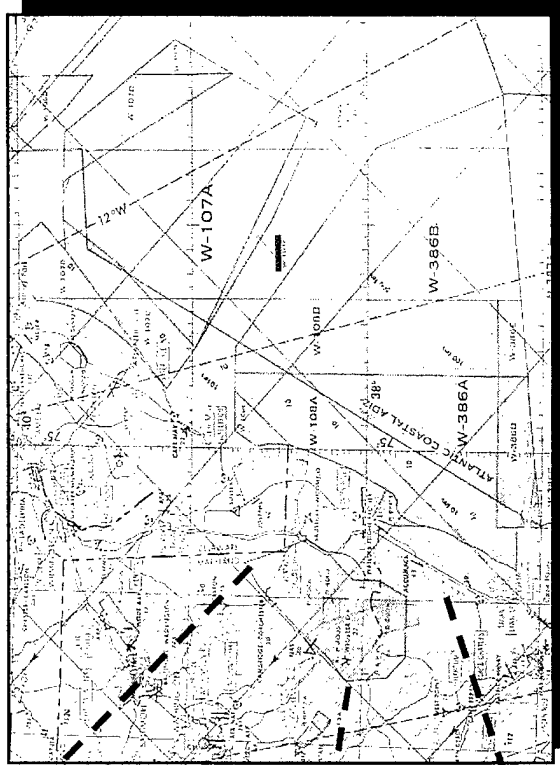

Offshore Ranges
Warning Areas W-1078/386
Approx. 18,000 square miles
Surface to unlimited altitude

Over Water Supersonic Areas
Drop Areas



Cedar Point Facility

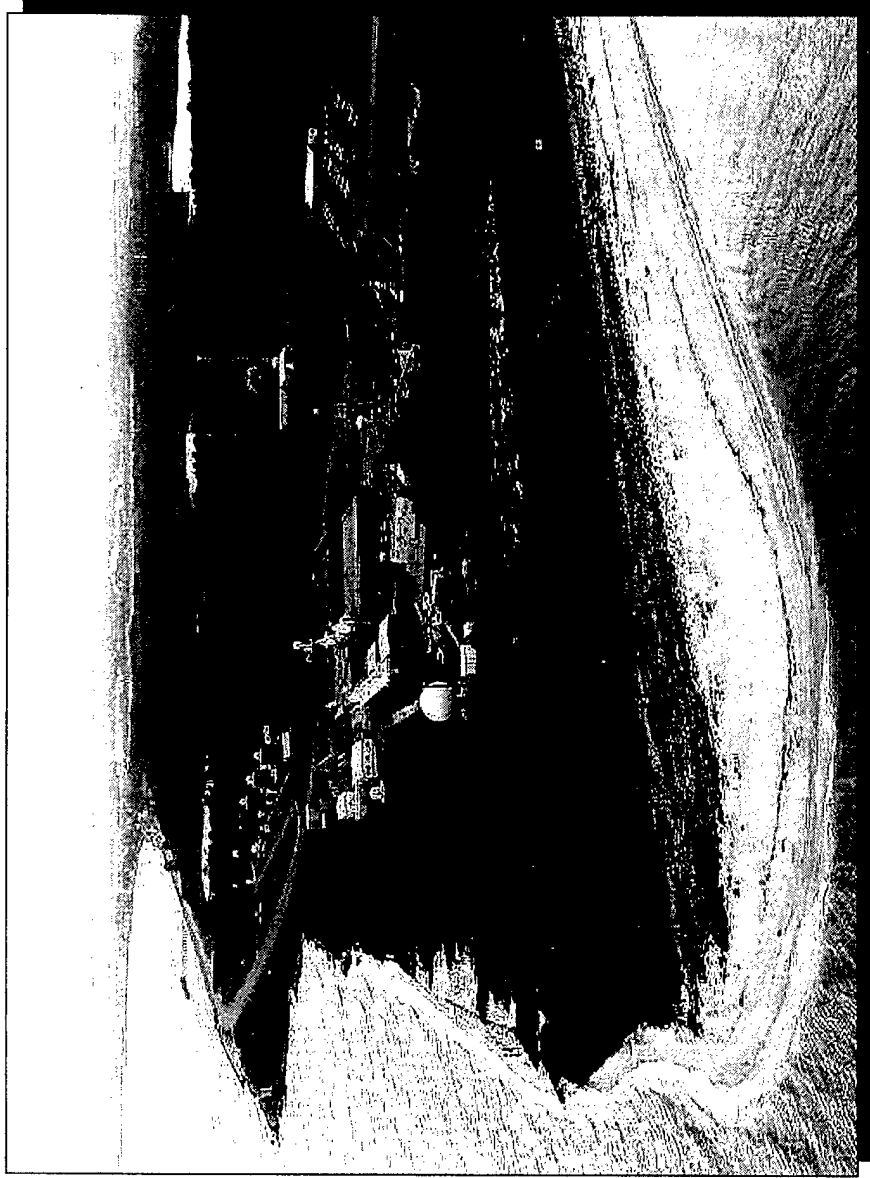



Range Control Center

- ❖ **Real-Time Control, Safety, Data Acquisition and Processing of Multiple Test Vehicles (up to 128)**
- ❖ **Simultaneous Mission Support (5 Mission Control Consoles)**
- ❖ **Range Safety (Airspace & Surface)**
 - Local and Remote Area Surveillance (IFF, FACSFAC VACAPES, Link-11, Surface Radar)
- ❖ **Communications Diversity (Video, Voice and Data)**
 - Radio, Microwave, Land-line, Fiber Optics, SATCOM
 - Secure Operations
 - DIS/DSI Compatibility With External Connectivity
- ❖ **Multisensor Integration**
 - Time Space Position Information (TSPI)
 - Video (High Resolution)
 - Film (5 to 400 Frames Per Second)
 - Audio
 - Meteorological Data

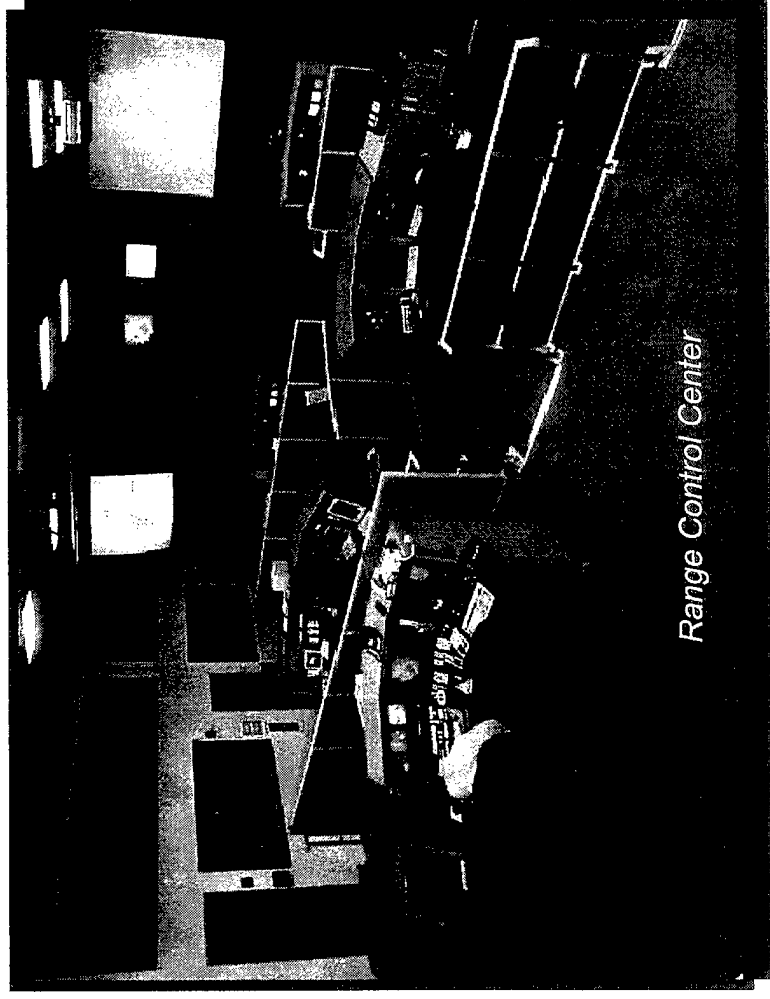



Tracking Instrumentation Diversity

- ❖ **Radar**
 - Single and Multiple Object
 - Cooperative and Noncooperative
 - Frequency and Geographic Diversity
- ❖ **Electro-Optical**
 - Video and Film Theodolites
 - Automatic Laser Tracking System (ALTS)
 - Infrared (IR)
- ❖ **Multilateration Tracking System**
 - Mid-Atlantic Tracking System (MATS)
 - Global Positioning System (GPS)

- Large area coverage
- Multiple participants
- Over the horizon
- Land, air and sea coverage

- ❖ **Area Surveillance**
 - IFF
 - FACSFAC
 - Link II
 - Surface

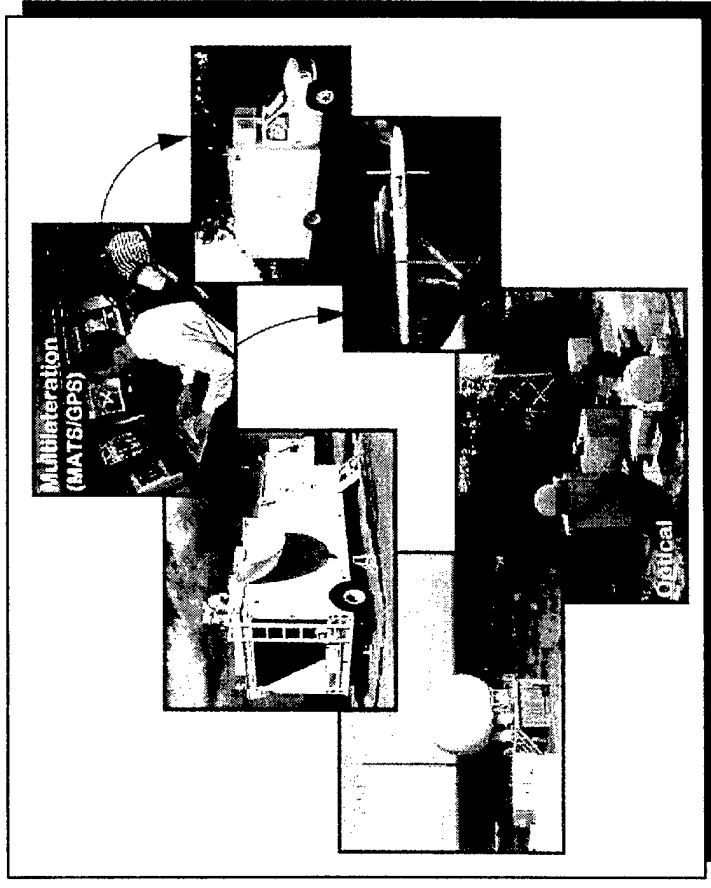



Range Tracking Systems Performance

Tracking System	Tracking Range	Accuracy (RMS)	Special Considerations
ALTS (portable) Automatic Laser Tracking System (2)	8.5 Miles	Range: 3 feet Angle: 0.1 mils	Requires retroreflector on target
THEODOLITE Range * w/Laser Ranger **	15 Miles (max)	@ Hooper Target (4 miles) X,Y,Z: 15 feet (Real-time) X,Y,Z: 3 feet (Post-flight film reading)	Visual observation Man in the Loop 4 Fixed Contraves 1 Mobile Contraves
CEDAR POINT RIR-778 Radars (3)	Skin 100 Miles Beacon 200 Miles	Range: 10 feet Angle: 0.1 mils	Nth time around trackers 3 Radars
CEDAR POINT AN/FPQ-17 Radar (MIR)	Skin 100 Miles Beacon 200 Miles	Range: 10 feet Angle: 0.25 mils	16 tracks Skin 2 tracks Beacon
WALLOPS RADARS FPS-16, FPQ-6	200 Miles	Range: 6 feet Angle: 0.1 mils	3 Radars linked into ATR
GPS with High Dynamic Instrumentation Set (HDIS) 15 External Pods 5 Internal Advanced Range Data System (ARDS) plates	600 miles w/ relays or Line of Sight	X&Y: 6 feet Z: 10 feet X&Y: 21 feet Z: 35 feet X&Y: 19 feet Z: 32 feet X&Y: 42 feet Z: 70 feet Pitch β 0.3 Roll β 0.5 Heading β 0.3 H. Position τ 4.0 V. Position τ 6.0 H. Velocity f 0.7 V. Velocity f 0.7	P/Y-Code Differential P-Code Absolute C/A-Code Differential C/A-Code Absolute

* Requires three sites for solution

** Single Mobile Theodolite has real-time accuracy
 β - degrees τ - feet f - ft/sec



Real-Time Telemetry Processing System (RTPS)

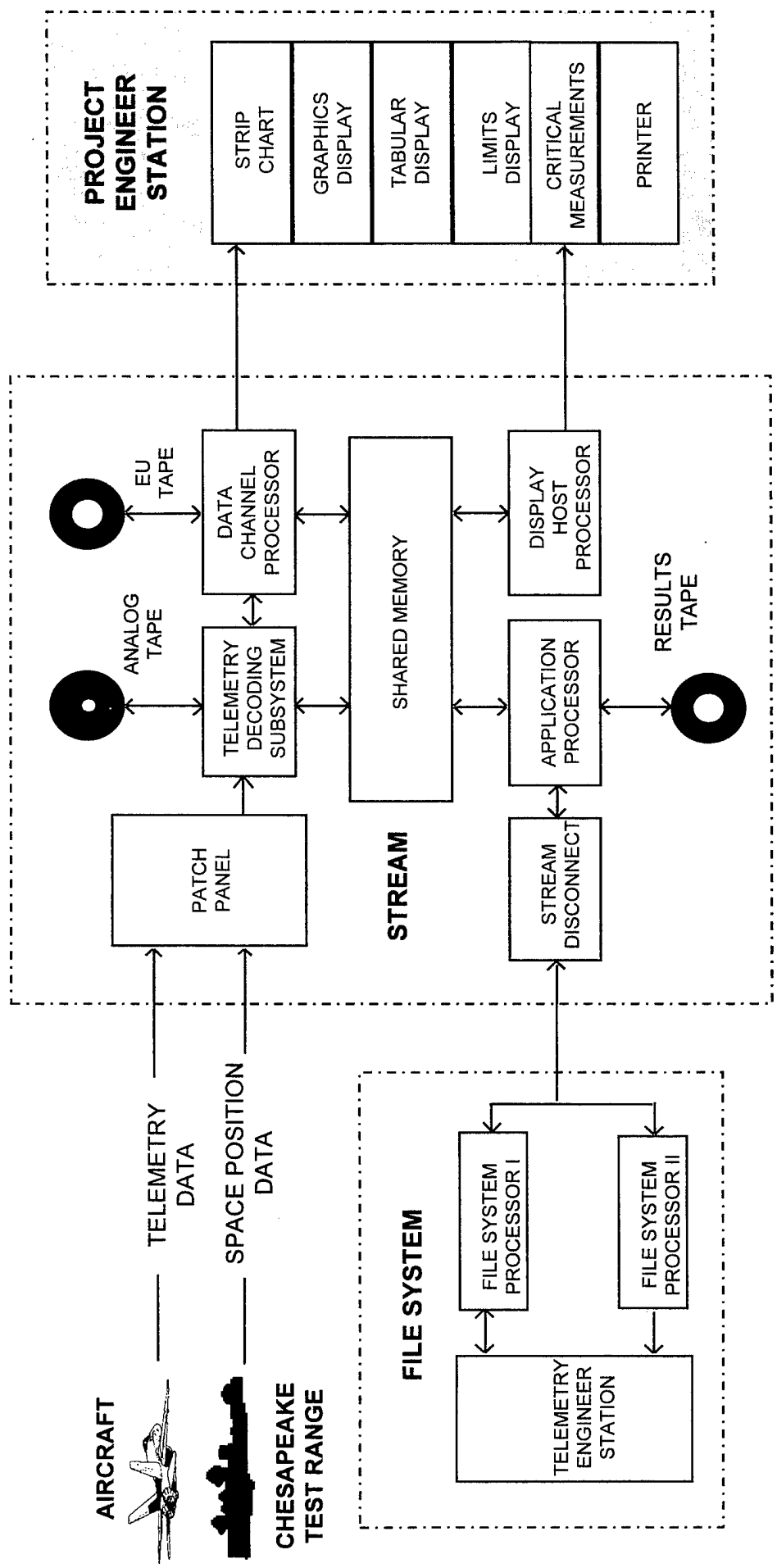



Dynamic Collection Flight Control

- ❖ Computer-Generated Flight Profiles
- ❖ Pre-Fly RCS Maneuvers
 - Maximizes Data Collection
 - Minimizes Flight Time
 - Employs Manned Flight Simulator at ACETEF
- ❖ Real-Time Data Bin Filling Routine

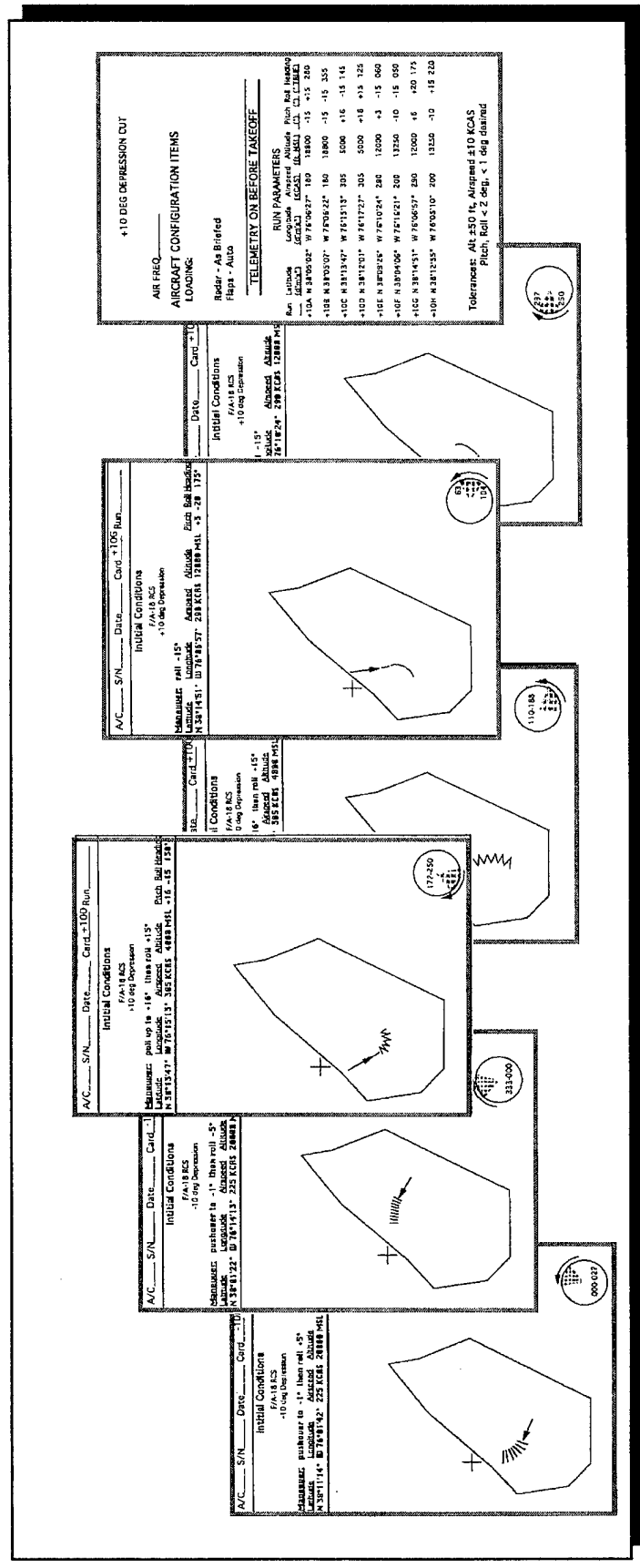



Aircraft Aspect and BIN Filing Display

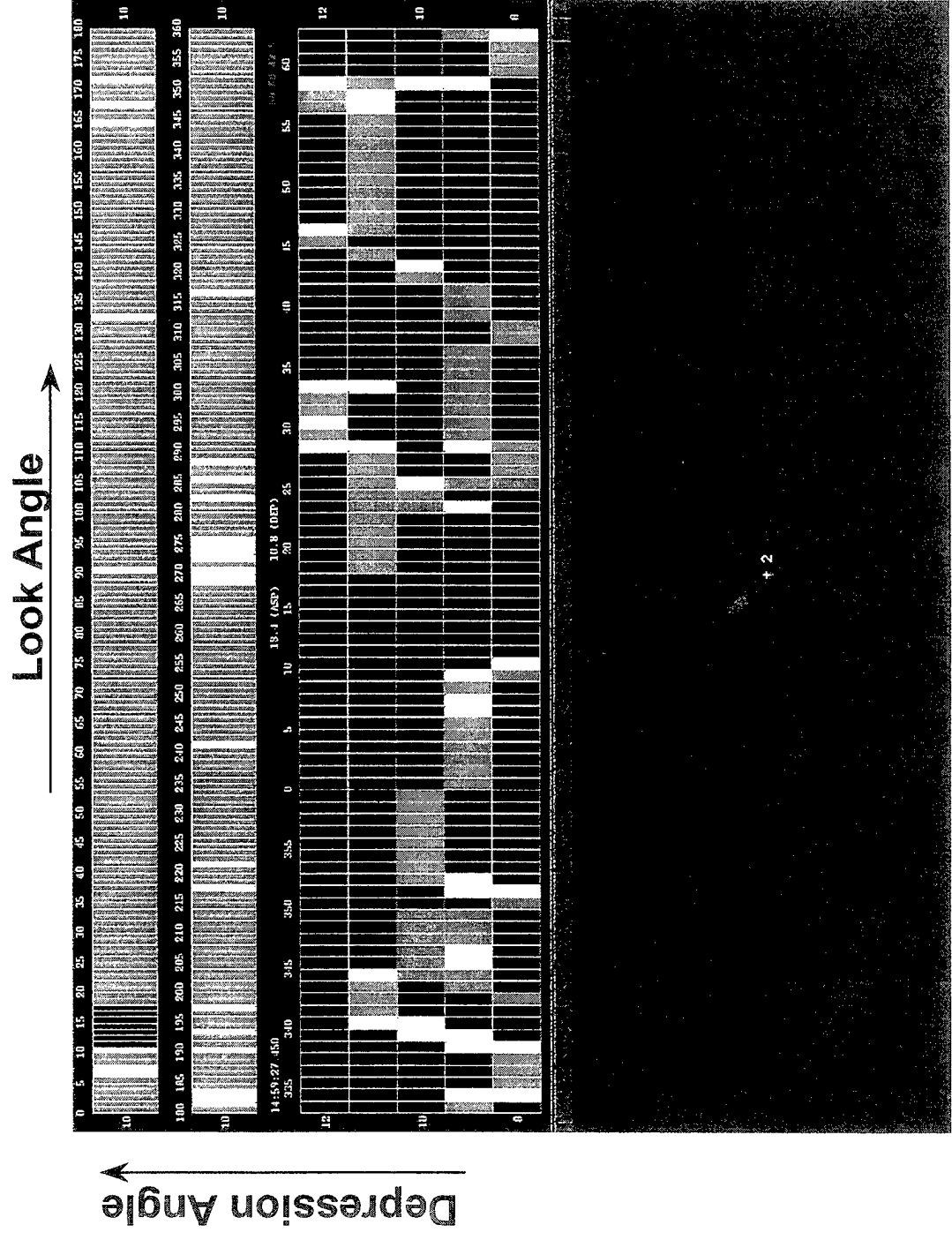



Dynamic In-Flight Radar Cross Section Measurements

- ❖ Whole Body & Doppler Signature Measurements
- ❖ Down Range & ISAR Measurements
- ❖ Jammer-to-Signal Ratio
- ❖ Chaff & Decoy Measurement





Air Vehicle RCS Measurement Process

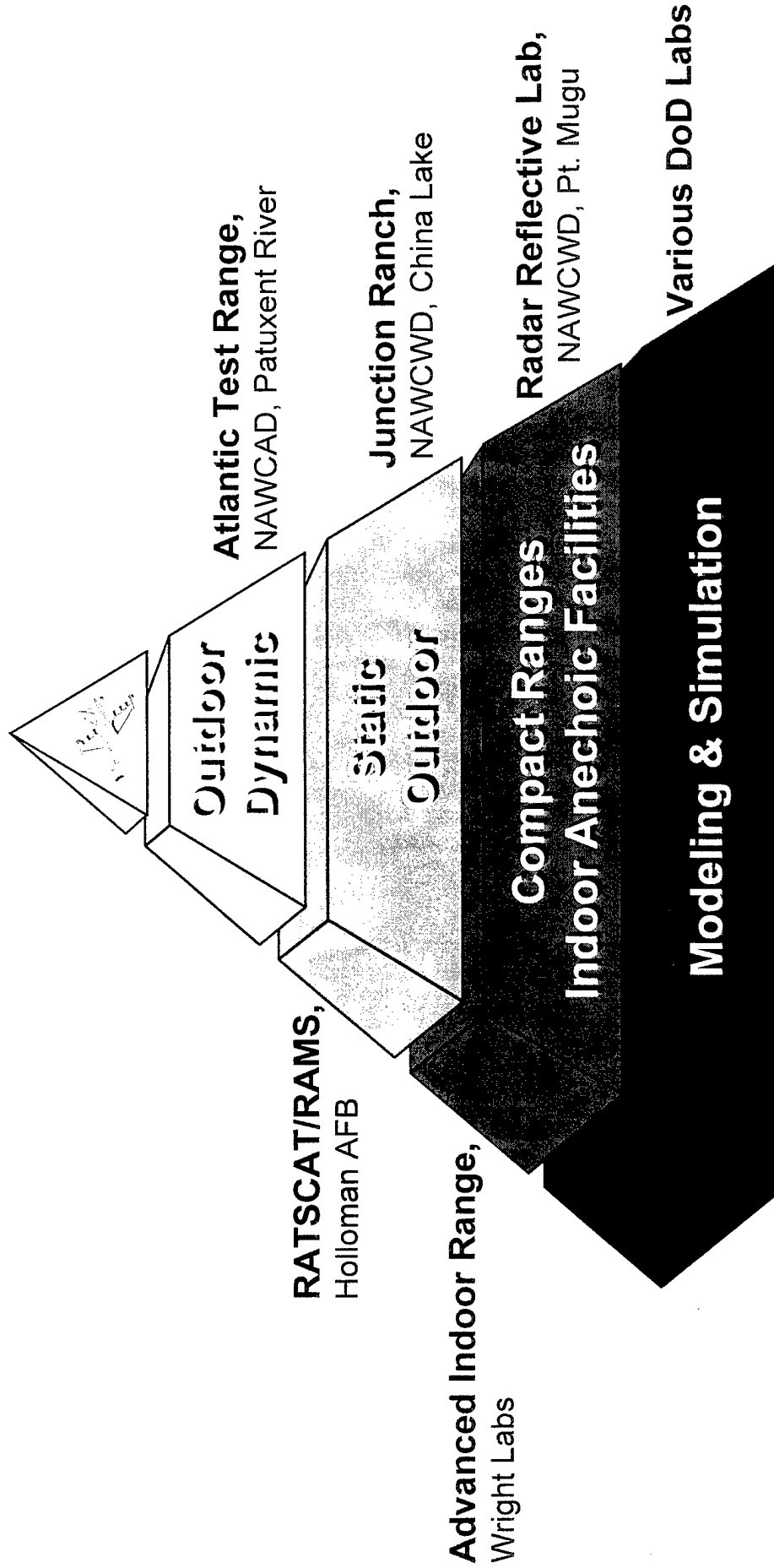



Signature Measurements Support DoD Acquisition Process

- ❖ Signature Measurements Required for Vehicle & Munitions Development
- ❖ Different Vehicles & Different Environments (Land, Air, Sea, Space)
- ❖ Different Types of Measurement Facilities Support the “Cradle-to-Grave” Acquisition Life Cycle

- Indoor Static Tests (Compact Ranges, Wind Tunnels)
 - Component, Subassembly, Scale Model
 - Controlled Environment
 - Precision Measurements
- Outdoor Static Tests
 - Full Size Aircraft, Ground Vehicle, Ship, Weapon Models
 - Precision Measurements
- Outdoor Dynamic Tests (Free Flight)
 - “Real” Targets
 - Vibration, Flexing, Doppler Modulation, Chaff, J/S

Increased Test Cost

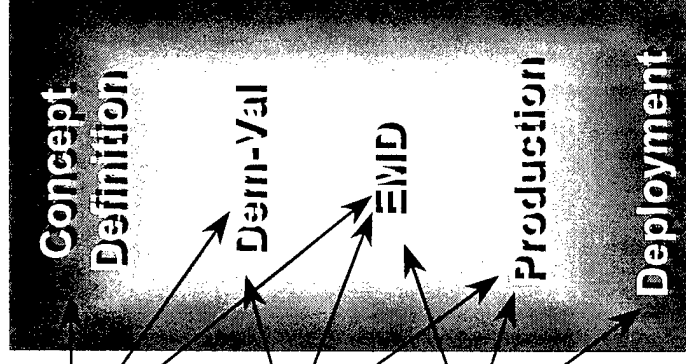



Why Dynamic In-Flight RCS Measurements?

- ❖ Full-Size Actual Test Article
- ❖ Target Scintillation
 - Engine Modulation
 - Propeller Modulation
 - Antenna Rotation
 - Vehicle Vibration
 - Vehicle Flexing
- ❖ Towed / Expendable Decoys
- ❖ Jammer-to-Signal
- ❖ Chaff



Dynamic RCS Measurement Features

- ❖ **80 Simultaneous Measurements**
 - **150 MHz to 35 GHz**
 - **500 Hz to 200 kHz Pulse Sampling Rate**
 - **Vertical & Horizontal Polarization**
 - **+1.1/-1.5 dB (NIST Report NISTR 5073 of Feb 98)**
 - **1 Degree Aspect Resolution in both AZ & EL**
- ❖ **Coherent and Non-Coherent Measurement Systems (ADAMS & WDPS)**
- ❖ **Real-Time Processing & Display of Polar Plots**
- ❖ **Complete Statistical Reports Including Probability Density Function (PDF)**
- ❖ **Dynamic Flight Control**



RCS Measurement Antenna Sites

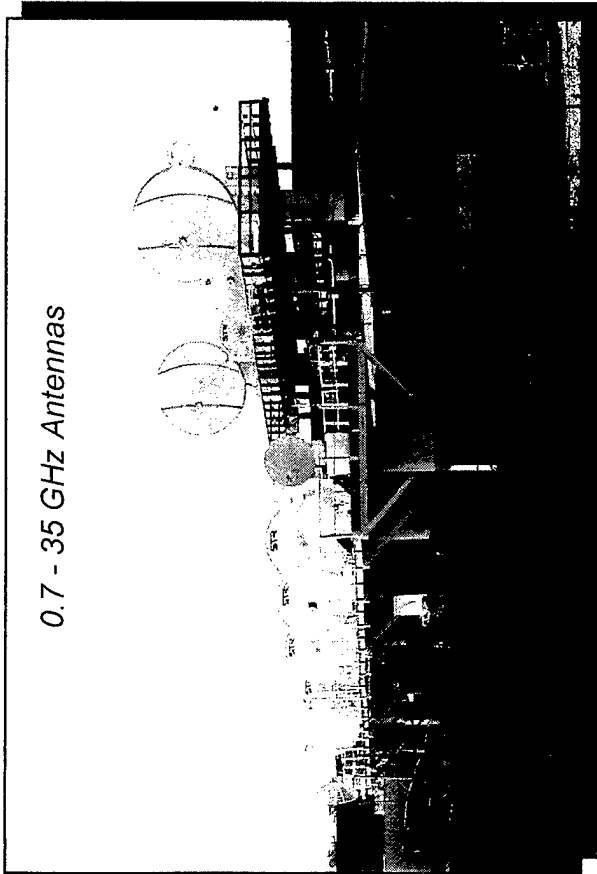

0.7 - 35 GHz Antennas

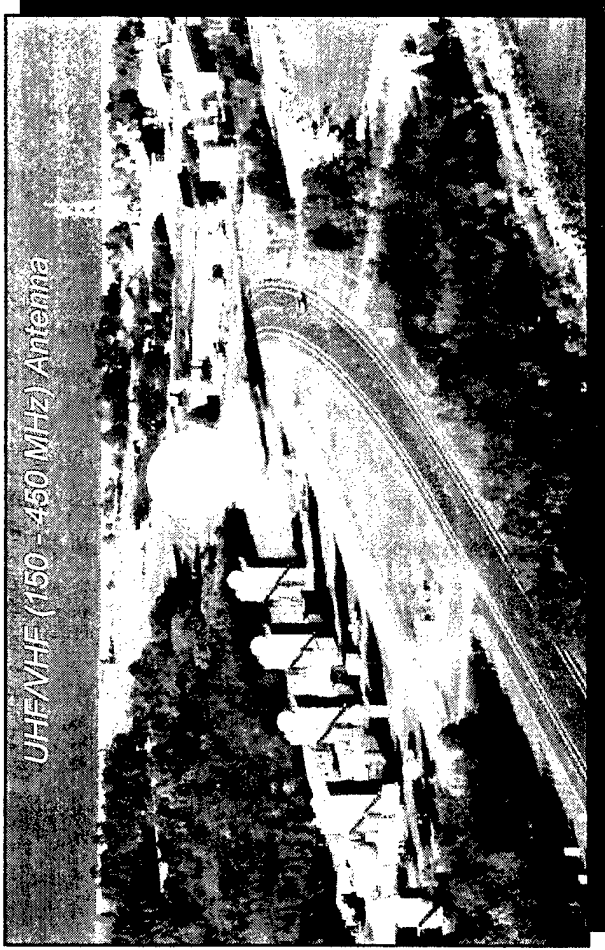

UHF/VHF (150 - 450 MHz) Antenna



RCS Flight Test System

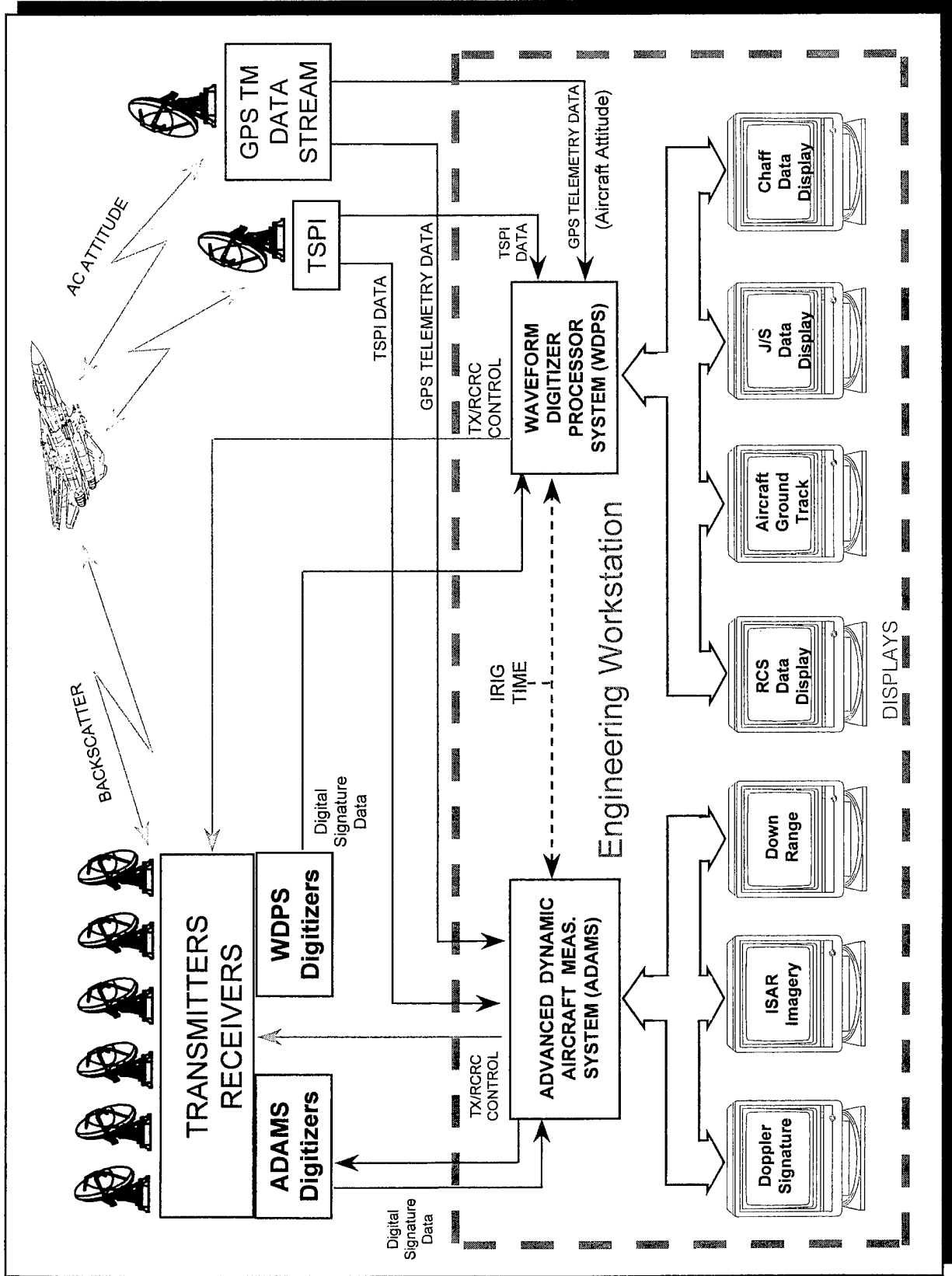



Real-Time RCS Flight Test System



RCS Engineering Workstation



Dynamic Signature Capabilities

- ❖ **Whole Body RCS Signature Measurements**
- ❖ **Doppler Signature Measurements**
 - **Blades**
 - **Jet Engine Modulation (JEM)**
- ❖ **Precision Down Range Profiles**
- ❖ **ISAR Imagery**
- ❖ **Jammer-to-Signal Ratio Measurements**
- ❖ **Chaff Measurements**
 - **Growth Rate (SP)**
 - **RF Spectrum**
 - **Shadow Graph**
- ❖ **Decoy Measurements (Towed and Expendable)**
- ❖ **Extensive Signature Data Library**



Whole Body RCS Signature Measurements Sample Data Products

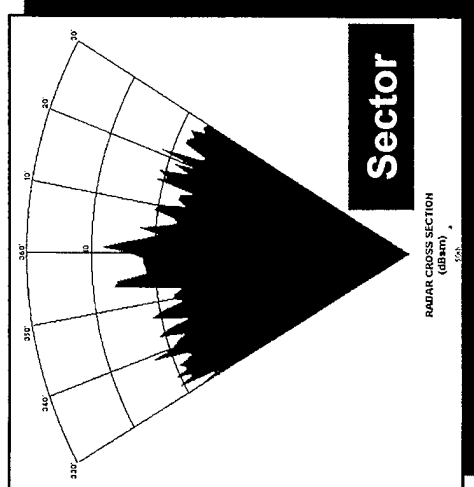
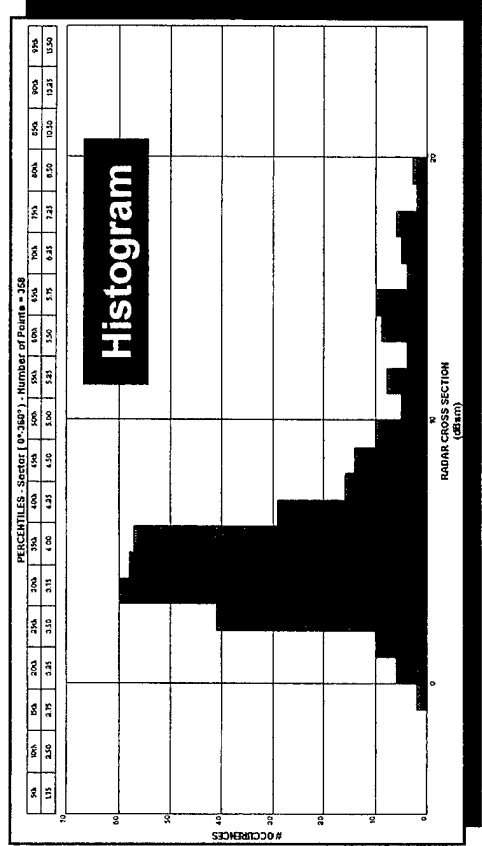
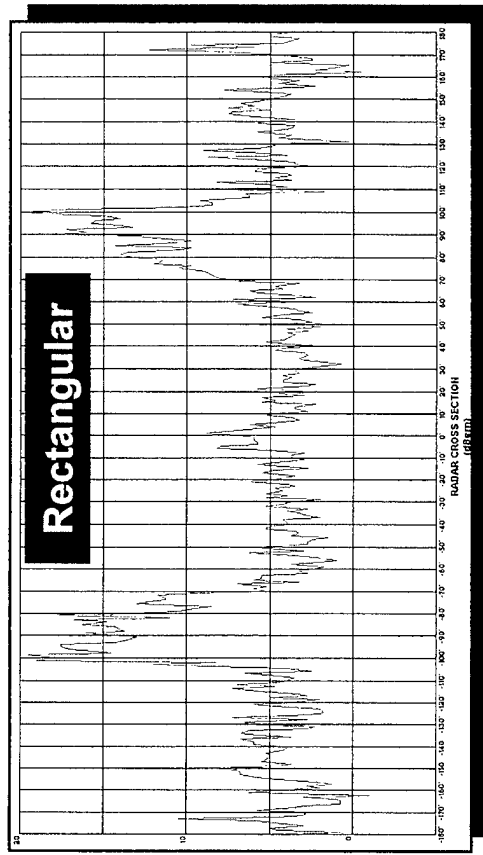
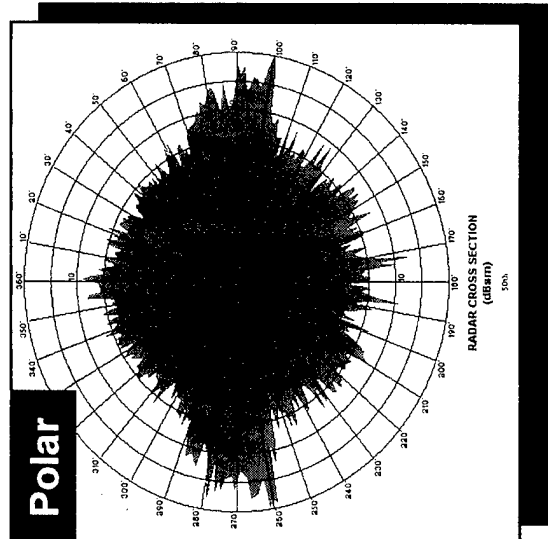



Doppler Signature Measurements Sample Data Product - Blade Modulation

Example: Piper Navajo

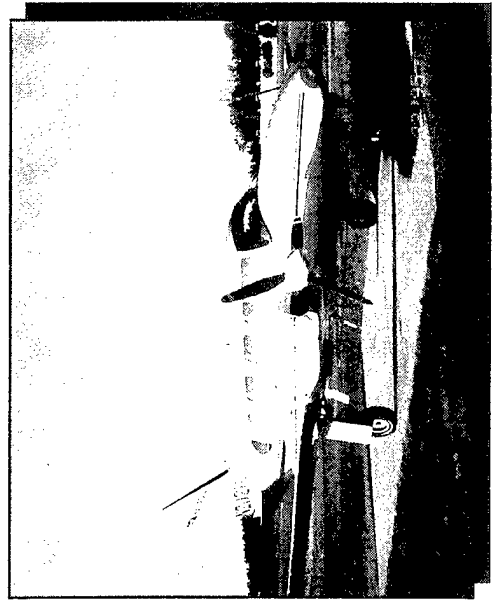
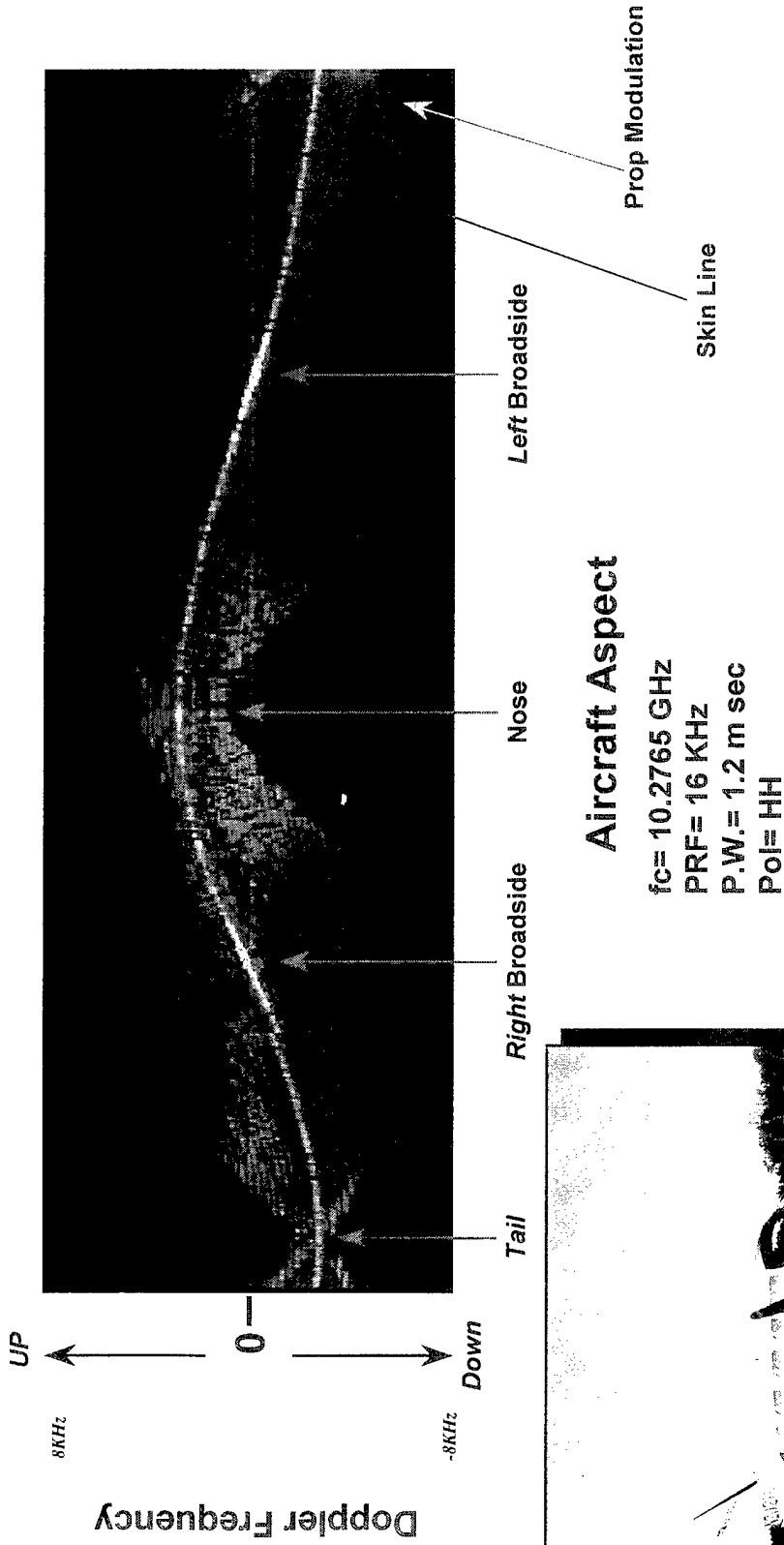



Doppler Signature Measurements Sample Data Product - JEM Spectrum/Histogram

Example: Learjet

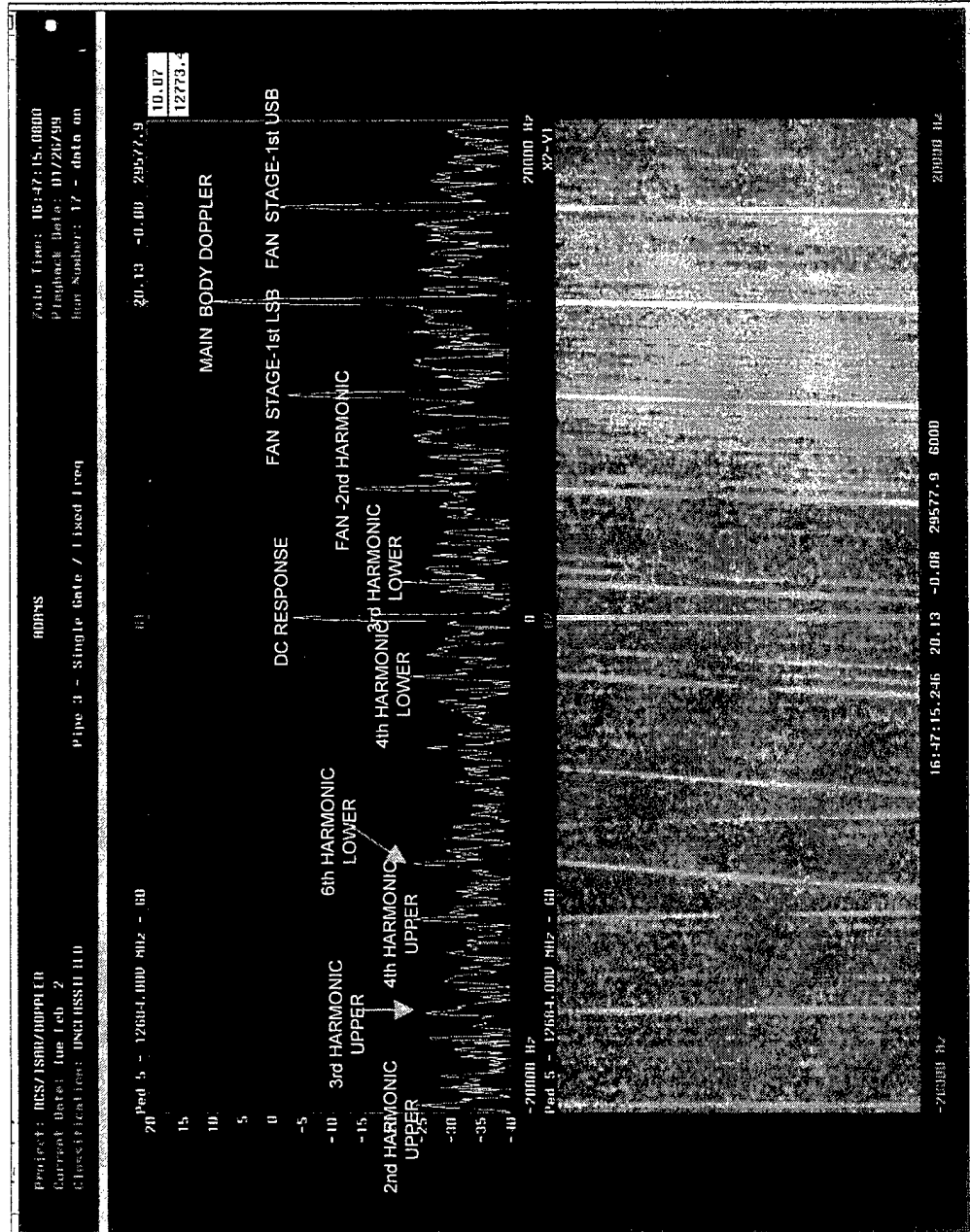



Doppler Signature Measurements Sample Data Product - JEM vs Aspect

Example: Lear 36

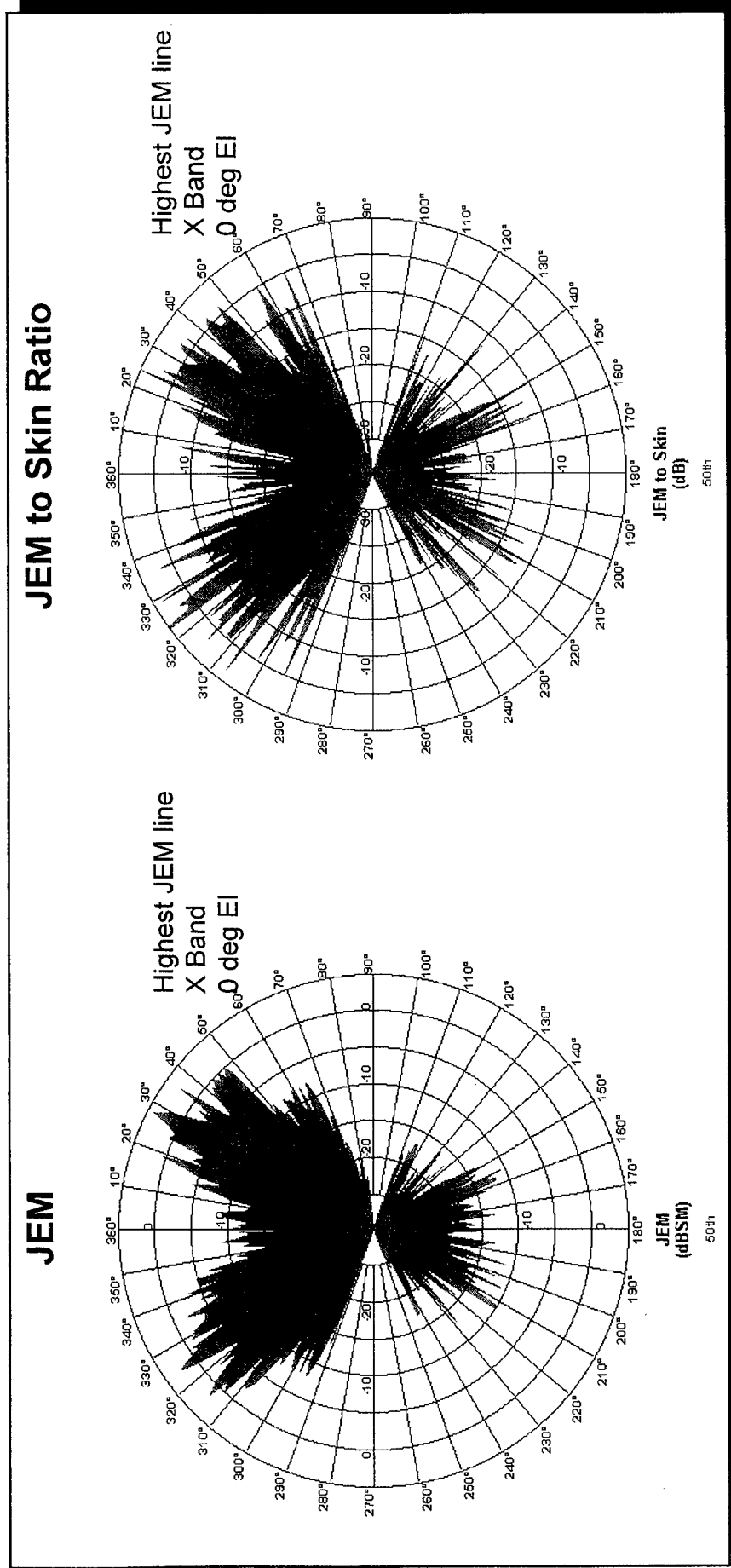



Different Engines = Different JEM

Lear 36 Engine

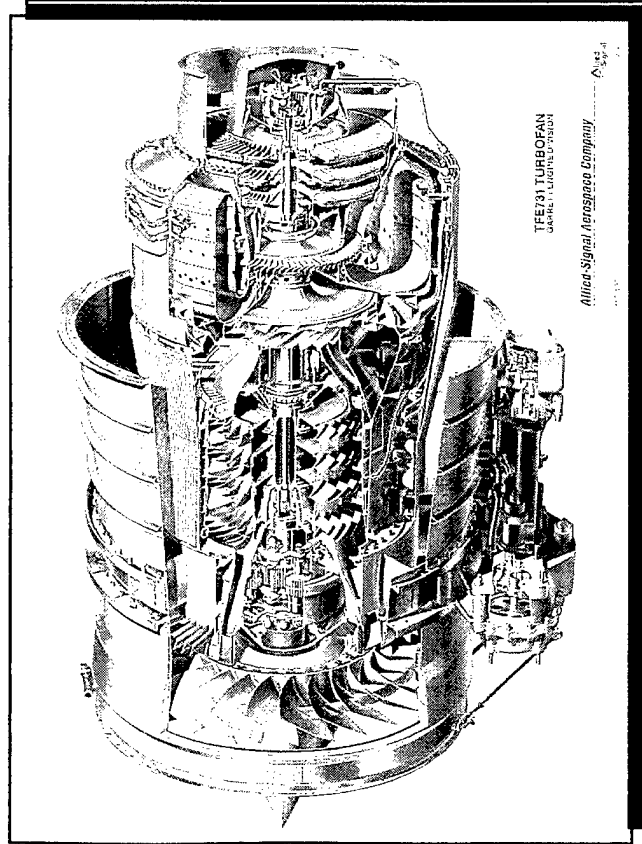

F-18E/F Engine
GE F-414

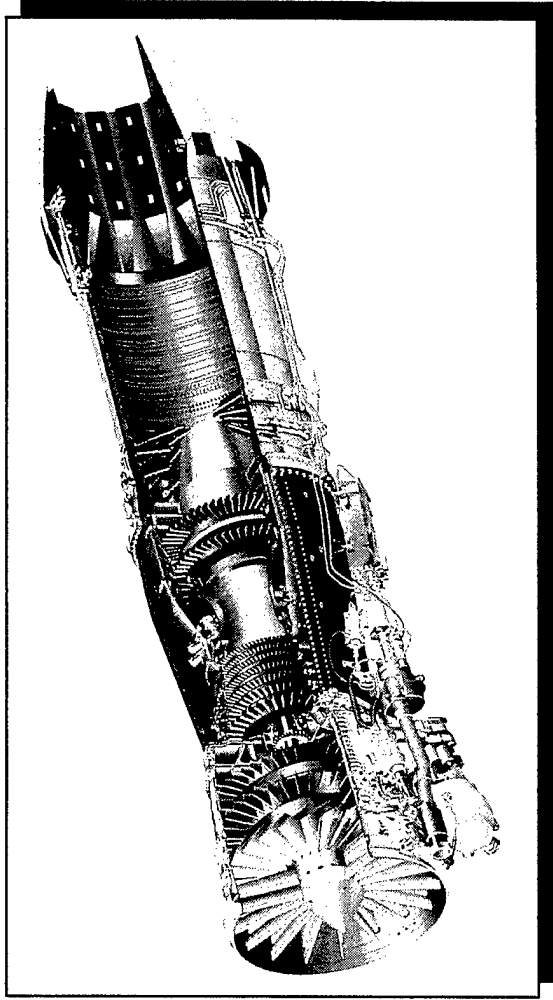



Precision Down Range Profiles

Example: Piper Navajo

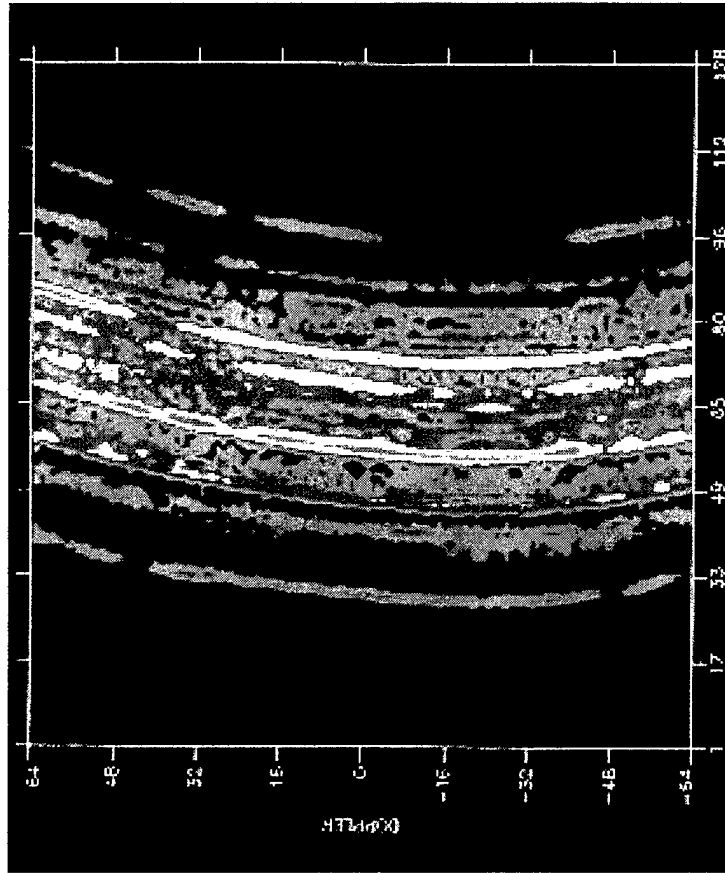

Down Range →

fc= 10.2765 GHZ Res.= 6"
PRF= 10 KHZ D f= 950 MHz
P.W.= 1.2 m sec # steps= 128
Pol= HH



ISAR Imagery

Example: Piper Navajo

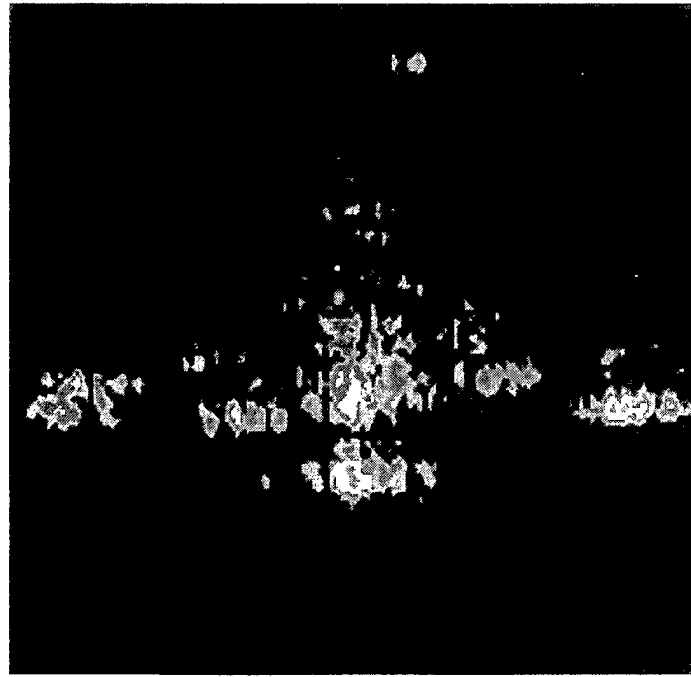

Cross Range

Down Range

fc= 10.2765 GHZ
PRF= 10 KHZ
P.W.= 1.2 m sec
Pol= HH

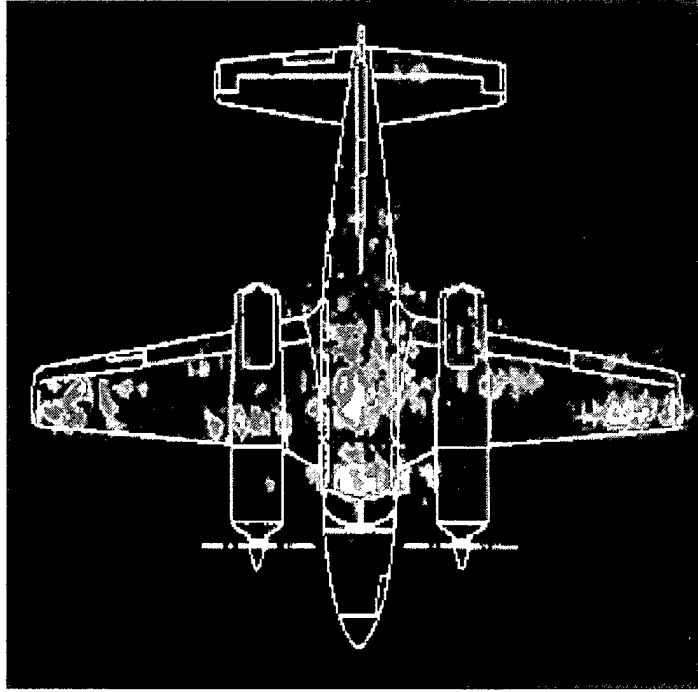

Cross Range

Down Range

Res.= 6"
D f= 950 MHZ
steps= 128



Chaff Measurements Sample Data Product - Growth Rate

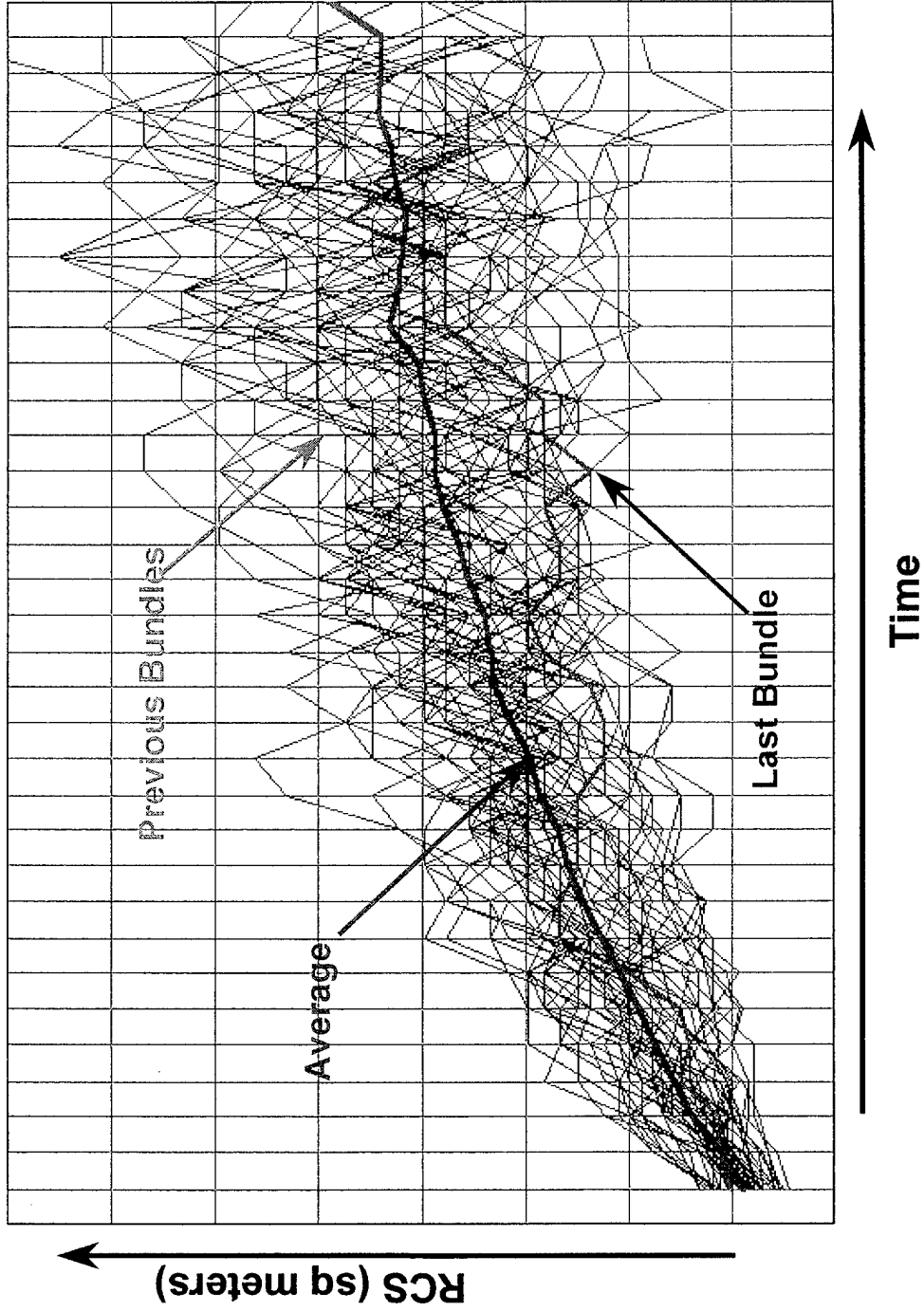



Chaff Measurements

Sample Data Product - RF Spectrum

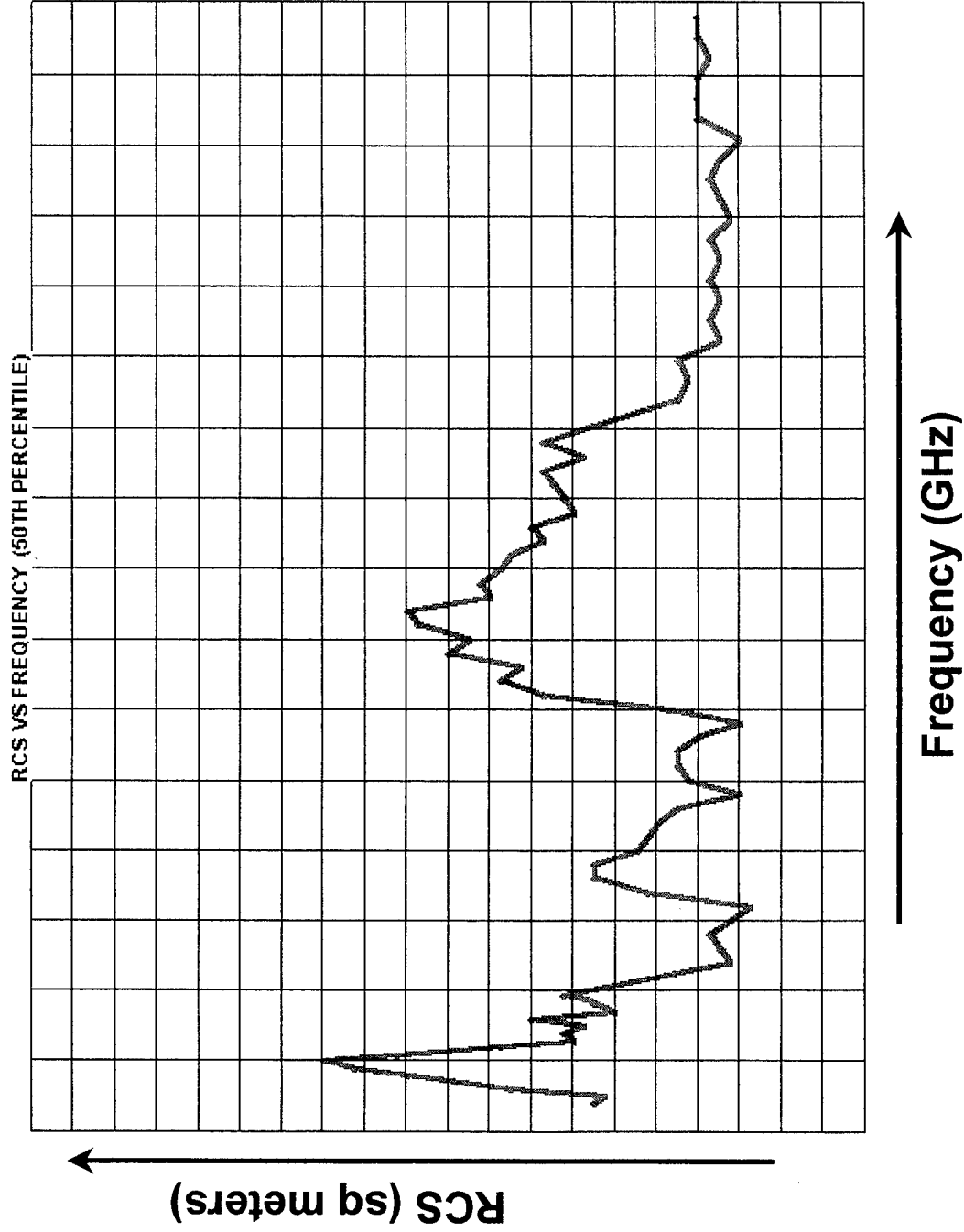



Chaff Measurements Sample Data Product - Shadow Graph

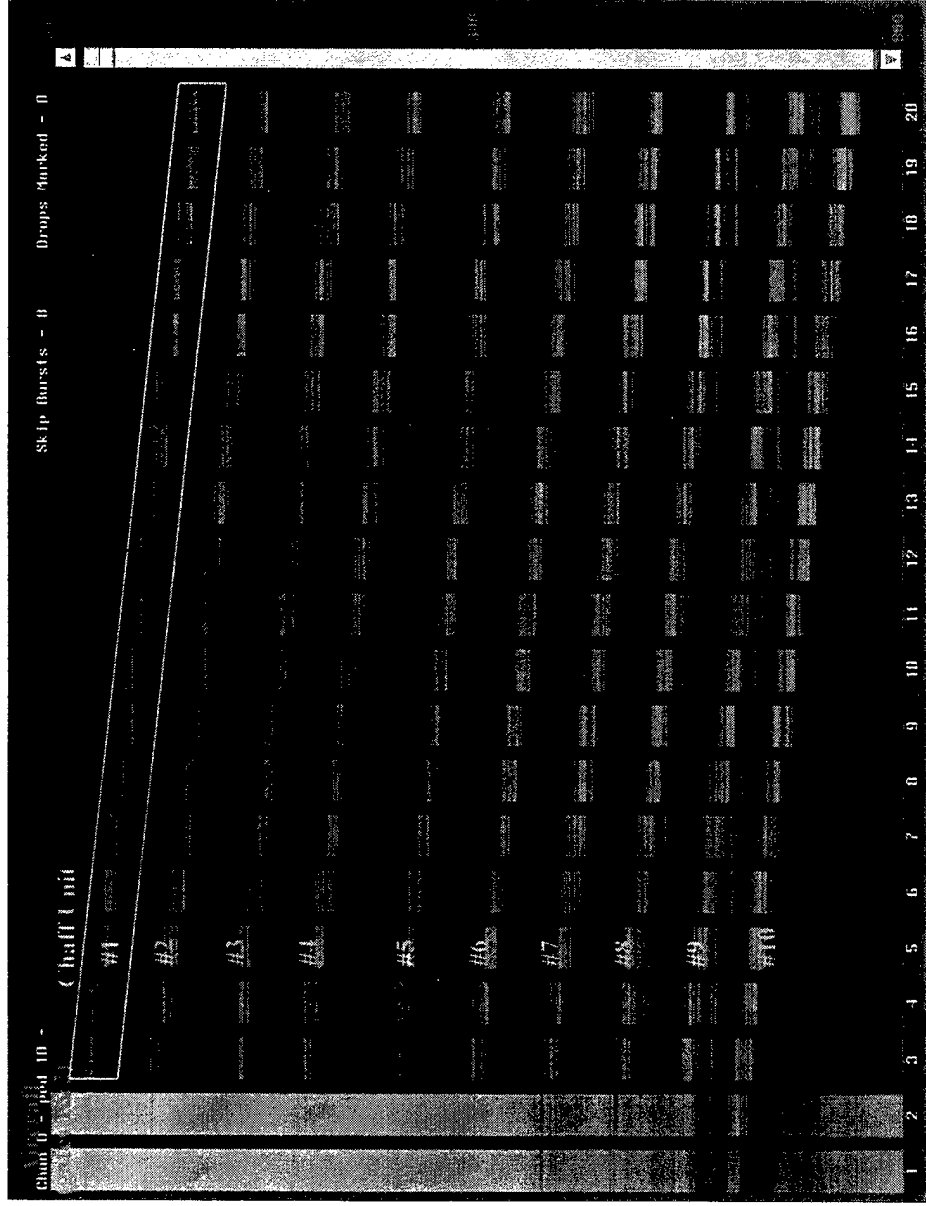

Range Gates



Extensive Signature Data Library

- ❖ **Over 50 Platforms On-Line**
 - Various Platform Configurations
- ❖ **Multiple Frequencies Available**
 - 150 MHz to 35 GHz
- ❖ **Wide Elevation Coverage**
 - $\pm 45^\circ$ Elevation 360° Azimuth
- ❖ **VV and HH Polarizations**
- ❖ **Data Available to Authorized Users**



For More Information....

Contact: Mr. Jim Tuttle/Mr. Martin Stuble

Range Measurement Team

Naval Air Warfare Center Aircraft Division

Atlantic Test Range

23029 Cedar Point Rd, Unit 4

Patuxent River, Maryland 20670-5304

(301) 342-1211 DSN: 342-1211 FAX: (301)342-1190

Email: TuttleJD@navair.navy.mil

StubleMH@navair.navy.mil

1	Coverrcs.ppt	Cover
2	Mission.ppt	Mission
3	ATR RCS Cap2.ppt	Dynamic Measurement Capabilities
4	ATR RCS Cap1.ppt	Infrastructure
5	Flight Test.ppt	Flight Test Areas
6	ATR Facility.ppt	Cedar Point Facility
7	Range Cntl Cnt.ppt	Range Control Center
8	Trk Inst Diver.ppt	Tracking Instrumentation Diversity
9	Rng Trk Sys.ppt	Range Tracking Systems Performance
10	RTPSIII.ppt	Real-Time Telemetry Processing System (RTPS)
11	Dyn Flight.ppt	Dynamic Collection Flight Control
12	BIN.ppt	Aircraft Aspect and BIN Filling Display
13	Dyn RCS Msmt 1.ppt	Dynamic In-Flight Radar Cross Section Measurements
14	Av RCS Msmt.ppt	Air Vehicle RCS Measurement Process
15	DOD Acq Prc.ppt	Signature Measurements Support DoD Acquisition Process
16	Dyn RCS Msmt 2.ppt	Why Dynamic In-Flight RCS Measurements?
17	Dyn RCS Msmt 3.ppt	Dynamic RCS Measurement Features
18	RCS Antenna.ppt	RCS Measurement Antenna Sites
19	RT RCS Tst Sys 2.ppt	RCS Flight Test System
20	RT RCS TST Sys 1.ppt	Real-Time RCS Flight Test System
21	ADAMS Coh.ppt	Wide Band RCS Measurement System (Coherent)
22	WDPS Non.ppt	Narrow Band RCS Measurement System (Non-coherent)
23	Dyn Signature.ppt	Dynamic Signature Capabilities
24	RCS Data Prod.ppt	Whole Body RCS Signature Measurements Sample Data Products
25	Doppler.ppt	Doppler Signature Measurements Sample Data Product - Blade Modulation
26	Jet Eng Mod.ppt	Doppler Signature Measurements Sample Data Product - JEM Spectrum/Histogram
27	Lear Jem.ppt	Doppler Signature Measurements Sample Data Product - JEM vs Aspect
28	Lear 36.ppt	Different Engines = Different JEM
29	Down-Range.ppt	Precision Down Range Profiles
30	ISAR.ppt	ISAR Imagery
31	Chaff 2.ppt	Chaff Measurements Sample Data Products - Growth Rate
32	Chaff 3.ppt	Chaff Measurements Sample Data Product - RF Spectrum
33	Chaff 1.ppt	Chaff Measurements Sample Data Product - Shadow Graph
34	Ext Sign Data.ppt	Extensive Signature Data Library
35	Info.ppt	For More Information...
36		List of Pages (updated 7/12/99)