

AFRL-ML-WP-TR-2000-4035

**RETIREMENT FOR CAUSE (RFC) EDDY
CURRENT INSPECTION SYSTEM
CALIBRATION IMPROVEMENT**



DAVID A. STUBBS, RICHARD W. MARTIN, AND NORM D. SCHEHL

**THE UNIVERSITY OF DAYTON RESEARCH INSTITUTE
300 COLLEGE PARK
DAYTON OH 45469-0104**

FEBRUARY 2000

FINAL REPORT: SEP 1995 - APR 1999

APPROVED FOR PUBLIC RELEASE; DISTRIBUTION UNLIMITED

**MATERIALS AND MANUFACTURING DIRECTORATE
AIR FORCE RESEARCH LABORATORY
AIR FORCE MATERIEL COMMAND
WRIGHT-PATTERSON AIR FORCE BASE OH 45433-7750**

REPORT DOCUMENTATION PAGE

1. REPORT DATE (DD-MM-YYYY) 01-02-2000	2. REPORT TYPE Final Report	3. DATES COVERED (FROM - TO) xx-09-1995 to xx-04-1999
4. TITLE AND SUBTITLE Retirement for Cause (RFC) Eddy Current Inspection System Calibration Improvement Unclassified		5a. CONTRACT NUMBER
		5b. GRANT NUMBER
		5c. PROGRAM ELEMENT NUMBER
6. AUTHOR(S) Stubbs, David A. ; Martin, Richard W. ; Schehl, Norm D. ;		5d. PROJECT NUMBER
		5e. TASK NUMBER
		5f. WORK UNIT NUMBER
7. PERFORMING ORGANIZATION NAME AND ADDRESS University of Dayton Research Institute 300 College Park Dayton , OH 45469-0104		8. PERFORMING ORGANIZATION REPORT NUMBER
9. SPONSORING/MONITORING AGENCY NAME AND ADDRESS Materials and Manufacturing Directorate Air Force Research Laboratory Air Force Materiel Command Wright-Patterson AFB , OH 45433-7750		10. SPONSOR/MONITOR'S ACRONYM(S)
		11. SPONSOR/MONITOR'S REPORT NUMBER(S)
12. DISTRIBUTION/AVAILABILITY STATEMENT A PUBLIC RELEASE Materials and Manufacturing Directorate Air Force Research Laboratory Air Force Materiel Command Wright-Patterson AFB , OH 45433-7750		

13. SUPPLEMENTARY NOTES**14. ABSTRACT**

Examination of the reliability test data from the eddy current Retirement For Cause (RFC) systems installed at the-San Antonio and Oklahoma City ALCs has revealed occasional systematic shifts in the probability of detection (POD) curves created from inspecting specimens containing fatigue cracks. Analysis showed that the shift was not related to the fatigue cracks. The most likely cause was thought to be the gain calibration process uses electro-discharge machined (EDM) notches as the artifact that causes the eddy current response, and it was thought that some of the shift in the POD curves was due to variability of the notches. EDM notches have been used in eddy current systems because of their similarity to fatigue cracks. However, the RFC eddy current systems were designed such that the calibration process did not require crack-like artifacts in order to successfully perform gain calibration. The research identified two candidate technologies fix the new calibration artifacts. A photolithography technique was investigated to produce both conductive lines and marked-off areas that caused reproducible eddy current responses. Precisely placed wire segments were also investigated as a technique to produce uniform and repeatable eddy current responses. Both types of calibration artifacts were fabricated and extensively tested for repeatability, uniformity, and ease of manufacture. Ultimately, the wire-type artifact was selected for more extensive testing due to the ease in which they were produced- Many wire-type artifacts were constructed having the same size, shape, and fit conventional EDM notch calibration blocks used on the RFC systems.

15. SUBJECT TERMS

RF6 (Retirement for Cause); Eddy Current Calibration

16. SECURITY CLASSIFICATION OF:			17. LIMITATION OF ABSTRACT Public Release	18. NUMBER OF PAGES 94	19a. NAME OF RESPONSIBLE PERSON Fenster, Lynn lfenster@dtic.mil
a. REPORT Unclassified	b. ABSTRACT Unclassified	c. THIS PAGE Unclassified			19b. TELEPHONE NUMBER International Area Code Area Code Telephone Number 703 767-9007 DSN 427-9007

NOTICE

WHEN GOVERNMENT DRAWINGS, SPECIFICATIONS, OR OTHER DATA ARE USED FOR ANY PURPOSE OTHER THAN IN CONNECTION WITH A DEFINITELY GOVERNMENT-RELATED PROCUREMENT, THE UNITED STATES GOVERNMENT INCURS NO RESPONSIBILITY OR ANY OBLIGATION WHATSOEVER. THE FACT THAT THE GOVERNMENT MAY HAVE FORMULATED OR IN ANY WAY SUPPLIED THE SAID DRAWINGS, SPECIFICATIONS, OR OTHER DATA, IS NOT TO BE REGARDED BY IMPLICATION OR OTHERWISE IN ANY MANNER CONSTRUED, AS LICENSING THE HOLDER OR ANY OTHER PERSON OR CORPORATION, OR AS CONVEYING ANY RIGHTS OR PERMISSION TO MANUFACTURE, USE, OR SELL ANY PATENTED INVENTION THAT MAY IN ANY WAY BE RELATED THERETO.

THIS REPORT IS RELEASABLE TO THE NATIONAL TECHNICAL INFORMATION SERVICE (NTIS). AT NTIS, IT WILL BE AVAILABLE TO THE GENERAL PUBLIC, INCLUDING FOREIGN NATIONS.

THIS TECHNICAL REPORT HAS BEEN REVIEWED AND IS APPROVED FOR PUBLICATION.

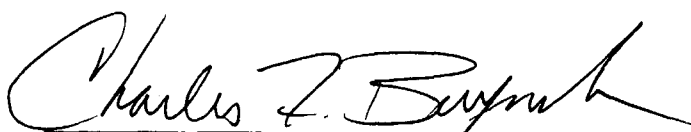

CHARLES F. BUYNAK, Project Engineer
Nondestructive Evaluations Branch
Metals, Ceramics & NDE Division

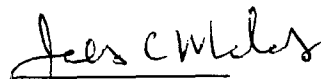

JAMES C. MALAS, Chief
Nondestructive Evaluations Branch
Metals, Ceramics & NDE Division



WALTER M. GRIFFITH, Chief
Metals, Ceramics & NDE Division
Materials & Manufacturing Directorate

COPIES OF THIS REPORT SHOULD NOT BE RETURNED UNLESS RETURN IS REQUIRED BY SECURITY CONSIDERATIONS, CONTRACTUAL OBLIGATIONS, OR NOTICE ON A SPECIFIC DOCUMENT.

REPORT DOCUMENTATION PAGE

Form Approved
OMB No. 0704-0188

Public reporting burden for this collection of information is estimated to average 1 hour per response, including the time for reviewing instructions, searching existing data sources, gathering and maintaining the data needed, and completing and reviewing the collection of information. Send comments regarding this burden estimate or any other aspect of this collection of information, including suggestions for reducing this burden, to Washington Headquarters Service, Directorate for Information Operations and Reports, 1215 Jefferson Davis Highway, Suite 1204, Arlington, VA 22202-4302, and to the Office of Management and Budget, Paperwork Reduction Project (0704-0188), Washington, DC 20503.

1. AGENCY USE ONLY (Leave blank)		2. REPORT DATE FEBRUARY 2000	3. REPORT TYPE AND DATES COVERED FINAL REPORT FOR SEP 1995 - APR 1999	
4. TITLE AND SUBTITLE RETIREMENT FOR CAUSE (RFC) EDDY CURRENT INSPECTION SYSTEM CALIBRATION IMPROVEMENT			5. FUNDING NUMBERS C F33615-95-C-5241 PE 63112 PR 3153 TA 00 WU 18	
6. AUTHOR(S) DAVID A STUBBS, RICHARD W. MARTIN, AND NORM D. SCHEHL				
7. PERFORMING ORGANIZATION NAME(S) AND ADDRESS(ES) UNIVERSITY OF DAYTON RESEARCH INSTITUTE 300 COLLEGE PARK DAYTON, OHIO 45469-0104			8. PERFORMING ORGANIZATION REPORT NUMBER UDR-TR-2000-00057	
9. SPONSORING/MONITORING AGENCY NAME(S) AND ADDRESS(ES) MATERIALS AND MANUFACTURING DIRECTORATE AIR FORCE RESEARCH LABORATORY AIR FORCE MATERIEL COMMAND WRIGHT-PATTERSON AFB, OH 45433-7750 POC: CHARLES F. BUYNAK, AFRL/MLLP, 937-255-9807			10. SPONSORING/MONITORING AGENCY REPORT NUMBER AFRL-ML-WP-TR-2000-4035	
11. SUPPLEMENTARY NOTES				
12a. DISTRIBUTION AVAILABILITY STATEMENT APPROVED FOR PUBLIC RELEASE; DISTRIBUTION UNLIMITED.			12b. DISTRIBUTION CODE	
13. ABSTRACT (Maximum 200 words) Examination of the reliability test data from the eddy current Retirement For Cause (RFC) systems installed at the San Antonio and Oklahoma City ALCs has revealed occasional systematic shifts in the probability of detection (POD) curves created from inspecting specimens containing fatigue cracks. Analysis showed that the shift was not related to the fatigue cracks. The most likely cause was thought to be the gain calibration process uses electro-discharge machined (EDM) notches as the artifact that causes the eddy current response, and it was thought that some of the shift in the POD curves was due to variability of the notches. EDM notches have been used in eddy current systems because of their similarity to fatigue cracks. However, the RFC eddy current systems were designed such that the calibration process did not require crack-like artifacts in order to successfully perform gain calibration. The research identified two candidate technologies for the new calibration artifacts. A photolithography technique was investigated to produce both conductive lines and marked-off areas that caused reproducible eddy current responses. Precisely placed wire segments were also investigated as a technique to produce uniform and repeatable eddy current responses. Both types of calibration artifacts were fabricated and extensively tested for repeatability, uniformity, and ease of manufacture. Ultimately, the wire-type artifact was selected for more extensive testing due to the ease in which they were produced. Many wire-type artifacts were constructed having the same size, shape, and fit conventional EDM notch calibration blocks used on the RFC systems. <p style="text-align: right;">(continued)</p>				
14. SUBJECT TERMS RFC (Retirement For Cause), Eddy current, calibration			15. NUMBER OF PAGES 94	
			16. PRICE CODE	
17. SECURITY CLASSIFICATION OF REPORT UNCLASSIFIED	18. SECURITY CLASSIFICATION OF THIS PAGE UNCLASSIFIED	19. SECURITY CLASSIFICATION OF ABSTRACT UNCLASSIFIED	20. LIMITATION OF ABSTRACT SAR	

13. ABSTRACT (continued)

Data were acquired on the University of Dayton eddy current system, a RFC eddy current system at Veridian, Inc. in Dayton, OH, and on a RFC system at Oklahoma City ALC. In the final configuration, no statistical difference in the POD curves could be discerned when using the new wire-type calibration blocks as compared to the conventional EDM notch calibration blocks.

Besides lessening the effect on POD of the gain calibration the new calibration blocks have the potential of giving other benefits when implemented into ALC inspection systems. These other benefits include: substantially reduced calibration times, calibration block cost reductions on the order of 50 percent, and significant reduction in the property control and utilization logistics associated with conventional EDM notch calibration blocks.

Table of Contents

List of Figures	v
List of Tables	viii
Executive Summary	ix
1.0 INTRODUCTION	1
2.0 STATEMENT OF THE PROBLEM	2
2.1 Inherent variability in EDM notches	2
2.2 Small size of EDM notches	2
2.3 Cost	3
2.4 Property control and utilization logistics	3
2.5 Station-to-station variability in the Probability of Detection results	3
3.0 PROPOSED SOLUTION	5
4.0 RESEARCH AND DEVELOPMENT APPROACH	6
5.0 RESEARCH AND DEVELOPMENT RESULTS	8
5.1 Eddy Current Data Acquisition System	8
5.2 MACOR® Machinable Ceramic Substrate Material	9
5.3 Electronic Artifact	10
5.4 Photolithography Artifact	10
5.5 Wire-type Artifacts	16
6.0 DATA: EDDY CURRENT RESPONSE TO WIRE ARTIFACTS	23
7.0 RESULTS: RELIABILITY TESTING AND ANALYSIS	32
8.0 IMPLEMENTATION CONSIDERATIONS	38
8.1 Effects on Existing Scan Plans - Phase Calibration	38
8.2 Effects on Existing Scan Plans - Gain Calibration	39
8.3 Effects on Existing Scan Plans - Placement of Calibration Blocks	40
8.4 Durability and Wear of Calibration Blocks	41
8.5 Costs of the Wire Artifact Calibration Blocks	43
8.6 Manufacturing Process	43
9.0 RECOMMENDATIONS FOR FUTURE WORK	45
10.0 ACKNOWLEDGMENTS	46

Appendix A
Overview of Calibration in the RFC Systems A - 1

Appendix B
Proposed Objectives and Goals B - 1

Appendix C
Specifications for Eddy Current Data Acquisition System C - 1

Appendix D
Properties of MACOR® D - 1

Appendix E
Mechanical Drawing of Standard RFC Calibration Block
and Modifications for Wire Artifact Process E - 1

Appendix F
Reliability Test Results F - 1

Appendix G
Results of the Eddy Current Probe Shoe Wear Tests on the Surface of the MACOR®
Substrate, Wire Artifact, Calibration Blocks G - 1

List of Figures

Figure 1 - Mechanical frame, motorized axes, and alignment fixtures of the eddy current data acquisition system used to develop the new calibration blocks.	8
Figure 2 - Comparison of the eddy current responses from EDM notches in the UDRI Waspaloy calibration block and the RFC Master Waspaloy calibration block.	9
Figure 3 - MACOR® stock used for substrate material for surface calibration blocks and RECHII inserts.	10
Figure 4 - Comparison of the edges of a photolithography “notch” (left photograph) and an EDM notch (right photograph).	11
Figure 5 - Gold coated MACOR® substrate (left) and glass plate (right). Variations in the gold film thickness are evident on the glass plate.	12
Figure 6 - The eddy current response along a photolithographic “notch” was very uniform.	13
Figure 7 - Eddy current responses from five different photolithography notches on a MACOR® substrate.	13
Figure 8 - The photolithography process was evaluated for creating RECHII calibration artifacts.	14
Figure 9 - The eddy current response along the axis of a photolithography artifact, RECHII calibration insert.	14
Figure 10 - The initial process for creating wire-type calibration artifacts.	16
Figure 11 - Different compositions of wire greatly affect the eddy current response.	17
Figure 12 - The difference in gage of the wires clearly affects the eddy current response.	18
Figure 13 - A precision machined, steel fixture was used to produce correct wire alignment on the substrates.	18
Figure 14 - This schematic shows the placement of the wire relative to the substrate and surface of the binder.	19
Figure 15 - The process of creating five-sided wire-type artifacts is shown in the photograph on the left. The resultant calibration block is shown in the right photograph.	20

Figure 16 - A mold was created to allow simultaneous construction of all five sides of the wire-artifact blocks. 20

Figure 17 - The hybrid, wire-type RECHII calibration inserts are shown. 21

Figure 18 - The gage assembly used to create the RECHII inserts is shown. 21

Figure 19 - In this figure the RECHII alignment gage is shown with a RECHII insert being assembled 22

Figure 20 - The greatly superior signal-to-noise ratio of the wire-artifact calibration block compared to an EDM notch in titanium is illustrated. 23

Figure 21 - The uniformity of eddy current response along any given wire is shown by a pie chart of the variations from an average response. 23

Figure 22 - The variation in eddy current response from wire-to-wire is shown for 33 different NiCr wires on acrylic substrates. 24

Figure 23 - The uniformity of the eddy current response along any given wire and from wire-to-wire is shown for a five-sided, MACOR® substrate, RFC-style calibration block. 25

Figure 24 - Five wire-artifact, five-sided, RFC-style, MACOR® substrate calibrations blocks are shown. 27

Figure 25 - The uniformity of eddy current response along any given wire on the five-sided, RFC-style, MACOR® substrate blocks is clearly validated. 28

Figure 26 - The wire-to-wire variability for three RFC-style calibration blocks (15 wires) is shown to be less than 1 dB for all but one of the wires (2 MHz probe). 28

Figure 27 - The wire-to-wire variability for three RFC-style calibration blocks (15 wires) is shown to be less than 1 dB for all but two of the wires (6 MHz probe). 29

Figure 28 - The variation in the eddy current response along the wire artifact in two RECHII inserts is shown. 31

Figure 29 - Flat plate Waspaloy reliability specimens were used to compare inspections using the new calibration blocks with Waspaloy master EDM calibration blocks. 32

Figure 30 - Using the five-sided, RFC-style, wire-artifact, calibration blocks to calibrate an RFC eddy current system produced reliability results that were indistinguishable from those obtained using the master Waspaloy EDM notch calibration block.	33
Figure 31 - Comparison of 6 MHz reliability results using probe 13652.	35
Figure 32 - Comparison of 6 MHz reliability results using probe 13653.	35
Figure 33 - Comparison of 2 MHz reliability results using probe 15077.	36
Figure 34 - Comparison of 2 MHz reliability results using probe 15078.	36
Figure 35 - Comparison of 2 MHz reliability results: probe-to-probe variation.	37
Figure 36 - Comparison of 6 MHz reliability results: probe-to-probe variation.	37
Figure 37 - An engine alloy end piece has been attached to the MACOR® wire-artifact block so that the block can be used for phase calibration.	38
Figure 38 - An alternative configuration of calibration blocks for maximizing the number of engine components that can be inspected on an RFC eddy current system.	41
Figure 39 - The metal base plate improves the ruggedness of the MACOR® substrate calibration blocks.	41
Figure 40 - An eddy current probe shoe was used to conduct wear tests on the wire-artifact calibration blocks.	42
Figure 41 - The pneumatic press and mold is shown in this photograph.	44
Figure 42 - This calibration block was made using the press shown in Figure 41.	44

List of Tables

Table I - Optical Evaluation of Wire Artifact and Block Surface Conditon. 31

Table II - Summary of Eddy Current Responses from Flat Plate Reliability Specimens 34

Table III - Effects on Scan Plan of Using New Calibration Block. 39

Executive Summary

Examination of the reliability test data from the eddy current retirement for cause (RFC) systems installed at the San Antonio and Oklahoma City ALCs has revealed occasional systematic shifts in the probability of detection (POD) curves created from inspecting specimens containing fatigue cracks. Analysis showed that the shift was not related to the fatigue cracks. The most likely cause was thought to be the gain calibration process that occurs before each probe is used to inspect an engine component. The gain calibration process uses electro-discharge machined (EDM) notches as the artifact that causes the eddy current response, and it was thought that some of the shift in the POD curves was due to variability in the notches. EDM notches have been used in eddy current systems because of their similarity to fatigue cracks. However, the RFC eddy current systems were designed such that the calibration process did not require crack-like artifacts in order to successfully perform gain calibration. Consequently, the University of Dayton proposed a research program to identify and develop a new type of calibration artifact that could be produced in a more repeatable fashion than EDM notches.

The research identified two candidate technologies for the new calibration artifacts. A photolithography technique was investigated to produce both conductive lines and masked-off areas that caused reproducible eddy current responses. Precisely placed wire segments were also investigated as a technique to produce uniform and repeatable eddy current responses. Both types of calibration artifacts were fabricated and extensively tested for repeatability, uniformity, and ease of manufacture. Ultimately, the wire-type artifact was selected for more extensive testing due to the ease in which they were produced.

Many wire-type artifacts were constructed having the same size, shape, and fit as the conventional EDM notch calibration blocks used on the RFC systems. Data were acquired on the University of Dayton eddy current system, a RFC eddy current system at Veridian, Inc. in Dayton, OH, and on a RFC system at Oklahoma City ALC. In the final configuration, no statistical difference in the POD curves could be discerned when using the new wire-type calibration blocks as compared to the conventional EDM notch calibration blocks.

Besides lessening the effect on POD of the gain calibration the new calibration blocks have the potential of giving other benefits when implemented into ALC inspection systems. These other benefits include: substantially reduced calibration times, calibration block cost reductions on the order of 50 percent, and significant reduction in the property control and utilization logistics associated with convention EDM notch calibration blocks.

1.0 INTRODUCTION

This report describes the research and development performed by the University of Dayton Research Institute that resulted in a completely new calibration artifact and methodology for the Retirement of Cause (RFC) eddy current inspection systems in use at U.S. Air Force inspection facilities. By the end of the program several prototype calibration blocks had been fabricated and tested on RFC inspection systems at the University of Dayton, Veridian (a supplier of the RFC eddy current systems), and the inspection facilities at Oklahoma City Air Logistics Command. Analysis of data obtained from reliability specimens containing fatigue cracks showed that there was no statistically significant difference between inspections calibrated using conventional calibration blocks and the new calibration blocks. Implementation of the blocks into the ALC environment will likely require a production feasibility program to demonstrate that the blocks can be created in sufficient quantities to support the ALC needs.

This report is organized to lead the reader through the research and development steps that occurred during the program. All of the major research tasks are described but the tasks leading to the most successful calibration block method receive the most emphasis. While the report assumes the reader is somewhat familiar with the RFC systems it does not assume familiarity with the calibration process or details of the calibrations blocks. Thus, Appendix A is included to acquaint the reader with the RFC calibration process and several sections in the Appendix describe the problems with conventional eddy current calibration blocks, the solution proposed by the University of Dayton Research Institute and the technical approach taken to develop the solution.

Finally, during the quarterly status reviews of this program and associated RFC PRDA programs, the Air Force requested that this final report contain a recommendation of the placement and use of the new calibration blocks on the RFC systems. Section 8.3 contains a recommendation that UDRI feels optimizes the use of the new calibration blocks on the RFC system.

2.0 STATEMENT OF THE PROBLEM

Examination of reliability test data from the RFC systems during the past ten years revealed occasional systematic shifts in the amplitude of eddy current responses from fatigue cracks. The most likely cause was thought to be the gain calibration process that occurs whenever a probe is selected for an inspection. Examination of the gain calibration process revealed that much of the problem was due to the use of electro-discharge machined (EDM) notches for calibration. Specifically, five problems associated with the notches were identified and are describe below.

2.1 Inherent variability in EDM notches

Using EDM notches for the purpose of conveying system sensitivity settings were causing occasional shifts in the amplitude of the RFC system eddy current responses. Placing EDM notches in engine component alloys is as much an art as a science. Each EDM machinist often has his own values for the machining parameters (voltage, feed rate, electrode undersizing, oil conditions, etc.). Additionally, variations in the microstructure of the engine part alloys causes deviations in the machining process. The final result is that each EDM notch is different. The differences can be dimensional and/or changes in the conductivity of the surrounding metal due to the heat affected zone.

In the RFC eddy current systems, variations from notch-to-notch are partially compensated for through look-up tables that correlate the signal from each notch to the signal from a "master notch". Each eddy current station contains look-up tables for each notch resident on the station. During gain calibration the system sensitivity is compensated according to the amplitude scaling information found in the look-up tables. In theory, this approach should work well in reducing the effects of notch variability. However, the creation of the look-up table values is a source of variability itself.

2.2 Small size of EDM notches

Small EDM notches are used in conventional eddy current calibration blocks for two reasons: 1) as a holdover from the days of manual inspections using analog eddy current instruments, and 2) long EDM notches are inherently variable in the response they give to eddy current inspections. Traditionally it is desirable to use a calibration artifact that closely resembles the defect of interest. However, the RFC systems only require gain calibration on an artifact that can convey the information from the original system setup in the laboratory to the system settings necessary for the current inspection (see Appendix A). Long EDM notches would seem to work except for the inherent variability in the eddy current response along the length of the notch.

Small EDM notches create serious problems in the calibration of automated systems. Typical RFC eddy current probe coil diameters are 0.080 to 0.120 inches. To get the maximum response from the EDM notch the coil must pass over the notch at a location that most disrupts the eddy currents created by the coil. The location of the maximum response must be found to within ± 0.001 inches. The RFC system attempts to find this location by indexing the probe across the reference standards. A preliminary search takes place with 0.010 inch steps and then a finer inspection takes place using 0.005 inch index steps. Experiments have determined that the eddy current signal from the notch can vary as much as 6 dB (50%)

between scans that are as little as 0.010 inches apart. Further, evidence shows that the finer indexing of 0.005 inches can cause deviations in the eddy current signal amplitude of 1-2 dB (12% - 25%). Better reproducibility could be achieved by indexing in finer increments. However, the current indexing process produces gain calibration times that last eight minutes or more. Finer indexing would increase an already undesirable calibration time per probe.

2.3 Cost

To understand the costs involved in creating the EDM notches for calibration, let's examine the reference standards needed for one eddy current system for the inspection of GE F101 and F110 components. The F110/F101 engine inspections require the creation of three surface calibration blocks (Rene-95, INCO-718, and Ti-17) and approximately, 20 bolt hole calibration inserts. The bolt hole inserts each contain two notches (one on the corner, one in the bore) and the surface calibration blocks each contain fifteen notches. For one set of calibration blocks 85 EDM notches must be created. Each notch must be machined, replicated, and compared to a "master notch". It is typical for the machining cost alone to be on the order of several hundred dollars, per notch, for these size notches. Replication and comparison to "master notches" are time consuming and must be done by highly skilled (and thus expensive) personnel.

In addition to the costs of creating and documenting each EDM notch, the cost of the reference block itself must be taken into account. Due to the linear scanning technique used during calibration, the surface blocks must each be six inches or longer. This allows the scanning machinery to accelerate to a constant speed before acquiring the EDM notch data. To accommodate various probe angles, five faces of the reference block are machined and ground to a 32 microinch finish. Over 10 cubic inches of engine component alloy are needed for each surface block. Some alloys are available only from the engine company. The summation of the requirements for the reference blocks is that the blocks themselves are very expensive to acquire; some are only available from one source - the engine manufacturers.

2.4 Property control and utilization logistics

As stated above, each engine requires the creation and utilization of 20-30 reference blocks containing 80 or more EDM notches, *for each eddy current inspection station*. In addition, a "master set" of reference blocks and one spare set are required. The U.S. Air Force currently has approximately forty RFC systems in operation. Including only the inspections for the F100, F101, and F110 engines, a rough estimate of the calibration blocks required results in 1050 blocks containing over 3300 EDM notches! This number will only get larger considering that the ALCs are expected to begin inspections of new engines in the foreseeable future. Keeping track of, and protecting over 1000 reference blocks cannot be a desirable task. Further, keeping the notch calibration factor look-up tables for over 3300 notches is an invitation for incorrectly calibrated inspections. In fact, at one of the RFC PRDA reviews it was mentioned that incorrect look-up tables had been used in inspections on at least one occasion in the ALCs.

2.5 Station-to-station variability in the Probability of Detection results

Some of the problems that have been discussed in the preceding paragraphs have resulted in undesirable degradation in the reliability of inspections on the RFC systems. On occasion UDRI has

analyzed POD curves for the same reliability inspections acquired using two different RFC eddy current systems and observed that the set of POD curves for one of the stations is shifted along the crack size axis compared to the results for the other system. Ideally the POD curves should be nearly identical for the two systems. UDRI feels that the most logical explanation for the station-to-station POD variability are the errors associated with using EDM notches for gain calibration.

Summarizing, UDRI felt that the use of EDM notches for calibrating the gain of the RFC systems was creating several problems adversely affecting the reliability and throughput of the ALC inspections. Consequently, UDRI proposed the solution of creating an eddy current calibration process that did not require EDM notches.

3.0 PROPOSED SOLUTION

Examining the problems listed above leads to the following conclusions:

- 1) A calibration "artifact" is needed that can be exactly duplicated in a manner which provides repeatable eddy current responses, and eliminates the need for notch amplitude scaling factor look up tables,
- 2) A new calibration artifact and calibration process are needed that eliminate or reduce the need for searching for the maximum response, and
- 3) The artifact must be simply and cheaply produced, easily replicated, identical to other calibration artifacts (thus removing the requirement for lookup tables), and can be used for the gain calibration of both surface and bolt hole probes.

The solution UDRI proposed was possible due to insight into how the RFC calibration process worked. Specifically, in the RFC calibration process, no requirement exists for using EDM notches for gain calibration. Any artifact that produces similar eddy current responses for different probe/instrument/station combinations can be used. This opened up the range of calibration artifacts to include many products and processes already established in other technical fields. Thus, when the program started the solution to the EDM notch problem was to conduct research and development of a reproducible gain calibration artifact by:

- 1) Establishing that "metallic artifacts" or electromagnetic field generators are suitable substitutes for EDM notches, and
- 2) Developing the most reproducible and appropriate artifact for RFC system calibration.

4.0 RESEARCH AND DEVELOPMENT APPROACH

To begin the program UDRI searched for three “types” of potential calibration artifacts: metallic objects, photolithography “notches”, and electromagnetic devices. Each type of artifact would have to be tested to see if it could produce suitable eddy current responses, be reproduced, be used in a form that eliminated the “searching” routines required for EDM notches, and produced at a reasonable cost.

There are many types of metallic objects that are very accurately reproduced in large quantities. Eventually, the list was narrowed down to a very common object that is produced, literally, in quantities of many thousands of miles per day: **wire**. Wire is drawn to accurate diameters from stock that is very reproducible. Wire can be purchased in a wide range of diameters and cut to any length. However, if was not known if passing an eddy current probe over a conductor (the wire), as opposed to passing the probe from a conductor to a “void” (the EDM notch), would produce usable eddy current responses. Thus, the first goal for this approach was to determine if wire could be used to produce suitable eddy current responses using RFC probes and equipment.

The second type of artifact considered was to create a “notch” using **photolithography techniques**. In essence, the metal calibration block would be replaced by a metallic film on a nonconducting substrate, and a notch-shaped area of no film would represent the EDM notch. Photolithography processes are extensively used in the electronics industry to produce very uniform, reproducible traces on integrated circuit boards. It was felt that photolithography had potential for producing very uniform and reproducible artifacts useful for eddy current gain calibration.

A third concept was to use an electromagnetic field to calibrate the eddy current probes. UDRI proposed to examine devices currently in use in the electronics industry such as the **magnetic heads** used on PC floppy disk drives. The magnetic read/write heads are made by the millions and presumably meet very tight magnetic field specifications. The approach was to examine the specifications of the heads and, if deemed suitable for calibrating eddy current probes, some would be purchased and used in feasibility experiments.

As explained in Appendix A, phase calibration also is an important part of the RFC calibration process. Since new gain calibration artifacts wouldn’t necessarily require the metallic, engine-alloy blocks necessary for phase calibration, UDRI proposed to create preliminary designs for phase calibration blocks that would allow phase calibration to be accomplished in the same manner as was currently done on RFC systems.

The overall research and development approach was broken into three phases as listed below. At the end of each phase a program review would take place and a decision whether or not to continue would be made. The phases were:

Phase I - Establishing the validity of the new gain calibration concept and determining the necessary modifications of the phase calibration method,

- Phase II - Designing the new phase and gain calibration methodologies for operation in the RFC systems, and verification that the methodologies produce equivalent or better POD results,
- Phase III - Demonstration of the new phase and gain calibration methodologies on RFC systems at one of the ALCs.

Once the research and development approach was created, a list of goals or objectives was also created to help determine if the solutions were worthwhile. The objectives and brief explanations are included in Appendix B.

5.0 RESEARCH AND DEVELOPMENT RESULTS

5.1 Eddy Current Data Acquisition System

It was decided before the contract started that UDRI would need an eddy current system that could scan RFC-type probes across calibration blocks and produce responses that were similar to the RFC systems. While the specifications were being developed to procure an eddy current data acquisition system UDRI learned that the Air Force was considering selecting the UniWest 450R eddy current instrument as the successor for the Staveley/Nortec NDT-25L instrument in use at that time. UDRI's specifications were modified to include the UniWest instrument. The complete specifications that UDRI developed before procuring an eddy current data acquisition system are included in Appendix C.

A few of the important requirements of the data acquisition system should be mentioned. Of highest importance was the requirement that the sensitivity and signal-to-noise ratio should be as equal to the RFC eddy current inspection systems as possible. Second, the speed of the motorized axes, especially the axis that moved during data acquisition, had to be at least 1-2 inches per second. This would allow the data acquisition process to use the same filter settings as the RFC systems. Third, the system had to use the same probes as RFC systems. Finally, the system had to have good stability in the probe lift-off direction to minimize lift-off noise.

The eddy current system procured from Structural Diagnostics Incorporated had motorized X,Y, and Z axes and a motorized turntable (see Figure 1). It also integrated a Robin bolt hole scanner that was modified to accept RFC style probes, including both surface and RECHII probes. The frame containing the motorized axes was modified so that it could be "leveled" to make the X-Y plane parallel to the base plane supporting the frame and turntable. The base plane was created from a 900 x 600 mm (~ 36 x 24 inches) optics table that was flat to within 0.100 mm (0.004 inches) over its entire area. The alignment of the two planes help reduce probe lift-off when acquiring data.

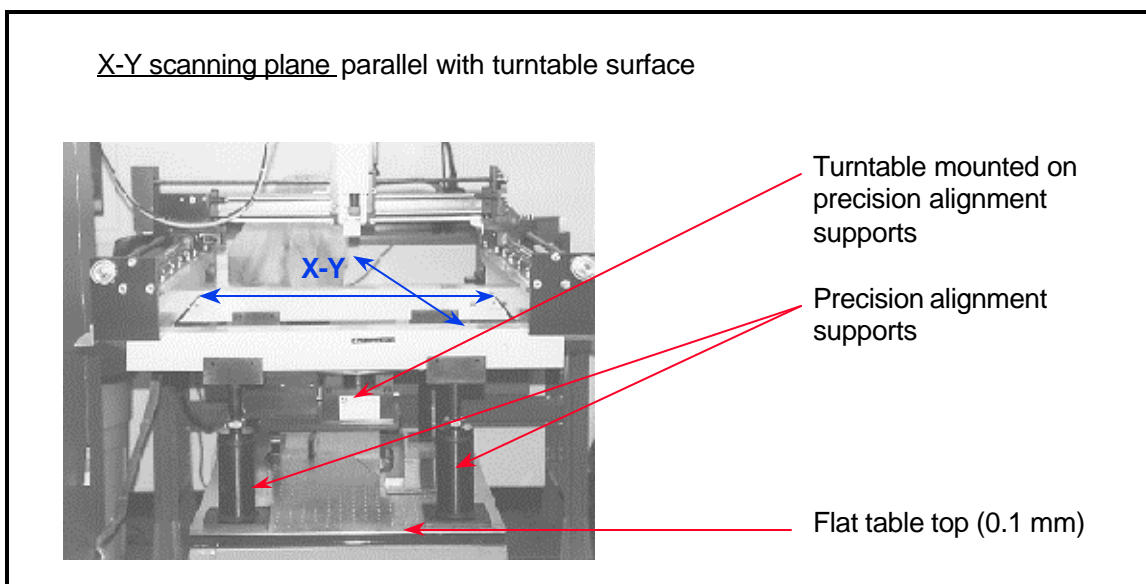

Figure 1 - Mechanical frame, motorized axes, and alignment fixtures of the eddy current data acquisition system used to develop the new calibration blocks.

Custom software was written to process the data acquired to detect amplitude peaks in data sets containing many passes over calibration artifacts. Also, a Zip drive was added to the system to archive all of the data acquired.

To establish a sensitivity baseline a calibration block containing EDM notches was machined from a piece of Waspaloy obtained from a scrap engine disk. The block was machined using RFC calibration block drawings and specifications. Three EDM notches were machined into the block: 1 x 0.5, 0.5 x 0.25, and 0.25 x 0.13 mm (0.04 x 0.02, 0.02 x 0.01, and 0.01 x 0.005 inches). All of the notches were approximately 0.15 mm (0.006 inches) wide. A comparison was made between the eddy current responses from the notches in the UDRI Waspaloy block and a RFC Master Waspaloy block. Figure 2 shows the eddy current responses. It is seen that the amplitude of the eddy current response from the UDRI 0.25 x 0.13 mm (0.01 x 0.005 inches) notch was very close to the amplitude from the 0.25 x 0.12 mm notch in the RFC Master Waspaloy block.

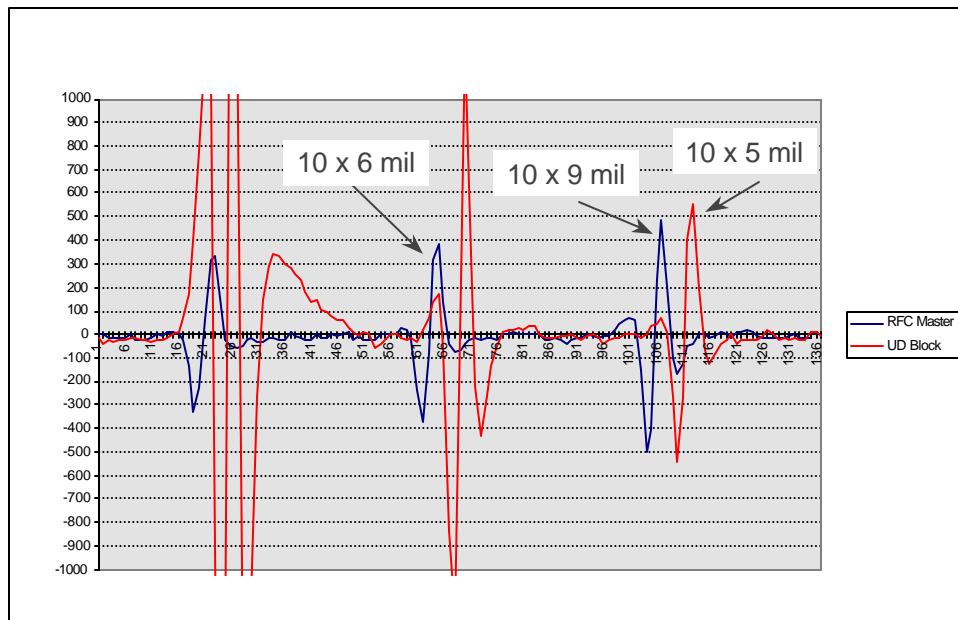

Figure 2 - Comparison of the eddy current responses from EDM notches in the UDRI Waspaloy calibration block and the RFC Master Waspaloy calibration block.

5.2 MACOR[®] Machinable Ceramic Substrate Material

Many of the artifact approaches considered early in the program required a nonconducting substrate to support the artifacts. Beside being electrically nonconductive, the material had to be reasonably machinable, chemically and environmentally stable, and rugged enough to survive depot environment handling. A search of suitable ceramic materials resulted in the identification of a machinable glass ceramic from Corning called MACOR[®]. MACOR[®] is a white, odorless, porcelain-like (in

appearance) material composed of approximately 55% fluorophlogopite mica and 45% borosilicate glass¹. MACOR[®] turned out to be a very useful substrate material for all of the calibration artifacts used in the program and a full description of it is contained in Appendix D. Samples of some of the MACOR[®] rod and bar stock used during the program are shown in Figure 3.



Figure 3 - MACOR[®] stock used for substrate material for surface calibration blocks and RECHII inserts.

5.3 Electronic Artifact

One of the calibration artifact approaches was to evaluate the read/write heads used in personal computer hard drives. UDRI personnel consulted with manufacturers of several hard drives to obtain electrical, magnetic, physical, and performance specifications for typical coils used in the read/write heads. The plan was to see if the magnetic fields generated by the coils could be used as a signal source for calibrating eddy current probes. If the magnetic fields were repeatable and uniform then the coils in the eddy current probes could be passed through the magnetic field and the resulting response used for calibration.

The information UDRI gathered indicated that the magnetic fields generated by the type of coils used in read/write heads in hard drives were very noisy and not uniform nor very repeatable. In fact, it was learned that the signals generated by the coils require signal processing hardware and software to compensate for the variations. Upon learning about the characteristics of the magnetic fields produced by the read/write heads, UDRI decided to halt the investigation into electronic artifacts pending the initial results of other approaches. Because other approaches were successful, UDRI did not conduct any further research on this type of artifact during the program.

¹ “MACOR[®] Machinable Glass Ceramic”, Corning Technical Bulletin MACOR-B-94, Corning Incorporate Advanced materials, Corning, NY 14831, 607-974-7618

5.4 Photolithography Artifact

The initial idea of using photolithography techniques was prompted by examination of the metallic traces found on printed circuit boards. Under microscopic examination these traces were found to be very uniform in width. UDRI proposed using the photolithography technology to either deposit “metallic notches” on nonconducting substrates, or create a metallic conducting plane with “notches” of missing metal.

Photolithography works by plating a suitable substrate with a thin metallic film (typically a few microns thick) and then removing the film in selected areas. Removal is accomplished by coating the metallic film with a photoresist layer that “cures” when exposed to light. The curing is accomplished by projecting light through a photographic positive of the final metal film pattern onto the photoresist layer. After curing the photoresist layer the “uncured” regions are chemically removed exposing the underlying metallic layer. Then, the metallic layer is also removed leaving a metallic pattern equivalent to the pattern in the photographic positive. Through photographic enlargement and reduction techniques, very precise patterns can be created in the photographic positive and the final metallic patterns on the substrate. Line width accuracies and uniformity of less than one micron are possible.

UDRI first tested the photolithography approach of using thin traces of metallic conductors to create eddy current signals. Metallic traces similar in width to those found on printed circuit boards were scanned using the eddy current data acquisition system. It was found that the traces produced very small responses in RFC probes at gains similar to those used during RFC inspections. This approach was halted and the evaluation of the second photolithography concept was begun.

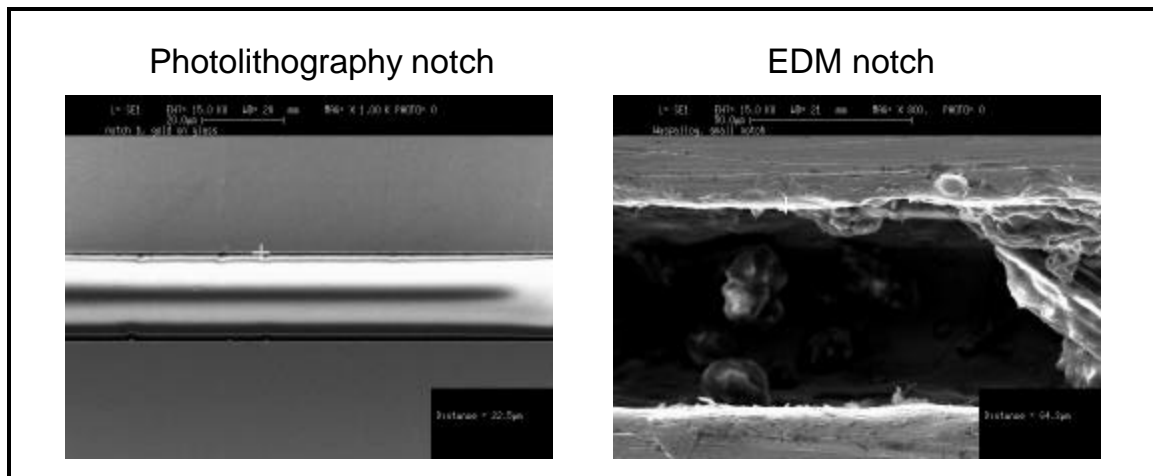

Figure 4 - Comparison of the edges of a photolithography “notch” (left photograph) and an EDM notch (right photograph).

To test the idea of making calibration artifacts by creating “notches” in a metallic layer, several photolithography specimens were designed having 1-2 micron thick chrome or gold coatings on glass substrates. The “notches” were created on a photographic positive that was a factor of 100 times larger

than the actual notches. The magnification provided dimensional accuracy and resolution on the order of one micron in the actual notches (see Figure 4 for an illustrative comparison of the dimensional resolution achieved with photolithography versus electro-discharge machining.)

The first specimens had a variety of notch lengths (0.3 to 12 mm, (0.012 to 0.48 inches)) and widths (0.01 to 0.2 mm, (0.0004 to 0.008 inches)) for studying the interaction of the eddy currents with the notches. Initially a chrome coating was deposited on a glass substrate with the “notches” actually being a lack of coating. The initial results showed that photolithography films with notches produced large eddy current responses, on the order of ten times the response of a similar sized EDM notch. This success prompted additional work on creating photolithography specimens using MACOR[®] as the substrate.

Several technical problems had to be overcome to successfully create photolithography notches in metallic films on a MACOR[®] substrate including adherence of the film to the MACOR[®], film thickness uniformity, and depositing the film on a large surface area (the area of a RFC calibration block.) After considerable searching and consultation with several vendors in the film sputtering field, a company called “Specialty Thinfilm Services, Inc.” was selected². Specialty Thinfilm Services recommended the deposition of a 0.3 - 0.6 μm thick base layer of Nichrome (80% Ni and 20% Cr) followed by a top layer of gold, 1 μm thick. The notches were selected to be 5 x 0.2 mm (0.2 x 0.008 inches).

UDRI supplied MACOR[®] blocks machined to the shape and dimension of a standard RFC calibration block (drawing in Appendix F) to Specialty Thinfilm Services (STS) for gold film deposition. STS had considerable difficulty getting the Nichrome and gold films to stick to the MACOR[®] but eventually was able to determine the proper surface treatments needed to get the metal films to adhere well. Figure 5 shows photographs of gold/Nichrome coated glass and MACOR[®] substrates; coverage of the entire

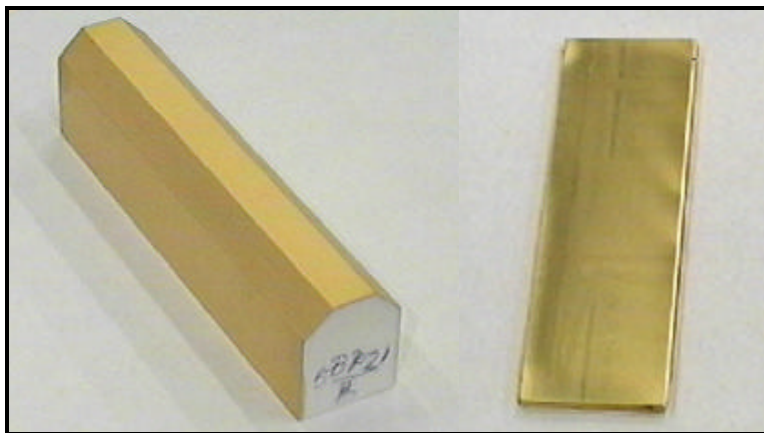

Figure 5 - Gold coated MACOR[®] substrate (left) and glass plate (right). Variations in the gold film thickness are evident on the glass plate.

² Address: 9B Lincoln Street, Medway, MA 020253, (508) 533-3350.

surface area of the substrates is evident. However, the photograph of the coated glass substrate gives a hint of one of the problems that proved fatal to using the photolithography technique. Variations in the thickness of the coating can be seen as differing shades of gold in the photograph.

Continued evaluation of the eddy current response from the photolithography notches in gold showed that the responses taken along a given notch were very uniform. Figure 6 shows typical eddy current responses at different positions along two different notches. In this figure it should be noted that a different eddy current probe was used for each notch. The variation seen from location to location along a given notch is very small, less than 5% scatter from an average value. However, comparison of signals from different notches produced much greater variations, as can be seen in Figure 6.

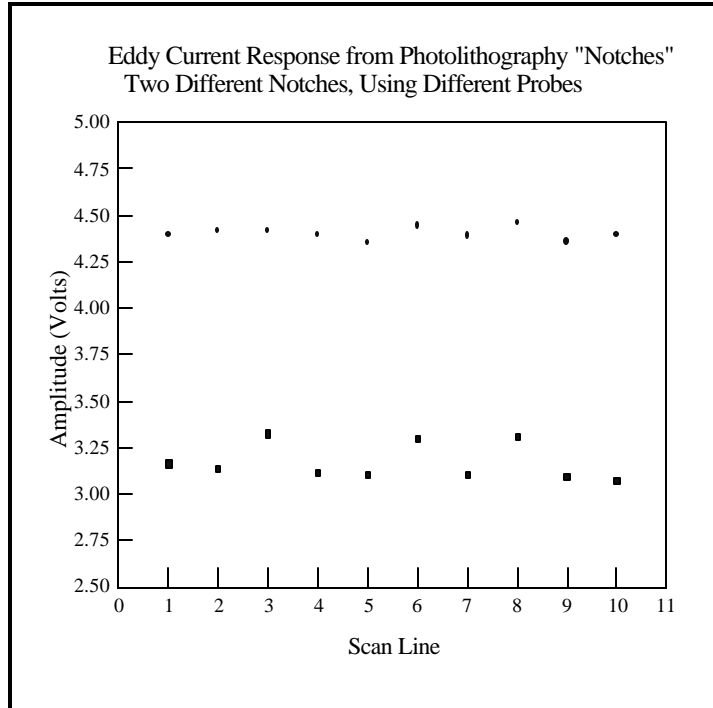

Figure 6 - The eddy current response along a photolithographic “notch” was very uniform.

Figure 7 contains results from scanning an eddy current probe across multiple locations on five photolithography notches on one MACOR® block. One notch from each face of the five-sided MACOR® block was scanned. The sharp rise and fall of the eddy current response at each side of the graph shows where the probe was just starting or ending being over the notches. The variation between responses is primarily due to differences in the thickness of the films on each face. This block was coated with Nichrome/gold films with the goal of producing a uniformly thick coating. However, very slight differences in the film thickness produced much different eddy current responses. Also, on at least

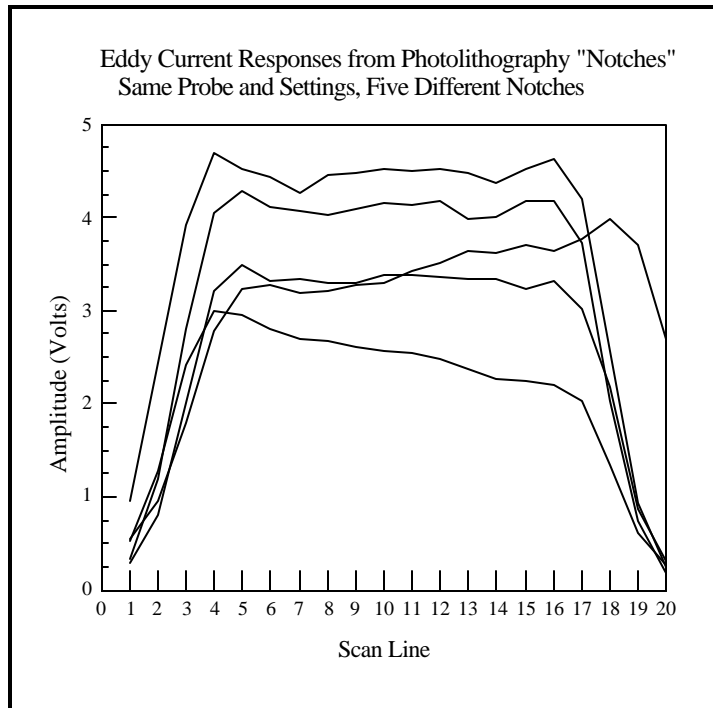

Figure 7 - Eddy current responses from five different photolithography notches on a MACOR® substrate.

two of the faces the eddy current responses changed as the probe was scanned across different locations on a single notch.

Discussions with the film coating vendor revealed that the film thickness variations causing the different eddy current responses were likely on the order of $0.005\ \mu\text{m}$ and would be difficult to control over the large surface area of the calibration block. This problem, along with several others to be mentioned, eventually resulted in the decision to stop pursuing photolithography as a calibration artifact technique.

UDRI also developed a photolithography approach for RECHII calibration inserts. RECHII inserts were constructed by machining a block of MACOR[®] to create a cylinder with a selected inside diameter. The cylindrical piece was cut in half and part of the face of one cut surface was coated with Nichrome/gold (see Figure 8.) Then the two halves were placed back together and mechanically secured. The eddy current responses from a 12.7 mm (0.500 inch) diameter insert were encouraging. The RECHII eddy current data were acquired using a 12.45 mm (0.49 inches) diameter, differential RECHII probe spinning at 120 r.p.m. The maximum peak-to-peak signal amplitude per revolution of the probe was recorded as the probe was indexed down the axis of the hole. Figure 9 shows the eddy current response for the insert. The variation of the eddy current response along the plated artifact (from location #5 to #15) was approximately $\pm 10\%$ from the average, but was greater than desired.

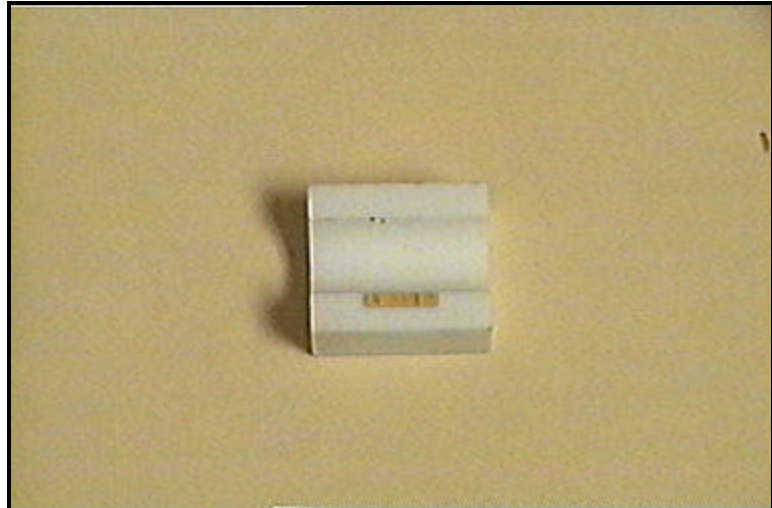

Figure 8 - The photolithography process was evaluated for creating RECHII calibration artifacts.

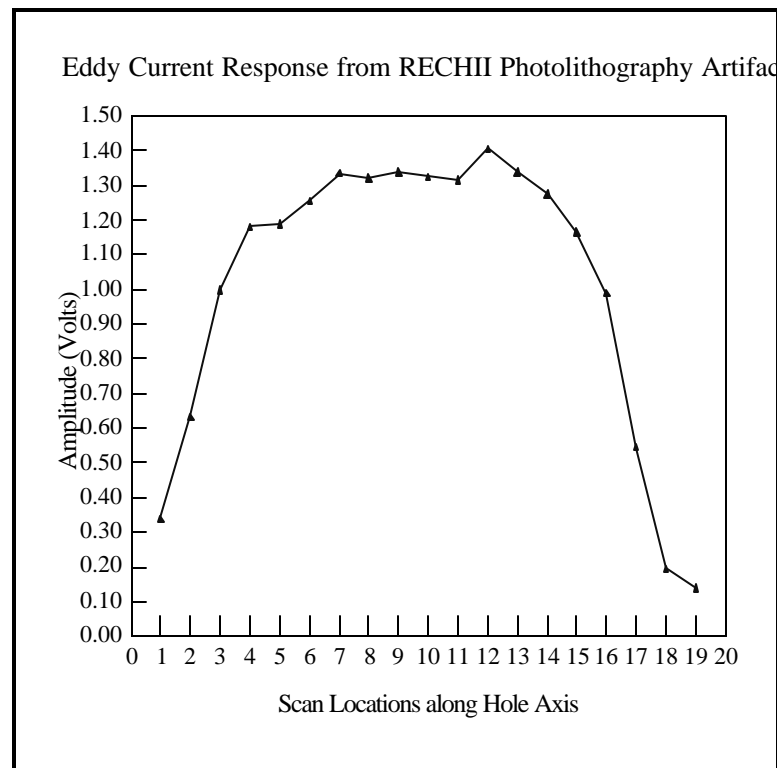

Figure 9 - The eddy current response along the axis of a photolithography artifact, RECHII calibration insert.

A brief review of two other problems encountered in the development of the photolithography artifact is worthwhile. During data acquisition on the photolithography specimens it quickly became apparent that some type of protective coating would be needed to keep the gold film from being scraped off the substrate as the eddy current probe was scanned across it. A promising solution was a coating called “diamond-like carbon”. From technical literature provided by Diamonex®, the producer of DLC, diamond-like carbon (DLC) is an amorphous form of carbon with properties closely resembling diamond (“a random covalent network of graphitic-type structures interconnected by sp³ linkages.”)³ It is created by an ion-assisted chemical vapor deposition process and adheres to a wide range of materials. Some of the properties of the DLC are:

- 1) It has a hardness of 9+ (Mohs) which is comparable to TiC,
- 2) Its coefficient of friction is between 0.1 and 0.2 (approximately equal to Teflon),
- 3) It adheres well to chromium, nickel, glasses, ceramics, and some polymers,
- 4) Coating thickness can be made between 0.1 and 10 microns.
- 5) It is optically transparent and chemically inert (oxidizes at >350EC)
- 6) Electrically insulating (resistivity from 10⁶ to 10¹² ohm-cm)

Diamonex® successfully applied DLC to chrome-coated MACOR® and gold-coated MACOR® blocks. Quick assessments of the DLC coatings seemed to show that they adhered well and prevented the metal films from being scratched by routine handling. However, the decision to not pursue the photolithography technique was made before the effectiveness of the DLC as a protective coating could be completely examined.

One final note about the Nichrome/gold photolithography artifacts is worth mentioning. After several of the artifacts were created, UDRI was informed that the presence of “gold-coated” objects was generally not allowed in the Air Force ALCs. A quick calculation showed that the total value of the gold on an RFC-type calibration block would be less than \$5.00 (especially at the then current gold price of ~ \$290 per ounce), however, there was some concern expressed by ALC representatives at the review meetings that the glittering gold look would be undesirable.

Although the photolithography approach had many advantages it was decided at the end of Phase II that it was not the best choice as the artifact technique to be fully developed in Phase III. Consequently, by late Fall 1997, UDRI decided to focus its efforts on the other technique being examined, the wire-type artifacts.

³ Diamonex®, A Unit of Monsanto, 7150 Windsor Drive, Allentown, PA 18106, (610) 366-2106

5.5 Wire-type Artifacts

The wire-type artifact concept was very simple: embed a metal wire flush with the surface of an electrically nonconductive substrate and, hopefully, a reproducible eddy current response would be created wherever a probe was scanned across the wire. The initial steps in demonstrating this concept were to select a wire diameter sufficient to cause an eddy current response, evaluate the effect of different wire compositions, select a substrate material, choose some type of binder to hold the wire, and create a process for repeatably and uniformly positioning the wire flush with the surface of the binder. Some of the details of the technical research and development that provided solutions to requirements are described in this section.

Initially, one inch square acrylic bar stock was selected as the substrate. It was chosen because it was readily available, inexpensive, easily machined, and had sufficient structural integrity to support the wire setting process. More than 50 acrylic calibration blocks were constructed in the first half of the program. Later in the program MACOR[®] was used instead of the acrylic.

A white, brushable ceramic adhesive (model #11770) made by Devcon⁴ was selected as the binder to hold the wire in place on the substrate. It was chosen for its fast curing time, chemical resistance, high dielectric strength, low toxicity, good adherence to many materials, and low viscosity. Typical brush coat thickness is reported by Devcon to be 0.5 mm (0.02 inches). Working time is approximately 20 minutes after mixing the resin and hardener. This adhesive proved to be a very good choice and was used for all of the wire artifacts throughout the program.

The concept for the process to embed the wire in the adhesive was straightforward: use the substrate to press the wire against a very flat surface. The flat surface was selected to be a granite surface block. The details of the process, such as how hard to press the wire, how to accommodate the excess adhesive, how to hold the wire so that it didn't bend, and

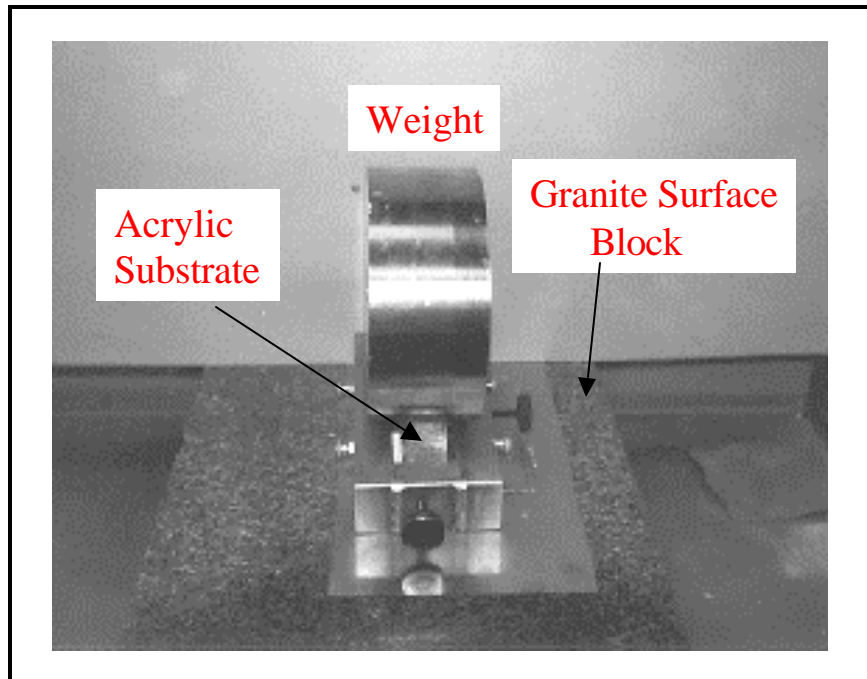

Figure 10 - The initial process for creating wire-type calibration artifacts.

⁴ Devcon, An Illinois Tool Works Company, 30 Endicott Street, Danvers, MA 01923, (508) 777-1100

others were determined through many experiments during all three phases of the program. However, in its simplest implementation, the wire artifact process is summarized in Figure 10.

Several different wire compositions were considered. Important characteristics were availability, tensile strength, electrical conductivity, and that the wire not be ferromagnetic.

Figure 11 shows the eddy current responses from several wires of the same diameter but different compositions. The figure clearly shows that the copper wires produced much stronger signals than either

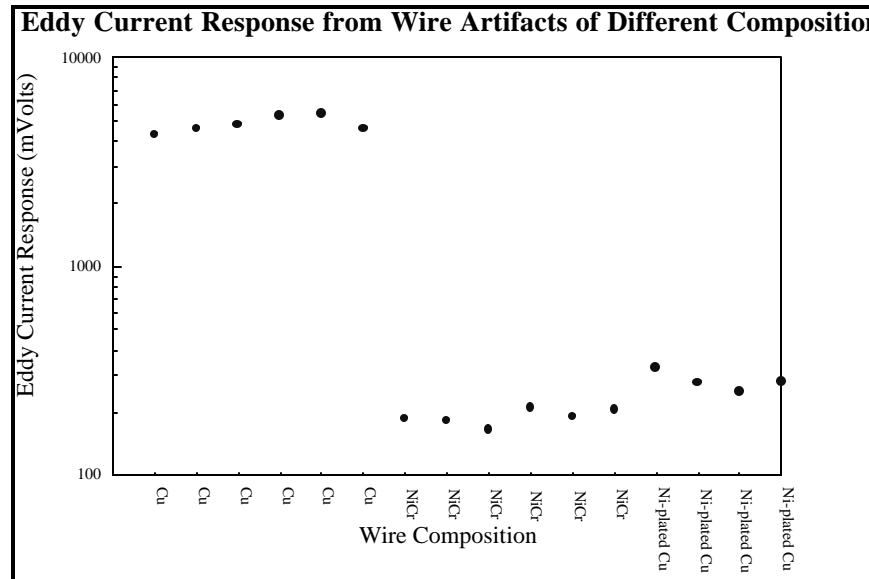

Figure 11 - Different compositions of wire greatly affect the eddy current response.

the Nichrome (NiCr) or the nickel-plated copper wires. Eventually, 80-20 Nichrome wire (80% nickel, 20% chromium) was selected as the wire to use because it produced eddy current signal amplitudes that were comparable to the signal amplitudes the RFC systems produced from EDM notches⁵.

Different gage wires were used to make artifact blocks to test the dependence of the eddy current response on wire diameter. Figure 12 shows eddy current responses obtained from artifacts constructed from 32, 34, and 36 gage (0.008, 0.0063, and 0.005 inch diameter) Nichrome wire. Nichrome wire with 32 gage (~ 0.2 mm or 0.008 inches) diameter was selected for use in subsequent wire artifact blocks because it produced eddy current response amplitudes comparable to the amplitudes produced by EDM notches on

⁵ It should be noted that the composition of Nichrome wire is not always the same. For example, Nichrome wire purchased during this program had compositions of: a) 59.2% Ni, 16.0% Cr, 23.5% Fe, and 1.3% Si, b) 61% Ni, 15% Cr, and 24% Fe., c) 80%Ni, 20%Cr. Also, it should be noted that the compositions were occasionally listed incorrectly: the 59.2% Ni, 16.0% Cr, 23.5% Fe, and 1.3% Si composition was listed as 60% Ni, 26% Cr, and 14% Fe in one catalogue.

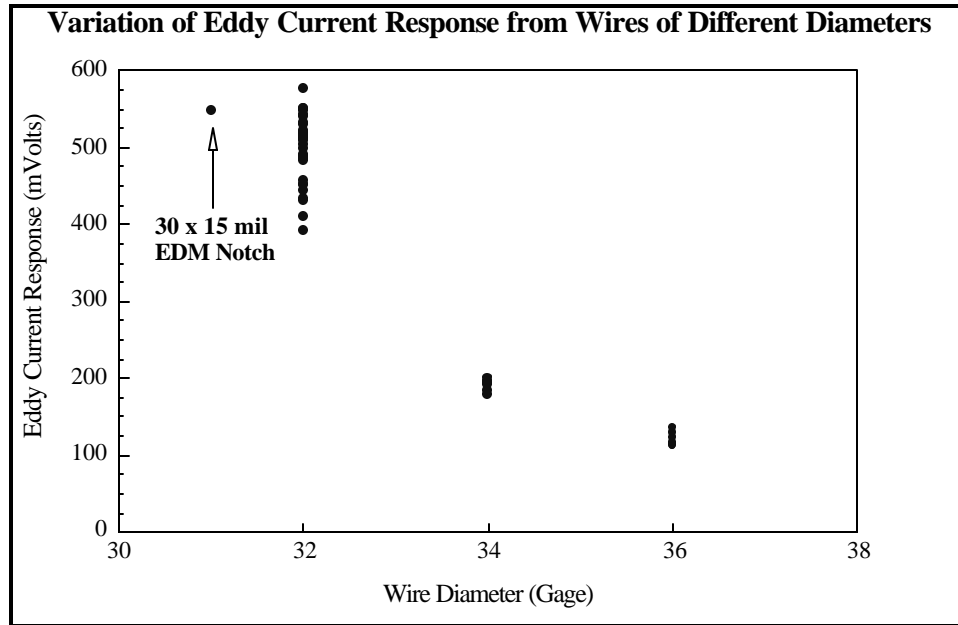

Figure 12 - The difference in gage of the wires clearly affects the eddy current response.

the RFC systems. The 32 gage wires also were stronger than the other gages which was important when the wires were tightly stretched across the substrates.

Correct placement of the wire during the artifact assembly process required several design iterations. Initially, when using the acrylic substrates, a steel support frame was used to stretch the wire tight and hold it in place while the binder cured (see Figure 13). The steel support frame was designed and machined so that the wires were held precisely parallel to the bottom of the frame and thus flat with respect to the granite block. The frame also held the wire and substrate so that they were perpendicular to each other. The steel frame worked very well for ensuring correct placement of the wire on the substrates even when the five-sided MACOR® substrate was used.

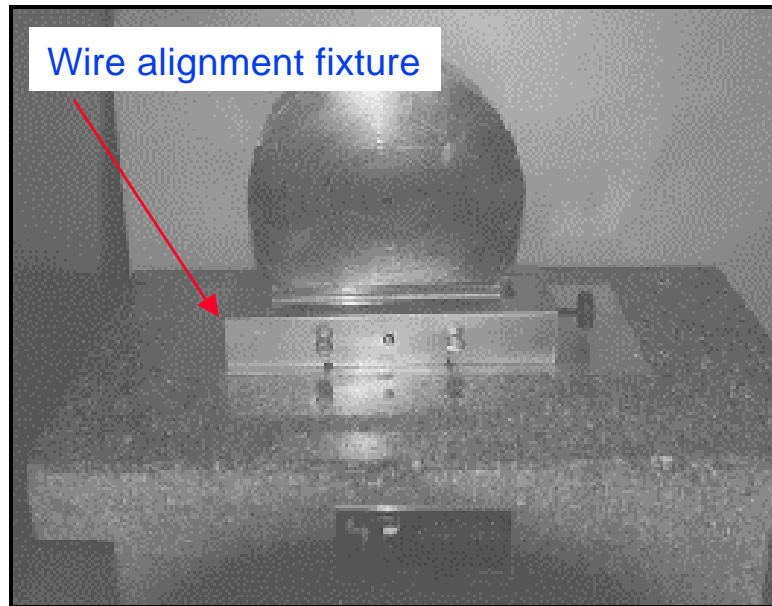

Figure 13 - A precision machined, steel fixture was used to produce correct wire alignment on the substrates.

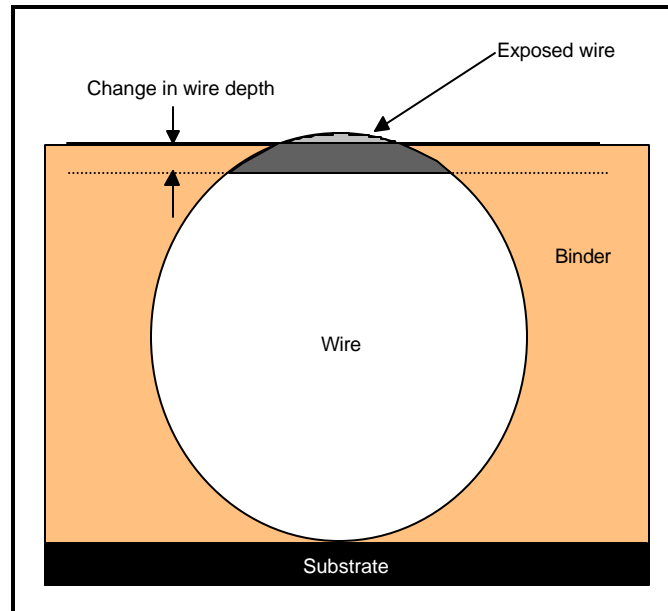

Figure 14 - This schematic shows the placement of the wire relative to the substrate and surface of the binder. The depth of the wire was easily verified by observation of the width of exposed wire.

For every wire artifact that was made, the amount of wire exposed above the binder was examined using optical microscopy. Judging the correct amount of exposed wire was quickly learned: wires positioned correctly were seen as a bright, reflective, narrow band running the length of the wire, whereas wires positioned incorrectly were either not seen or were visible as very wide bands. Figure 14 illustrates the geometry of the wire placement within the binder and shows how the amount of exposed wire varies strongly with the thickness of the binder layer. The proper amount of exposed wire was not quantitatively measured, but easily could be for tighter quality control in a production process.

More than 200 acrylic substrate wire artifacts were made during Phases I and II of the project. The data acquired using these blocks verified the feasibility of using wire artifacts for RFC eddy current system calibration. During the latter months of Phase II and throughout Phase III efforts were made to design the blocks so that they would be useful in the ALC environment; specifically, the ruggedness, environmental tolerance, and adaptability to incorporating phase calibration were studied.

The first step in making the blocks ALC-ready was to use the five-sided MACOR® substrate. Compared to the acrylic substrate, MACOR® substrate held tolerances better during machining, was more resistant to environmental factors such as heat and humidity, and was more resistant to oil, solvents, and other chemicals. Details of the MACOR® substrate can be found in an earlier section in this report. At first the wires were placed on only one face of the MACOR® block at a time. Since the curing time of the binder was approximately 24 hours it took at least five days to complete one block. The process of producing one face at a time also created problems due to the spread of the binder to the unfinished faces. Although tedious and time consuming several five-sided, wire artifact, MACOR® blocks were produced

(see Figure 15). Data acquired from the five-sided, wire artifact, blocks showed that the process was very repeatable and produced consistent eddy current signals along a given wire and from wire-to-wire. The data are presented and discussed in a later section of this report.

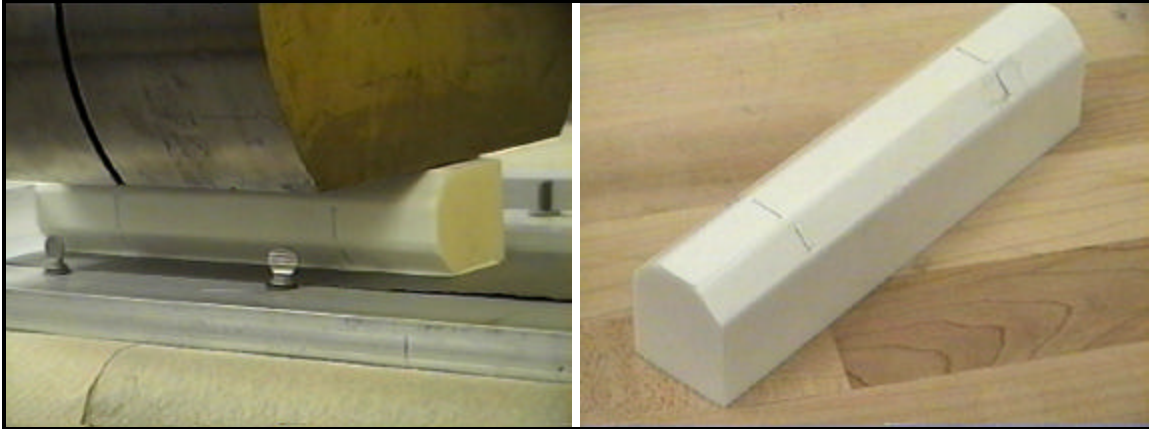

Figure 15 - The process of creating five-sided wire-type artifacts is shown in the photograph on the left. The resultant calibration block is shown in the right photograph.

The success of the five-sided, wire artifact, MACOR® blocks prompted the research to make the manufacturing process faster and less tedious. A design for a five-sided mold was made and the components machined out of steel (Figure 16). The initial trials used weights and/or springs to compress the substrate into a fixed mold, but problems with nonuniform pressure on each side and allowance for the excess binder turned the design towards a mold with five moveable sides. Finally, a mold with each side actuated by pneumatic pressure was designed and built. The pneumatic mold produced blocks quickly (a few hours) and the eddy current data from the wires on each side were uniform. The pneumatic mold is discussed in a later section in this report.

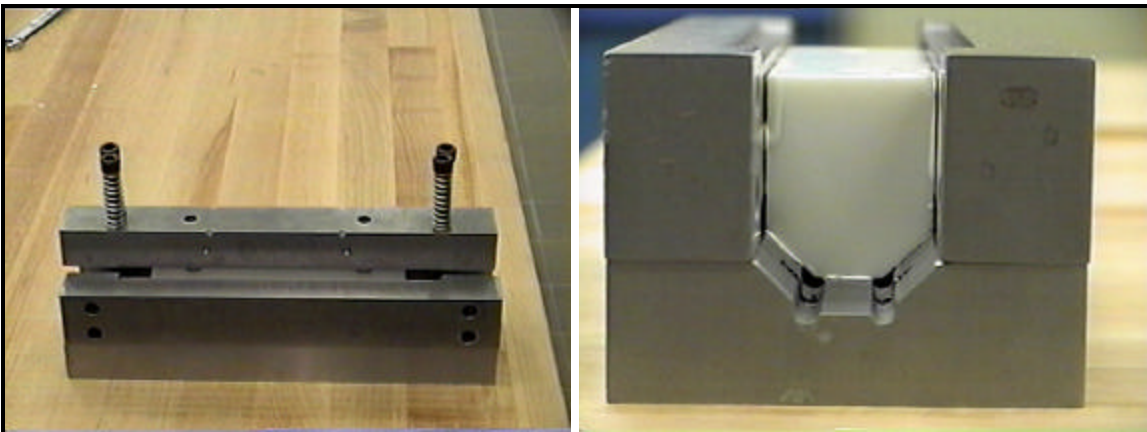

Figure 16 - A mold was created to allow simultaneous construction of all five sides of the wire-artifact blocks.

The project statement of work required the development of both surface and RECHII calibration blocks. The research work on developing photolithography RECHII “inserts” was described earlier in this report and similar research was done to develop wire artifact RECHII inserts. A key design decision was made during the program that allowed the RECHII calibration inserts to use the same artifact concepts as was done for the surface calibration blocks. RECHII calibration inserts provide several functions for the RFC eddy current systems: dimensioning location, bolt hole centering calibration, phase calibration for bolt hole inspections, centering of the probe before gain calibration, and gain calibration. All of the functions except gain calibration require a surface of metal to be present for the eddy current probe. An important milestone was reached when it was decided to incorporate the necessary features of both the current RECHII inserts and the new artifact inserts. Specifically, the top portion of the current RECHII inserts were mated to the MACOR® cylinder containing the new calibration artifact (see Figure 17). This “hybrid” RECHII insert provided for dimensioning location, bolt hole centering calibration, phase calibration for bolt hole inspections, and centering of the probe before gain calibration using the engine alloy top portion, and improved gain calibration using the wire artifact in the MACOR® substrate in the lower portion.

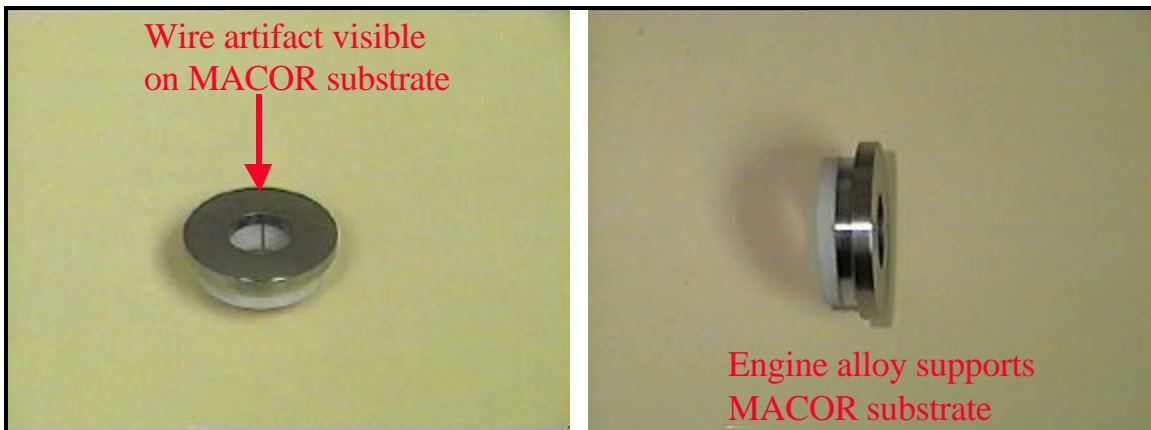

Figure 17 - The hybrid, wire-type RECHII calibration inserts are shown.

The primary technical task that needed a solution was how to position the wire artifact on the inside of the MACOR® cylinder so that it was parallel and equidistant (along the wire’s length) to the axis of the cylinder. Any deviation of any portion of the wire from the desired radial position would cause a measurable change in the eddy current response. A related concern was how to make sure the MACOR® cylinder was concentric with hole in the engine alloy because the eddy current bolt hole probe centered over the RECHII insert using the hole in the engine alloy.

The solution to the wire location problem was a unique assembly fixture design illustrated in Figure 18. A metal cylinder was substantially but not completely divided into two halves by a slot milled through the cylinder wall. A second slot was cut along the length of the metal cylinder so that the cylinder could be expanded to a slightly larger diameter. Two tapered pins were made to fit part way into each end of

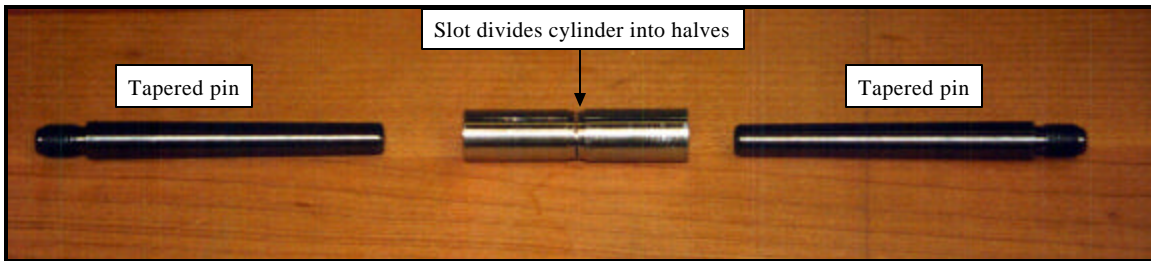

Figure 18 - The gage assembly used to create the RECHII inserts is shown.

the cylinder. Fabrication of the RECHII insert was accomplished by placing the engine alloy ring over one end of the cylinder and the MACOR® substrate ring over the other end (see Figure 19). The MACOR® ring was just slightly larger than the alignment cylinder and contained the wire artifact inserted into uncured binder. The engine alloy ring and MACOR® ring were pushed together and cemented using a standard high strength adhesive. The tapered pins were inserted into each end of the metal cylinder so that the cylinder inside the MACOR® ring expanded, pressing the wire artifact against the MACOR® . After the

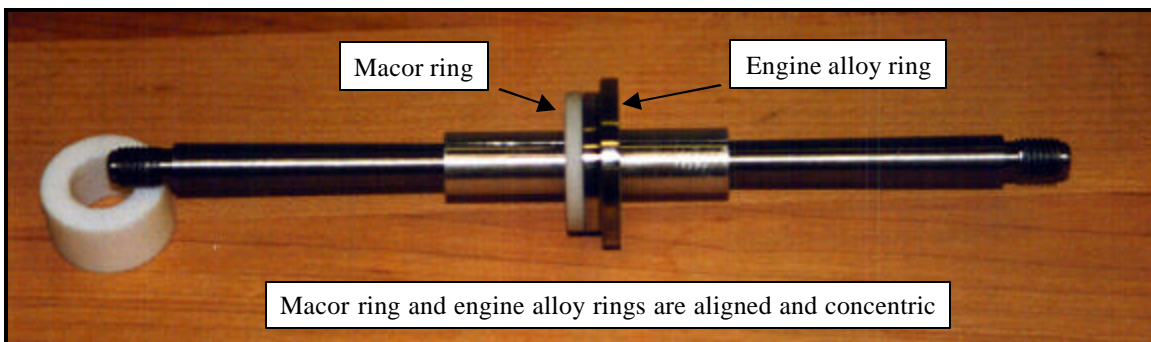

Figure 19 - In this figure the RECHII alignment gage is shown with a RECHII insert being assembled.

adhesive and binder cured, the tapered pins and metal cylinder were removed from the RECHII insert.

All of the design considerations necessary for demonstrating the feasibility of the new calibration concept were created and tested during Phases I and II of the project. Data acquired on the UDRI test system, Veridian’s RFC systems, and RFC systems at Oklahoma City ALC during Phases II and III demonstrated that the new calibration concept worked and could be easily implemented into the RFC eddy current systems. The next section of this report presents the data acquired during Phases II and III for both the surface block and RECHII wire artifacts. The last section of this report contains information about how the new calibration artifacts were optimized so that insertion into RFC eddy current systems would have minimal impact on the system hardware, scan plans, and logistics of support at an ALC.

6.0 DATA: EDDY CURRENT RESPONSE TO WIRE ARTIFACTS

The absolute amplitude of the eddy current response to the wire artifact was selected to be close to that produced by EDM notches by choosing 32 gage (0.2 mm diameter) Nichrome wire. However, unless the signal-to-noise ratio of the artifact response compared to other noise acquired during calibration process was equal to or less than that of EDM notches, the artifact concept might not produce better overall results. Fortunately, the approach of using an electrical conductor (the wire) bound in a nonconducting medium (binder and substrate) produced very good signal-to-noise ratios. In essence, the epoxy binder and MACOR® substrate produced no eddy current response; this is unlike EDM notch blocks where considerable “material noise” is produced. An excellent example of the superior signal-to-noise ratio of the wire artifacts is shown in Figure 20. Also, in the case of surface calibration blocks, because the surface of the epoxy binder was produced through contact with a granite surface block, almost no probe vibration occurred while the probe was scanned across the block.

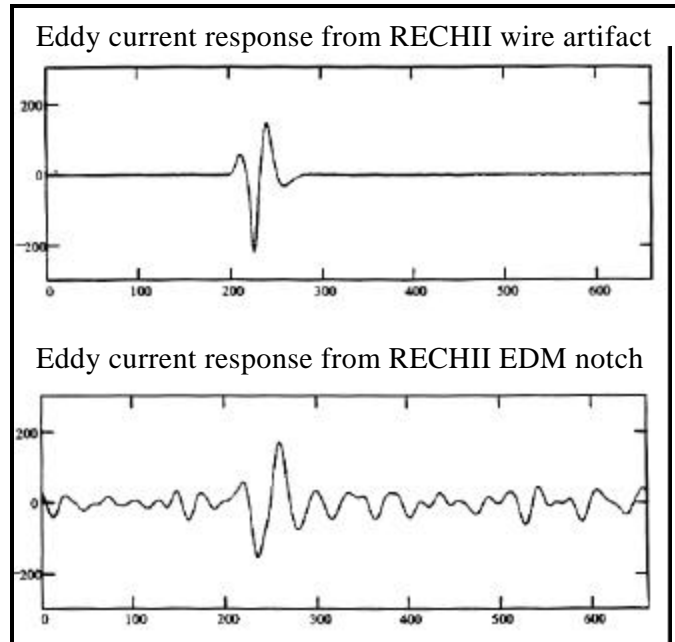

Figure 20 - The greatly superior signal-to-noise ratio of the wire-artifact calibration block compared to an EDM notch in titanium is illustrated.

The first goal in producing the artifacts was to have uniform eddy current response along the artifact itself. This was required to eliminate the searching for a maximum response necessary with EDM notches. Uniformity along an artifact was the primary “quality” factor used to judge artifacts in Phases I and II of the project. Early on in the project, success was established in obtaining eddy current response uniformity along a given artifact. The pie chart shown in Figure 21 breaks down the percent variation in the eddy current signal obtained from different locations across a given wire. More than 90 different wire artifacts were included in this summary. The percentage variation was defined as the difference between the largest and smallest signal obtained from a wire divided by the smallest signal. For example the scans across a given wire produced signals with the largest amplitude being 550 mV and the smallest

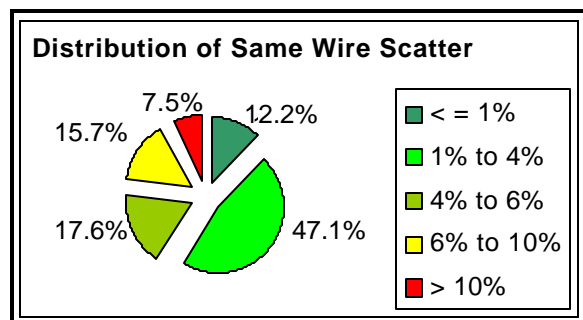

Figure 21 - The uniformity of eddy current response along any given wire is shown by a pie chart of the variations from an average response.

500 mV. The percentage difference for this wire would be 10% ($550 - 500 / 500$). As seen in Figure 21 over 90% of the wires produced eddy current signals having less than 10% variation. This is less than the variability (12% - 25%) that is obtained from scanning over EDM notches with 0.005 inches between scans.

The next objective was to compare the eddy current response from different wire artifacts. Thirty-nine NiCr wire artifacts on acrylic substrates were scanned with a 2 MHz RFC differential eddy current probe. The peak-to-peak amplitude of the eddy current response from the wire was recorded as the probe was scanned over the same location three times. The three peak-to-peak responses were averaged to produce an average response for that location. Then the probe was moved 5 mm to a different location on the wire and three more peak-to-peak responses were averaged. The probe was again moved 5 mm to a third location and the averaged response obtained. A “population” average was obtained by averaging all of the location averages (1.695 Volts with a standard deviation of 0.098 volts). The percentage difference of the location average, compared with the population average, is shown in Figure 22 for each location. So, the Percentage Error of -6% for “W01A1” means that the average of the three peak-to-peak

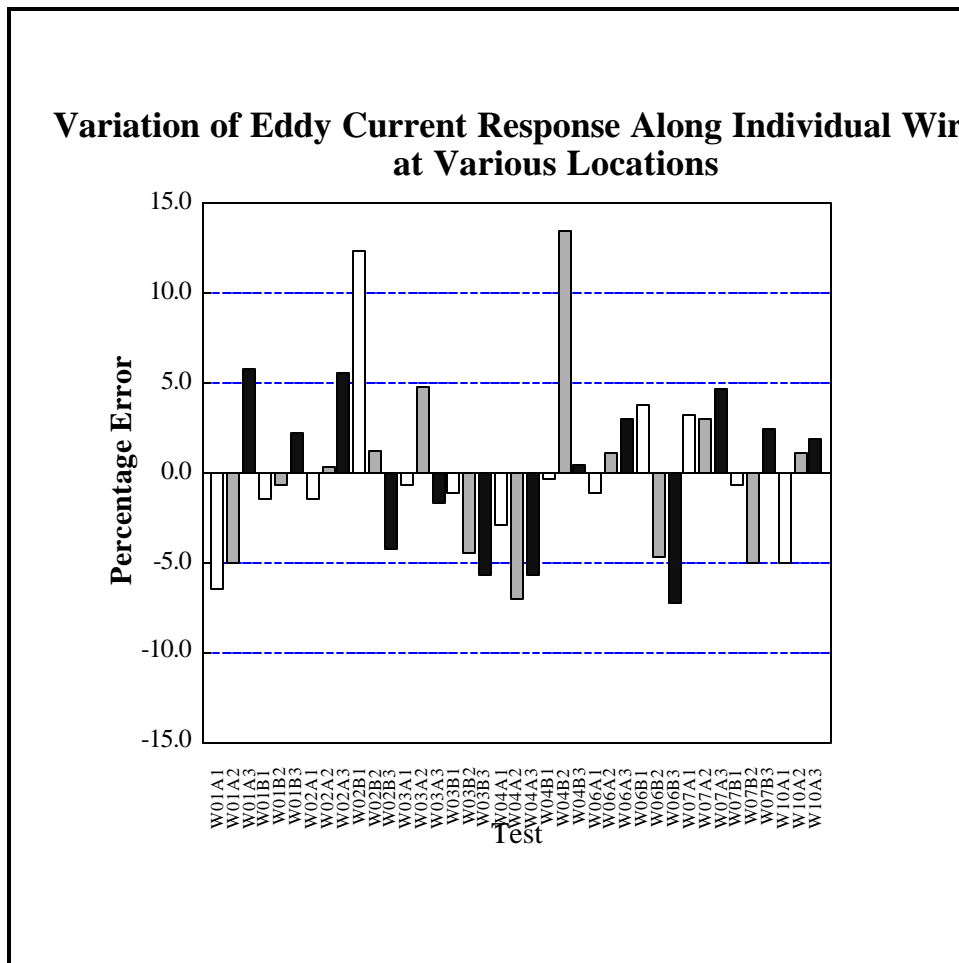

Figure 22 - The variation in eddy current response from wire-to-wire is shown for 33 different NiCr wires on acrylic substrates.

responses obtained on Wire Block 1, Wire A, Location 1 was 6% lower than the population average. All of the blocks used to acquire the data shown in Figure 22 were made using acrylic substrates and Nichrome wire. Except for two wires, the percentage variation was less than $\pm 7\%$ from wire to wire compared to the population (of 39 artifacts) average. This again demonstrated the feasibility of the wire artifact concept showing that the eddy current response was repeatable from wire-to-wire as well as along a given wire.

After establishing the uniformity of eddy current response along a given wire and from wire-to-wire on acrylic substrates, similar tests were conducted on five sided, MACOR® substrate blocks. The MACOR® substrate blocks contained two wires on each of the sides. Tests measuring the variation in the eddy current response from wire-to-wire were conducted using the UDRI eddy current system. Figure 23 shows the variation in eddy current response along each of the ten wires in Block 08, a MACOR® substrate, five-sided, RFC-style block. If an “average response” of 0.35 volts is assumed, a 1 dB variation results in bounds of 0.31 to 0.39 volts. Figure 23 shows that Block 08 was very close to being useful as

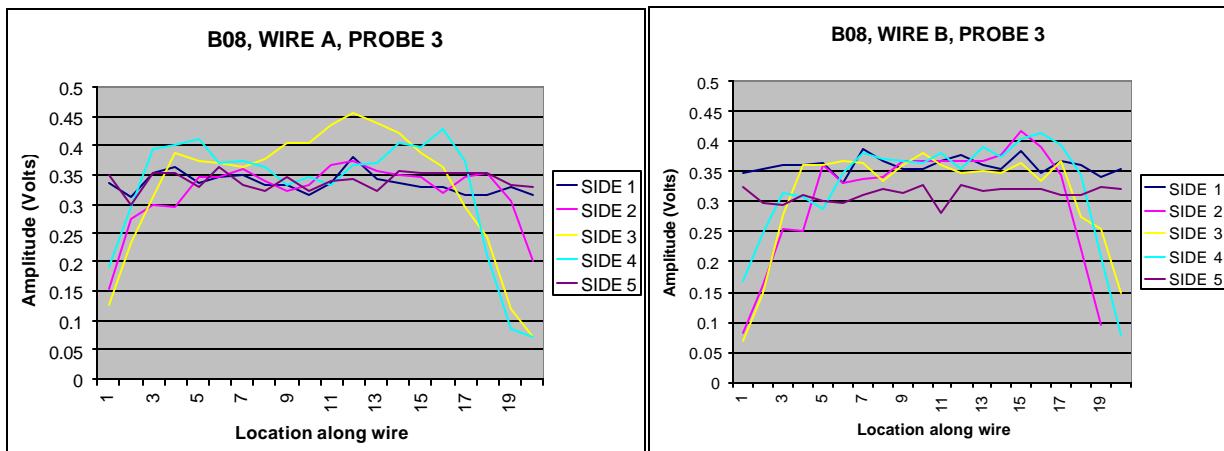

Figure 23 - The uniformity of the eddy current response along any given wire and from wire-to-wire is shown for a five-sided, MACOR® substrate, RFC-style calibration block.

an RFC-style calibration block if the wire artifacts at the “B” end of the block were used.

In March 1998 UDRI began evaluation of wire artifacts on five-sided, MACOR® substrates at Systems Research Laboratories using RFC inspection systems. UDRI had produced five MACOR® blocks by this time and selected three blocks that appeared to produce the most uniform eddy current responses across all wires. Figure 24 shows a photograph of the five blocks. Blocks 09, 11, and 12 were chosen for testing on the RFC system. Data were gathered using a 2 MHz surface probe and the standard RFC gain calibration algorithm. The standard gain calibration algorithm raster scans the probe along the calibration block indexing typically 0.1 - 0.2 mm (0.004 - 0.008 inches) between scans. The algorithm retains the maximum eddy current response acquired during the raster scanning process. Approximately



Figure 24 - Five wire-artifact, five-sided, RFC-style, MACOR® substrate calibrations blocks are shown.

20 indexes are performed resulting in the probe gathering eddy current responses across 2 - 4 mm (0.08 - 0.16 inches) of the block. When this algorithm was used with the wire-artifact MACOR® blocks, it sometimes resulted in the maximum eddy current response occurring away from the middle of the wire, towards the corner of the side of the block. This happened because on some of the sides the wires protruded from the epoxy binder near the corner. (Note: This problem was resolved on later blocks by slicing a channel through corners of the blocks so that the wires could conform more closely to the surface of the blocks - see Appendix E).

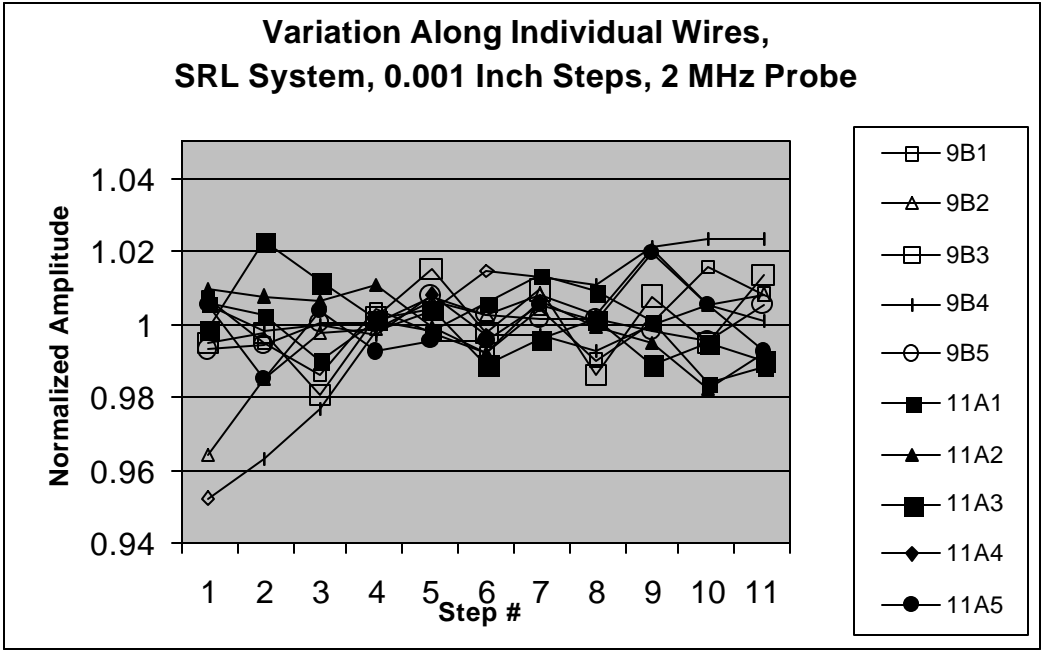

Figure 25 - The uniformity of eddy current response along any given wire on the five-sided, RFC-style, MACOR® substrate blocks is clearly validated.

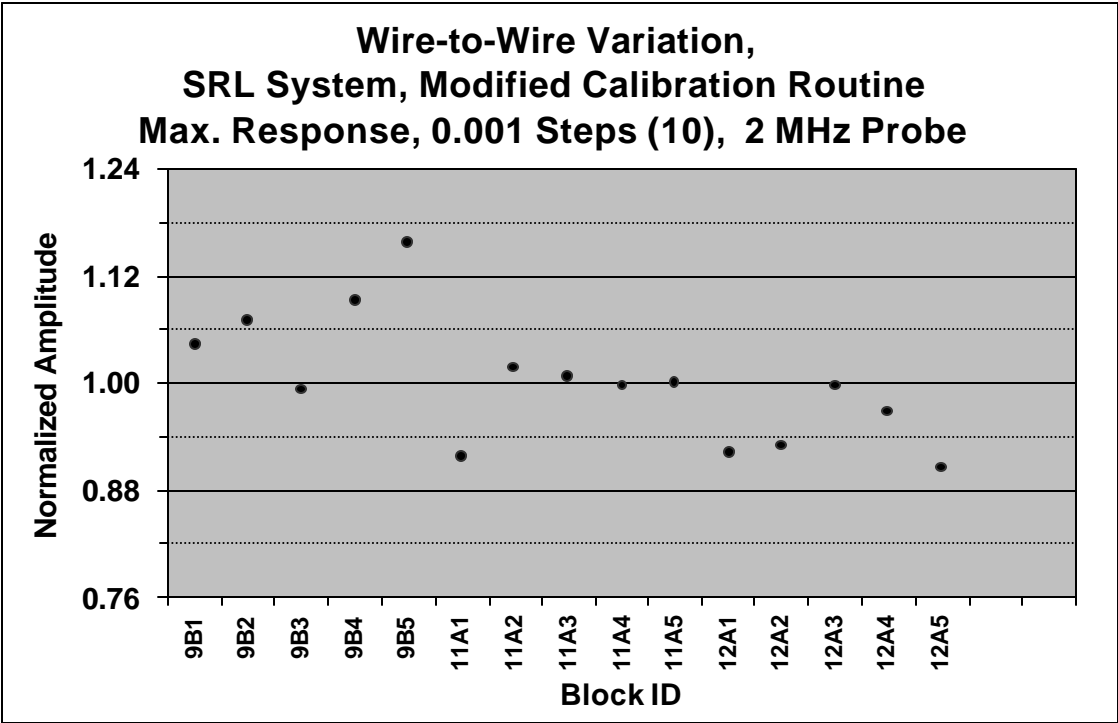

Figure 26 - The wire-to-wire variability for three RFC-style calibration blocks (15 wires) is shown to be less than 1 dB for all but one of the wires (2 MHz probe).

Veridian chose to use a modified gain calibration that limited the number of indexes thus keeping the probe near the center of the wire artifacts. Figure 25 shows the uniformity of the eddy current response along a given wire, for ten different wires, along a 0.25 mm (0.01 inches) region near the center of each wire.

Note: The nomenclature used for data sets obtained using the five-sided blocks was: “BBWS” where BB = block # , W = wire label (either “A” or “B”), and S = block side # (1,2,3,4, or 5). The location of each side is shown in above in Figure 24. For example, data set “9B3” was acquired from Block #9, Wire at end “B”, and Side #3 (the top of the block).

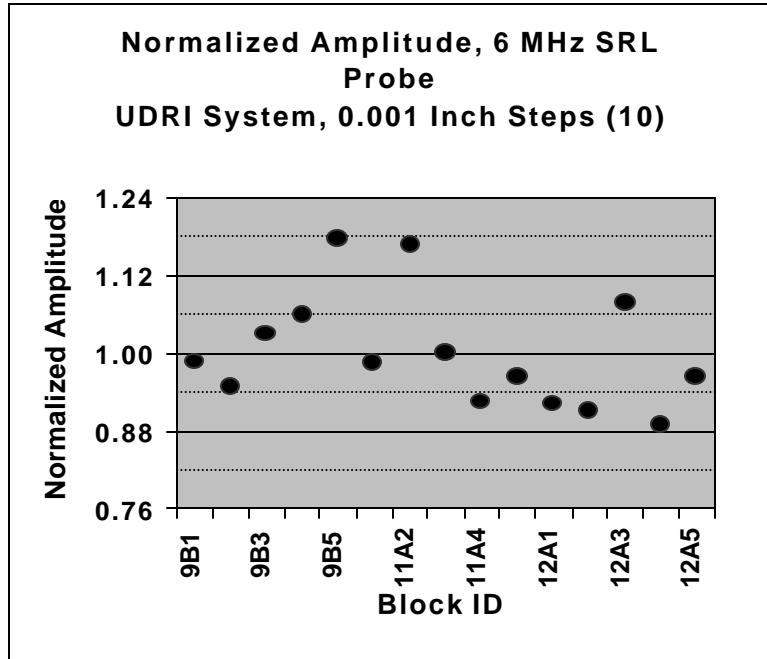

Figure 27 - The wire-to-wire variability for three RFC-style calibration blocks (15 wires) is shown to be less than 1 dB for all but two of the wires (6 MHz probe).

Using the modified gain calibration, five wire artifacts on three different blocks were tested. The resulting signal amplitudes are shown in Figure 26 having been normalized to an average response from all fifteen artifacts. Fourteen of the fifteen artifacts produced a signal response within 1 dB (12%) of the average. The wire artifact labeled “9B5” produced an eddy current response 1.3 dB (16%) larger than the average response. A probable reason was that more of the wire was on the surface due to some experimental polishing done on this block. Table 1 lists comments made for each wire during examination under an optical microscope. Similar eddy current responses were obtained using a 6 MHz probe on UDRI’s eddy current system as shown in Figure 27. Using a 6 MHz probe and constraining the indexing to ten steps 0.001 inches apart at the center of each side of the block, 13 of the 15 wires produced eddy current responses within 1 dB of the group average response. Again wire “9B5” produced a larger response, approximately 1.4 dB (18%) larger than the average response. Wire “11A2” produced a similarly larger response. Several more tests were run on both the UDRI and Veridian systems to verify the repeatability of the data and determine the relationship between the average wire artifact response and the average response from the EDM notch in the Waspaloy Master calibration block. The repeatability of the eddy current responses from the wire artifacts was very good as had been the case during testing of other wire artifacts on UDRI’s eddy current system. The average eddy current response from the EDM notch was approximately 25% larger than the average wire response.

UDRI constructed three 0.5 inch diameter RECHII calibration blocks using wire artifacts and titanium top sections. Limited access to RFC eddy current inspection systems prevented a thorough investigation of the eddy current responses on RFC systems. However, preliminary data, such as those shown in Figure 28, was encouraging and suggested that the wire artifact approach for RECHII calibration inserts could be as successful as the surface calibration blocks. Additional optimization of the manufacturing process needs to be done on the wire artifact RECHII inserts to assure uniformity of response along a given wire and for different wires.

Table I - Optical Evaluation of Wire Artifact and Block Surface Condition.

Optical Inspection of Wire Artifact Depth and Surface Condition	
B9 - Wire B	
Side #1.	Uniform only in the area of measurement (1/4" down)
#2.	Uniform only in center
#3.	Uniform but exposed wire surface is a little wide (from polishing)
#4.	Uniform but exposed wire surface is a little wide (from polishing)
#5.	Uniform but exposed wire surface is VERY wide (from polishing)
B11 - Wire A	
Side #1.	Uniform only in the area of measurement (1/4" down)
#2.	Fair Uniformity in center
#3.	Uniform
#4.	Uniform only in center
#5.	Uniform
B12 - Wire A	
Side #1.	Uniform but wire is a little deep
#2.	Uniform but wire is too deep
#3.	Uniform
#4.	Uniform but exposed wire is a little wide on surface
#5.	Uniform

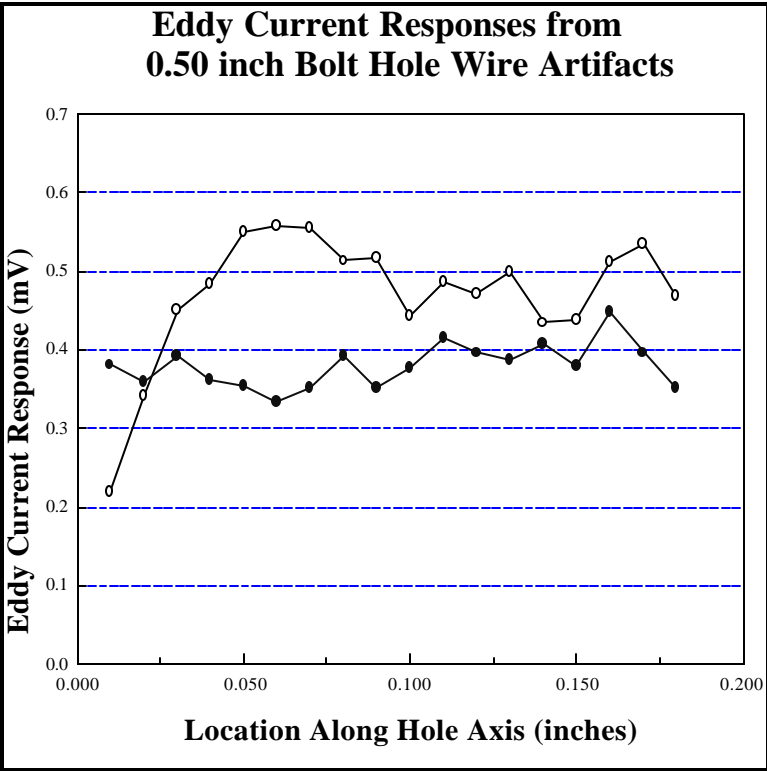

Figure 28 - The variation in the eddy current response along the wire artifact in two RECHII inserts is shown.

7.0 RESULTS: RELIABILITY TESTING AND ANALYSIS

The uniformity and repeatability of eddy current responses from the calibration blocks on both UDRI and Veridian inspection systems cleared the way for the final testing phase of the program. Tests using flat plate reliability specimens (see Figure 29) containing fatigue cracks, were designed to detect differences in the detection results when using the new calibration blocks versus a master EDM notch block. The tests were conducted at Systems Research Laboratories using an RFC eddy current inspection system and RFC probes. Four D20 differential eddy current probes were used, two operating at 2 MHz (Probe 872, S/N 15077 and 15078) and two at 6 MHz (Probe 4005, S/N 13653 and 13652). Sixteen Waspaloy flat plate specimens (PWA-1016) were selected for testing. Veridian's flat plate reliability test scan plan "IN100-FP-20T" was used to acquire data. UDRI selected for testing four of the five-sided, MACOR® substrate, RFC-style, wire artifact calibration blocks. The block and wire identification numbers were B09, B11, B12, and B16. Block B16 was made using a pneumatic mold that is described in a later section in this report. A Waspaloy calibration block containing an EDM notch was used for comparison purposes. Veridian chose the master Waspaloy surface block, S/N QMM022 for these tests.



Figure 29 - Flat plate Waspaloy reliability specimens were used to compare inspections using the new calibration blocks with Waspaloy master EDM calibration blocks.

The tests were designed to detect the effects of the calibration blocks, the different probes, and any calibration block - 31probe interaction. For each test the selected eddy current probe was calibrated on one of the five calibration blocks and then eight of the test specimens were inspected (set "A"). The same gain and phase settings determined during calibration were then used to inspect a second set of eight specimens (set "B"). When using the 2 MHz probe the EDM notch produced an eddy current response that was typically 5 dB smaller than the response produced by the wire artifact blocks. The EDM notch responses when using the 6 MHz probe were approximately 3 dB smaller than the wire artifact responses. The phase angle was determined by the calibration using the EDM notch and was 197/199 degrees for the 2 MHz probes and 253/255 degrees for the 6 MHz probes.

A summary of the eddy current responses from the Waspaloy flat plate specimens is shown in Table II. The amplitude of the response from each crack for each inspection is contained in Appendix F. Figures 31 - 36 graphically compare the eddy current signal amplitudes from the cracks for inspections calibrated with the UDRI calibration blocks and those calibrated using the master Waspaloy EDM notch. It is easily seen in the figures that there are no statistically significant differences between using the new UDRI calibration blocks and the master Waspaloy EDM calibration block to calibrate the reliability inspections. In fact, Figures 35 and 36 show the variation that can occur when two probes (of the same frequency) are calibrated using just the master Waspaloy calibration block. The only differences between the two inspections that produced the data shown in each figure was the switching from one probe to the other. No changes were made to the scan plan and the calibration and inspection algorithms were allowed to proceed without interruption.

Dr. Al Berens, UDRI, who routinely assesses reliability inspection results for RFC tests, summarized the reliability test data at the July 21, 1998 RFC PRDA review meeting as follows:

Summary of Reliability Tests

- 1) The effects due to using the UDRI wire artifact calibration blocks for calibration, as part of the reliability test data acquisition for the Waspaloy flat plate specimens, are not statistically significant in either the 2 MHz or 6 MHz probe data sets.**
- 2) The probe-to-probe variation is significant in the 2 MHz data.**
- 3) The differences in the data due to using any of the calibration blocks is less important than differences due to repeated probe calibrations.**

Figure 30 - Using the five-sided, RFC-style, wire-artifact, calibration blocks to calibrate an RFC eddy current system produced reliability results that were indistinguishable from those obtained using the master Waspaloy EDM notch calibration block.

Table II - Summary of Eddy Current Responses from Flat Plate Reliability Specimens

				Eddy Current Response - All 5 Calibration Blocks (Digitizer Counts)							
Set	Crack S/N	Surface	Depth	Probe SN: 15077 (2MHz)		Probe SN: 15078 (2MHz)		Probe SN: 13653 (6MHz)		Probe SN: 13652 (6MHz)	
				Average	Std. Dev.	Average	Std. Dev.	Average	Std. Dev.	Average	Std. Dev.
A	1	Top	6.7	339	27	380	40	343	28	336	15
	3	Top	9.3	630	14	815	65	636	51	593	35
	5	Bottom	13.9	1129	18	1208	122	923	37	1069	24
	7	Top	21.1	3196	37	3433	95	2851	200	2842	76
	9	Bottom	10	681	16	822	68	582	59	573	17
	10	Top	6	250	22	282	31	268	31	233	13
	11	Bottom	15.2	1111	14	1417	67	1058	51	1078	38
	13	Top	8.7	390	8	461	11	381	34	350	15
B	14	Bottom	6	231	11	290	18	232	13	232	11
	15	Top	17.8	1884	36	2360	74	1823	158	1951	99
	17	Bottom	10.6	815	23	896	88	667	20	757	23
	18	Bottom	7.3	No Data	No Data	No Data	No Data	388	18	389	12
	20	Top	13.2	1212	29	1617	63	1266	95	1273	73
	21	Bottom	5.4	368	29	422	28	353	12	365	8
	22	Top	23	4136	76	4739	151	3731	236	3747	207
	23	Top	11.9	940	22	1224	59	912	43	901	62

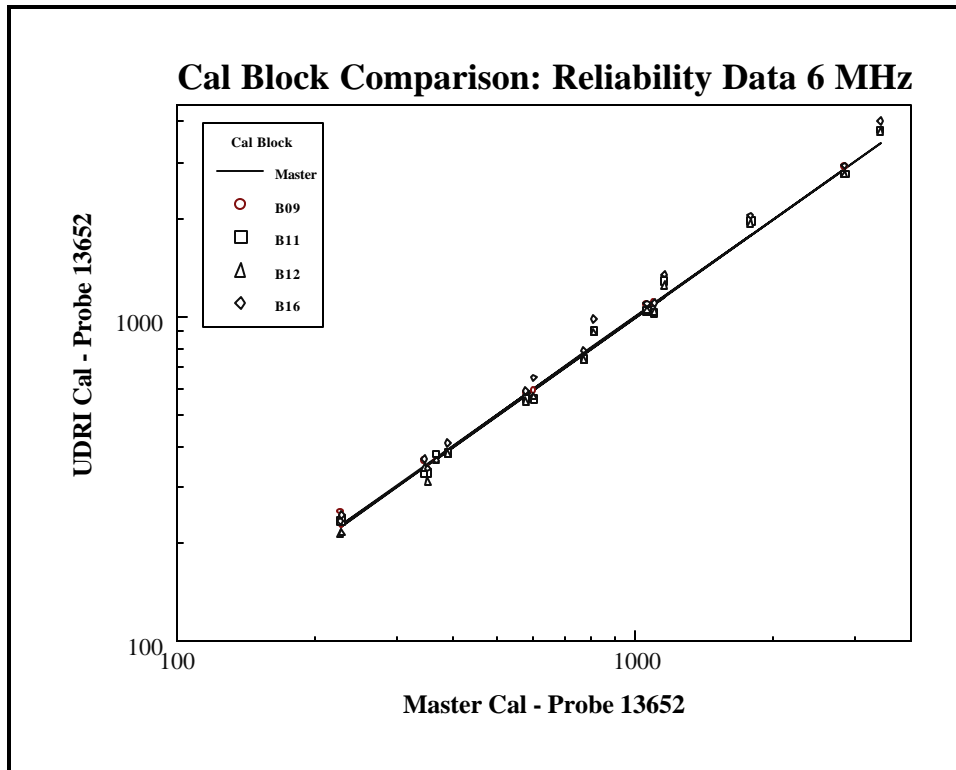

Figure 31 - Comparison of 6 MHz reliability results using probe 13652.

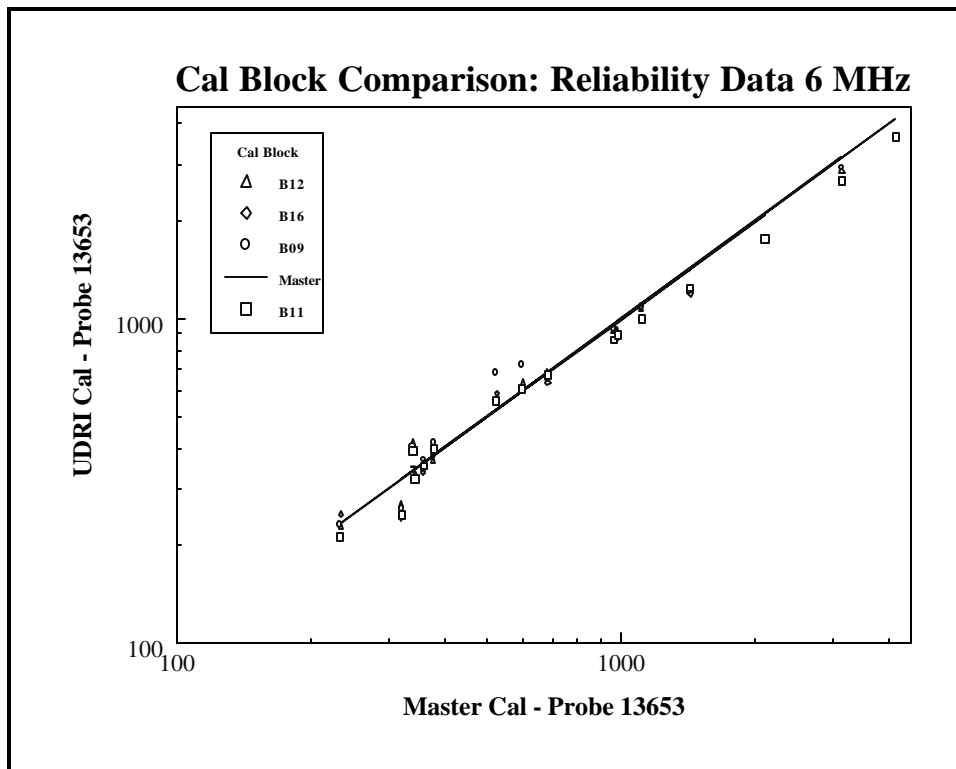

Figure 32 - Comparison of 6 MHz reliability results using probe 13653.

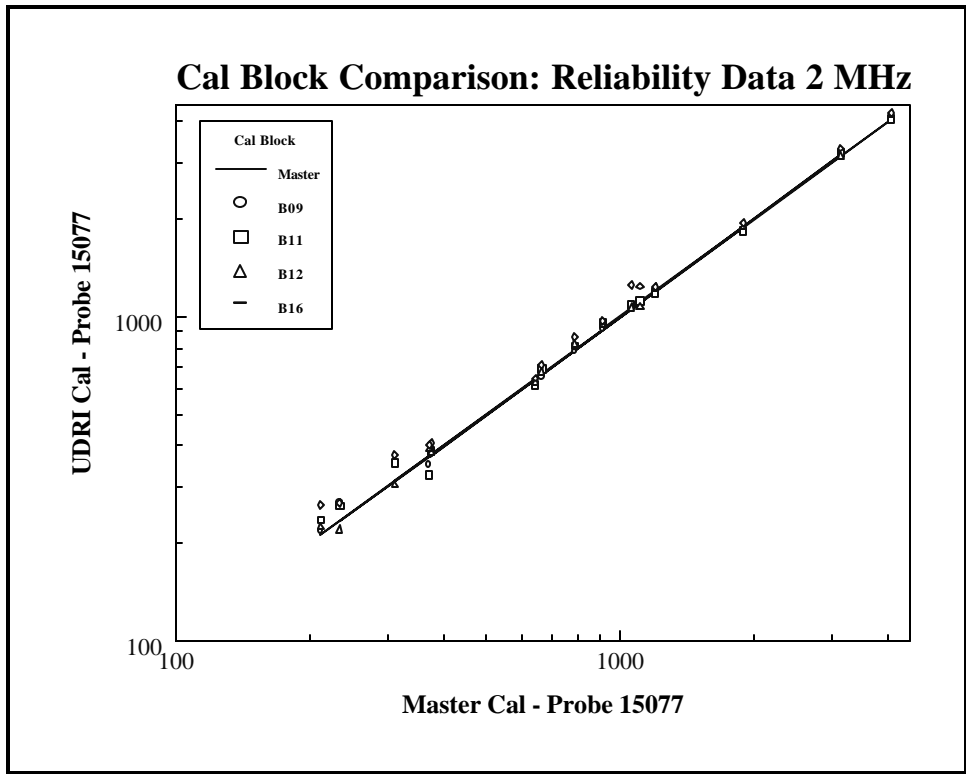

Figure 33 - Comparison of 2 MHz reliability results using probe 15077.

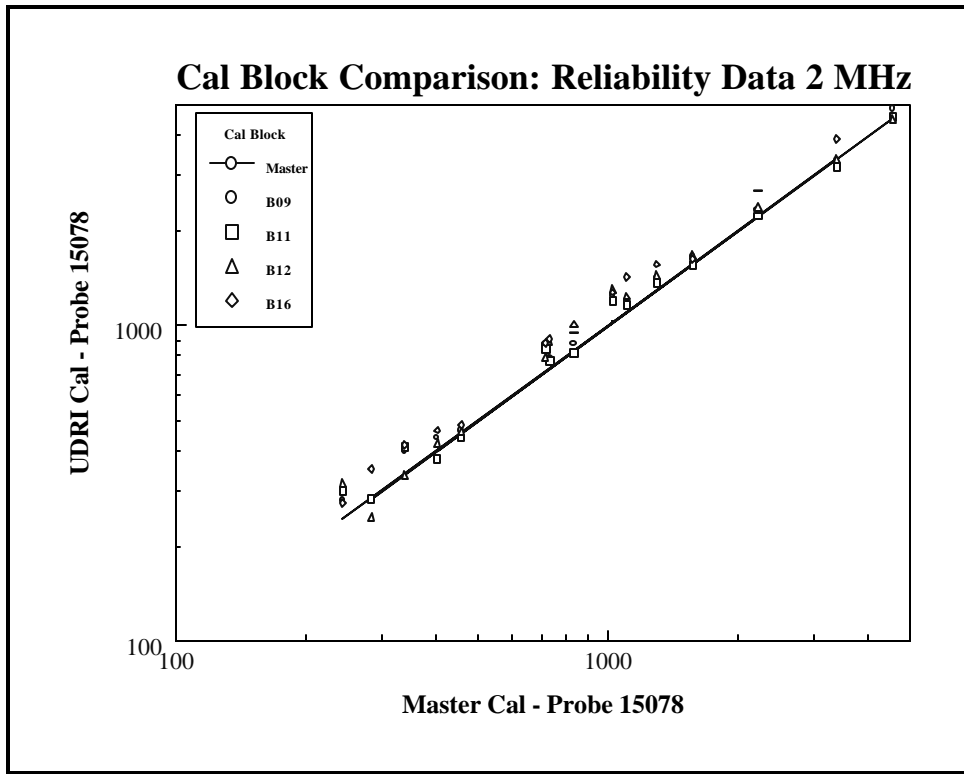

Figure 34 - Comparison of 2 MHz reliability results using probe 15078.

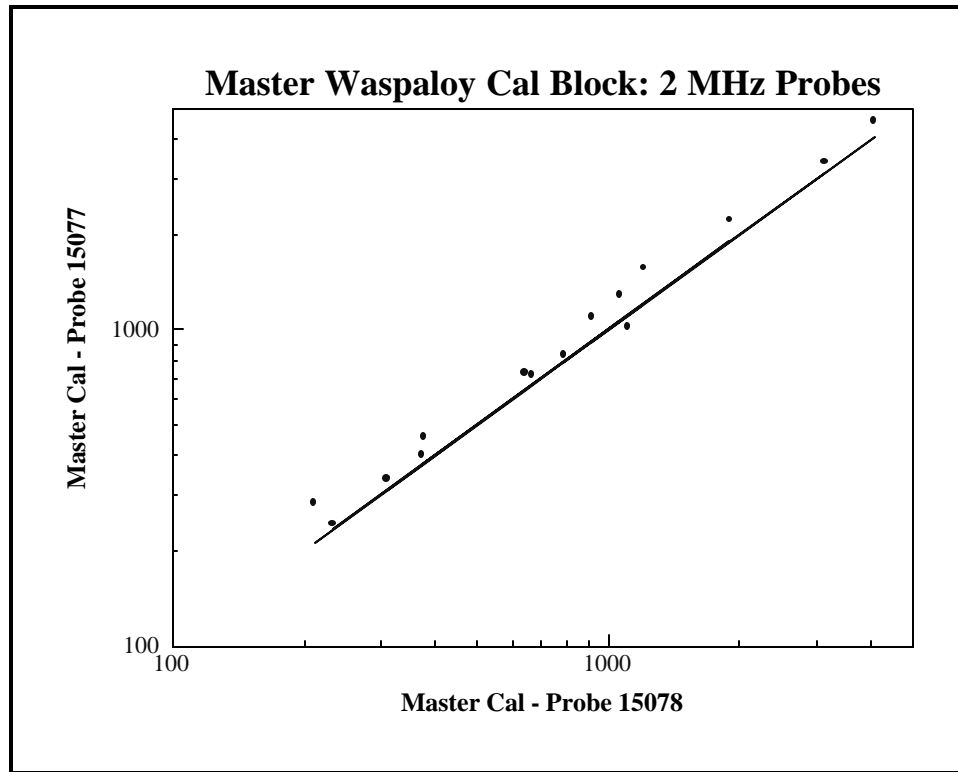

Figure 35 - Comparison of 2 MHz reliability results: probe-to-probe variation.

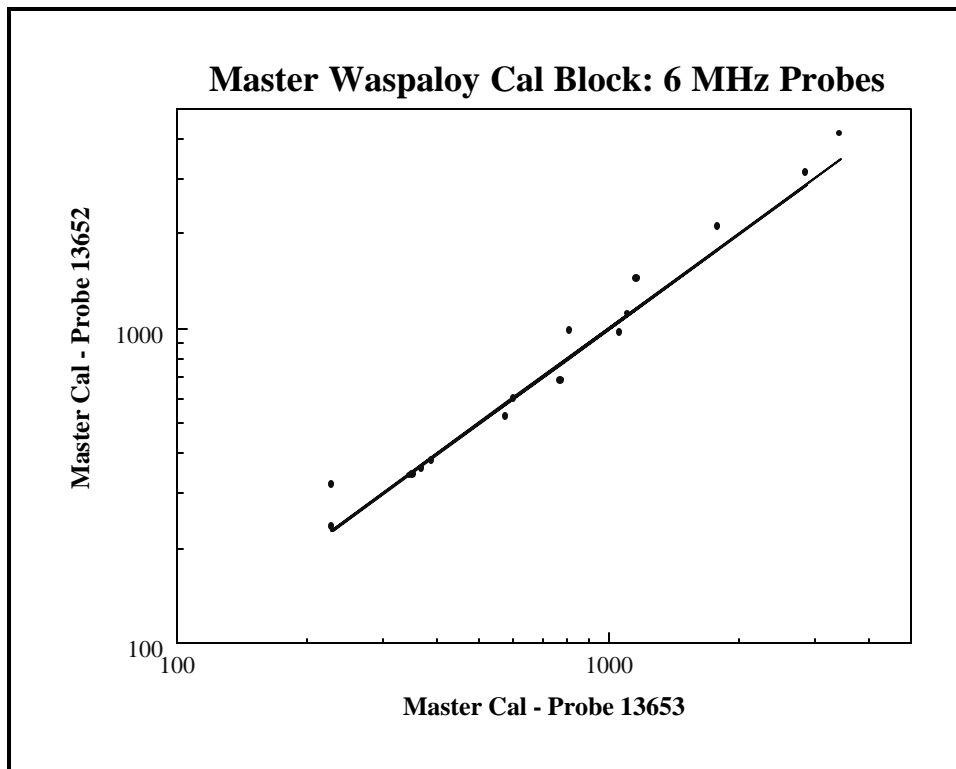

Figure 36 - Comparison of 6 MHz reliability results: probe-to-probe variation.

8.0 IMPLEMENTATION CONSIDERATIONS

The preceding sections described the research and development that went into demonstrating the feasibility of the new eddy current calibration artifact concept. The reliability testing of four wire artifact calibration blocks showed that they could be used in place of the traditional EDM notch calibration blocks with regard to their effect on gain calibration. However, several other considerations were examined in order to justify recommendation of the new calibration blocks for use in ALC RFC eddy current systems. Implementation considerations that were examined included the effects on existing scan plans and system software, revision of the notch scaling factors, the effect on the time required to accomplish calibration, block durability, wearing of the surface due to repeated scanning of the eddy current probes, and cost of the new blocks. In this section these considerations for implementation of the new calibration artifact into RFC inspections are discussed.

8.1 Effects on Existing Scan Plans - Phase Calibration

If necessary, the new calibration blocks could be used for gain calibration without modification to the system software or scan plan. However, phase calibration is essentially part of gain calibration and the MACOR® substrate blocks cannot be used to calibrate the phase angle of the eddy current instrument. Accomplishing phase calibration on the RFC eddy current inspection systems requires the use of engine alloy blocks. UDRI has designed and demonstrated a hybrid surface calibration block incorporating the MACOR® substrate wire artifacts with engine alloys. Figure 37 shows one of the hybrid blocks made and successfully tested on an RFC eddy current system at Systems Research Laboratories. For the test the block shown in Figure 37 was directly substituted for a standard RFC calibration block - no changes were made to the system software or scan plan - and the inspection system successfully completed the gain and phase calibration routines. The engine alloy attachment was designed to be large enough to allow phase calibration to occur, but small enough such that the alloy wasn't within the data acquisition "window" during gain calibration. This design allowed a successful gain calibration without modification to either the scan plan or the gain and phase calibration algorithms.

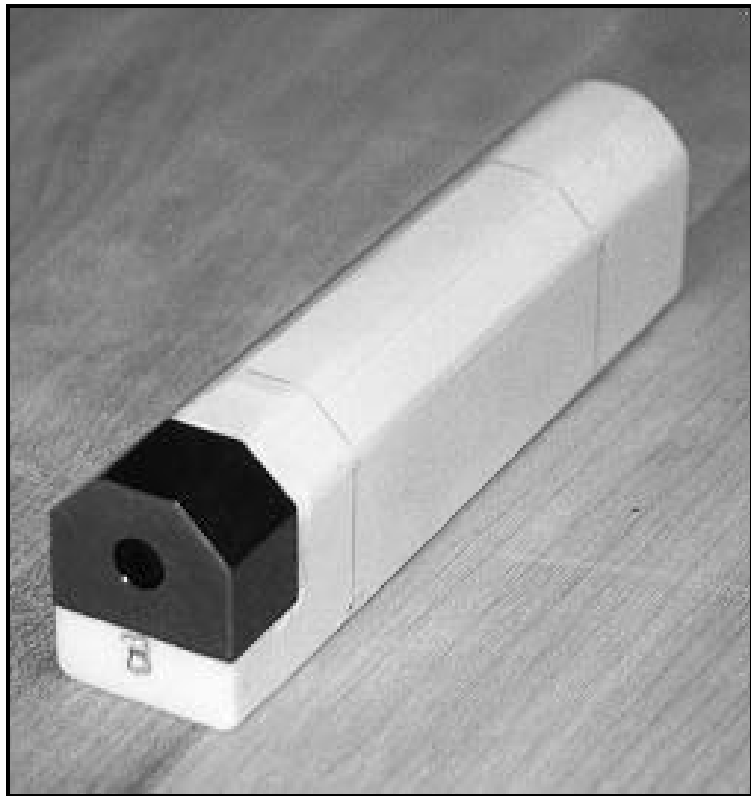

Figure 37 - An engine alloy end piece has been attached to the MACOR® wire-artifact block so that the block can be used for phase calibration.

8.2 Effects on Existing Scan Plans - Gain Calibration

While no changes to gain calibration are required, significant time savings can be achieved by modifying the number of index steps currently required. Since the eddy current response from the wire artifacts has been shown to be uniform along the wires, no indexing is necessary to find the maximum response. Several passes of the eddy current probe over the wire could be averaged to reduce electrical noise and random fluctuations of the eddy current signal as is current done during gain calibration. Since there would be no need to index the probe the initial placement of the probe should be moved to the center of the calibration block rather than offset from the center. Thus, the recommended changes to the system software to optimize gain calibration with the new calibration blocks are:

- S Make the initial starting point of gain calibration at the center of the block,
- S Eliminate the stepping of the probe in the index direction.

The changes are summarized in Table III.

It is important to note that these changes could be accomplished without making existing scan plans obsolete by changing the gain calibration to recognize a “flag” in the notch scaling index lookup tables. For example, if the second field in the notch scaling lookup table was set to a predefined value (say “999”) the gain calibration algorithm would choose to execute the new calibration routine rather than the old.

Table III - Effects on Scan Plan of Using New Calibration Block.

Calibration Parameter	Comparison of Scan Plan Values	
	EDM Notch	New Block
Desired Amplitude	Same	Same
Beginning Gain	Same	Same
Index Step Size	0.005 inches	N/A
# of Indexes	12 - 20	0
Scan Distance	Same	Same
# Averages	4 per index	4
Filter Settings	Same	Same
Phase Angle Location	Same	Same
Gain Cal. Start Location	Same	Same
Cal. Block Location	Same	Same
RECHII - Centering Cal.	Same	Same
RECHII - Phase Cal.	Same	Same
RECHII - Gain Cal.	Same	Same

Gain calibration uses the values in the notch scaling lookup table to compensate for the inherent differences in each EDM notch. The data presented in the Results section of this report show that only one notch scaling value would be necessary for all wire artifact blocks. This would remove the requirement to update the lookup tables in the RFC inspection systems each time a new calibration block is incorporated. At this point in the research and development UDRI suggests that a separate notch scaling value be used for surface blocks versus the RECHII inserts. However, there is some indication that a single value could be used for all calibration blocks, both surface and RECHII types.

Using the new wire-type calibration blocks in the manner suggested above would let the gain calibration of each probe take place in less than 30 seconds. This represents a times savings of approximately five minutes per probe calibration compared to the present method using EDM notch calibration blocks. The inspection of some engine components requires more than ten probe changes and calibrations, thus, a time savings of approximately one hour could be realized in the inspection of each of these components.

8.3 Effects on Existing Scan Plans - Placement of Calibration Blocks

With the development of the hybrid block incorporating engine alloy for phase calibration the new calibration blocks can be a “drop-in” replacement for the old calibration blocks. No changes in block placement, system software, or scan plan parameters is required. As mentioned in the preceding section, optimization of the scan plan parameters and system software would result in considerable time savings during engine component inspections.

An option exists for using the new surface calibration blocks to replace several old blocks if the space is needed on the calibration setup plates. “Phase calibration” blocks could be made and located separately on the setup plates (see Figure 38). Each phase calibration block could be a cube, approximately 25 mm on a side (~ 1 inch) and used solely for phase calibration. Gain calibration could take place on a single, five-sided, wire artifact calibration block. This approach would require changing the starting location of the probe in both gain and phase calibration in the scan plans and may require changes in the system software. It also would require new phase calibration blocks to be made. However, the savings in space on the calibration setup plate could be substantial.

The new, hybrid RECHII inserts, incorporating an engine alloy top flange with the MACOR® cylinder and wire artifact for gain calibration, also could be “drop-in” replacements for existing RECHII calibration inserts. However, there is no advantage in the time of calibration when using the new RECHII inserts compared to the existing inserts. And, because the RECHII probes rotate so quickly (1500 r.p.m.) the index step size can be made very small so that the repeatability of the calibration is better than for the surface calibration blocks. An advantage that would be gained by using the new RECHII inserts is that a single notch scaling index factor could be used for all RECHII inserts. Assessing the limited advantages of using the new RECHII inserts UDRI recommends that the Air Force consider using the technology for any new RECHII inserts but not replacing existing inserts.

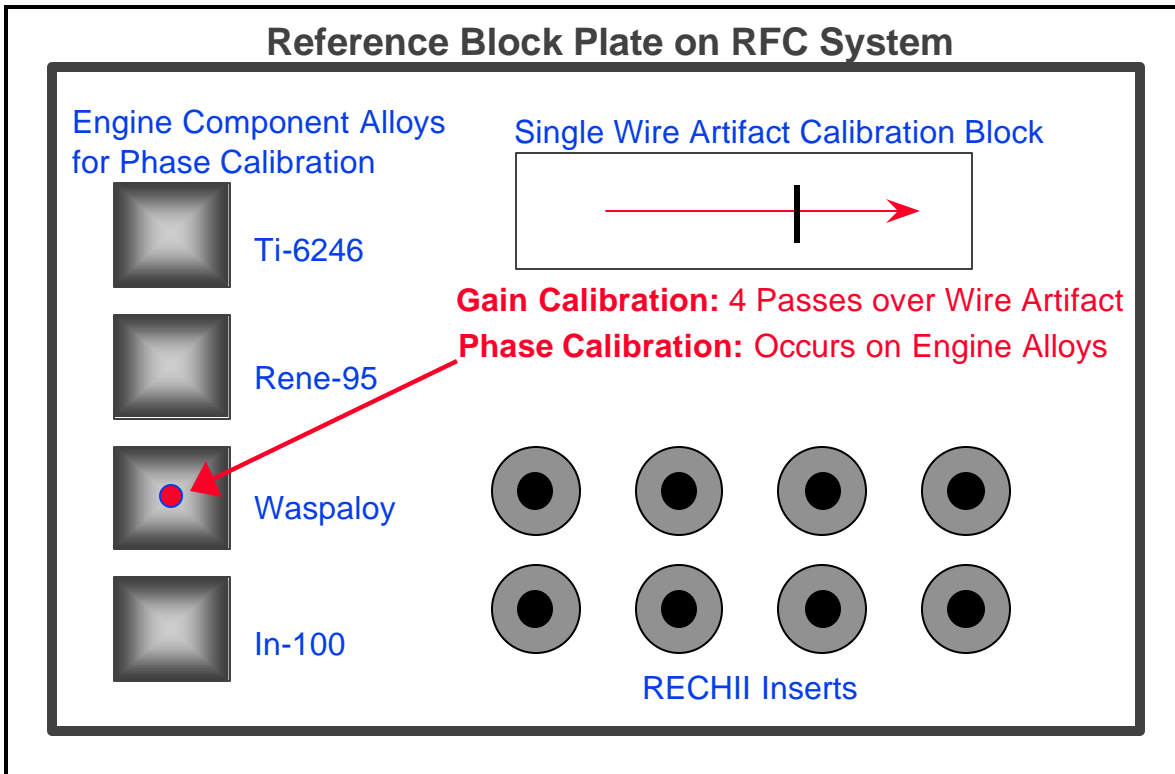

Figure 38 - An alternative configuration of calibration blocks for maximizing the number of engine components that can be inspected on an RFC eddy current system.

8.4 Durability and Wear of Calibration Blocks

To be useful on RFC eddy current inspection systems the new calibration blocks must be durable and withstand the wear that thousands of passes of the surface probes could create. UDRI's experience with the MACOR® substrate suggests that the blocks will hold up well to normal handling. There was a concern with the substrate fracturing due to repeated attachment to the setup plates. Excessive tightening of metal screws into the threaded holes in the calibration blocks fractured a block that UDRI was testing. To remove the concern UDRI designed a metallic base that the MACOR® block could be attached to once and then the base would tolerate the stresses from repeated attachment to the setup plates. The base and new MACOR® substrates were designed so that the size and shape of the mated pair were the same as

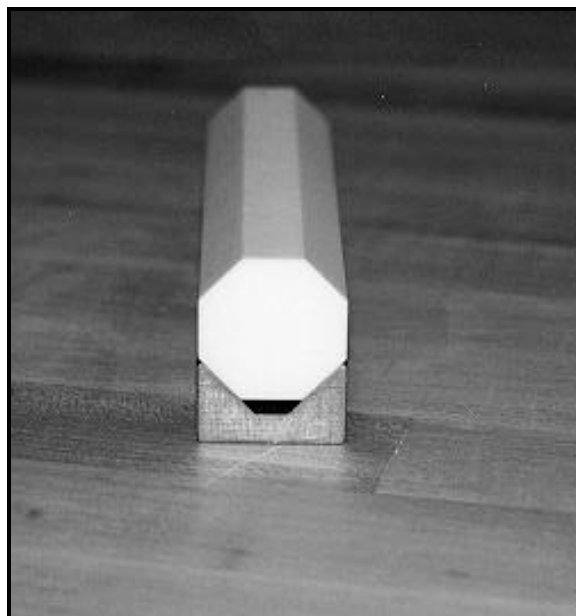

Figure 39 - The metal base plate improves the ruggedness of the MACOR® substrate calibration blocks.

the original block (see Figure 39). The MACOR® substrate is held tightly in place on the metallic base with screws. This design adds a small cost to each calibration block but would substantially increase the durability of repeated attachments to the inspection systems.

Testing was conducted to determine how much deformation to the surface of the new calibration blocks would occur due to the repeated passes of the eddy current probes over the surface. A servo-hydraulically-actuated scanning system was used to move an RFC eddy current probe shoe back and forth over the top surface of a five-sided, MACOR® substrate, wire artifact block. The shoe moved along a 25 mm long path (~ 1 inch) centered about the wire artifact and completed each forward/backward pass along the block in 1 second. The probe shoe was forced down onto the surface of the block with a force equal to that created by the “high compliance” RFC eddy current surface probes (see Figure 40).

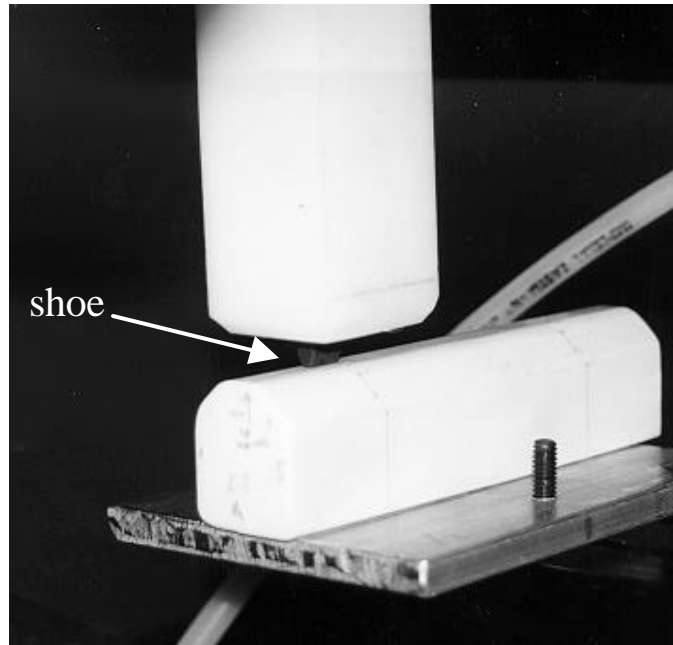

Figure 40 - An eddy current probe shoe was used to conduct wear tests on the wire-artifact calibration blocks.

The surface of the block was examined periodically using a WYKO NT-2000 vertical scanning interferometer (VSI) manufactured by Veeco Instruments Incorporated.⁶ The VSI had the capability to measure heights from 0.0001 mm to several millimeters, with vertical resolution as low as 0.0001 mm. Scans of the block’s surface were made before the wear tests started and after 1000, 5000, 10,000, 50,000, 100,000 and 200,000 passes of the probe shoe across the surface.

No change in the surface of the block was measurable until 100,000 passes of the probe had occurred. After 100,000 the VSI showed a wear pattern evidenced by three grooves in the probe shoe scanning direction. The grooves were measured to be approximately 0.002 mm deep. After 200,000 passes of the probe, a fourth groove had developed in the surface, presumably due to variations in the shoe path. The deepest groove was measured to be 0.004 mm deep. UDRI acquired eddy current amplitude data from the wire artifact after the wear tests and found no change in the eddy current response. The grooves also did not seem to affect the probe shoe sliding along the block.

⁶ Veeco Metrology Group, WYKO Optical Profilers, 2650 East Elvira Road, Tucson, AZ 85706-7123 Phone: (520) 741-1044

The following example will help to put into perspective the rate of wear detected during these tests. Let's assume that during RFC inspections a calibration process takes place every 60 minutes, or 16 times per day for a 16 hour day. Let's also assume that during each calibration the probe scans across the new wire-artifact calibration block 10 times. At this rate of calibration, the block would see the equivalent of 200,000 passes in approximately 1250 days. Thus, after 1250 days (4+ years) grooves 0.004 mm deep might be expected in the surface of the blocks. As indicated above 0.004 mm deep grooves do not seem to affect the functionality of the blocks for eddy current calibration.

8.5 Costs of the Wire Artifact Calibration Blocks

The costs of making the five-sided, RFC-style, MACOR® substrate, wire-artifact calibration blocks using the pneumatic mold were:

S	\$300	machined MACOR® block (in quantities of 10)
S	\$ 10	wire, epoxy, and other expendables
S	\$250	estimated for labor to make block
S	\$250	estimated for labor to checkout block
<hr/>		
Total:	\$810 per block	(in quantities of 10)

These cost estimates assume a yield of “good” blocks (the wire artifacts on all five sides produce appropriate eddy current responses) of 75 - 80%. The cost estimates do not include a metal base that would be desirable for use in an inspection facility. The cost estimates also do not include the cost of engine alloys for phase calibration.

8.6 Manufacturing Process

A five-sided, pneumatically-actuated, mold and press system was designed to make the construction of the five-sided, RFC-style, MACOR® substrate wire artifact blocks a faster process. The same construction concepts that were done by hand one side at a time were incorporated into the pneumatic press. Several design iterations were required to optimize the press. Problems overcome included unoptimized pressures, nonuniform distribution of the epoxy binder, holding the wire in place, and removing the blocks from the mold. The final design of the pneumatic press and mold is shown in Figure 41. The calibration block shown in Figure 42 was made with the press and mold in less than eight hours and one of the blocks included in the reliability testing was produced using the same equipment. During the program five blocks were produced using the pneumatic press and mold.

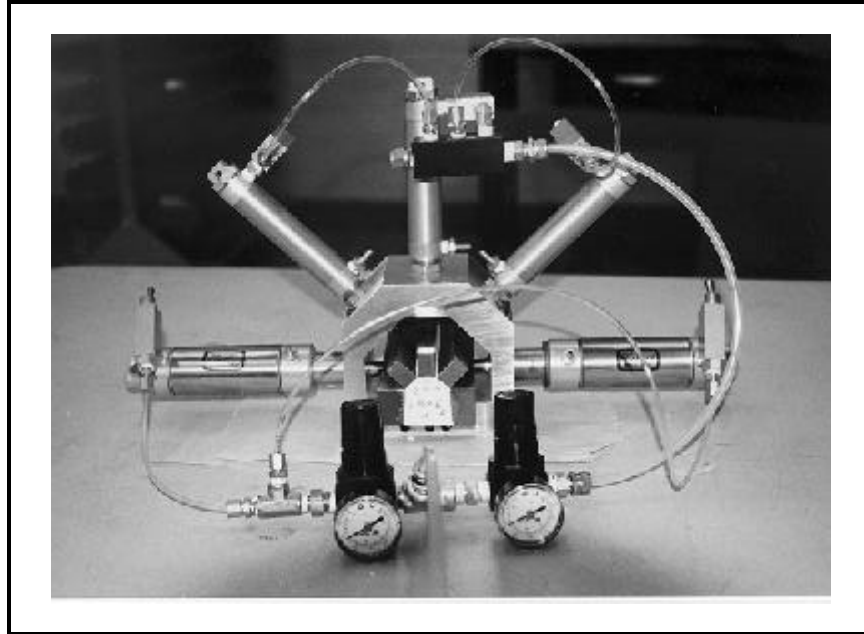

Figure 41 - The pneumatic press and mold is shown in this photograph.

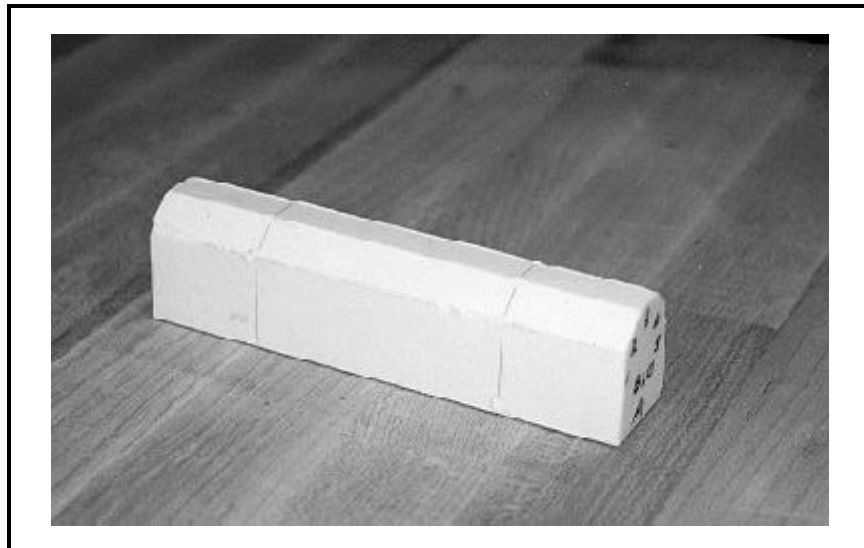

Figure 42 - This calibration block was made using the press shown in Figure 41.

9.0 RECOMMENDATIONS FOR FUTURE WORK

- 1) Further development and testing of the RECHII inserts are needed to verify the repeatability of the eddy current response from RECHII artifact to artifact,
- 2) The control of the pneumatic press cylinders should be optimized,
- 3) A “master” wire-artifact surface calibration block should be constructed that produces the eddy current response that all other blocks will be compared to,
- 4) Final drawings for the surface blocks incorporating an engine alloy insert (for phase calibration) need to be made,
- 5) Finishing processes should be finalized (for example, to determine how much of the excess epoxy binder should be removed) and the final form of the calibration blocks should be specified,
- 6) A specification should be written describing the acceptable range of eddy current response amplitudes and variations along each wire,
- 7) Several surface blocks incorporating an engine alloy insert and metallic base should be constructed and evaluated on RFC systems at an ALC inspection facility,
- 8) Several RECHII calibration inserts should be constructed and evaluated on RFC systems at an ALC inspection facility,
- 9) Reliability testing should be conducted and POD results obtained for wire-artifact RECHII inserts of various diameters,
- 10) A company that has sufficient knowledge of eddy current probes and inspections should be selected for commercializing the new calibration block technology.

10.0 ACKNOWLEDGMENTS

The technical achievements produced during this program were the result of a team of University of Dayton Research Institute engineers and technicians. Some of their contributions are noted below.

The efforts of Mark Ruddell in finding the Macor® material, the diamond-like carbon coating process, and pushing forward the photolithography specimen design and procurement were significant contributions to the program.

Dave Petricola acquired and processed most of the data that were used to verify the new calibration concept and assisted in constructing some of the wire artifact blocks.

Brian Frock quickly determined that the electronic artifact approach, specifically using PC disk drive read/write heads, was not likely to result in repeatable calibrations.

Ira Fiscus designed the pneumatic press and mold equipment that successfully reduced the calibration block construction time from one week to one day.

James Sebastian designed the RECHII insert alignment gage and produced rotating wire artifacts to demonstrate a calibration method that better simulated the actual inspection process.

George Hartman got the project started by designing the initial wire artifact construction concept. Appreciation is expressed to Dr. Al Berens for analyzing and summarizing the POD test data.

The work of several University of Dayton students was very helpful to the program: Mark Muldoon for constructing the equipment cabinet and building many acrylic substrate wire artifact blocks, and Kelly Haldeman and Chris Schmidt for their work in constructing wire type artifact blocks.

Appreciation is expressed to Ernie Keppler, Tim Braun, and Joe Ruthenberg at Veridian for helping test the wire-artifact blocks using the RFC inspection systems in their laboratory.

UDRI also acknowledges the helpful comments and constructive criticisms offered by Charlie Buynak, Matt Golis, Wally Reimann, Don Forney, Sara Keller, and the rest of the RFC community during the many status review meetings.

Appendix A

Overview of Calibration in the RFC Systems

This appendix contains a brief description of the process used to calibrate each eddy current probe on the RFC eddy current systems, before an inspection.

RFC eddy current calibration occurs in two steps. The eddy current probe is first brought to a calibration block for phase calibration. A lift-off signal is generated by either slightly rotating the surface probes or uncentering the hole probes. A linear least-squares-fit is made to the impedance plane signal and the resulting line is rotated to be horizontal by adjusting the phase angle parameter in the eddy current instrument. A check of the accuracy of the phase calibration is made by producing another lift-off signal, and if the resulting least-squares fit line is within ± 2 degrees of horizontal the procedure is completed. Otherwise, several more iterations can occur before an error condition is declared.

Gain calibration is performed by passing the eddy current coils over one or more EDM notches on the same calibration block used for phase calibration. The surface calibration blocks used at Kelly AFB contain three different size notches but only one is used for gain calibration. The surface calibration blocks at Tinker AFB also contain three notches, however, two are small and one is very long. Only one of the small notches is used for calibration. Both ALCs perform gain calibration by:

- 1) Raster scanning the probe coil across one EDM notch, in 0.01 inch index steps, until a maximum response to the notch is found (16 index steps occur),
- 2) Raster scanning again, but with 0.005 inch index steps, until a maximum response to the notch is found (again, 16 index steps are made),
- 3) Adjusting the gain of the eddy current instrument to produce a predetermined amplitude response from the notch.

This process takes less than one minute for bolt hole calibration, but can take over eight minutes for the surface probes. This long calibration time occurs because four passes of the probe along the calibration block are made for each index step during surface probe gain calibration to average out noise from the eddy current signal. (Note: averaging also is used during bolt hole gain calibration; but since the probe rotates at 1500 r.p.m. averaging at each index position takes only a fraction of a second).

Attempts have been made to reduce the time needed for surface probe gain calibration by incorporating long EDM notches (0.500 inches) in the surface probe reference blocks designed for the GE F101 and F110 engines at Tinker AFB. Problems with variations of the eddy current signal response along the length of the notch (probably due to inconsistencies in the width and depth dimensions and extent of the heat-affected zone) prevented the long notches from being used during gain calibration.

Although the RFC systems use EDM notches to adjust the gain of the eddy current system before each engine part geometry is inspected, the notches are not used to determine the sensitivity of the system to small cracks. For each geometry, the system sensitivity is determined, in the laboratory, relying on test engine components and reliability specimens. The NDE scientist responsible for the scan plan conducts experiments to determine system sensitivities that will allow the system to reliably detect the smallest crack required for that engine part geometry. This is accomplished using engine parts with EDM notches, engine parts with actual cracks (ideal, but rarely available), and reliability test specimens with fatigue cracks. An estimate is made of the system sensitivity required, then the system parameters (instrument gain, filter settings, scanning speed, etc.) are written into the scan plan. Next, the probe is scanned across a reference block with an EDM notch to determine the response from the notch. The amplitude from the notch is recorded as the "required amplitude" for that geometry scan plan. All subsequent scans of that geometry require gain calibration to adjust the response from a similar EDM notch to the "required amplitude."

To determine the actual system sensitivity to fatigue cracks, reliability tests are conducted using test coupons (more commonly known as reliability specimens). The reliability specimens are made of the same alloys used in the engine components and contain one or more fatigue cracks. Reliability scan plans, with eddy current system settings approximating those used in scan plans of engine components, are written for the reliability specimens. The probability of detection (POD) results from the reliability tests give some insight into how the system will perform on engine components. However, it is important to understand that the reliability test scan plans are not the same as the scan plans used on engine components. Critical parameters such as probe scanning speed, signal filters, thresholds, signal averaging routines, step sizes, etc. are different between the reliability scan plans and the actual engine component inspection scan plans. Reliability specimens require short, linear scans. Engine components are rotated on a turntable. Generally, it is not possible to use identical settings between the reliability scan plans and engine part inspections, largely because of the geometry difference of the two test objects. This difference causes numerous differences in the scan plans, and thus the crack detection sensitivities. Of importance for this proposal is the understanding that calibration on the calibration blocks is achieved using the same scanning motions as is done on the reliability specimens. Thus, gain calibration acquires the signal from the EDM notch in a manner similar to the scanning of reliability specimens, but unlike the actual inspection of engine components.

Attempts have been made to correlate the sensitivity of the eddy current systems determined using reliability specimens (with actual fatigue cracks) to the engine part scan plans. The analysis is very complicated and conclusions about the correlation are uncertain. The EDM notches serve only as a vehicle for conveying the system sensitivity determined in the laboratory to the day-to-day set up of each eddy current system at the ALCs.

Appendix B

Proposed Objectives and Goals

The objectives of the proposed program were:

- 1) Increase the reliability of the gain calibration process,
- 2) Achieve higher inspection throughput by decreasing calibration time,
- 3) Reduce the property control and reference standard utilization logistics problems associated with very large numbers of reference standards and EDM notches,
- 4) Reduce the costs of acquiring reference standards, and
- 5) Allow calibration to have the same setup parameters as the actual engine component inspections.

Increasing gain calibration reliability. The station-to-station variation that occurs in gain calibration can be reduced through the development and implementation of a highly reproducible gain calibration artifact. Additionally, the variation will decrease if the artifact is large compared with the diameter of the eddy current coils. The proposed research and development will identify, and implement in an ALC-acceptable manner, a calibration artifact (not an EDM notch) that can be exactly duplicated.

Increase inspection throughput. By using a long artifact the time spent during calibration will be significantly reduced. A typical complex engine component may use as many as eight different surface probes, each requiring calibration before use. Using current calibration techniques over one hour of inspection time is spent on the calibration process for each engine part! UDRI proposes changes in the calibration concept that conceivably could reduce calibration times by an order of magnitude.

Reduce property control and reference standard utilization problems. UDRI is proposing the development of a reproducible gain calibration artifact that can be used for all surface probes, and potentially all bolt hole probes. It is conceivable that each eddy current station will have only one gain calibration artifact. Phase calibration will still require a small block of material having the same conductivity as the engine component, but only one small block may be required per material type.

Cost Reduction. The number of reference standards potentially could be reduced from over 1000 to less than 200. This assumes that one gain calibration artifact is needed per station and 3-4 phase calibration blocks are required per station.

Equivalent calibration and inspection setups. As will be explained in more detail in the following sections, UDRI's concept of a single, reproducible calibration artifact may lend itself to the creation of a spinning reference standard. This would allow inspection settings such as high and low pass filters, scanning speeds, and signal processing parameters (there are several) to be identical between calibration and inspection. This should improve the station-to-station repeatability. It also may create a tighter link between the part inspection parameters and the reliability inspection parameters because the mechanism (gain calibration) that transfers the system sensitivity information partly derived from the reliability tests, would be the same as the actual part inspections.

Appendix C

Specifications for Eddy Current Data Acquisition System

----- Eddy Current Scan System Block Diagram -----

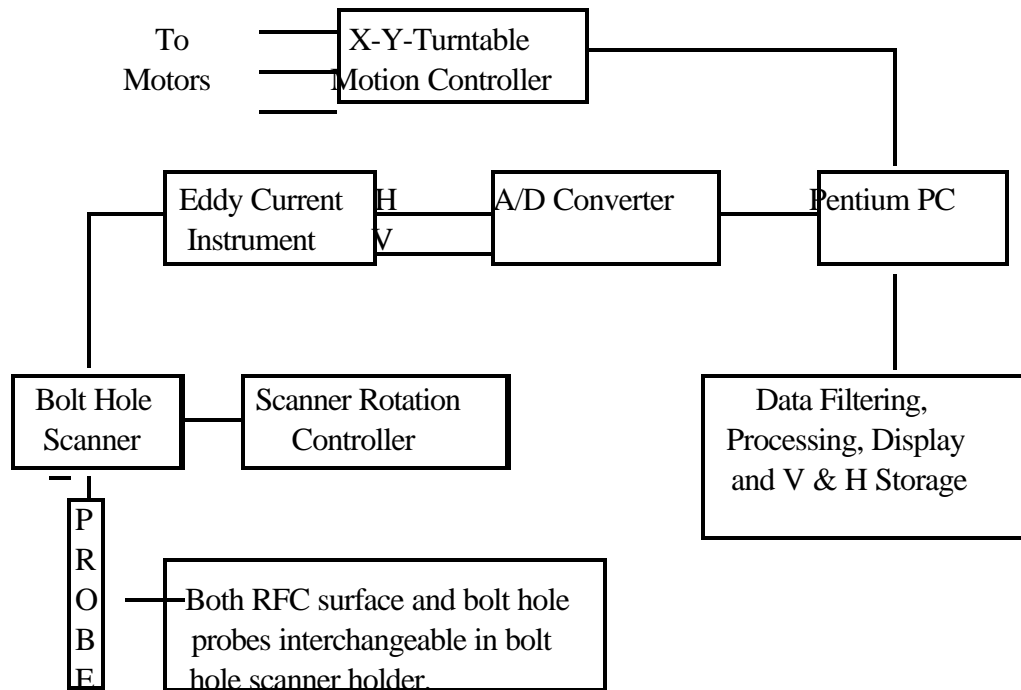

----- System Specifications -----

Eddy Current Instrument:

- (1) The EC instrument must have sensitivity, signal-to-noise ratio and a selection of filters and gains similar to the Staveley or Nortec 25L instrument which is used in RFC eddy current systems.
- (2) Variable low pass, high pass or bandpass filters for both the vertical and horizontal impedance plane signals.
- (3) Adjustable gains in the range of 0-90 dB.
- (4) Minimum frequency range of 100 Hz to 6 MHz.
- (5) The probe drive must be capable of fully driving RFC probes in both reflection absolute and reflection differential mode.
- (6) The instrument must have both horizontal and vertical outputs to the A/D.
- (7) A 4-wire electrical connection is required from the EC instrument to the bolt hole scanner: 1) Receive-0 degrees, 2) Drive, 3) Common, and 4) Receive-180 degrees.

A/D Converter:

- (1) A 2 channel A/D digitizer within the PC will interface the eddy current instrument's vertical and horizontal signals to the PC.
- (2) The A/D resolution must be at least 12-bits with a digitization rate of at least 10,000 sps or higher.

Bolt Hole Scanner and Holder:

Note: RFC eddy current probe dimensional, mechanical, and electrical specifications can be obtained from the following sources:

Systems Research Laboratories
2800 Indian Ripple Road
Dayton, OH 45440
(513) 426-6000

UniWest
1021 N. Kellogg
Kennewick, WA 99336
(509) 783-0680
Attn: Mark Gehlen

- (1) Both RFC type surface probes and rotating RFC type bolt hole probes must be mechanically accepted by the probe holder/scanner. Quote any additional costs (if any) to interface the RFC style probes to the scanner.
- (2) The rotating probe holder must rotate the probe to any position with 0.5 degree resolution and 1.0 degree accuracy. The probe must spin at a minimum of 200 r.p.m. Rotation speeds up to 1500 r.p.m. are highly desired.
- (3) A 4-wire electrical connection is required from the scanner to the EC instrument and from the scanner to probe 1) Receive-0 degrees, 2) Drive, 3) Common, and 4) Receive-180 degrees.
- (4) No Z-axis indexing of the probe by the bolt hole scanner is required. However, a means to adjust the z-axis to a fixed position manually is required.

Bolt Hole Scanner Controller:

Note: The bolt hole scanner controller "may" be supplied as an integral part of the eddy current instrument.

- (1) Must maintain r.p.m. constant at a selected value between 200 and 1500 r.p.m.
- (2) A spin/rotate switch (or other means of stopping the spin of the probe) must be provided so that rotation may be turned off while using surface probes. A manually operated switch is sufficient.
- (3) A once per revolution sync pulse must be provided to indicate start/end of a rotation for data acquisition.

Eddy Current Probes:

RFC Probes are not a part of this request for quotes and will be purchased at a later time. However the RFC probe must be considered in interfacing it to the scanner and holder.

- (1) RFC style probe body and connector.
- (2) Operate in reflection absolute or reflection differential mode.
- (3) A 4-wire electrical connection is required from the scanner/holder to the RFC probe: 1) Receive-0 degrees, 2) Drive, 3) Common, and 4) Receive-180 degrees.
- (4) Coil diameter = 0.080 +- .005 inches.

X-Y Scanning System:

- (1) The Z axis must provide at least 8 inches of travel in height and capable of being adjusted manually to the desired position. The z-axis must be perpendicular to the x-y axes plane.
- (2) The x-y-z axes configuration must be capable of supporting and moving at least an 8 pound load attached to the z-axis.
- (3) The X and Y axes must be motorized and with computer control. provide an active raster type scan area of at least 12 inches by 12 inches with a resolution and repeatability of at least 0.001 inches.
- (3) Servo motors are preferred on each axis in order to minimize electrical noise.
- (4) The X and Y axis maximum scan speed should be at least 1 inch per second.

Turntable Scanning System:

- (1) The turntable must be at least 6 inches in diameter and capable of operation at any speed from 0.5 to 60 r.p.m. (maximum r.p.m. depends upon diameter: 12 inch diameter at 30 r.p.m.).
- (2) The turntable speed may be adjusted under either manual or computer control (either is acceptable).
- (3) A once per revolution position pulse must be provided to synchronize the turntable rotation to the data acquisition system.
- (4) The turntable must be capable of supporting a minimum weight of 5 pounds.

Software for Data Acquisition/ Analysis/ Display/ Storage:

- (1) Software for control of the eddy current instrument.
- (2) Software for control and synchronization of the A/D converter and motorized scanning system with the EC instrument. This includes the scanner sync pulse and the once per revolution turntable pulse.
- (3) Impedance plane display software with the ability to rotate the impedance plane continuously (0-360 degrees) with either the EC instrument controls or software. The impedance plane signal shall be displayed in rectangular coordinates.
- (4) Provide full waveform capture capability of both the vertical and horizontal components of the impedance plane signal.
- (5) A minimum of 30 seconds of data must be stored to disk from both the horizontal and vertical channels.

(6) Software for separate strip chart display (vertical or horizontal impedance plane components versus time) and data storage of both the vertical and horizontal components of the impedance plane signal.

(7) The bolt hole scanner mode will use the SAME impedance plane display and data storage of vertical and horizontal outputs as used by the surface probes.

(8) Data storage on the hard disk must conform to an industry “standard” recognized format to allow data analysis and image display by other computer software including databases and image display software. As a minimum, data formats should be selectable between 16-bit binary and ASCII.

(9) C-scan acquisition/display software (Quote as Optional).

Computer System (Optional if supplied by UDRI):

(1) Intel Pentium processor, 120 MHz or faster clock speed with ISA and PCI backplanes (desktop or tower case).

(2) 16 Mbyte of RAM

(3) 3 1/2 inch floppy drive 1.44 Mbyte.

(4) 1 Gigabyte or greater hard disk drive. EIDE or SCSI based PCI interface preferred.

(5) 15 or 17 inch SVGA color monitor (PCI interface preferred) and 101 key enhanced keyboard.

(6) Operating system software: Windows 95 highly preferred. DOS 6.22 or higher and Windows for Workgroups 3.11 or higher is acceptable only if required by the eddy current software.

Documentation:

(1) Full electrical and mechanical drawings for all system components.

(2) Operating and maintenance manuals for all system components.

Appendix D
Properties of MACOR®

Supplied by:

Accuratus Corporation
H.D. 4, Brass Castle Road, Washington, New Jersey 07882
(908) 6890850 Fax (908) 689-8794

MACOR® - (Isotropic Glass - Ceramic)

MACOR® is cast as a fluorine rich glass with a composition approaching that of trisilicic fluorophlogopite mica ($\text{KMg}_3\text{AlSi}_3\text{O}_{10}\text{F}_2$). Upon cooling from the melt, the glass spontaneously phase separates into fluorine rich droplets. Subsequent controlled heating to devitrify the glass causes a series of morphological changes ultimately resulting in the formation of randomly oriented, sheet-like fluorophlogopite mica crystals in the aluminoborosilicate glass matrix. The volume percent crystallinity after heat treatment is approximately 55% with an average grain size of less than 20 microns.

MACOR® possesses a number of interesting material properties, one of which is its machinability using standard metal working tools. It is a fully dense body requiring no firing after machining so that tolerances of .0005" are easily maintained. It has a very high dielectric strength and moderate dielectric constant. It exhibits good thermal shock resistance and fracture toughness when compared to glasses with similar mechanical and thermal properties.

MACOR® is usable in an air atmosphere to 1000°C. In vacuum systems, where the temperature exceeds 600°C, fluorine is evolved. This is a temperature dependent phenomenon with BF_3 forming initially followed by HF as the fluorine reacts with residual water in the system. MACOR® is attacked by halogen acids at elevated temperatures but shows a much lower weight loss when exposed to sodium hydroxide. Alkali salts have a negligible effect. Some applications for MACOR® include high voltage insulators and feedthroughs, thermal insulators, complex geometry high temperature mechanical supports and biocompatible implants.

The following technical data were obtained by Corning Glass Works.

<u>ATTRIBUTE</u>	<u>TEST METHOD/ MEASUREMENT*</u>	<u>VALUE</u>
PHYSICAL		
Bulk Density	g/cm ³	2.52
Hardness	Knoop 100g	250
Melting Point		Not Applicable
Color		White
Crystal Morphology		45% vitreous 55% monoclinic
MECHANICAL		
Young's Modulus	10 ⁶ psi	9.3
Compressive Strength	10 ³ psi	50
Flexural Strength	10 ³ psi	13.6
Poisson's Ratio		0.26
THERMAL		
Thermal Conductivity	W/mEK	1.7
Specific Heat	cal/g.EC	0.18
Coefficient of Expansion	10 ⁻⁶ /EC (25°C-400EC)	9.4
Maximum Use Temperature	No Load	1000°C
ELECTRICAL		
Dielectric Constant	10KHz	5.92
	8.6GHz	5.68
Dielectric Loss Tangent	10KHz	0.003
	8.6GHz	0.007
Dielectric Strength	1/4" thick	450
	volts/.001" (A.C.)	
Volume Resistivity	ohm.cm ² /cm(D.C.)	>10 ¹⁴
Te Value	Volume Res.=10 ⁶ ohm	>500EC

*Room temperature values except as noted

Appendix E

Mechanical Drawing of Standard RFC Calibration Block and Modifications for Wire Artifact Process

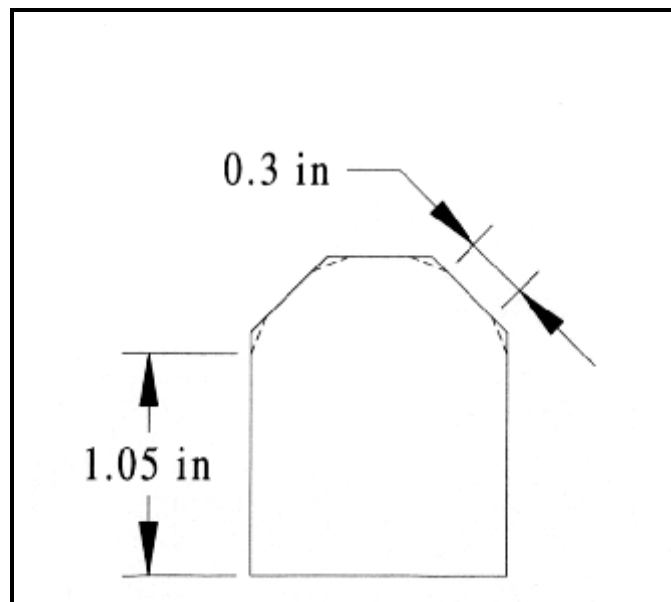
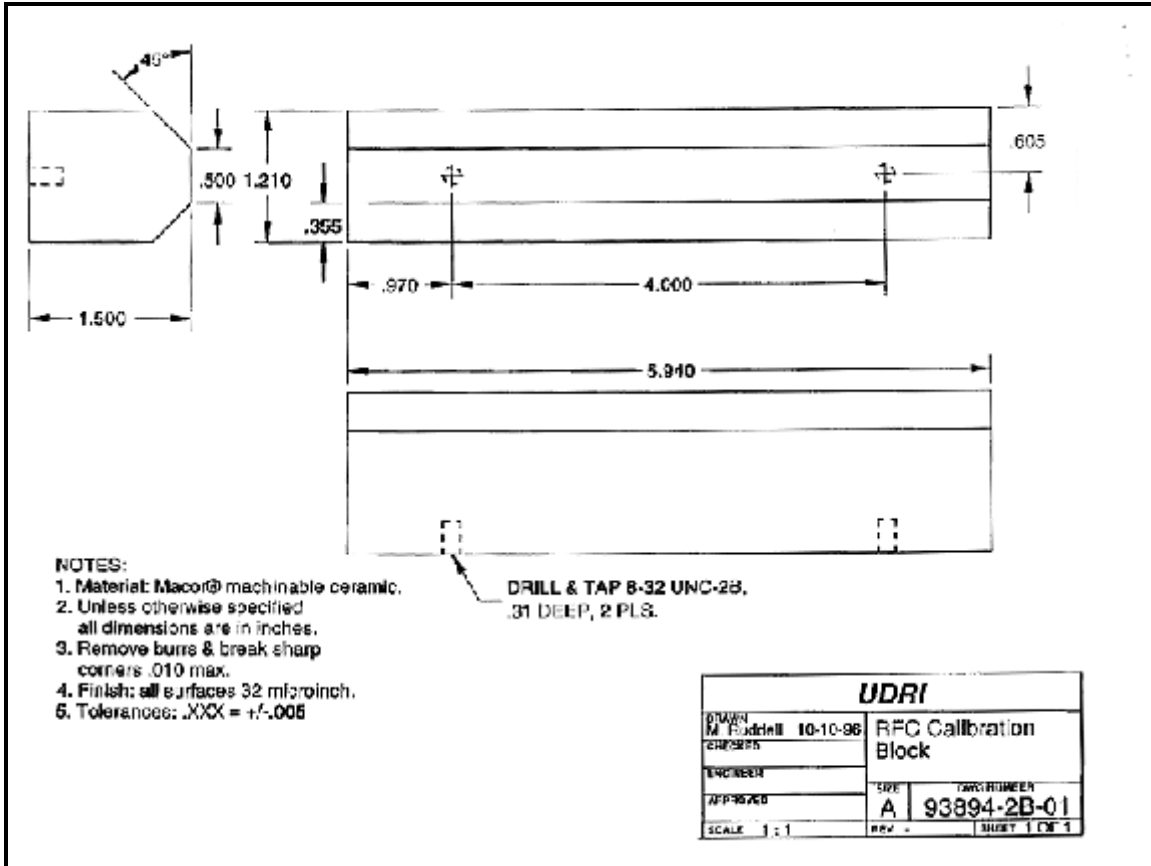

NOTCH DETAIL

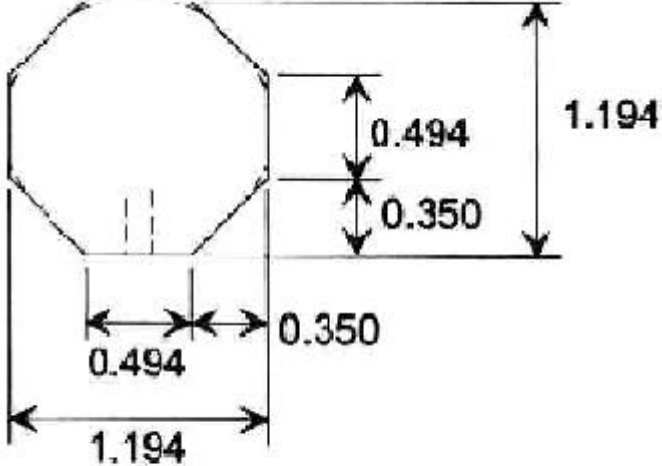
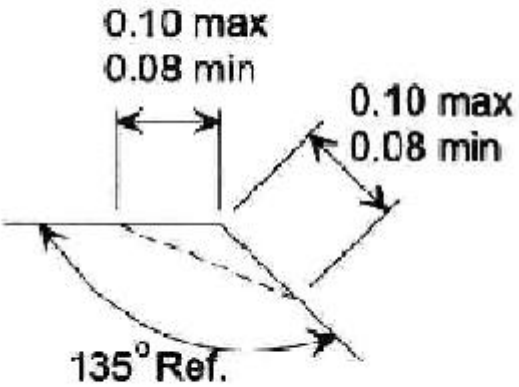

⌀

Appendix F Reliability Test Results

**Waspaloy (PWA-1016) Flat Plate, Scan Plan: IN100-FP-20T, Transverse
2 MHz Probe #872, Threshold: 100Data Acquired: 10-12 June 1998**

Probe S/N 15077		Calibration Block						
Set	S/N	Surface	Depth	Master-7	B09-7	B11-7	B12-7	B16-7
A	1	Top	6.7	310	352	356	304	374
	3	Top	9.3	642	616	613	635	646
	5	Bottom	13.9	1106	1097	1120	1077	1243
	7	Top	21.1	3137	3176	3216	3142	3309
	9	Bottom	10	665	655	690	682	711
	10	Top	6	233	268	261	221	267
	11	Bottom	15.2	1060	1084	1091	1073	1249
	13	Top	8.7	375	394	387	386	407
B	14	Bottom	6	211	218	236	226	262
	15	Top	17.8	1892	1843	1833	1906	1948
	17	Bottom	10.6	787	779	813	828	870
	20	Top	13.2	1199	1205	1176	1246	1232
	21	Bottom	5.4	371	350	324	393	403
	22	Top	23	4073	4078	4060	4222	4245
	23	Top	11.9	911	914	953	949	972

Probe S/N 15078		Calibration Block						
Set	S/N	Surface	Depth	Master-8	B09-8	B11-8	B12-8	B16-8
A	1	Top	6.7	337	399	411	336	418
	3	Top	9.3	732	781	772	884	906
	5	Bottom	13.9	1020	1242	1198	1303	1276
	7	Top	21.1	3378	3340	3171	3360	3917
	9	Bottom	10	716	871	842	798	882
	10	Top	6	243	279	298	316	274
	11	Bottom	15.2	1293	1414	1365	1446	1565
	13	Top	8.7	457	465	440	462	483
B	14	Bottom	6	283	284	283	248	350
	15	Top	17.8	2219	2328	2225	2367	2660
	17	Bottom	10.6	832	875	819	1011	945
	20	Top	13.2	1564	1655	1555	1679	1630
	21	Bottom	5.4	401	441	377	425	466
	22	Top	23	4541	4845	4596	4515	5199
	23	Top	11.9	1100	1191	1166	1243	1419

Waspaloy (PWA-1016) Flat Plate, Scan Plan: IN100-FP-20T, Transverse
6 MHz Probe # 4005, Threshold: 100 **Data Acquired: 8 July 1998**

Probe S/N 13652		Calibration Block						
Set	S/N	Surface	Depth	Master	B09	B11	B12	B16
A	1	Top	6.7	351	342	332	312	342
	3	Top	9.3	600	591	557	570	648
	5	Bottom	13.9	1059	1093	1046	1051	1097
	7	Top	21.1	2860	2906	2764	2761	2921
	9	Bottom	10	576	584	559	551	593
	10	Top	6	227	251	236	216	234
	11	Bottom	15.2	1100	1107	1029	1045	1107
	13	Top	8.7	346	362	328	346	366
B	14	Bottom	6	228	229	240	217	245
	15	Top	17.8	1784	1986	1983	1957	2047
	17	Bottom	10.6	771	737	740	745	791
	18	Bottom	7.3	389	383	381	382	410
	20	Top	13.2	1157	1294	1297	1260	1356
	21	Bottom	5.4	367	358	378	362	362
	22	Top	23	3428	3778	3777	3745	4007
	23	Top	11.9	810	911	901	897	984

Probe S/N 13653		Calibration Block						
Set	S/N	Surface	Depth	Master	B09	B11	B12	B16
A	1	Top	6.7	344	390	322	335	325
	3	Top	9.3	600	723	609	642	607
	5	Bottom	13.9	965	934	863	924	927
	7	Top	21.1	3138	2929	2662	2863	2662
	9	Bottom	10	525	679	560	558	587
	10	Top	6	320	261	248	268	244
	11	Bottom	15.2	1111	1085	1000	1086	1006
	13	Top	8.7	340	402	393	418	350
B	14	Bottom	6	234	231	213	230	250
	15	Top	17.8	2105	1747	1766	1745	1751
	17	Bottom	10.6	685	656	674	683	637
	18	Bottom	7.3	378	414	400	369	380
	20	Top	13.2	1432	1222	1248	1233	1194
	21	Bottom	5.4	359	368	352	348	337
	22	Top	23	4152	3601	3655	3639	3608
	23	Top	11.9	981	890	894	924	872

Appendix G

Results of the Eddy Current Probe Shoe Wear Tests on the Surface of the MACOR® Substrate, Wire Artifact, Calibration Blocks

NT-2000 Vertical Scanning Interferometry

- Light reflected from a reference mirror combines with light reflected from a sample to produce interference fringes.
- In VSI mode, white-light is not filtered, and the degree of fringe modulation, or coherence, is measured. This differs from Phase-Shifting Interferometry where the phase of the interference fringes is measured.

Inspection setup performance specifications

- Magnification 2.5X
- Field of view 2.4 mm x 1.8 mm
- Spatial sampling interval 3.92 μm
- Vertical resolution 3 nm

Calibration Artifacts subjected to the “wear test” were inspected at prescribed intervals:

1000, 5,000, 10,000, 50,000, 100,000, and 200,000 cycles.

Inspections included the direction of the scanning probe shoe and transverse to scanning shoe.

Surface Profile after 100,000 cycles

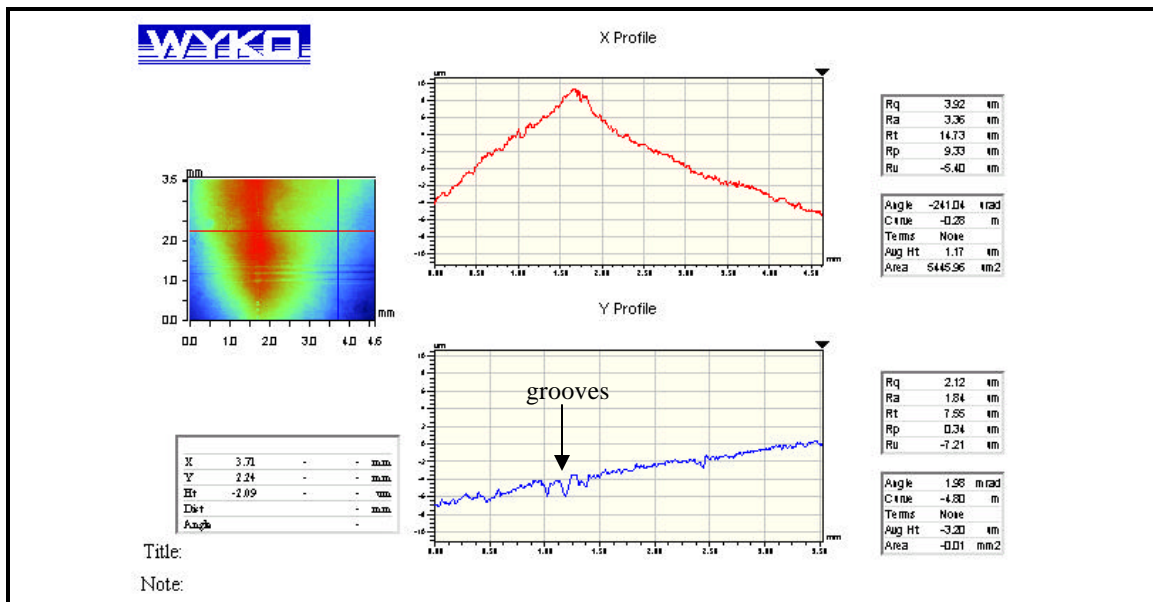

Notes: The red profile was taken along the long axis of the block. The peak represents the wire artifact protruding approximately 0.014 mm (~ 0.0005 inches) above the surface of the block. The blue profile was taken perpendicular to the probe shoe scanning path. Three grooves are evident. The two deepest grooves are approximately 0.002 mm (~ 0.00008 inches) deep.