



NRL/MR/6180--01-8552

Development of DC-ARM Reflexive Smart Valve

TOM LESTINA
MELISSA BRADLEY
RYAN DOWNS
ERIC RUNNERSTROM

*MPR Associates
320 King Street
Alexandria, VA*

ARTHUR DURKIN
FREDERICK W. WILLIAMS

*Navy Technology Center for Safety and Survivability
Chemistry Division*

JOHN FARLEY

*GEO Centers, Inc.
4640 Forbes Boulevard, Suite 130
Lanham, MD*

May 7, 2001

20010608 042

REPORT DOCUMENTATION PAGE

Form Approved
OMB No. 0704-0188

Public reporting burden for this collection of information is estimated to average 1 hour per response, including the time for reviewing instructions, searching existing data sources, gathering and maintaining the data needed, and completing and reviewing the collection of information. Send comments regarding this burden estimate or any other aspect of this collection of information, including suggestions for reducing this burden, to Washington Headquarters Services, Directorate for Information Operations and Reports, 1215 Jefferson Davis Highway, Suite 1204, Arlington, VA 22202-4302, and to the Office of Management and Budget, Paperwork Reduction Project (0704-0188), Washington, DC 20503.

1. AGENCY USE ONLY (Leave Blank)	2. REPORT DATE May 7, 2001	3. REPORT TYPE AND DATES COVERED July 1999—June 2000	
4. TITLE AND SUBTITLE Development of DC-ARM Reflexive Smart Valve			5. FUNDING NUMBERS PE - 0603508N
6. AUTHOR(S) Tom Lestina,* Melissa Bradley,* Ryan Downs,* Eric Runnerstrom,* Arthur Durkin, Frederick W. Williams, and John Farley**			
7. PERFORMING ORGANIZATION NAME(S) AND ADDRESS(ES) Naval Research Laboratory Washington, DC 20375-5320			8. PERFORMING ORGANIZATION REPORT NUMBER NRL/MR/6180--01-8552
9. SPONSORING/MONITORING AGENCY NAME(S) AND ADDRESS(ES) Office of Naval Research Arlington, VA 22217-5660			10. SPONSORING/MONITORING AGENCY REPORT NUMBER
11. SUPPLEMENTARY NOTES *MPR Associates, 320 King Street, Alexandria, VA **GEO Centers, Inc., 4640 Forbes Boulevard, Suite 130, Lanham, MD 20706			
12a. DISTRIBUTION/AVAILABILITY STATEMENT Approved for public release; distribution is unlimited.			12b. DISTRIBUTION CODE
13. ABSTRACT (Maximum 200 words) The development of a smart valve, which automatically detects and isolates a rupture in a shipboard fluid system, is discussed. The hardware design is based on commercial components consisting of pressure sensors embedded in the inlet and outlet of the valve and a microprocessor and a communication transceiver embedded in the valve actuator. The smart valve software detects and isolates a rupture using the embedded pressure data even if communication beyond the smart valve is severed. Concept smart valves installed in a shipboard fire main isolated test ruptures in times ranging from 15 to 90 s. With software modifications, the existing fire main smart valve can isolate ruptures within 30 s. Development of hydraulic circuit breaker software and improvements in differential pressure signal processing are needed to further reduce the rupture isolation times and to improve the sensitivity of the leak detection. Initial proof-of-concept tests indicate that these developments can be made using the smart valve architecture. With these improvements, the smart valve concept can be extended to other shipboard fluid systems such as chilled water and fuel systems.			
14. SUBJECT TERMS Shipboard fluid system Rupture Smart valve Distributed control			15. NUMBER OF PAGES 46
			16. PRICE CODE
17. SECURITY CLASSIFICATION OF REPORT UNCLASSIFIED	18. SECURITY CLASSIFICATION OF THIS PAGE UNCLASSIFIED	19. SECURITY CLASSIFICATION OF ABSTRACT UNCLASSIFIED	20. LIMITATION OF ABSTRACT U1

CONTENTS

1.0	Summary	1
2.0	Introduction	5
2.1	Background	5
2.2	Purpose and Scope	6
3.0	Approach	7
3.1	Functional Requirements	7
3.2	Reflexive Fluid System Software Architecture	8
3.3	Smart Valve Hardware Architecture	11
3.4	SHADWELL Fireman Configuration	16
4.0	Results and Discussion	19
4.1	SHADWELL Fireman Test Results	19
4.2	Design of Damage Tolerant Shipboard Fluid Systems Using Smart Valves	36
4.3	Areas of Continuing Work	37
5.0	Conclusions	39
6.0	References	41

FIGURES

<u>Figure</u>		<u>Page</u>
1	Schematic Configuration of DC-ARM Smart Valve	4
2	Estimated Performance Capability for Smart Valve Technologies	5
3	Software Architecture for Reflexive Fluid Systems	10
4	Model of Fire Main Smart Valve on SHADWELL	14
5	SHADWELL Fireman in the Test Area	18
6	Closure Time Delays for Fireman Smart Valves During Initial Rupture Tests	25
7	Pressure Traces for Operations Office Rupture with Fire Pump 2 Operating	27
8	Pressure Traces for Operations Office Rupture with Fire Pump 1 Operating	28
9	Pressure Traces for Magazine Sprinkling Actuation	30
10	Pressure Traces and Flow Rate Measurements for Small Leak Test	33
11	Pressure Traces for Operations Office Rupture with Zero Time Delay and No Data Averaging	35

TABLES

<u>Table</u>		<u>Page</u>
1	SHADWELL Fireman Smart Valve Specifications.....	13
2	Components of DC-ARM Fireman Smart Valve on SHADWELL.....	15
3	Test Matrix for Fireman Reflexive Smart Valves.....	19
4	Smart Valve Pressure Measurements for Zero Flow Tests.....	20
5	Smart Valve Differential Pressure Measurements for Flow Tests.....	22
6	Smart Valve Apparent Flow Coefficients for Flow Tests.....	23
7	Magazine Sprinkling Flow Rates on SHADWELL Fireman	29
8	Smart Valve Differential Pressures and Flow Rates for Small Leak Tests.....	32

Development of DC-ARM Reflexive Smart Valve

1.0 Summary

A DC-ARM reflexive smart valve is an assembly of valve and control components for shipboard fluid systems capable of automatically isolating piping damage. Reflexive smart valve technology is used to reduce the time to detect a leak or rupture and reduce the burden on ship personnel. The valve contains the following features:

- Commercial valve and actuator combination suitable for shipboard fluid systems,
- Microprocessor and communication transceiver embedded in the valve actuator,
- Pressure sensors embedded in the valve body inlet and outlet,
- Control logic embedded in the device microprocessor which can operate the valve based on commands from a remote supervisory station,
- Rupture detection and isolation logic which can operate the valve following a damage event based on local data when communication beyond the smart valve is severed, and
- Communication with a remote supervisory control station system and/or an optional system controller.

The schematic configuration of a smart valve is shown in Figure 1. Multiple valve types e.g. (butterfly, globe, gate and ball) may be used as long as a detectable pressure drop is available. The actuator can be motor-operated, solenoid-operated, pneumatic, or hydraulic depending on the application and closing time requirements. The valve control circuit board and associated software are provided by the valve manufacturer. The applications circuit board hardware is provided by the valve manufacturer and the software is provided by the system designer. Layering of rupture logic software may be used to provide a defense-in-depth approach when multiple simultaneous failures are experienced. Elements of leak detection logic may be included in the application circuit board depending on the application.

Testing of a concept smart valve has been performed on the fire main aboard the ex-USS SHADWELL (LSD-15) [1]. The smart valves successfully isolated a rupture with isolation times ranging from 15 seconds to 90 seconds. In addition, the smart valves were able to distinguish between a rupture and other transients such as actuation of vital loads and a pump trip. Following actuation of a vital load and a pump trip, smart valves operated as designed and remained open. Modifications to the pressure averaging algorithm and time delay software can reduce the isolation times to less than 30 seconds with the existing configuration on the SHADWELL fire main.

These initial rupture tests indicate that the pressure measurements provide a sensitive indication of changes in the fluid system, possibly enabling the performance of the smart valve capabilities to be extended. To test the limits of the technology, initial concept tests for fast-acting rupture isolation and small leak detection were performed. For a zero time delay rupture test, only the smart valves nearest the rupture closed. For a small leak test, flow rates as low as 10 gpm were detected by the smart valve nearest the leak location. These results are promising and indicate that the capabilities of the existing smart valve hardware and software can be expanded substantially.

The estimated performance of the various technologies for the Damage Control-Automation for Reduced Manning (DC-ARM) reflexive smart valve is shown in Figure 2. The technology for the DC-ARM smart valve is a trade-off between leak size and time to detect and isolate damage; therefore, flow detected is plotted against time to detect and isolate a rupture. Flow detected is represented as a percentage of pipe capacity (or maximum flow rate in the pipe). The time to detect and isolate a rupture is shown over

flow detected is plotted against time to detect and isolate a rupture. Flow detected is represented as a percentage of pipe capacity (or maximum flow rate in the pipe). The time to detect and isolate a rupture is shown over a range that includes very fast acting valves to slow manual response. With sufficient time, roving patrols (or other ship personnel) will be able to identify and correct for leaks. Shipboard experience, tests, and analyses demonstrate that, in many instances, this method cannot reliably locate a leak in less than 20 minutes [2]. For smaller leaks, personnel may not locate the leak for hours. Smart valve technology provides a substantial performance improvement to a manned response of a rupture¹, and it may provide a cost-effective alternative to commercial leak detection methods for some fluid system leaks². The smart valve performance diagram, Figure 2, is subdivided into the following regions based on the types of software methods used:

- Current Hydraulic Resistance Logic ($\geq 10\%$ pipe capacity flow detection, ≥ 30 second isolation time). This method uses "almost" steady embedded pressure data and device-level rupture logic to detect and isolate a rupture. Current hydraulic resistance logic detects a rupture when the local pressure decreases below a setpoint and flow rate increases above its setpoint. Once a rupture is detected, a valve closure sequence is initiated such that valves furthest from the operating pumps (and nearest the rupture) close first. Hydraulic resistance logic is limited to the analysis of almost steady pressure data with isolation times greater than 30 seconds for multi-valve and multi-pump piping systems typical for shipboard fluid systems. Hydraulic resistance logic has been successfully tested and is considered ready for prototype shipboard implementation.
- Enhanced Hydraulic Resistance Logic (1% pipe capacity \leq flow detected $\leq 10\%$ pipe capacity, ≥ 30 second isolation time). This method uses almost steady embedded pressure measurements and system level logic in addition to the device level rupture logic. Enhanced hydraulic resistance logic uses accurate flow measurements and flow inventory logic (system level logic) to detect and locate ruptures and leaks. Performance capability for enhanced hydraulic resistance logic is estimated because improvements in pressure sensor calibration and signal processing methods are needed to confirm the performance capability. Smart valve technology may provide a substantial cost reduction in flow measurement compared to existing industrial flowmeters.
- Hydraulic Circuit Breaker Logic ($\geq 1\%$ pipe capacity flow detection, 0.1 second \leq isolation time ≤ 30 seconds). This method consists of applying analysis of transient pressure signal data and fast acting actuators. Only an initial concept test of hydraulic circuit breaker logic has been performed and development of software is needed along with improvements in pressure signal processing. Performance capability for hydraulic circuit breaker logic is estimated because development and testing are needed to confirm the performance capability.
- Commercial Leak Detection ($< 1\%$ pipe capacity flow detection, ≥ 30 -1200 second isolation time). This method consists of applying commercial leak detection sensors/methods on or in the immediate vicinity of smart valves. The sensors could be hydrocarbon detectors to detect leaks at flanged joints or acoustic sensors to "listen" for system leaks. The performance capability is approximated based on a review of commercial literature. The U.S. Environmental Protection Agency requirement for gross leak detection is 3 gallons per hour [3]. Applying commercial leak detection methods with smart valves has not been tested.

¹ A rupture is a separation of pipe caused by a damage event. As a benchmark estimate, a smart valve can detect a rupture if it can detect a change in flow greater than 10% of the pipe capacity.

² A leak is any unintended discharge from a fluid system that is not a rupture. For this report, a smart valve can detect some leaks if it can detect a change in flow less than 10% of the pipe capacity.

Based on the overall functional requirements for a particular system, smart valve technology can influence overall architecture (zonal, offset loop, single main, dual main), the number and location of pumps, the size of tanks, and control methods.

Fireman System

The DC-ARM smart valve [4,5] is ready for prototype fire main installation on an active duty Navy ship. The hardware and software architecture used on the SHADWELL is appropriate for a prototype valve. Compared to the existing smart valves installed on the SHADWELL, a different actuator model would be selected, the circuit boards would need to be qualified for shipboard environment and software improvements would be added to reduce the rupture isolation time and improve the reliability.

Chilled Water System

A smart valve could be developed for a chilled water system using hydraulic circuit-breaker logic for rupture detection and enhanced hydraulic resistance logic for leak detection (using flow inventory system logic)[6,7,8]. The reliability and survivability may be improved by implementing hydraulic resistance logic in addition to hydraulic circuit breaker logic for rupture isolation. This software could be integrated with system level logic to detect small leaks in time to prevent the system from failing due to loss of fluid.

Fuel System

A smart valve could be developed for fuel systems using hydraulic circuit-breaker logic for rupture detection and a hydrocarbon sensor (or other method) for small leak detection. The reliability and survivability may be improved by implementing hydraulic resistance logic in addition to hydraulic circuit breaker logic for rupture detection and enhanced hydraulic resistance logic in addition to the hydrocarbon sensor for leak detection.

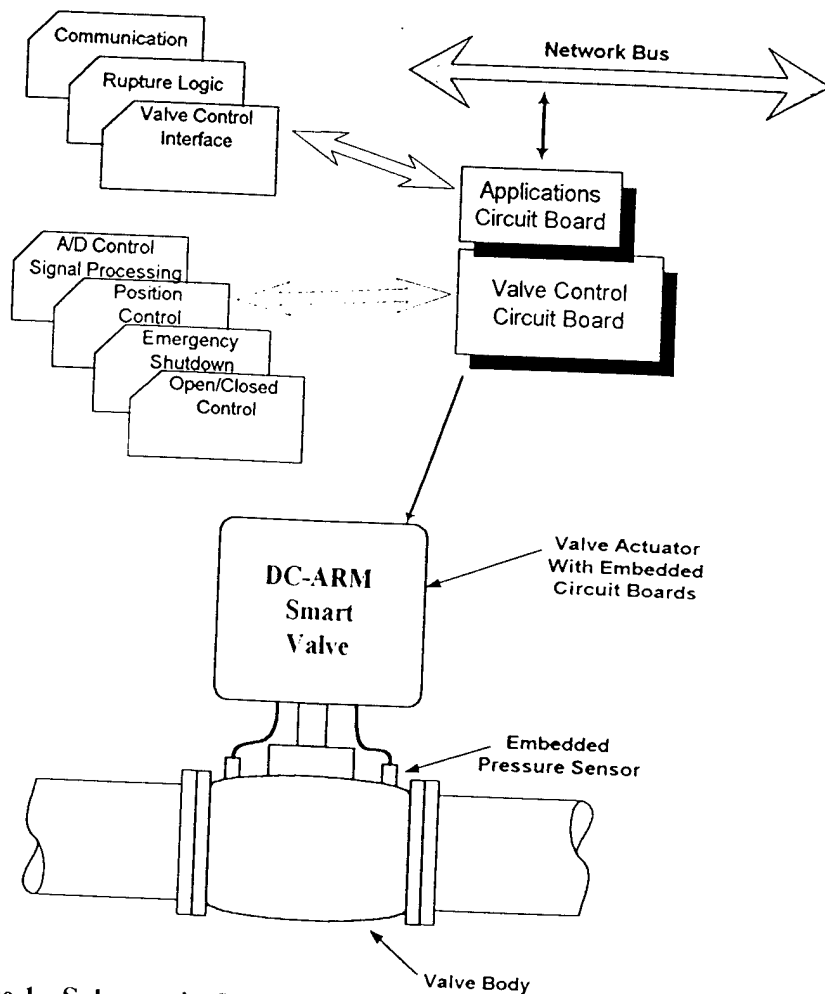

Figure 1. Schematic Configuration of DC-ARM Smart Valve

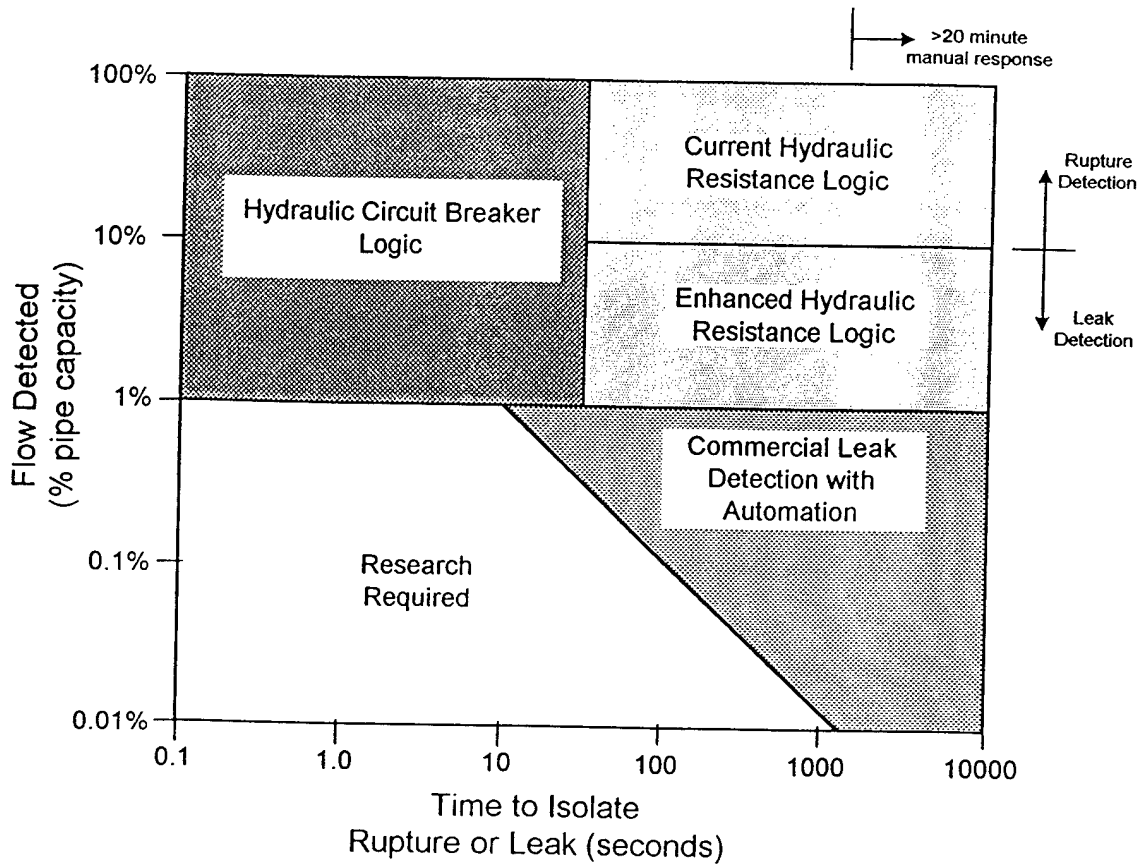

Figure 2. Estimated Performance Capabilities for Smart Valve Technologies

2.0 Introduction

2.1 Background

The overall objective of the Damage Control Automation for Reduced Manning (DC-ARM) reflexive fluid systems development is to demonstrate unmanned isolation of fluid system damage while restoring service to intact sections and vital loads.

To meet this overall objective, the general approach has been to survey commercial technology which can be applied to automated damage recovery of shipboard fluid systems. Where possible, applicable commercial technology has been used or adapted to meet the Navy requirements. Development of new technology has been started in a cooperative arrangement with commercial suppliers where commercial suppliers is to use existing commercial research and development programs to develop products suitable for both Navy ships and commercial industrial facilities.

The fire main system has been selected as the first prototype for DC-ARM reflexive system development. Two interim reports of the reflexive system development have been published [4], evaluates fire main architectures including offset loop, dual main, and zonal configurations. The results of the

evaluation indicate that the implementation of a particular architecture involves a trade-off between the number of pumps and the number of segmentation valves. The selection of architecture should be the subject of the ship design. Consequently, the DC-ARM program focused on the development of smart valve technology that can be used in any fluid system architecture. Reference 4 concluded that development of a smart valve which can detect and isolate a rupture using only local information is needed. This development has been divided into two parts consisting of (1) development of a concept valve and actuator package with embedded sensors and microprocessors and (2) development of logic which can be applied at a device microprocessor using data measured in the immediate vicinity of the valve.

An evaluation of device level rupture detection and isolation logic is discussed in the second interim report [5]. Four different methods to evaluate hydraulic data (pressure and flow) were investigated based on a commercial survey and benchtop model testing. The results indicate that logic based on hydraulic resistance is the most suitable method to detect a rupture. Using hydraulic resistance, a rupture is detected if pressure decreases below a setpoint and differential pressure increases above a setpoint. Based on a preset time delay³, the valve closes if rupture conditions persist. With this logic and closure sequencing, a rupture can be isolated without isolating intact piping sections. The key feature of hydraulic resistance logic is that communication to remote personnel or other components is not required after damage has occurred.

In parallel with the assessment and development of rupture detection and isolation logic, Tyco® Flow Controls agreed to develop a concept smart fire main valve. The valve would be based on the existing development program at Tyco® to use network communication and microprocessor control with their existing product line of valves. To meet the reflexive fire main smart valve requirements, the design for a new network interface card was modified to accept the pressure sensor inputs. The Vanessa® model valve was selected for embedding pressure sensors since it already was under evaluation for shipboard fire main applications.

The Naval Sea Systems Command, Philadelphia Code 825 has been developing automated survivable shipboard fluid system concepts for the last several years. For the FRMS Program (Fireman Reconfiguration Management System), flow balance logic was demonstrated on the ex-USS SHADWELL fire main [6,7,8]. A rupture between valves was detected when the flow imbalance in a pipe segment increased above a threshold. Once a rupture was detected, the valves closed. Application of this approach has been tested for a fire main installed at Aberdeen Proving Grounds as part of the Automated Systems Reconfiguration (ASR) program [9]. The results of the ASR testing indicate that the flow balance logic can identify rupture or large leak paths, but reliable and survivable communication between the valves is needed to ensure the rupture can be isolated.

2.2 Purpose and Scope

This report describes the initial results of the development of the DC-ARM smart valve. The architecture of the software and hardware for the smart valve is described, the reflexive fire main design on the ex-SHADWELL is summarized, results of initial testing of the concept smart valves are evaluated and a general procedure to design a reflexive fluid system based on the smart valve is discussed. These results

³ The time delay is established by the relative location of the valve to the operating pumps. Valves furthest from the operating pumps close first and valves near the operating pumps close last. With this valve sequencing, valves nearest the rupture close first.

can be used as a basis for the design of damage tolerant, automated shipboard fluid systems and for continuing work to further develop the smart valve technology.

3.0 Approach

This section discusses the functional requirements of a reflexive fluid system, software architecture for a reflexive fluid system, hardware and configuration for a smart valve.

3.1 Functional Requirements

The overall goal of developing a reflexive fluid system is to demonstrate the operation of the components and logic sequences which respond automatically to fluid system damage with multiple failures among components (including loss of communication between components after damage). The following functional objectives are based on previous reports [4,5] and form the basis of the DC-ARM reflexive fluid system research:

1. **Rupture Isolation.** The reflexive system should be able to isolate a rupture and restore system services to intact portions of the fluid system. The rupture isolation should be accomplished without increasing the safety hazard to ship personnel. For example, trial and error cycling of fire main valves to locate a rupture is not acceptable since fire main pressure may be temporarily lost to fire party personnel manning a hose. Fireman ruptures should be isolated and service restored in less than 9 minutes to ensure that fire main is available before fire spreads to adjacent compartments [2].
2. **No Manned Intervention.** The system should perform damage isolation and service restoration actions without manned intervention.
3. **Tolerant of Multiple Failures and Degradation.** The system should be able to operate successfully with failures of more than one valve or pump in addition to other degradation expected in shipboard fluid systems. Loss of communication among components following damage should be considered in addition to other failures. Other degradation mechanisms such as buildup of fouling product (corrosion and biological) should be considered along with equipment malfunctions.
4. **Leak Detection.** Leak detection should be implemented to alert ship personnel to potentially deteriorating or hazardous conditions. The consequences of leaks are different for different shipboard fluid systems. For fuel service, a small leak (less than 1 gpm) is a substantial fire hazard within a few minutes. For fire main operation, detecting smaller leaks is not considered critical to reflexive system operation because the flow rates to fire main services remain adequate and fire main pressures are not reduced for small leaks which are not caused by the rupture of piping. For chilled. The system should water systems, small leaks can disable the system if the tanks are emptied; however, more time for detection is available for smaller leaks than larger leaks. (Previous discussions of reflexive fluid system requirements did not include leak detection because the initial work was focused on the fire main system where a small leak does not have critical consequences.)
5. **Simple and Reliable Design.** The system should isolate damage and restore services with a minimum number of components and with a design based on proven technology that is straightforward to implement. In general, simple designs contain fewer components and minimal processing requirements for the component level controller. Simple designs generally are less expensive to implement and maintain and more reliable.
6. **Low Cost.** The system must have a low life cycle cost. The maintenance effort must be kept to a minimum to meet manning objectives for future ships. Reducing the number of active components in the system will help minimize life cycle cost.

3.2 Reflexive Fluid System Software Architecture

To meet the functional requirements, a system designer performs a trade-off between distributed control using smart technology and centralized control using redundant components and subsystems. Factors which affect the trade-off analysis are status of commercial technology, ship performance requirements (including reliability and survivability) and cost. Since each of these factors will change for different ship designs, it is impractical for DC-ARM to provide a standard software design for shipboard fluid systems. Instead, an overall goal of the DC-ARM program is to provide the ship designer the necessary tools to develop a design using smart technology.

The general approach used in the DC-ARM fluid systems program is to demonstrate smart technology which distributes analysis and control logic in a manner that results in a reliable, low cost and survivable design. This does not mean that components are automated such that all decisions are made at the component level. Instead, decisions based on local, subsystem data are made at the component level, decisions based on system wide data are made at the system level and decisions based on overall ship conditions and mission are made at the supervisory level. The architecture based on this breakdown of decisions is shown in Figure 3.

At the fluid system component level, decisions based on data available within the equipment housing or in the immediate vicinity are incorporated into device logic. For valves, control logic associated with open/close travel stops (e.g., limit switches, potentiometers), safety cutout limits (over temperature protection for motor operators) and automated position control (for flow and fluid temperature control) are typically provided for commercial valve and actuator installations. For reflexive fluid systems, software in addition to typical commercial software is needed. This additional software provides signal conditioning (filtering, A/D conversion and conversion to engineering units), rupture detection and isolation and self-diagnostic checks (including prognostic diagnostics for condition based maintenance). For the DC-ARM program, each of these logic methods will be demonstrated except for the self-diagnostic checks.

Pump logic is similar to valve logic in that speed control (associated with pump starts and pressure control) and safety cutout limits (over-current and over-temperature protection) are typically provided with commercial pump controllers. For reflexive systems, additional software is needed to provide for automatic starts and stops, signal conditioning and self-diagnostics. For the DC-ARM program, each of these logic methods will be demonstrated except for self-diagnostic checks.

Instrument logic is different than pump and valve logic since control logic is not needed. Signal conditioning is typically provided with commercial industrial instruments to provide output in engineering units. For reflexive systems, additional software should be provided to permit data trending and analysis (e.g., alarm and alert setpoints) and self-calibration. For the DC-ARM program, only commercial signal conditioning will be demonstrated.

Fluid system level logic analyzes the data from remote portions of the system and/or from multiple compartments. Unlike component level logic, system level logic relies upon uninterrupted communication for successful operation. For shipboard fluid systems, system level logic is used to analyze the overall system alignment including valve positions for segregated and open configurations, vital load demand and status, pump status and flow distribution. In addition, leak detection is considered to be system logic because available commercial technology relies upon comparison of data from subsystem boundaries.

Supervisory logic provides the primary man-machine interface for the fluid system. To support this interface function, decision aids may be included to provide recommendations for system realignment to support mission requirements and anticipated damage threat. In addition, analysis of system-to-system interactions may be provided.

The hardware configuration need not match with the logical hierarchy shown in Figure 3. For instance, system level logic can be embedded in the component microprocessor, installed in a dedicated controller, or installed in the supervisory station. For the SHADWELL fire main system, only component level logic will be embedded in the smart components. System level and supervisory logic is installed in the supervisory control station in the SHADWELL Control Room and/or Damage Control Central (DCC).

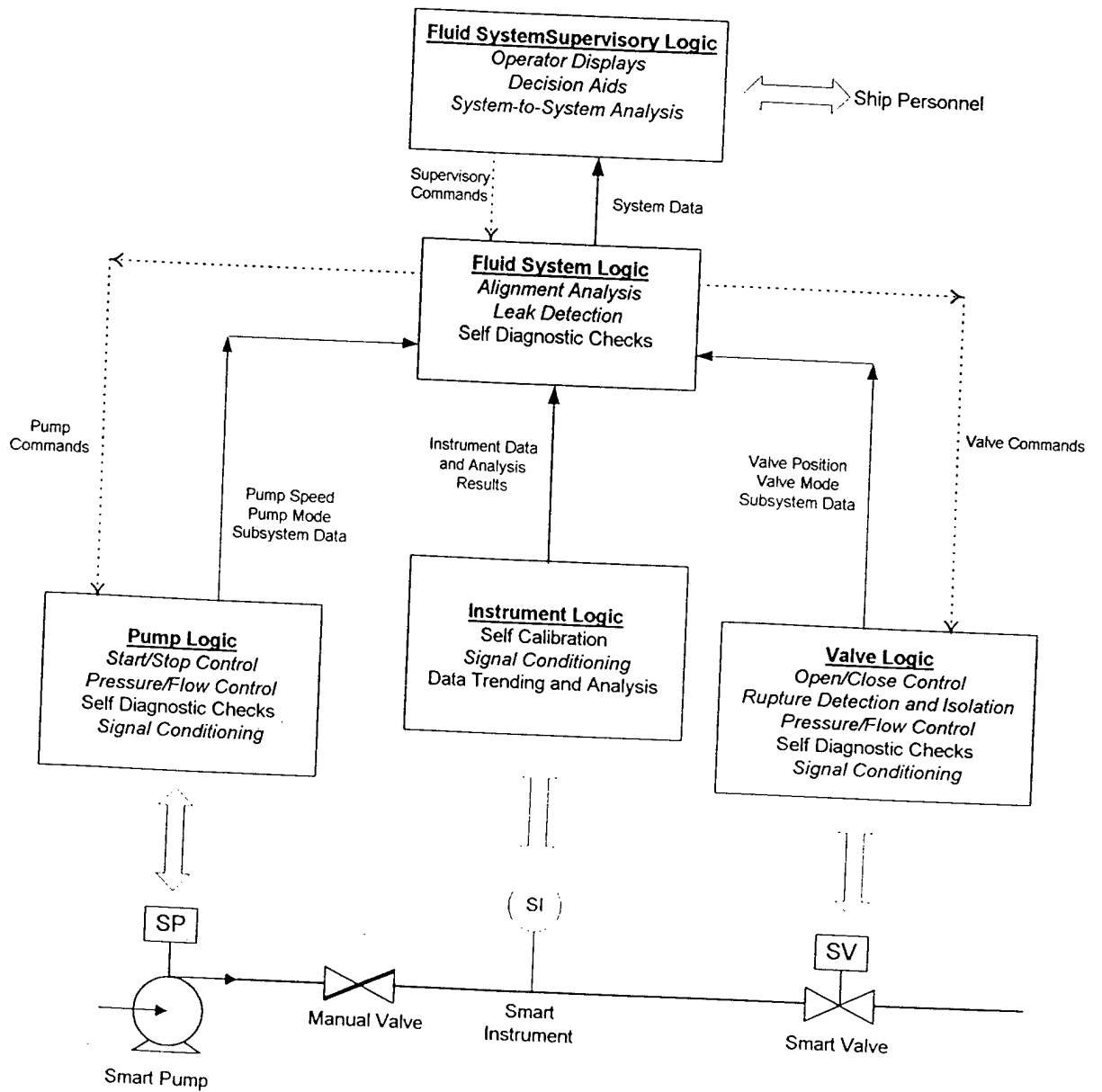

Logic shown in italics has been or will be demonstrated on SHADWELL

Figure 3. Software Architecture for Reflexive Fluid Systems

3.3 Smart Valve Hardware Architecture

The most survivable approach to implement valve logic is with a smart valve architecture consisting of pressure sensors embedded in the inlet and outlet of the valve body and an embedded circuit board in the valve actuator which contains a microprocessor and communication transceiver. When the DC-ARM program started, several commercial valve suppliers were able to provide valve and actuator packages with an embedded circuit board containing a microprocessor and network transceiver ready for a field bus connection. Developing improved capability using the embedded circuit card is an ongoing commercial initiative of several valve manufacturers. Installing embedded pressure sensors suitable for accurate differential pressure measurement to meet Navy requirements was considered to be an extension of this existing commercial initiative. The DC-ARM program has been working with several valve companies in a cooperative arrangement to develop a hardware configuration suitable for Navy shipboard installation. General functional and performance requirements are developed to ensure that the smart valve can adequately perform component level logic (such as rupture logic) and can interface with the system and supervisory level software.

Differential Pressure Measurement

The most important hardware feature which distinguishes the DC-ARM reflexive smart valve from existing commercial smart valves is the use of embedded pressure sensors to measure flow rate. The key design constraint is to provide independent measurement of upstream and downstream pressures (for open and closed valve positions) along with accurate measurement of small differences between upstream and downstream pressure when the valve is in the open position. A review of the sources of flow measurement error for the DC-ARM smart valve provides a basis for establishing a design for the pressure sensor configuration:

- **Factory Calibration.** The factory calibration of the pressure sensors consists of comparing the output of the sensors with calibrated pressure instruments. Based on this calibration data, limits of repeatability, non-linearity and hysteresis can be established. Alternatively, methods to correct for non-ideal calibration data can be developed to reduce the limits of error.
- **Flow Disturbances.** Disturbances such as tees and elbows within a few pipe diameters of the smart valve can introduce an error in the flow measurement. This error may be affected by the orientation of the valve and pressure sensors (such as in-plane or out-of-plane pressure sensor orientations). As discussed in Reference 4, this error is attributed to pipe tap effects and possible swirl effects which change the detected pressure at the sensor.
- **Sensor Drift.** Day-to-day temperature variations of the sensor circuits can result in drift in the sensor output. In addition, pressure cycling of the sensors (by opening and closing of the valve) can result in a drift in sensor output. While compensation for these effects is typically included in commercial sensors, small changes may be observed in the differential pressure measurements.
- **Variable Flow Coefficient.** The valve flow coefficient may vary with flow rate, fluid properties (such as density) and surface roughness of the upstream pipe and valve surface. Variations in the valve flow coefficient may introduce errors in the flow calculation performed by the smart valve.
- **Random Fluctuations.** All measurements are subject to variations that are not compensated and are random. These variations are attributed to unsteady process conditions and instrument effects. For smart valve pressure measurements, the random fluctuations are dominated by fluid turbulence.

Ideally, the design approach used for differential pressure measurements would be based on data for each of these factors. For practical development of the DC-ARM smart valve, best estimates of these factors are used to determine a suitable design for initial testing. For the first DC-ARM smart valves to be used on the SHADWELL fire main, it was decided to implement a straightforward approach with two commercial pressure sensors with a commercial analog-to-digital converter chip. Using these first valves, data would be measured to identify design improvements such as filtering or digital signal processing. Both factory tests and hydraulic characteristic tests on the SHADWELL fire main provide the foundation for determining design improvements [6-8].

SHADWELL Fireman Smart Valve Hardware

For testing and demonstration on the SHADWELL, the objectives for the smart valve are as follows:

- **Demonstrate Rupture Isolation.** The smart valve must be able to provide rupture isolation for credible damage scenarios. Reliable rupture isolation should be demonstrated within a time period which ensures the fire main is available to prevent the spread of fire from the initial damage area. To meet the general rupture isolation requirement, hydraulic resistance logic was selected since it can isolate a rupture without communication following damage and with multiple valve failures. The time available before fire spread is estimated to be approximately 9 minutes [10].
- **Facilitate Supervisory Interface.** The smart valve must be able communicate status information to the supervisory control station and accept commands from the supervisory control station.
- **Develop Performance Capability.** The data from the initial smart valve testing should be sufficient to identify the performance capability of a DC-ARM smart valve. Potential improvements in the smart valve capability should be identified.

Based on these general objectives for the initial smart valve on SHADWELL, the following specifications were developed:

Table 1
SHADWELL Fireman Smart Valve Specifications

<p>Size and Rating 4-inch flanged, ANSI 150 lb. Class</p>
<p>Pressure Sensor Location: inlet and outlet Low Setpoint: 50 psig Range and Accuracy: 0 to 200 psig, ± 1 psig</p>
<p>Flow Sensor Location: flow through valve High Setpoint: 100 gpm relative⁴ Range and Accuracy: 0 to 30 ft/s, ± 50 gpm,</p>

Implementation of shipboard shock and vibration requirements is not considered for the initial testing. Due to the environment on the SHADWELL during fire testing, it is desired (although not required for the initial tests) that the smart valve operate at temperatures up to approximately 200°F.

Discussions with Tyco® Flow Control Research and Development identified an approach to develop the DC-ARM smart valve concept for the SHADWELL fire main using an existing commercial valve and actuator product line. A model of the DC-ARM fire main valve is shown in Figure 4.

⁴The setpoint is based on relative hydraulic resistance logic [5]. The objective of relative hydraulic resistance is to detect an increase in flow rate greater than that of a fire hose which is about 90-100 gpm.

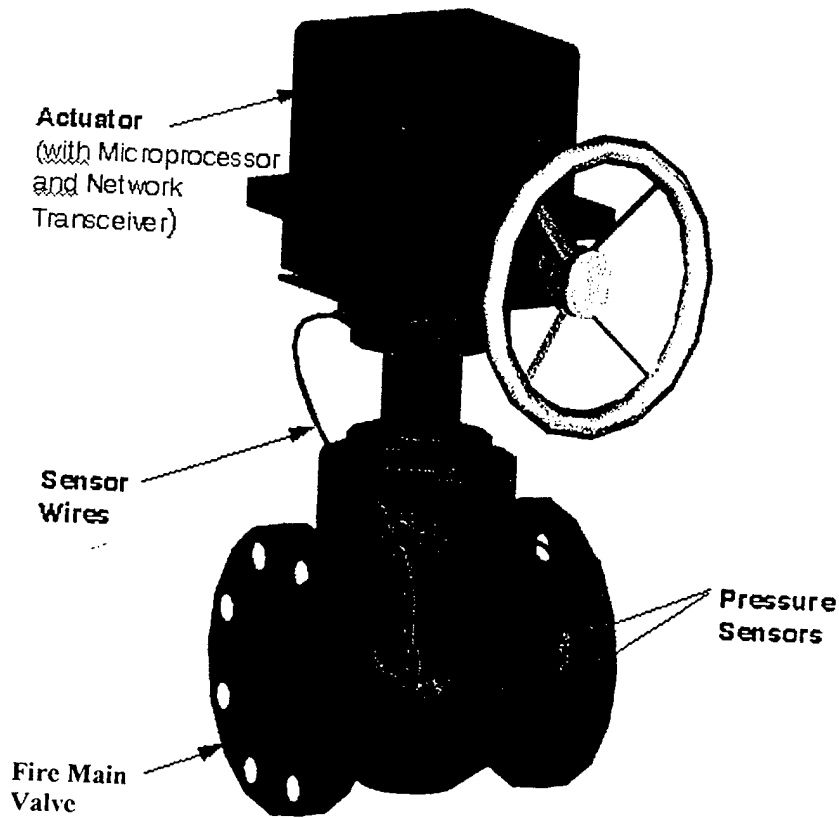

Figure 4. Model of Fire Main Smart Valve on SHADWELL

The components for the DC-ARM smart valve tested on the SHADWELL fire main are listed in Table 2. The Vanessa valve is a triple offset butterfly valve suitable for fire main service. This valve model has been under test and evaluation on DDG-51 Class fire main by Bath Iron Works. The Keystone EPI actuator was selected for SHADWELL installation as a cost effective platform to test new circuit boards for valve control. Two circuit boards are used for the smart valve: a valve control board and an applications board. The valve control board contains an AC/DC power supply, analog/digital processing, and hardware associated with open/stop/close control, position control and status feedback and emergency shutdown. The applications board contains a microprocessor, network transceiver and embedded software for valve control and user applications. (For the SHADWELL, user application software consists of rupture detection and isolation logic.) The pressure sensors used are typical of commercial unpackaged piezoresistive pressure sensors for industrial applications.

Table 2
Components of DC-ARM Fireman Smart Valve on SHADWELL

Component	Description
Valve	4-inch Tyco® Vanessa® Series 30,000 QTG Double Flange ANSI 150
Actuator	Keystone EPI 13 Motor Operated ⁵ , 120 VAC
Circuit Board Control Card	Power board containing power supply, A/D, switches, etc. Network board containing Echelon® FTT-10A LonWorks® network transceiver,
Pressure Sensors	SensSym series 19C sensors, stainless steel isolated, temperature compensated, 0-200 psig, 50 μV/V/psi output

Flow testing of the fire main smart valve was first performed at the Tyco® Flow Laboratory in Providence, Rhode Island. This testing indicated that the apparent valve flow coefficient was approximately 160-gpm/√psi based on the embedded pressure measurements⁶ which corresponds to a pressure drop of 0.4 psi at 100 gpm. In addition, these tests indicated that the random fluctuations of the pressure measurements are substantial. The standard deviation of the differential pressure measurements varied from 0.28 to 0.63 psi. Based on this data, rupture setpoints were developed for the SHADWELL fire main using hydraulic resistance logic consistent with the valve specifications. The conditions necessary to detect a fire main rupture at an open smart valve are:

$$\begin{aligned}
 & \text{Pressure} < 50 \text{ psig} \\
 & \text{AND} \\
 & \text{Differential Pressure} > 0.40 \text{ psi} + \text{Baseline Differential Pressure}
 \end{aligned}$$

where *pressure* is the pressure at the upstream or downstream sensor, *differential pressure* is the absolute value of the upstream minus downstream pressure and the *baseline differential pressure* is the most recent smoothed differential pressure when the fire main pressure is greater than 50 psig. In other words, a fire main rupture is detected if pressure decreases below the low pressure setpoint and flow increases by at least 100 gpm.

⁵ Tyco® would not recommend the Keystone EPI actuator be used with a Vanessa® QTG valve because the Vanessa valve is a torque seated valve and the Keystone actuator does not stop based on torque. The Keystone actuator was selected for the SHADWELL installation to facilitate cost effective testing of new circuit control board designs.

⁶ The nominal flow coefficient for the valve is 210 gpm/√psi. The apparent flow coefficient is less than the nominal flow coefficient due to a reduction in the area of the outlet flow which increases the localized pressure difference.

To ensure that random fluctuations (or noise) do not trigger rupture detection (i.e., a false alarm), an averaging algorithm was developed for the pressure data. The control circuit board acquired data at the rate of approximately 8 Hz. Based on a maximum smoothing interval of 10 seconds (which is less than the valve stroke time of 15 seconds), a maximum of 80 measurements can be averaged to minimize the uncertainty associated with the random fluctuations. Based on standard statistical methods and industry standard practice, the uncertainty attributed to random fluctuations can be estimated using the standard deviation of the mean [11]. For 95% confidence, the uncertainty attributed to random fluctuations is less than $2(0.63 \text{ psi})/\sqrt{80} = 0.14 \text{ psi}$. This uncertainty is equivalent to a flow rate uncertainty of $\pm 18 \text{ gpm}$ at 100 gpm and is considered to be sufficiently less than the relative setpoint of 0.40 psi.

3.4 SHADWELL Fireman Configuration

The original fire main in the ex-USS SHADWELL (LSD-15) was modified in 1998 to simulate the hydraulic characteristics of an offset loop fire main in the fire test area (between frames 9 and 29) on the third deck, second deck, and main deck. A schematic representation of the fire main is shown in Figure 5. The principal loop of piping for fire main testing consists of a 4-inch main on the starboard side second deck, a 3-1/2 inch main on the port side main deck, a 4 inch aft cross-connect at frames 23 to 26 and a 4 inch forward cross-connect at frames 12 to 17. The test loop is supplied by two fire pumps each with a capacity of about 600 gpm at discharge pressure of 100 psig.

Rupture flow paths are installed at three different locations: one in the port main, one in the starboard main, and one in the aft cross-connect. For each of these flow paths, flow is actuated with a quick-acting air operator and can be routed to the deck in the test area or to the peak tank. Another discharge flow path is installed in the forward cross-connect with an orifice plate to simulate a magazine sprinkling flow path. Upon removal of the orifice plate, this discharge flow path could be a fourth rupture flow path.

Initial plans for the fire main identified four locations for reflexive smart valve installation in the main flow loop. Installation of four valves is considered to be the minimum needed to demonstrate the functional capability of a smart valve system in an offset flow loop. During a damage event with four valves installed, one valve is lost to the damage, one valve malfunctions due to other causes (single failure) and two valves remain to isolate the rupture and restore pressure⁷. Installation of an additional smart valve in the main loop is planned to improve the isolation capability

⁷Due to cost constraints, a similar redundancy has not been provided with the fire pumps. In general, availability of both fire pumps is needed to demonstrate a survivable design. Alternatively, more than two pump supply paths can be simulated using other pipe connections in the test flow area.

Installation of redundant flow paths to a simulated electronics cooling load is planned. Each flow path will be provided with a smart valve which provides a reduced flow coefficient to limit flow rate, backflow protection to eliminate the possibility of the loss of two sections of fire main and rupture isolation logic if the branch line is severed. The smart valves are being manufactured by the Curtiss Wright Flow Control Corporation and are scheduled for installation in 2001.

A fire main supervisory control station is provided in the SHADWELL Control Room. The supervisory control station monitors and displays fire main data, provides control of fire main valves and pumps, contains system-level logic which evaluates for large fire main leaks and provides decision aids to ship personnel⁸.

⁸ The fire main supervisory control station is an IBM compatible PC running Windows 2000. The fire main control station is integrated with an overall supervisory damage control system for DC-ARM testing.

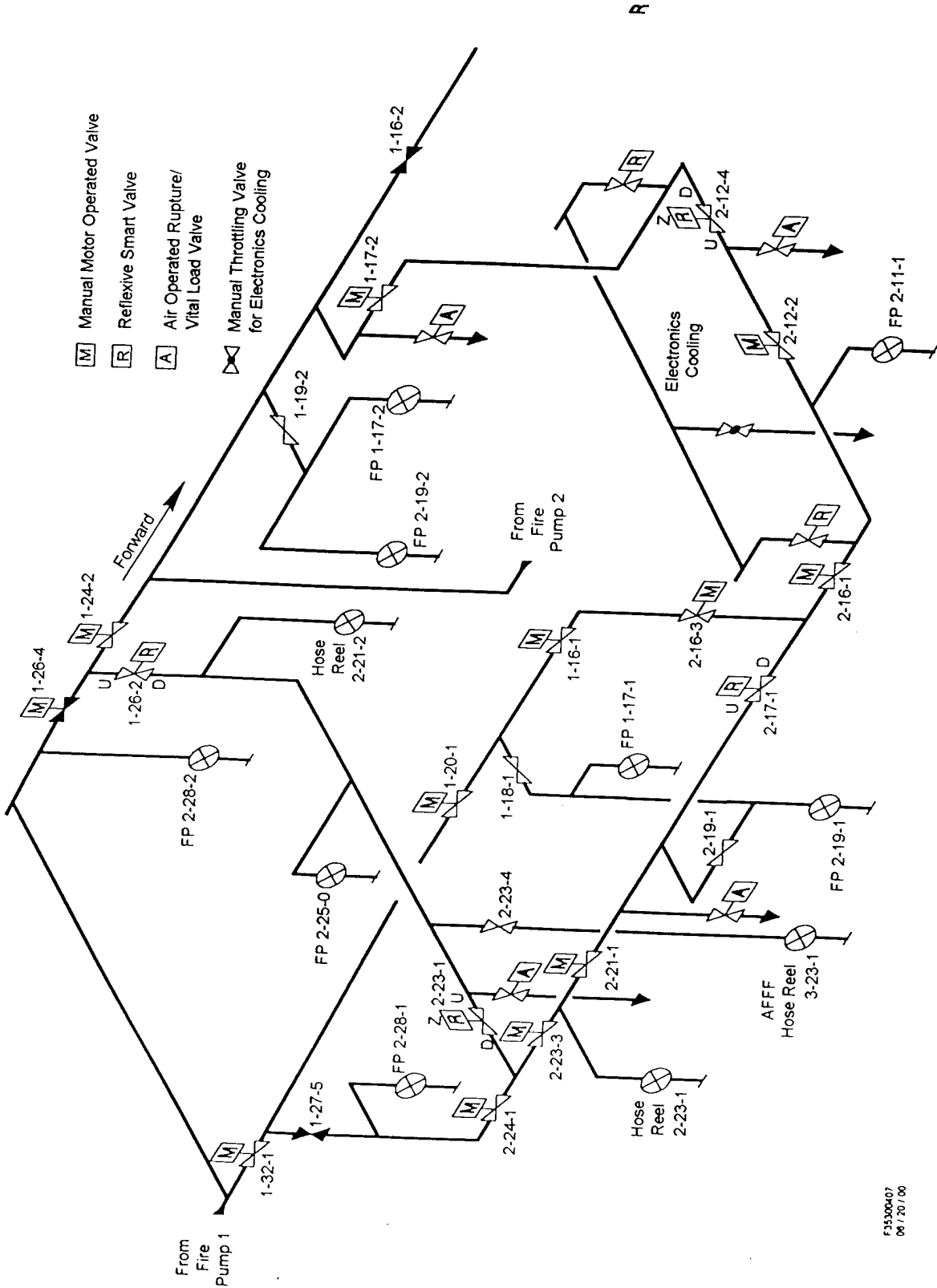

F35300407
06 / 20 / 00

Figure 5. SHADWELL Fireman in the Test Area

4.0 Results and Discussion

4.1 SHADWELL Fireman Test Results

The SHADWELL fire main tests consisted of hydraulic characteristics tests, rupture tests using hydraulic resistance logic, a vital load test, a small leak detection test, and a rupture test without a time delay. The test matrix is provided in Table 3

Table 3
Test Matrix for Fireman Reflexive Smart Valves

Test Date	Description	Summary
11/30/99	Zero Flow Test 1 and Clockwise Flow Test, No Rupture	Flow was routed from fire pump 1 to the peak tank via a clockwise path in the test area. Pressure sensor data was measured at flow rates ranging from 0 to 540 gpm. Flow was measured using a Controlotron strap-on ultrasonic flowmeter.
11/30/99	Zero Flow Test 2 and Counterclockwise Flow Test, No Rupture	Flow was routed from fire pump 2 to overboard via a counterclockwise flow path in the test area and four 1-1/2 inch fire hoses at FP 2-19-1 and FP 1-17-1. Flow rates ranged from 0 to 290 gpm.
12/1/99	Operations Office Rupture, Fire Pump 2	Rupture was isolated in approximately 90 seconds. A 15 second time period is unaccounted for in the design and is attributed to a software error.
12/1/99	Operations Office Rupture, Fire Pump 1	Rupture was isolated in 60 seconds. Isolation sequence was completed as designed.
12/2/99	Pump Trip	Fire pump was stopped, pressure reduced to zero and the valves remained open (as designed).
3/1/00	Zero Flow Test 3, No Fireman Pressure	Confirms factory determined sensor offset data.
3/2/00	Vital Load Test	Fire pump 2 was operating and forward magazine sprinkling flow path was activated with a flow rate of about 245 gpm. Valves did not close (as designed).
3/2/00	Small Leak Test	Fire pump 2 was operating and 2-12-4 was closed. Flow rate was adjusted from 0 to 85 gpm using 1-1/2 inch fire hose at FP 2-19-1. Valves monitored flow changes but did not close (as designed).
3/3/00	Zero Flow Test 4, No Fireman Pressure	Provides a check against 3/1/00 data.
3/3/00	Operations Office Rupture, No Time Delay	Time delays were removed from smart valves. Fire pump 2 was operating and a rupture in the Operations Office was initiated. Rupture was isolated in about 15 seconds. The smart valves nearest the rupture 1-26-2 and 2-23-1 closed. Smart valve 2-17-1 started to close and reopened as pressure was restored.

For the tests performed on 11/30, 12/1 and 12/2/99, only smart valves 1-26-2 and 2-23-1 were installed. For tests performed on 3/1, 3/2, and 3/3/00, all four smart valves were installed. For each of the tests, pressure sensor data was acquired using a laptop PC with a LonWorks® interface card and protocol analyzer software supplied by Echelon®.

Hydraulic Characteristic Tests

The objectives of the hydraulic characteristic tests were to determine which factors contribute to the error of the pressure and differential pressure measurements and to provide an initial estimate of their magnitude. This data can be used as a basis for developing signal conditioning methods and improving pressure measurements.

Initial flow testing of the fire main smart valve at the Tyco flow laboratory indicated that the most significant source of error is the random fluctuations due to fluid turbulence. Of secondary importance are errors attributed to upstream disturbances (installation configuration) and variation of flow coefficient with flow rate. For initial testing on SHADWELL, tests were performed to estimate the magnitude of the random fluid fluctuations for a typical shipboard fire main application. In addition, tests were performed to estimate the limits of variation of the valve flow coefficient for different flow rates and different upstream flow disturbances.

Two types of tests were performed to measure the hydraulic characteristics. First, zero flow tests were performed periodically to measure random fluctuations under conditions of zero flow (minimal turbulence). Second, flow tests were performed to compare the differential pressure with the flow reading of an ultrasonic flowmeter. The flow direction was reversed to estimate the effect of upstream disturbances.

The results of the zero flow tests are shown in Table 4. The output of the smart valve is converted into a pressure measurement using the sensor's zero offset and gain from factory calibration data. The magnitude of the random fluctuations are estimated using the standard deviation of the measurements.

Table 4
Smart Valve Pressure Measurements for Zero Flow Tests

Zero Flow Test Number	Pressure (psig)							
	1-26-2		2-23-1		2-17-1		2-12-4	
	U	D	U	D	U	D	U	D
1	94.7±0.1	95.7±0.1	99.0±0.1	98.3±0.12	NA	NA	NA	NA
2	98.0±0.5	99.1±0.5	103.1±0.3	102.7±0.3	NA	NA	NA	NA
3	0.93±0.1	1.5±0.1	5.1±0.1	5.2±0.01	5.8±0.01	5.7±0.1	4.5±0.5	4.5±0.1
4	73.4 ±0. 0	74.6±0.3	78.3±0.2	78.7±0.2	76.6±0.1	77.2±0.1	NA	NA

From the data in Table 4, the following is observed:

- Magnitude of Random Fluctuations at Zero Flow.** The maximum standard deviation measured under conditions of minimal turbulence is 0.47 psi. Using two standard deviations as a benchmark (two standard deviations bound approximately 95% of the data), the limits of fluctuation under steady conditions with minimal turbulence (no flow) are about ± 0.94 psi. This fluctuation is small compared with the allowable error in evaluation of the low-pressure setpoint. However, this fluctuation is greater than the changes in differential pressure which must be detected. As a result, some averaging or signal conditioning of the pressure signals is required. As discussed in section 3.3 above, a rolling average algorithm is used in the fire main smart valves based on 80 measurements. This averaging method

results in an uncertainty which is 1/4 to 1/5 the value of the standard deviation. This reduction is considered acceptable for rupture detection.

- **Non-Zero Differential Pressure.** At zero flow conditions, the difference between the upstream and downstream pressure sensor measurements is non-zero for all of the smart valves. For smart valve 1-26-2 (which is installed vertically), a portion of the zero flow difference can be attributed to fluid elevation (about 0.2 psi for ½ foot of elevation difference). The remaining pressure difference for 1-26-2 and the entire pressure difference for the other smart valves can be attributed to sensor drift, calibration bias and random fluctuations. The range of non-zero differential pressures is from -1.26 psi to 0.68 psi. Random fluctuations alone, cannot account for all of these variations.
- **Day-to-Day Sensor Drift.** The drift in the pressure sensor output is evaluated by comparing the change in the zero flow differential pressure when the fire main is at operating pressure. The zero flow differential pressure varies from -0.94 psi to -1.26 for smart valve 1-26-2 and from -0.42 to 0.68 for smart valve 2-23-1. Additional data is not available to determine the factors which contribute to the drift; however, changes in temperature along with other factors contribute to these variations. The use of relative setpoints is unaffected by day-to-day sensor drift. Since the day-to-day drift in sensor output is greater than the differential pressure setpoint of 0.40 psi, relative setpoints are required for the SHADWELL fire main application.
- **Calibration Bias.** The calibration bias is evaluated by comparing the zero flow differential pressure at zero pressure with the zero flow differential pressure at operating pressure (zero flow tests 3 and 4). Differences can be attributed to methods of implementing the calibration constants and non-linearity in the sensor output. The change in differential pressure between zero flow tests 3 and 4 is 0.70 psi for 1-16-2, 0.32 psi for 2-23-1, and 0.66 psi for 2-17-1. Some of this change can be attributed to day-to-day variations but some can also be attributed to calibration bias. The observed change in zero flow differential pressure impacts the sensitivity of the trigger for the relative differential pressure setpoint because the differential pressure can change when the system pressure changes even if the flow rate does not change. However, this factor did not adversely affect the response of the smart valve for all of the rupture, vital load and pump trip tests performed to date. Therefore, this bias is probably limited to 0.40 psig. Additional investigation of this non-linear calibration bias is ongoing to determine if corrective action is needed for the SHADWELL fire main valves.

For evaluation of data for these initial tests, a simple correction is applied to account for the zero flow offset in the evaluation of differential pressure measurements. The correction consists of subtracting the zero flow differential pressure from a smoothed average differential pressure.

The flow test data was measured for smart valves 1-26-2 and 2-23-1 for both clockwise and counterclockwise flow directions in the fire main piping in the test area. For the clockwise flow test, the forward cross-connect (near Repair 2) was isolated and flow was routed from fire pump 1 to the peak tank. For the counterclockwise flow test, the forward cross-connect was isolated and flow was routed from fire pump 2 to four 1-1/2 inch fire hose stations at fire plugs 2-19-1 and 1-17-1. The average differential pressure data is shown in Table 5

Table 5
Smart Valve Differential Pressure Measurements for Flow Tests

Test	Flow Rate (gpm)	Differential Pressure (psi)	
		1-26-2	2-23-1
Clockwise Flow Test, 11/30/99	0	-0.94±0.15	0.68±0.17
	160	-1.8±0.16	-0.55±0.17
	280	-3.44±0.23	-2.90±0.40
	464	6.76±0.426	-7.72±0.72
	536	-8.55±0.50	-10.23±0.85
Counterclockwise Flow Test, 11/30/99	0	-0.99±0.76	0.46±0.48
	80	-0.77±0.61	0.70±0.46
	144	-0.061±0.353	1.44±0.301
	240	1.25±0.389	2.77±0.50
	288	2.001±0.41	3.81±0.62

This flow data is evaluated by calculating the variation in valve flow coefficient. The flow coefficient is defined by the following expression [12]:

$$C_v = \frac{Q}{\sqrt{\Delta P_{\text{loss}} \left(\frac{\rho_{\text{ref}}}{\rho} \right)}} \quad (1)$$

where C_v is the valve flow coefficient, gpm/ $\sqrt{\text{psi}}$
 Q is the flow rate, gpm
 ΔP_{loss} is the pressure loss across the valve, psi
 ρ is the density of fluid
 ρ_{ref} is the density of water at 60°F

Due to a constricted flow path within the body of the valve, the pressure sensors determine an apparent flow coefficient which is less than the actual flow coefficient. Assuming that the ratio of densities is approximately equal to one and correcting for zero flow differential pressure, the apparent valve flow coefficient is calculated as follows:

$$(C_v)_{\text{apparent}} = \frac{Q}{\sqrt{|\Delta P - \Delta P_{\text{zero}}|}} \quad (2)$$

where ΔP is the differential pressure across the valve, psi
 ΔP_{zero} is the differential pressure across the valve at zero flow, psi

Table 6 contains the results of the calculations.

Table 6
Smart Valve Apparent Flow Coefficients for Flow Tests

Test	Flow Rate (gpm)	Apparent Flow Coefficient (gpm/ $\sqrt{\text{psi}}$)	
		1-26-2	2-23-1
Clockwise Flow Test, 11/30/99	160	166	142
	280	177	148
	464	192	160
	536	194	162
Counterclockwise Flow Test, 11/30/99	80	169	163
	144	149	146
	240	160	158
	288	164	157

The variation in the calculated flow coefficients in Table 6 is attributed to a several factors. The two primary sources of variation are considered to be the error of the ultrasonic flowmeter and the calibration bias of the pressure sensors (when the fire main pressure changes). Without these two sources of error, the true variation in flow coefficient is probably less than $\pm 10\%$. This true variation includes non-ideal effects due to upstream disturbances, flow rate, and valve geometry variations. This testing indicates that the variation in flow coefficient for the Vanessa valve is small, and can be incorporated into the margin for the differential pressure setpoint. *As a result, restrictions which may limit installation locations and correction factors for flow rate and fluid property variations do not appear to be required.*

Based on the results of the hydraulic characteristics tests, the uncertainty limits for the sources of error are estimated as follows:

Random fluctuations:	± 0.10 psi or equivalently ± 13 gpm at 100 gpm or $\pm 3^9$ gpm at 500 gpm
Calibration Bias:	± 0.40 psi or equivalently ± 50 gpm at 100 gpm or ± 10 gpm at 500 gpm
Day-to-Day Drift	± 0.50 psi or equivalently ± 64 gpm at 100 gpm or ± 13 gpm at 500 gpm
Flow Coefficient	$\pm 10\%$ or equivalently ± 10 gpm at 100 gpm or ± 50 gpm at 500 gpm

The day-to-day drift does not affect the operation of relative hydraulic resistance logic. Therefore the uncertainty of the flow measurement for the fire main smart valves is approximately ± 53 gpm at 100 gpm and ± 51 gpm at 500 gpm. These results are consistent with the specifications. The setpoint for the relative differential pressure may need to be increased to reduce the sensitivity that could cause inadvertent valve closure (false alarm).

⁹ The uncertainty attributed to each of these factors could be reduced by using different signal conditioning methods, improving calibration practices, and implementing self compensation algorithms. However, this is not needed for rupture detection on the SHADWELL fire main.

Rupture Tests

Rupture tests were performed to observe the response of the smart valves. Data was evaluated to determine when the rupture setpoints were exceeded, when the valves started to close and when pressure was restored to the system. Hydraulic resistance logic was used to detect and isolate a rupture. If a rupture is detected and the smart valve is on the rupture path, closure is determined by the time delay schedule programmed in the valve microprocessor. The rupture time delay schedule is a function of the flow direction, the valve closing stroke time and the relative location of the valve to the operating pump(s). For the initial SHADWELL installation, the rupture time delay schedule is shown in Figure 6. Reference 5 provides a complete discussion of the basis for hydraulic resistance logic and the basis for the time delays.

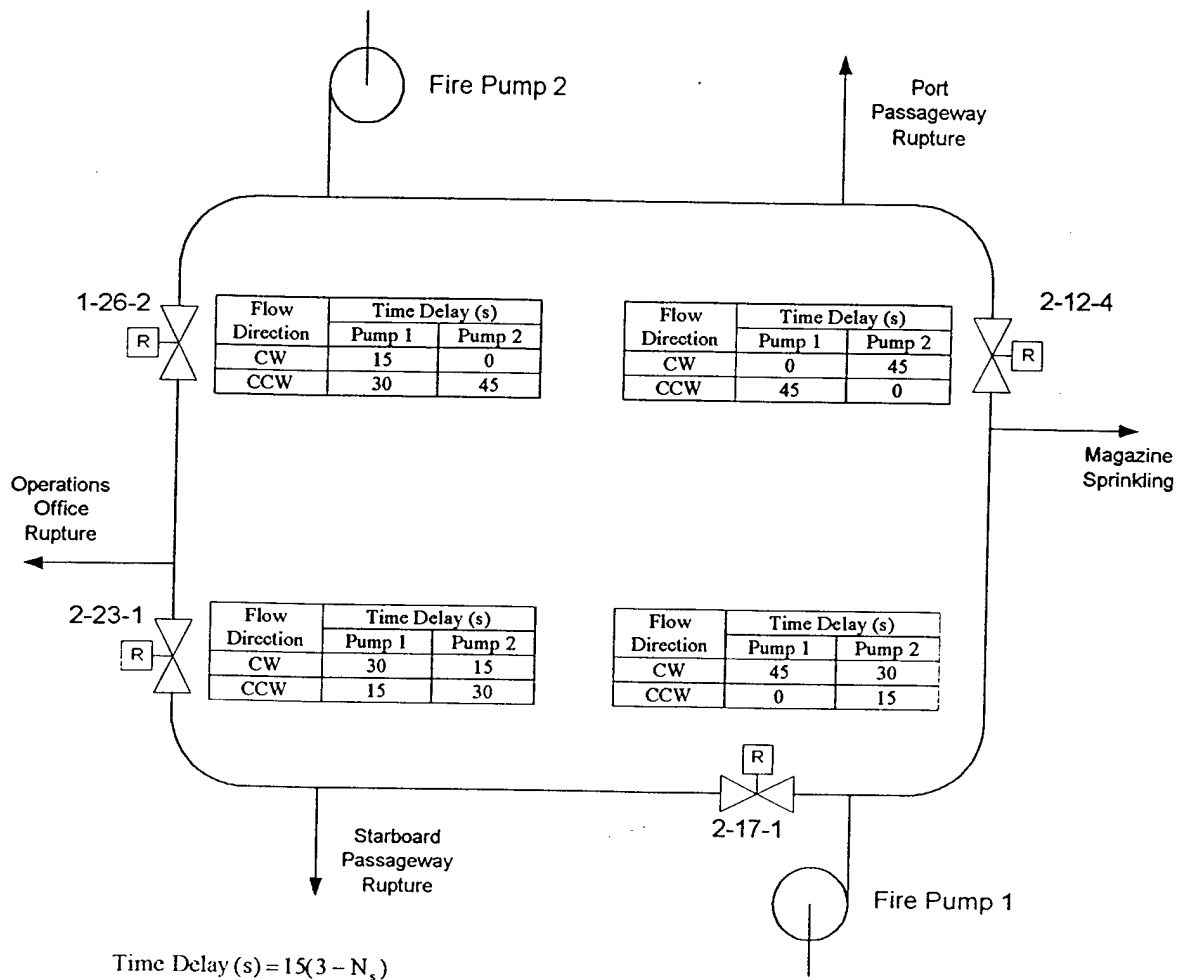

Figure 6. Closure Time Delays for Fireman Smart Valves During Initial Rupture Tests

Pressure traces have been measured for several rupture tests. In this report, pressure data is shown for two ruptures in the Operations Office. Figure 7 contains the data with fire pump 2 operating, and Figure 8 contains the data with fire pump 1 operating. With fire pump 2 operating, the rupture was isolated in about 90 seconds (with 2-23-1 closing after 60 seconds and 1-26-1 closing after 90 seconds). This 65 second rupture event contains the following breakdown of time periods:

- ▶ 15 second delay for rupture detection (3-5 seconds for pressure decline and 10-12 seconds for 80 sample rolling average),
- ▶ 15 second time delay for 2-23-1 and 45 second time delay for 1-26-2 from Figure 6,
- ▶ 15 second valve closing stroke, and
- ▶ 15 second time period for 2-23-1 and 15 second time period for 1-26-1 unaccounted for.

The unaccounted time is attributed to software programming errors with the time delay¹⁰.

With fire pump 1 operating, the rupture was isolated in about 60 seconds (with 2-23-1 and 1-26-1 closing at 60 seconds). This 60 second rupture event contains the following breakdown of time periods:

- ▶ 15 second delay for rupture detection (3-5 seconds for pressure decline and 10-12 seconds for 80 sample rolling average),
- ▶ 30 second time delay for 2-23-1 and 30 second time delay for 1-26-2 from Figure 6, and
- ▶ 15 second valve closing stroke.

Based on these initial tests, two areas for improvement were identified. First, the reliability of the time delay software needs to be sufficiently high to ensure that the time delays are repeatable to within 1 or 2 seconds. Second, rupture detection methods utilized might be refined to detect the rupture within a few seconds of the initiating event. Subsequent testing has shown that the time delay can be calculated reliably by correcting the valve software. With the current design of the smart valve data acquisition and signal conditioning, rupture detection times can be reduced by increasing the threshold for detection and reducing the number of measurements averaged. This possible enhancement is under consideration for the SHADWELL installation.

Using the data measured during these initial tests and the subsequent analysis, the best achievable fire main rupture isolation time using hydraulic resistance logic is estimated as follows. The rupture isolation time can be reduced to less than 30 seconds based on the following assumptions:

- Single loop main with eight smart valves (see References 4 and 5 for typical fire main loop),
- Two fire pumps operating (which are not adjacent to each other),
- Ten second valve closing stroke,
- Time delays staggered at 5 second intervals for adjacent valves, and
- One to two second detection time.

With the time delays staggered at 5 second intervals and with a 10 second closing stroke, neighboring smart valves will be in the closing stroke at the same time. Once the valve nearest the rupture closes, pressure is restored and the neighboring valve reopens. To meet this isolation time schedule, the signal conditioning and data acquisition for the smart valve would need to be enhanced to permit detection with a high level of confidence in one to two seconds.

For smart valve installations at branch cutout locations, the time delay for isolation may be reduced to less than 10 seconds because staggered time delays are not needed. Reducing the isolation time to less than 30 seconds for loop configurations is not considered practical because coordination of shortened time delays may be unreliable.

¹⁰An error in the time delay greater than 15 seconds could result in inadvertent isolation of intact sections. The time delay error identified in this test has been corrected by modifying the software. Subsequent testing has shown that time delays are repeatable to within a few seconds.

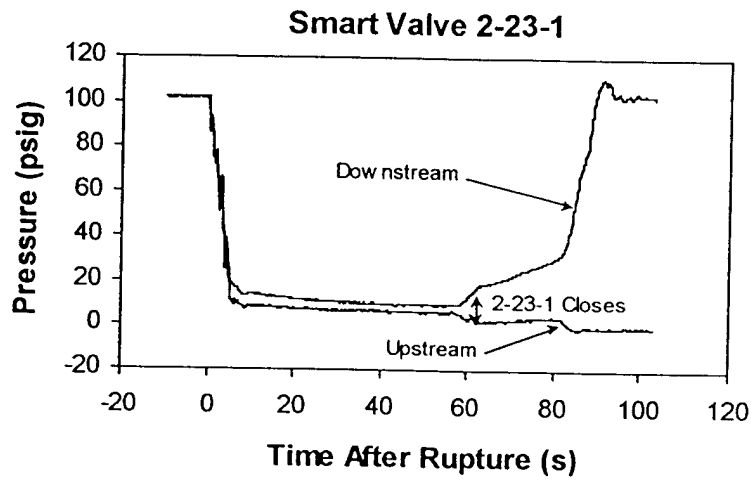
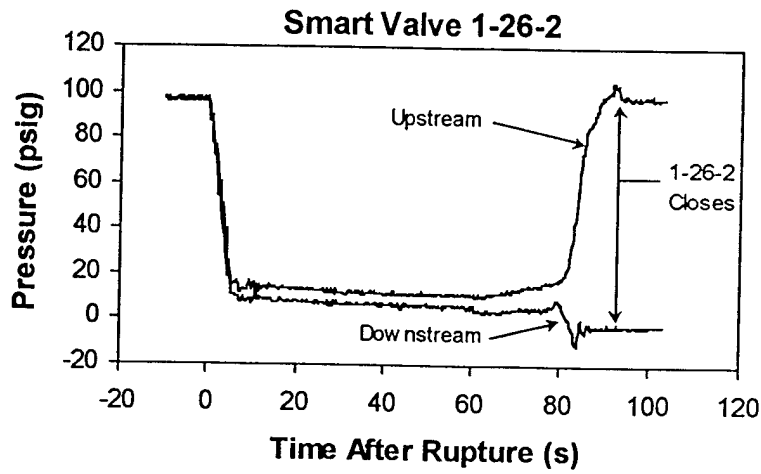

Figure 7. Pressure Traces for Operations Office Rupture with Fire Pump 2 Operating

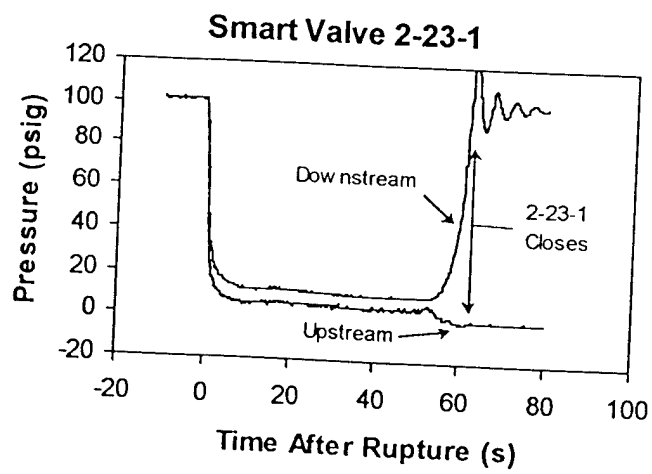
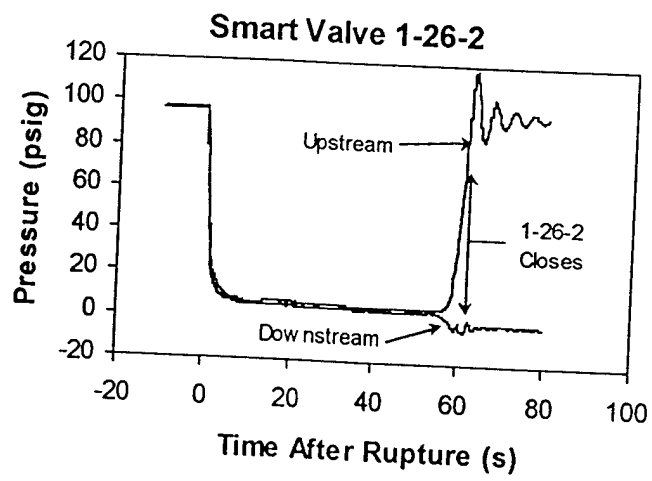

Figure 8. Pressure Traces for Operations Office Rupture with Fire Pump 1 Operating

Vital Load Test

A flow path is installed in the forward cross-connect in the test area to simulate magazine sprinkling which is considered a large vital load. Flow is actuated from the Control Room using an air-operated valve, and the flow is restricted with a 1.43-inch orifice (in a 4-inch pipe). The results of one vital load test is shown in Figure 9. Fire pump 2 is operating and smart valve 2-12-4 is closed to direct flow in a counterclockwise direction only. The differential pressure increases above its relative setpoint ($0.40 \text{ psig} + \Delta P_{\text{baseline}}$) but the system pressure remains above 50 psig and a rupture is not detected. Based on this test data and using a flow coefficient of $160 \text{ gpm}/\sqrt{\text{psi}}$, the magazine sprinkling flow rates for different fire main pressures are calculated in Table 7.

Table 7
Magazine Sprinkling Flow Rates on
SHADWELL Fireman

Fireman Pressure (psig)	Magazine Sprinkling Flow Rate (gpm)
60	245
70	266
80	283
90	301
100	317

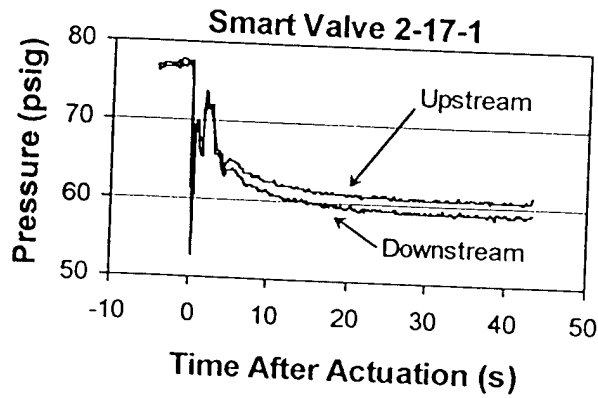
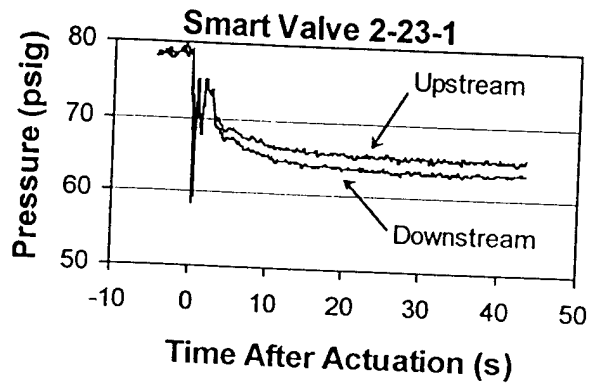
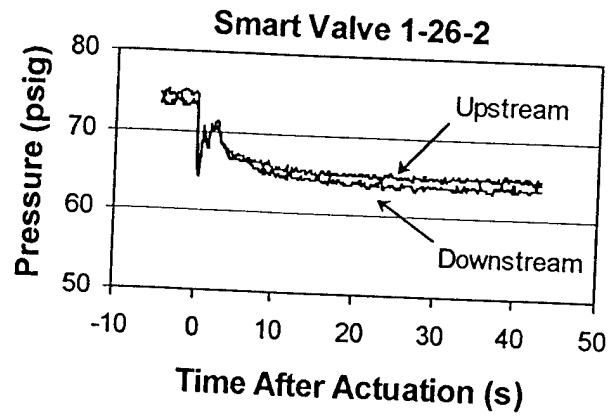

Figure 9. Pressure Traces for Magazine Sprinkling Actuation

Small Leak Test

Even though the concept smart valves on the SHADWELL fire main were not designed for small leak detection¹¹, a test was performed to determine the feasibility of applying the differential pressure measurements for leak detection of shipboard fluid systems. The objective of the small leak test was to determine if any significant changes in differential pressure measurements are detected for flow rates as low as 10 gpm¹².

The operating alignment for the test consisted of closing fire main valve 2-12-4 and operating fire pump 2. A counterclockwise flow pattern was established by operating two 1-1/2 inch nozzles from fireplug 2-19-1. With this alignment, flow was routed from the upstream to downstream sides of smart valves 1-26-2 and 2-23-1, and flow remained stagnant in smart valve 2-17-1. Flow rate was measured using a turbine flowmeter installed in the fireplug piping and was adjusted from stagnant (zero flow) conditions to 85 gpm.

The differential pressure and flow rate measurements for the test are shown in Figure 10. The differential pressure measurements shown are based on a rolling average of 40 measurements (which corresponds to about 5 seconds of data). An initial observation indicates that pressure conditions at the smart valves are not as steady as the flow conditions in the fireplug piping. Also, the short surge in flow rate to eject air at about 70 seconds into the test was detected at smart valve 2-17-1 only. An initial qualitative evaluation of the data traces in Figure 10 is not precise enough to determine if small leaks would be detected.

The average differential pressure for the three smart valves have been calculated for each flow rate and the results are shown in Table 8. Using equation 2 and an apparent flow coefficient of 160-gpm/ $\sqrt{\text{psi}}$, the smart valve flow rate was calculated. The results in Table 8 show that flow rates less than 20 gpm were detected at smart valve 2-17-1. This result is considered consistent with stagnant conditions. At smart valve 2-23-1, changes in flow rate as low as 11 gpm were detected but the error in the calculated flow rates are relatively large. The error in detected flow rates range from a low of 5 gpm at 85 gpm up to 18 gpm at 64 gpm. For smart valve 1-26-2, error in detected flow rates ranged from 2 gpm at 85 gpm to 16 gpm at 34 gpm.

¹¹ Since the fluctuations in differential pressure measurements are greater than the steady signal for low flow rates, filtering and/or digital signal processing methods could be applied to dampen the fluctuations and provide a more accurate quasi-steady flow rate measurement. However, such improvements in measurement methods were not considered necessary for rupture detection and therefore were not incorporated in the first smart valves on SHADWELL.

¹² With a pipe capacity of 600 gpm, this flow rate corresponds to 1.7% of the pipe capacity.

Table 8
Smart Valve Differential Pressures and Flow Rates for Small Leak Test

FP Flow Rate (gpm)	Smart Valve Data					
	1-26-2		2-23-1		2-17-1	
	ΔP (psi)	Calculated Flow (gpm)	ΔP (psi)	Calculated Flow (gpm)	ΔP (psi)	Calculated Flow (gpm)
0	-1.26	NA	-0.50	NA	-0.52	NA
11	-1.24	25	-0.46	29	-0.52	6
34	-1.25	18	-0.39	51	-0.52	10
64	-1.12	60	-0.24	81	-0.53	-9
85	-0.97	87	-0.24	80	-0.51	16

Applying additional quantitative analysis to estimate the significance of the leak detection with this data is not considered to be appropriate because of the relatively large uncertainties involved. In particular, the process variations are large compared to the signal which are detected. Over the sampling period used in this test, the process variations may not be completely random over the sampling period and a fixed error may be included in the average measurement. Also, slight variations in flow coefficient are expected over the range of flow rates and installation locations and additional data is considered necessary to account for these variations. Nevertheless, the conditions at the smart valve are considered typical of a shipboard fire main and these process variations need to be considered for leak detection.

These results indicate that it may be possible to enhance the differential pressure smart valve technology so that it can be used as a cost effective leak detection system for shipboard fluid systems. The results of this test are insufficient to determine the performance capability of such an approach. However, it is expected that flow measurement accuracy of ± 6 gpm (which corresponds to 1% of pipe capacity) can be attained with the smart valves installed on the SHADWELL if the signal processing is modified to account for non-linear calibration characteristics of the sensors and to allow more complete signal conditioning of process variations. Based on experience with differential pressure flowmeters (orifice and venturi), lowering the flow measurement error to less than 1% of the pipe capacity can be expensive and may not be practical.

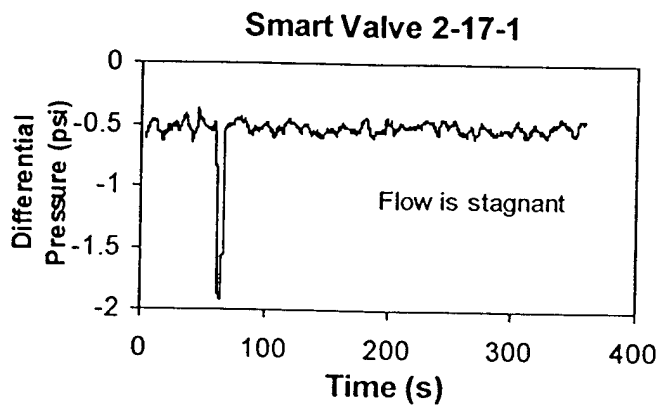
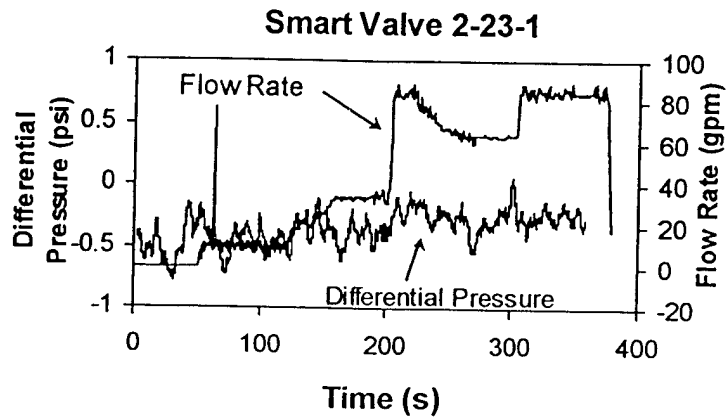
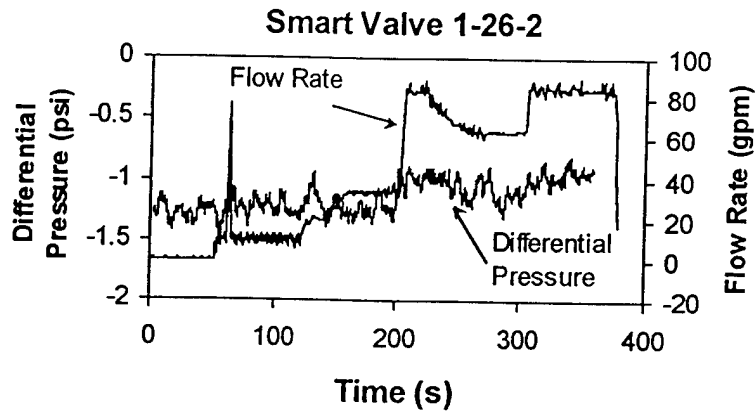

Figure 10. Pressure Traces and Flow Rate Measurements for the Small Leak Test

Hydraulic Circuit Breaker Test

For the first rupture tests performed using hydraulic resistance logic, the time delays prior to isolation would be considered excessive for other shipboard fluid systems such as chilled water. Investigation of alternative rupture logic methods which shorten the isolation time have been initiated to address the needs of these fluid systems. Different approaches are proposed:

- **Inherent Time Delay in Piping System.** In general, rupture set points are triggered first at smart valves nearest the rupture. This inherent time delay is very small (often less than 1 second) and is a function of length of piping, amount of air in the system (for liquid systems), size of rupture and other factors. If each smart valve starts to close as soon as it detects a rupture, valves nearest the rupture would start to close first. Near the end of the valve stroke, pressure would start to recover in intact sections. If pressure increases above the low set point on both sides of the smart valve (those valves further from the rupture), it would reopen.
- **Time Delay as a Function of Pressure.** The lower the pressure, the closer the rupture and the larger the break. Establishing a short time delay (1 to 5 seconds) as a function of pressure would help ensure that smart valves nearest the rupture would start closing first.
- **Rate of Closing Stroke as a Function of Valve Position.** If the rate of closing a smart valve is high at the beginning of the stroke and low at the end of the stroke, a leak-by path is provided while pressure is restored to intact sections. If pressure is increased on both sides of a smart valve, the smart valve reopens since it is not nearest the rupture. This approach extends the time delay inherent in the piping system and provides margin for valve-to-valve variations.

As an initial test of the hydraulic circuit breaker concepts, time delay software was removed from smart valves. As a result, the smart valve would close when the first pair of pressures from the sensors exceed the rupture setpoints (no averaging). The results of this test are shown in Figure 11. The following sequence of events was observed:

- ▶ Rupture conditions are detected within a second for smart valves 1-26-2 and 2-23-1¹³.
- ▶ Conditions fluctuate between rupture and non-rupture conditions for smart valve 2-17-1 for the first few seconds and therefore the valve does not start to close until after about 3-5 seconds.
- ▶ Smart valves 1-26-2 and 2-23-1 close after about 15 seconds and pressure is restored to the fire main.
- ▶ Smart valve 2-17-1 starts to open about 15 to 17 seconds after the rupture when the upstream and downstream pressures increase above 50 psig.

This test indicates that with careful selection of set point time delay functions and valve closing stroke profiles, it may be possible to design hydraulic circuit breaker logic to isolate a rupture without isolating intact pipe sections. For sections where large flow vital loads are in service, accurate control of the valve closing stroke profile is critical to ensure the vital load is isolated. Hydraulic circuit breaker logic is an area recommended for continued development.

¹³ Pressures close to the rupture do not decrease near zero because of a "kink" in the 4-inch discharge hose to the peak tank used for this rupture simulation. This non-ideal condition was fortuitous since it demonstrated how careful selection of rupture setpoints may be used to sequence smart valve closures.

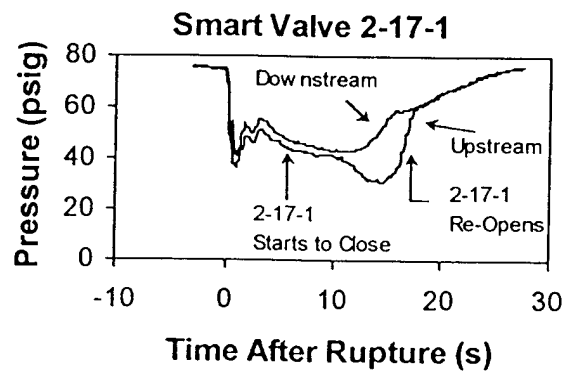
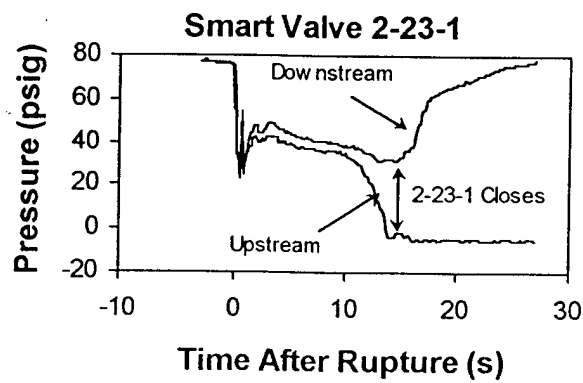
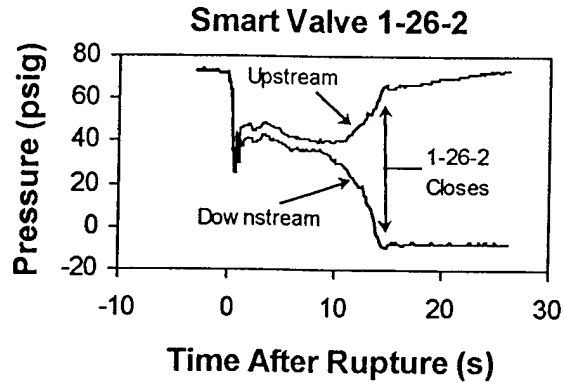

Figure 11. Pressure Traces for Operations Office Rupture with Zero Time Delay and No Data Averaging

4.2 Design of Damage Tolerant Shipboard Fluid Systems Using Smart Valves

DC-ARM smart valve technology may be applied to shipboard fluid systems other than fire main. In general, the approach to develop a damage tolerant fluid system consists of the following steps:

1. Determine the Minimum Acceptable Operating Conditions. The minimum acceptable conditions to support the mission need to be defined. This minimum set of conditions consists of a set of services which should be available after major damage.
2. Identify Vital Services. Vital services are those which comprise the minimum conditions. Additional services may be identified as vital if they provide desired redundancy.
3. Identify the Required Recovery Time. The required recovery time is the time that a fluid system can be lost without degrading mission capability. The recovery time is an important parameter influencing the design of the smart valve configuration for a fluid system. The recovery time may determine the valve and actuator design and the valve logic used.
4. Determine the Consequences of Leaks. Leaks have different consequences for different shipboard fluid systems. With compressed low-pressure air, a small leak may only have adverse consequences if the leak rate exceeds the capacity of a compressor. For chilled water systems, a small leak (a couple of gpm) could damage sensitive electronic equipment or drain the supply/expansion tank. The evaluation of leaks should consider the response time of personnel and leak detection technology available. In general, the minimum acceptable leak size is determined based on a trade-off competing factors including cost of leak detection technology, supply capacity and personnel response. For example, the minimum acceptable leak size may be determined based on the supply tank capacity and assuming continued system operation for 20 minutes until ship personnel can correct the problem. (Without automated detection and leak location, the time to locate a small leak could be substantially greater than 20 minutes.)
5. Determine Smart Valve Locations. Smart valves are placed at locations to isolate damage and restore operation to vital services in order to meet minimum acceptable conditions following credible damage scenarios. In the piping main, smart valves are installed at locations to contain damage (such as at fire zone boundaries). In branch piping, smart valves are located at cutout locations for vital services and other services for leak monitoring, damage isolation and flow control.
6. Analyze Fluid System Performance. The system pressures, flow rates and temperatures should be calculated for normal operating and casualty scenarios. The results of these analyses are used as the basis for smart valve logic methods and smart valve specifications.
7. Develop Smart Valve Logic. Rupture setpoints, time delays for valve closure and leak detection sensitivity are developed based on the system performance analysis.
8. Develop Supervisory System Interface. Valve operating modes and data required by the supervisory system should be developed to meet the overall functional requirements of the supervisory system.
9. Develop Smart Valve Specifications. Based on the evaluations in steps 6, 7 and 8, specifications should be developed for a manufacturer. The following information should be included to define the smart valve performance:
 - Upstream and downstream pressure accuracy
 - Flow rate accuracy (flow rate which can be detected)
 - Time to close
 - System pressures and temperatures

- Maximum valve flow rate and pressure drop
- Interface data with supervisory system (such as pressures, flow rates, valve positions and valve mode), and
- Additional sensors.

The initial application of this design approach may be iterative so that a valve manufacturer can evaluate if valve specification can be met with affordable technology. The constraints for smart valve design can be summarized by considering the following derivation of non-dimensional constraints. Starting with equation (1) and assuming that the pressure loss across the valve is the same as the differential pressure across the valve:

$$C_v = \frac{Q}{\sqrt{\Delta P \left(\frac{\rho_{ref}}{\rho} \right)}} \quad (3)$$

Introducing Q_{max} , the maximum flow rate through the valve, and P , the normal system operating pressure, equation (1) can be rearranged as follows:

$$\frac{\Delta P}{P} \frac{C_v^2}{Q_{max}^2} P \left(\frac{\rho_{ref}}{\rho} \right) = \left(\frac{Q}{Q_{max}} \right)^2 \quad (4)$$

Equation (4) contains three non-dimensional parameters:

- Q/Q_{max} is the non-dimensional flow rate,
- $\Delta P/P$ is the non-dimensional differential pressure across the valve, and
- $C_v/Q_{max} \sqrt{P(\rho_{ref}/\rho)}$ is the non-dimensional flow coefficient.

Equation (4) can be used as a design equation where $(Q/Q_{max})_{min}$ is the minimum detected flow rate as specified by the system designer, $(\Delta P/P)_{min}$ is the minimum detectable differential pressure as determined by the valve manufacturer (for the sensor, A/D conversion, and signal conditioning methods used) and the flow coefficient should be less than the resulting ratio to meet system requirements:

$$\frac{C_v^2}{Q_{max}^2} P \left(\frac{\rho_{ref}}{\rho} \right) \leq \left(\frac{Q}{Q_{max}} \right)_{min}^2 / (\Delta P/P)_{min} \quad (5)$$

If a valve flow coefficient does not meet the criteria in equation 5, either a different valve should be selected, the differential pressure sensitivity should be improved by the valve manufacturer, the system designer should relax the leak requirement or a flow meter separate from the smart valve should be used.

4.3 Areas of Continuing Work

Continued cooperative work between valve manufacturers and the Navy is needed to ensure that DC-ARM smart valve technology is suitable for deployment. The development should focus on providing a set of design tools to be used by the Navy shipbuilding community for new ship design and back-fit of some existing fluid systems. Particular areas for continued development are as follows:

Expand Hardware Selection for Rupture Detection

At this time, DC-ARM smart valve has been demonstrated only for the Tyco® Vanessa valve and Keystone motor operated actuator combination. Plans are underway to test a Curtiss Wright globe valve with solenoid operator for electronics cooling applications and a Tyco ball valve with a motor-operated actuator for water mist systems. Expanding the DC-ARM smart valve concept to other actuator models is needed. For example, implementation with a pneumatic actuator could be used to demonstrate rapid closure and reduce the dependence on electric power (only low power DC current is needed for sensors and network transceivers). Implementation on different valve models is needed to demonstrate capability for other shipboard fluid system applications. In general, the concept is limited by the ability to measure the pressure drop across the valve. As a result, it may not be practical to use a full port ball valve as a DC-ARM smart valve.

As additional applications are developed, the limits of the smart valve hardware concept can be better defined. Predicting the limits of rupture and leak detection based on the current data is uncertain. Different methods to amplify and process the pressure signals may improve the sensitivity of the differential pressure measurements. Also modifications to the inside surfaces of some high flow coefficient valve models (such as a full port ball valve) may provide local pressure variations which can be used to measure flow rate. Based on the initial testing, inexpensive commercial pressure sensors can provide sensitive "fluid signal listening" capability which may be used to expand the traditional performance of differential pressure measurements.

Provide Additional Test Platforms for DC-ARM Smart Valve Demonstrations

To expand the software and hardware development, demonstrations of the DC-ARM smart valve should be performed on test platforms in addition to the SHADWELL fire main. The SHADWELL water mist system and NAVSEA Philadelphia chilled water and fire main systems are possibilities. Demonstrations for compressed air and fuel systems should be considered. Effort should be focused on demonstration platforms which expand the capabilities of current hardware and software.

Design and Implement a Smart Valve System for a Fireman Aboard an Active Ship

This initial testing indicates that the smart valve concept for rupture detection and isolation on the SHADWELL fire main is ready for prototype implementation on an active duty Navy ship. First, a design would need to be developed based on overall functional and performance requirements. The design would identify smart valve locations, required closing times, rupture setpoints, maximum allowable pressure drops, maximum flow rates, ship environmental and reliability requirements and interface requirements for the supervisory control system. Based on the design, smart valve specifications could be prepared for valve manufacturers. Based on these specifications, the Navy could evaluate and select one or more suppliers and their smart valve designs. Following installation, a test and evaluation program could be used to identify improvements that might be needed.

Develop Leak Detection Methods

The use of commercial pressure sensors embedded in a smart valve is a cost effective alternative to installing an industrial flowmeter or commercial leak detection system. Development of accurate flow measurement hardware and software using the DC-ARM smart valve concept should be pursued. The development would involve a systematic evaluation of the sources of error for the pressure measurement techniques. In particular, diagnostic tests in a flow laboratory are needed to establish reliable estimates of instrument corrections needed to substantially reduce fixed errors such as attributed to day-to-day variations and non-linear calibration. Once sources of fixed errors are minimized, standard signal processing methods can be applied to reduce the errors attributed to random fluctuations [13]. Close cooperation with the valve manufacturer is needed because the methods applied are closely linked to the hardware selection for the valve body, pressure sensor, analog-to-digital converter chip and digital signal processing used. In general, this development effort is considered to be low-risk, but time is needed for evaluation of the data and redesign of the circuit boards.

Develop Hydraulic Circuit Breaker Logic

Development of process methods and associated software to very quickly detect and isolate a rupture has wide commercial applicability. The general approach to develop the logic involves performing calculations to match (1) time delay versus pressure functions with system pressure decay transients, and (2) valve closing rate versus position functions with system repressurization transients. Based on the results of these calculations, a concept valve can be developed and tested to determine the performance capability.

5.0 Conclusions

Fireman Smart Valve

The DC-ARM reflexive smart valve architecture tested on the SHADWELL is ready for prototype installation and evaluation on an active duty ship. The valve for prototype installation can be a Vanessa model as installed on the SHADWELL. Alternatively, other valves designs may be considered providing that hydraulic characteristic tests are performed with embedded pressure sensors to confirm flow measurement capability. A different actuator would be needed to ensure reliable valve operation over an extended evaluation period¹⁴. Qualification of the circuit boards embedded in the actuator (for shock, vibration, and environmental conditions) would be required.

¹⁴ Tyco personnel indicate that the existing valve control board design can be used with several actuators suitable for extended shipboard service. Furthermore, the control board can be used with different network protocols.

Hydraulic resistance logic could be used as the core logic for rupture detection and isolation. A system design would be needed to identify suitable smart valve locations, setpoints and closure time delays. Based on evaluation of current data, branch ruptures could be isolated within 15 seconds and main loop ruptures could be isolated within 30 seconds. Modifications to the software on the SHADWELL would be needed to reduce the time required for the averaging algorithm and to ensure that timing sequences are reliable (repeatability within 1 or 2 seconds).

Expanded Hardware and Software Capability

The data indicates that the DC-ARM smart valve concept can be applied to a wide variety of valve designs. For valve designs with a reduced-size seat such as with globe valves, reduced port ball valves, and some butterfly valves (similar to the Vanessa model), differential pressure measurements may be sufficiently accurate for both rupture detection and some leak detection. For valve designs with the highest flow coefficient (such as gate valves and full port ball valves), the range of flow detection may be limited. However, it may be possible to modify the inside surface of the valve in the vicinity of the pressure sensors to improve the sensitivity of the differential pressure measurement.

The existing pressure sensor data indicates that a family of rupture logic methods may be practical for smart valve implementation (without isolating intact sections and without the need for communication following damage). One approach for very quick rupture detection would use the pressure sensors "to listen" for signals which are characteristic of a rupture. A variety of different triggering mechanisms to initiate valve closure may be practical. By adjusting the valve closure stroke, ruptures may be isolated without isolating intact pipe sections. For small leaks, implementation of modified commercial leak detection methods may be practical for the smart valve. Since commercial leak detection methods rely upon system level logic, modification of these methods would be needed to separate applicable portions for a smart valve.

Fluid Systems Other Than Fireman

The DC-ARM smart valve is appropriate for shipboard fluid systems other than the fire main. For chilled water systems, development of hydraulic circuit breaker methods for fast acting rupture isolation and accurate flow measurement methods for leak detection may be used as a practical approach. For fuel systems, hydrocarbon sensors may provide a cost effective method to detect very small leaks.

Further Development Work

At this time, several different valve companies have been developing smart valve hardware configurations to meet shipboard requirements. Additional hardware development can be accomplished with continued cooperative working arrangements between Navy technical staff and valve manufacturers. This cooperation between manufacturers and the Navy would be a continuation of the current DC-ARM program.

6.0 Reference

1. Carhart, H.W., Toomey, T.A., and Williams, F.W., "The ex-USS *Shadwell* Full-scale Fire Research and Test Ship," NRL Memo Report 6074, 6 Oct 1987, reissued Sep 1992.
2. Williams, F.W. et al., Results of 1998 DC-ARM/ISFE Demonstration Tests, NRL/FR/6180—00-9929, 25 Apr 2000.
3. U.S. Environmental Protection Agency's Underground Storage Tank Regulation, 40 CFR, Part 280, Subpart D.
4. Runnerstrom, L.T., Davis, E., Durkin, A.F. and Williams, F.W., "Evaluation of Reflexive Valve Logic for a Shipboard Fireman," NRL/MR/6180—00-88425, 12 Jan 2000
5. Runnerstrom, L.T., Davis, E., Durkin, A.F. and Williams, F.W., "Evaluation of Fireman Architectures and Supporting Reflexive Technology," NRL/MR/6180—99-8346, 12 Mar 1999.
6. Dalessandro, D., "Shipboard Test Results of a Differential Pressure Transmitter for the Fireman Reconfiguration Management System," NSWCCD-TR-80-97XX (Draft). Nov 1997.
7. Durkin, A.F., Byrne, P.C., Niciforw, P.G., Nguyen, X.H. and Williams, F.W., "An Application of Process Control Technologies for use Aboard Naval Ships: Automated Fire main Management Systems (AFMS)," NRL Ltr Rpt 6180/0181, 29 Apr 1998.
8. Durkin, A.F., Niciforous, P.G., Mai, M.T., Byrne, P.C., Nguyen, X.H. and Williams, F.W., "An Application of Process Control Technologies for use Aboard Naval Ships: Automated Fire main Management Systems (AFMS) Phase 2 Differential Pressure," NRL Ltr Rpt 6180/0033, 11 Feb 1999.
9. Naval Surface Warfare Center's draft report NSWCCD-82-TR-2000/xx , "DDG-51 Flight 11A Reflexive Chilled Water Automation System ", Oct 2000.
10. Williams, F.W., Scheffey, J.L., Hill, S.A., Toomey, T.A., Darwin, R.L., Leonard, J.T. and Smith, D.E., "Post-Flashover Fires in Shipboard Compartments Aboard ex-USS *Shadwell*: Phase V – Fire Dynamics," NRL Formal Rpt NRL/FR/6180—99—9902, 31 May 1999
11. ASME Performance Test Code 19.1, Test Uncertainty, 2000.
12. Crane Technical Paper No. 410, Flow of Fluids Through Valves Fittings and Pipe, Crane Company.