

12th Annual SO/LIC Symposium & Exhibition

Transformation Strategies to Meet
Future Operational Requirements



Hyatt Regency Crystal City

Arlington, VA

February 12-14, 2001

NDIA Event # 1880



Sponsored by the
SO/LIC Division of NDIA

Proceedings

DISTRIBUTION STATEMENT A
Approved for Public Release
Distribution Unlimited

20010404 016

EXCERPTS FROM JOINT VISION 2020

1. Introduction.

The US military today is a force of superbly trained men and women who are ready to deliver victory for our Nation. In support of the objectives of our National Security Strategy, it is routinely employed to shape the international security environment and stands ready to respond across the full range of potential military operations. But the focus of this document is the third element of our strategic approach – the need to prepare now for an uncertain future.

The overall goal described in this document is the creation of a force that is dominant across the full spectrum of military operations – persuasive in peace, decisive in war, preeminent in any form of conflict.

The strategic concepts of decisive force, power projection, overseas presence, and strategic agility will continue to govern our efforts to fulfill those responsibilities and meet the challenges of the future.

This vision is centered on the joint force in 2020. The overarching focus of this vision is full spectrum dominance – achieved through the interdependent application of dominant maneuver, precision engagement, focused logistics, and full dimensional protection.

The evolution of these elements over the next decades will be strongly influenced by two factors. First, the continued development and proliferation of information technologies will substantially change the conduct of military operations. These changes in the information environment make information superiority a key enabler of the transformation of the operational capabilities of the joint force and the evolution of joint command and control. Second, the US armed Forces will continue to rely on a capacity for intellectual and technical innovation.

2. Strategic Context.

The joint force of 2020 must be prepared to win across the full range of military operations in any part of the world, to operate with multinational forces, and to coordinate military operations, as necessary, with government agencies and international organizations.

Second, potential adversaries will have access to the global commercial industrial base and much of the same technology as the US military. Our advantage must, therefore, come from leaders, people, doctrine, [tactics] organizations, and training that enable us to take advantage of technology to achieve superior war fighting effectiveness.

Third, we should expect potential adversaries to adapt as our capabilities evolve. ...the appeal of asymmetric approaches and the focus on the development of niche capabilities will increase.

The potential of such asymmetric approaches is perhaps the most serious danger the United States faces in the immediate future – and this danger includes long-range ballistic missiles

The joint force must be able to achieve full spectrum dominance.

3. Full Spectrum Dominance.

Full spectrum dominance [is] the ability of US forces, operating unilaterally or in combination with multinational and interagency partners, to defeat any adversary and control any situation across the full range of military operations.

The label full spectrum dominance implies that US forces are able to conduct prompt, sustained, and synchronized operations with combinations of forces tailored to specific situations and with access to and freedom to operate in all domains –space, sea, land, air, and information. The transformation of the joint force to reach full spectrum dominance rests upon information superiority as a key enabler and our capacity for information.

Information Superiority.

Information environment – the aggregate of individuals, organizations, and systems that collect, process, or disseminate information, including the information itself (JP 1-02).

Information superiority – the capability to collect, process, and disseminate an uninterrupted flow of information while exploiting or denying an adversary’s ability to do the same. (JP1-02) Information superiority is achieved in a noncombat situation or one in which there are no clearly defined adversaries when friendly forces have the information necessary to achieve operational objectives.

... advances in information capabilities are proceeding so rapidly that there is a risk of outstripping our ability to capture ideas, formulate operational concepts, and develop the capacity to assess results. While the goal of achieving information superiority will not change, the nature, scope, and rules of the quest are changing radically.

The joint force must be able to take advantage of superior information converted to superior knowledge to achieve “decision superiority”...

The evolution of information technology will increasingly permit us to integrate the traditional forms of information operations with sophisticated all-source intelligence, surveillance, and reconnaissance in a fully synchronized information campaign. We must also remember that information superiority neither equates to perfect information, not does it mean the elimination of the fog of war.

Information superiority is fundamental to the transformation of the operational capabilities of the joint force.

Innovation.

Technological innovation is a vital component of the transformation of the joint force. The ideas in JV 2010 as carried forward in JV 2020 are, indeed, innovative and form a

vision for integrating doctrine, tactics, training, supporting activities and technology into new operational capabilities.

4. Conduct of Joint Operations.

The complexities of the future security environment demand that the United States be prepared to face a wide range of threats of varying levels of intensity. Success in countering these threats will require the skillful integration of the core competencies of the Services into a joint force tailored to the specific situation and objectives. ... in most cases, a joint force comprised of both Active and Reserve Components will be employed.

The complexity of future operations also requires that, ... all the tools of statecraft to achieve our national objectives unilaterally when necessary, while making optimum use of the skills and resources provided by multinational military forces, regional and international organizations, non-governmental organizations, and private voluntary organizations when possible. Participation by the joint force in operations supporting civil authorities will also likely increase in importance due to emerging threats to the US homeland such as terrorism and weapons of mass destruction.

People.

Our vision of full spectrum dominance and the transformation of operational capabilities has significant implications for the training and education of our people. The tactics of information operations, the coordination of interagency and multinational operations, as well as the complexity of the modern tools of war all require people who are both talented and trained to exacting standards.

Interoperability.

Interoperability is the foundation of effective joint, multinational, and interagency operations. The joint force has made significant progress toward achieving an optimum level of interoperability, Exercises, personnel exchanges, agreement on standardized operating procedures, individual training and education, and planning will further enhance and institutionalize these capabilities. Interoperability is a mandate for the joint force of 2020

Multinational Operations.

Since our potential multinational partners will have varying levels of technology, a tailored approach to interoperability that accommodates a wide range of needs and capabilities is necessary. Our more technically advanced allies will have systems and equipment that are essentially compatible, enabling them to interface and share information in order to operate effectively with US forces at all levels. However, we must also be capable of operating with allies and coalition partners who may be technological incompatible-especially at the tactical level.

In all cases, effective command and control is the primary means of successfully extending the joint vision to multinational operations.

Interagency Operations.

The primary challenge of interagency operations is to achieve unity of effort despite the diverse cultures, competing interests, and differing priorities The joint force must be proactive in improving communications, planning, interoperability, and liaison with potential interagency participants

Operational Concepts.

Dominant Maneuver. The ability of joint forces to gain positional advantage with decisive speed and overwhelming operational tempo in the achievement of assigned military tasks. Widely dispersed joint air, land, sea, amphibious, special operations and space forces, capable of scaling and massing force or forces and the effects of fires as required for either combat or noncombat operations, will secure advantage across the range of military operations through the application of information, deception, engagement, mobility and counter-mobility capabilities.

Information superiority will support the conduct of dominant maneuver by enabling adaptive and concurrent planning; coordination of widely dispersed units; gathering timely feedback on the status, location, and activities of subordinate units; and anticipation of the course of events leading to mission accomplishment. The joint force will also be capable of planning and conducting dominant maneuver in cooperation with interagency and multinational partners with varying levels of commitment and capability.

Precision Engagement. The ability of joint forces to locate, surveil, discern, and track objectives or targets; select, organize, and use the correct systems; generate desired effects; assess results; and reengage with decisive speed and overwhelming operational tempo as required, throughout the full spectrum of military operations.

The pivotal characteristic of precision engagement is the linking of sensors, delivery systems, and effects. In the joint force this linkage will take place across Services and will incorporate the applicable capabilities of multinational and interagency partners when appropriate.

The concept of precision engagement extends beyond precisely striking a target with explosive ordnance. Information superiority will enhance the capability of the joint force commander to understand the situation, determine the effects desired, select a course of action and the forces to execute it, accurately assess the effects of that action, and reengage as necessary while minimizing collateral damage.

In noncombat situations, precision engagement activities will, naturally, focus on nonlethal actions.

Focused Logistics.

Focused logistics will provide military capability by ensuring delivery of the right equipment, supplies, and personnel in the right quantities, to the right place, at the right time

Full Dimensional Protection. The ability of the joint force to protect its personnel and other assets required to decisively execute assigned tasks.

The capability for full dimensional protection incorporates a complete array of both combat and noncombat actions in offensive and defensive operations, enabled by

information superiority. It will be based upon active and passive defensive measures, including theater missile defenses and possible limited missile defense of the United States; offensive countermeasures; security procedures; antiterrorism measures; enhanced intelligence collection and assessments; emergency preparedness; heightened security awareness; and proactive engagement strategies.

Information Operations.

Information operations are essential to achieving full spectrum dominance. The joint force must be capable of conducting information operations, the purpose of which is to facilitate and protect US decision-making processes, and in a conflict, degrade those of an adversary.

Joint Command and Control.

Command and control is most effective when decision superiority exists. Decision superiority results from superior information filtered through the commander's experience, knowledge, training, and judgment; the expertise of supporting staffs and other organizations; and the efficiency of associate processes.

In the joint force of the future, command and control will remain the primary integrating and coordinating function for operational capabilities and Service components.

Leaders of the joint force must analyze and understand the meaning of unit cohesion in the context of the small, widely dispersed units that are now envisioned. Second, decision makers at all levels must understand the implications of new technologies that operate continuously in all conditions when human beings are incapable of the same endurance. Third, as new information technologies, systems, and procedures make the same detailed information available at all levels of the chain of command, leaders must understand the implications for decision making, the training of decision makers at all levels, and organizational patterns and procedures.

5. Implementation.

Joint Vision 2010 has had a profound impact on the development of US military capabilities. By describing those capabilities necessary to achieve success in 2010 we set motion three important efforts. First, JV 2010 established a common framework and language for the Services to develop and explain in their unique contributions to the joint force. Second, we created a process for the conduct of joint experimentation and training to test ideas against practice. Finally, we began a process to manage the transformation of doctrine, organization, training, materiel, leadership and education, personnel, and facilities necessary to make the vision a reality. JV 2020 builds on this foundation of success and will sustain the momentum of these processes.

Our objective in implementing the joint vision is the optimal integration of all joint forces and effects.

... the SecDef designated the CinC, JFC as the Executive Agent for experimentation design, preparation, execution, and assessment.

The linchpin of progress from vision to experimentation to reality is joint training and education.

5. Conclusion.

This vision is firmly grounded in the view that the US military must be a joint force capable of full spectrum dominance. Its basis is four-fold:

- The global interests of the United States and the continuing existence of a wide range of potential threats to those interests
- The centrality of information technology to the evolution of not only our own military, but also the capabilities of other actors around the globe
- The premium a continuing broad range of military operations will place on the successful integration of multinational and interagency partners and the interoperability of processes, organizations, and systems
- Our reliance on the joint force as the foundation of future US military operations

Excerpts from A National Security Strategy for a New Century

1. Introduction

Our national security strategy is designed to meet the fundamental purposes set out in the preamble to the Constitution:

...provide for the common defense, promote the general Welfare, and secure the Blessings of Liberty to ourselves and our Posterity,...

Opportunities and Challenges

Many former adversaries now work with us for common goals. The dynamism of the global economy is transforming commerce, culture, communications and global relations, creating new jobs and opportunities for Americans.

Globalization, however, also brings risks. Outlaw states and ethnic conflicts threaten regional stability and progress in many important areas of the world.

Increasingly important implications for American security include:

- Weapons of mass destruction (WMD),
- terrorism,
- drug trafficking and other international crime are global concerns that transcend national borders.

Other problems originating overseas which have security implications are:

- resource depletion,
- rapid population growth,
- environmental damage,
- new infectious diseases,
- pervasive corruption,
- uncontrolled refugee migration

National Interests

vital interests—those of broad, overriding importance to the survival, safety and vitality of our nation. Among these are the physical security of our territory and that of our allies, the safety of our citizens, the economic well-being of our society, and the protection of our critical infrastructures – including energy, banking and finance, telecommunications, transportation, water systems and emergency services – from paralyzing attack.

The second category is ***important national interests***. These interests do not affect our national survival, but they do affect our national well-being and the character of the world in which we live. Important national interests include, for example, regions in which we have a sizable economic stake or commitments to allies, protecting the global environment from severe harm, and crises with a potential to generate substantial and

highly destabilizing refugee flows. Our efforts to halt the flow of refugees from Haiti and restore democracy in that country, our participation in NATO operations to end the brutal conflicts and restore peace in Bosnia and Kosovo, and our assistance to Asian allies and friends supporting the transition in East Timor are examples.

The third category is *humanitarian and other interests*. Examples include responding to natural and manmade disasters; promoting human rights and seeking to halt gross violations of those rights; supporting democratization, adherence to the rule of law and civilian control of the military; assisting humanitarian demining; and promoting sustainable development and environmental protection. The spread of democracy and respect for the rule of law helps to create a world community that is more hospitable to U.S. values and interests.

Regional or State-Centered Threats:

A number of states have the capabilities and the desire to threaten our national interests through coercion or aggression. They continue to threaten the sovereignty of their neighbors, economic stability, and international access to resources. In many cases, these states are also actively improving their offensive capabilities, including efforts to obtain or retain nuclear, biological or chemical weapons and the capabilities to deliver these weapons over long distances.

Transnational threats: These are threats that do not respect national borders and which often arise from non-state actors, such as terrorists and criminal organizations.

Spread of dangerous technologies: Weapons of

mass destruction pose the greatest potential threat to global stability and security. Proliferation of advanced weapons and technologies threatens to provide rogue states, terrorists and international crime organizations with the means to inflict terrible damage on the United States, our allies and U.S. citizens and troops abroad. Foreign intelligence collection: The threat from foreign intelligence services is more diverse, complex and difficult to counter than ever before.

Environmental and health threats: Environmental and health problems can undermine the welfare of U.S. citizens, and compromise our national security, economic and humanitarian interests abroad for generations. These threats respect no national boundary.

A Strategy of Engagement

Our strategy is founded on continued U.S. engagement and leadership abroad. costs of defending U.S. interests – in dollars, effort and, when necessary, with military force.

Implementing the Strategy

International cooperation will be vital for building security in the next century because many of the challenges we face cannot be addressed by a single nation. Many of our security objectives are best achieved – or can only be achieved – by leveraging our

influence and capabilities through international organizations, our alliances, or as a leader of an ad hoc coalition formed around a specific objective.

II. Advancing U.S. National Interests

In our vision of the world, the United States has close cooperative relations with the world's most influential countries, and has the ability to shape the policies and actions of those who can affect our national well-being.

Enhancing Security at Home and Abroad

Our strategy for enhancing U.S. security has three components:

1. shaping the international security environment,
2. responding to threats and crises,
3. and preparing for an uncertain future.

Shaping the International Environment

The United States seeks to shape the international environment through a variety of means, including diplomacy, economic cooperation, international assistance, arms control and nonproliferation, and health initiatives.

Diplomacy

Diplomacy is a vital tool for countering threats to our national security. The daily business of diplomacy conducted through our missions and representatives around the world is an irreplaceable shaping activity.

Public Diplomacy

International Assistance

From the U.S.-led mobilization to rebuild post-war Europe to more recent economic success stories across Asia, Latin America and Africa, U.S. foreign assistance has helped emerging democracies, promoted respect for human rights and the rule of law, expanded free markets, slowed the growth of international crime, contained major health threats, improved protection of the environment and natural resources, slowed population growth, and defused humanitarian crises.

Arms Control and Nonproliferation

Arms control and nonproliferation initiatives are an essential element of our initiatives are an essential element of our national security strategy and a critical complement to our efforts to defend our nation through our own military strength.

Military Activities

Our nuclear posture is one example of how U.S. military capabilities are used effectively to deter aggression and coercion against U.S. interests.

Through overseas presence and peacetime engagement activities such as defense cooperation, security assistance, and training and exercises with allies and friends, our Armed Forces help to deter aggression and coercion, build coalitions, promote regional stability and serve as role models for militaries in emerging democracies.

Strategic mobility is a key element of our strategy. We are committed to maintaining leadership in space. We are also committed to maintaining information superiority. Quality people are our most important asset.

Responding to Threats and Crises

Because our shaping efforts alone cannot guarantee the international security environment we seek, the US must be able to respond at home and abroad to the full spectrum of threats and crises that may arise.

Transnational Threats

Transnational threats include terrorism, drug trafficking and other international crime, and illegal trade in fissile materials and other dangerous substances

Terrorism

To respond to terrorism incidents overseas, the State Department leads an interagency team, the Foreign Emergency Support Team (FEST), which is prepared to deploy on short notice to the scene of an incident. Whenever possible, we use law enforcement and diplomatic tools to wage the fight against terrorism. But there have been, and will be, times when those tools are not enough.

Drug Trafficking and other International Crime

The aim of our drug control strategy is to cut illegal drug use and availability in the US by 50 percent by 2007 – and reduce the health and social consequences of drug use and trafficking by 25 percent over the same period, through expanded prevention efforts, improved treatment programs, strengthened law enforcement and tougher interdiction. Our strategy recognizes that, at home and abroad, prevention, treatment and economic alternatives, must be integrated with intelligence collection, law enforcement and interdiction efforts.

Other International Crime

Money laundering, corruption, extortion undermine legitimate governments and imperil fragile democracies. The US is negotiating and implementing new and updated extradition and mutual legal assistance treaties, and increasing our enforcement options through agreements on asset seizure, forfeiture, and money laundering to fight these problems.

Because of the global nature of information networks, no area of criminal activity has greater international implications than high technology crime.

Defending the Homeland

Our potential enemies, whether nations or terrorists, may be more likely in the future to resort to attacks against vulnerable civilian targets in the United States. At the same time, easier access to sophisticated technology means that the destructive power available to rogue nations and terrorists is greater than ever. Adversaries may be tempted to use long-range ballistic missiles or unconventional tools, such as WMD, financial destabilization, or information attacks, to threaten our citizens and critical national infrastructures at home.

National Missile Defense

We are committed to meeting the growing danger posed by nations developing and deploying long-range missiles that could deliver weapons of mass destruction against the United States

Countering Foreign Intelligence Collection

The United States is a primary target of foreign intelligence services due to our military, scientific, technological and economic preeminence. Although difficult to quantify, economic and industrial espionage result in the loss of millions of dollars and thousands of jobs annually. To protect sensitive national security information, we must be able to effectively counter the collection efforts of foreign intelligence services through vigorous counterintelligence efforts and security programs. Over the last five years, we have created new counterintelligence mechanisms to address economic and industrial espionage and implemented procedures to improve coordination among intelligence, counterintelligence and law enforcement agencies. These measures have considerably strengthened our ability to counter the foreign intelligence collection threat. We will continue to refine and enhance our counterintelligence capabilities as we enter the twenty-first century.

Domestic Preparedness Against

Weapons of Mass Destruction

The Federal Government will respond rapidly and decisively to any terrorist incident in the United States involving WMD, working with state and local governments to restore order and deliver emergency assistance. The Domestic Terrorism Program is integrating the capabilities and assets of a number of Federal agencies to support the FBI, FEMA, the Department of Health and Human Services, and state and local governments in crisis response and managing the consequences of a WMD incident.

Critical Infrastructure Protection

Our national security and our economic prosperity rest on a foundation of critical infrastructures, including telecommunications, energy, banking and finance, transportation, water systems and emergency services.

The President has directed that a plan for defending our critical infrastructures be in effect by May 2001, and fully operational by December 2003. Through this plan we will achieve and maintain the ability to protect our critical infrastructures from intentional acts that would significantly diminish the ability of the Federal Government to perform essential national security missions.

National Security Emergency Preparedness

We will do all we can to deter and prevent destructive and threatening forces such as terrorism, WMD use, disruption of our critical infrastructures, and regional or state-centered threats from endangering our citizens. But if an emergency occurs, we must be prepared to respond effectively at home and abroad to protect lives and property, mobilize the personnel, resources and capabilities necessary to effectively handle the emergency, and ensure the survival of our institutions and infrastructures. To this end, we will sustain our efforts to maintain comprehensive, all-hazard emergency planning by federal departments, agencies and the military, as well as a strong and responsive industrial and technology base, as crucial national security emergency preparedness requirements.

Smaller-Scale Contingencies

In addition to defending the U.S. homeland, the United States must be prepared to respond to the full range of threats to our interests abroad. Smaller-scale contingency operations encompass the full range of military operations short of major theater warfare, including humanitarian assistance, peace operations, enforcing embargoes and no-fly zones, evacuating U.S. citizens, and reinforcing key allies. These operations will also put a premium on the ability of the U.S. military to work closely and effectively with other U.S. Government agencies, non-governmental organizations, regional and international security organizations and coalition partners.

Accordingly, appropriate U.S. forces will be kept at a high level of readiness and will be trained, equipped and organized to be capable of performing multiple missions at one time.

Major Theater Warfare

Fighting and winning major theater wars is the ultimate test of our Armed Forces – a test at which they must always succeed. For the foreseeable future, the United States, preferably in concert with allies, must have the capability to deter and, if deterrence fails, defeat large-scale, cross-border aggression in two distant theaters in overlapping time frames. Fighting and winning major theater wars entails three challenging requirements.

First, we must maintain the ability to rapidly defeat initial enemy advances short of the enemy's objectives in two theaters, in close succession.

Second, the United States must be prepared to fight and win under conditions where an adversary may use asymmetric means against us – unconventional approaches that avoid or undermine our strengths while exploiting our vulnerabilities.

Third, our military must also be able to transition to fighting major theater wars from a posture of global engagement – from substantial levels of peacetime engagement overseas as well as multiple concurrent smaller-scale contingency operations. reduce the greater risk incurred if we failed to respond adequately to major theater wars.

The Decision to Employ Military Forces

In those specific areas where our **vital interests** are at stake, our use of force will be decisive and, if necessary, unilateral. In situations posing a threat to **important national interests**, military forces should only be used if they advance U.S. interests, they are likely to accomplish their objectives, the costs and risks of their employment are commensurate with the interests at stake, and other non-military means are incapable of achieving our objectives. The decision to employ military forces to support our **humanitarian and other interests** focuses on the unique capabilities and resources the military can bring to bear, rather than on its combat power.

Preparing for an Uncertain Future

We must prepare for an uncertain future even as we address today's security problems. We must transform our capabilities and organizations – diplomatic, defense, intelligence, law enforcement, and economic – to act swiftly and to anticipate new opportunities and threats in today's continually evolving, highly complex international security environment. Preparing for an uncertain future also means that we must have a strong, competitive, technologically superior, innovative and responsive industrial and research and development base. Within the military, transformation requires that we strike a balance among funding three critical priorities:

1. maintaining the ability of our forces to shape and respond today,
2. modernizing to protect the long-term readiness of the force, and
3. transforming our unparalleled capabilities to ensure we can effectively shape and respond in the future.

We also must work with Allies and coalition partners to help improve their defense capabilities and interoperability with our forces, in order to bolster the effectiveness of multinational operations across the full spectrum of potential military missions.

we seek to leverage technological, doctrinal, operational and organizational innovations to give U.S. forces greater capabilities and flexibility. Joint Forces Command and the Armed Services are pursuing an aggressive, wide-ranging innovation and experimentation program to achieve that transformation.

Promoting Prosperity

The second core objective of our national security strategy is to promote America's prosperity through efforts at home and abroad. Our economic and security interests are inextricably linked.

Strengthening Financial Coordination

As national economies become more integrated internationally, U.S. prosperity depends more than ever on economic developments abroad. Cooperation with other states and international organizations is vital to protecting the health of the global economic system and responding to financial crises.

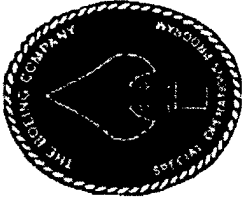

12th Annual Special Operations/ Low Intensity Conflict (SO/LIC) Symposium & Exhibition



Tuesday, February 13, 2001

(Morning Session)



7:00 - 8:00 a.m.

Continental Breakfast

8:00 - 8:20 a.m.

Welcome: *LTG Lawrence F. Skibbie*

Opening Remarks: *MG William C. Moore*

Symposium Introduction: *Col Ron F. Henderson /
Col James W. Kraus*

8:20 - 9:00 a.m.

Keynote Address: *Mr. Robert F. Newberry, Principal Deputy
Assistant Secretary of Defense SO/LIC
"SO/LIC Transformation, Capabilities, Future Requirements"*

9:00 - 10:30 a.m.

Presentations and Panel Discussions

10:30 - 11:00 a.m.

Break – Tour of Exhibit Area

11:00 - 12:00 p.m.

Plenary Session: *LTC Bruce J. Reider, U.S. Army, Chairman,
Future Concepts Working Group, USSOCOM
"USSOCOM's Future Concepts Working Group (FCWG)"*

12:00 - 1:15 p.m.

Luncheon Served in Exhibit Area



Tuesday, February 13, 2001

(Afternoon Session)



1:15 - 2:45 p.m.

Presentations and Panel Discussions

“Technology, Research and Development, and Acquisition to Support a SO/LIC Strategy Transformation.”

Moderator:

Col Tim Davidson, U.S. Air Force (Ret)

2:45 - 3:15 p.m.

Break – Exhibit Area Open

3:15 - 5:15 p.m.

Plenary Session

“Special Operations Commanders Panel”

Moderator:

MG Geoffrey C. Lambert, U.S. Army, Director, Operations, Plans and Policy, USSOCOM

5:30 - 7:00 p.m.

Reception and Technology Showcase – Exhibit Area

7:00 - 9:00 p.m.

Awards Banquet

**Master of Ceremonies: MG William C. Moore, U.S. Army (Ret),
Chairman, SO/LIC Division, NDIA**

**Address: GEN Henry H. Shelton, U.S. Army, Chairman
of the Joint Chiefs of Staff**

“Appreciation of the SO/LIC Warrior”





Wednesday, February 14, 2001 (Morning Session)

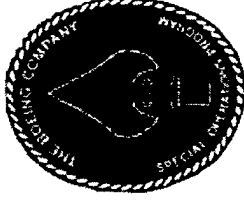

7:00 - 8:00 a.m.

Continental Breakfast

8:00 - 11:30 a.m.

SO/LIC Functional Area and Requirements Seminars

Seminar #1 – “SO/LIC and America’s War on Drugs”

**Seminar #2 – “Responding to Weapons of Mass Destruction /
Terrorism on Military Installations”**

Seminar #3 – “The Service Battle Labs”

Seminar #4 – “The Information Environment of SO/LIC”

Seminar #5 – “SO/LIC Role in Multinational Warfare”

**Seminar #6 – “Marine Expeditionary Unit, Special Operations
Capable MEU (SOC) Organization, Mission and
Capabilities”**

11:30 - 12:15 p.m.

**Tour of Exhibits by CINCUSOCOM – Last chance
to review displays**

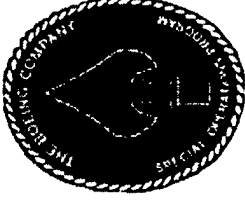

Wednesday, February 14, 2001 **(Afternoon Session)**

- 12:15 - 2:00 p.m. Keynote Luncheon Presentation:**
***“The State of the Command – SO/LIC
and U.S. National Security Strategy”***
- General Charles R. Holland, U.S. Air Force,
Commander-in-Chief, U.S. Special Operations
Command**
- 2:00 - 2:30 p.m. Concluding Comments, Adjournment, and
Distribution of Proceedings**



Seminar #1

SO/LIC Functional Area and Requirements



“SO/LIC and America’s War on Drugs”

Moderator: COL Tim O’Connell, U.S. Army (Ret)

***Mr. Bob Brown, Deputy Director (Acting), Supply Reduction
Office of National Drug Control Policy***

***CAPT Joseph Conroy, U.S. Coast Guard, Chief, Office of Law
Enforcement, Headquarters, U.S. Coast Guard***

***Col John C. “Duck” Mosbey, U.S. Air Force, Chief,
Counterdrug Office National Guard Bureau***

***Dr. Ken Allard, Colonel, U.S. Army (Ret) Vice President,
STRATFOR.com***

CAPT (S) Robert Winneg, U.S. Navy, OASD (SO/LIC)





Seminar #2
SO/LIC Functional Area and Requirements

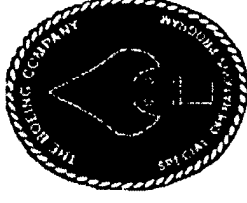

***“Responding to Weapons of Mass Destruction / Terrorism
on Military Installations”***

Moderator: Brig Gen Roger C. Smith, U.S. Air Force (Ret)

COL Charles Billingsly, U.S. Army, OASD SO/LIC

***Mr. Brett Burdick, Director, Technological Hazards Division
Commonwealth of Virginia***

***Mr. Eric E. Hahn, Environmental Safety Group
City of Boston Police Department***

***Mr. Robert Jevic, Office of Emergency Preparedness
Department of Health and Human Services***

***Captain Robert Ingram, HAZMAT Operations,
City of New York Fire Department***

***Mr. John Kimball, U.S. Fire Administration
Federal Emergency Management Agency***



Seminar #3

SO/LIC Functional Area and Requirements



"The Service Battle Labs"

Moderator: Mr. Frank W. Cooper, Concurrent Technologies Corp.

"Dismounted Battlespace Battle Lab"

Col. Frank Stone, U.S. Army, Director of Combat Developments, U.S. Army Infantry Center, Ft Benning, Georgia

"Diver Propulsion Devices (DPD) and Their Impact on Future Marine Reconnaissance Infiltration Capabilities"

CPT Randall Hoffman, USMC, Amphibious Raids & Reconnaissance Project Officer, Marine Corps Systems Command

"Army Special Operations Forces Digital Command and Control Challenges"

Dr. John Basehart, Deputy Director, Army Special Operations Battle Lab, Ft. Bragg, North Carolina

"Tactical Unmanned Aerial Vehicle (TUAV) Reconnaissance Support to Small Scale Contingencies (SSC)"

Lt Col Janice M. Morrow, USAFR, Chief, Plans, Programs and Technologies and TSgt Christopher Crutchfield, UAV Mission Commander, USAF, Hurlburt Field, FL

"Deployed Environmental Surveillance System (DESS)" and "Chemical and Biological Aerosol Warning System (CBAWS)"

Lt Col James A. Swaby, Deputy Director, U.S. Air Force, Force Protection Battle Lab, San Antonio, TX





Seminar #4

SO/LIC Functional Area and Requirements



“The Information Environment of SO/LIC”

Co-moderators: COL John J. Meyer, III, U.S. Army (Ret) President, Seafox Associates; COL AI DeProspero, U.S. Army (Ret)

COL Paul T. Hengst, U.S. Army, Chief Information Officer (CIO), USSOCOM

COL John Defreitas, U.S. Army, Senior Intelligence Officer, USSOCOM

Col Michael E. DeHart, U.S. Air Force, Director, Communications and Information, U.S. Air Force Special Operations Command

COL Donald Kopp, U.S. Army, Deputy Chief of Staff for Information Management, U.S. Army Special Operations Command

Mr. James W. Cluck, GS-15, Information and Intelligence Management Officer, USSOCOM



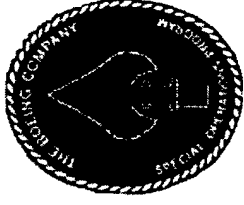

Seminar #5

SO/LIC Functional Area and Requirements

“SO/LIC Role in Multinational Warfare”

Moderator: COL Glen M. Harned, U.S. Army (Ret)

“The Gulf War Experience”.

COL James W. Kraus, U.S. Army (Ret)

“The NATO Model”.

COL William J. Flavin, U.S. Army (Ret)

“The Balkan Experience”.

***COL Peter J. Gustaitis, U.S. Army, J-33C
Deputy for Special Operations, The Joint Staff***

“The Korean Model”.

COL Glen M. Harned, U.S. Army (Ret)



Seminar #6

SO/LIC Functional Area and Requirements

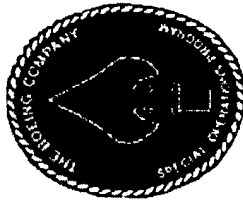

“Marine Expeditionary Unit, Special Operations Capable MEU (SOC) Organization, Mission and Capabilities”

Moderator: LtCol Mike Janay, U.S. Marine Corps (Ret)

***BG Gordon C. Nash, USMC, Director, Operations Division,
Headquarters Marine Corps***

***BG Richard F. Natonski, USMC, Director, Strategy and Plans
Division, Headquarters Marine Corps***

***Col Walter E. Gaskin, (Brigadier General Select) USMC,
Director, Training Command, MCCDC-Quantico***

***Col Richard T. Tryon, USMC, Commanding Officer – Marine
Barracks, 8th & I – Washington, DC***

LtCol Drew M. Watson, USMC

***Executive Officer – Coalition and Special Warfare,
MCCDC – Quantico***

***Maj. J. R. Brown III, USMC, MAGTF – Special Operations,
Operations Division, Headquarters Marine Corps***





**Department of Defense
Science and Technology Program**

12th Annual SO/LIC Symposium

13 February 2001

Dr. Delores M. Etter
Deputy Under Secretary of Defense (Science & Technology)

Mission

... to ensure
that the warfighters
today and tomorrow
have superior and
affordable technology
to support their
missions, and to give
them revolutionary
war-winning
capabilities.

Office of the Deputy Under Secretary of
Defense for Science and Technology

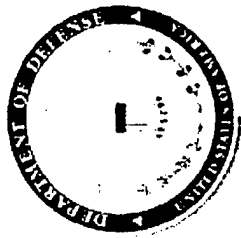

Defense Science and Technology



A Focus on Revolutionary Advances

Stealth



*Adaptive Optics
and Lasers*



GPS



Night Vision

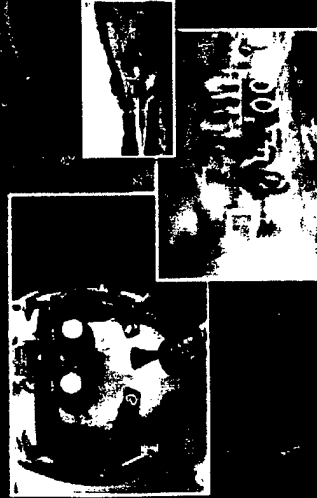

Phased Array Radar

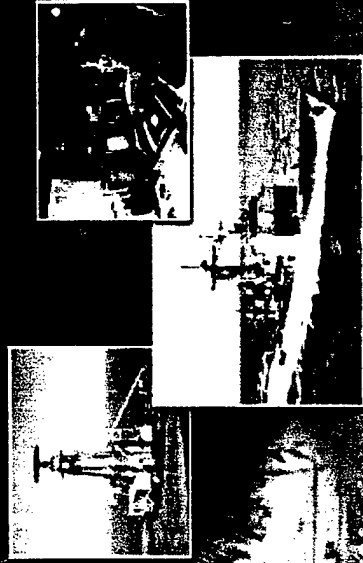

Strategic Environment



Global US Interests

Political - Economic - Humanitarian

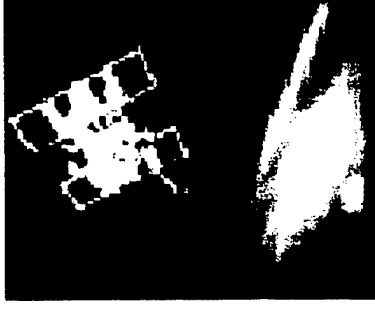

Asymmetric Threats

In any domain - Air, Land, Sea, Space or Information

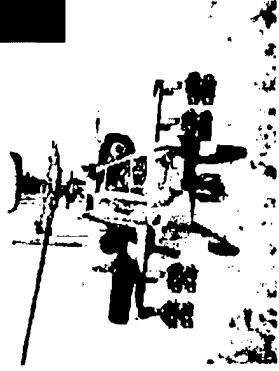

DUSD (S&T) Priorities 2001



Technical

- Basic Research
- JV 2020 Capabilities
- Revolutionary Capabilities
- Enabling Capabilities

Non-Technical

- Funding Stability
- Technology Transition
- S&T Workforce

Basic Research: Micro Robotics



Cricket Micro-Robot

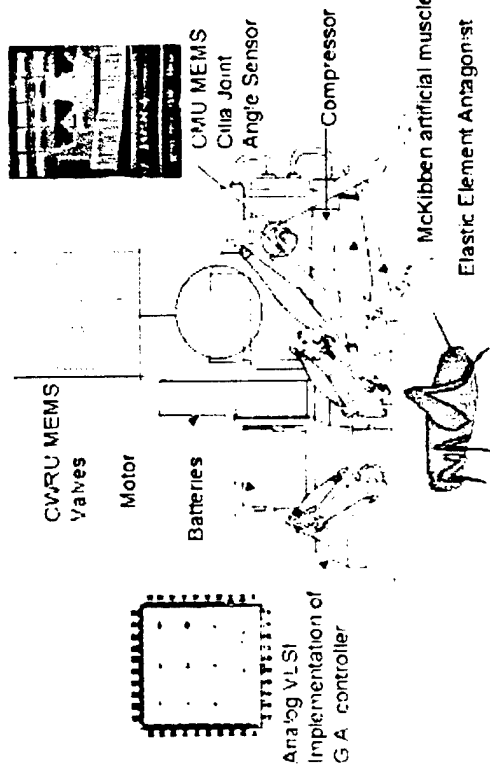

Ara log VLSI Implementation of G.A. controller

Millibots

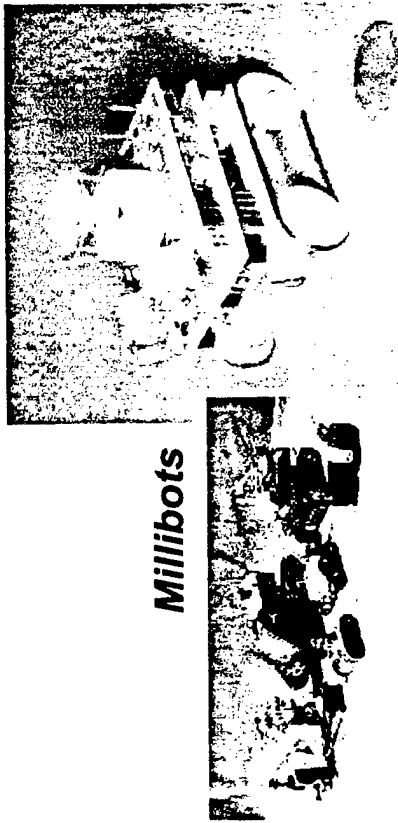

Underwater Robotarief



Robot III



K2T

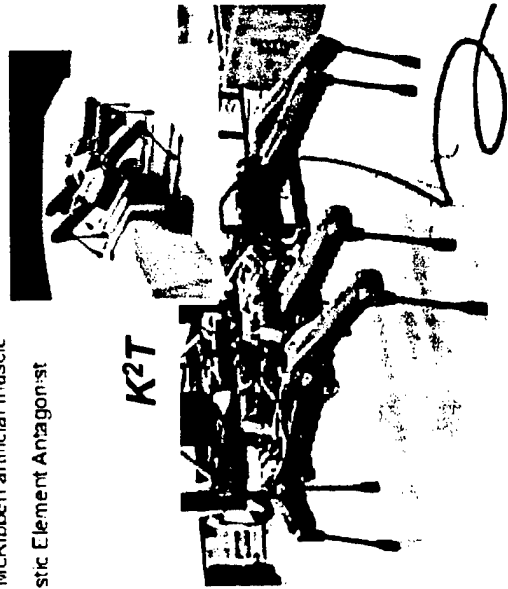

Basic Research: Micro Air Vehicles



MAVs
(3.5 in. and
6 in. models)

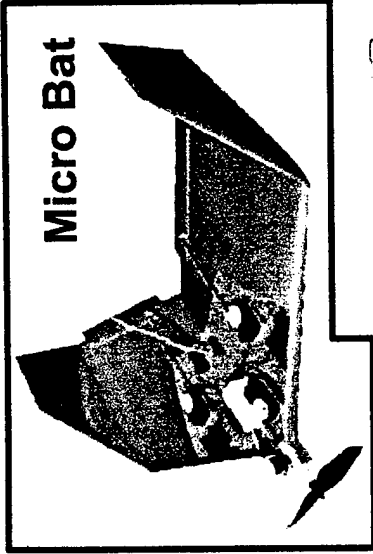

Micro Bat

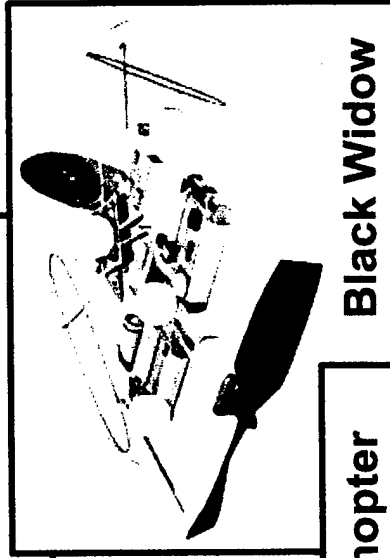

Black Widow

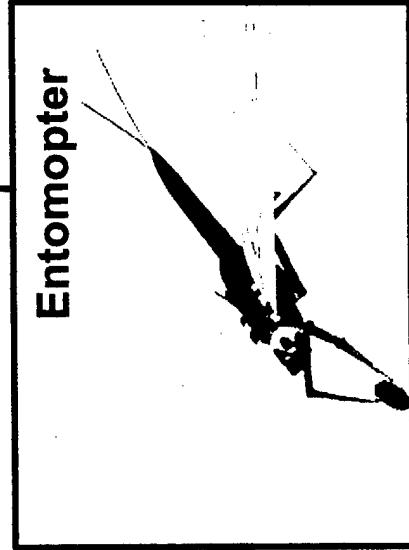

Entomopter

- Exoskeletal Chemical Muscle Reaction Chamber
- Exhaust Ports
- Wing Hinges
- Thermoelectric Generator
- Intensity Sensor-Actuated Trinary Steering
- Wing Ribs double as Gas Ducts to Circulation Control Points
- Fuel Storage and Metering is a part of Antenna Structure
- Antennas double as Trim Stabilizers
- Inflight, widely spread Surface Locomotors provide Anti-Roll Inertia with auxiliary fuel storage (mass) in legs/feet.

Basic Research: Micro Satellites

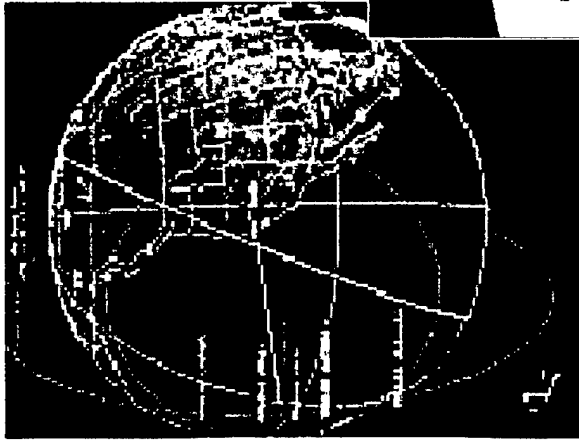

Picosatellites
< 2 Pounds

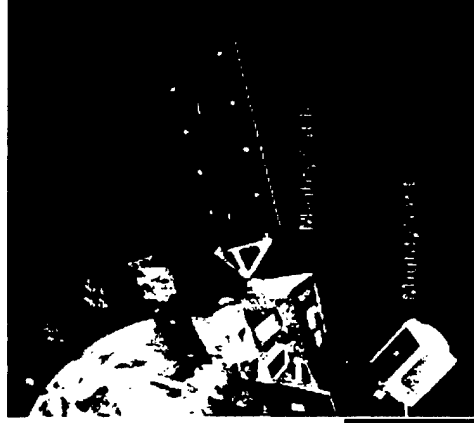

Small Satellites
200-2000 Pounds

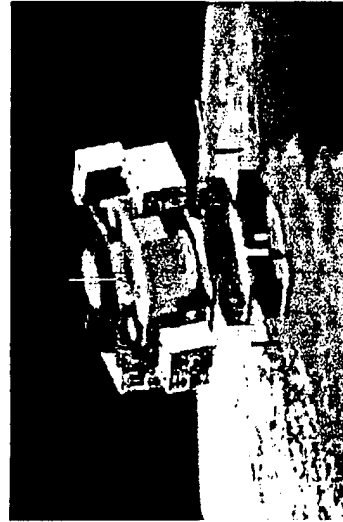
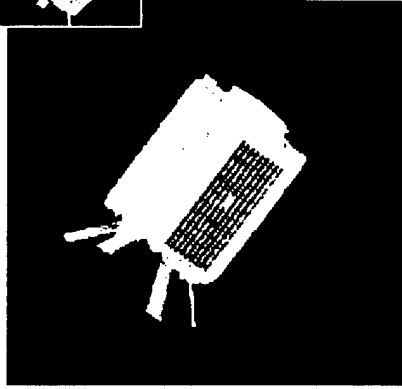

Nanosatellites
2-20 Pounds

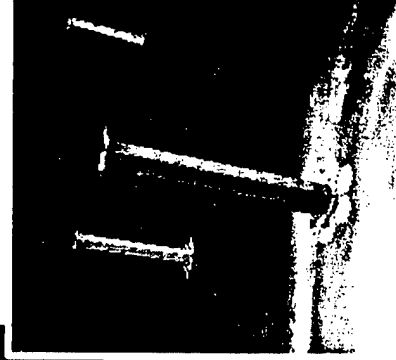

Microsatellites
20-200 Pounds

Basic Research: Smart Materials & Structures



- Elastic active materials
- Smart skins and coatings
- Distributed sensors and actuators
- Armor materials by design
- Adaptive structures

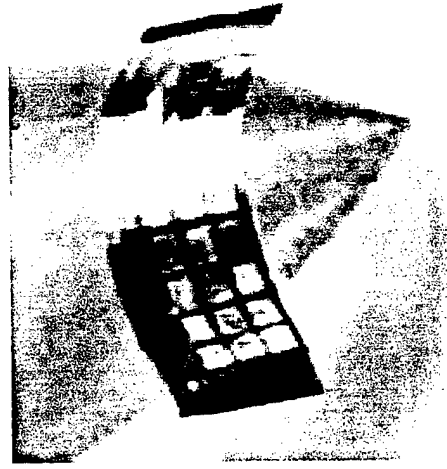

Flexible Sensor Skin

- Ultraquiet submarines,
- adaptive flight control,
- vibrational control,
- advanced stealth,
- armor materials

Basic Research: Nanotechnology

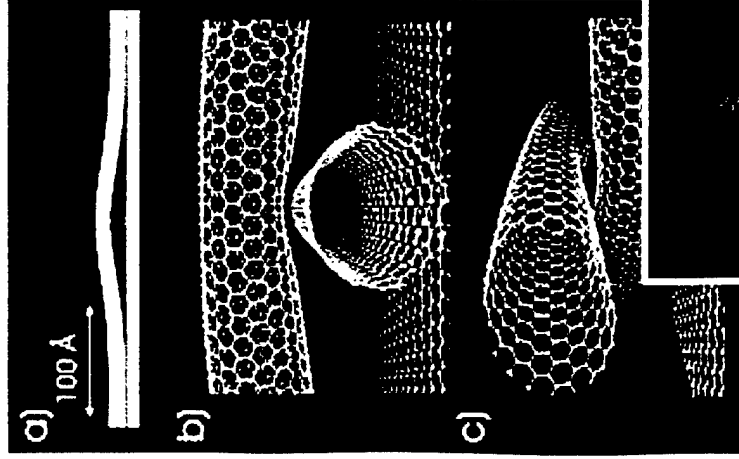

- *Carbon Computers*
- *Molecular Engineering*
- *Nanoscale Robots, Sensors, Machines*
- *Battery Electrode and Energy Storage*
- *Vacuum Microelectronics Devices*
- *Molecular Composites*

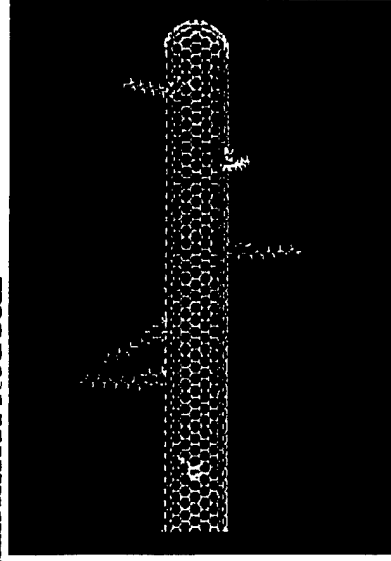
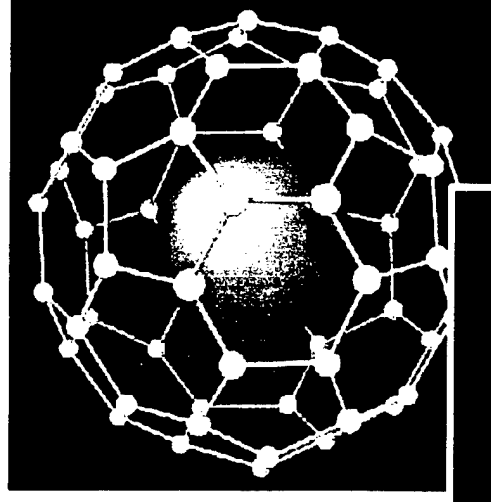

Multidisciplinary University Research Initiative (MURI)



MURI Themes for 2002

- **Energetics-** (explosives, propulsion, power)
- **Multifunction Materials-** (adaptive response to changing environments, sensors, warrior readiness, information flow)
- **Synergistic Sensing-** (battlespace awareness, combating terrorism, decision making)
- **Control for Adaptive and Cooperative Systems-** (adaptive command and control of swarms of micro air vehicles, robots, or satellite clusters)

Collective Behavior of Smaller, Smarter Systems



Goal: Collective Dynamic Intelligence in an Autonomous System

- Achieved By: Swarm Behavior in Low-Cost, Low-Tech Individual Entities & Cooperative Control



Lessons From Nature



Flocking Behavior



Collective Behavior



Collective Intelligence



- Systems Whose Purpose is:
 - To Act in Collaboration with Other Systems
 - To Produce Information that is Greater than the Sum of the Individual Components.



Swarm Movement



Let R be the
desired distance
between two
entities.

Let r be the
actual distance
between two
entities.

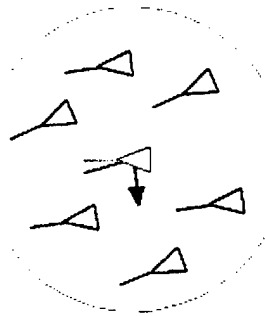

alignment

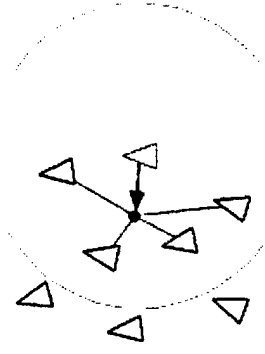

Cohesion
($r > R$)

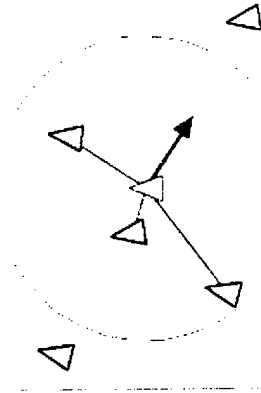

Separation
($r < R$)

Swarm Movement Model

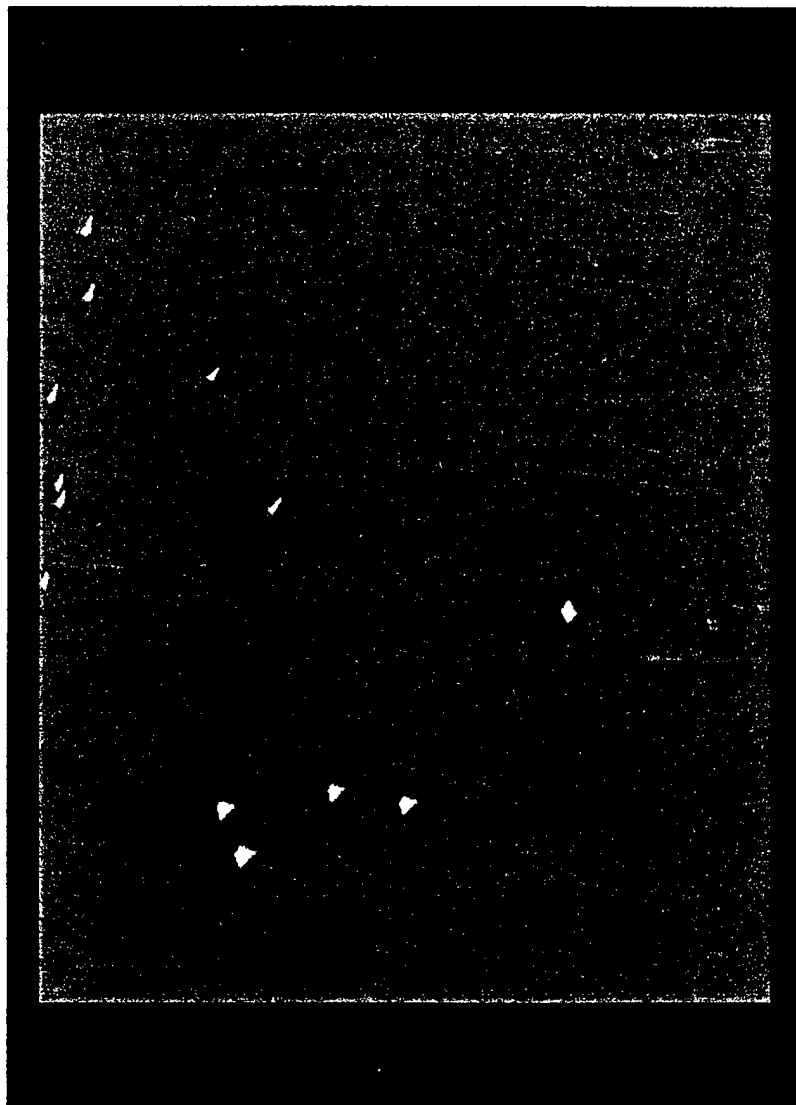

Simple Tasks with Collective Behavior



Move Items to Target Location

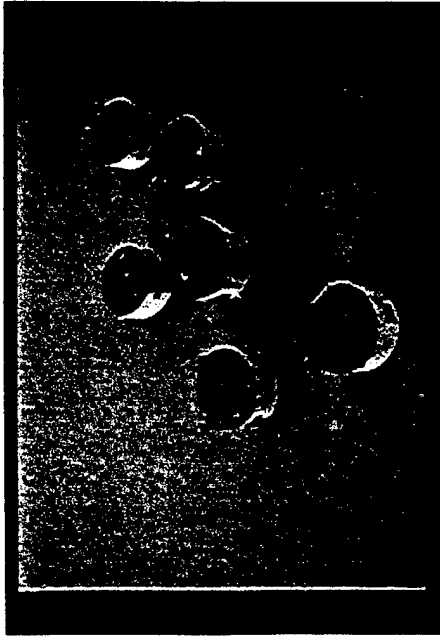

Locate Items and Cluster Around Them



Follow Signals, Locate and Move Items



Role Playing - Tag You're It





Platform for Autonomous Control of Distributed, Multi-Entity Systems in an Adversarial, Evolving, and Uncertain Environment

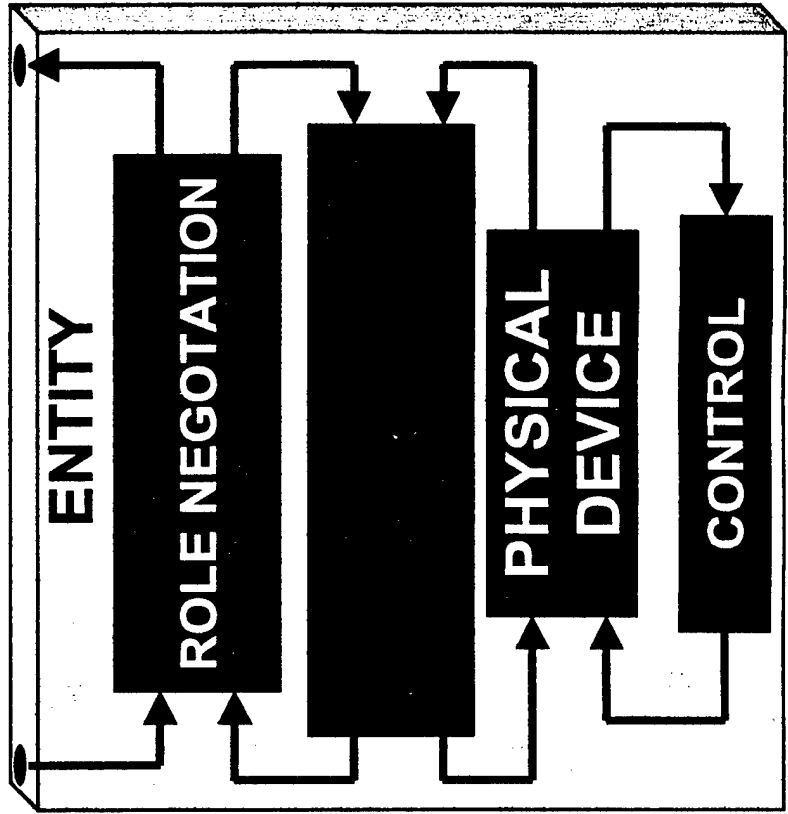
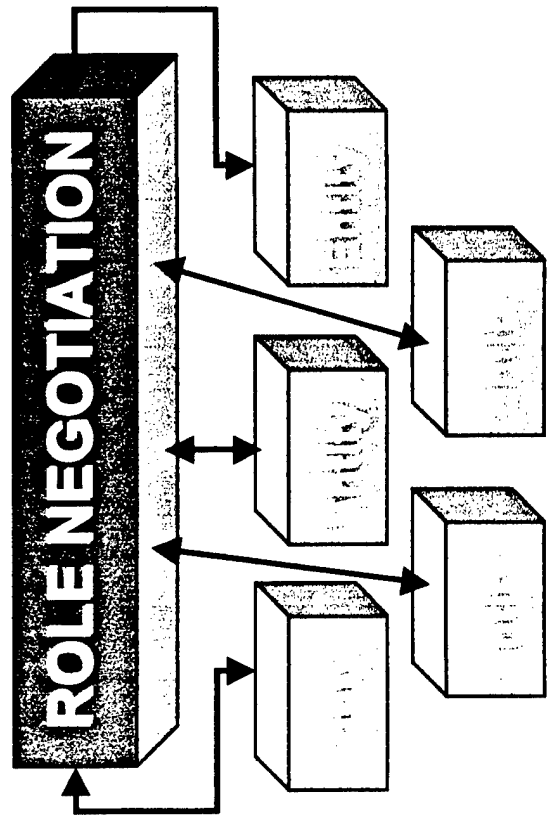
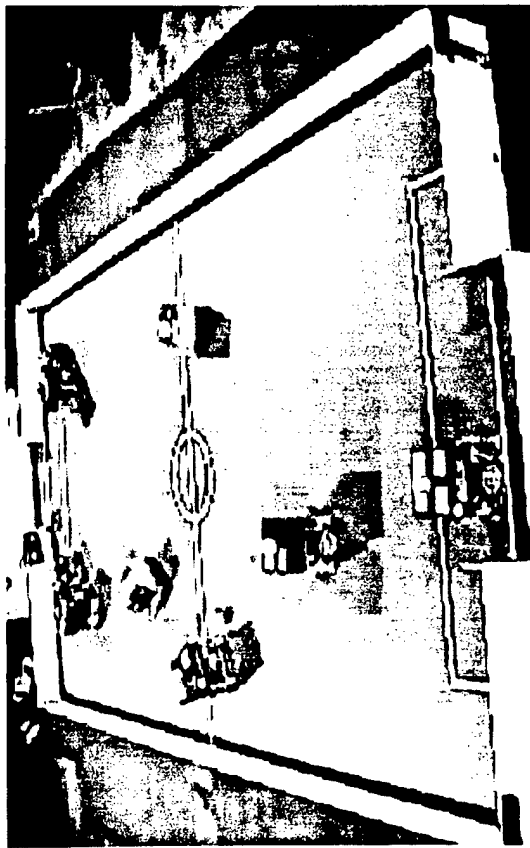

Robocup Tournament

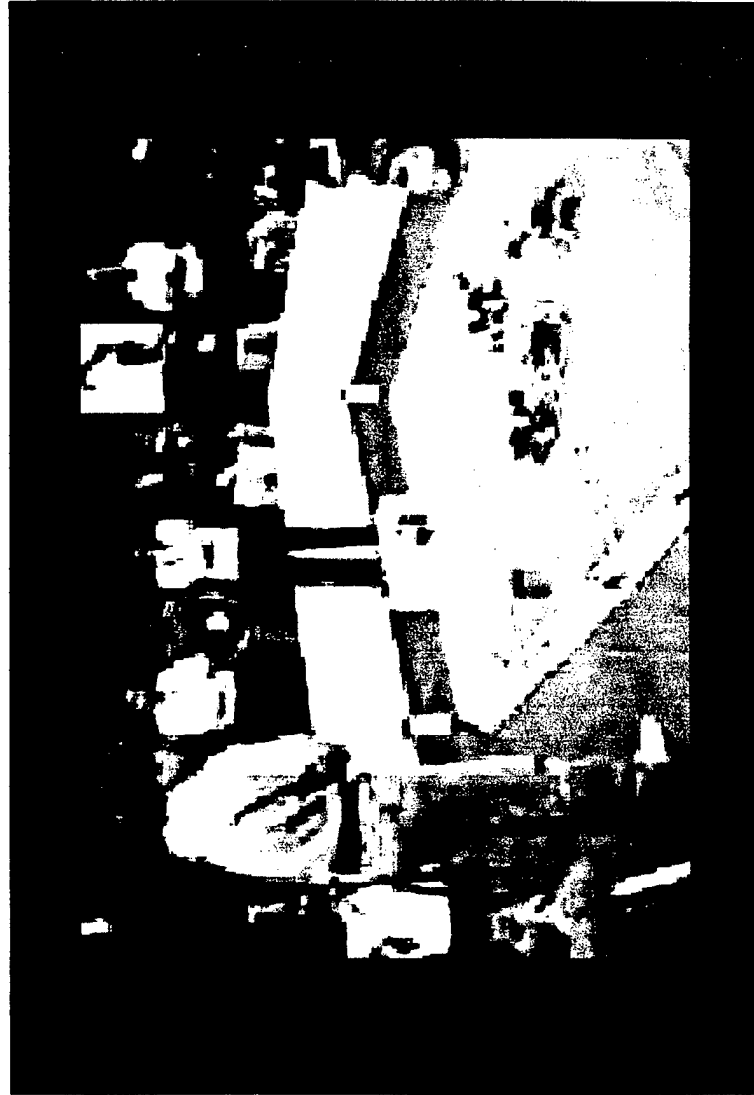

Basic UXO Gathering System (Bugs)



- Multiple Cooperative Behavior Robots

- Pick Up and Carry Away Submunitions

Blow in Place

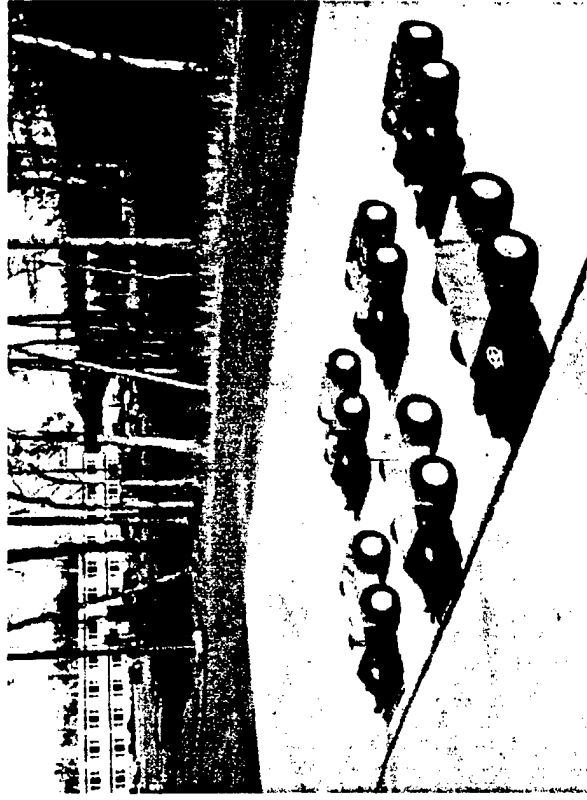
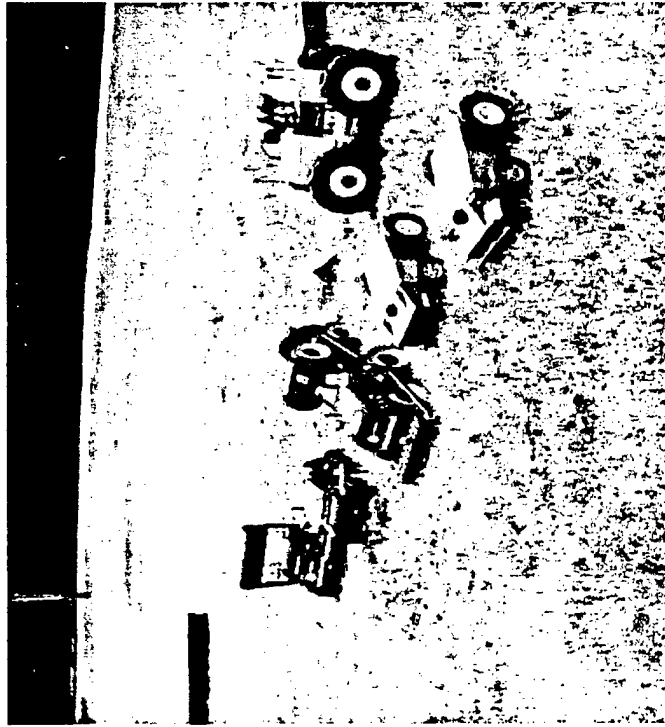

Basic UXO Gathering System (Bugs)



- Model Search Strategies

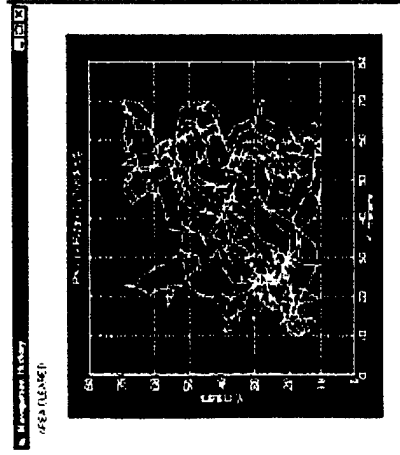

- Simulate Systems to Optimize Subsystems

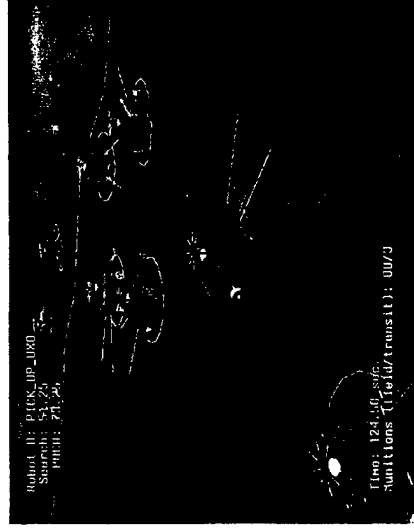

- Demonstrate Search Strategies Using Micro Robots

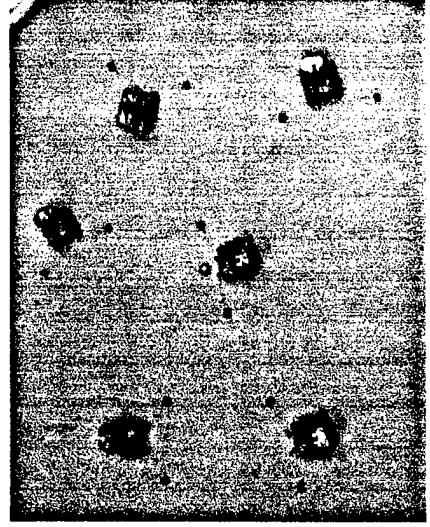



BUGS In Action



The Future of Satellites

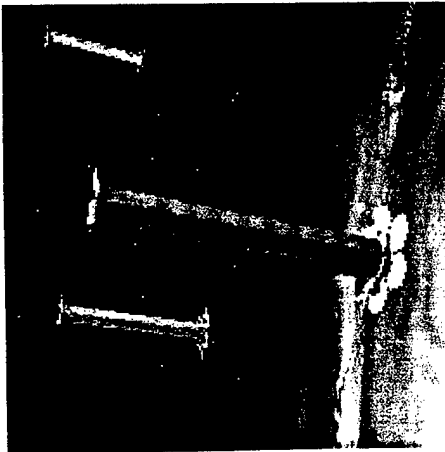

Microsatellites

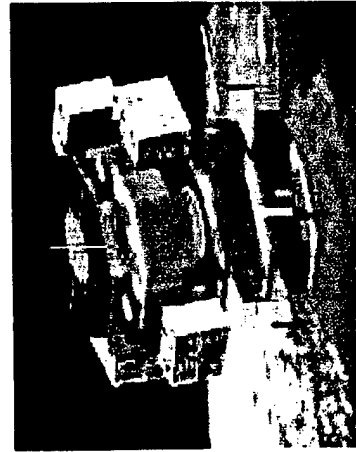

Nanosatellites



Smallsatellites

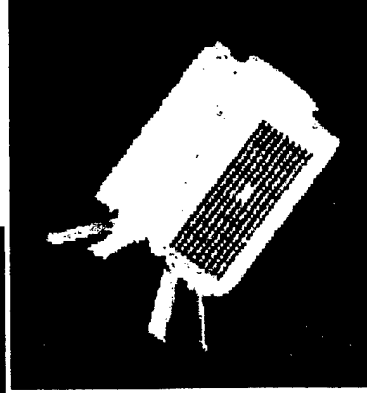
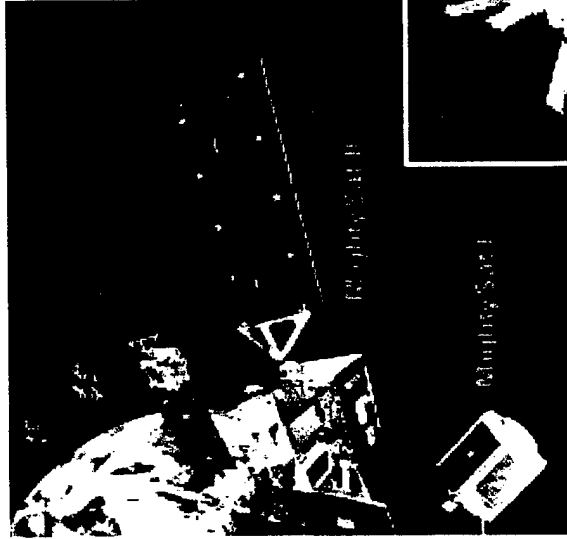

Collaborating Microsatellite Clusters TechSat 21



- Cluster of formation flying capable microsats form a “virtual satellite”
- Concept enables multi-mission capability
 - Space Based Radar
 - Communications
 - Geolocation

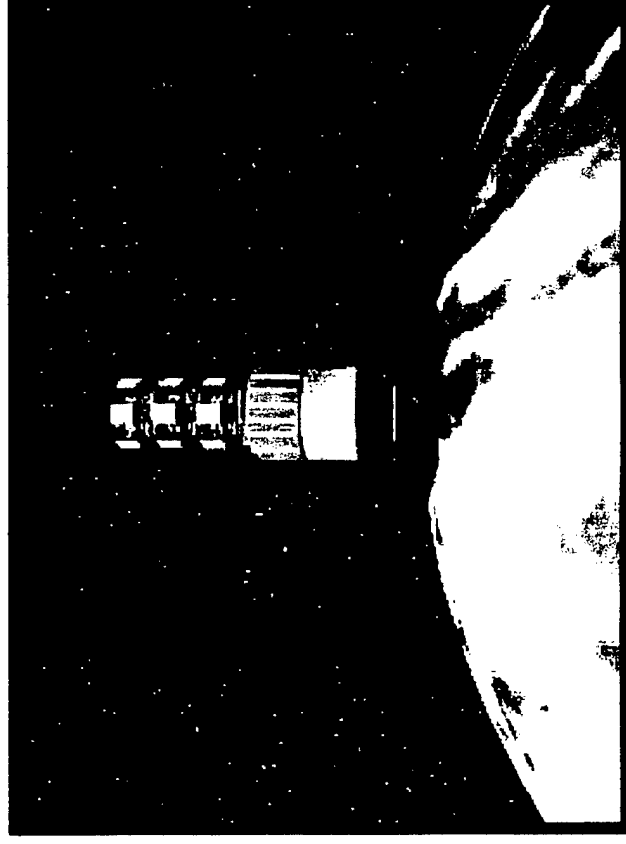

Goal: Affordable, Real-Time, On-Demand Global Awareness

Technology Transition Requires Strong Partnerships

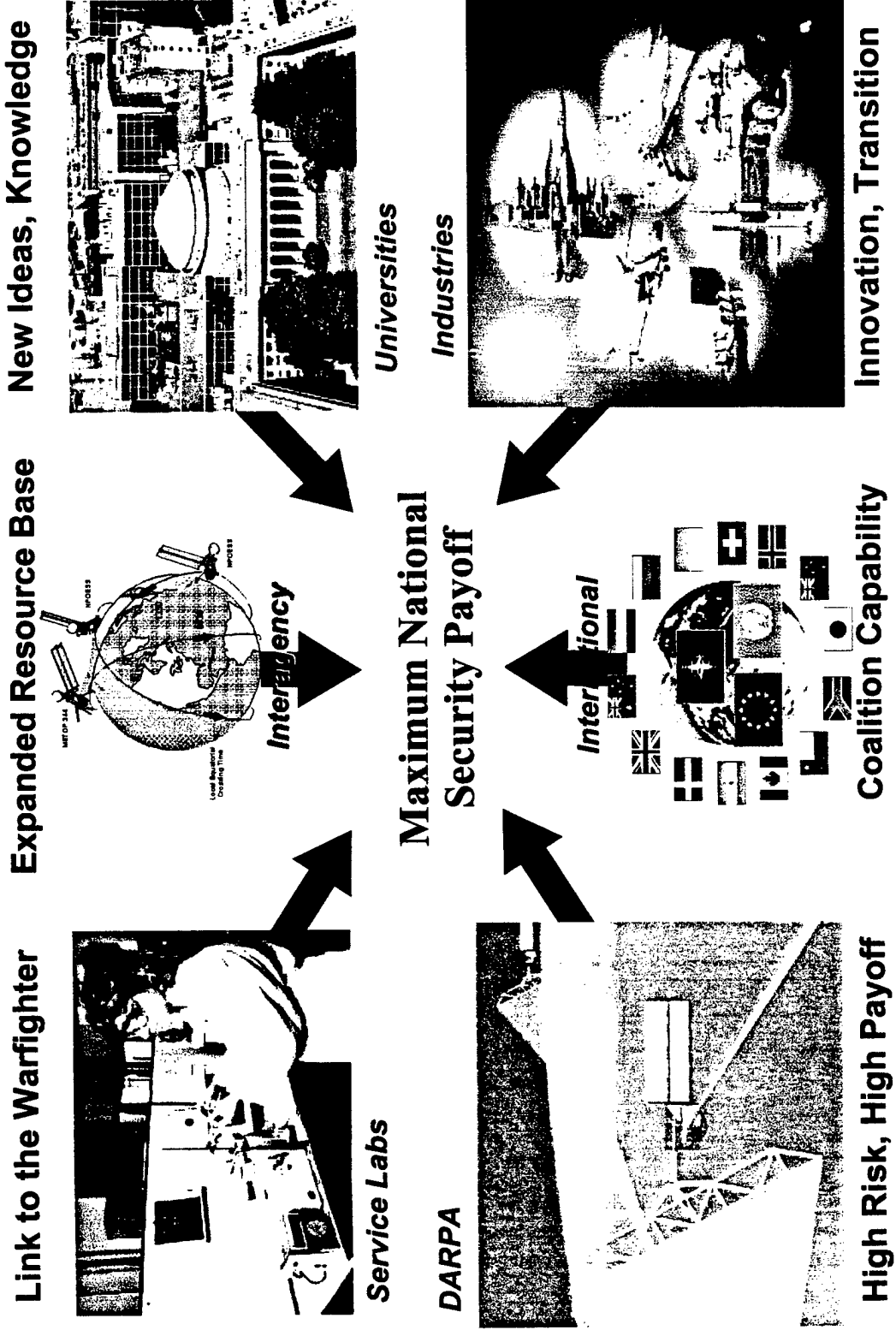

A Focus on Tomorrow's Possibilities



"**T**echnical Superiority is
Critical for National Security.
In peace, it provides deterrence;
In crisis, it provides options;
In war, it provides an edge."

Defense Science and Technology Strategy
May 2000



The National Drug Control Strategy



Robert E. Brown
Assistant Deputy Director for Supply Reduction
February 14, 2001



International Drug Control Strategy Based on the Drug Threat

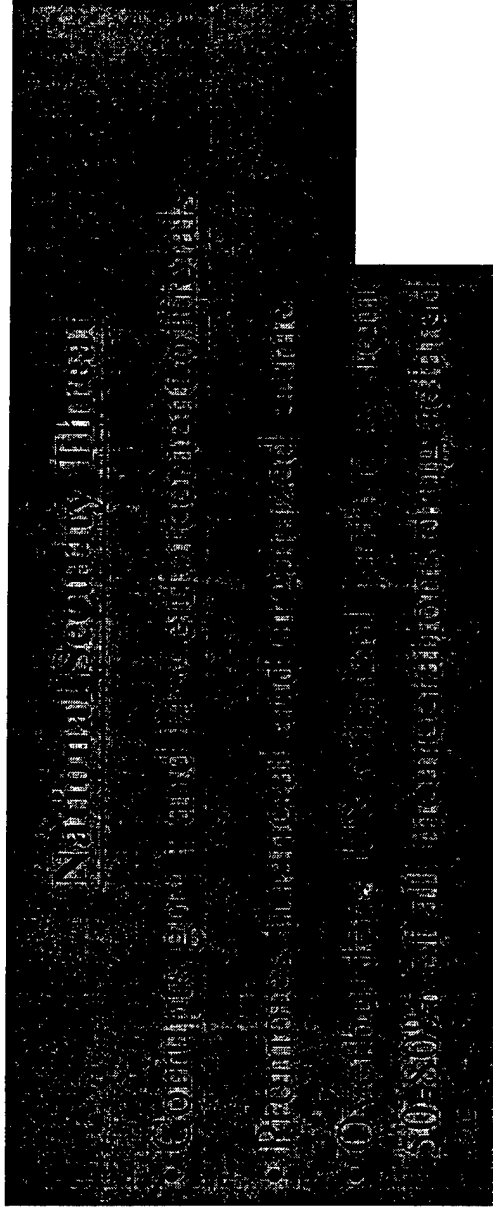

Health Threat

- Drug abuse kills 52,000 Americans annually
- Emergency Room Visits - Nearly 300,000 annually

Economic Threat

- Taxpayer Cost: Nearly \$ 110B/Annually
- \$63.2B annually spent on drugs



National Drug Control Strategy

Five Goals

- I: Educate and enable America's youth to reject illegal drugs as well as alcohol and tobacco.**
- II: Increase the safety of America's citizens by substantially reducing drug-related crime and violence.**
- III: Reduce health and social costs to the public of illegal drug use.**
- IV: Shield America's air, land, and sea frontiers from the drug threat.**
- V: Break foreign and domestic drug sources of supply.**



International Drug Control Priorities

- **Drug Priorities**
 - Cocaine
 - Heroin
 - Synthetics - increasing importance
 - Cannabis

- **Geographic Priorities**
 - Colombia
 - Mexico
 - Peru
 - Bolivia
 - Burma, Afghanistan, Laos, Thailand



Global Drug Production

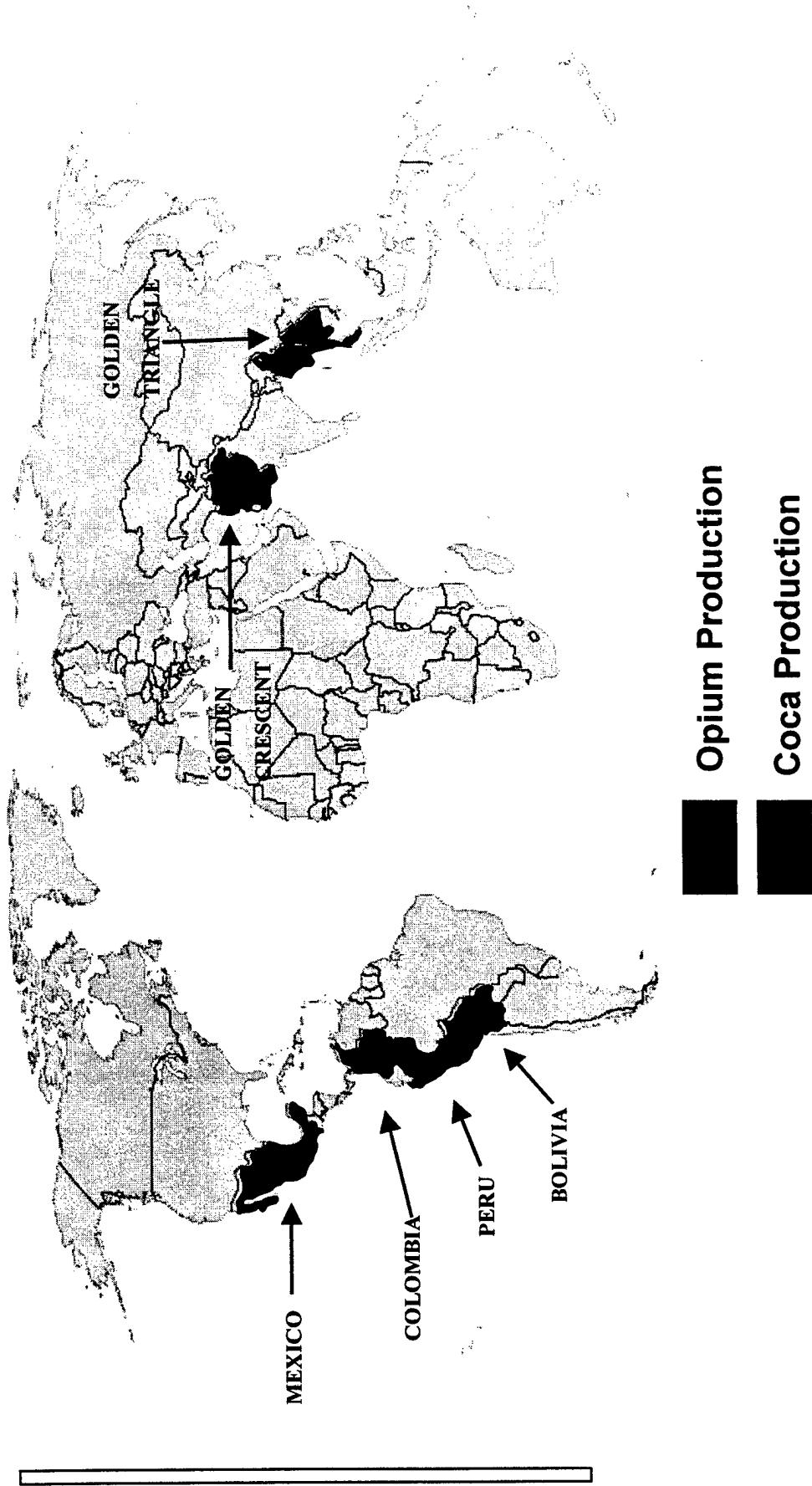



The Synthetics Threat

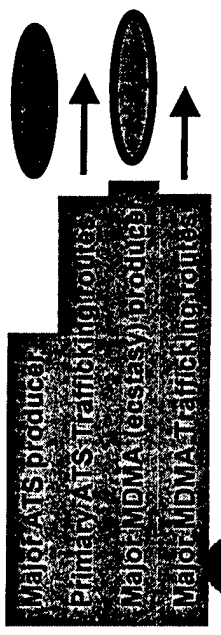
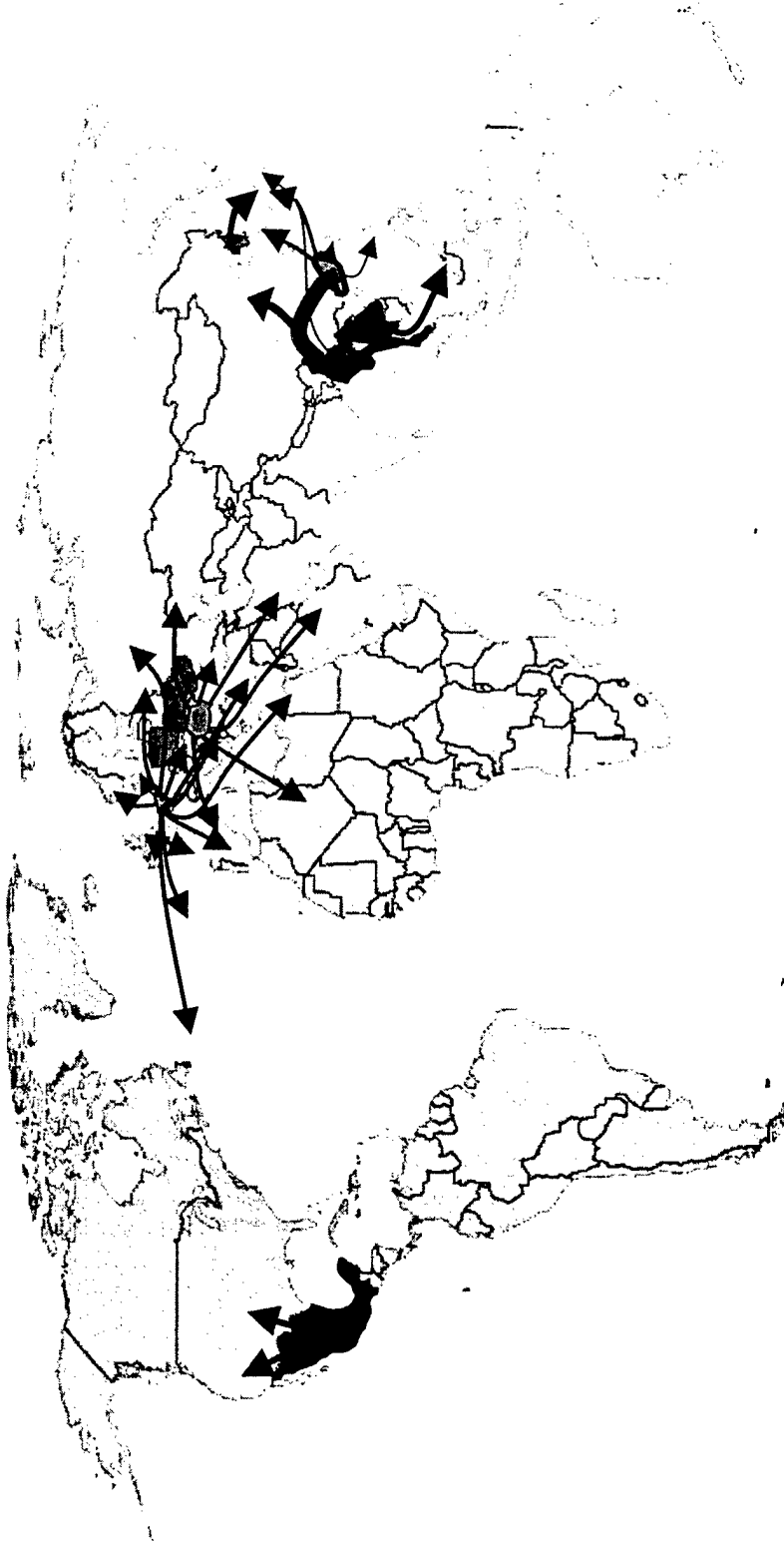



International Drug Control Strategy

Focus efforts on source countries

- Bolster source country resources, capabilities, and political will to:
 - Reduce cultivation
 - Attack production
 - Disrupt & dismantle trafficking organizations
- Assist host nations to:
 - Expand effective law enforcement control over growing areas
 - Reestablish the rule of law
 - Eliminate illegal drug crops

While also seeking to...

- Interdict drug shipments
- Maximize intelligence support
- Support democracy and safeguard human rights
- Fight drug-related corruption
- Build international cooperation



Mexico: Opium poppy at record low

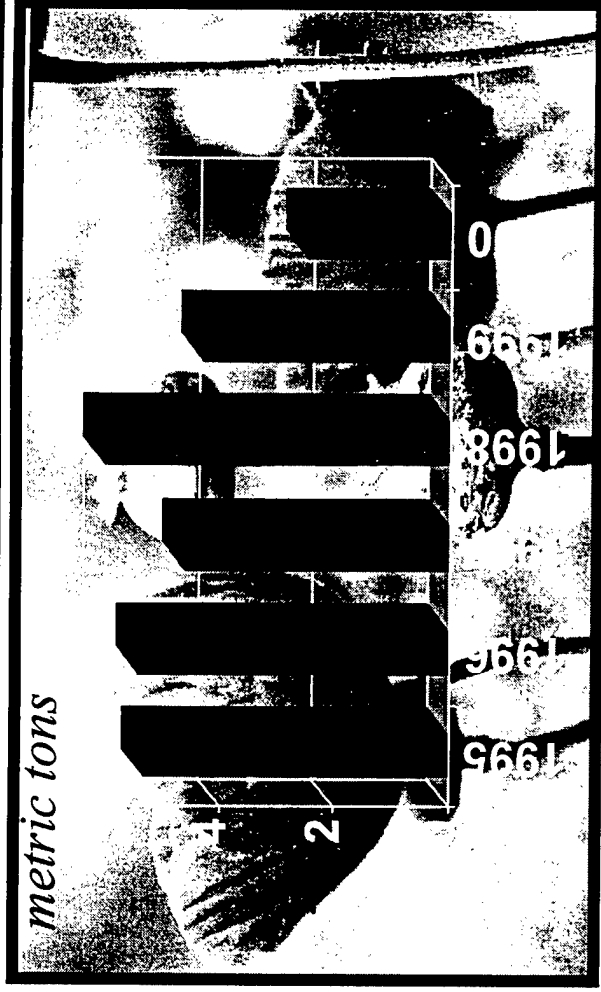

A second year of drought and a continuing aggressive eradication plagued the regions' narcotics farmers

- Crop fell nearly 50 percent to 1,900 ha
- Military plays key role in eradication effort



Source Zone Strategy is Working in Bolivia and Peru

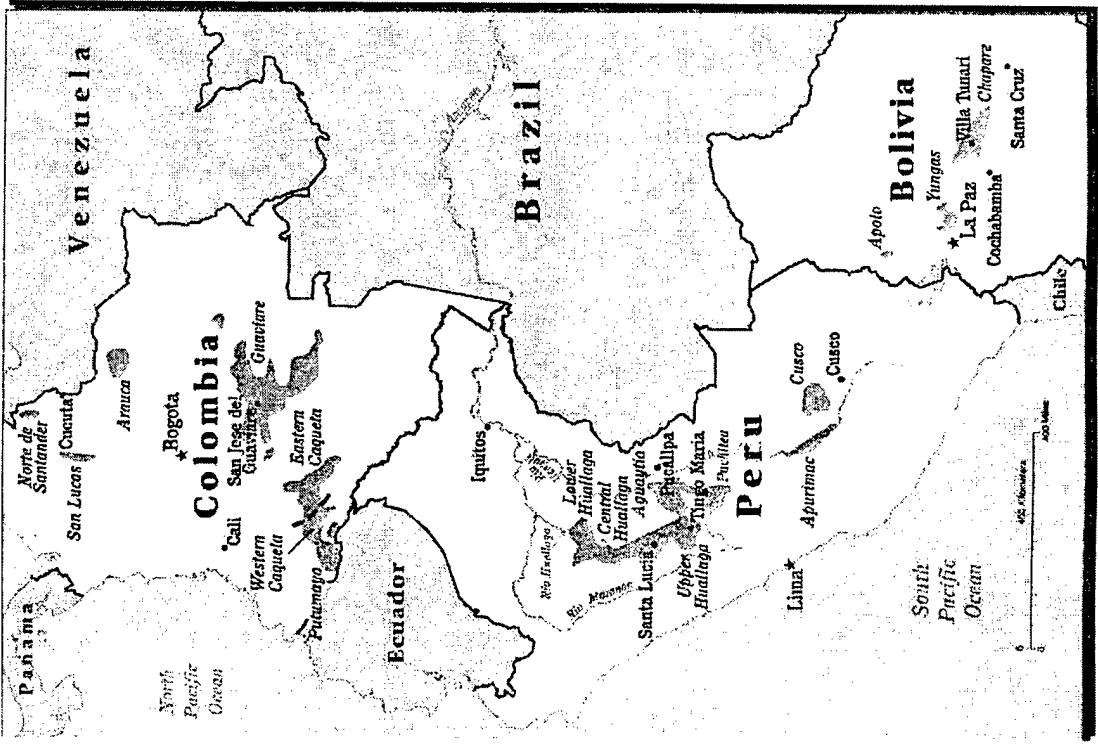

Effect of eradication, interdiction and alternative development evident

- ✓ In Peru cocaine production is down 68 percent since 1995
- ✓ In Bolivia production is down 82 percent since 1995

Source: DCI Crime and Narcotics Center imagery-based drug crop estimates

ONDCP June 26, 2000



Common Elements of CD successes in Peru and Bolivia

COCA

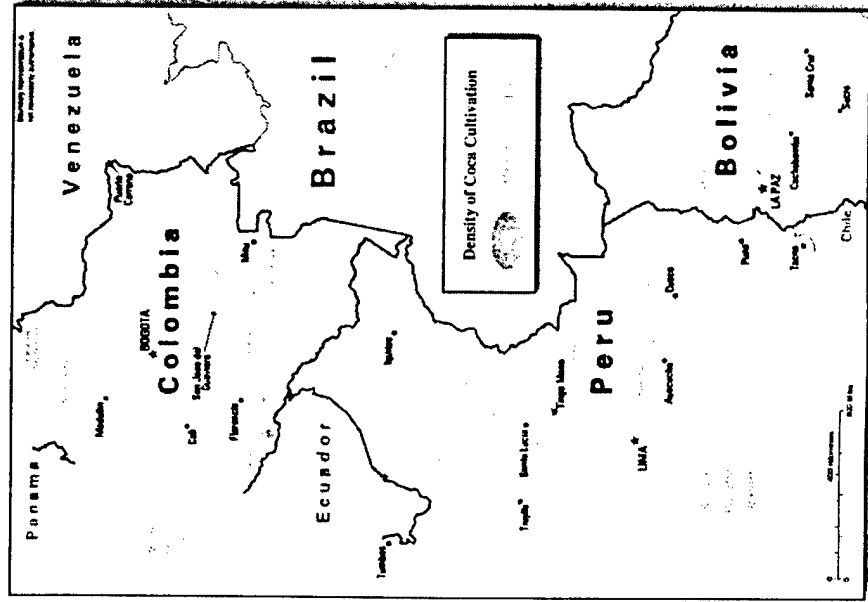

- ⇒ Increased Government Presence/Control of growing region
- ⇒ Law enforcement/interdiction programs to disrupt the industry
- ⇒ Crop control programs
 - Alternative development
 - Eradication



Colombia's Interlocking Problems Resulting in Dramatic Drug Increase

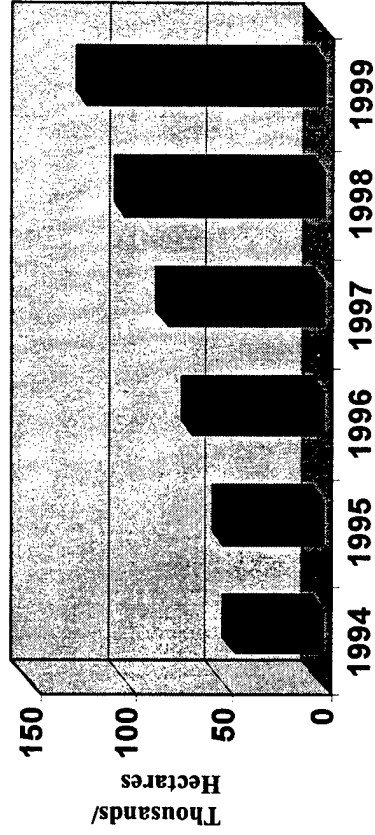
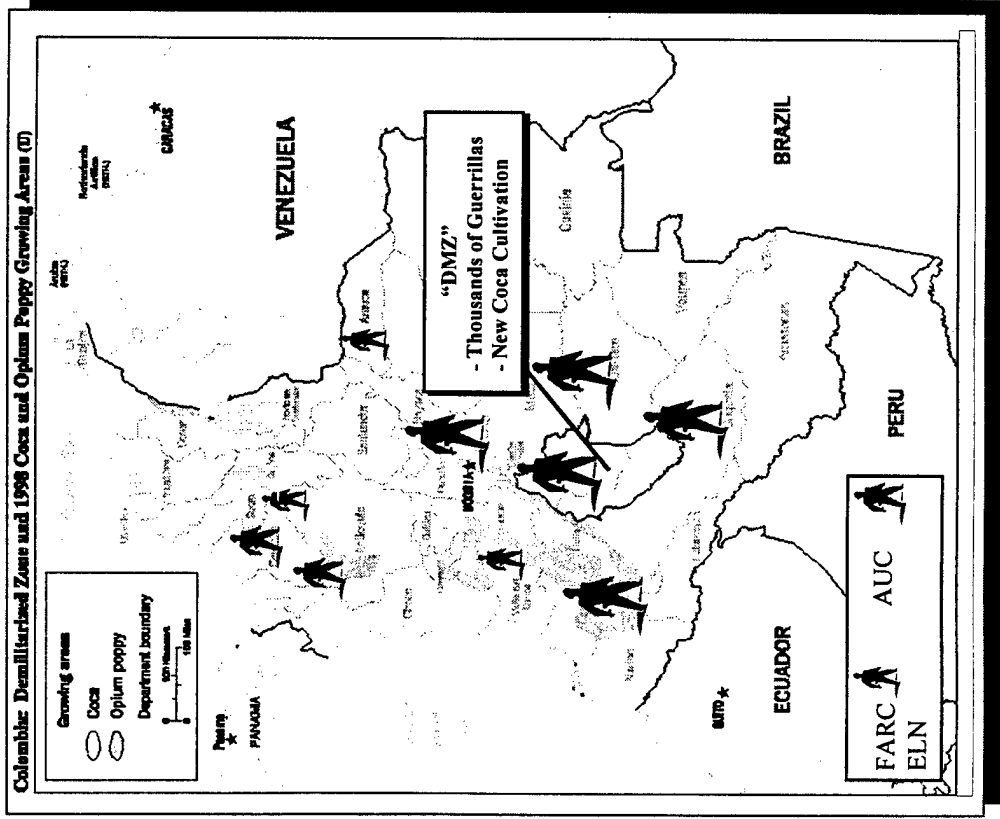

In February 2001, CNC is again expected to report a significant increase in Colombian Cocaine Production

- Cultivation and production areas controlled by guerrillas and paramilitaries
- Drug trade funding outlaw groups responsible for violence, internal conflict, and human rights violations
- Peace process at risk as long as drug profits are high
- Guerrilla and paramilitary battles to control rural areas causing massive internal displacement
- Economy crippled by violence and uncertainty
- Emigration/capital flight by educated middle class



Integrated Regional Solution Required

- Initiative calls for significant increases in funding -- \$1.3 Billion over two years
- Solution is regional in scope with emphasis on Colombia -- the center of gravity
 - Interdiction/eradication operations in drug producing regions
 - Will require additional security
 - Alternative Economic Developments
 - Strengthen Democratic Institutions
 - Continued support for Bolivia
 - Increased support for Ecuador
 - Defense's Forward Operating Locations are key

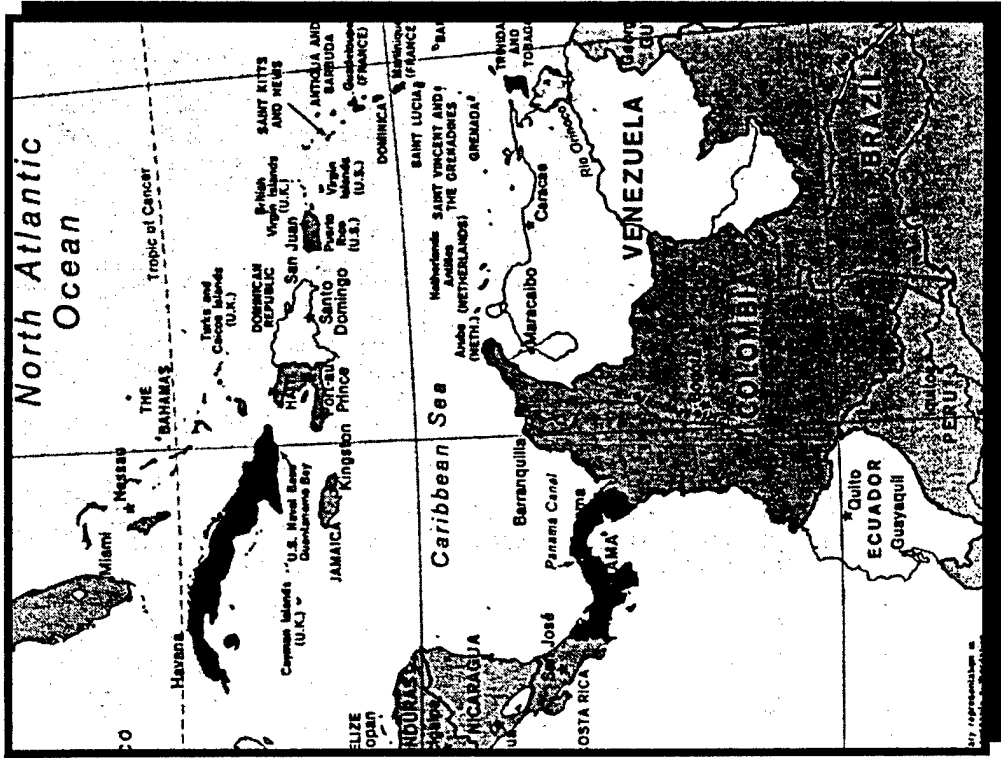



Colombia/Andean Region Initiative

Boost Governing Capacity - \$122 million

- Human Rights Protection
- Administration of Justice Programs
- Security for Witnesses, Judges and Prosecutors
- Investigative Training

Alternative Economic Development

- \$174 million
- Voluntary Eradication/Licit Alternatives
- Local Government Strengthening
- Support for Internally Displaced
- Bolivia (\$85 million)
- Ecuador (\$8 million)

Colombian National Police

- Support - \$116 million
- 2 BlackHawk Helos
- 12 Huey II Helos
- Upgrade Existing Aircraft
- Spray Aircraft
- Training

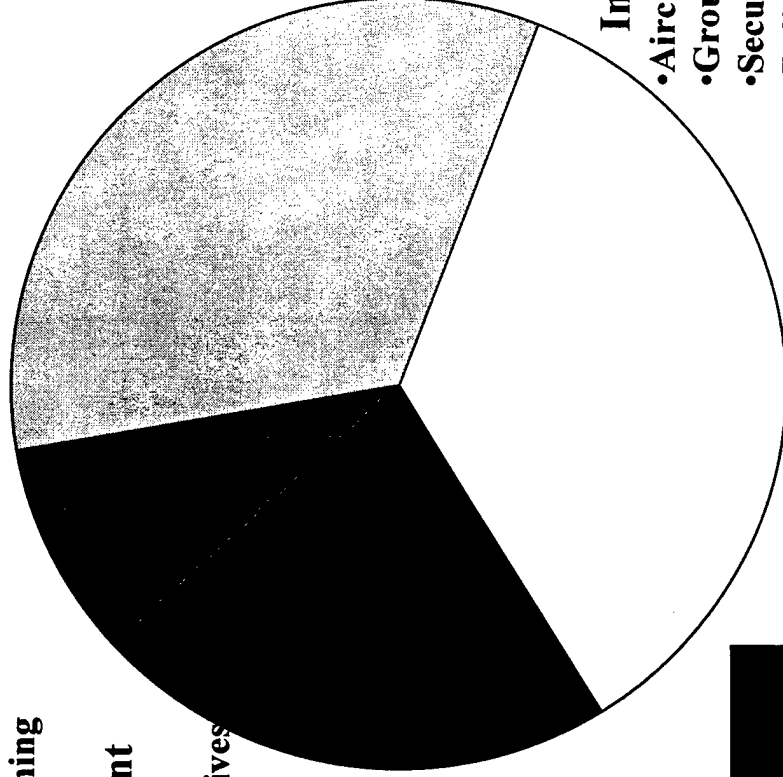

- Implementing Initiative in the South - \$442 million
- Train & Equip 2 CN BNs
- 14 BlackHawk Helos
- 15 UH-1N Helos
- 30 Huey II Helos
- Intel Support
- Force Protection
- Secure Communications
- \$25 M in Alt Development

Drug Trafficking

- Interdiction - \$466 million
- Aircraft and Airfield Upgrades
- Ground Based Radar
- Secure Communications
- Bolivia, Ecuador, Peru, Others
- FOLs (Manta, Aruba, Curaçao)



Impact of Initiative on US Interests - The National Security/Drug Nexus-

Counterdrug Operations in Southern Colombia



- Reduce Global supply of cocaine & heroin
- Address source of regional instability

Boost Government Capacity



- Strengthen democracy and rule of law
- Enable long-term solution

Support Economic Recovery



- Reduce future dependence on US Aid
- Re-establish growth in key South American economy

Assist the Peace Process



- Reduce funding for insurgency
- Peacefully resolve longest continuous conflict in Western Hemisphere

Regional Initiatives



- Expand regional CD cooperation
- Avoid displacement of drug industry to other countries in the region



Successful Supply Reduction effort in Source zone requires a balanced strategy



Interdiction

- Requires a comprehensive approach - surface, air, riverine, maritime
- Disrupt trafficking patterns
- Lower farmgate prices
- Isolate growing areas: drugs, chemicals, money, criminal contacts, and labor

Law Enforcement

- Put criminal elements at risk
- Synergy between governmental, military, police and private efforts



Successful Supply Reduction effort in Source zone requires a balanced strategy



Powder cocaine

Eradication

- Eliminate illegal coca cultivation
- Raise cost of illegal growing activity

Alternative Development

- Provide alternatives to the growers
- Redirect local economies



Role of U.S. Military in Source Zone

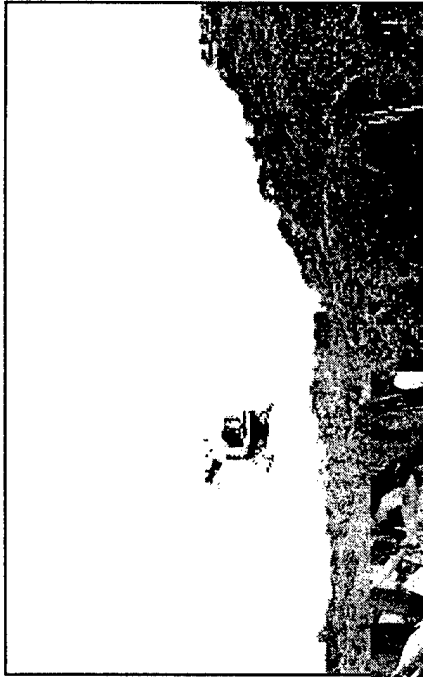

- Provide Planning Support
- Assist in Training
 - CD Bn(s)
 - Riverine
 - Helicopter/Maintenance
 - Intelligence
- Provide Detection & Monitoring Support
- Maintain Forward Operating Locations



Role of U.S. Military in Transit Zone

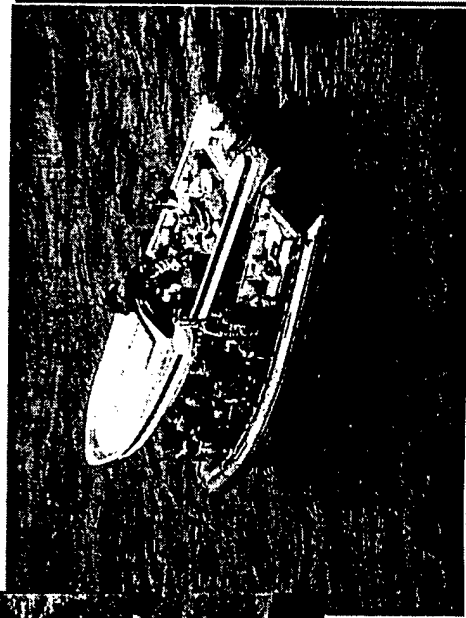
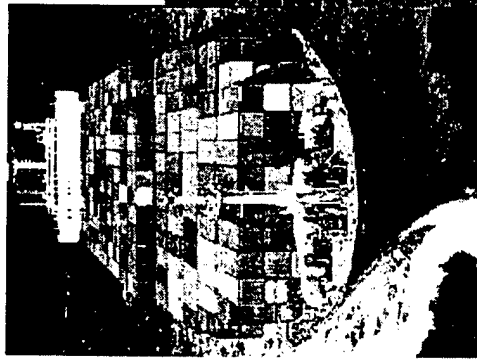

- Coordinate intelligence and asset allocation
 - JIATF-East & West
- Support Law Enforcement
 - LE Det's
- Assist in Training
- Provide Detection & Monitoring Support
- Maintain Forward Operating Locations



DEPARTMENT OF DEFENSE

Drug Enforcement Policy and Support

February 14, 2000



National CD Policy

Goal 1: Educate/enable America's youth to reject illegal drugs

- Services and National Guard Community Outreach
- Young Marines

Goal 2: Increase safety of America's citizens by substantially reducing drug-related crime and violence

- National Guard (MJTF, GSI Regional Training Academy)
- Intel Support (Intel Analysts)

Goal 3: Reduce health/social costs to public of illegal drug use

- Military/DoD Civilian Drug Testing

Goal 4: Shield America's air/land/sea frontiers from drug threat

- D&M (Aircraft, Ships, ROTH, CBRN, Aerostats, FOLs)
- Intel Support

Goal 5: Break foreign and domestic drug sources of supply

- D&M (ROTHR, GMR, Trackers, AWACs, FOLs)
- SOF Training Support





How does DEP&S accomplish this mission

- *Developing and promulgating overall Department of Defense counterdrug Policy and guidance, consistent with the President's National Drug Control Policy goals and objectives*
- *Planning, programming, budgeting, and managing the execution of all facets of the DoD counterdrug program and related activities (\$.925B in FY01)*
- *Serving as the primary DoD interface with Congress and the Interagency on all counterdrug policy, strategy, and budgetary issues*
- *Representing the Department in interfaces with the senior military and civilian leadership of countries involved in countering the production and trafficking of illegal drugs*
- *Working with the Joint Staff, CINCs, and Reserve/NG forces on issues and actions relating to the operational execution of DoD's counterdrug programs*
- *Reviewing, assessing, and reporting on the impact and effectiveness of all DoD counterdrug activities both for internal Department use and for input into the National assessment.*



Requirements and Prohibitions

- **Requirements and Prohibitions**
 - Counter drug nexus
 - Request to DoD from a US federal agencies with authority to conduct counterdrug operations
 - Human rights vetting and background checks
 - No DoD direct participation in counterdrug search/seizure/arrest operations
 - No lethal equipment can be provided outside of U.S.

- **Section 1004 Authority (National Defense Authorization of 1991)**
 - Counterdrug Training
 - Build qualified minor infrastructure \$1.5M limit

- **Section 1003 Authority (National Defense Authorization of 1998)**
 - Non-lethal equipment (e.g. boots, uniforms, radios, night vision goggles, navigational aides)
 - Colombia and Peru; working to extend to Ecuador
 - Air/Ground/Riverine & Support



FY93-01 DoD Counterdrug Funding (\$M)

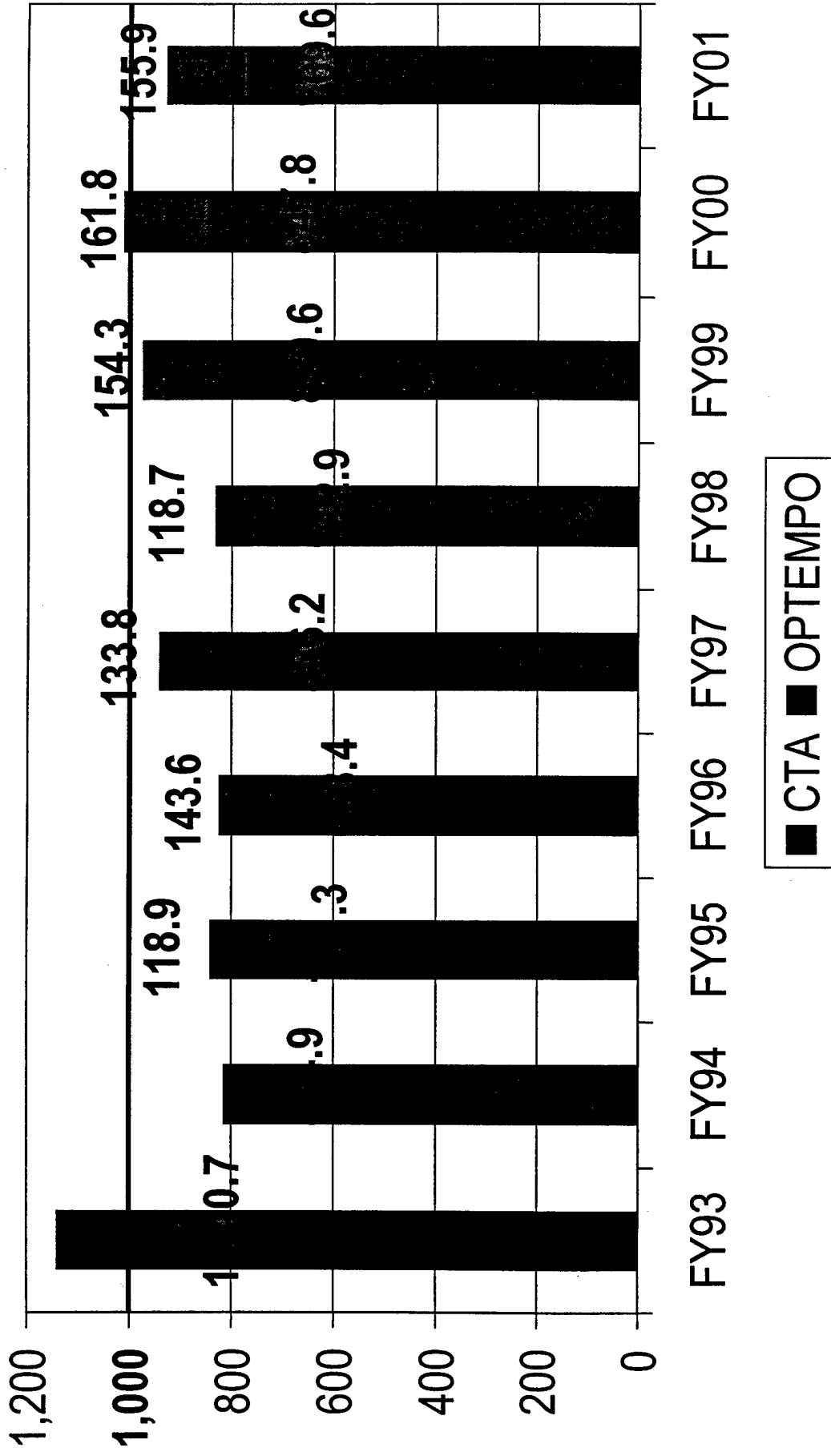



Balancing Competing Factors

**Military
Tradition**

**Expectations:
Congress, Executive
Branch, and the Public**



Constitution-Legislation-Policy



SO/LIC & The War on Drugs: The Question of Strategy



**Dr. Kenneth Allard
NDIA Presentation
February 14, 2001**



Major Point.....

American SO/LIC forces are the finest in the world. But as good as they are, they are not enough *by themselves* to win the war on drugs. And if employed as the principal instrument of US policy in that war, they will fight bravely and fail gloriously.

Facing Up to The Problem....

- Colombia...the immediate challenge
 - Rapid social and economic disintegration
 - Escalating social violence: left, right, and drug cartels
 - Civil war overlaid on drug war
 - Escalating US commitment
 - Clear possibilities for spillover effects in the region.

Facing Up To Failure....

■ US Efforts Have Been Handicapped By....

- Too many agencies and agendas - usually the wrong ones
- No unity of command
- The exclusive focus on law enforcement
- The mismatch between resources, threats and US policy
- **Most important: A domestic US culture that continues to tolerate drug abuse!**

Some Organizational Considerations...

- **Unity of Effort and Unity of Command**
 - US Ambassadors versus the CINC
 - Unified action versus national sovereignty
 - Interagency frictions
- **Regional coalition and cooperation are key**
- **Our C3I must defeat a highly networked adaptive, entrepreneurial adversary**

Some Strategic Considerations...

- Coalescing of US National Will and international opinion
- Recognize history of US intervention in Latin America
- Interdiction in depth versus potential for mistakes and collateral damage
- Reinforce security and integrity of US borders

● ● ●
[]
However.....

There is no conceivable strategy for defeating drugs that does not depend upon a fundamental change in American domestic culture...one that will realign rights and responsibilities while clarifying for a new generation the difference between liberty and license.

**“The difference between genius and
stupidity is that genius understands
limits...”**

Anonymous



Future Interdiction Challenges





TRANSIT ZONE DRUG FLOW

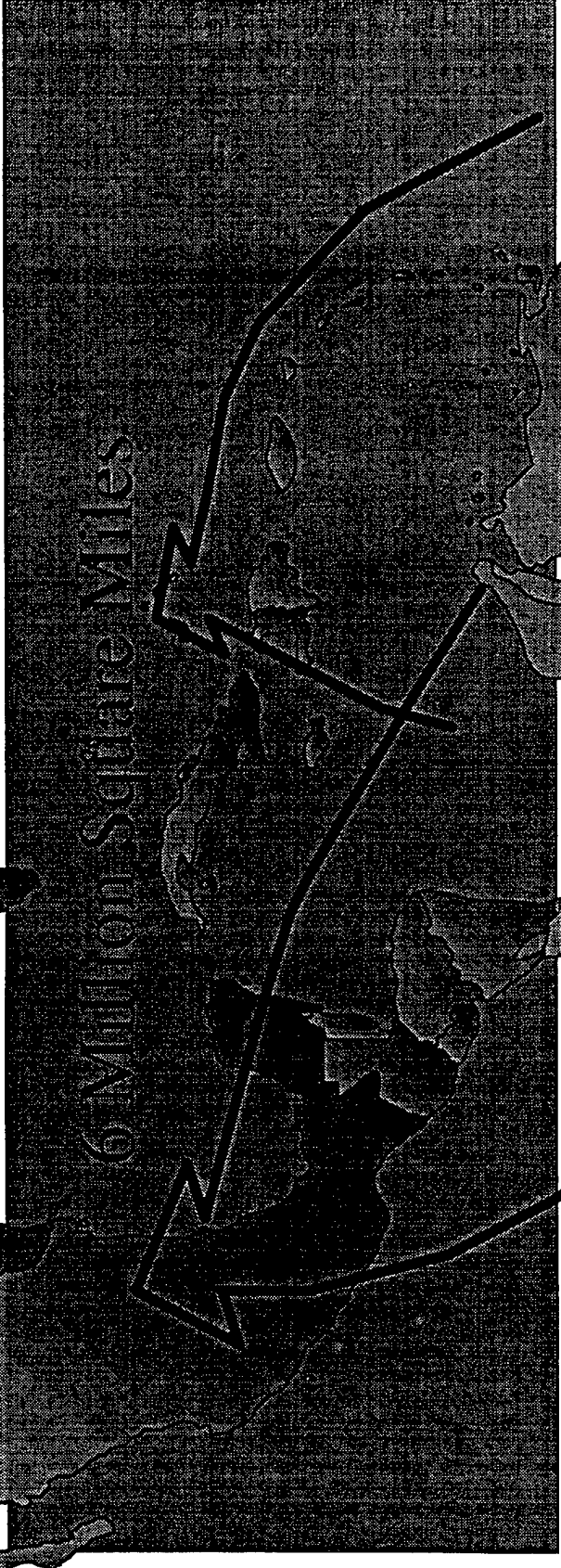

6 Million Square Miles

Total 550 metric
tons of Cocaine
in transit - 2000

We must be equally flexible and give traffickers
no quarter as we respond to their moves. NDCS



NON-COMMERCIAL MARITI

- M/V SHANDY EXPRESS - Left (HO) 6 JUN 00: 600 lbs cocaine
- M/V HARDNESS (HO) Bottom Left, 29 OCT 00: 2000 lbs cocaine
- Stateless Go-Fast - Below, 28 OCT 00: 1000 lbs marijuana

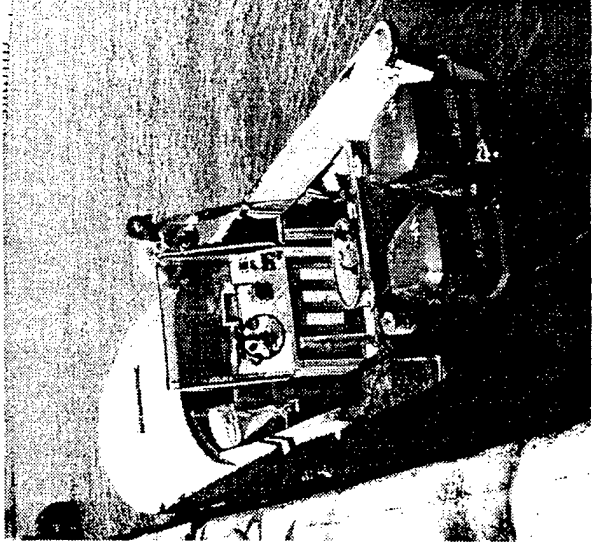
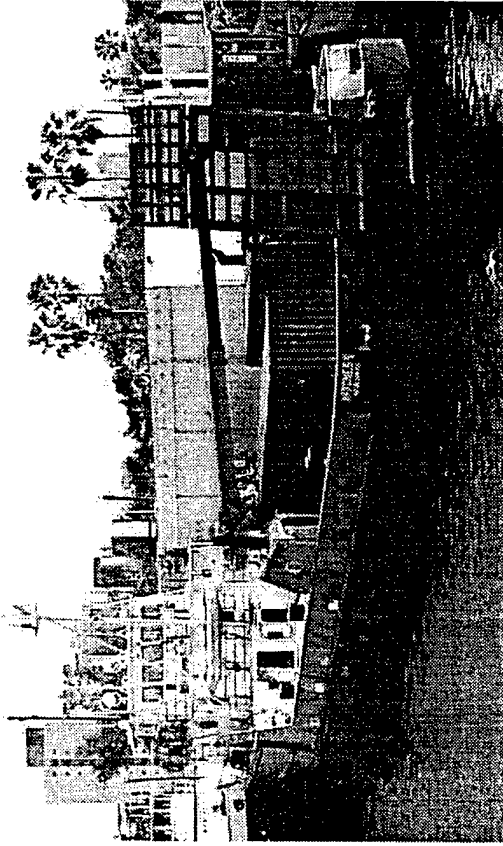



GO-FASTS

- Go-fasts - elusive, agile, & responsible for 80% of non-commercial maritime cocaine flow - 30 to 50 ft - 30 to 50 knots
- Caribbean: North Coast of Colombia to PR Hispaniola, Jamaica and Mexico/CENTAM, Carry 700-1100 kilos, Mostly overnight trips
- EPAC: West Coast of Colombia to Mexico/CENTAM, Carry 1000-3000 kilos, 3-5 day trips, Employ fishing vessels as Logistics Supply Vessels (LSVs) for fuel along route

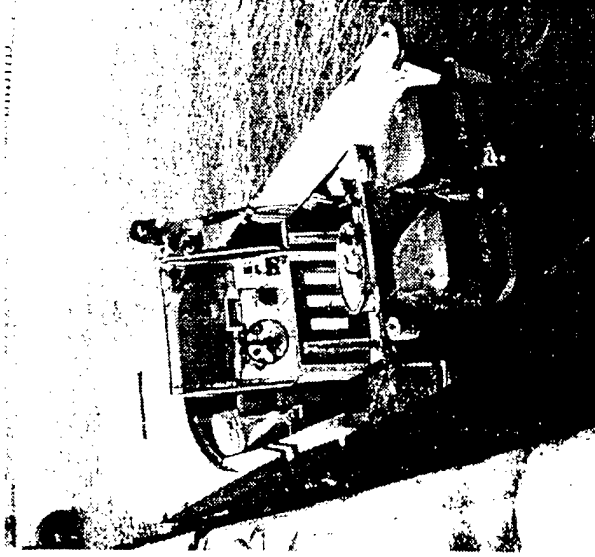
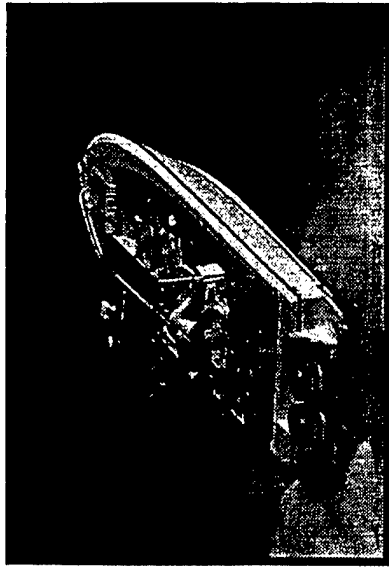



Keys to Interdiction Success

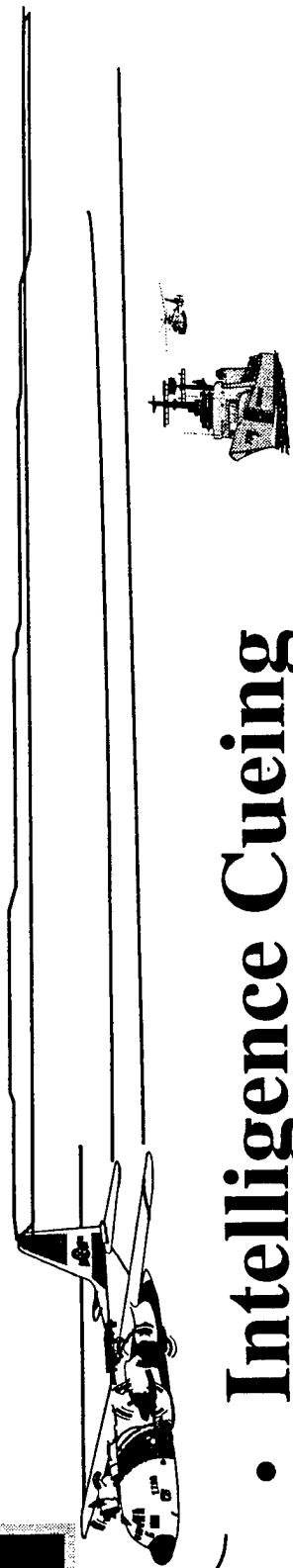

- **Intelligence Cueing**
- **Coordinated Operations**
- **Maritime Surveillance**
- **Endgame Capabilities**

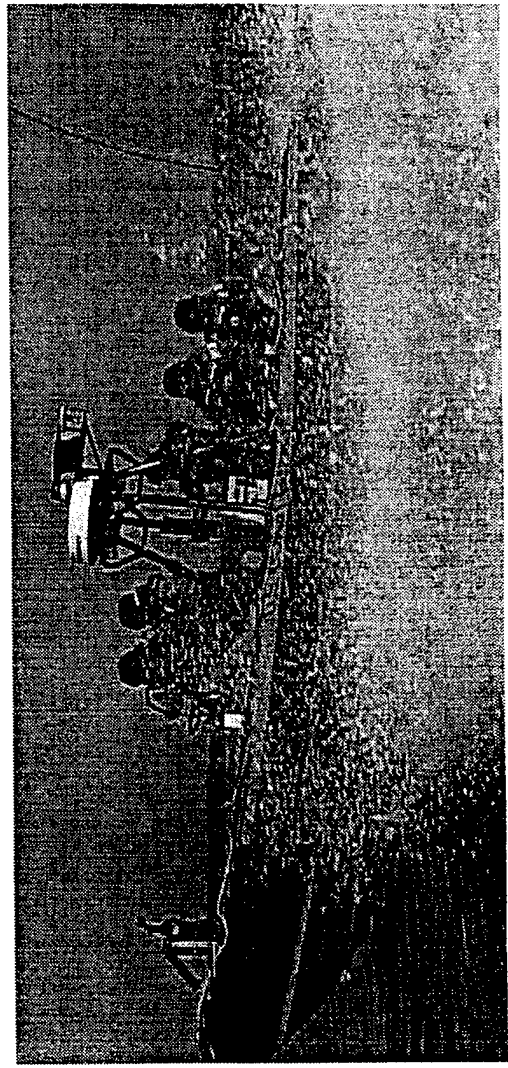

Operation NEW FRONTIER

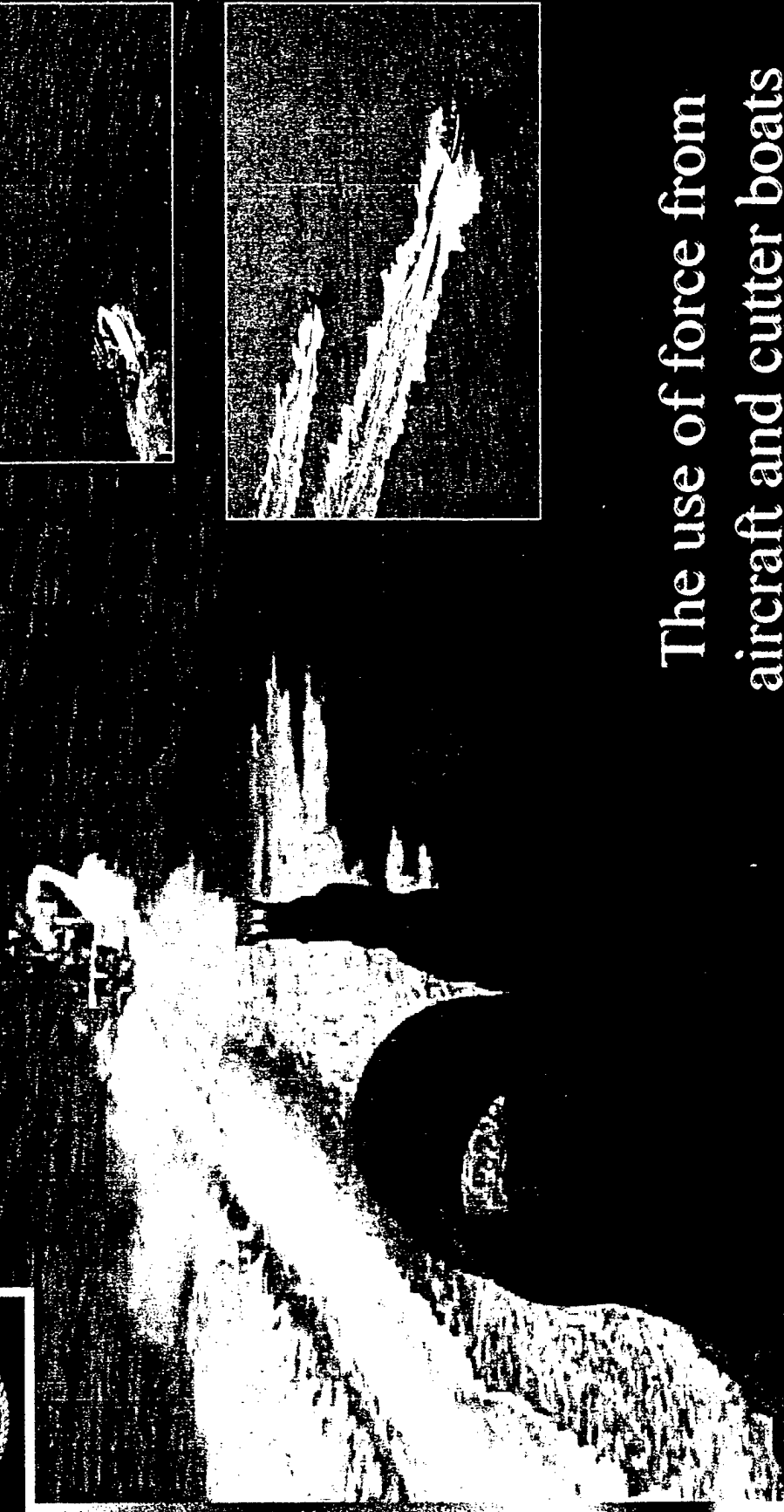

The use of force from
aircraft and cutter boats



ULTIMATE ENDGAME

- Six Go-Fast vessels seized in six opportunities
- Arrested/detained 20 suspects
- Interdicted 3,014 lbs of cocaine
- Interdicted 11,710 lbs of marijuana
- Street Value over \$134 Million
- NEW FRONTIER works!

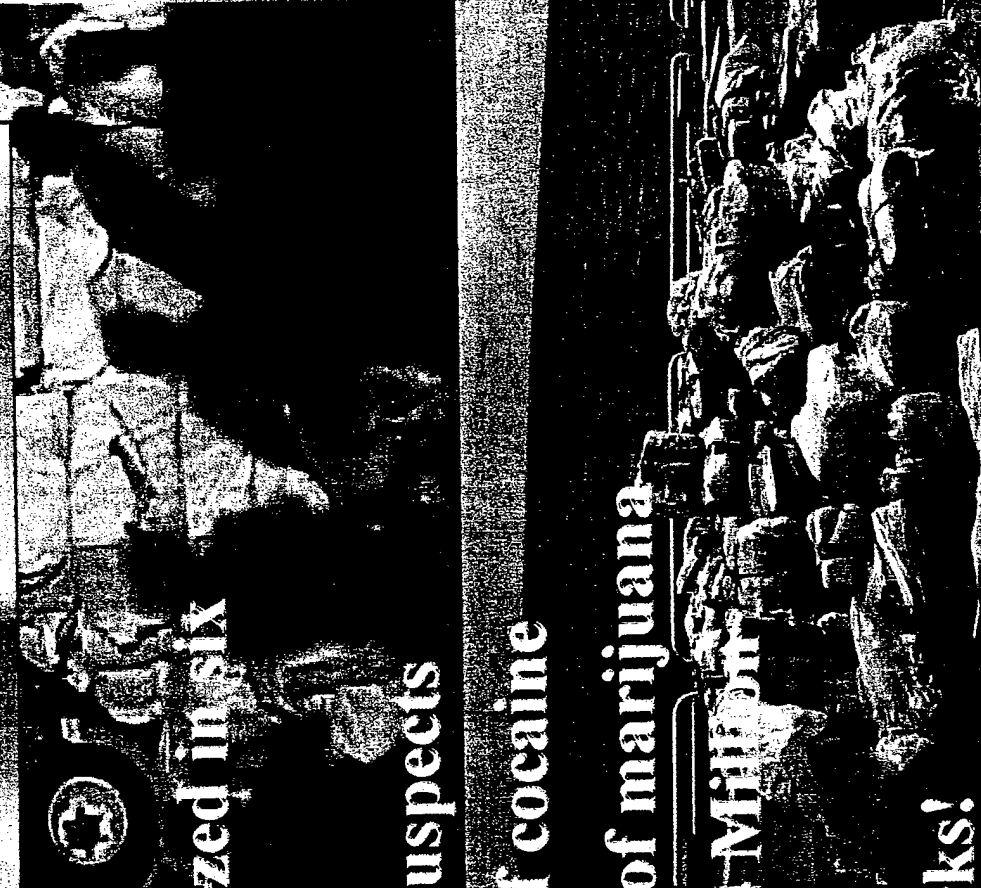



DEPLOYABLE PURSUIT BOAT

Deployable Pursuit Boat (DPB)

- High-performance & long range
- Superior sensors, navigation, communications, non-lethal technologies
- Future includes plans to forward-deploy from shore facilities

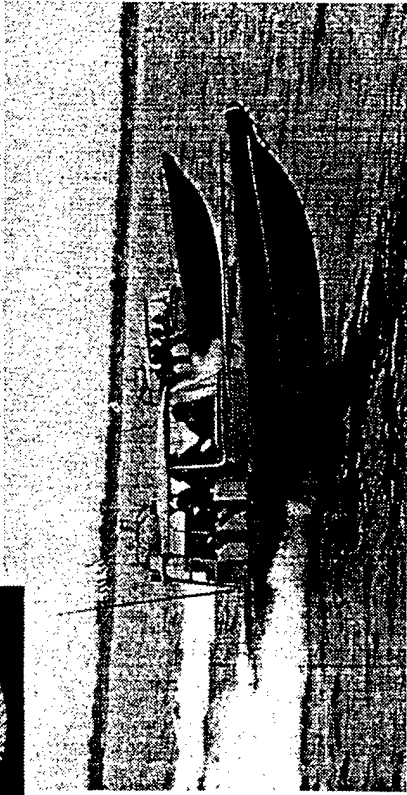

T-AGOS ship

- CG TACLET DPB Detachment
- MSC civilian crew
- Mission Operations Center with full C3 suite, air and surface search radar
- Special davit and DPB cradle system

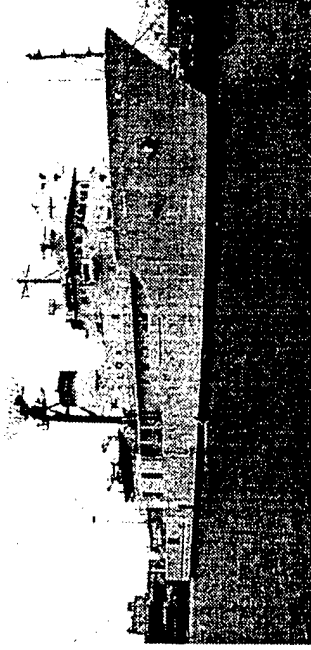



ENDGAME INITIATIVES: The Future

Agusta A109

Establish permanent HITRON Squadron:

Procure new armed helicopters

Additional Cutter Boats

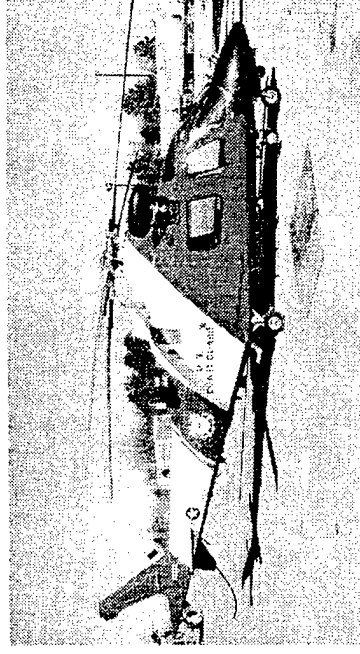

Deployable Pursuit Boats

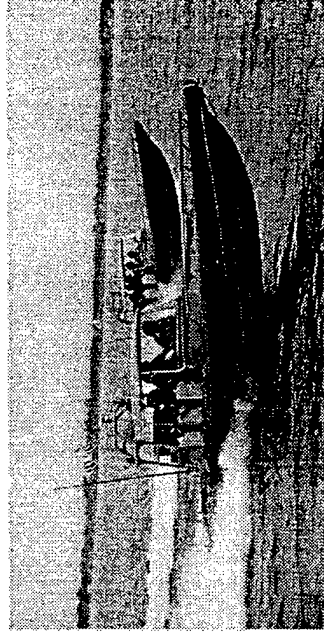



CONCLUSION

Coast Guard is thinking "out of the box"

Initiatives are fully field tested and thoroughly vetted

Building upon early success to improve deterrence

Other initiatives still being evaluated show great promise

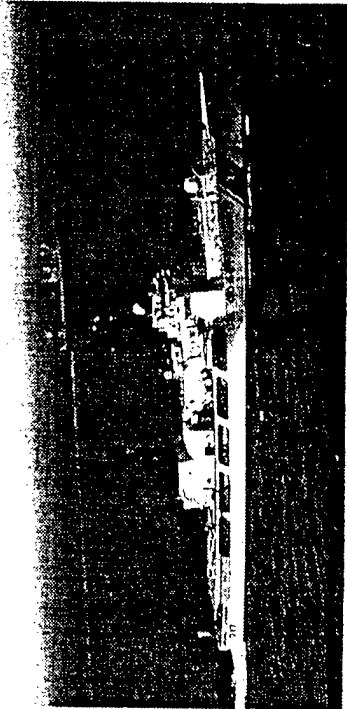
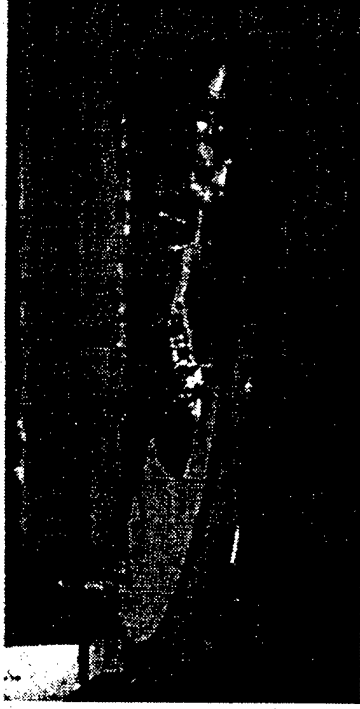



National Guard Counterdrug Programs



Safeguarding
America's Future

COUNTERDRUG PROGRAMS

The National Guard
"Special Ops" Approach

Colonel
JOHN C. MOSBEY
Chief of Counterdrug



Overview

- NG Special Forces Operations
- NG CD-RAID Operations
- NG C-26 Operations
- NG Technologies

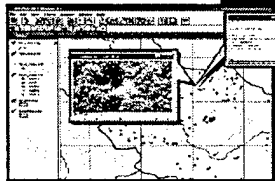

- Fighting
Terrorism

Contact Information

Voice (703) 607-5665
FAX (703) 601-2734

DSN Voice 327-5665
DSN FAX 329-2734



National Guard Counterdrug Programs



Domestic Operations

Special Forces Skills

- Special Reconnaissance
- Foreign Internal Defense
- Communications (18E)
- Medical (18D)
- Operations / Intelligence (18F)
- SCUBA Teams
- Language Identifier



NG-CD Missions

- Surface Reconnaissance / Cannabis Eradication
- Training
- Communications
- Logistics
- Investigative Case and Analyst Support
- Diver
- Linguist



OCONUS Operations Special Forces ARNG

- SOUTHCOM
 - FID--road blocks, vehicle searches, ambush tactics, range firing, MDMP
 - JPATs
- PACOM



Contact Information

Voice (703) 607-5665
FAX (703) 601-2734

DSN Voice 327-5665
DSN FAX 329-2734



National Guard Counterdrug Programs



Special Forces

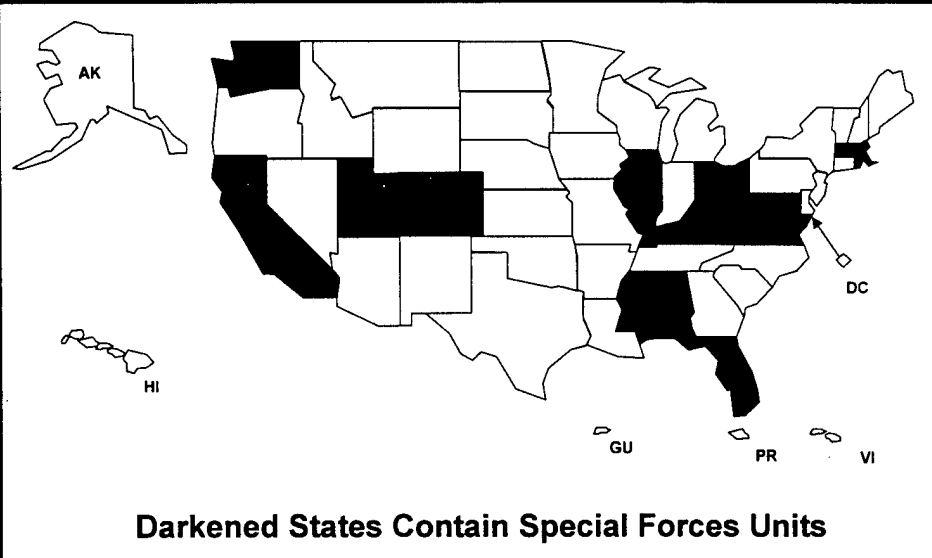

Counterdrug OH-58 Reconnaissance And Interdiction Aircraft (CD RAID)

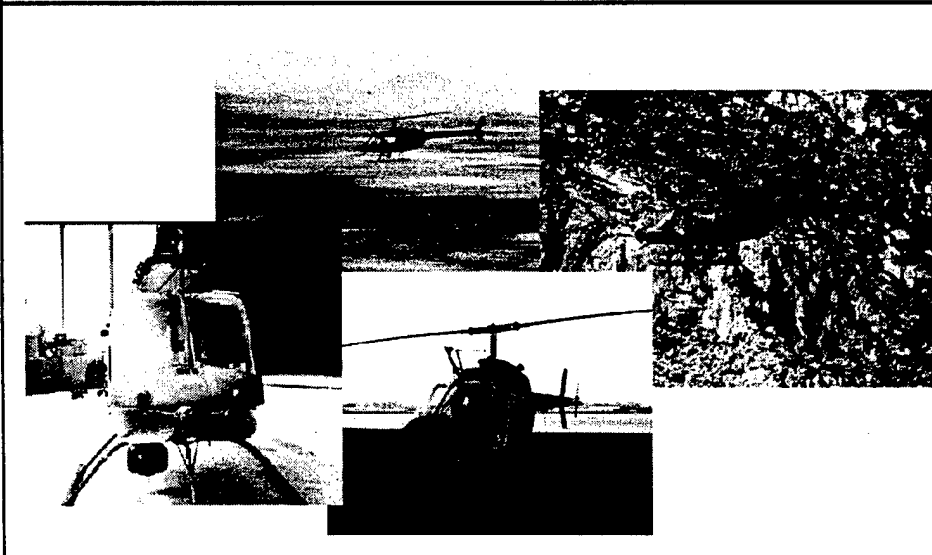

Contact Information

Voice (703) 607-5665
FAX (703) 601-2734

DSN Voice 327-5665
DSN FAX 329-2734



National Guard Counterdrug Programs



CD RAID (Continued)

- Established in 1991
- The CD RAID aircraft is an OH-58A+ helicopter
- There are detachments in 32 states containing a total of 116 aircraft



CD RAID (Continued)

- Aerial Surveillance--Day and Night
- Forward Looking Infra-Red (FLIR)
 - Identifies key signatures of structures for indoor growth of cannabis
 - Vehicle/vessel surveillance
- Video capabilities for evidence
- Global Positioning System Navigational Equipment
 - Identify marijuana locations for ground recovery

Contact Information

Voice (703) 607-5665
FAX (703) 601-2734

DSN Voice 327-5665
DSN FAX 329-2734



National Guard Counterdrug Programs



CD RAID (Continued)

- **NITE-SUN Search Lights**
 - Illuminates target; assists in ground search
- **Communications (Wulfsburg Multiband Radios)**
 - Inter-communications with Law Enforcement
 - Air-to-ground communications/relay capabilities
 - Command and Control



Reconnaissance and Interdiction Detachment Current Distribution

Reconnaissance and Interdiction Detachment Distribution



Redistribution currently underway

Total Detachments: 32
(116 Aircraft)

Contact Information

Voice (703) 607-5665
FAX (703) 601-2734

DSN Voice 327-5665
DSN FAX 329-2734



National Guard Counterdrug Programs



Counterdrug Modified C-26

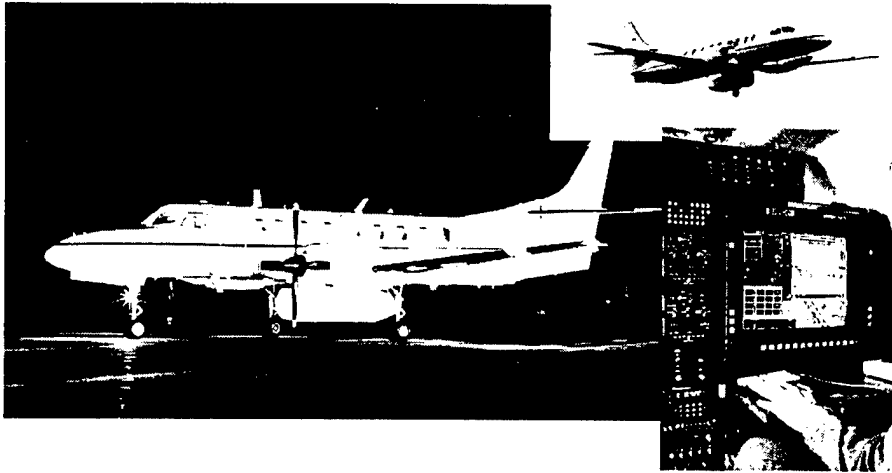

CD C-26 Capabilities

- **Aerial Surveillance - Day and Night**
 - **Locate illegal drug activities**
 - Thermal image comparisons to locate indoor Marijuana grows, outdoor infrastructure
 - **Monitor activity at known sites**
 - Meth labs, stash houses, marijuana grows
 - **Real time surveillance during raid**
 - Command & control, officer safety
 - **Operating altitudes determined by mission & terrain**
 - Normally 2500' - 10000 Above Ground Level

Contact Information

Voice (703) 607-5665

DSN Voice 327-5665

FAX (703) 601-2734

DSN FAX 329-2734



National Guard Counterdrug Programs



CD C-26 Capabilities (Continued)

- **Communications**
 - Wide Range of communications capability 29 to 960MHz
 - LEA position has complete access to mission communications
- **Situational Awareness Display (SAD)**
 - Displays sensor information on moving map display
 - Photo footprints
 - Thermal Imaging System (TIS)/TV field of view
 - Accurate position information relative to ground teams
- **2 Video Recorders**
 - Records SAD and TIS
- **2 KS-87 Aerial Photographic Camera w/Oblique and Overhead capability**



CD Modified C-26 Distribution

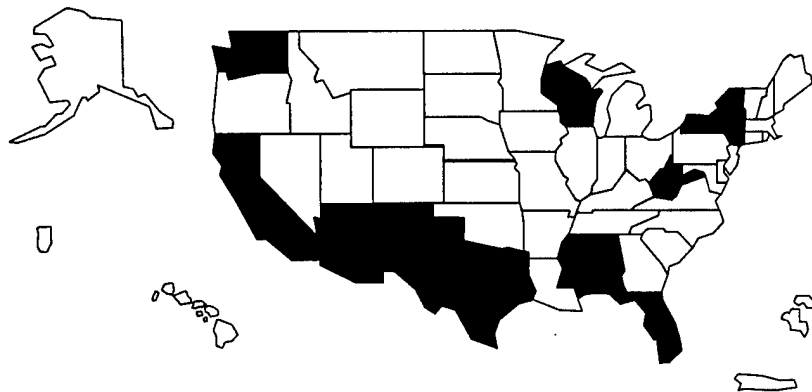

Darkened States Contain a CD Modified C-26
West Virginia CD Modified C-26 deployment is projected for FY02

Contact Information

Voice (703) 607-5665
 FAX (703) 601-2734

DSN Voice 327-5665
 DSN FAX 329-2734



National Guard Counterdrug Programs

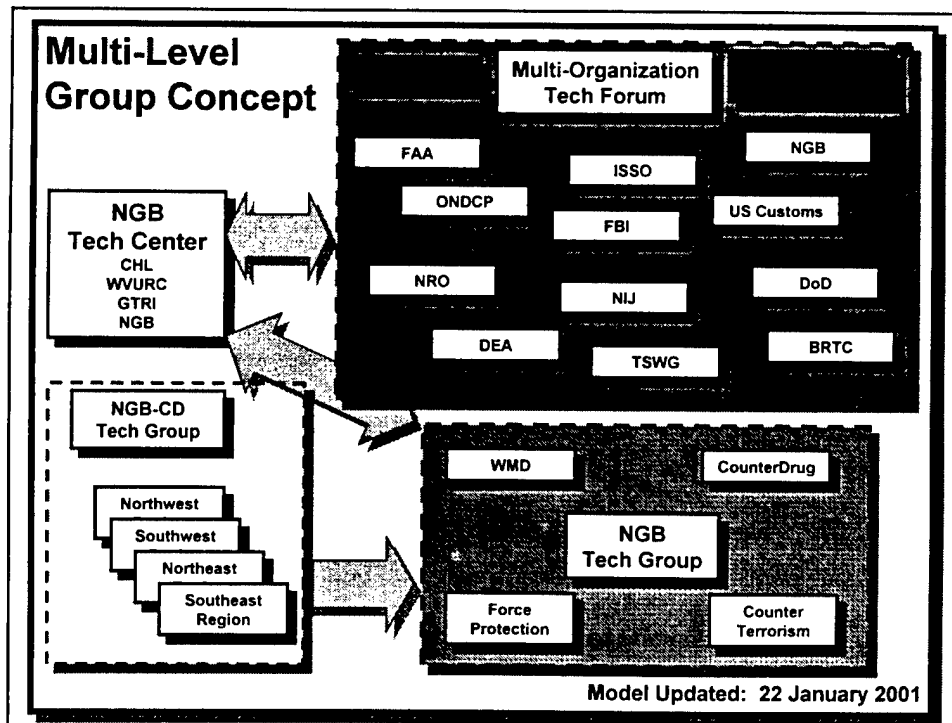
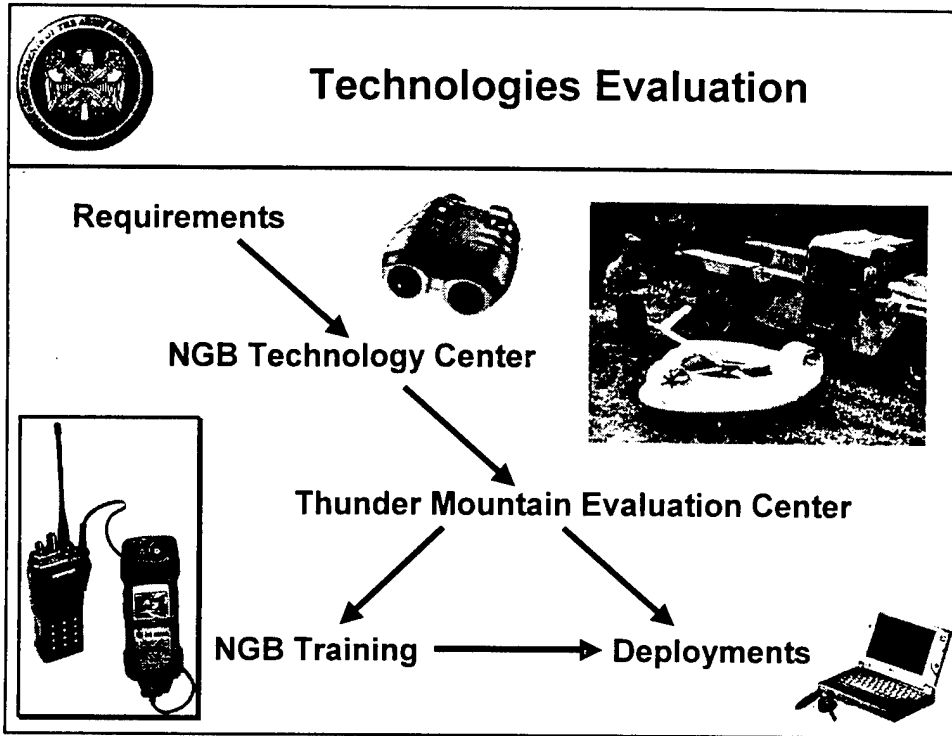

Contact Information

Voice (703) 607-5665 DSN Voice 327-5665
 FAX (703) 601-2734 DSN FAX 329-2734



National Guard Counterdrug Programs

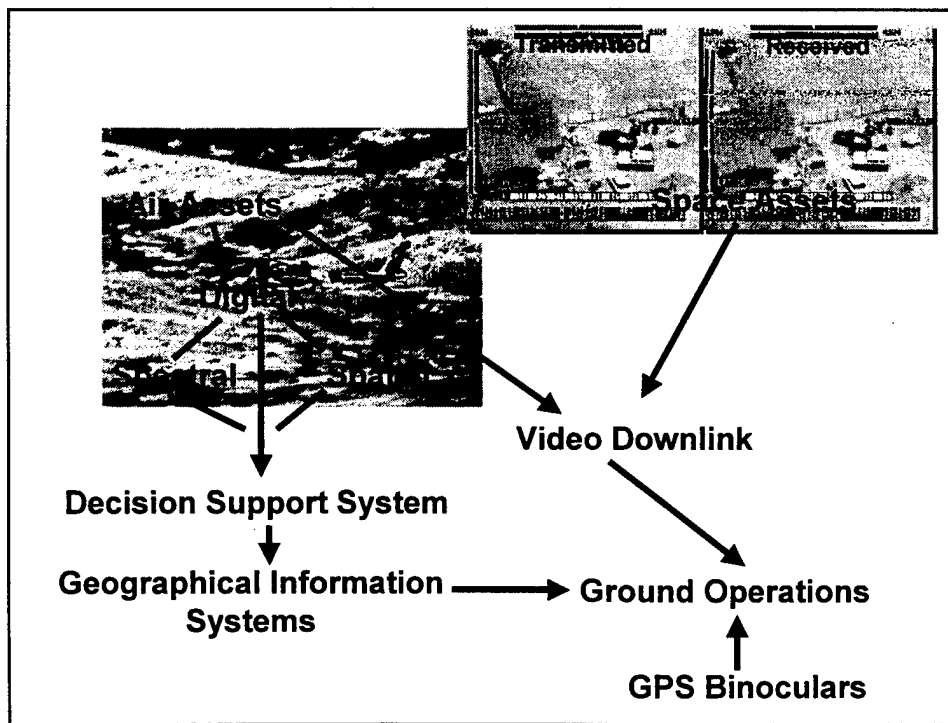
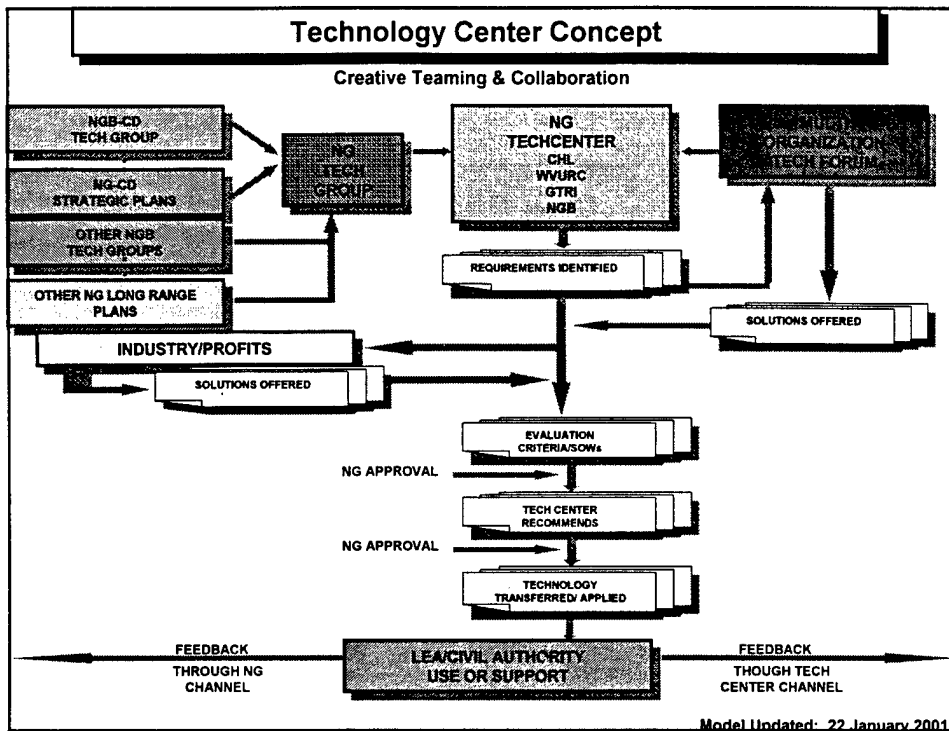

Contact Information

Voice (703) 607-5665
 FAX (703) 601-2734

DSN Voice 327-5665
 DSN FAX 329-2734



National Guard Counterdrug Programs



Non-Intrusive Inspection Devices

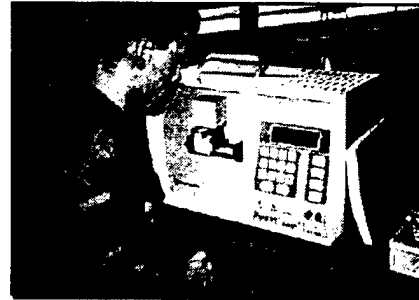
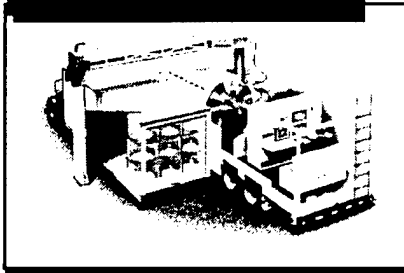
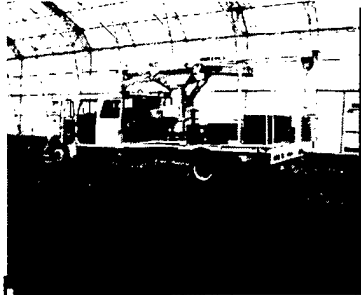

Capabilities

National Guard Counterdrug SO/LIC capabilities using Special Forces, RAID and C-26 assets, combined with future technologies, intensifies law enforcement capabilities to stop drug trafficking operations the United States.

... National Guard Counterdrug SO/LIC capabilities have the potential to be expanded beyond counterdrug.

Contact Information

Voice (703) 607-5665
FAX (703) 601-2734

DSN Voice 327-5665
DSN FAX 329-2734



National Guard Counterdrug Programs



Terrorism

A direct [catastrophic] attack against American citizens *on American soil* is likely over the next quarter century.

In the face of this threat, our nation has no coherent or integrated governmental structures.

*U.S. Commission on National
Security in the 21st Century*



Terrorism (Continued)

- **Narco-traffickers and terrorist/criminal organizations work closely:**
 - Russians Organized Crime
 - Colombian Insurgents and DTOs
 - Mexicans DTOs
 - Chinese Triads

Contact Information

Voice (703) 607-5665
FAX (703) 601-2734

DSN Voice 327-5665
DSN FAX 329-2734



National Guard Counterdrug Programs



Terrorism (Continued)

- **Illegal Drug Trafficking Finances
Terrorism/Insurgencies/International Crime**
- **Close inter-working relationship of
“underworld” makes smuggling WMD onto
US soil easy.**



Summary

- **NG CD assets have multiple capabilities with
SO/LIC characteristics**
- **NG CD assets are capable of assisting in the
fight against smuggling of WMD materials**
- **National Guard Counterdrug SO/LIC
capabilities have the potential to be
expanded beyond counterdrug**

Contact Information

Voice (703) 607-5665 DSN Voice 327-5665
FAX (703) 601-2734 DSN FAX 329-2734



National Guard Counterdrug Programs

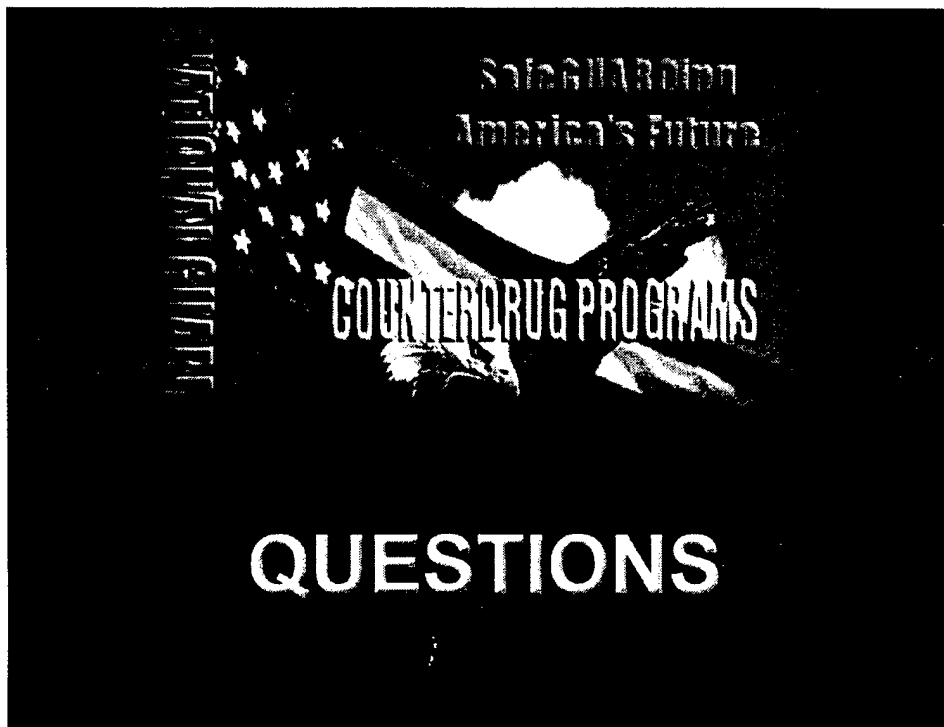

Contact Information

Voice (703) 607-5665
FAX (703) 601-2734

DSN Voice 327-5665
DSN FAX 329-2734

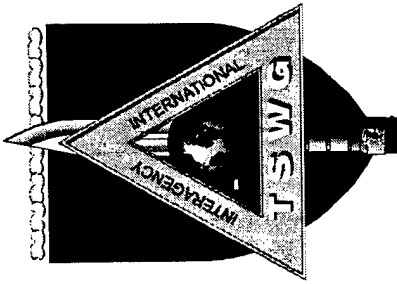

Combating Terrorism Technology Support Office

Edward J. McCallum
Director, CTTSO



National Defense Industrial Association
Special Operations and Low Intensity Conflict Conference
February 12-14, 2001

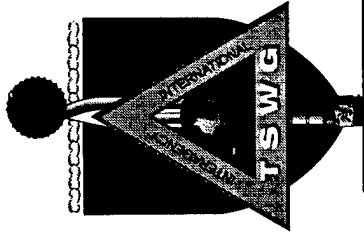

Agenda

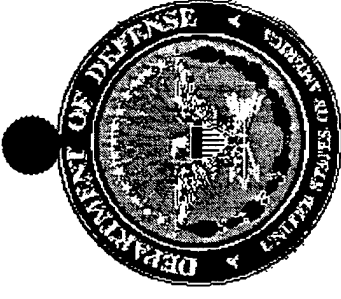

- Background and Mission
- Organization
- Business Processes
- Project Examples
- Current Focus Areas

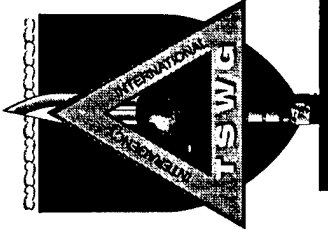

CTTSO



- CTTSO manages TSWG programs by Charter between DOS and DoD
- Full time program managers and support staff
- On-site contracts, finance, and security



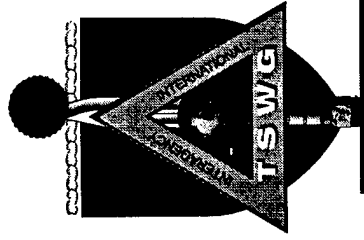

TSWG Mission



“Countering terrorism requires close day-to-day coordination among many Executive Branch agencies.... Part of the challenge is to identify needs, seek common approaches, and coordinate development of new technologies.... This is accomplished through the interagency Technical Support Working Group.”

Excerpts from the President's 1995 National Security Science and Technology Strategy

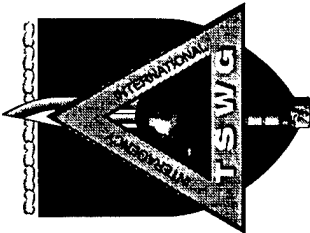

Organization

**OFFICE OF THE COORDINATOR
FOR COUNTERTERRORISM**

**INTERAGENCY WORKING GROUP
ON COUNTERTERRORISM**

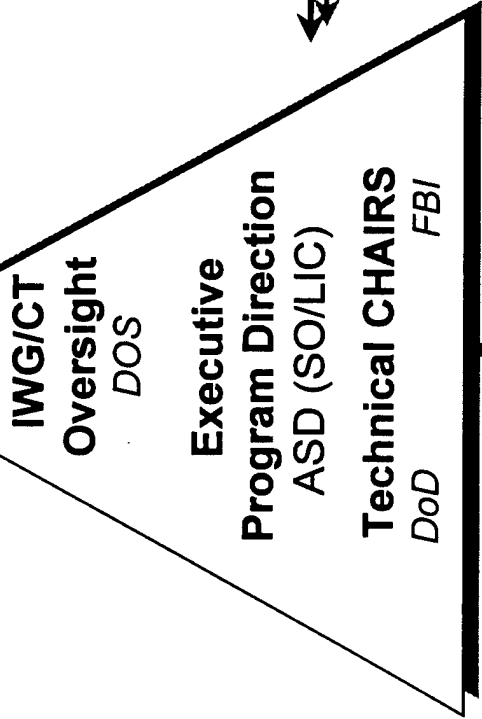

PROGRAM MANAGEMENT
Combating Terrorism
Technology Support Office
DoD

MULTI-AGENCY MEMBERSHIP SUBGROUPS

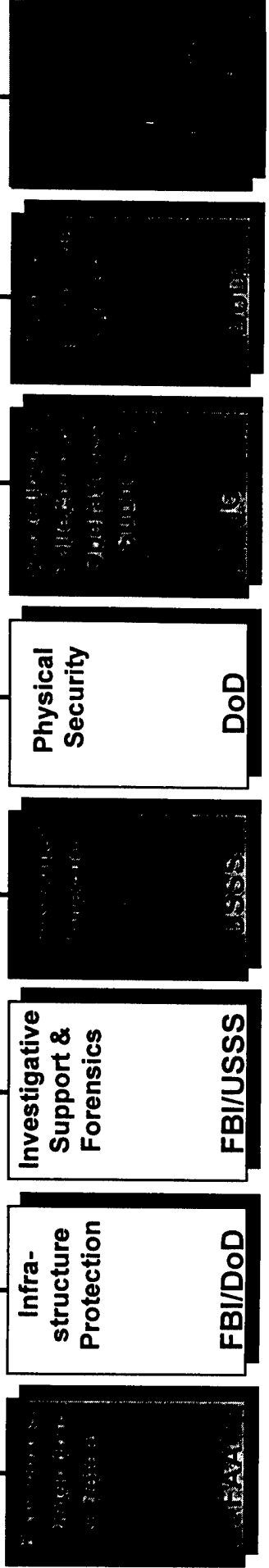

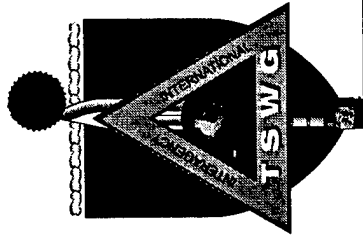

TSWG Members

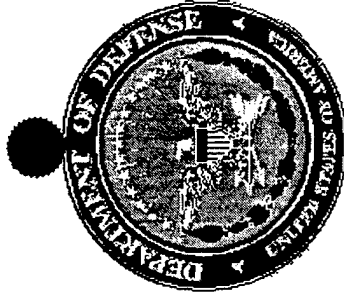

Department of Defense

OASD(SO/LIC)
OATSD(NCB)CP/CBD
ODTUSD(P) PS/IP
OUSD(A&T) DDR&E and S&TS/LW
Defense Intelligence Agency
Defense Logistics Agency
Defense Threat Reduction Agency
National Security Agency
The Joint Staff
Unified Commands
US Atlantic Command
US Special Operations Command
US Air Force
Air Combat Command
AFMC
Force Protection Battle Laboratory
Force Protection System Programs Office
US Army
SBCCOM / ECBC
Corp of Engineers / WES / PMDC
Criminal Investigations Command
Joint Program Office for Bio Defense
Medical Institute for Infectious Diseases
Office of the Chief of the Army Reserve
Special Forces
Technical Escort Unit
Consequence Management Integration Office
US Marine Corps - CBIRF
US Navy
JPO / STC
Naval Criminal Investigative Service
Naval Research Laboratory
Naval Special Warfare
NEODTD / DTRG

Department of State

Office of the Coordinator for Counterterrorism
Diplomatic Security

Department of the Treasury

Bureau of Alcohol, Tobacco and Firearms
Explosives Technology Branch
National Laboratory Center
Office of Law Enforcement
US Customs Service
US Secret Service

Forensic Services Division
Technical Security Division

Department of Justice

Drug Enforcement Agency
Federal Bureau of Investigation
Counterterrorism Planning Section
Hostage Rescue Team
Laboratory Division
Bomb Data Center
Forensic Science and Training Center
Hazardous Material Response Unit
Material Analysis Section
Materials and Devices Unit
Explosive Operations Group
Questioned Documents Section
Scientific Analysis Section
National Domestic Preparedness Office
National Infrastructure Protection Center
Special Operations Unit
Federal Bureau of Prisons
National Institute of Justice

Department of Agriculture

Agricultural Research Service
Animal and Plant Health Inspection Service

Department of Energy

Defense Programs Elements
National Laboratories
Office of Safeguards and Security
Office of Energy Intelligence

Department of Health and

Human Services/USPHS

Centers for Disease Control & Prevention
Food and Drug Administration
Office of Emergency Preparedness

Department of Commerce

National Telecommunications & Information Administration
National Institute of Standards and Technology
Office of Security

Department of Transportation

Intelligence and Security Division
Federal Aviation Administration
Office of Civil Aviation Security
FAA Technical Center
Office of Emergency Preparedness

Other

Central Intelligence Agency
Counterterrorism Center
Center for CIA Security
Office of Transnational Issues
Environmental Protection Agency
Federal Emergency Management Agency
General Services Administration - Federal Protective Services
US Postal Inspection Service
US Postal Service - National Forensic Laboratory

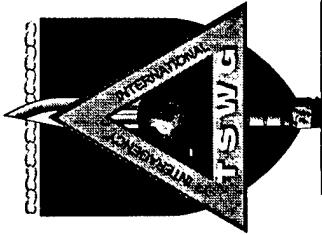

Business Formulation Cycle

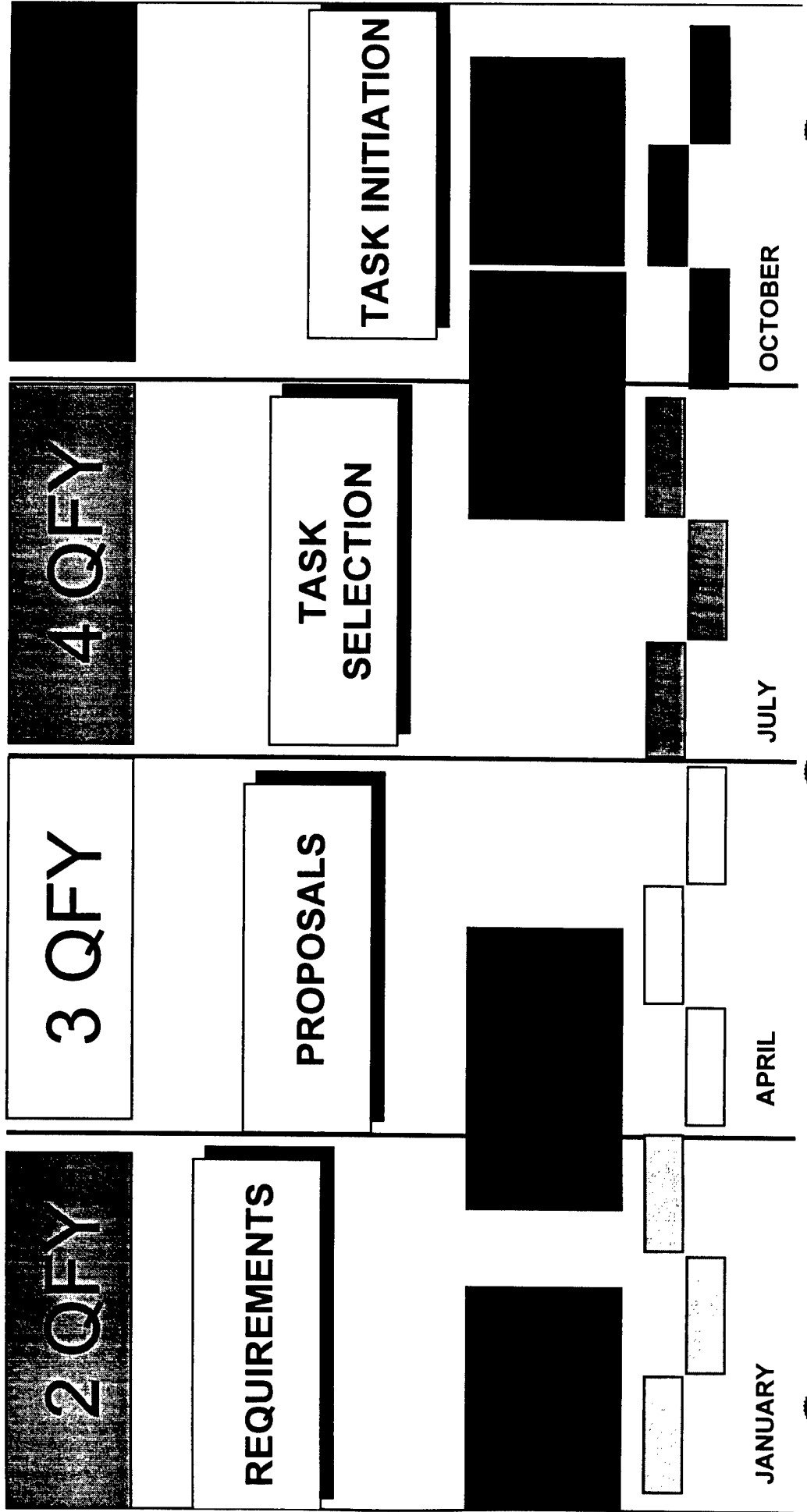

BAA

**REQ'T
STATEMENT**

SPONSOR

**Subject
Matter
Experts**

USER

**Requirements
Meeting**

**Quadchart
Review**

**Whitepaper
Review**

**Proposal
Review**

HARDWARE

EXECUTION



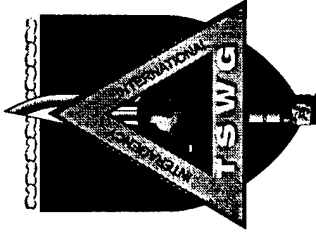

Threats and Requirements



- Emerging Ballistics
- Toxic Industrial Chemicals
- Novel Explosives
- Cyber/ Information Operations
- IED Delivery Platforms



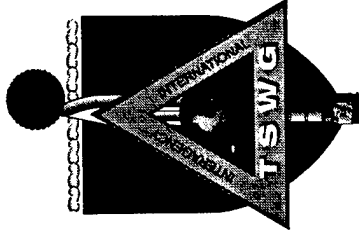

Subgroup Focus Areas

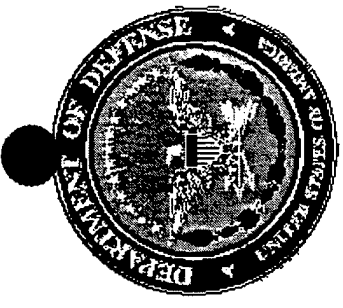

- Areas of special interest for each subgroup
- Bottom-up approach
- SOF interest at operator level

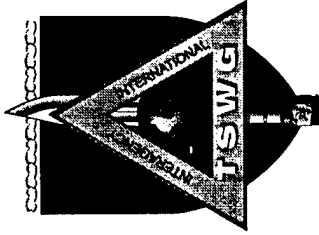

CBRN Countermeasures



- Protection
- Detection
- Decontamination
- Information Products



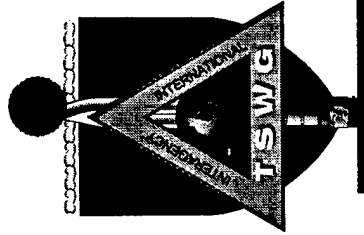

Palmtop Emergency Action Computer – Chemical Warfare



- Purpose: Develop a hazardous material database within a handheld computer.
- Capabilities: Hazardous Materials Properties, Protective Equipment and Emergency Response Tool
 - ~4000 Chemicals plus 24 CW Agents/Precursors
- Availability: February 2001

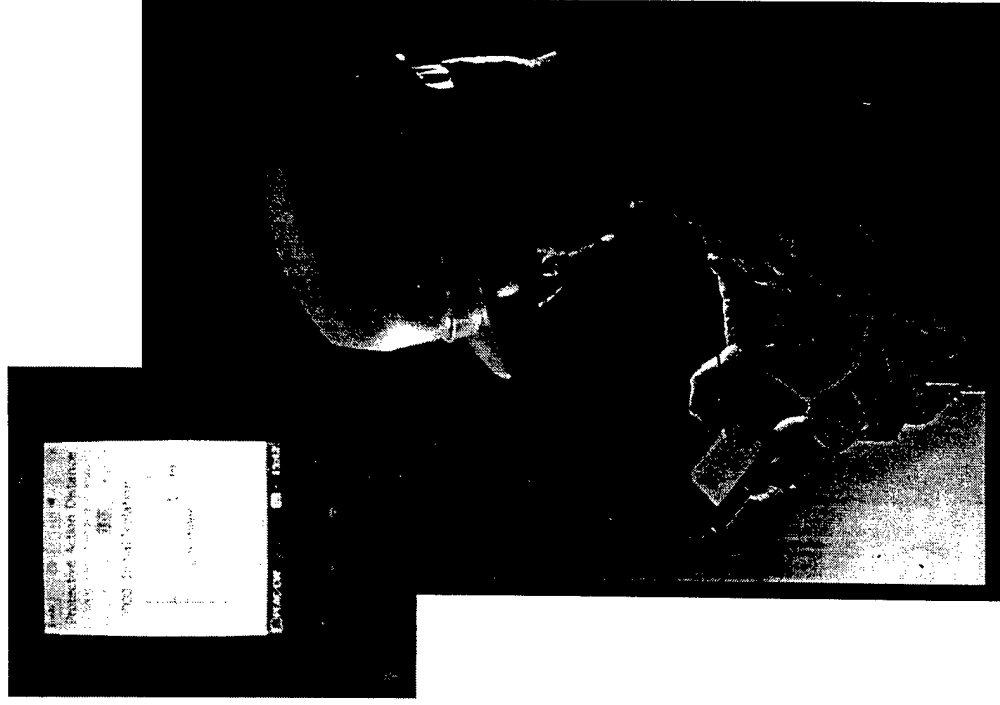

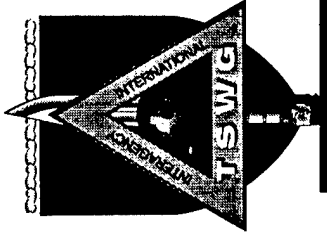

Explosives Detection and Defeat

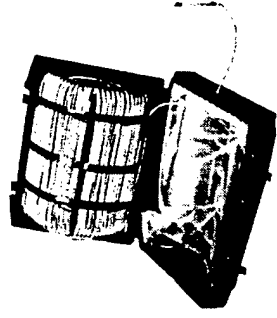

- Detection
- Diagnostics
- Defeat
- Robotics
- Improvised Materials

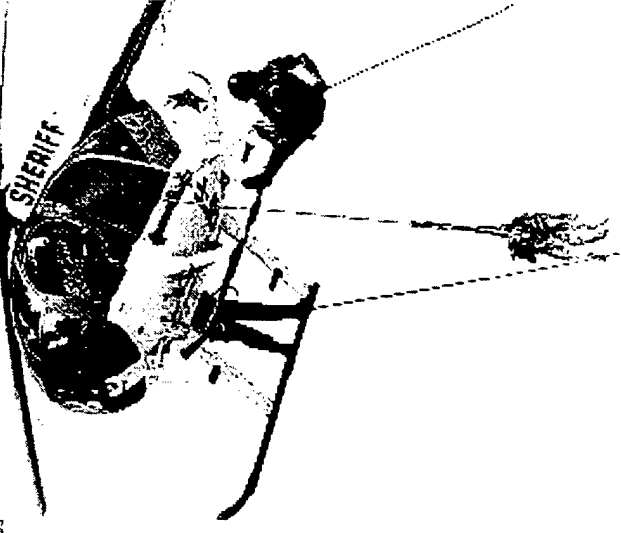

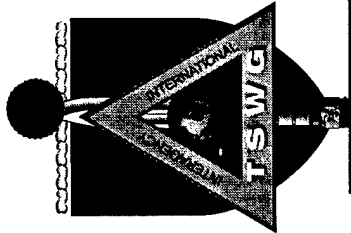

Infrastructure Protection

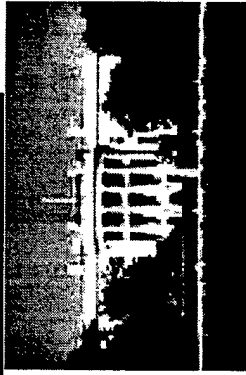
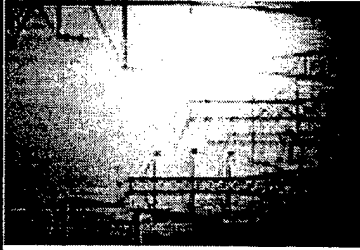

- Physical Protection
- Cyber Protection

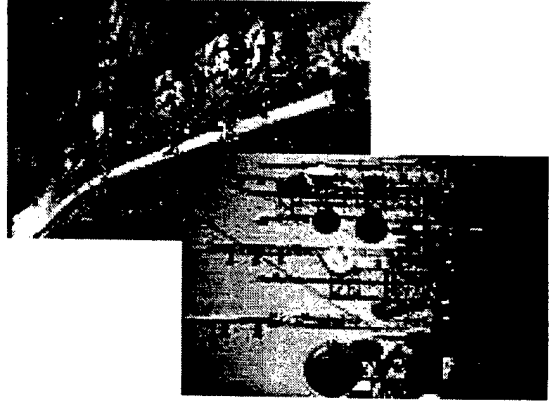
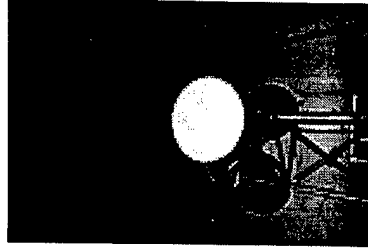
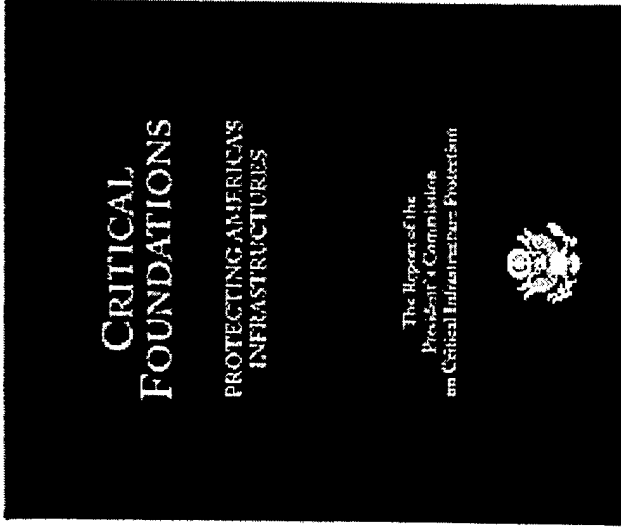

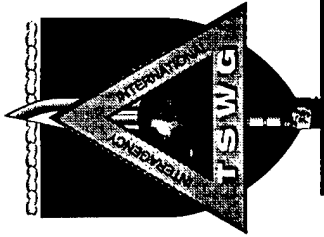

Investigative Support and Forensics



- DNA Recovery and Analysis
- Latent Fingerprint Recovery
- Computer Forensics
- Digital Evidence Development
- Tagging, Tracking, and Locating

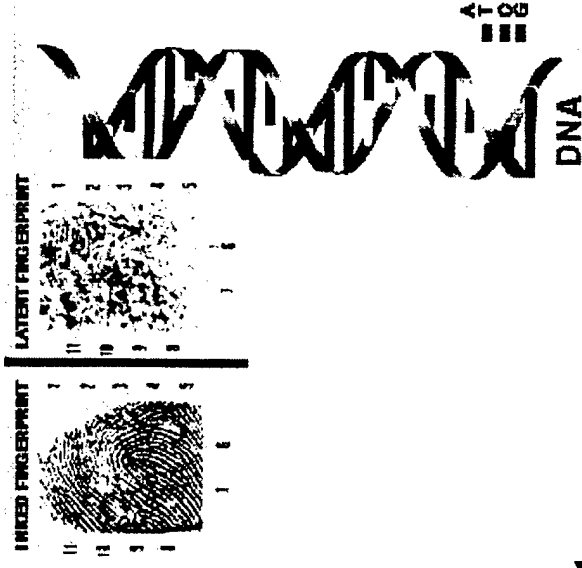

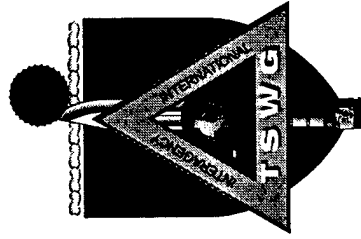

Personnel Protection



- Vehicle Protection and Performance
- Transparent Armor
- Enhanced Body Armor
- Counter Sniper

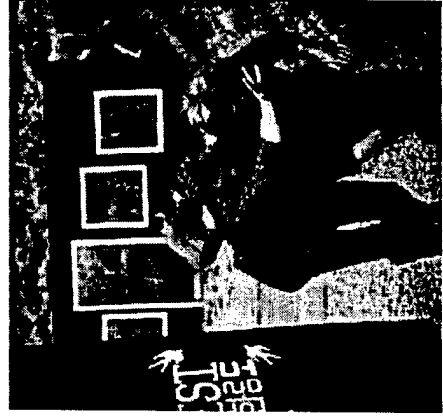
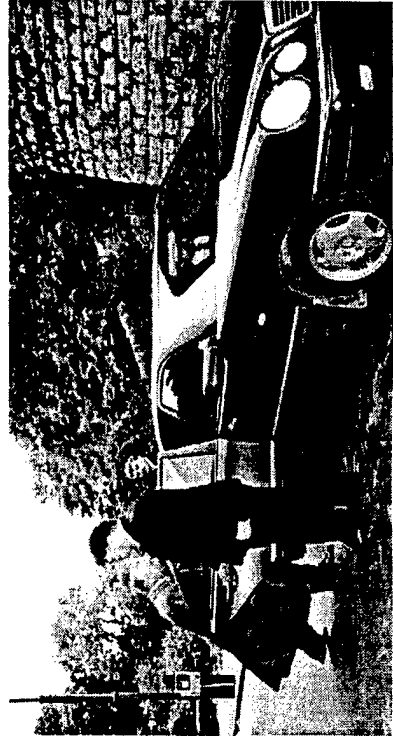

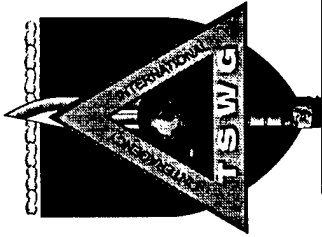

Lightweight Body Armor



TSWG is a joint effort of the Army, Navy, Air Force, and Marine Corps. It is a part of the Department of Defense's efforts to develop and field the next generation of body armor.

Requirement:

- Develop ultra-lightweight flexible body armor

Status:

- Completed development of armor using ZYLON fabric
- Completed NIJ Level IIIA certification
 - 9mm FMJ and 0.44 MAG projectiles
- Lightest Level IIIA armor currently available

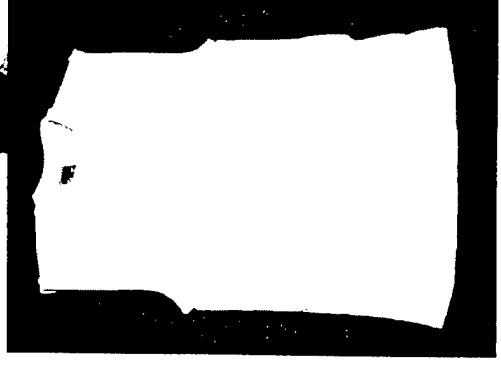

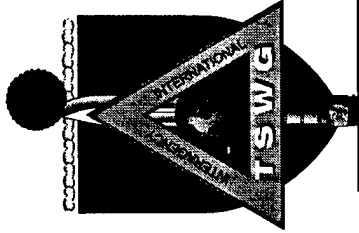

Physical Security



- Blast Protection & Mitigation
- Entry Point Screening
- Vulnerability Assessments
- Advanced Sensors

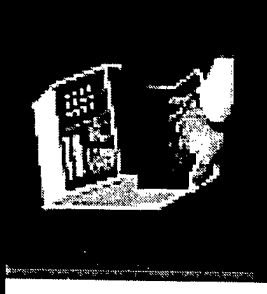
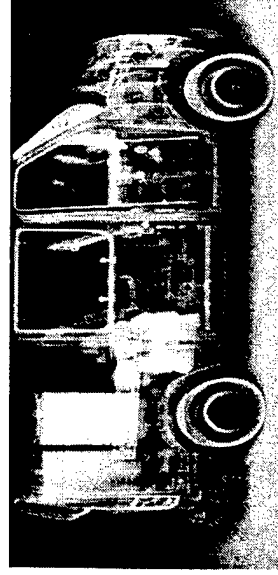
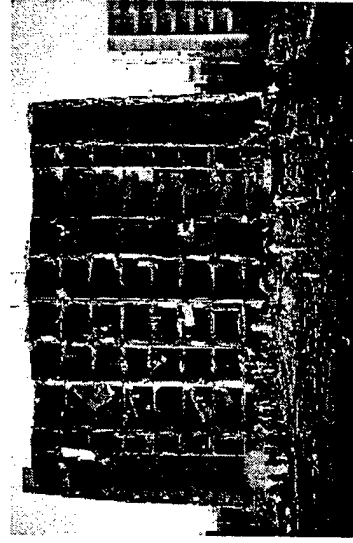
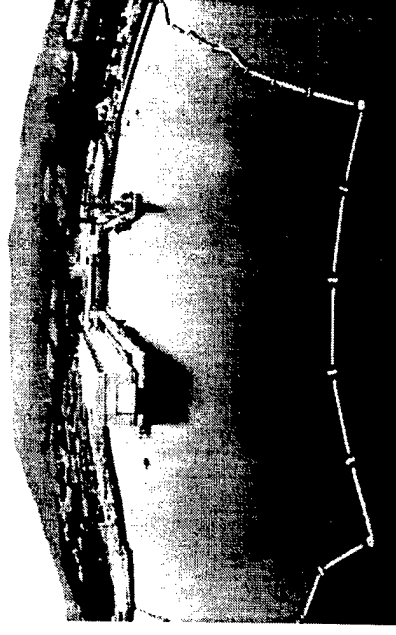
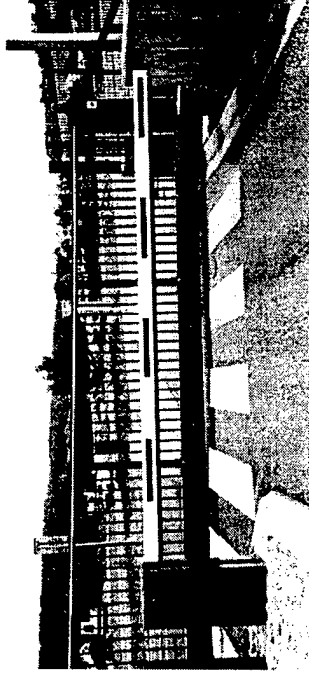

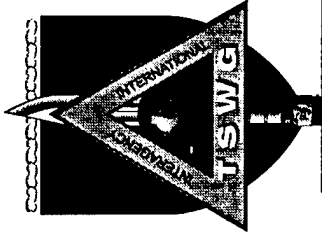

Surveillance, Collection, and Operations Support



- Specialized Surveillance Equipment
- Reconnaissance Enhancement
- Terrorist Search and Recognition Systems
- Information Operations

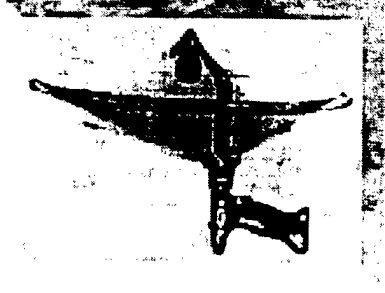

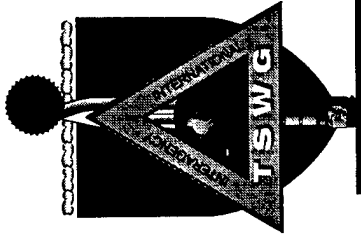

Tactical Operations Support

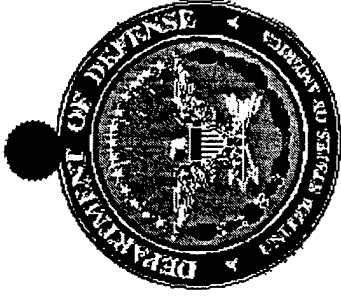

- Advanced Imaging Systems
- Specialized Access systems
- CBRN Detectors
- Tactical Offensive Systems
- Tactical Communications Systems



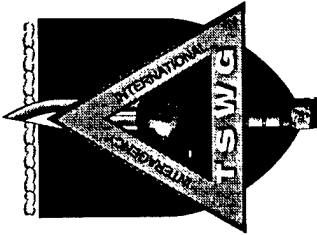

Field Tests Show Halo Reduction



... ..

**Standard OMNI IV
Night Vision
Monocular**

**Reduced Halo
OMNI IV
Prototype System**

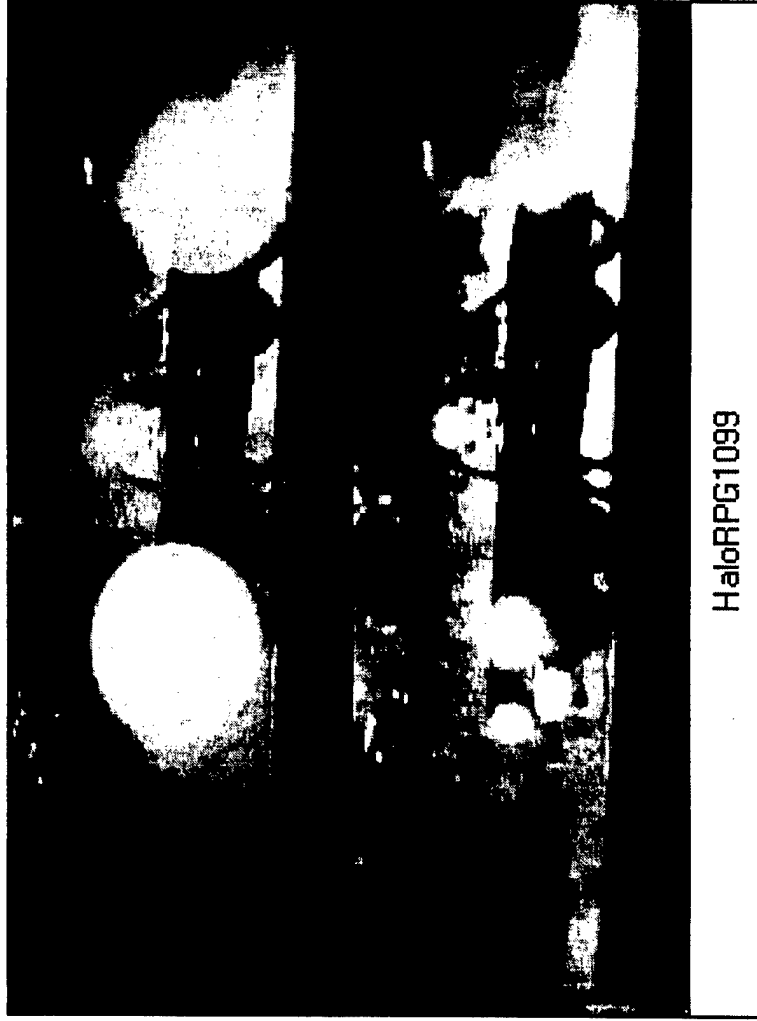

HaloRPG1099



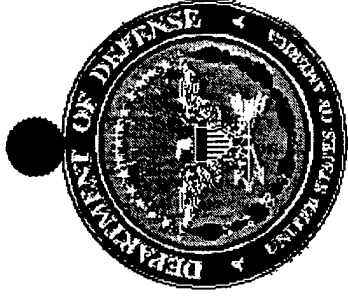
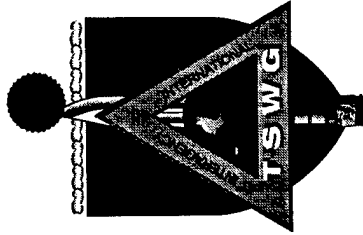

SUMMARY

- **Forum to Rapidly Identify, Prioritize, and Resolve Needs/Requirements**
- **User Driven**
- **Interagency and International**
- **Effectively Support Transitional to Acquisition and Commercial Production**

● ● ●
Virginia Department of Emergency
Management

WMD Support to Military Installations

Brett A. Burdick

Director, Technological Hazards Division
Virginia Department of Emergency Management

VDEM is Virginia's Consequence Management Agency

- **Tasked by Executive Order**
- **Planning**
- **Training**
- **Exercising**
- **Equipping**



Terrorism Courses

- Training since 1995
- Public Safety Response to Terrorism
- Course Levels
 - ◆ Awareness
 - ◆ Tactical Considerations
 - ◆ Management Considerations

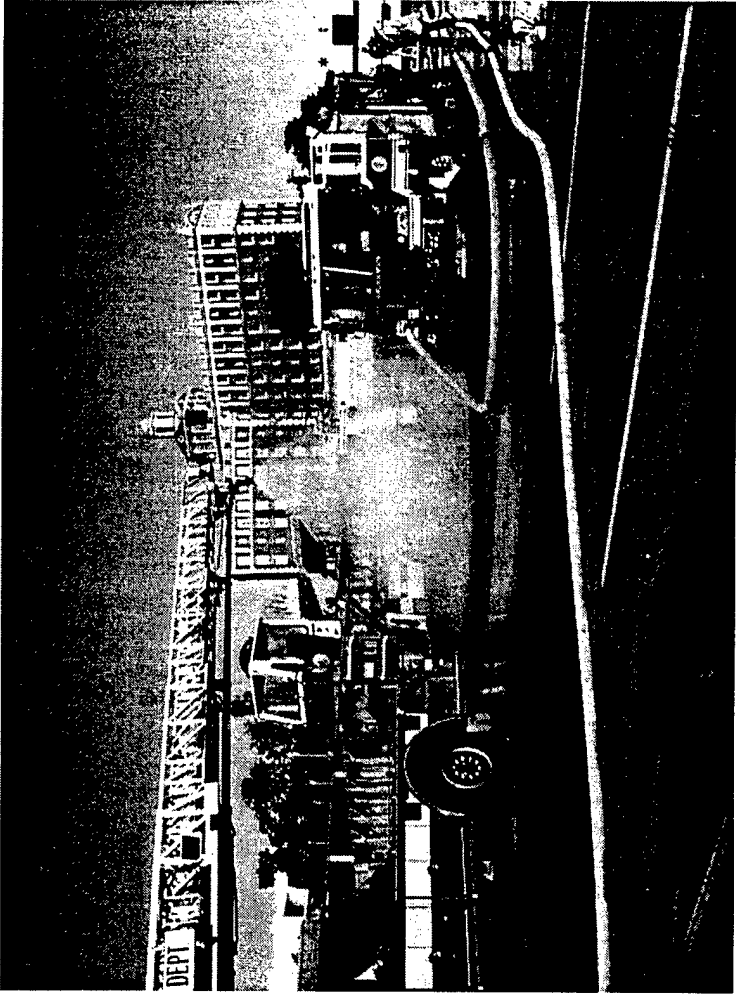

Developed Plans

- Virginia's Terrorism Consequence Management Plan
- Sample jurisdictional plan
- Congruency with federal plans

Exercises

- **ILL WIND**
- **TERMINAL BREEZE**
- **Several CLASSIFIED Exercises**
- **Regional WMD Drills**
- **SERTEX 2001**

Major Issues

- Command and Control
- Communications
- Logistics
- Decontamination
- Federal understanding of own plans

Command and Control



- Incident Command System
- Unified Command System
- Governor's authority
- VDEM coordination role
- Too many command centers

Communications

- Not interoperable
- Black box fix for tactical control
- Heavy reliance on cell phones
- Vulnerable to cyber attack
- Still room for pencils and paper

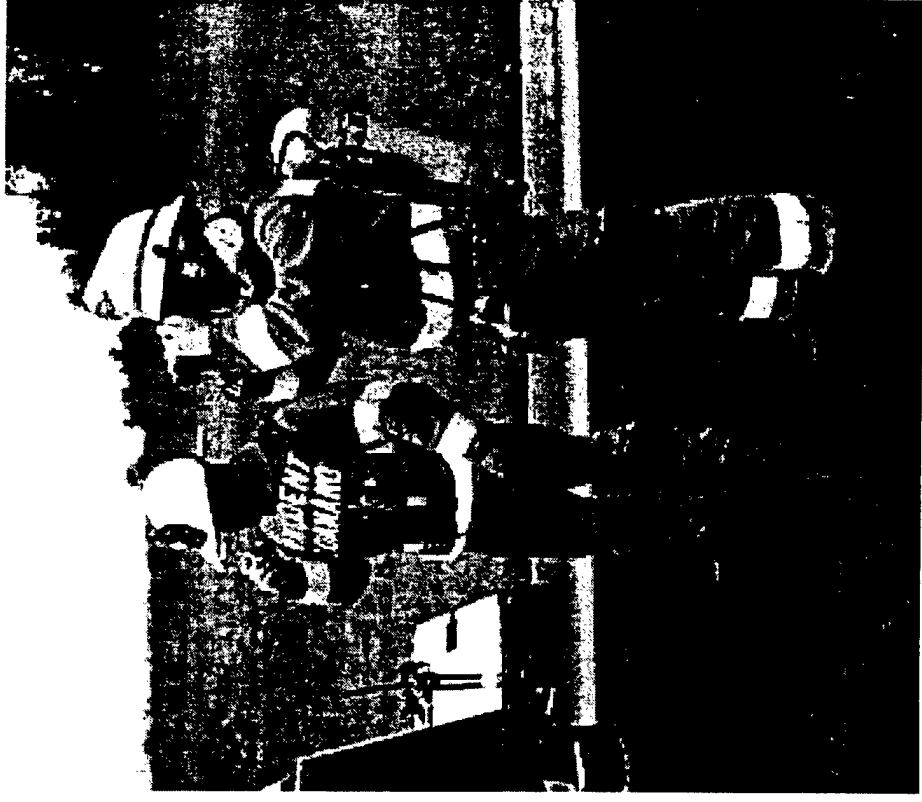

Logistics

- Local response will starve after 8 to 10 hours
- State response will not arrive in force for 24 hours
- Federal response will come much later
- National Pharmaceutical Stockpile
- Security
- Lessons from Oklahoma City

Decontamination

- Identifying need
- Immediate
- Effectiveness
- Water-based
- Don't use bleach
- “Decontamination in depth”



● ● Federal Understanding of Own

Plans

- Generally poor
- Don't follow what is written
- Make it up as you go along
- Change with the “phase of the moon”
- Understanding of other agency plans is nonexistent
- Leads to conflict, inefficiency, multiple mission assignments

Solutions

- **Talk to each other**
- **Work out Command and Control issues**
 - ◆ Military support
 - ◆ Multiple levels of government
 - ◆ Problem doesn't stop at fence
- **Communications interoperability**
 - ◆ IAB efforts
 - ◆ Find appropriate level of linkage

Solutions (cont'd)

- **Logistics**
 - ◆ Capabilities inventory, not resource lists
 - ◆ Understand personnel requirements
 - ◆ Improve civilian capabilities
 - ◆ Collective Protection/Force Protection
- **Decontamination**
 - ◆ Everyone needs to know how
 - ◆ Implement immediately
 - ◆ Can't get too much or too good!

Solutions (cont'd)

- Federal understanding of plans
 - ◆ Cross-training
 - ◆ Exercising
 - ◆ Can't support what you don't understand

State Assets

- **VDEM**
 - ◆ 13 Regional Hazardous Materials Response Teams
 - ◆ 10 Hazardous Materials Officers statewide
 - ◆ SAR
 - ◆ Command vehicles
 - ◆ Emergency Management expertise
 - ◆ Legal authority
 - ◆ Training, Planning, Exercising

State Assets (cont'd)

- Virginia State Police
 - ◆ 1600 Troopers
 - ◆ 350 Investigators
 - ◆ Bomb Technicians
 - ◆ Motor Carrier Troopers
 - ◆ Legal authority
 - ◆ Command vehicles
 - ◆ Rapport with local law enforcement

State Assets (cont'd)

- **Virginia Department of Health**
 - ◆ Epidemiological surveillance
 - ◆ EMS Task Forces
 - ◆ Laboratory capabilities
- **National Guard**
 - ◆ Liaison
 - ◆ WMD-Civil Support Teams
 - ◆ Traditional guard missions
 - ◆ Security clearance

End



• •

Responding to Weapons of Mass Destruction/Terrorism on Military Installations

Lt. Eric E. Hahn

Boston Police, Special Operations Division

Common Core Management Issues

Isolation

Decontamination

Protection

Treatment

Identification

Evacuation/Shelter

Containment

Recovery

Interoperability Issues

Command and Control (ICS Format)

Standard Operating Procedures

Equipment

Workplace Compliance Regulations

Communications



• •

The Main Solution

MOOD

The MOU Should Address

Mutual Aid Issues

Interoperability Issues

Cross-Training Issues

Credentials



The Bottom Line

We're all in this together. A threat to you is also a potential threat to us and vice versus.

We share common goals and with a little planning and common sense there is no reason why we can't work together..So.....

To turn the phrase around.....

**“Hi.....I’m a civilian and I’m
here to help you”**



USAF Force Protection Battlelab

Innovus Defensor Fortis

SO/LIC SYMPOSIUM BRIEFING

14 February 2001

Lt Col James A. Swaby

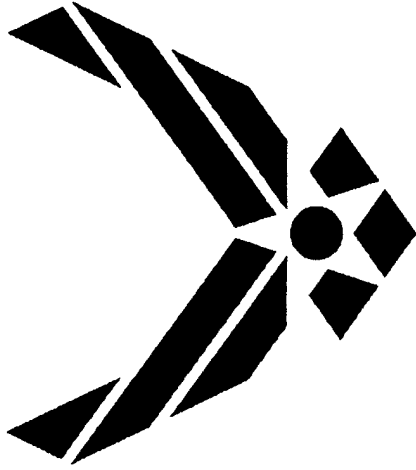

U.S. AIR FORCE

Lt Col James Swaby



U.S. AIR FORCE

Overview

- **Background Information**
- **CBAWS Initiative**
- **DESS Initiative**



U.S. AIR FORCE

AFFPB Vision

*“Provide an arena to measure the worth
of force protection concepts and ideas; driving
innovations in tactics, organization, and doctrine”*

Innovus Defensor Fortis



U.S. AIR FORCE

AFFPB Process

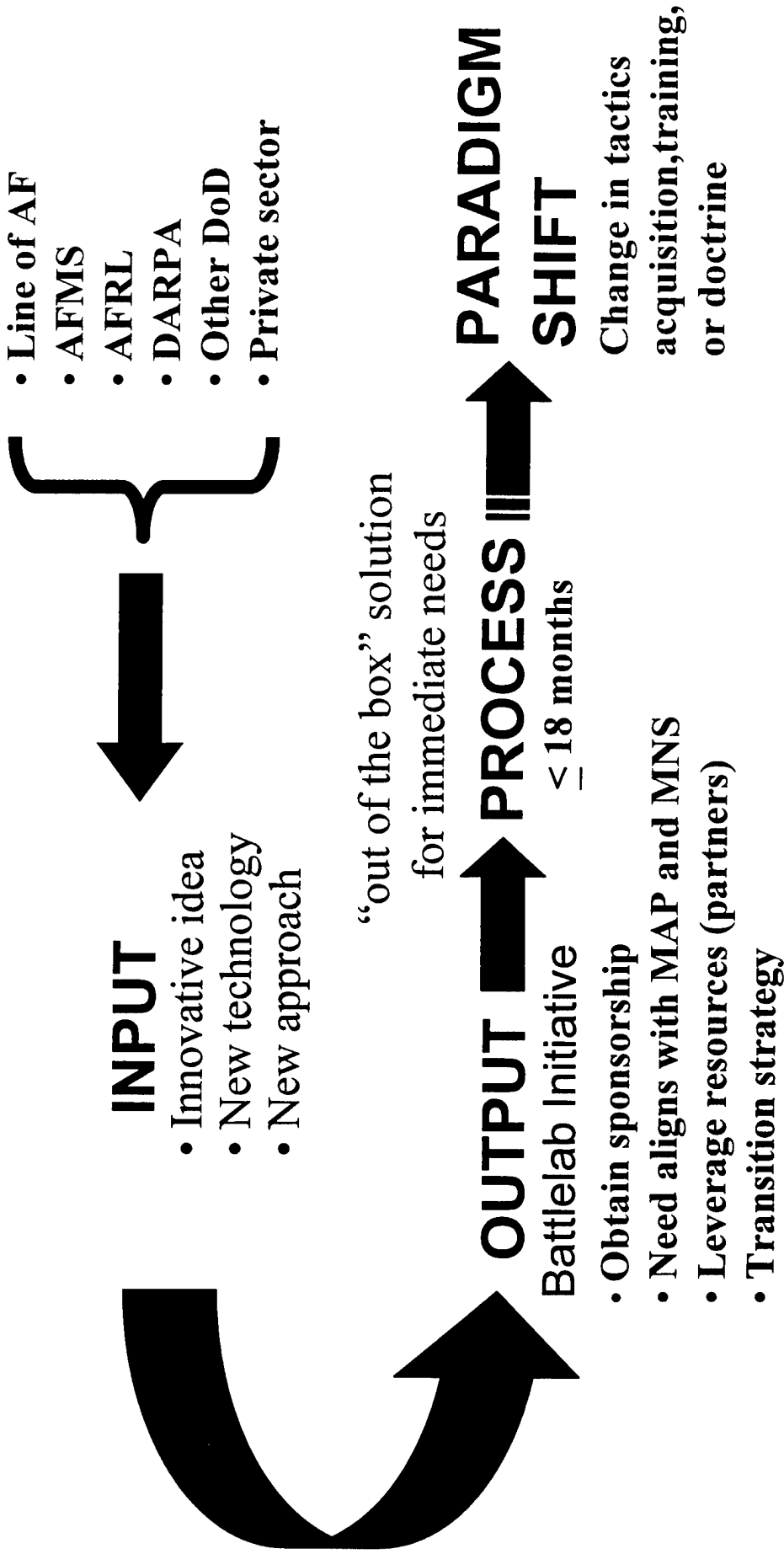



U.S. AIR FORCE

Security Forces Organization

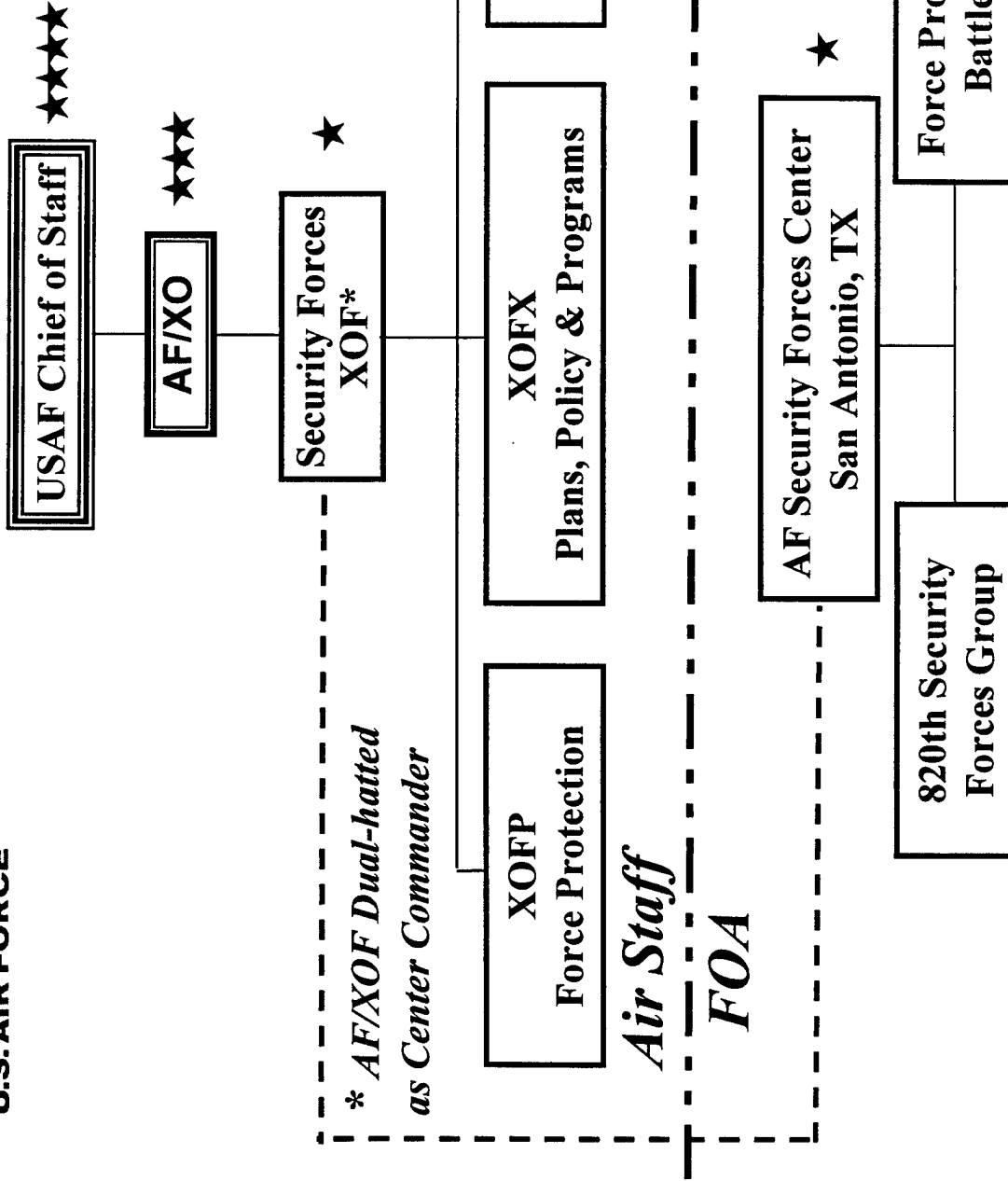

* AF/XOF Dual-hatted
as Center Commander

Air Staff

FOA



U.S. AIR FORCE

AFFPB Specialists



Structural Engineer

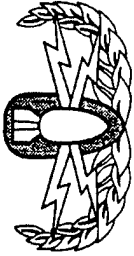

Explosive Ordnance Disposal

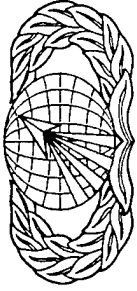

Scientific Analyst

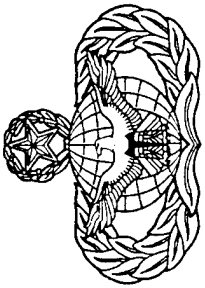

Security Forces

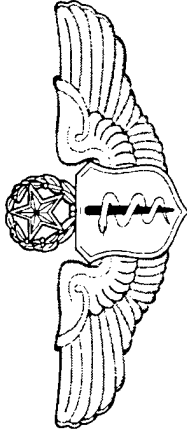
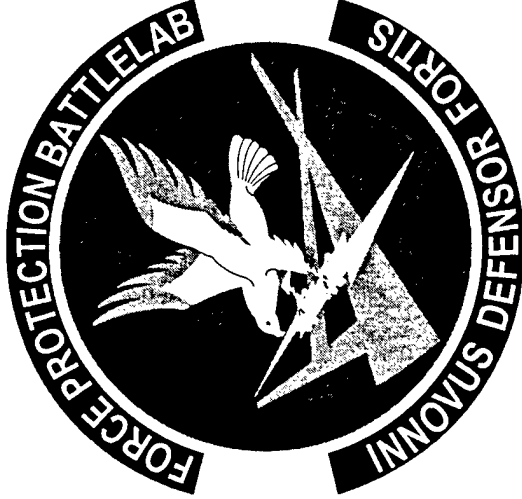

Flight Surgeon

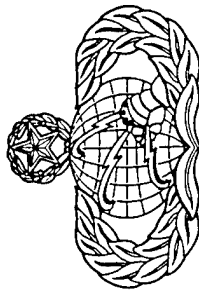

Communications

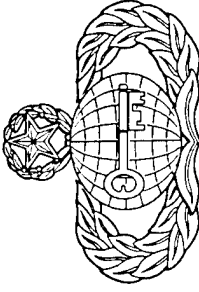

Intelligence

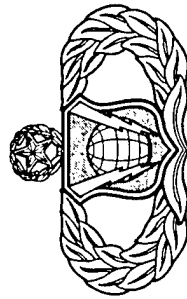

Command and Control

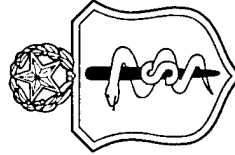

Entomologist



Readiness Technician



USAF Force Protection Battlelab

Innovus Defensor Fortis

Chemical-Biological Aerosol Warning System



U.S. AIR FORCE

Lt Col James Swaby



Bottom Line

U.S. AIR FORCE

- A true alert-to-warn and alert-to-treat CBAWS is possible using COTS & GOTS equipment
- First CBAWS kit can be fielded in 6-12 months
- CBAWS is not the ideal, it has limits but it is possible to field a true alert-to-warn system



U.S. AIR FORCE

Initiative Description

Initiative Name: Chemical-Biological Aerosol Warning System (CBAWS)

Problem: We have no true alert to warn CB sensor system

Innovative Concept: Can we deploy a true alert to warn CB sensor system for the “first-in” rapid deployment forces?

Demonstration Mission Statement: Demonstrate the utility of using a tactical, agile prototype coupled chemical-biological (CB) sensor system for forward-deployed, first-in forces to provide notional early alert & warning capability of an aerosol attack employing chemical or biological agents

Solution set: Use existing technologies COTS & GOTS to devise a CBAWS

Partners: AFIP, MSBL, SBCCOM, 820 SFG, & 786 CRG

Proposed Sponsorship: HQ ACC/ILE &/or HQ ACC/SG



Objectives

U.S. AIR FORCE

- Provide a quickly deployable, small, portable, easy-to-use & maintainable perimeter CB sensor system network for generic “early alert to warn” & specific alert to treat capability
 - Contain a personnel alert & warning system (RF/pager link)
 - Use wireless COTS & GOTS technology
 - Make it one man portable & deployable
 - Maintain a small foot print
 - Enhance force protection situational awareness & rapid decision making.
 - Alert to mask in <1 minute from CB detection
 - Facilitate phased employment of personal protection equipment
 - Reduce time to decision to remove personal protection equipment
-



U.S. AIR FORCE

CBAWS Components

— Tier I

- Status: shelved by Army**
- Sensor: particle detector**
- Advantages:**
 - True 13Km alert-to-warn stand-off**
 - One-man portable/deployable, simple**
 - Battery operated**
 - RS 232 connection**
 - Capable of collecting a sample**

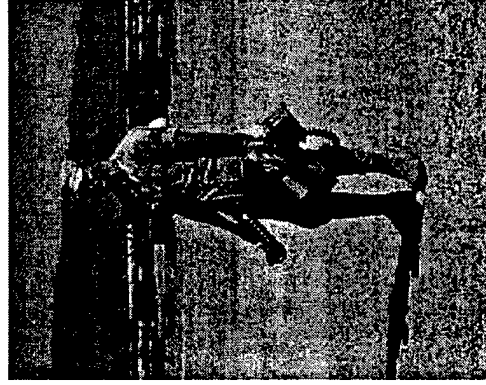

One-man portable
One-man deployable

Simple to operate

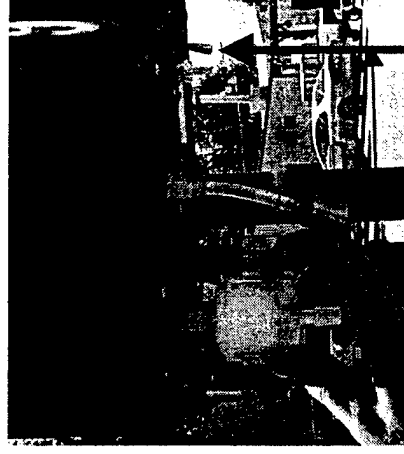

Sample filter **Switch**

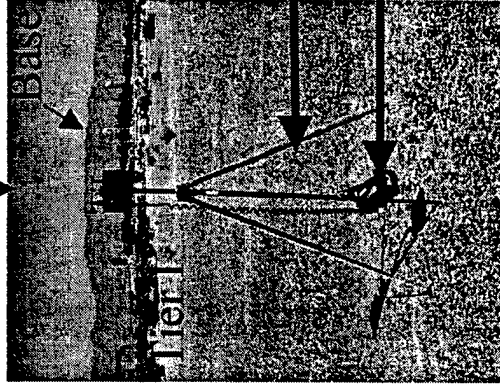

Tripod

Battery & cable



CBAWS Components

U.S. AIR FORCE

- Tier I (cont.)
- Advantages:
 - GPS
 - Meteorological weather station
- Limitations:
 - False alarm rate
 - Subject to tampering
 - Daily battery maintenance
- Solution:
 - Altered algorithm
 - Connected to TASS

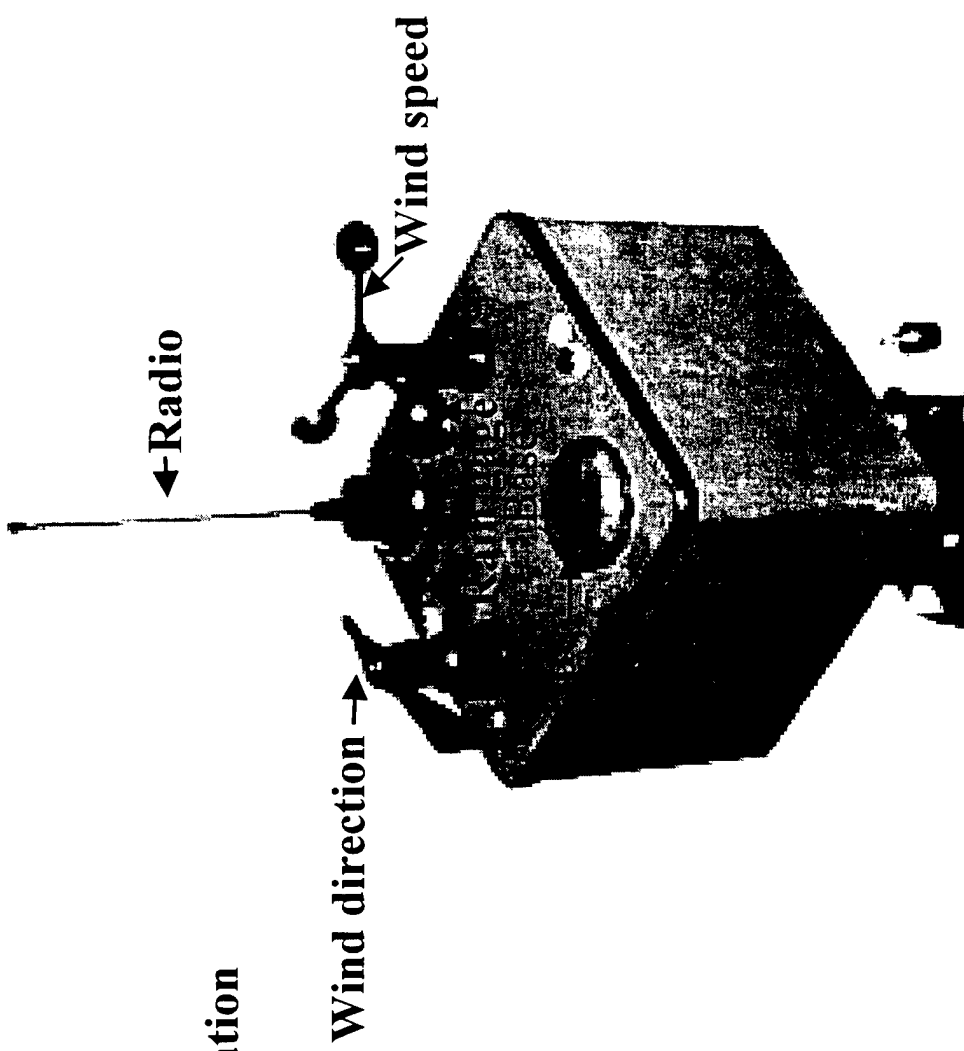

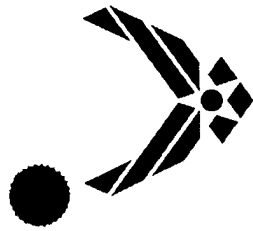

CBAWS Components

U.S. AIR FORCE

– TASS (Tactical Automated Sensor System)

- Status: Fielded
- Advantages:
 - Battery
 - Photoelectric panel recharger
 - Radio
 - Tamper detection
 - Low battery alert
 - Simple to operate
 - One-man portable/deployable
- Limitations: Needs adapter cables
- Solution: Built cables

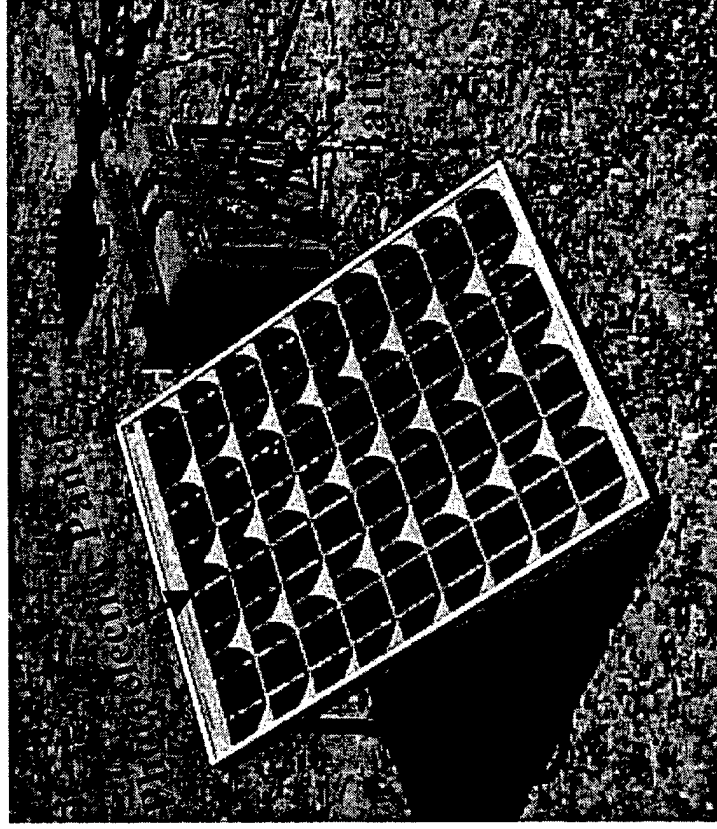



CBAWS Components

U.S. AIR FORCE

ACADA

- Status: Being fielded
- Sensor: Ion mobility spectrometry
- Advantages:
 - Gives generic nerve or blister agent ID
 - One-man portable & deployable
 - Battery operated
 - RS 232 connection
 - Simple to operate
- Limitations:
 - Limited by M42's 400M range
 - Alarm difficult to hear in noisy environments
 - Subject to tampering
 - Battery maintenance
- Solution:
 - Connect to Tier I radio
 - Connected to TASS

ACADA

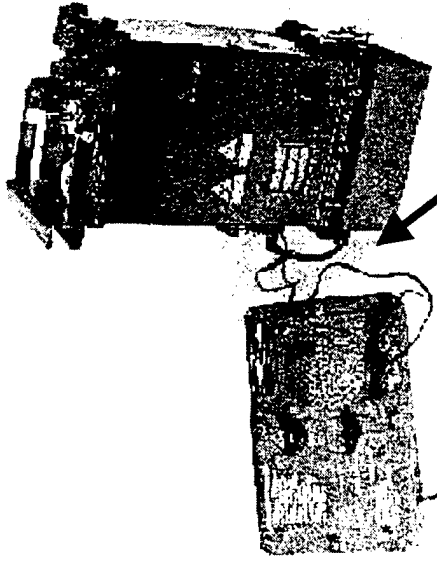

M42 alarm

400M Com. wire



CBAWS Components

U.S. AIR FORCE

– True alert to warn, stand off CB sensor system

– Combines GOTS:

- Tier I (shelved)
- ACADA (limited range)
- TASS (successfully fielded)

– Advantages:

- 13 Km range
- Wireless (radio)
- Tamper detection
- Low battery alert
- Limited maintenance
- One man portable/deployable
- Bio sample collection
- Simple - 1 hr training, 5 Min setup

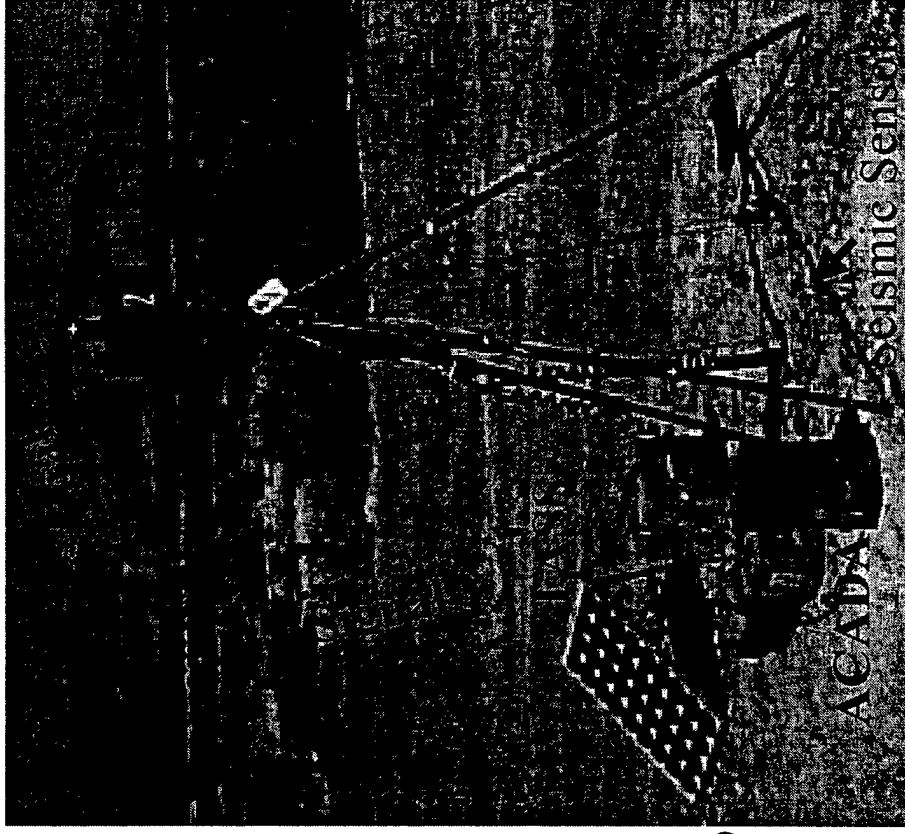



U.S. AIR FORCE

CBAWS Components

- True alert to warn, stand off CB sensor system (cont.)
 - Limitations:
 - Generic CB identification
 - Possible false alarms
 - Could be circumvented
 - Solution: Algorithm, Tier III, M21, RAPID & M256

Agent delivered over alert-to-warn sensors

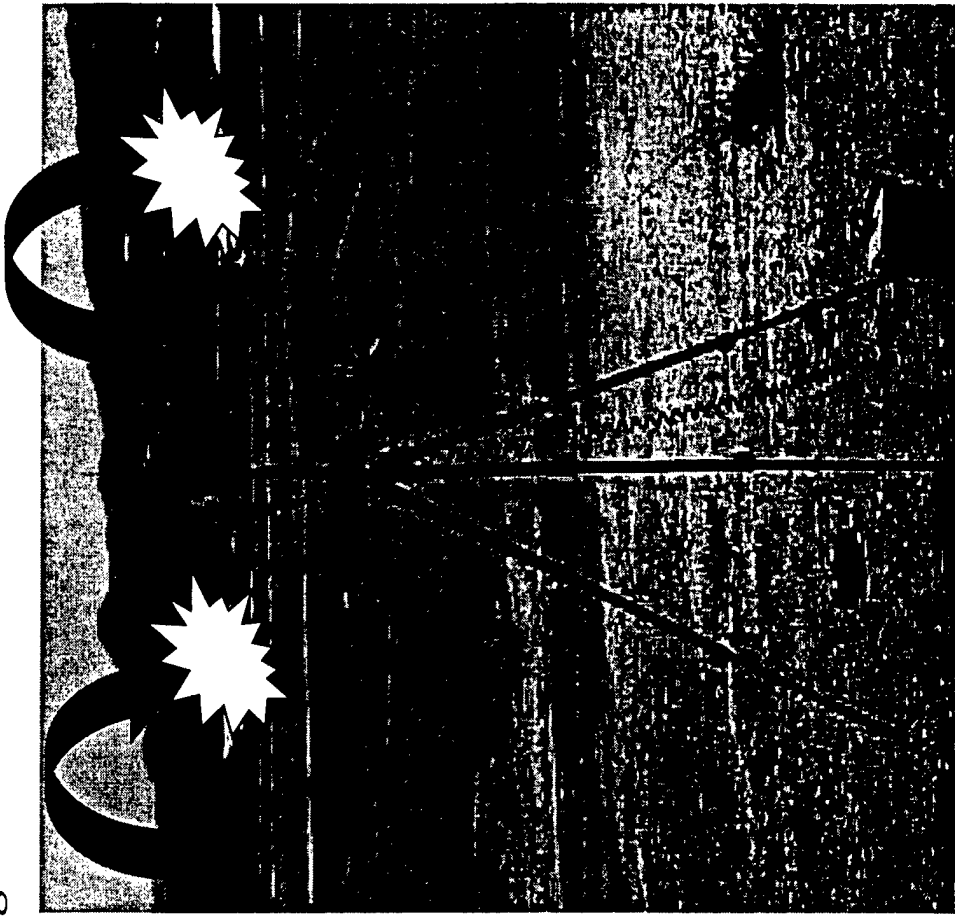



CBAWS Components

U.S. AIR FORCE

– Tier III

- Status: Early prototype
- Sensor: Passive UV Laser
- Advantages:
 - ID's if particle cloud is biological
 - One-man portable & deployable
 - Simple to operate
- Limitations:
 - Subject to tampering
 - Prototype
- Solution:
 - Tied to Tier I radio
 - Used TASS tamper detection
 - Deployed one per 10 Tier I's

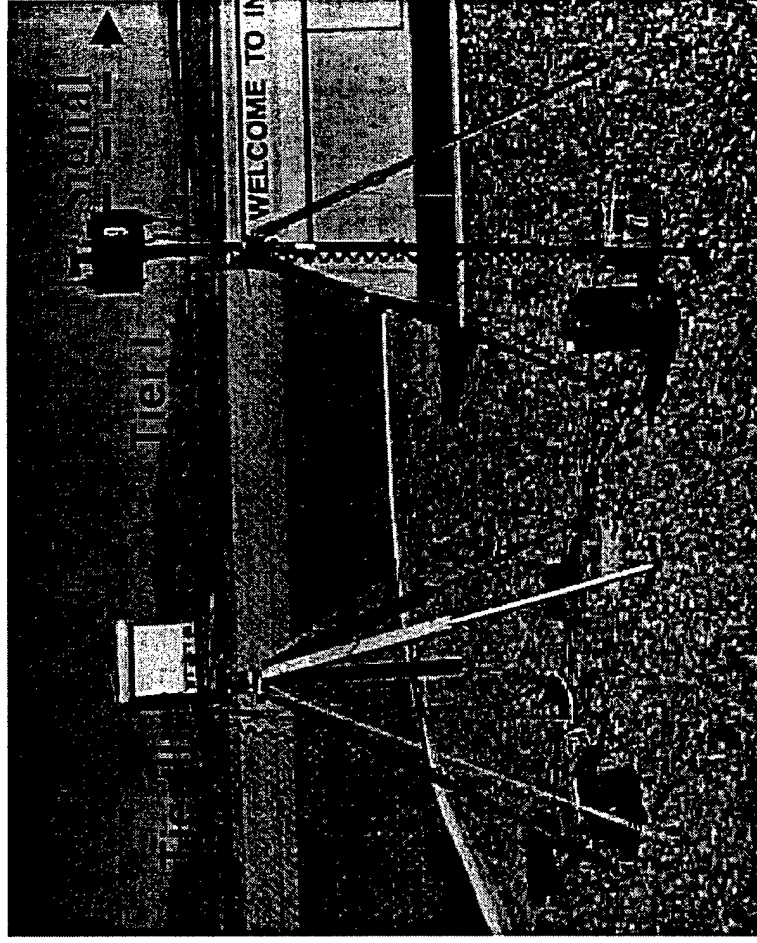



CBAWS Components

U.S. AIR FORCE

– M21

- Status: Being fielded
- Sensor: Passive infrared detector
- Advantages:
 - Gives generic nerve or blister agent ID
 - One-man portable & deployable
 - 5 mile range
 - Simple to operate
- Limitations:
 - AC power
 - 60° window (need more than one)
 - Direct cable to base station
- Solution: Replace with next generation IR detector

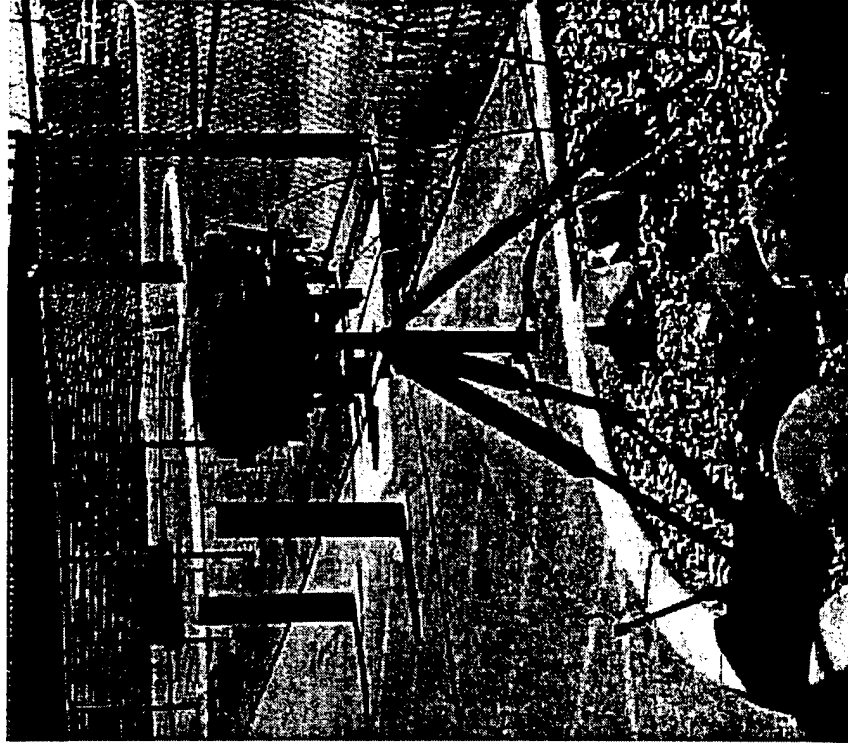



CBAWS Components

U.S. AIR FORCE

– Base station

– Components:

- PC Analysis Work Station (PAWS)
- Telemetry transceiver (GPS)
- Simulation interface PC
- M42 alarm

– Advantages:

- Adjustable alarm thresholds
- Displays condition yellow then red
- Sounds M42 alarm
- Sends NBC reports
- Can send warning to personnel (beepers)
- Remotely diverts air flow to collect bio sample
- Displays all meteorological data
- One man portable/deployable
- Simple - 3 hr training, 1 Hr setup
- Supports digital rehearsals
- Limitations: Requires AC power

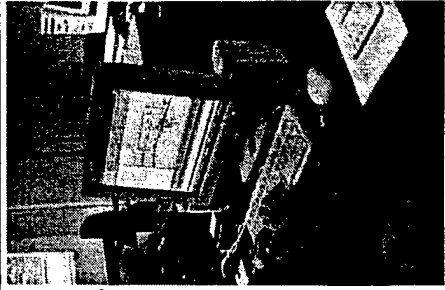



U.S. AIR FORCE

Generic CB Alert To Warn

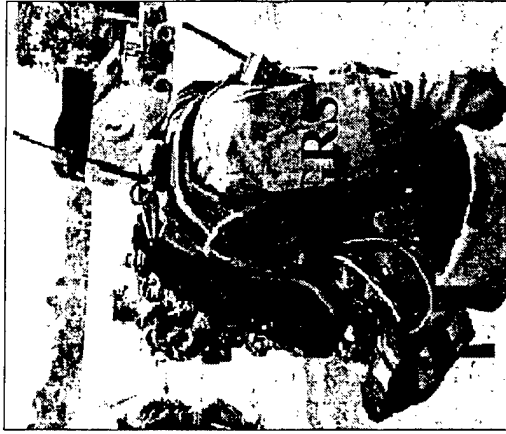
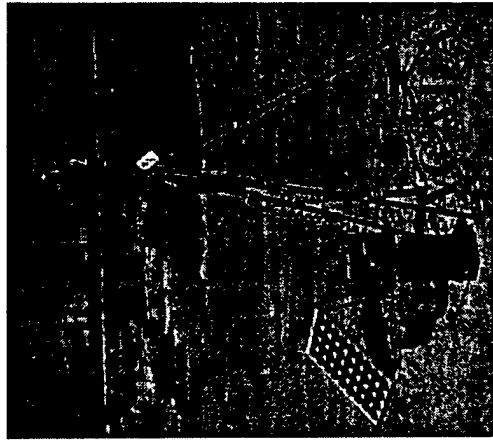

< 1 Min.



Real time



ESC2

Innovus Defensor Fortis



U.S. AIR FORCE

Specific Alert To Treat

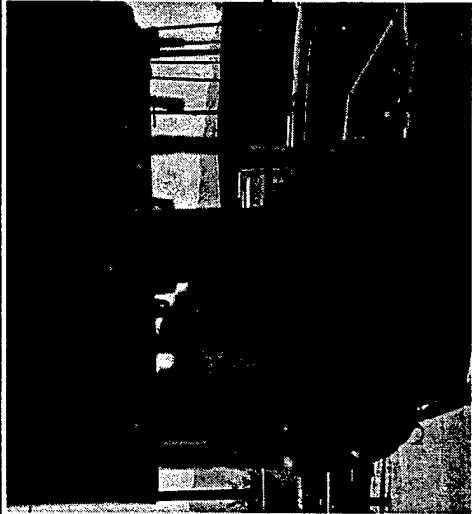

Biological: PCR with the

**Rugedized
Advanced
Pathogen
Identification
Devise**



**Chemical: M256A1 or
M18A1
kits
in
minutes**

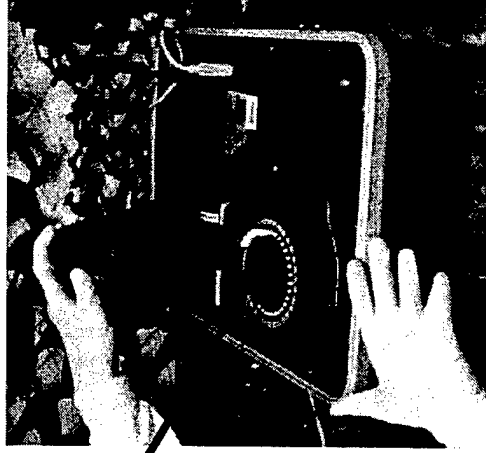
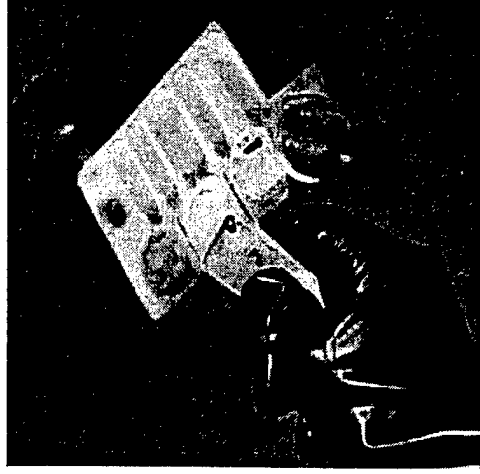

< 3 hours from first alert

Innovus Defensor Fortis



U.S. AIR FORCE

Deployable

Small Footprint



- 20 Tier I sensor-hubs
- 20 Tier I tripods
- 1 Tier III UV sensor
- 1 Tier III tripod
- Batteries
- Cables
- Chargers
- Antenna
- Base station
- RAPID
- PCR expendables

This is a 30 day mission load!



U.S. AIR FORCE

CBAWS vs. JBPDS

CBAWS Total Kit (20 units)

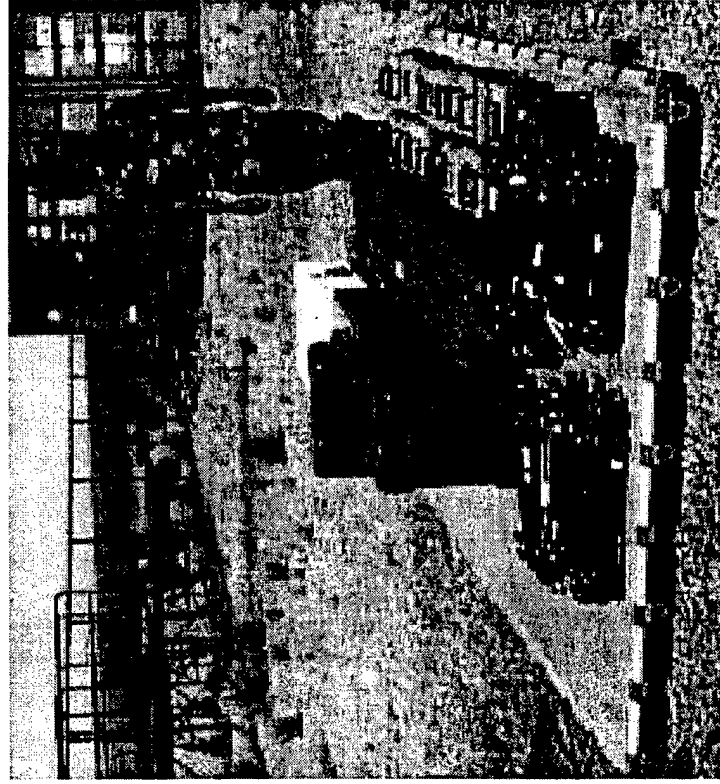

**This is a 30 day mission load!
Small Footprint**

JBPDS (1 unit)

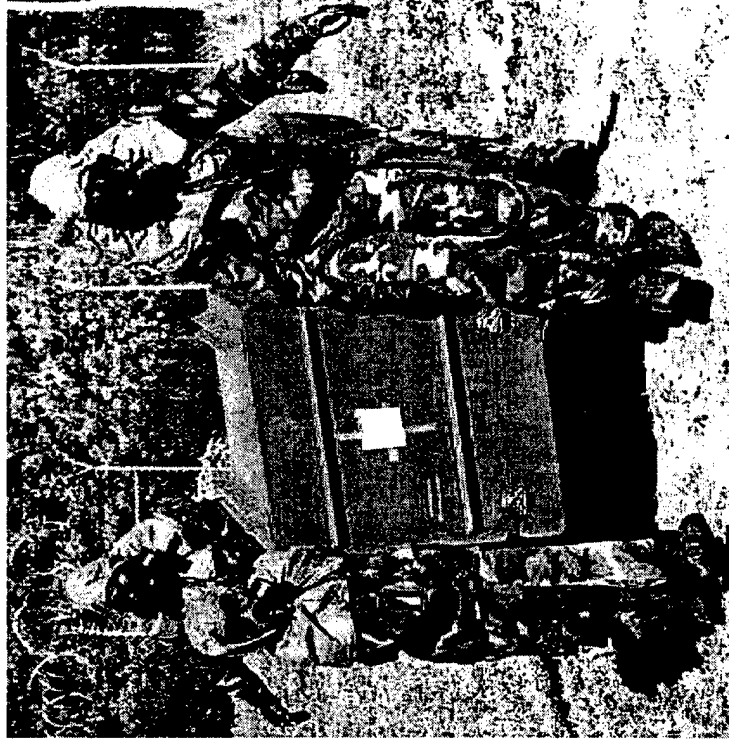

**2 Pieces, 300+ lbs. ea.
plus generator**

Innovus Defensor Fortis



Chem/Bio Alert and Warning System

(CBAWS)

U.S. AIR FORCE

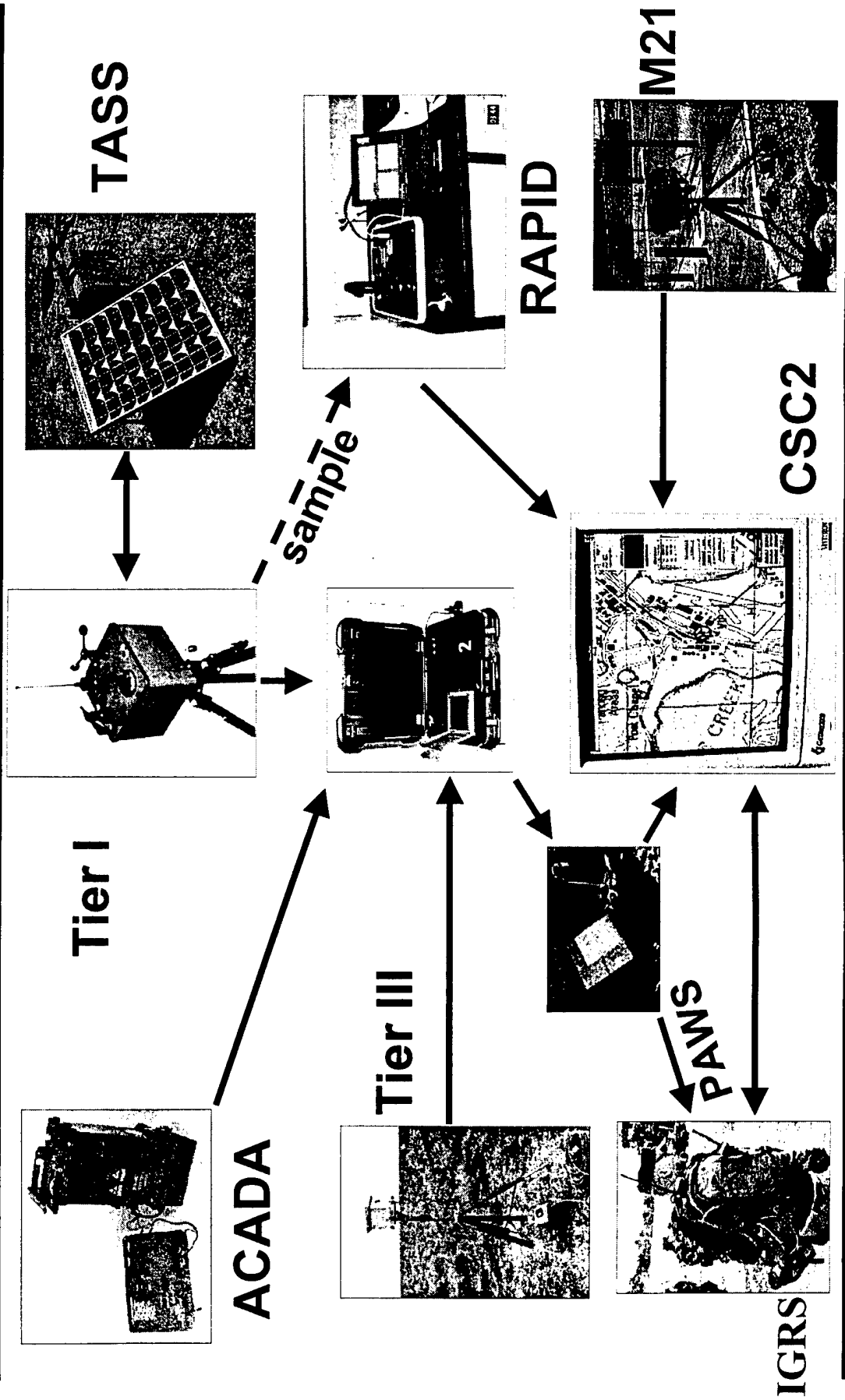

Innovus Defensor Fortis



Current Status

U.S. AIR FORCE

- Army field testing completed:
 - 1-25 Jun 99, Dugway Proving Grounds, UT
 - 2-6 Aug 99, Fort Leonard Wood, MS
 - 16-20 Aug 99, ULCHE FOCUS LENS 99, Yakima, WA
- Air Force field testing completed:
 - 25 Aug - 3 Sep 99, JEFX 99, Indian Springs, NV
 - 26 Jul - 5 Aug 00, JEFX Spiral 3, Indian Springs, NV
 - 1-16 Sep 00, JEFX 00 Execution, Indian Springs, NV
- Air Force field testing planned:
 - 22-26 Jan 01, 820 SFG, Mountain Home AFB, ID



Current Status

U.S. AIR FORCE

- Pursuing transition to end-user:
 - Collaborating with ESC/FD and 311th HSW/YA (lead)
 - System will be deployed in a two phases:
 - Block 1:
 - Rapid fielding by using COTS/NDI items (3400, O&M funds)
 - Prepare 1 kit (from existing equipment) with 3 options
 - Kit ready within 6 months after receipt of 3400 funds at YA
 - Block 2:
 - Product improvement to block I, effort to include:
 - Incorporate new hardware (JCAD, JSLCAD, and upgrade BAWS)
 - Incorporate latest JWARN software, hardware interface and communications protocols

Streamlined COTS/NDI acquisition approach



Current Status

U.S. AIR FORCE

— Aggressively seeking sponsorship

- 12 Oct HQ USAF/SGX briefing
 - 25 Oct TSWIG briefing
 - 7 Nov 00, ACC FP IPT briefing
 - 8 Nov 00, JSIG briefing
 - 9 Nov 00, J-34 briefing
 - 9 Nov 00, RESOPS ACTD briefing
 - 13 Dec 00, Medical Readiness Symposium
 - 14 Dec 00, HQ USAF/SG & GO Council
 - 10 Jan 01, USD/DDR&E & DATSD/CBDP
 - __ CENTAF/CC
 - __ HQ ACC/ILE briefings (working)
 - __ JSMG briefing (planned)
 - __ CENTCOM (planned)
 - __ SOCOM (Planned)
 - __ AFSOC (planned)
 - __ PACAF (planned)
-



Bottom Line

U.S. AIR FORCE

- A true alert-to-warn CBAWS is possible using COTS & GOTS
 - Includes alert-to-treat chemical identification in minutes
 - Includes alert-to-treat biological agent identification in < 3 hrs
 - One-man portable/deployable & fits on 1/3 of a pallet
- CBAWS has limitations & requires risk management
 - Tactical for first-in, light weight, mobile, 786 CRG, 820 SFG type forces
 - Alert-to-warn CB sensor false alarms minimized but still possible
 - Better in certain environments than others
- There is still work to be done
 - Need CONOPS
 - Need AFOTEC testing
 - Need biological identification probe freeze-drying
 - Need to resolve certain configuration issues



Summary

U.S. AIR FORCE

- Users have an immediate need for chem-bio detect to warn capability
- CBAWS has been successfully demonstrated in five test/exercises to meet this need
- AF 311 HSW/YA has draft acquisition plan in coordination
- Seeking consensus
- Firming up sponsorship:
 - Immediate funding for 1st Block 1 basic kit
 - Funding for Block 1 enhancements
 - Launch Block 2

USAF Force Protection Battlelab

Innovus Defensor Fortis

Deployed Environmental Surveillance System

Lt Col James A. Swaby



U.S. AIR FORCE

Lt Col James Swaby



DESS Initiative Description

U.S. AIR FORCE

Initiative Name: Deployed Environmental Surveillance System (DESS)

Problem: Not fully addressing Public Law 105-85 requirement to monitor individual environmental exposures during contingency operations

Innovative Concept: Can we monitor the environmental exposure of each individual during contingency operations?

Demonstration Mission Statement: Demonstrate the utility of combining use of forward-deployed agile, Chemical, Biological, Radiological, Nuclear (CBRN) detection and identification units with combined environmental hazard databases linked to central consultative services

Solution set: COTS & GOTS, CBRN detection/identification technologies tied to reach-back environmental databases & consultants

Proposed Partners: 786 CRG, 820 SFG, AFIERA, AFIP, AFRL, MSBL, SBCCOM, SWIBR & USDA

Proposed Sponsorship: HQ ACC/SG



DESS Objectives

U.S. AIR FORCE

- **Capture individual CBRN exposures**
 - **Use a suite of individually worn sensor technologies**
 - **Tie to one-man portable/deployable identification technologies**
 - **Directly/immediately capture/transmit data**
 - **Provide a network solution for distribution & accessing of information**
 - **Create an aggregate CBRN view at the data input level**
 - **Display dynamic real-time CBRN hazard input, assessment & tracking**
 - **Link to rear-based CBRN databases & consultants**
 - **Facilitate immediate, front-line analysis & rapid decision making**
 - **Give tactical & medical commander instantaneous CBRN picture**
 - **Enhance force protection situational awareness & decision making**
 - **Provide preliminary CBRN assessment**
 - **Baseline assessment through real-time database/consultant linkage**
 - **Use one-man deployable COT & GOTS technologies with small footprint**
-

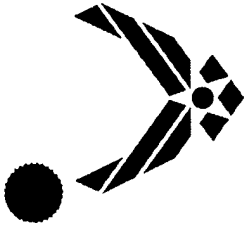

DESS Components

U.S. AIR FORCE

Components:

- (1) Individual exposure monitors
- (2) 1st echelon analytical & database capabilities
- (3) In theater enhanced analytical & database capabilities.
- (4) Robust, deployable analytical & consultative capabilities
- (5) Reach back, gold standard analytical, consultative, & database capabilities

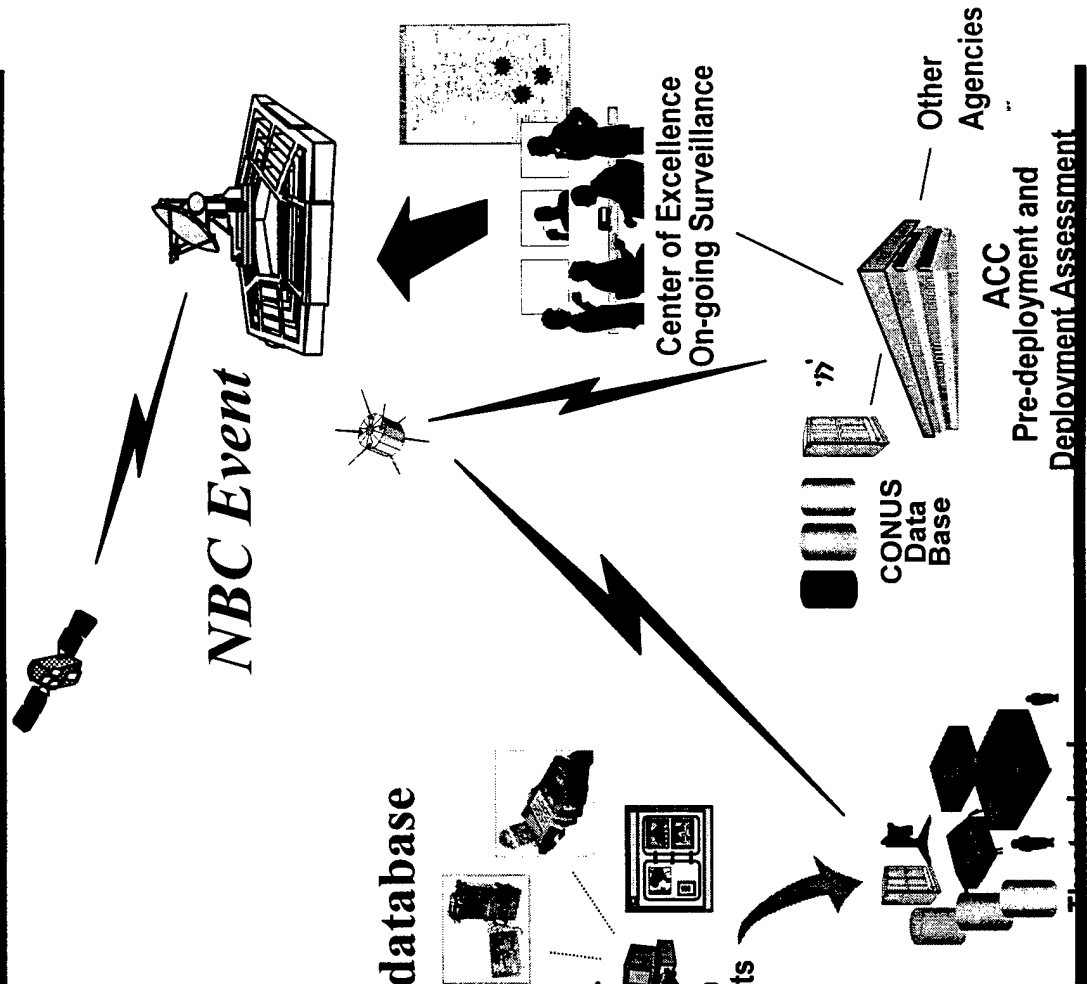



U.S. AIR FORCE

DESS Projected Schedule

Aug 00 - Mar 01:	Database & technology market survey (AFIERA & CTC)
Jan - Jun 01:	Initial Biological, Chemical & Radiological technology & procedures assessment
Mar - Jun 01 :	Combined technologies & database integration
Jun - Aug 01:	Initial field testing
Sep - Dec 01:	Demonstration
Jan - Feb 02:	Initiative final report



DESS Current Status

U.S. AIR FORCE

- **Doing market survey**
 - **Aggressively seeking sponsorship**
 - **12 Oct HQ USAF/SGX briefing**
 - **25 Oct TSWIG briefing**
 - **7 Nov 00, ACC FP IPT briefing**
 - **8 Nov 00, JSIG briefing**
 - **9 Nov 00, J-34 briefing**
 - **9 Nov 00, RESOPS ACTD briefing**
 - **13 Dec 00, Medical Readiness Symposium**
 - **14 Dec 00, HQ USAF/SG & GO Council**
 - **__ HQ ACC/SG, & ILE briefings (working)**
 - **__ PACAF (planned)**
 - **__ AFSOC (planned)**
 - **__ JSMG briefing (planned)**
-



DESS Summary

U.S. AIR FORCE

- **Not fully meeting Public Law 105-85**
- **Only have 18 months to complete initiative**
- **Concurrently working:**
 - **Requirements**
 - **Sponsorship**
 - **Partnerships**
 - **Proof of Concept: market survey**
 - **Transition/acquisition**



U.S. AIR FORCE

Questions?



Innovus Defensor Fortis



BATTLE SPACE BATTLE LAB





**Special Operations
Low Intensity Conflict
SO/LIC 2001**

**Colonel FRANK J. STONE
Director of Combat Developments
United States Army Infantry Center
Fort Benning, Georgia**



REQUIREMENTS PROCESS

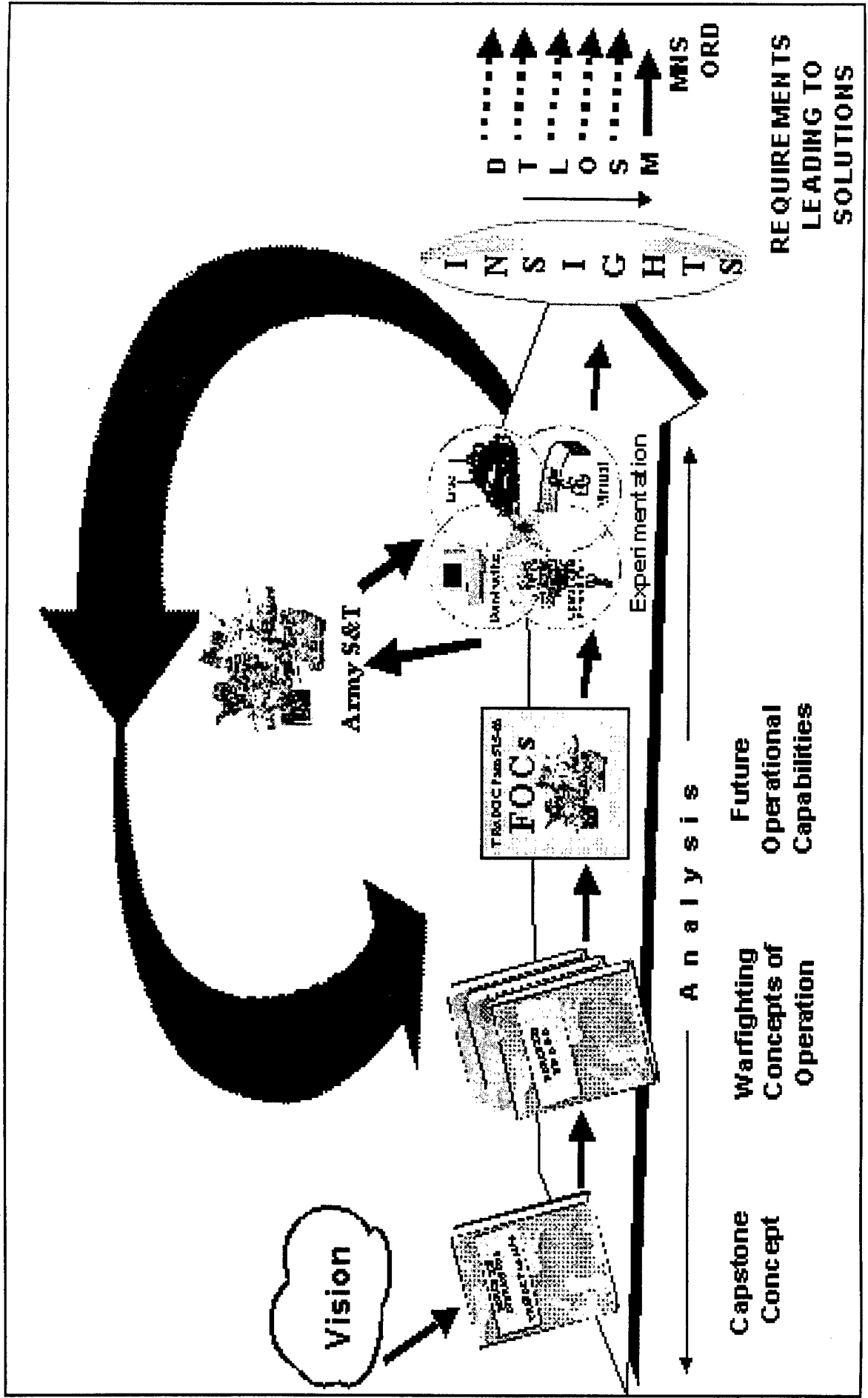



DISMOUNTED BATTLE SPACE BATTLE LAB

**BATTLE LAB
DEP DIR/HQ**
(COL Poody)

**LIAISON
OFFICER
SECTION**

Maintains and enhances close liaison relationship with the labs and organizations

AMC

DARPA

**DISMOUNTED
FORCES
DIVISION**
(C Kearns)

Conducts experiments on Dismounted Soldier Hardware, TTPs and Warfighting Concepts

**BATTLE
COMMAND
DIVISION**
(W Morimoto)

Conducts experiments on C4I systems

**EXPANDED
BATTLES
DIVISION**
(MAJ Echols)

Provides user management and oversight of the MOUT ACTD

**LAND WARRIOR
SIMULATIONS
DIVISION**
(J Chervenak)

Provides simulation, constructive and virtual support to the DBBL and Infantry School

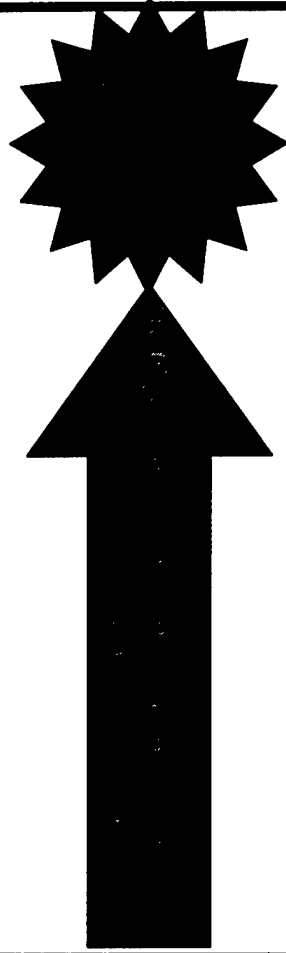



AFFILIATIONS

A large graphic of a hand holding a stack of blocks, with various military and agency logos scattered around it. The logos include:

- Airborne Battle Lab (top left)
- Diagonal stripes (top left)
- Airborne (top center)
- Mountain (top right)
- Lightning bolt (middle left)
- Airborne (middle left)
- Department of Defense (middle right)
- Department of Energy (bottom left)
- Department of Justice (bottom left)
- Department of the Air Force (bottom center)
- Department of the Army (bottom right)
- Department of the Navy (bottom right)
- Department of the Coast Guard (bottom right)
- Department of the State (bottom right)

Joint Services and Agencies



DISMOUNTED BATTLE SPACE BATTLE LAB PROGRAMS

- Dismounted Forces Division Programs
 - OSD Smart Sensor Web(SSW) and Antipersonnel Landmine Alternative (APLA)
 - Countersniper (to include Countersniper ACTD)
 - DARPA Small Unit Operations / Tactical Mobile Robotics / Exoskeleton
 - Combat Identification for the Dismounted Soldier
 - Own the Night
 - Enhanced Night Vision Goggle
 - Fused I2 and Thermal technology
 - LOSAT ACTD
 - Joint Non-Lethal Program
 - Under Barrel Tactical Payload System / Under Barrel Shotgun
 - Unmanned Ground and Aerial Vehicles (UGV / UAV)
 - Canadian/US Test and Evaluation Program - Experiment
- Battle Command Division
 - Light Digital TOC
 - Joint Enroute Mission Planning and Rehearsal System (JEMPRS)
- Expanded Battlespace Division
 - MOUT ACTD
 - Pointer UAV
 - Body Armor
 - Ladders
 - Rifle Launched Entry Munition (RLEM)
- Land Warrior Simulations Division
 - JANUS
 - CCTT
 - Land Warrior Test Bed



OPERATION FACILITIES

- **Mckenna Military Operations In Urban Terrain (MOUT) Site**
 - On-site Lodging (Platoon)
 - 3,700 ft Runway and Heliport
 - 430 Acre Maneuver Area
 - 15 Urban Structures 6 fully instrumented (inside tracking, cameras, audio)
 - Tunnel System
 - Preplanning and After Action Review Facility
 - Day and Night camera coverage outside and inside selected buildings
 - Control area for realtime monitoring of activities and data storage for AAR playback
 - Observer Controllers
 - Robotics Mobility Course under construction
- **Griswold Range**
 - 800 meter Known Distance firing range (5.56mm – 0.50 Cal)
 - Upper firing point that adds 1,000 meters to the range providing 1,800 meter target engagements
 - Maneuver area with forested terrain
 - Support building for range support
- **Kunzig Range**
 - Instrumented, Hardened Evaluation and Experimentation Tactical Objective
 - Fenced in compound
 - Two buildings and three out buildings
 - Three acre livestock fenced area
 - Four camera towers with day and night capability
 - Fiber optic export of data to control facility at McKenna MOUT site



6TH MOUNTED SIGNAL BATTALION

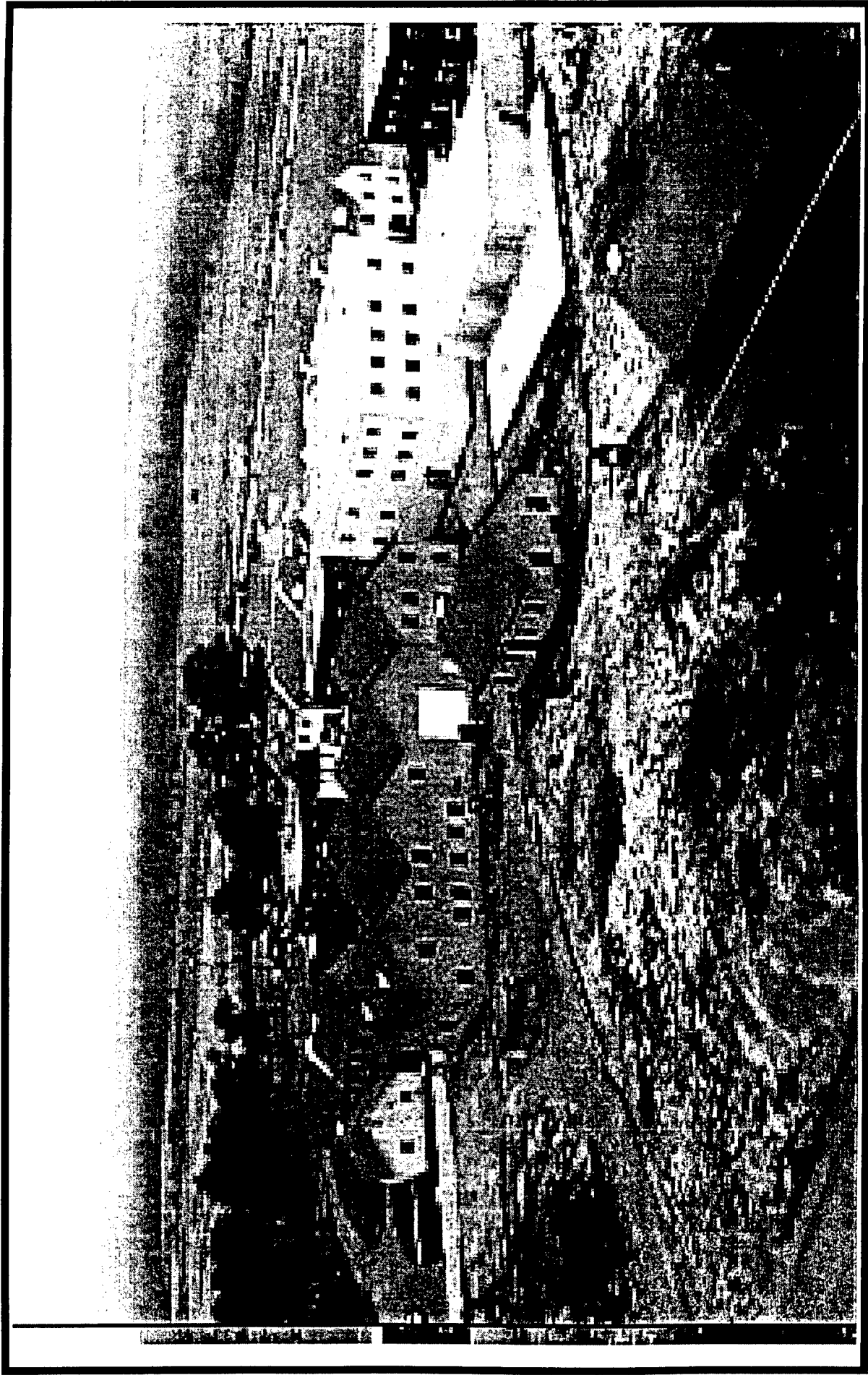

2/8/01

WHERE TOMORROW'S VICTORIES BEGIN



Range

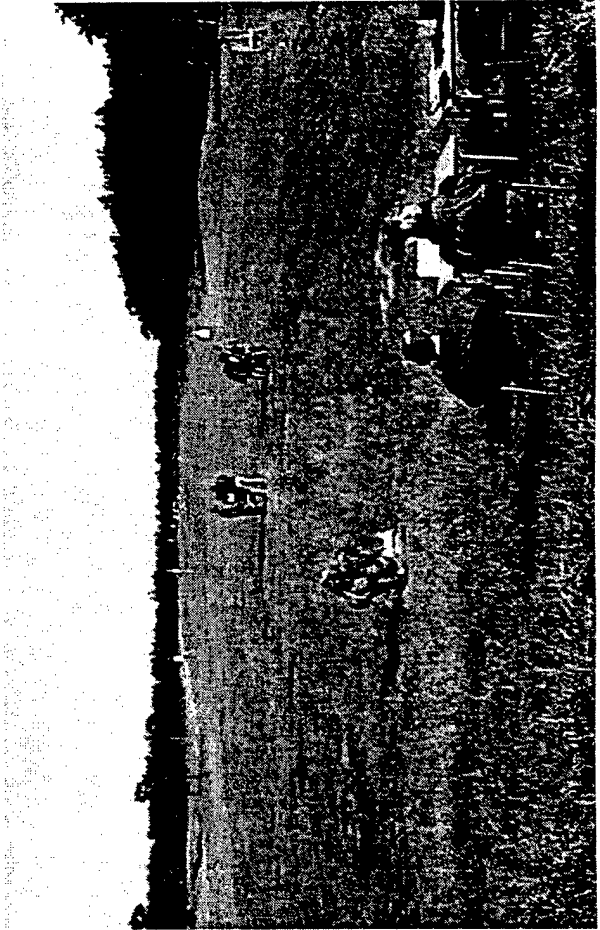
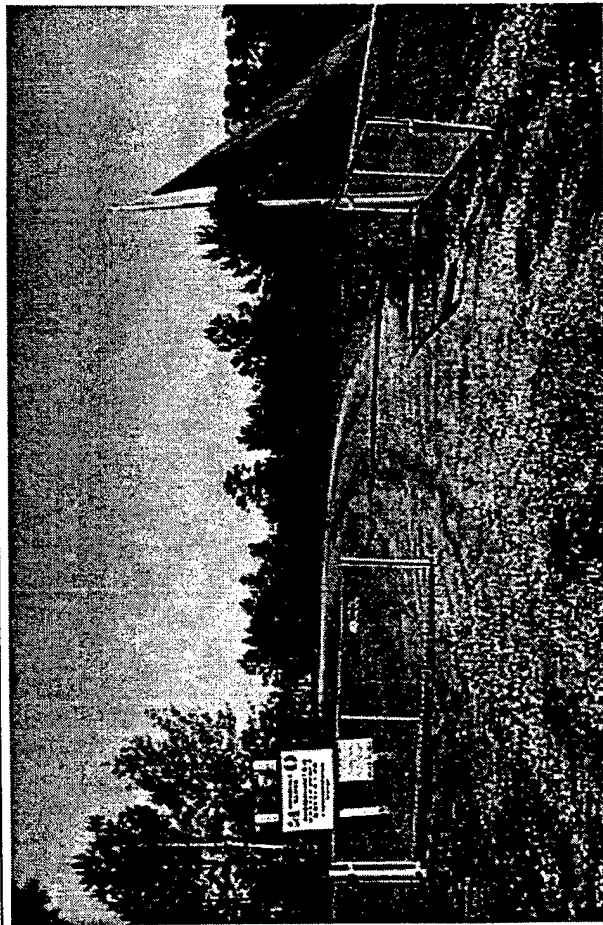



Kuige

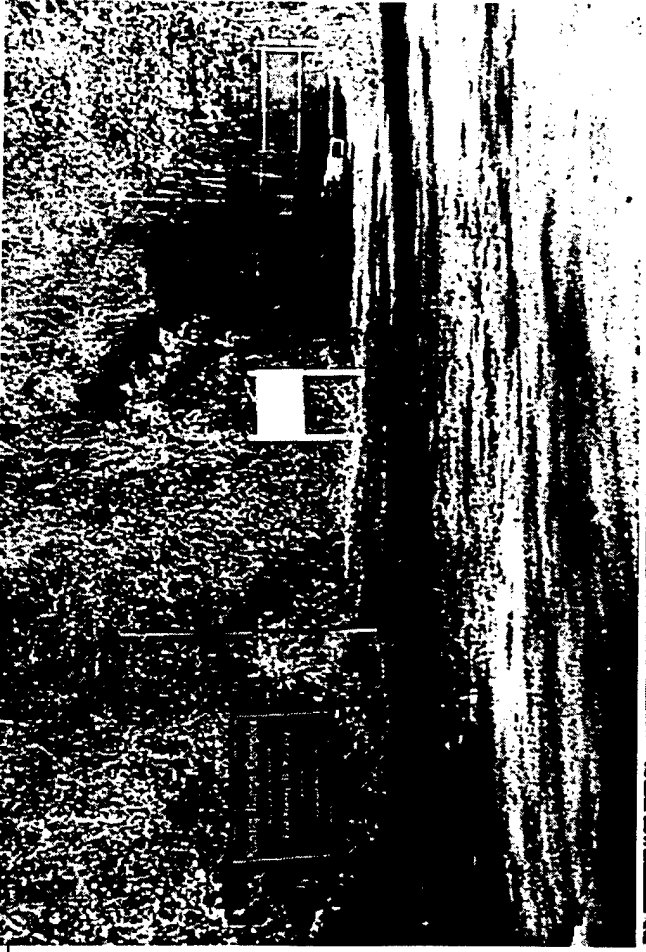
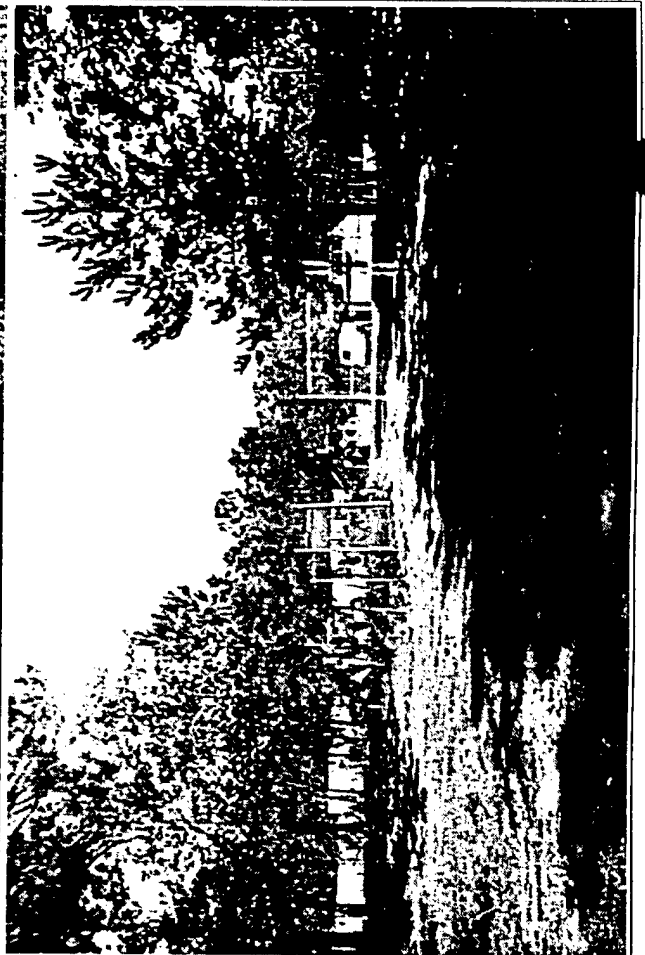



- **Own-the-Night experiments**
 - Thermal weapon sight evaluation Light, Medium and Heavy
 - Support the Enhanced Night Vision Goggle (ENVG) program
 - Supporting efforts for dismounted I2 and Thermal Fusion
- **Combat Identification and training system prototypes**
 - Man worn ground to ground
 - AC130H to ground
- **Weapon and Weapons Concepts Experimentation**
 - Multi-Role Anti-Armor Anti-Personnel Weapons System (MAAWS)
 - Under Barrel Shotgun
 - Future Sniper weapon concept exploration
- **Preparation for experimentation of Sympathetic Detonation program**
- **Field evaluation of new battery technology**
- **Proponent support to White Feather and Inertial Sight Reticle program**
- **Hosted SOF WEB experiment for Smart Sensor Web**
- **Training support to 75th Ranger Regiment, selected ODAs from 5th and 7th SF Group and Navy SEALs**



Sponsor Web

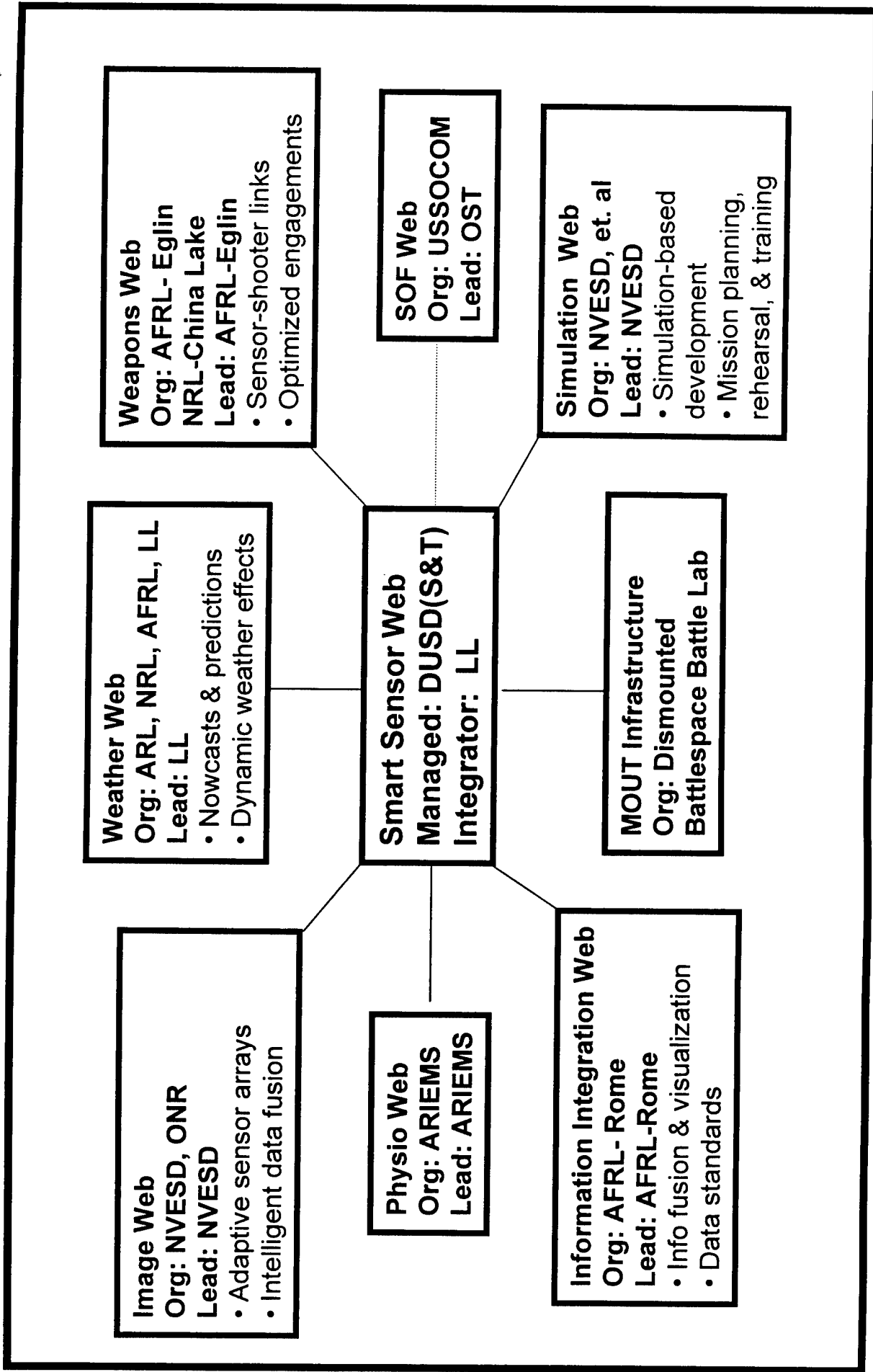

Image Web
Org: NVESD, ONR
Lead: NVESD
• Adaptive sensor arrays
• Intelligent data fusion

Weather Web
Org: ARL, NRL, AFRL, LL
Lead: LL
• Nowcasts & predictions
• Dynamic weather effects

Weapons Web
Org: AFRL-Eglin
NRL-China Lake
Lead: AFRL-Eglin
• Sensor-shooter links
• Optimized engagements

Physio Web
Org: ARIEMS
Lead: ARIEMS

Information Integration Web
Org: AFRL-Rome
Lead: AFRL-Rome
• Info fusion & visualization
• Data standards

Smart Sensor Web
Managed: DUSD(S&T)
Integrator: LL

SOF Web
Org: USSOCOM
Lead: OST

Simulation Web
Org: NVESD, et. al
Lead: NVESD
• Simulation-based development
• Mission planning, rehearsal, & training

MOUT Infrastructure
Org: Dismounted
Battlespace Battle Lab



- Multi-Role Anti-Armor Anti-Personnel Weapons System (MAAWS) Area Deterrent Munitions (ADM)
- Conducted a User evaluation of the MAAWS ADM munition for SOCOM
- Determine the effectiveness and suitability of the ADM
- Support a type-classification standard and materiel release decision.
- Determine probability of hit at 50 and 100 meters during daylight and limited visibility and in Mission Oriented Protective Posture (MOPP) Levels 0 and 4



TACTICAL UNMANNED AERIAL VEHICLE (TUAV)

RECONNAISSANCE SUPPORT TO

SMALL SCALE CONTINGENCIES (SSC)

AIR FORCE BATTLELAB KENNY CLASS INITIATIVE (Maj Steve Bishop)

HEADQUARTERS AIR FORCE SPECIAL OPERATIONS COMMAND

Lt Col Janice Morrow

TSgt Christopher Crutchfield

UNCLASSIFIED - APPROVED FOR PUBLIC RELEASE - 53WG-37106-99

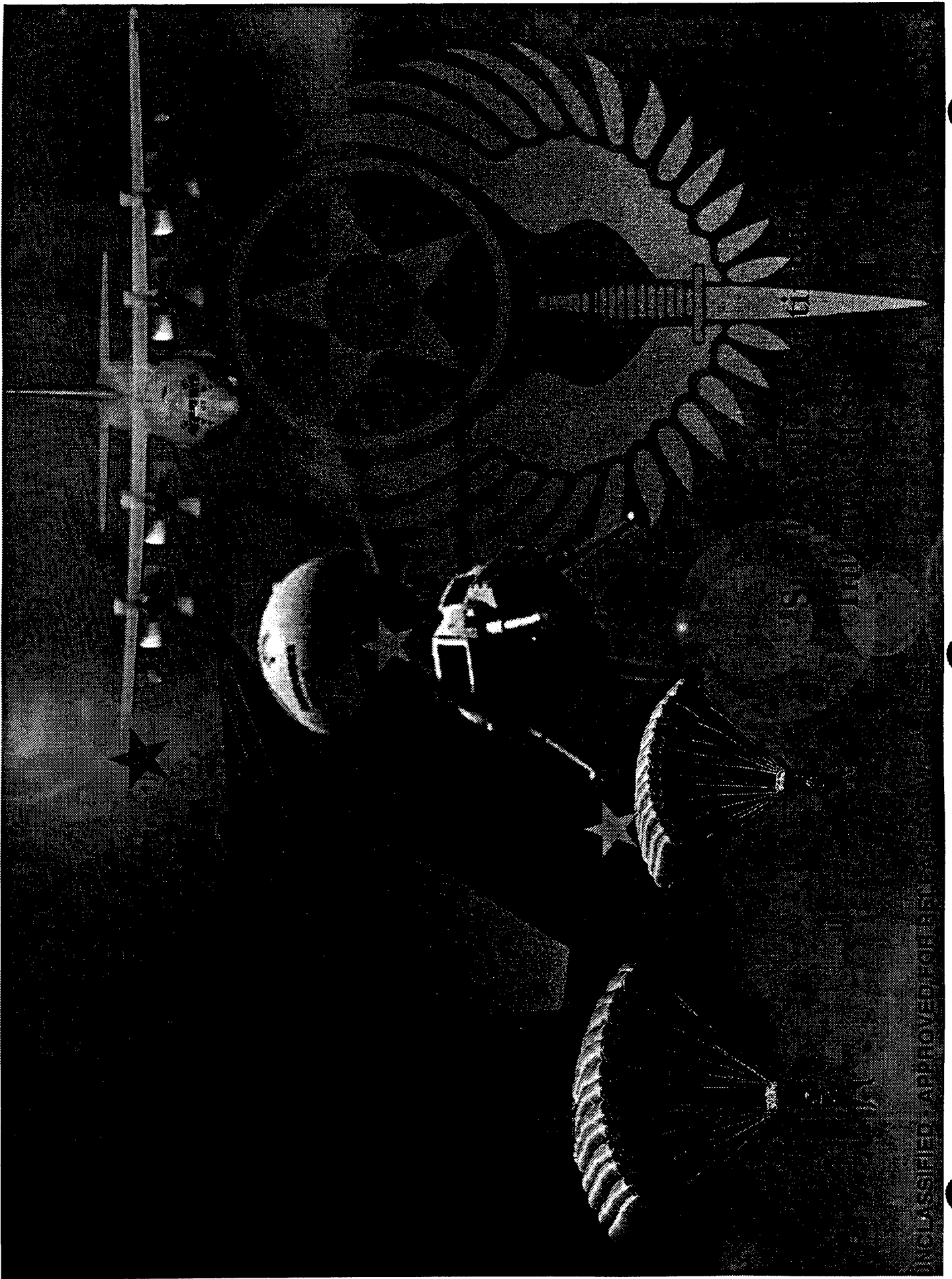

UNCLASSIFIED//APPROVED//FOUR EYES ONLY



BACKGROUND



- Demonstrated shortfalls in several theaters
- NEOs
 - Liberia, CAR, Congo, Albania, Haiti
- HUMROS
 - Rwanda, Burundi, Congo, Zaire,
- Poor tactical reconnaissance coverage
- Need for a small footprint and transportable vehicle
- Request from EUCOM to look at problem

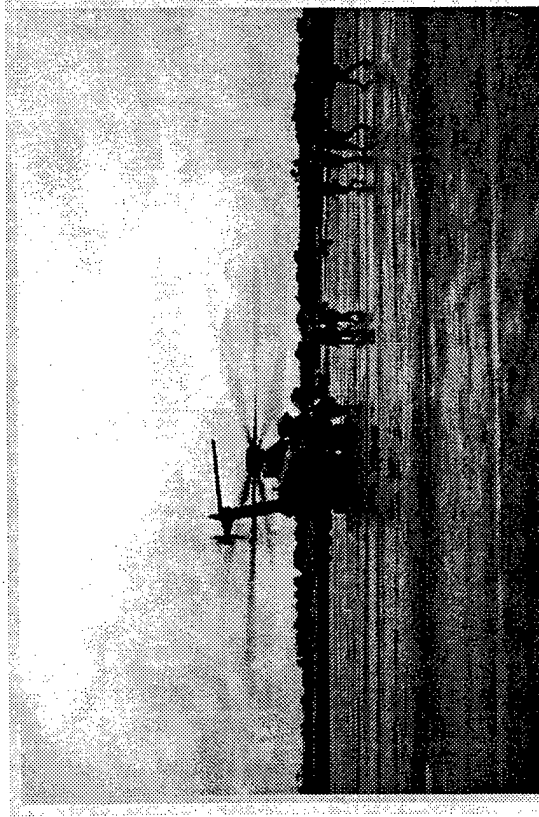

Special Forces Loading at Libreville, Gabon



PLAYERS



- UAV Battlelab, ISR Division
- HQ AFSOC/XPPD
- 18th FLTS
- 720 Special Tactics Group
- 23 Special Tactics Squadron
- Eglin AFB Special Projects/Contracting
- Bombardier Aerospace, U.S.A.
- L3 Communications
- FLIR Systems

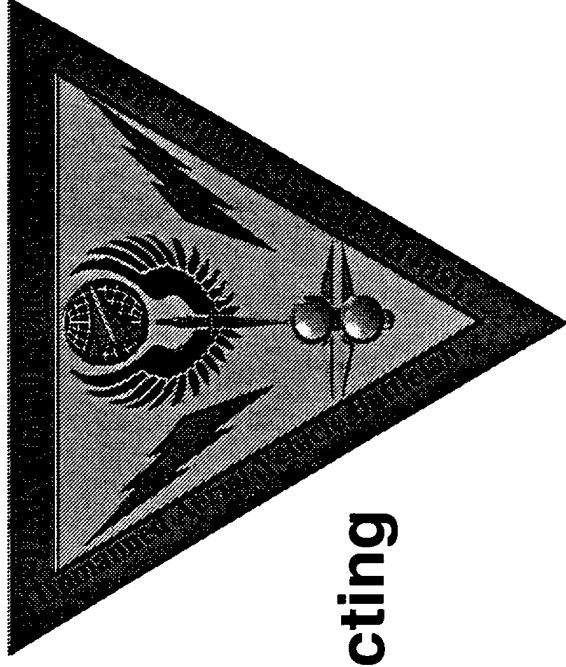

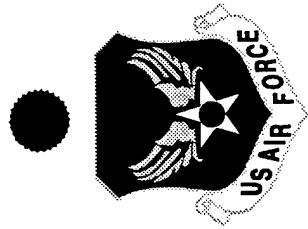

CL-327 GUARDIAN

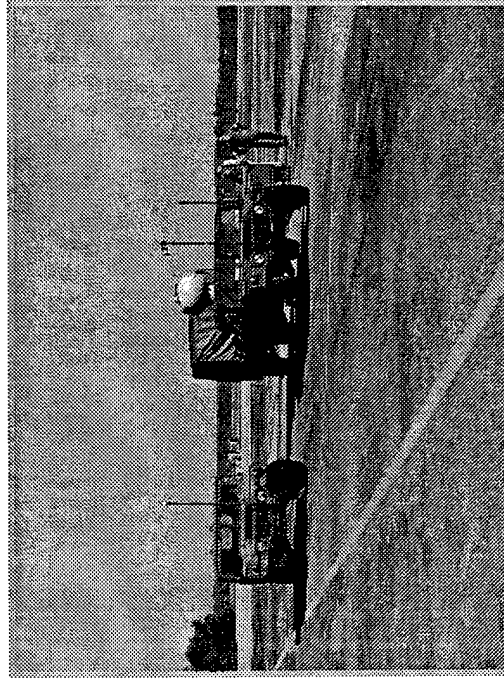
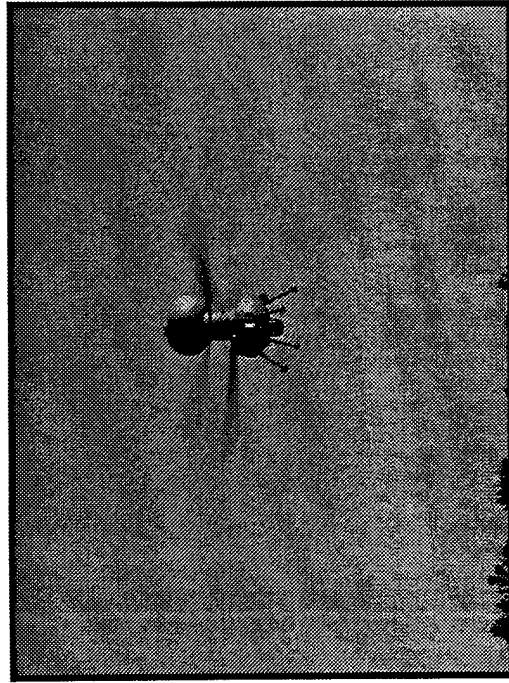
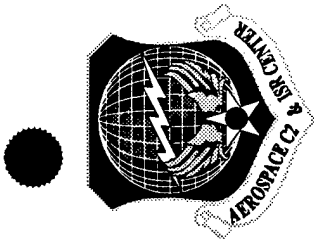

- **Endurance**
 - ▶▶▶▶ 6.25 hours
 - ▶▶▶▶ Range 100km
- **Size:**
 - ▶▶▶▶ 770 lbs
 - ▶▶▶▶ 13.1 feet rotor diameter
 - ▶▶▶▶ 6 feet in height
- **Payload**
 - ▶▶▶▶ EO/IR
 - ▶▶▶▶ 220 lbs
- **Speed**
 - ▶▶▶▶ Hover to 85kts dash



MISSION STATEMENT



Demonstrate the military worth of using a Tactical UAV (TUAV) to pass real-time video directly to AF Special Operations air and ground units in simulated Small Scale Contingency (SSC) environment.

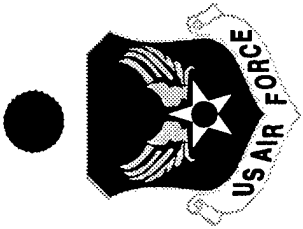

OBJECTIVES



- **Assess VTOL UAVs overall operational suitability to support SOF missions by passing real-time video to mobile AFSOC STS, Joint Survey and Assessment Teams**
- **Assess VTOL UAVs overall operational suitability to support SOF missions by passing real-time video to airborne AC-130 gunship orbiting 20 NM from UAV**



METHODOLOGY



- **Determine UAV ability to pass real-time video to STS teams in the field**
- **Rate usability of video information provided to STS teams.**
- **Determine UAV ability to pass real-time video to AC-130H aircraft**
- **Rate usability of video information provided to AC-130H aircrews**
- **Determine ability to transport UAV and associated equipment on C-130**



3. UAV simultaneously passes Video to ground units and they adjust mission accordingly based on situation



2. UAV Passes Video to AC-130H monitoring situation 20 NM out of harms way

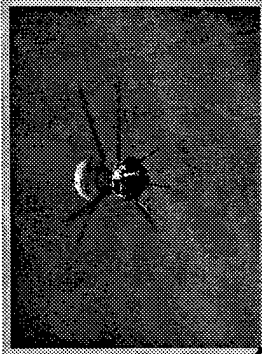
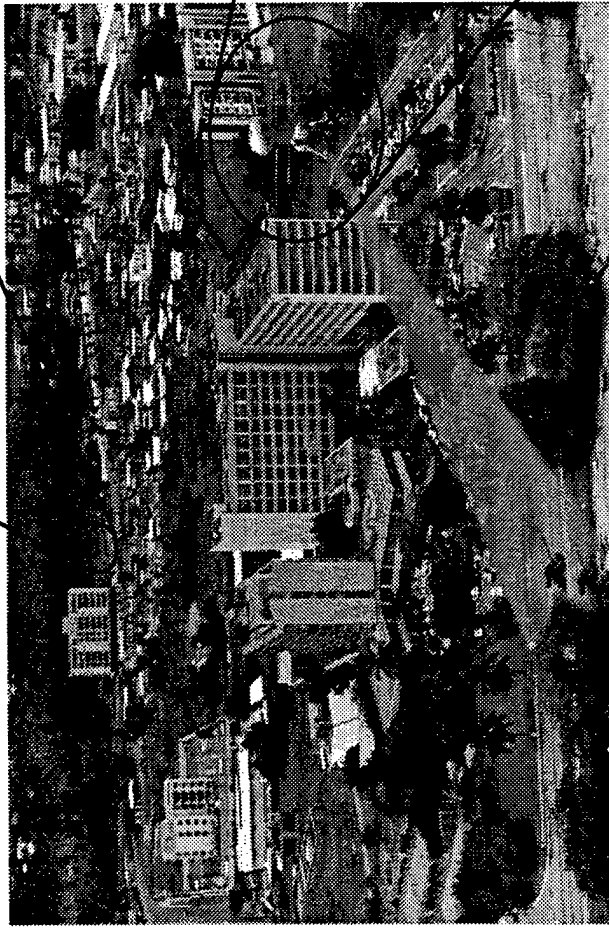

1. UAV on station and gathers Video on the situation prior to mission execution

Non Combatant Evacuation Scenario Humanitarian Relief Operation Scenario



SSC DEMONSTRATION NEO SCENARIO

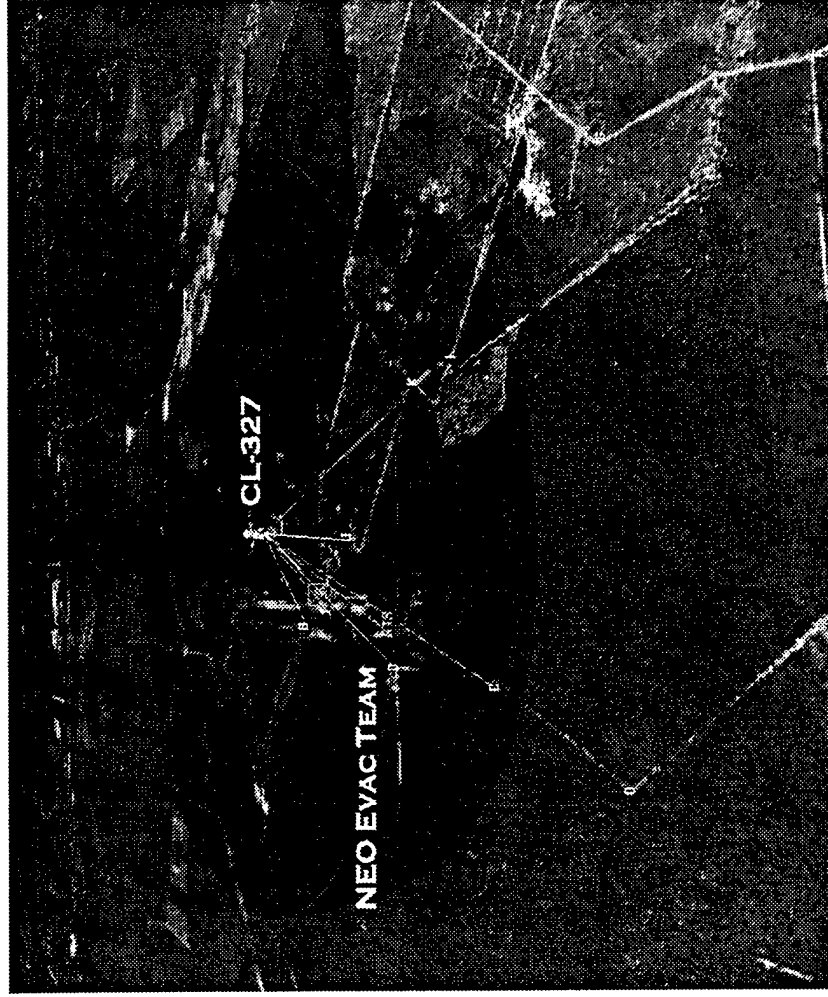

- Use UAV to
 - ▶▶▶ Pass real-time video to AC-130H
 - ▶▶▶ Assist STS team in avoidance of threat
 - ▶▶▶ Assist STS Team in prosecution of hostile targets in conjunction with AC-130H
 - ▶▶▶ Determine best evacuation route



SSC DEMONSTRATION HUMIRO SCENARIO



- Use UAV to

- ▶▶▶ Pass real-time video to AC-130H
- ▶▶▶ Assist STS team in avoidance of threat
- ▶▶▶ Assist STS Team in prosecution of hostile targets in conjunction with AC-130H
- ▶▶▶ Determine best evacuation route
- ▶▶▶ Identify location of simulated Refugee Camps
- ▶▶▶ Determine if camps are occupied and locate migration of refugees

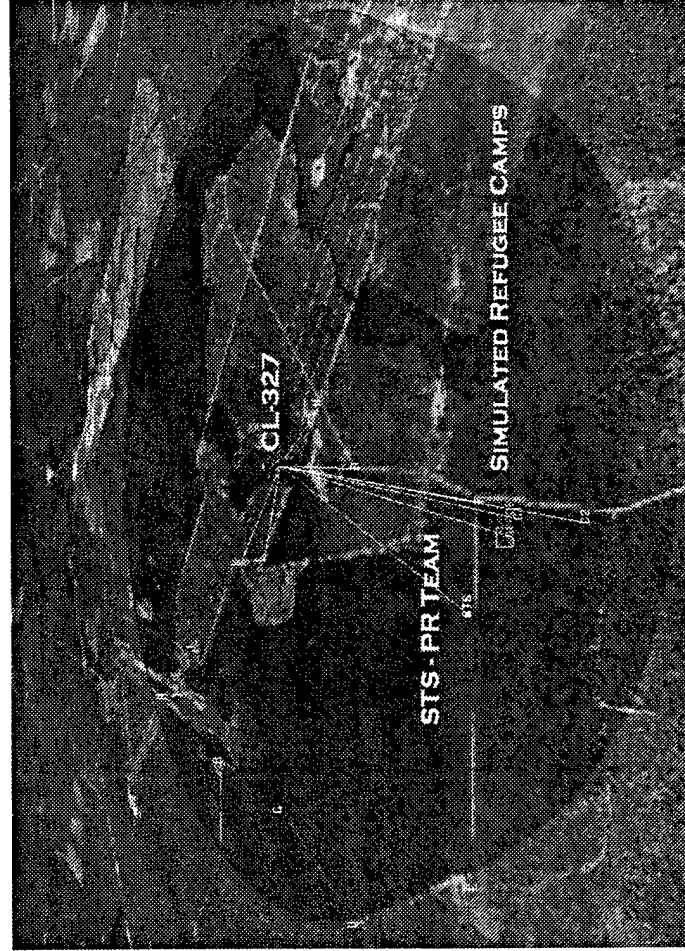



RESULTS



Technical:

- UAV Video to AC-130.....
- UAV Video to AC-130 - 20 NM.....
- UAV Video to STS

Scenarios:

- NEO Scenario.....
- HUMRO Scenario.....
- Deployability.....

Success Partial Success Unsuccessful



CONCLUSIONS



- **UAVB/18th FLTS proved the military utility and concept that a VTOL UAVs can enhance situational awareness**
- **Use of UAV and supporting equipment would be effective in improving SOF mission capability**
- **VTOL UAVs show potential to support theater CINCs in an SSC environment**



RECOMMENDATIONS



- **Integrate UAVs to support unique SOF requirements.**
- **Refine and formalize requirements and conops for UAVs supporting SOF missions.**
- **Pursue acquisition of a capability to receiving real-time video from existing UAVs directly to AF SOF air and ground forces as well as to Security Forces.**

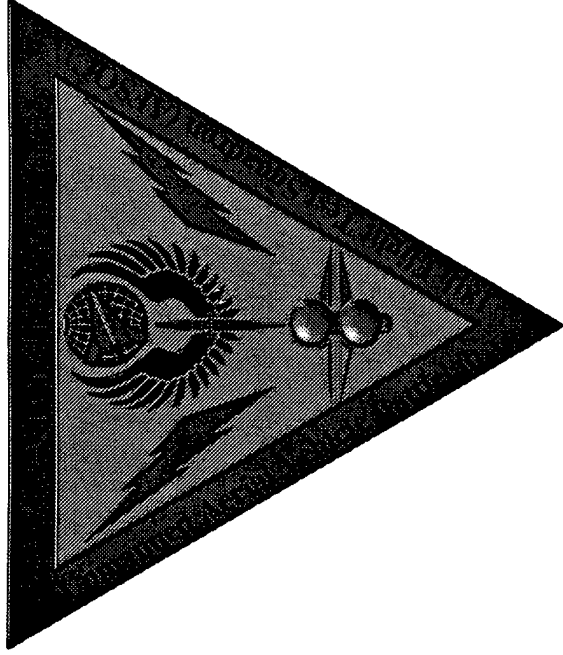
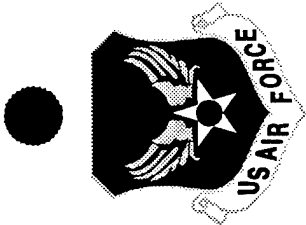

QUESTIONS ?

Maj Steve Bishop, Program Manager: UA VVB/DOI

Unmanned Aerial Vehicle Battlelab

1003 Nomad Way Suite 107

Eglin AFB, Florida - U.S.A 32536-6867

stephen.bishop@eglin.af.mil

Lt Col Janice Morrow: HQ AFSOC/XPPX

janice.morrow@hurlburt.af.mil

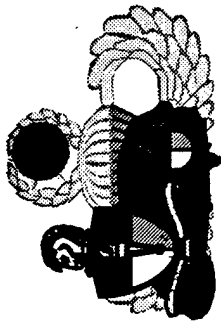

USAJFKSWCS

ARMY SPECIAL OPERATIONS BATTLE LAB



USASOC

ARMY SPECIAL OPERATIONS FORCES

DIGITAL

COMMAND AND CONTROL

CHALLENGES

Dr. Basehart, baseharj@soc.mil
DSN 239-1845, (910) 432-1845
Commander

U.S. Army John F. Kennedy Special
Warfare Center and School

ATTN: AOJK-BL

Fort Bragg, NC 28310

14 February 2001



AGENDA

USASOC

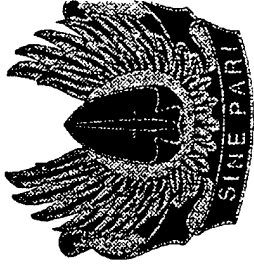

- Army Special Operations Battle Lab Mission
- Joint and Service Digital C2
- Army Special Operations Digital C2 Emerging Environment
- Strategy to Address Challenges
- DARPA Active Templates Technology



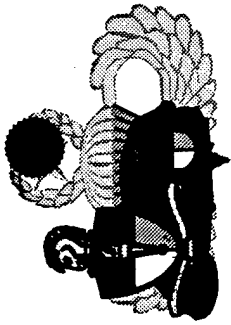

USAJFKSWCS

ARMY SPECIAL OPERATIONS BATTLE LAB MISSION



USASOC

As the architect of the future, the Battle Lab develops concepts for post POM ARSOF, conducts experiments, and assesses and operates digital C2 and simulation systems to ensure ARSOF remain relevant, dominant and capable of Advanced Full Spectrum Operations.

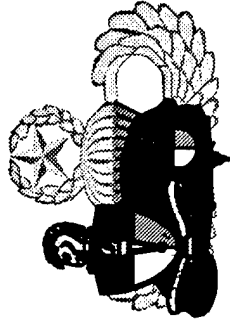

USAJFKSWCS

MAJOR FUNCTIONS



USASOC

- Future visions, concepts of operation, Objective Force Capabilities, and operational and organizational concepts for post POM ARSOF
- Experiment, determine insights for DTLOMS changes, document requirements for MAA
- Assess digital C2 systems, identify those useful to ground ARSOF
- Spiral development of emerging digital C2 and simulation systems
- Support school and units with digital C2 and simulation systems



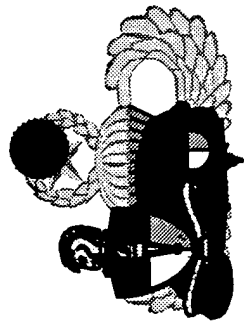

USAJFKSWCS

ARMY SPECIAL OPERATIONS BATTLE LAB

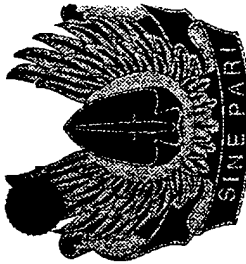

USASOC

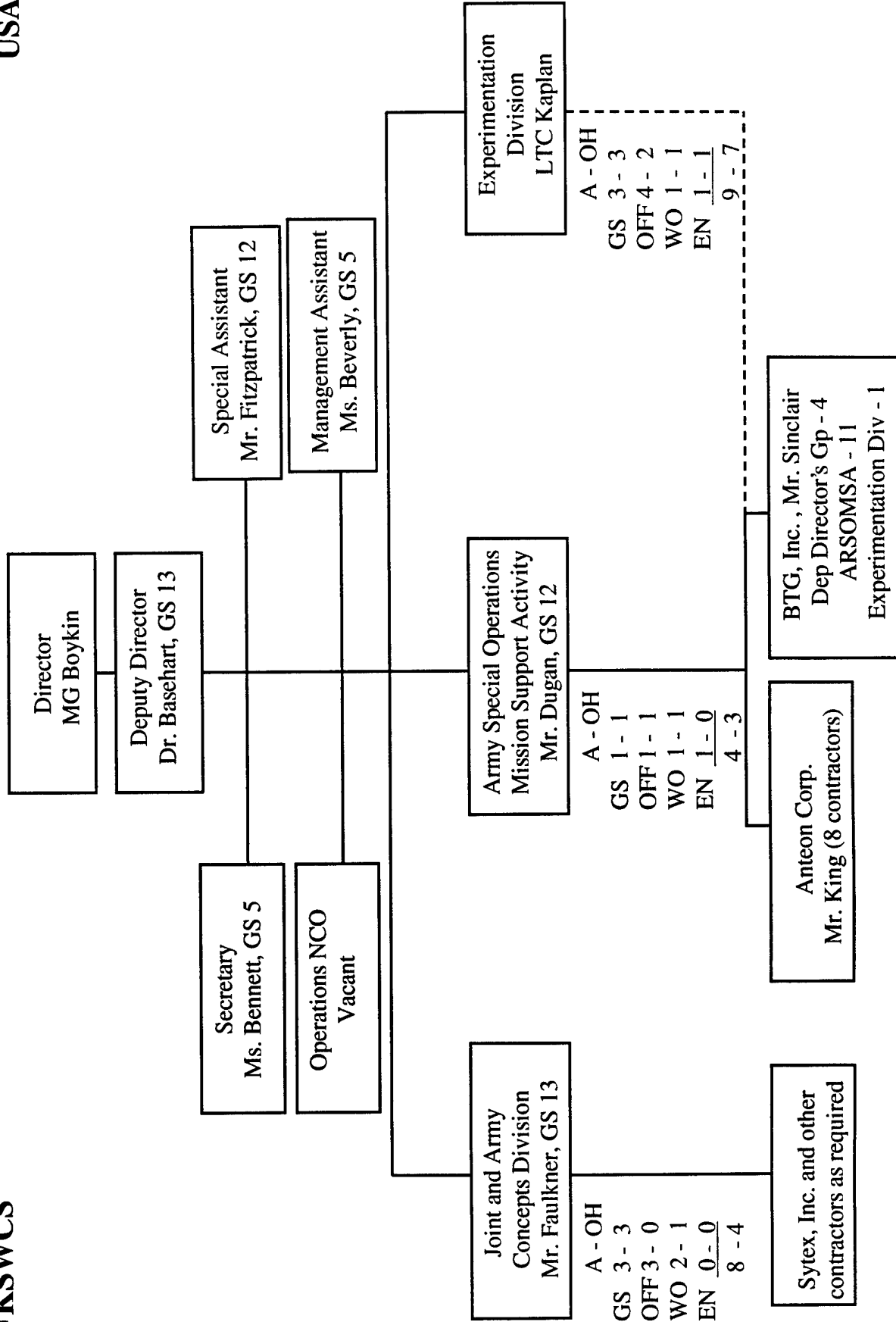

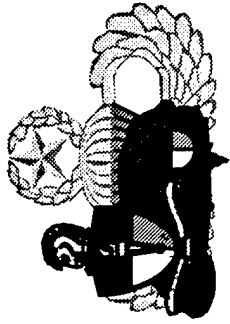

USAJFKSWCS

CURRENT AND EMERGING JOINT AND SERVICE SYSTEMS

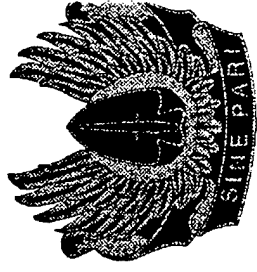

USASOC

C2 SYSTEMS

Global Command and Control System	DISA	Fielded
Army Battle Command System	USA	Developmental
Theater Battle Management Core Systems	USAF	Fielding
Global Command and Control System--Maritime	USN	Fielded
Tactical Combat Operations System	USMC	Fielded

MAPPING TOOLS

Joint Mapping Tool Kit (JMTK)	DISA	Fielded
Joint Mapping Tool Kit--NT	DISA	Fielding
C2 Personal Computer (C2PC)	DISA	Fielded
Commercial JMTK (CJMTK)	DISA	Contracting
Falcon View	SOFPARS	Fielded



USASOC

JOINT AND SERVICE DIGITAL C2 ARCHITECTURE

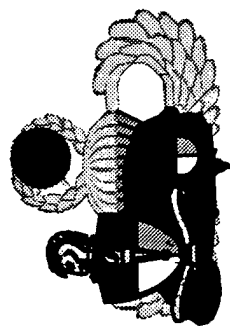
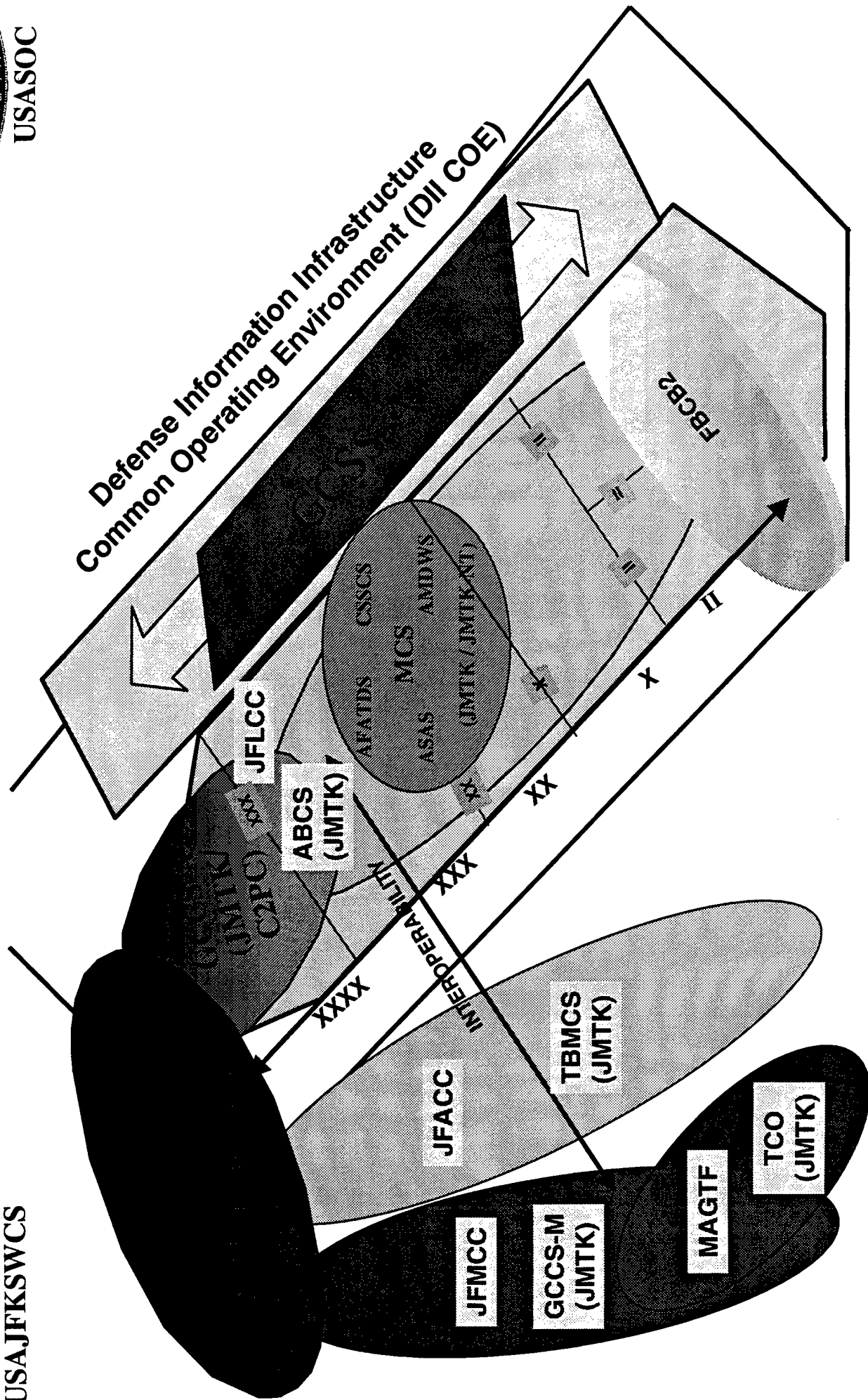

USAFJFKSWCS

ARMY BATTLE COMMAND SYSTEM 6.2

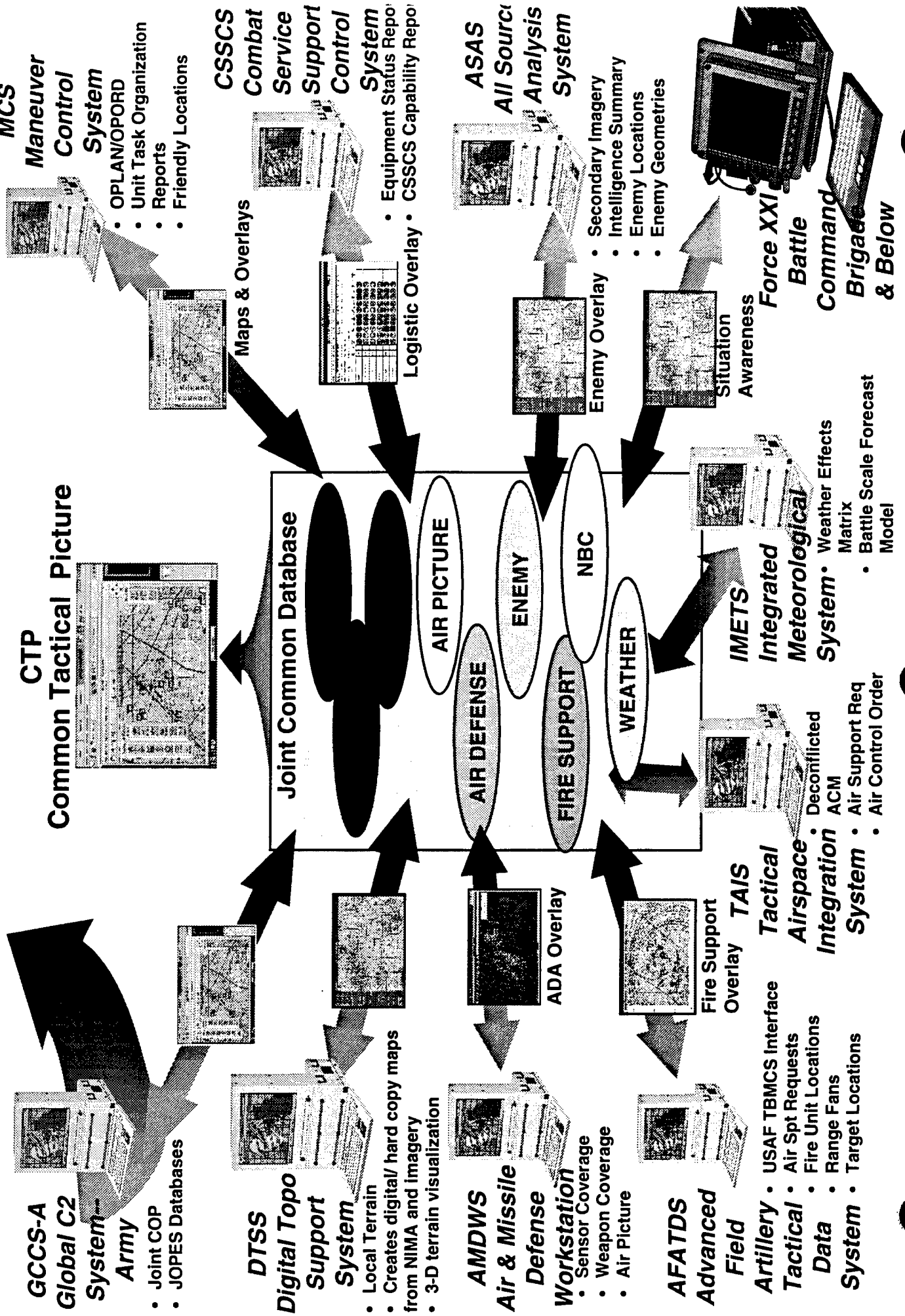

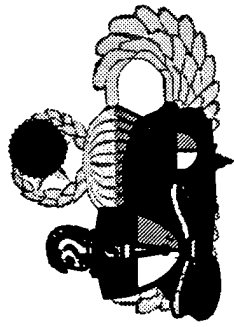

USAJFKSWCS

JOINT SPECIAL OPERATIONS EMERGING DIGITAL ENVIRONMENT



USASOC

Global Command and Control System	DISA	Fielded	USASOC
Army Battle Command System	USA	Developmental	
Theater Battle Management Core Systems	USAF	Fielding	
Special Warfare Automated Mission Planning System	NSWC	Fielded	
JDISS-SOCRATES	USSOCOM	Fielded	
Joint Tactical Terminal			
Global Broadcast System		Fielding	
SOF Tactical Assured Connectivity System	USSOCOM	Developmental	
Tactical LAN	USSOCOM	Developmental	
Joint Base Station with Outstation	USSOCOM	Fielding	
JSOTF Tools	USSOCOM	Developmental	
SOFPARS Air--Portable Flight Planning System	USSOCOM	Fielded	
SOFPARS Ground	USSOCOM	Developmental	
Multi-Mission Advanced Tactical Terminal		Fielding	
Secure Enroute Communication Package--Improved	USSOCOM	Developmental	
SPEAR / Land Warrior	USSOCOM	Developmental	
Special Operations Tactical Video System	USSOCOM	Developmental	
Lightweight Video Reconnaissance System	USA	Fielded	
Advanced SO Planning & Rehearsal Parachute Simulation	USSOCOM	Developmental	



USASOC

JOINT SPECIAL OPERATIONS FORCES DIGITAL C2 ARCHITECTURE

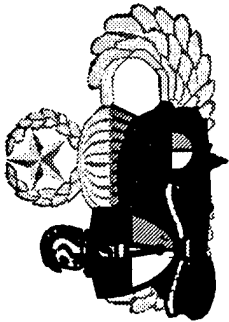

USAFJFKSWCS

Except SOC Korea
uses GCCS-K
(GCCS-A)

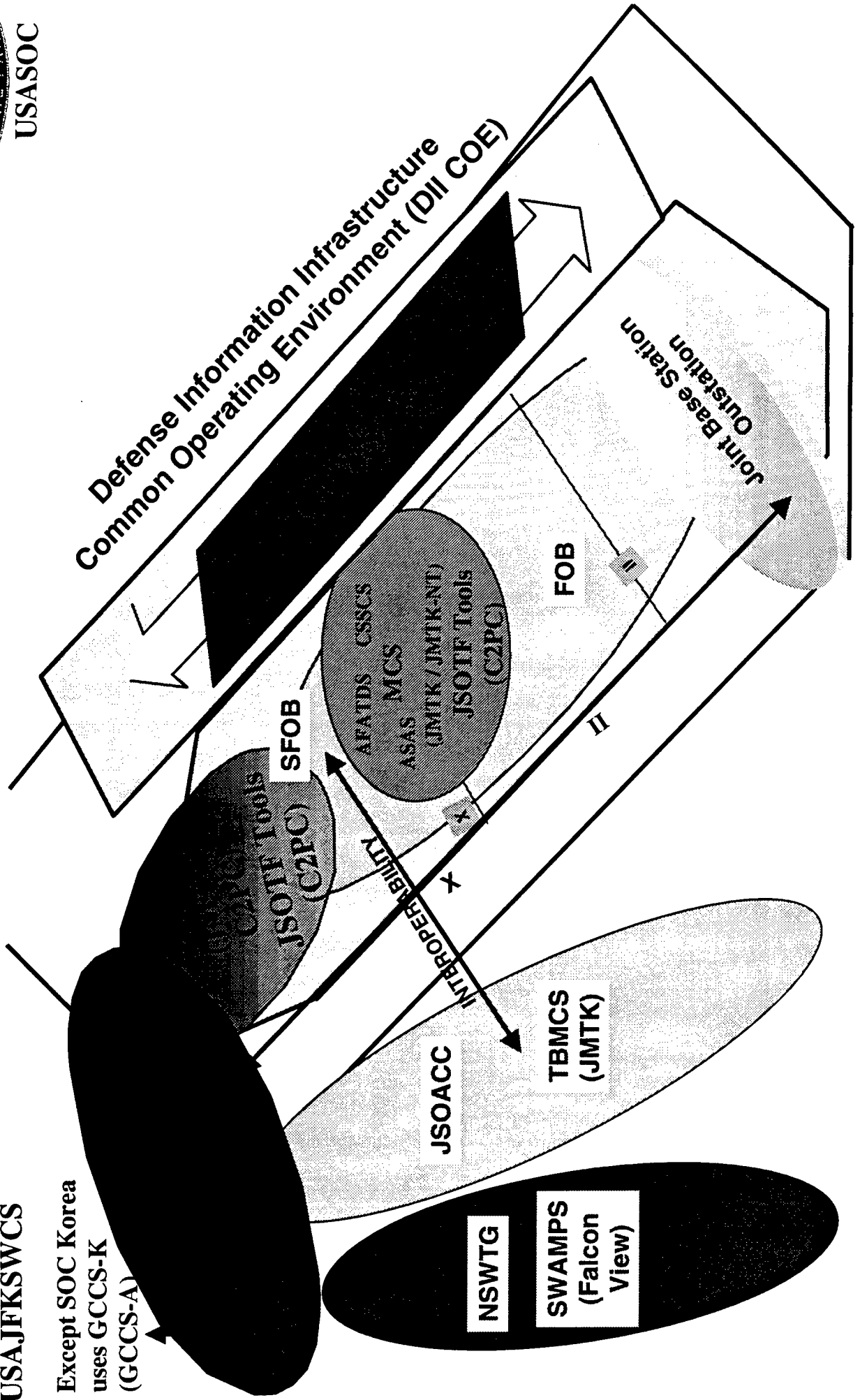

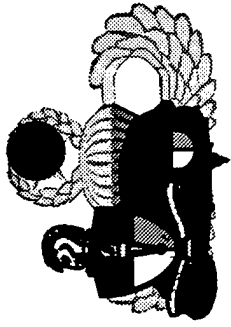

USAJFKSWCS

STRATEGY TO ADDRESS ARSOF DIGITAL C2 CHALLENGES



USASOC

- Identify ABCS functions useful to ARSOF
 - Robust ARSOF BOIP
 - Ensures interoperability with conventional Army
 - Leverages Army developed Joint and other Service interoperability
- Examine current / emerging DOD and SOF systems
 - Defense Information Systems Agency--Global C2 System
 - JSOC
 - SOAL, USSOCOM--JSOTF Tools, etc.
 - SOFPARS for detachment route planning, MDMP, etc.
 - Joint Base Station, etc.
- Develop concept / demonstrate efficient use of appropriate systems
- Digital C2 ICT/RIPT document requirements and interoperability voids
- Leverage DARPA Active Templates technology and other Programs

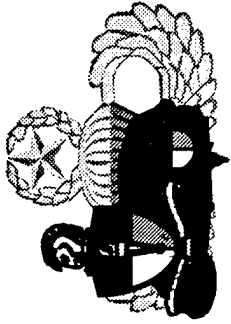

USAJFKSWCS

ACTIVE TEMPLATES TECHNOLOGY



USASOC

- Concept
- Joint Special Operations Task Force Tools
 - Synchronization Matrix
 - Checklist





DIGITAL C2 ASSESSMENT EVENTS



- 23 Apr - 8 Jun 01 Unified Vision (USJFCOM)
- 14-18 May 01 Prairie Warrior
- 15-19 Oct 01 Division Capstone Exercise, Phase 2
- 6-13 May 02 Prairie Warrior
- 18 Jul-9 Aug 02 Millennium Challenge (USJFCOM)
- 11-19 Dec 02 Corps Advanced Warfighting Experiment
- TBD Initial Brigade Combat Team JRTC

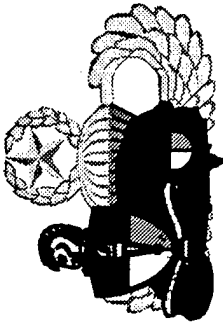

USAJFKSWCS

**ARMY SPECIAL OPERATIONS
BATTLE LAB**



USASOC

DISCUSSION



AFSOC
Communications and Information (C&I)
Campaign Plan



Communications and Information
Directorate
February 2001

Purpose:

The Communications and Information (C&I) Campaign Plan is the overarching mission, vision, and practical plan of action for the HQ AFSOC/SC staff. It encompasses key AFSOC policies and processes as well as DoD, USAF, and USSOCOM guidance for C&I support. It sets the overall Information Technology (IT) roadmap and priorities for all AFSOC C&I professionals. This plan replaces the HQ AFSOC/SC 500-day plan, but incorporates many of the issues and facets found in the 500-day plan.

AF IT Summit:

The Air Force senior leadership held an off-site in July 2000 to review and assess the management of IT. This "IT Summit" has led to significant changes in direction for AF IT managers. Most notably, the move toward a web-based portal for all AF IT services has accelerated. Also, there is a great emphasis on centralizing and optimizing IT systems, leading to the motto, "One Air Force, One Network." The essence of these initiatives is outlined in the ConOps for the Air Force Information Enterprise¹ (see references below).

Staff Priorities:

Perhaps the most common question on the staff involves priorities. Based on current command emphasis, here are the staff priorities:

- Current Operations. Combat unit readiness, equipment enhancements, UTC refinement, and integration of reserve component units, training, and situational awareness.
- Robust Infrastructure. Enhancements to SIPRNET and SCAMPI connectivity for garrison and deployed SOF personnel. Improved performance monitoring, increased throughput, and updated servers, workstations, and information transfer nodes.
- Improved Business Practices. Rapid migration to web-enabled applications; ease of use; customer advocacy. Refine the SC organization to accommodate these changes where necessary; emphasize electronic-business practices and achieve full compliance with SIE/CIO management directives.

Policies and Guidance:

This document is focused on HQ AFSOC, but the guidance herein is useful to all AFSOC communications and information professionals. In addition, the vision and guidance contained in the following documents were instrumental in developing the plan:

- ConOps for Air Force Information Enterprise (draft)
- Air Force IT Master Plan
- USSOCOM SIE Master Plan
- Joint Vision 2020
- AFSOC CIO Charter
- USSOCOM DIRECTIVE 25-1, as of 26 Oct 00, Information Technology Management for the Special Operations Forces Information Enterprise.
- SOF Information Enterprise (SIE) Capstone Requirements Document (CRD) Version 2.1, Dated 14 Sep 00

Air Force Information Enterprise Definition: From the CONOPS for the Air Force Information Enterprise:

- The aggregate of people, systems, resources, and processes that provide the information availability and assurance to enable Air Force core missions. It is not constrained by time or operating location, but assures access to the information required for decision-making and mission accomplishment.²

SOF Information Enterprise (SIE) Definition:

- SIE is defined as: "The information technology infrastructure, applications, policies, processes, people, and knowledge that is required to prepare for and conduct special operations across the spectrum of military operations from daily staff functions to war. (SIE TF)³

With this background, HQ AFSOC/SC defines its mission and vision below:

Mission

Provide combat ready C&I warriors and a C&I infrastructure to execute SOF war planning, command and control, and combat operations worldwide.

Vision

Assure information dominance for America's specialized airpower by providing the most capable and rapidly deployable SOF Information Enterprise--across the conflict spectrum, anywhere, anytime.

Challenges

We've found that there are several trends or challenges that define the operating environment for AFSOC. They shape our IT support and therefore are defined here:

Rapid Technological Change:

Phenomenal advances in emerging information systems technology add enormously to the complexities of C&I system management. AFSOC's Communications and Information acquisitions are often driven by near-term demands for new technologies and AF or USSOCOM-sponsored programs rather than the needs of the customers it serves. Additionally, customers are more educated and better equipped to find their own IT solutions. This leaves IT professionals with the added task of "getting inside the IT decision loops" of our customers.

Emerging and Changing Requirements:

Customer IT needs can change before systems are fielded to satisfy the initial requirement. Additionally, particularly demanding customers can "rapid fire" requirements to the communications and information staff, making prioritization difficult. In the SOF environment, this change is characteristic of the innovative and "out of the box" thinking of SOF warriors. IT professionals must therefore understand the environment and the changing nature of SOF IT requirements.

Joint and Service-specific Systems Fielding:

AFSOC is postured as a bridge between USSOCOM (and its sister components) and USAF and its related field activities. There are often conflicting policies and priorities with a resulting confusion in guidance for the staff and its customers. In this sense, AFSOC must run interference between the two organizations, providing systems integration, funding strategies, and policy deconfliction.

Limited Staff Resources:

The HQ AFSOC/SC staff is small, totaling only 42 government personnel and 12 contractor personnel. Handling the myriad challenges, taskings and needs can be a difficult task. This calls for innovative thinking, leveraging other organizations and their capabilities, and a highly cooperative work effort.

Global Mission:

AFSOC supports missions across the entire spectrum of conflict in all parts of the globe. This presents unique challenges, especially for rapid deployment with limited airlift capacity, yet demanding robust C&I connectivity and capability.

Seamless C&I Infrastructure:

AFSOC-fixed and deployed units must have access to the full range of DoD and SOF-specific C&I capabilities. This access should be seamless, free of special interfaces, translations, or other encumbrances to interoperability. Our seamless infrastructure must encompass fixed ground-based, airborne, and deployed IT systems.

The C&I Environment can therefore be depicted as an "iceberg," containing both the visible systems and services we provide, but considering the challenges above and the "hidden" infrastructure which underpins these services and systems:

The C&I Iceberg

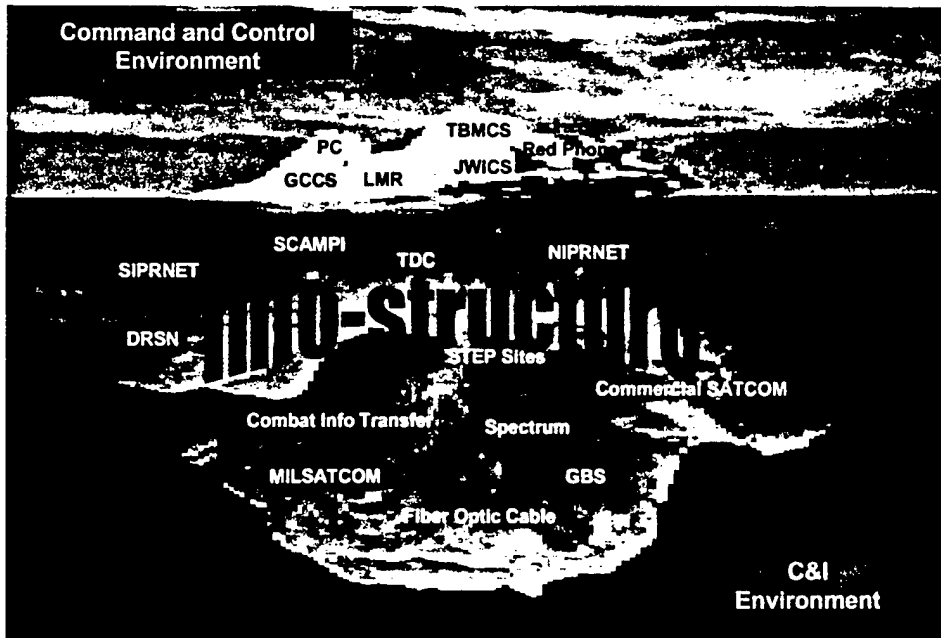

Core Capabilities

In consideration of the above challenges, we must achieve the following core capabilities. Each capability also drives objectives and eventually tasks to reach an action plan—our action road map for the coming months and years. These capabilities are:

Robust Infrastructure: Responsive C4 infrastructure must transport, manage, and ensure information flow between garrison installations, metropolitan areas, and forward-deployed units. This agile employment strategy employs state-of-the-art information assurance capabilities with the latest, most modern technology, to yield extremely high readiness C4 systems.

Objective 1: Modernize Infrastructure.

Modernize the ground, airborne, and space information transport infrastructure to meet warfighter requirements.

Objective 2: Retire Legacy IT Systems.

Retire or replace nonstandard, noninteroperable, and obsolete legacy systems which do not enhance SOF warfighting capabilities.

Objective 3: Move and Process Information.

Providing the right information at the right time, to the right place, and in a form that is useful to the user. This includes moving information regardless of transport medium, environment, or information type; and processing information from diverse information sources and databases, to include delivery, distribution, and format presentation.

Objective 4: Operate and Maintain Communications and Information Systems.

Operate and maintain communications and information systems efficiently, effectively, and securely.

Objective 5: Provide Information Assurance.

Provide Information Assurance (IA) to ensure information is protected and networks are available, operationally ready, and defended in-depth.

Common Grid: Our warfighters must have the same level and ease of service whether in garrison, airborne, or deployed to forward locations. Therefore, the AFSOC global grid must provide a seamless, network centric presence of the

larger DoD global information grid (GIG), but tailored to SOF missions and needs. This AFSOC global grid must be three dimensional, including surface, air, and space systems while using common interfaces to ensure ease of use and interoperability regardless of location.

Objective 6: Implement Global Information Grid (GIG).

Achieve seamless information sharing through implementation of the GIG architecture.

Objective 7: Seamless Information Access.

Achieve seamless access to all information/data so all information appears local to the user. Empower customers to access and manage their data through the latest smart web applications and access to SIPRNET resources.

Objective 8: Joint and Coalition Interoperability.

Provide IT capabilities that meet joint/coalition mission needs. Provide information technology solutions that enable AFSOC to operate better and cost less, through innovation, process reengineering, and modernization of systems. Participation in the SIE Enterprise Review Board (ERB) is an essential way to leverage and ensure joint IT solutions for SOF forces.

Objective 9: Optimize Frequency Spectrum Capability.

Ensure AFSOC forces have adequate access to necessary spectrum, while ensuring systems are designed and fielded with constrained spectrum in mind.

Responsive: Gone are the days when warfighters must attend specialized courses or learn complicated C4 interfaces to effectively complete their missions. Today's C4 systems must be developed and designed with customer buy-in and a full understanding of their warfighting usefulness. Procurement methods should be easy to understand and adaptable to the unique SOF environment. Finally, a clear roadmap should be available to show the way to future capabilities.

Objective 10: C&I Situational Awareness.

Provide commanders viable and useful status of their IT systems and personnel so they can make better decisions. Utilize common tools and procedures to achieve this objective, in concert with component and joint partners.

Objective 11: Apply evolutionary acquisition principles.

Clear up the tangle of requirements processing and streamline the customer's ability to rapidly acquire the IT they need. Provide a web-based, streamlined C4 requirements process designed to remove the "red tape" currently associated with C4 systems procurement or capability development. The SIE approved products list (APL) should be the lead technical reference and means to streamline the acquisition process.

Objective 12: Implement Enterprise Information Management (EIM).

Don't burden customers with unnecessary advisories or notices, but provide only necessary information to effectively manage their warfighting systems. Ensure needed information is at the warfighters fingertips—whenever or wherever the mission occurs.

Objective 13: Customer Advocates.

Establish "customer advocates" throughout the functional communities to assist and enhance the infusion of smart information technology to streamlined business practices. Capture IT requirements embedded in "non-IT" programs early in the development cycle.

Solid Business Practices: IT professionals owe the taxpayer the assurances that sound business analysis and practices drive investments. The USSOCOM SOF Information Enterprise (SIE) and AF IT Summit provide ample guidance to achieve these goals. Further, through a full understanding of AFSOC's mission area needs and joint mission analysis, a clear operational architecture and roadmap can be derived.

Objective 14: Solid Architectural Baseline.

Use operational architectures as a decision tool to evaluate process reengineering and material solutions for required capabilities. Use the AFSOC C2 Roadmap as the primary tool to achieve this objective.

Objective 15: IT Investment Strategy.

Manage AFSOC Information Technology Funding and Investment Strategy. Manage AFSOC IT funding to ensure we provide adequate information services to special operators, while optimizing scarce IT resources. Comply with DoD and Congressionally mandated direction in all AFSOC IT business practices. Use the AFSOC CIO council as the primary tool to achieve these goals.

Objective 16: Proactive Information Management.

Manage Information as a Critical Mission and Business Resource. Treat information as a strategic resource throughout its life cycle (from acquisition or

creation through disposition, including storage, retrieval, use, and distribution) to include information management policy, data standards and management, and information requirements that are based on reengineered Air Force and AFSOC core business processes.

21st Century Leadership: Leading and managing in this dynamic environment requires the development and grooming of SOF IT professionals. Twenty-first Century IT leaders must be highly competent in technical areas yet able to comprehend and apply technology to support warfighter needs. The ongoing nurture of a corps of IT leaders should take a high priority in all our endeavors.

Objective 17: Develop Communications and Information Professionals.

Manage AFSOC's Total Force to maintain the right force mix among military (active duty, Air National Guard, Reserve), and Department of Defense (DoD) civilian personnel.

Objective 18: Professional Forums.

Provide forums for information exchange amongst IT professionals in the local community and across the DoD.

Objective 19: Essential Education and Training.

Ensure adequate education and training opportunities are available to IT leaders as part of their ongoing professional development.

¹ CONOPS for the Air Force Information Enterprise, HQ USAF/SCM, Draft Version 14, 3 Jan 2001.

² Ibid, p5.

³ SOF Information Enterprise (SIE) Capstone Requirements Document (CRD) Version 2.1, dated 14 Sep 00, page 2

12th Annual SO/LIC Symposium, 14 Feb 2001
Seminar #4
"The Information Environment of SO/LIC"

AMERICA'S SPECIALIZED AIR POWER



ANY PLACE, ANY TIME, ANY WHERE

Col Mike DeHart
HQ AFSOC/SC
Director, Communications & Information



OVERVIEW

- C&I Campaign Plan
- Mission
- Organization
- AFSOF Information Enterprise
 - Fixed Info-structure
 - Deployed Info-structure
 - IT business processes

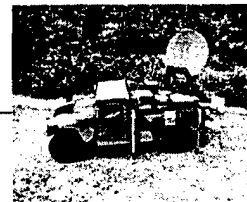



C&I Campaign Plan

- **Provides:**
 - **C&I Mission and Vision**
 - **Roadmap and priorities**
 - **Challenges**
 - **Core capabilities**
 - **Objectives**

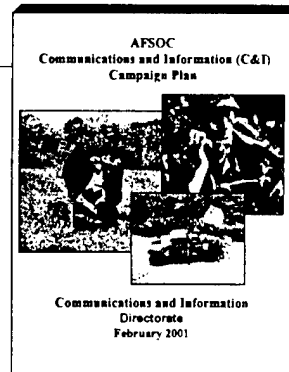

**Plan of action
for staff and
units**



C&I Mission

**Provide combat ready...
C4I warriors and C4I infrastructure...
... to execute
SOF war planning,
command and control, and
combat operations worldwide.**



HQ AFSOC/SC Organization

Auth/Assgn	
Off:	18/15
Enl:	24/24
Civ:	09/08
Total:	51/47
Ctr:	13/13

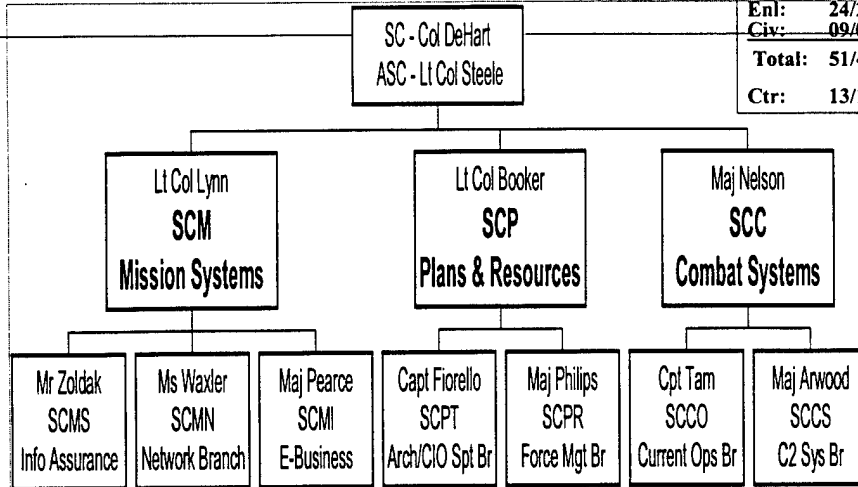

AFSOC Comm Units

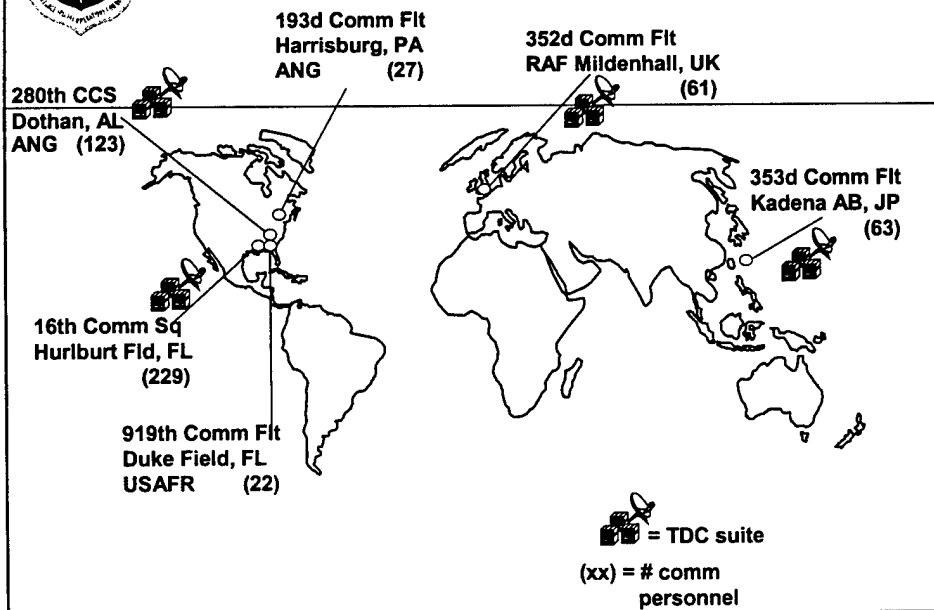

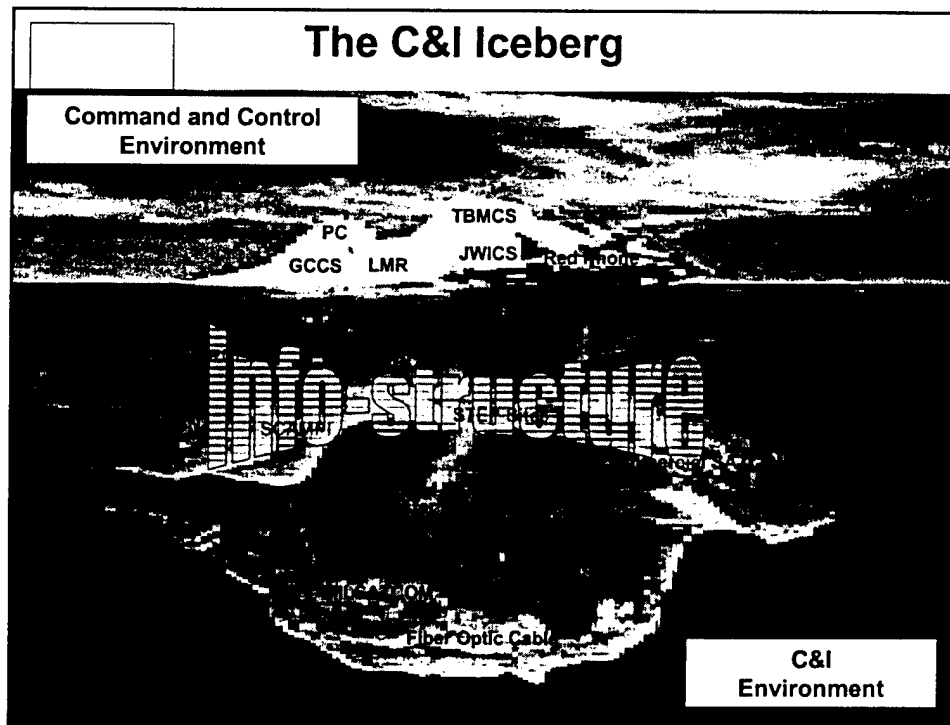
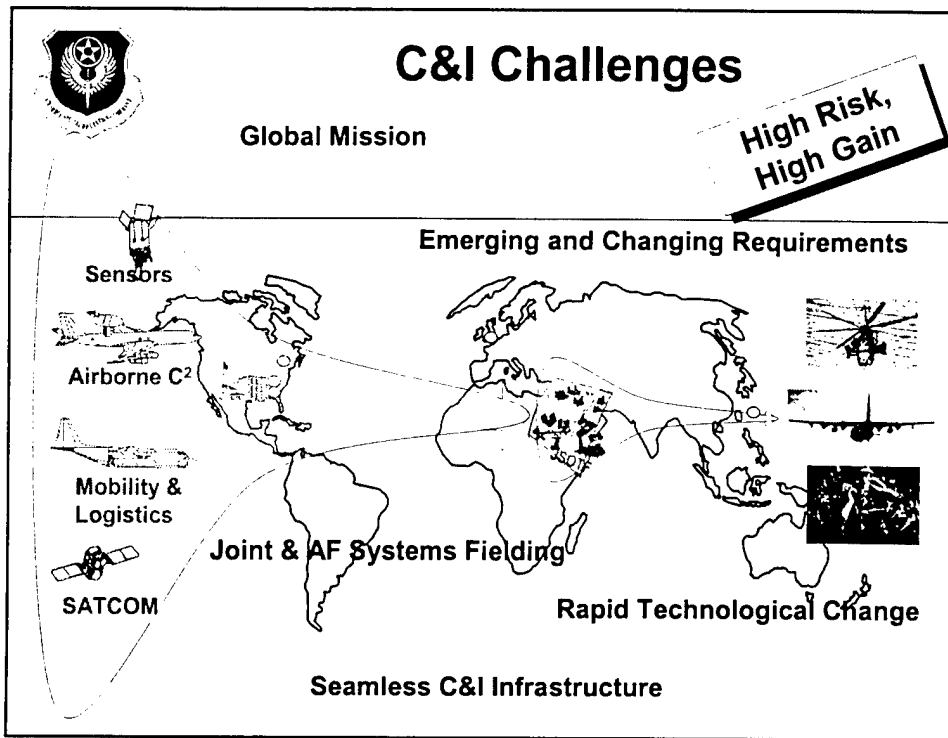

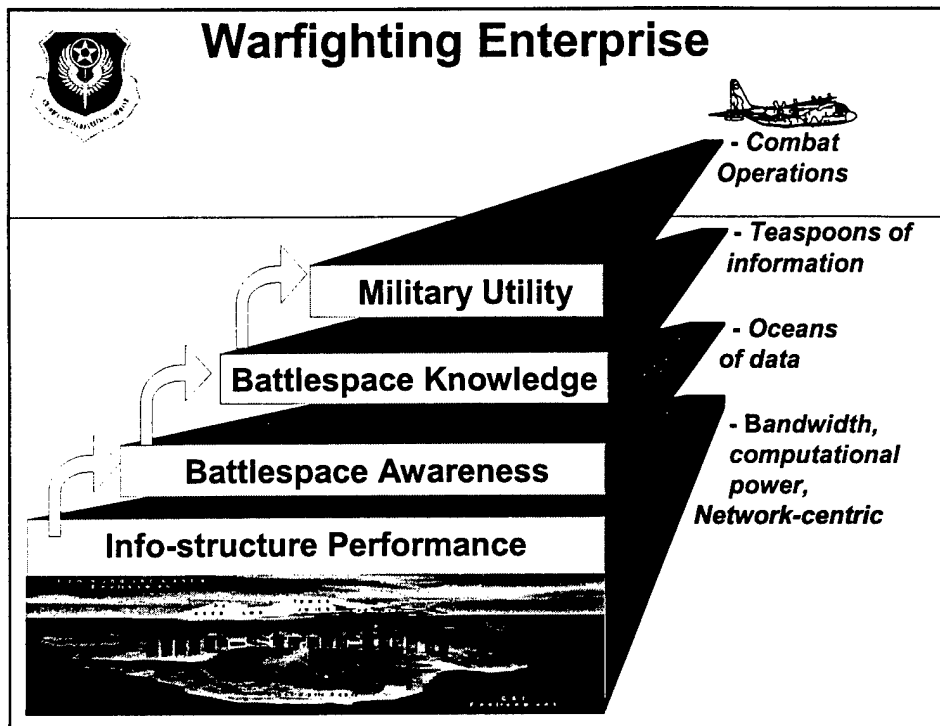

Network Centric Warfare

“The effective linking or networking of the warfighting enterprise.”

- **Built around the concept of sharing information and assets with forces that are...**
 - ... Geographically dispersed
 - ... Knowledgeable
 - ... Linked
- **“Info”structure is the enabler – must be...**
 - ... Robust, high-performance
 - ... Dynamic, self-healing “organism”

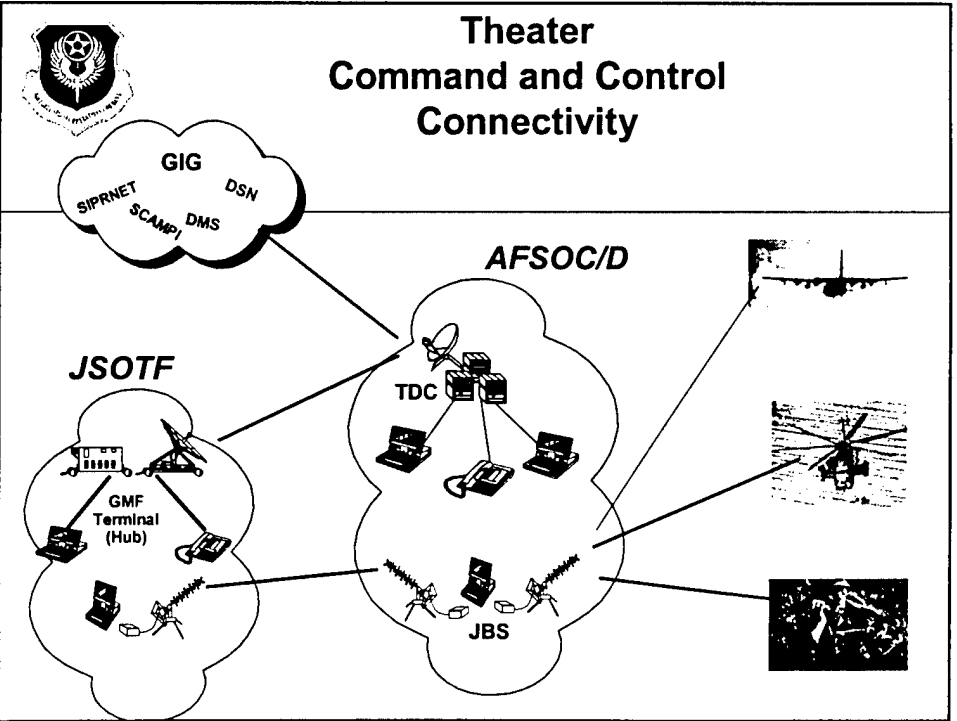
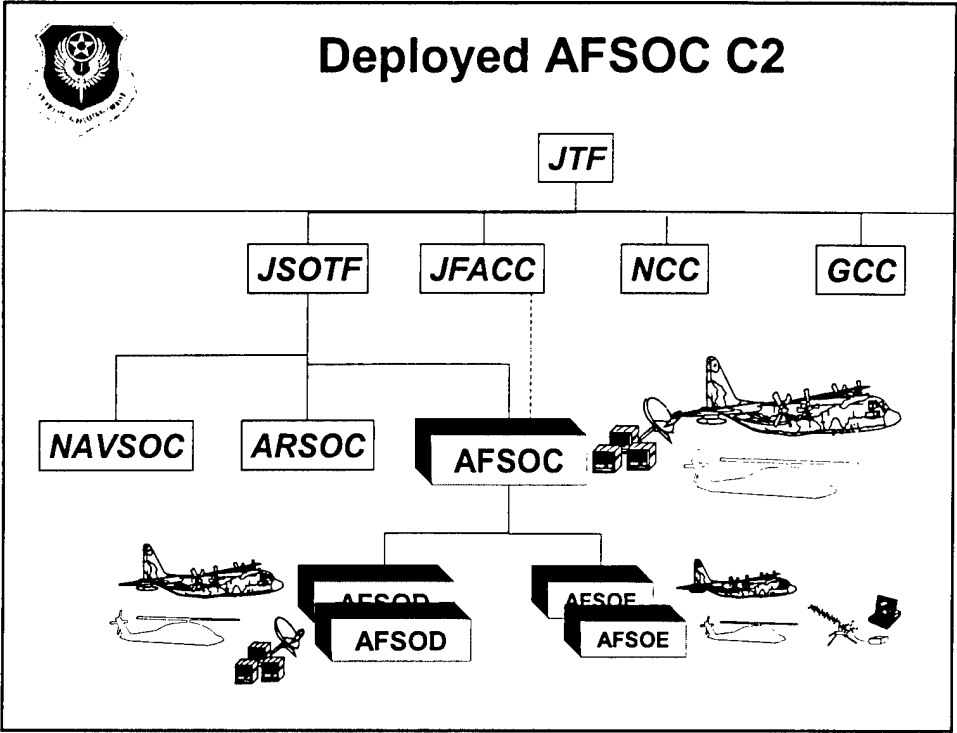



AFSOF Info Enterprise

- Deliberate and contingency planning
- CINC support
- Joint/Combined interoperability
- Assured Information
- Combat Operations

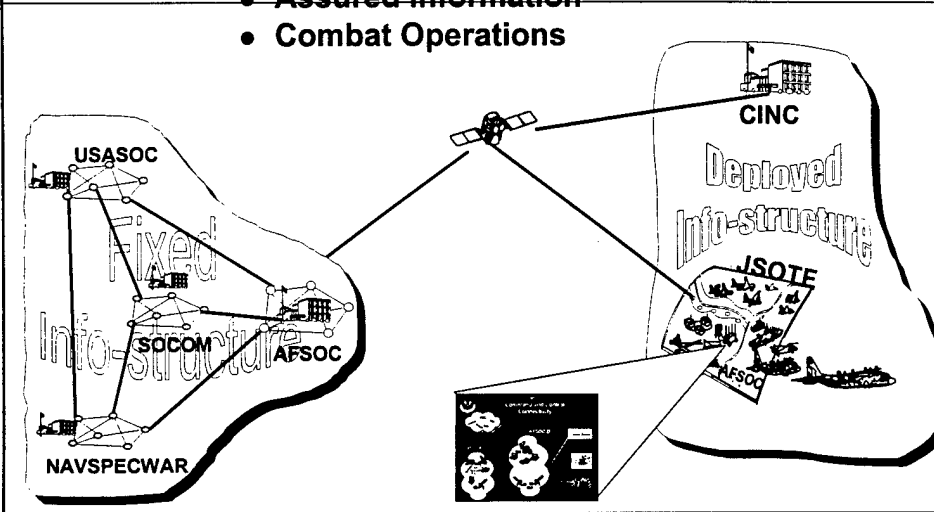

AFSOF Info Enterprise

- Fixed Info-structure "The last 400ft"
- Deployed Info-structure
- IT Business Processes



The Last 400'

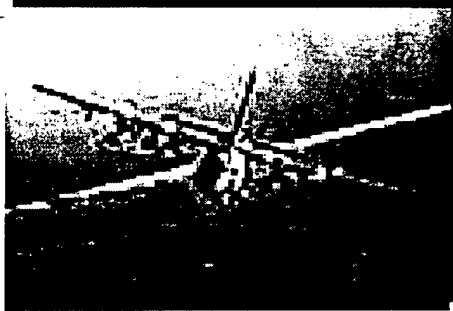

Fixed Info-structure

SIPRNET

- **The last 400' on Hurlburt**
 - **38 buildings wired for SIPRNET**
 - **28 buildings remaining**
 - **950 PC's bought for SIPRNET (575 at Hurlburt)**
- **Thin Client proof-of-concept**
- **SCAMPI Right-sizing**
 - **Legacy system**
 - **SOCOM ready to migrate to DISN**
 - **Mildenhall**



Fixed Info-structure

IT Summit

- AF Portal
 - 100+ AFSOC users now registered (700 soon)
- E-mail Server consolidation
 - Reduce from 7 to 2 server farms

	<u>Baseline</u>	<u>Goal</u>	<u>Servers to Eliminate</u>
E-mail Servers	13 (1 Jun 00)	10 (1 Apr 01)	3 (1 Apr 01)
Core Services	65 (1 Jun 00)	33 (Sep 02)	32 (Sep 02)
Functional Apps	50+ (1 Jun 00)	TBD	TBD



Fixed Info-structure

Digital Voice

- Secure Terminal Equipment (STE)
 - Next generation secure phone
 - Desk-top and tactical versions
 - ~1,100 required
- Telephone switch upgrades (unfunded)
 - 96% full (west) and 70% full (east)
 - ISDN capability required

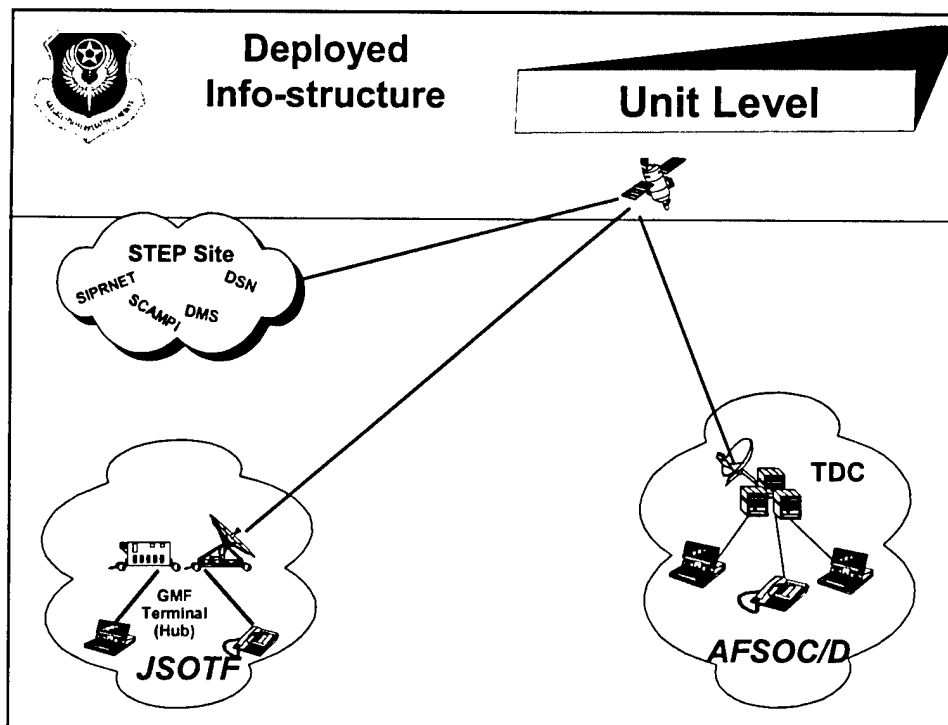
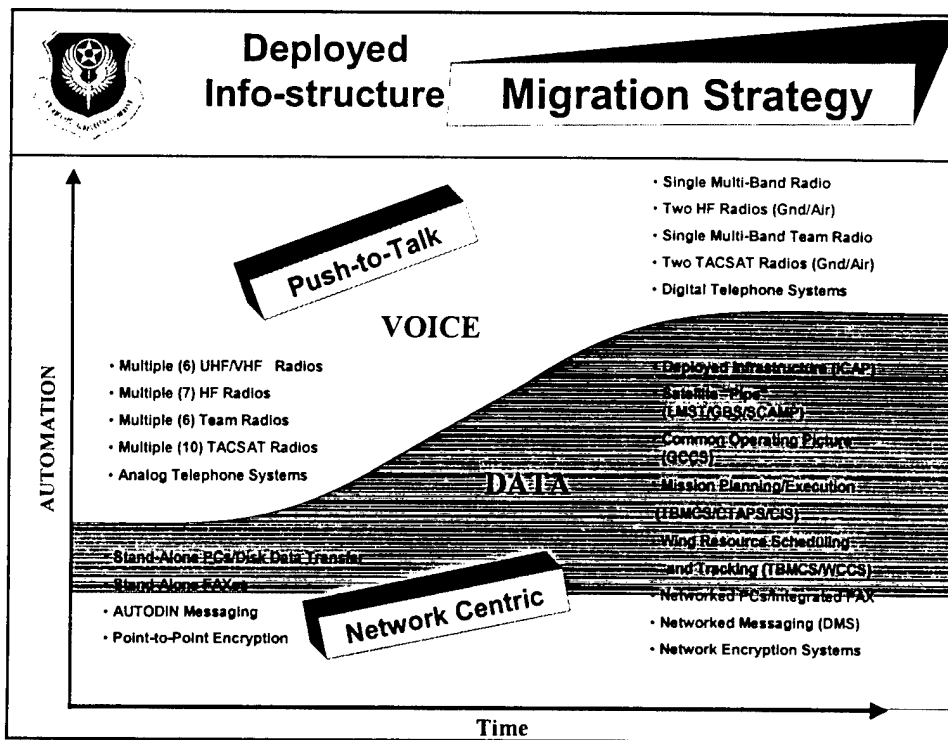



352SOG Mozambique

- First time in history that 352nd SOCF provided complete (100%) comm to JSOTF staff
- First test of SOCEUR joint comm ops
- 98.5% up-time rate
- Initial set-up; 10 personnel in 10 hours
 - 1 Officer, 4 Radio Ops, 4 TDC, & 1 Power Pro
- Only complete tactical comm site for entire ops
- Outstanding support to 216 missions, 604 sorties, and 856 flying hours



Deployed Info-structure

Unit Level

- TDC – “a success story”
 - 280 CCS will receive hub version
 - LMST antenna replaced by GMT in '05
- SMART-T* terminals fielded in '01
 - 16 SOW – 2
 - 352 SOG – 1
 - 353 SOG – 1
 - 280 CCS - 1
- GBS – Global Broadcast Service in '04



* SMART-T Secure Mobile Anti-jam Reliable Tactical Terminal

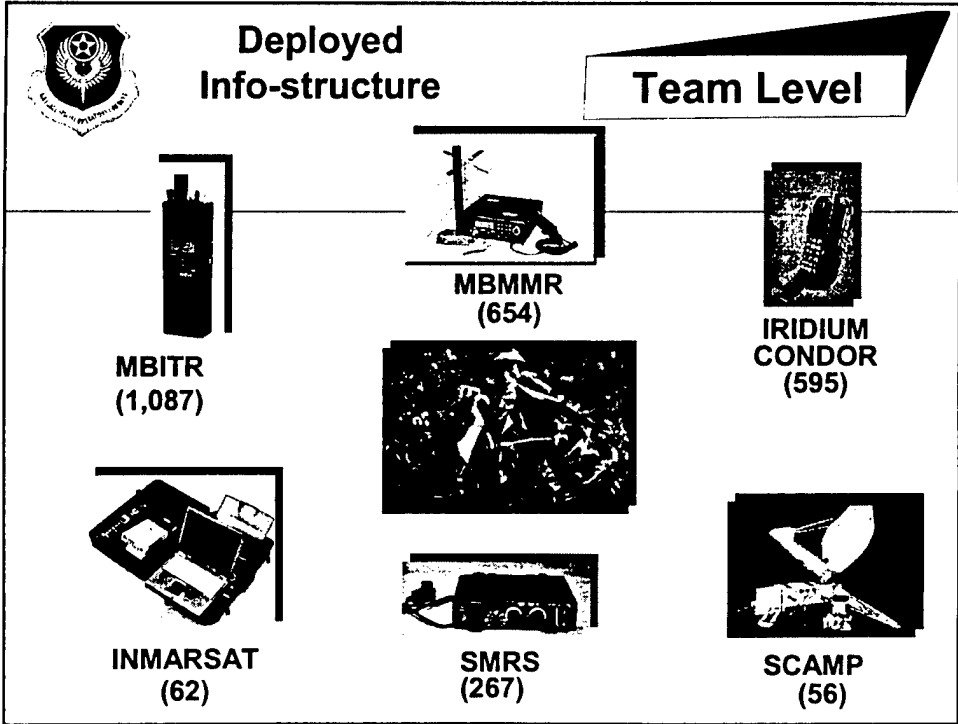
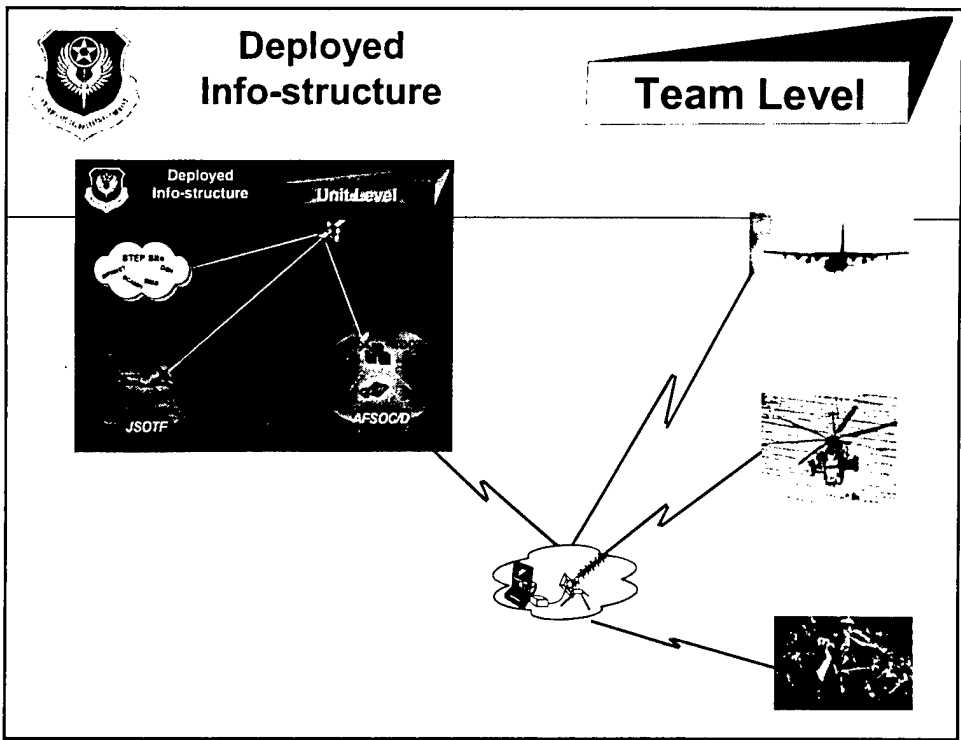



Deployed Info-structure

Airborne

- ~~Airborne comms are basically unchanged after 20 years~~
 - Infrastructure is narrow-band, push-to-talk, TADIL
 - Growing need for more bandwidth, C2, & sit awareness
- The future is network-centric – NIPR/SIPRnet, COP, web
 - Commercial airline IT services expanding
 - CINCCENTs C-40 -- 2002
 - GBS airborne terminal -- FY08
 - CV-22 wideband comm -- 6Mb prototype is here today
 - TACAMO E-6 – WB receive, NB transmit
- Must posture to partner with the airborne community
 - We're networking experts; we need airborne expertise
 - Must avoid stovepiping & growth of a separate IT domain



Deployed Info-structure

Airborne

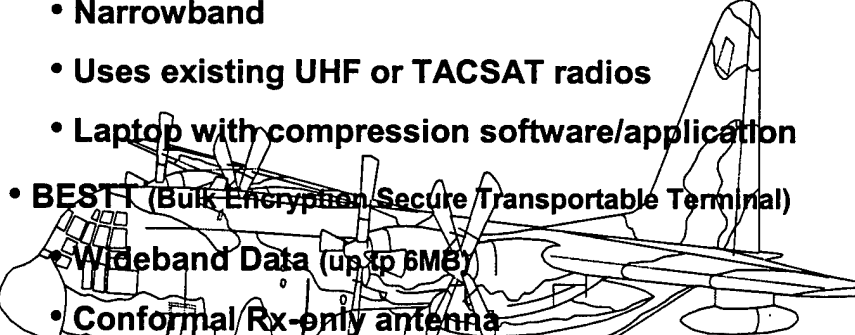
- **BRITE (Broadcast Request Imagery Technology Experiment)**
 - Narrowband
 - Uses existing UHF or TACSAT radios
 - Laptop with compression software/application
 - **BESTT (Bulk Encryption, Secure Transportable Terminal)**
 - Wideband Data (up to 6MB)
 - Conformal Rx-only antenna
- 

“One AF, One Network” includes the airborne domain !!!



IT Business Processes

AFSOC CIO

- 1996: Clinger-Cohen Act
 - Establishes Chief Information Officer (CIO) Position
 - Mandate - Spend money on IT to improve efficiency and effectiveness while reducing long terms costs
- 1999: AFSOC/CV appoints AFSOC/SC as CIO
- Oversee SOCOM SIE and AF CIO processes
 - IT Investment Strategy
 - Approved Product List
 - Configuration Mgt
 - Info Assurance
- Visibility on IT expenditures
- Cross-Functional Process, not just SC



IT Business Processes

CIO Council

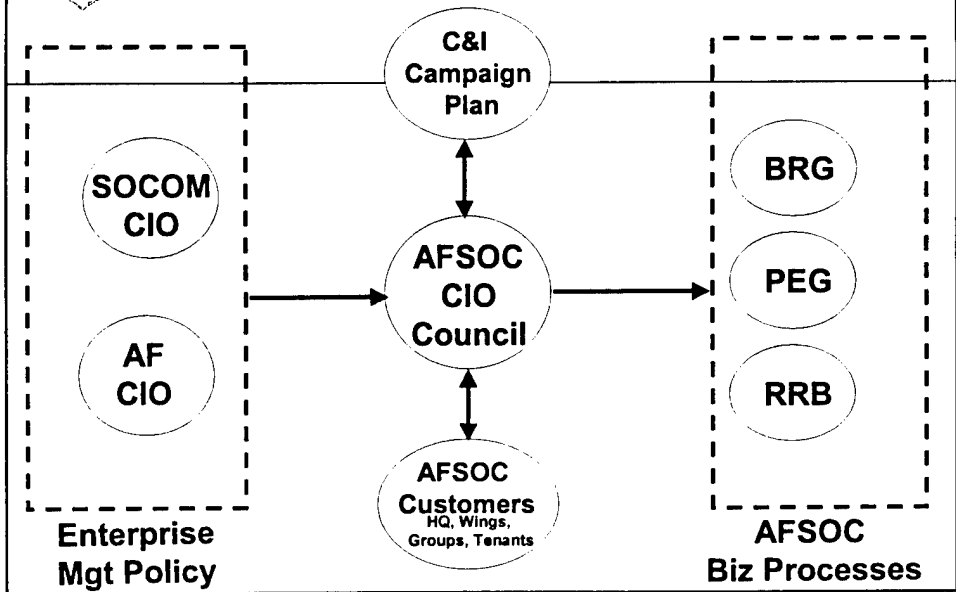



IT Business Processes

C&I Education

- ~~USAFSOS~~ and Joint Special Ops University
- Why not a course for SOF communicators?
- C&I capabilities and Concepts of Operations
 - Joint
 - Component
 - Theater SOCServices
- Programs and future systems
 - SOCOM
 - Services



SUMMARY

- C&I Campaign Plan is a “plan of action”
 - Network Centric Goal
 - Fixed Info-structure
 - Deployed Info-structure
 - IT Business Processes

Plan of action
for staff and
units

Acquisition Challenges for Adaptive IT Systems

Presented to
12th Annual NDIA SO/LIC Symposium
14 February 2001

by
James W. Cluck
Director of Management
Acquisition and Logistics Center
U.S. Special Operations Command

ADAPTIVE SYSTEMS

Systems Which Are Specifically Designed to Perform a Multiple Range Of Tasks With Minimal Reconfiguration by the Operator.

IT Systems Evolving More Adaptive Natures Include:

- Networks
- Receiver/Transmitters
- Antennas
- Sensors

NETWORKS

Major Focus Areas for Future Adaptability:

- Garrison/Tactical Interop/Interchange-Ability
- IP Addressing Protocols/Addressing
- Dynamic LAN Configurations
- Asymmetric Routing

RECEIVER/TRANSMITTERS

Future Radios Must Be Radically Different :

- Multi-Band
- Multi-User
- Multi-Functional

ANTENNAS

Principal Features Must Include:

- Adaptive Impedance Matching
- Dynamic Frequency Tuning
- Balance of Electrical and Physical Characteristics
With User and Equipment Load



SENSORS

- Self-Organizing
- Local Fusion of Sensor and Communication Information
- Adaptive LPI/LPD Comms
- Cross-Cueing
- Power Control Systems

ACQUISITION CHALLENGES

- Performance Based Contracts Must Become the Norm
- Government and Industry Must Team on R&D Ventures
- Licensing Schemes Must Balance Multi-Computer Users With Reasonable Protection to the Vendor
- Contracting Must Be Synchronized With Moore's Law



The IT Acquisition Challenge

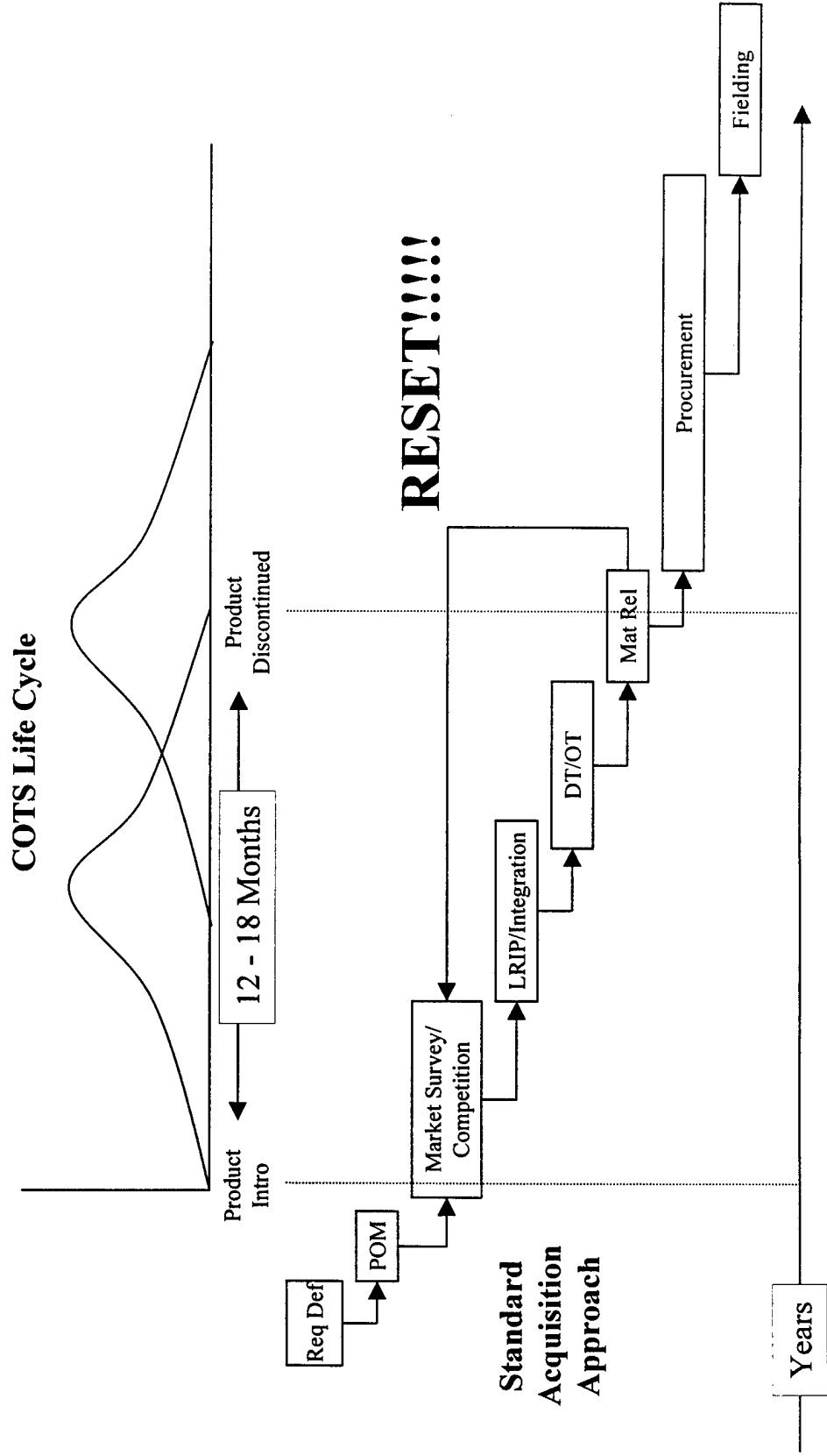

A Modest Proposal

Continuous Process To Keep Pace With Technology

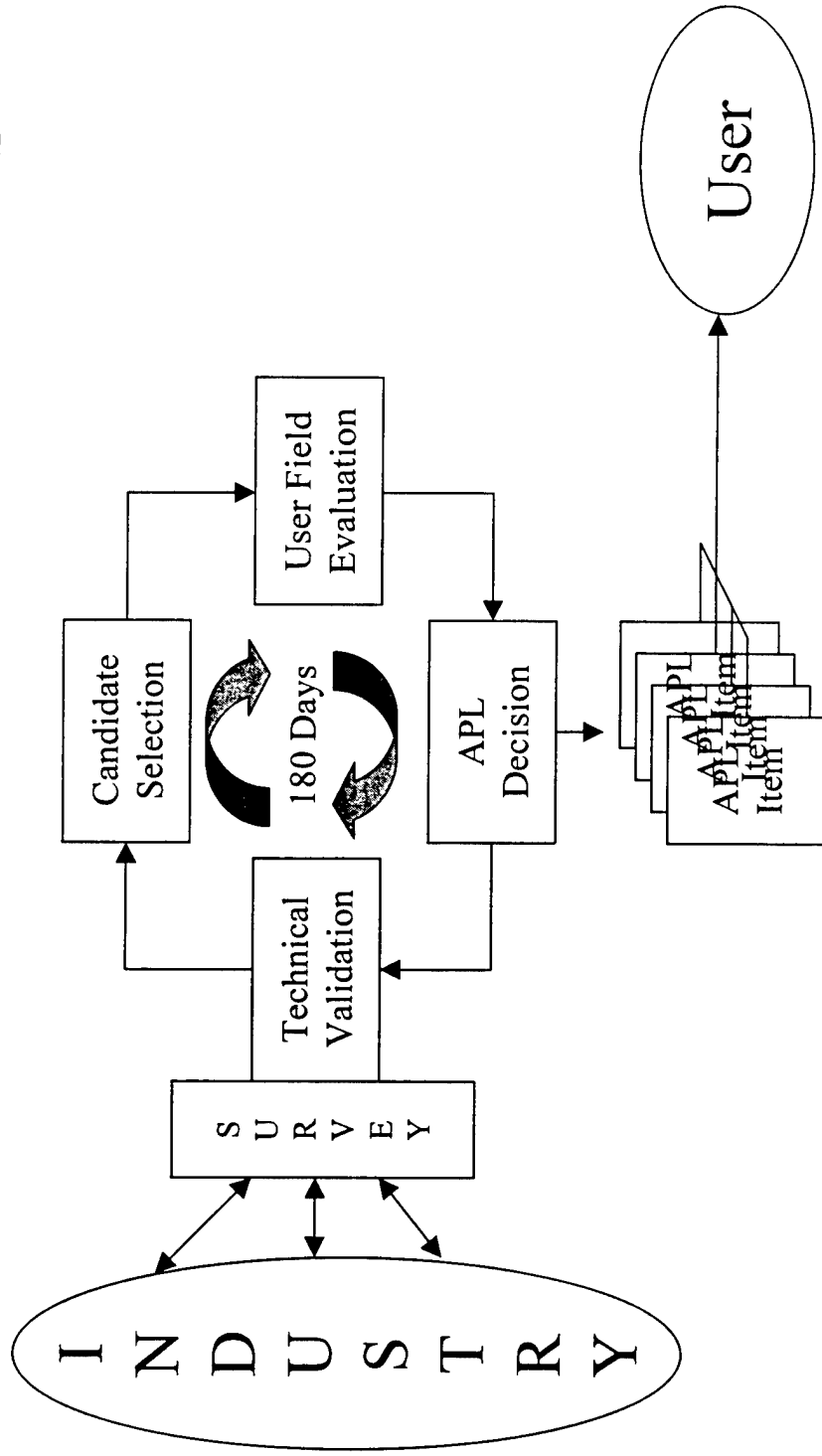

CHALLENGES (con't)

- SBA Credits Must Balance Prime Contractor and Organizational Goals
- Differentiate Between Seat-Based and Enterprise Licensing
- Infrastructures Dictate Product Loyalties

CHALLENGES (con't)

- SLA Definitions Must Be Adaptively Tied to Incentive
Clauses
- Incentive Fees Must Be Tied to Reliability Warranties
- Incentives May Be Term Arrangements or Fees

CONCLUSION

- Acquisition Practices Are Changing to Keep up With the Rapidly Changing IT Environment.
- Multi-Functional, Reliable Systems Will Be the Only Way for Modernization to Be Affordable.
- Keys to Success Will Be Innovative Gov't-Industry Teams, And Responsive Contracting Mechanisms.



Biography

United States Special Operations Command

Public Affairs Office 7701 Tampa Point Blvd MACDILL AFB, FL 33621-5323
(813) 828-4600 Fax: (813) 828-4035

JAMES W. CLUCK

Mr. James W. Cluck is the Director of Management within the Special Operations Acquisition and Logistics Center, United States Special Operations Command. His current charter is focused on management of the Acquisition Policy, Program Integration, Foreign Comparative Test, Management Operations, and Technical Industrial Liaison Offices. He also represents the Acquisition Executive in various acquisition matters within Headquarters, USSOCOM, and at the Department of Defense level.

Mr. Cluck has over 28 years combined military and Federal service including over seventeen years experience in DoD acquisition. His specific acquisition experience includes both corporate and Government program manager assignments for intelligence and telecommunications programs.

After enlisting in the Marine Corps in 1968, Mr. Cluck served as an aviation photographic-electronics technician with the 1st and 2nd Marine Aircraft Wings until 1974 when he entered The Citadel under the Marine Enlisted Commissioning Education Program. Commissioned as an Air Defense Officer in 1976, he subsequently held various Redeye, Improved HAWK and Marine Air Control Group assignments. From 1984 through 1988 Mr. Cluck served as the Systems Engineering Officer and Project Manager for developing Signals Intelligence Systems while assigned to Headquarters, U.S. Marine Corps, Washington, DC and the Marine Corps Research, Development and Acquisition Center, Quantico, VA.

From 1989 through 1991, Mr. Cluck was employed as a senior program manager for a telecommunications firm and was responsible for both business and technical management aspects for several U.S. Army and DoD Agency contracts involving intelligence systems development, production and fielding support.

Since accepting a position at the United States Special Operations Command in 1992, Mr. Cluck has served as the Deputy Program Executive Officer, Intelligence and Information Systems; Program Manager, Intelligence Systems; and Program Manager, C4I Automation Systems. Throughout these assignments, he consolidated diverse intelligence, command and control, and information programs through common migration and technical management techniques to minimize MFP-11 resourcing and enhance interoperability. Mr. Cluck received the USCINCSOC Quality Award in 1997 and the David Packard Award in 1996 for acquisition excellence.

Mr. Cluck graduated from The Citadel in 1976. He also earned a Master's Degree in Telecommunications Systems Management in 1984 from the Naval Postgraduate School, Monterey, California. Mr. Cluck completed the Defense Systems Management College – Program Management Course in 1987 and is designated as a Level III-qualified acquisition professional within the DoD Acquisition Corps.

Mr. Cluck is married to the former Valerie Wetherington of New Bern, North Carolina. They have one married son, Michael.

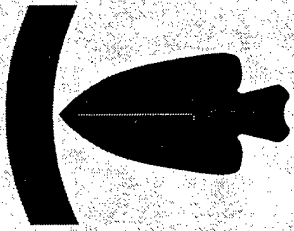

The changing ARSOF Communications Environment

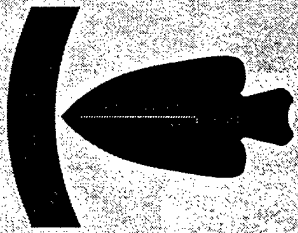

ARSOF Communications doctrine and equipment fieldings must keep pace with changing SOF mission requirements and take advantage of Service initiatives designed to accomplish similar requirements.

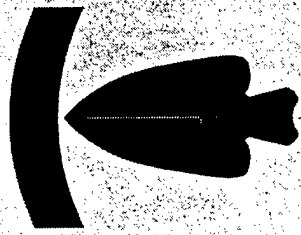

Command and control of ARSOF units has migrated from a decentralized system of scheduled contacts between the detachment on the ground and its immediate headquarters; to centralized system of instantaneous secure voice and data communications linking an increasingly smaller unit on the ground with an increasingly higher headquarters in the Chain of Command.

“Control” Requirements:

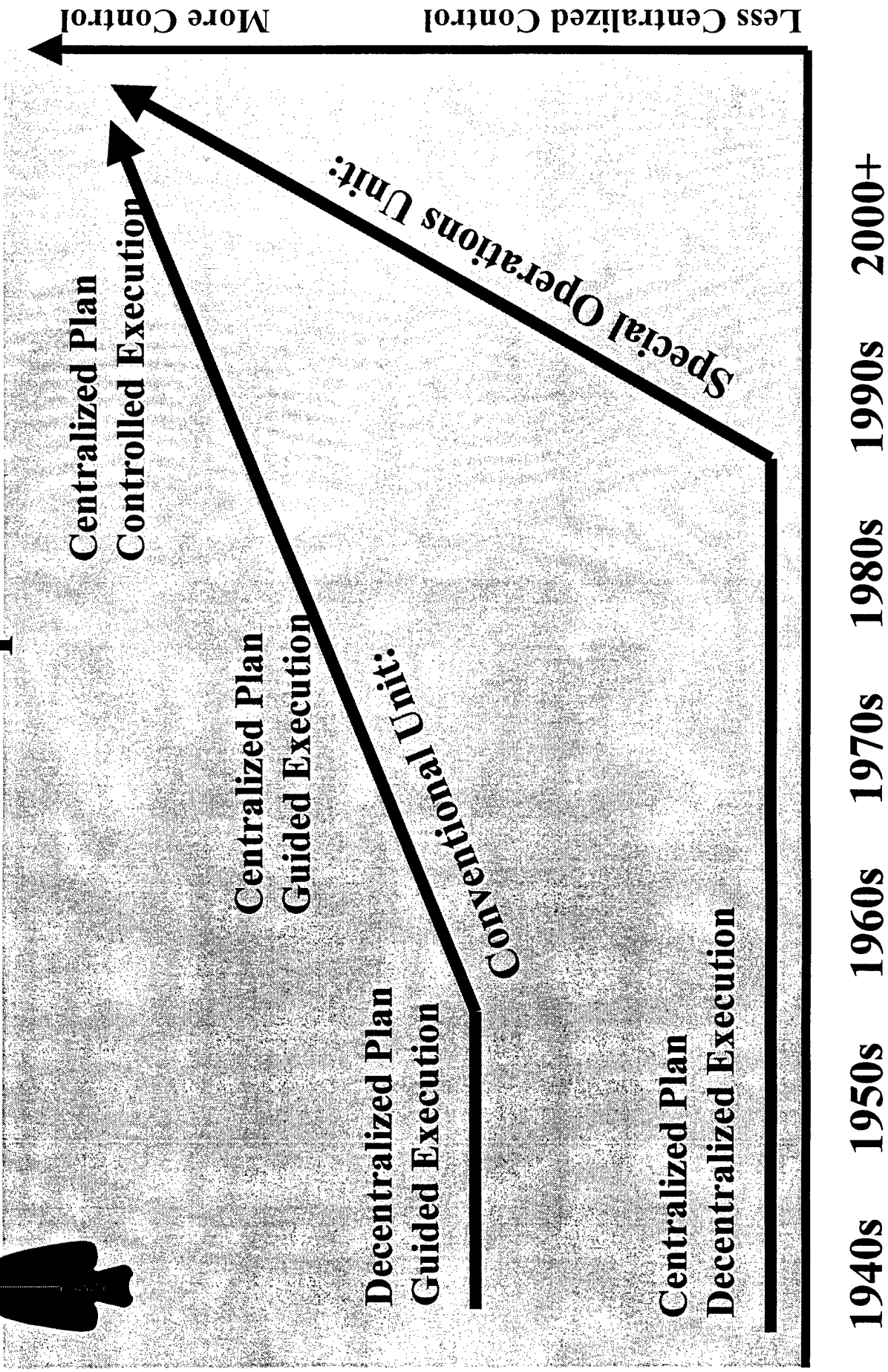

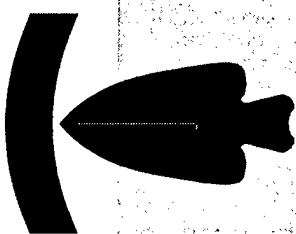

Communications Systems:

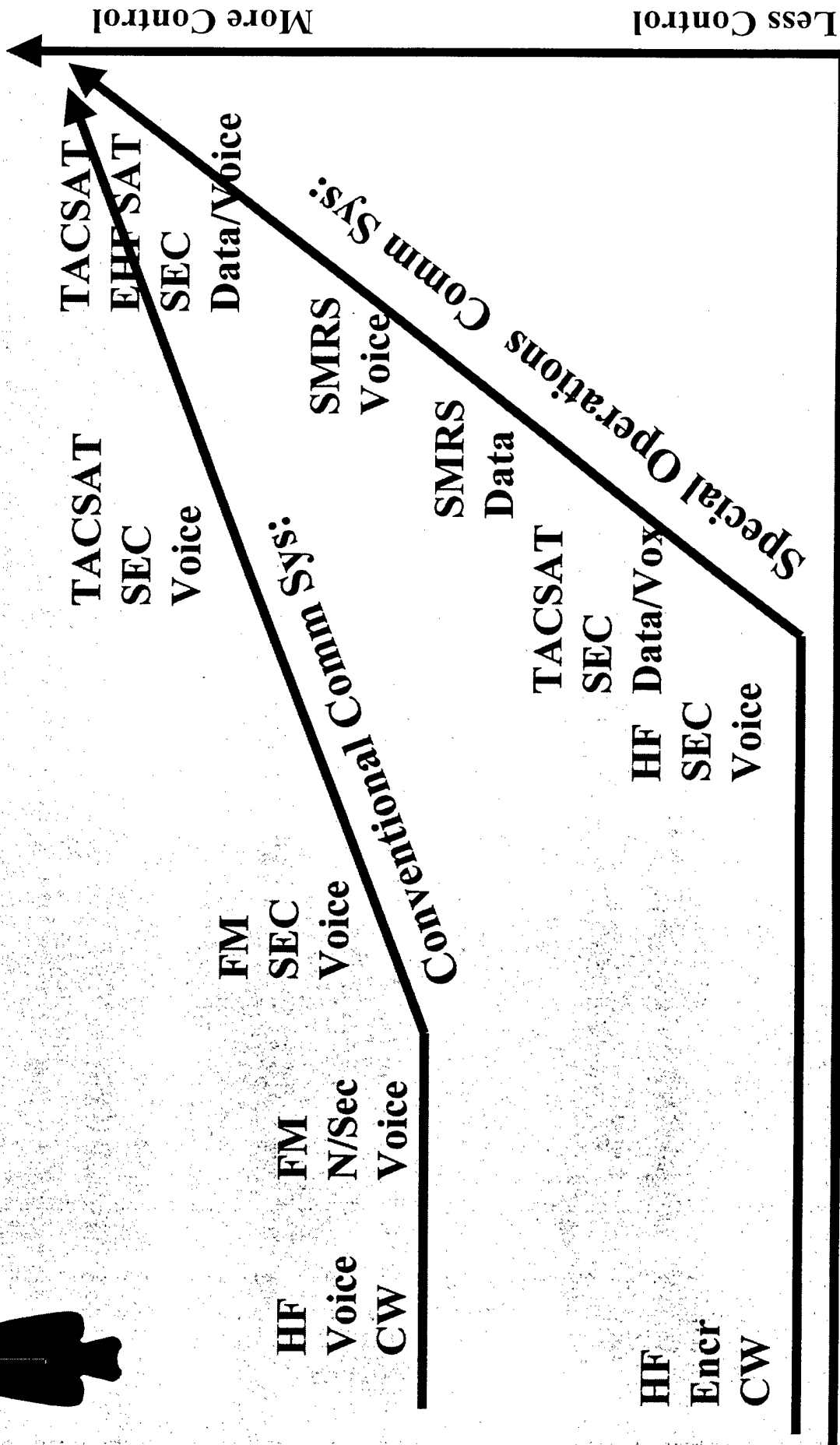

1940s 1950s 1960s 1970s 1980s 1990s 2000+

Less Control

More Control

Conventional Comm Sys.

Special Operations Comm Sys.

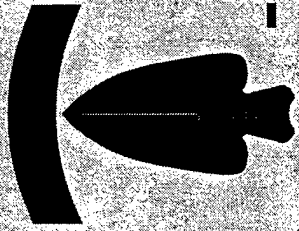

-High bandwidth reach-back systems required by ARSOF units at the battalion-level closely mirror the requirements of EAC units in the Conventional Army.

-As a result, ARSOF has an opportunity to take advantage of EAC communications initiatives programmed by the conventional Army.

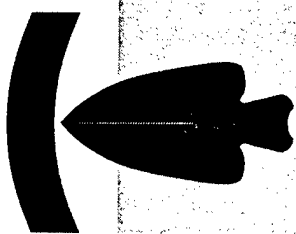

Reach-Back Requirements:

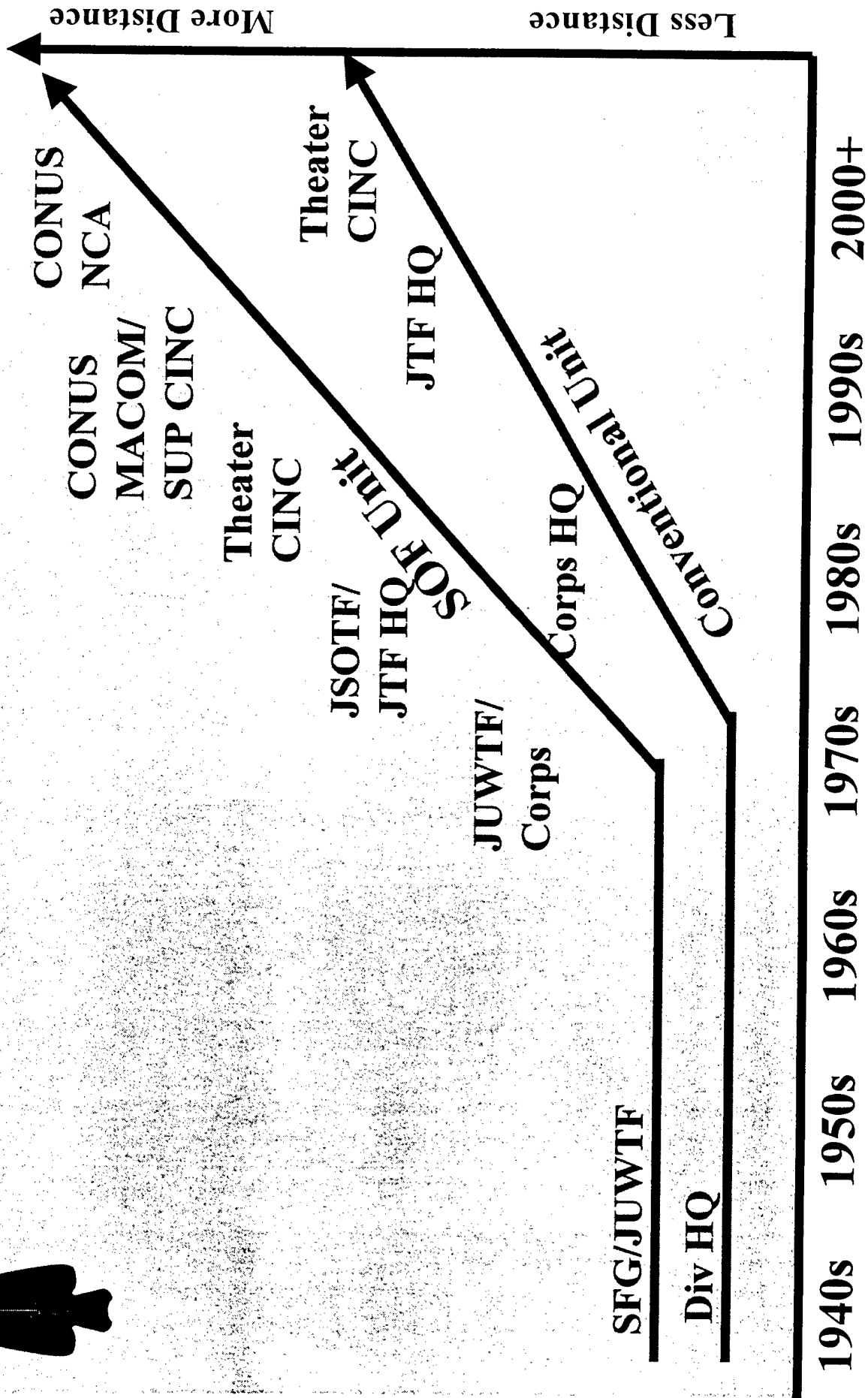

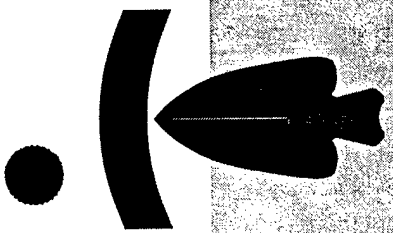

Reach-Back Data Load:

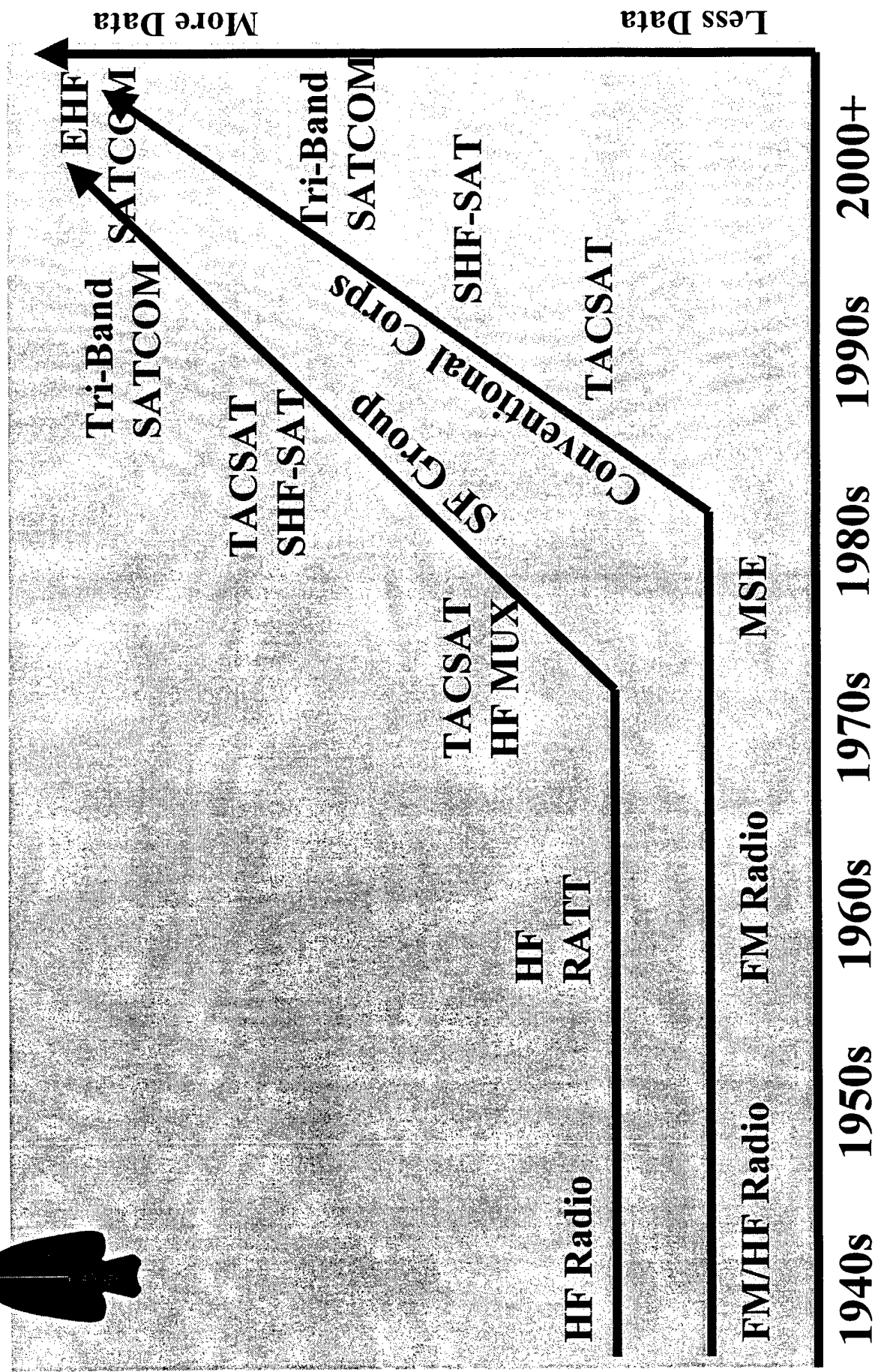

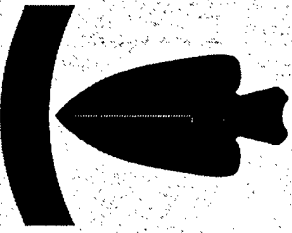

Conventional Army (P-2) funded communications programs have a better “field-to-TOE” record than SOF (P-11) programs. In most cases, SOF funded equipment is fielded at less than 50% of the MTOE requirement, while Army programs usually reach 100%.



Commo System Funding:

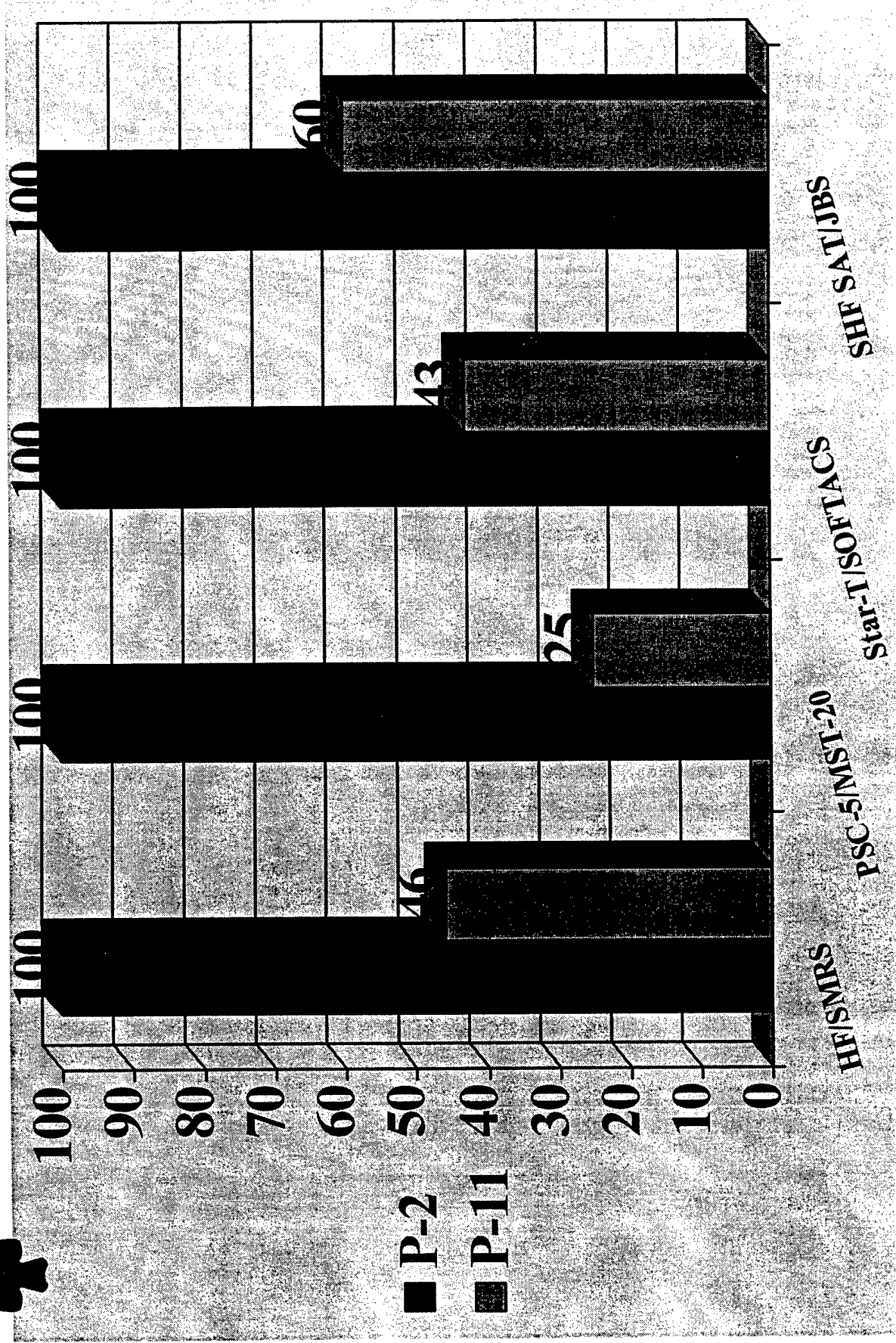

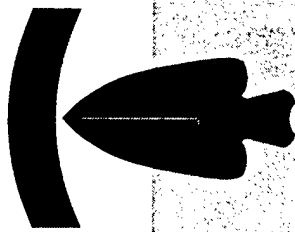

PSYOP System Funding:

EQUIPMENT	FY00	FY01	FY02	FY03	FY04	FY05	FY06	FY07	TOTAL
MPC					1		1, 1		1, 1, 1
TMPC	1, 1	1							1, 1, 1
PDS R/T		4, 3, 3	1			2		2	5, 5, 5
PDS R/O		3, 1	1, 1	2, 1	1, 1	4, 2, 1		6, 3, 2	17, 9, 4
LRB MED PWR AM				1					1, 0, 0
LRB MED PWR FM			1			1			1, 1, 0
LRB MED PWR TV						1			1, 0, 0
FABS AM		2	1	1, 1		2			3, 3, 1
FABS FM			2	1, 1	2, 1	1		1	3, 3, 3
FABS SW					1	2	1	1, 1	3, 1, 2
FABS TV					1	3, 1	1	1	3, 1, 3

Ledgend:

BLUE = 29 MAR 00
 RED = 19 OCT 00
 BLACK = 15 NOV 00

MPC - Media Production center
 TMPC - Theater Media Production Center
 PDS - PSYOP Distribution System
 LRB - Long Range Broadcast
 FABS - Fly Away Broadcast System

RADIO SYSTEM MIGRATION

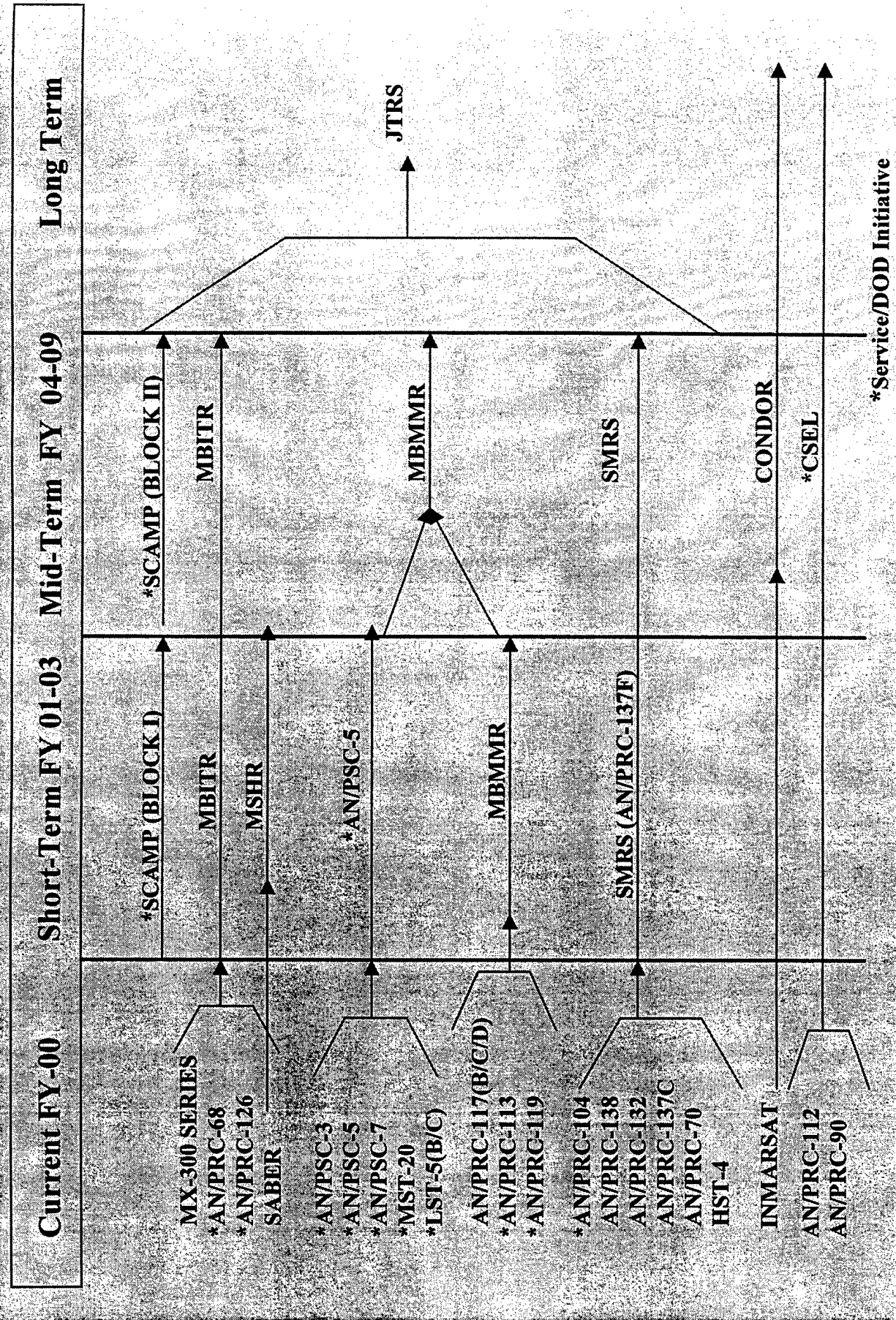

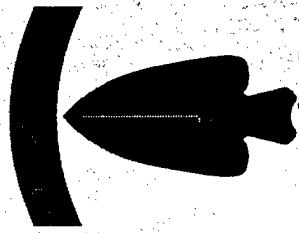

-The ARSOF community needs to rethink its communications doctrine to catch up with the reality of modern operational requirements.

-ARSOF needs to “ride the Component Service Train” wherever possible; Taking advantage of Army common solutions that fit SOF requirements.

-P-11 funds must “buy out” validated TOE requirements.

Special Operations in Desert Shield / Desert Storm



BY: Col (Ret) Jim Kraus



Purpose of Briefing

To inform attendees on the unclassified activities of the Army Special Operations Task Force during Desert Shield/Desert Storm (DS/DS)



What Briefing is Not

- A detailed account of DS/DS
- An account of all Special Operations activities during DS/DS



ARSOTF Mission

- Deploy to Saudi Arabia with all personnel and equipment
- Provide liaison and conduct Foreign Internal Defense (FID) operations with the Saudi Arabian Land Forces and on order conduct FID with with Pan Arab forces in the Eastern Area Command ...

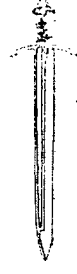

Army Special Operations Task Force in DS/DS

- Formed Army Special Operations Task Force OPCON to CENTCOM
- First time USSF/SOF have been used in day to day direct support of MRC
- Conducted Coalition Support Activities
- Developed TTP for Coalition Support activities



Alerted on 6 August 90 at Ft Campbell, KY

- Admonished to bring everything
- Planned and Prepared For
 - 24 hours
 - 1st Bn
 - Group Battle Staff
 - 48 hrs
 - 2nd Bn
 - Support Co (-)
 - 72 hours
 - Remainder less OPCON/attached units



Deployment Sequence

- 1- 5th Special Forces Group and Special Forces Operational Base Battle Staff
- 5th Special Forces Group Hq (-)
- 2-5 Special Forces
- 3-5 Special Forces
- 5 SFG Support Center

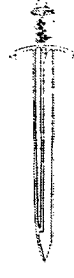
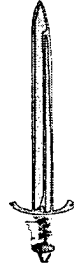

Deployment

DEPLOYMENT A/C

- 33, C-141
- 19, C-5
- 1902 SHORT TONS
- 1147 PAX

GUIDANCE

- ALL EQUIPMENT
- BARE BASE
- 30 DAYS SUSTAINMENT
- UBL AMMO
- 5 DAYS RATIONS

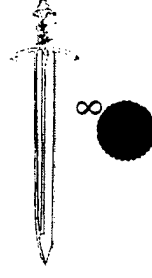

ORGANIZATION IN THEATRE



CENTCOM Command Structure

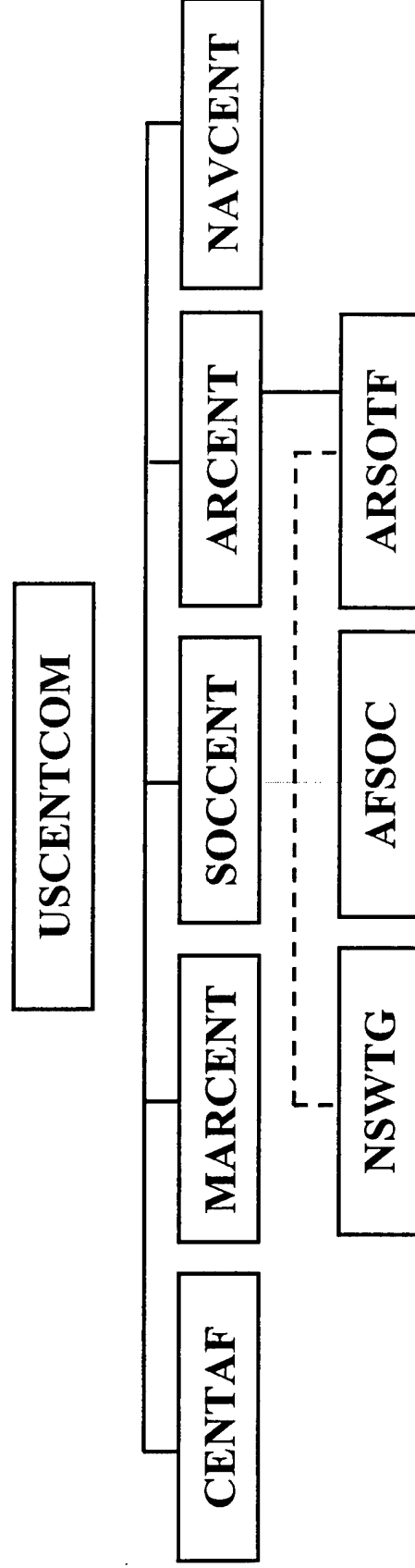

— CMD
- - - - - OPCON

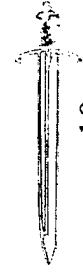

CENTOM Mission Statement

- Neutralize Iraqi National Command Authority
- Eject Iraqi Armed Forces From Kuwait
- Destroy Iraq's Ballistic Missile, NBC Capability
- Assist in the Restoration of the Legitimate Government of Kuwait



ARSOTF ORGANIZATION

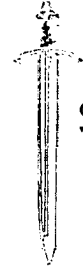
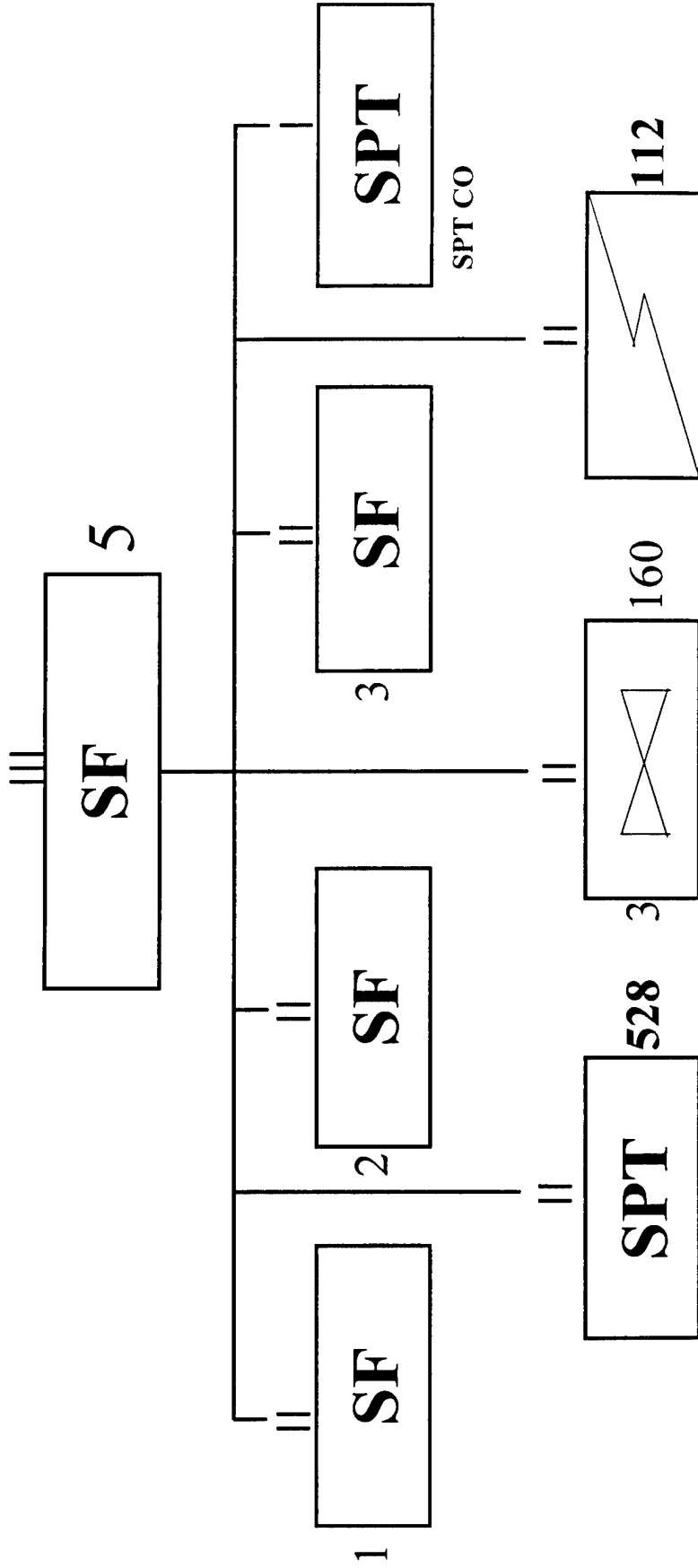

3-16th Special Operations Aviation Bn

- CSAR
- DEEP PENETRATION
- SR
- DA
- MEDEVAC (EMER EXFIL / MEDEVAC)
- 8 x MH 60s
- 7 x MH 47s



112th Special Operations Signal Bn (Abn)

- Provided invaluable communications support to the ARSOTF
- NRI (1)
- SOCA (8)
- LDC (13) (PART OF HFMUX AND SOCAS)
- HFMUX (8)
- COMMAND AND CONTROL
- PLANS



528th Special Operations Support Bn (Abn)

- LINKAGE INTO SUPCOM (EAC)
- ALL CLASSES OF SUPPLY
- TRANSPORTATION
- MAINTENANCE
- PLANS / COORDINATION TO SUPPORT
- CINC DEFENSIVE / OFFENSIVE CAMPAIGN



Desert Shield Activities



Incompatibility problems between

US and PanArab Forces

- Language differences and cultural differences
- Communications, equipment and procedures
- Different tactics / doctrine
- Equipment
- Staffing procedures
- Combat Support and Combat Service Support
- Use of Threat equipment by Pan Arab forces (T-72, BMP, BTR, D-30, etc.)



Pan Arab Forces

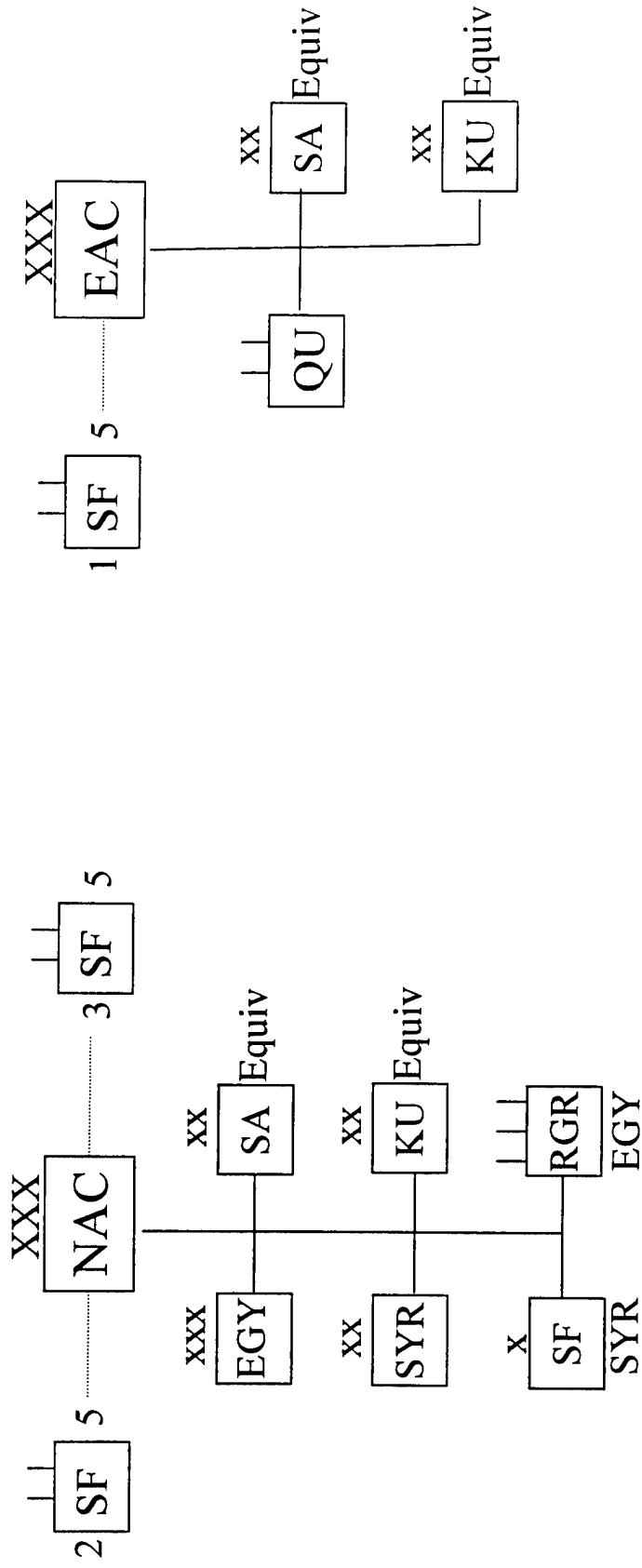

Equivalent to seven divisions +

NAC = Northern Area Command

EAC = Eastern Area Command

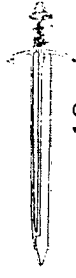

Initial Concept

- Train, coordinate, train
- Provide early warning of ground attack
- Attrit attacking forces
- Fall back to Saudi Brigades while continuing to attrit Iraqi forces
- Conduct passage of lines, under contact, thru XVIII Corps forces
- Move into assembly area prepare to continue attack

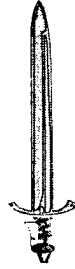

Border Surveillance

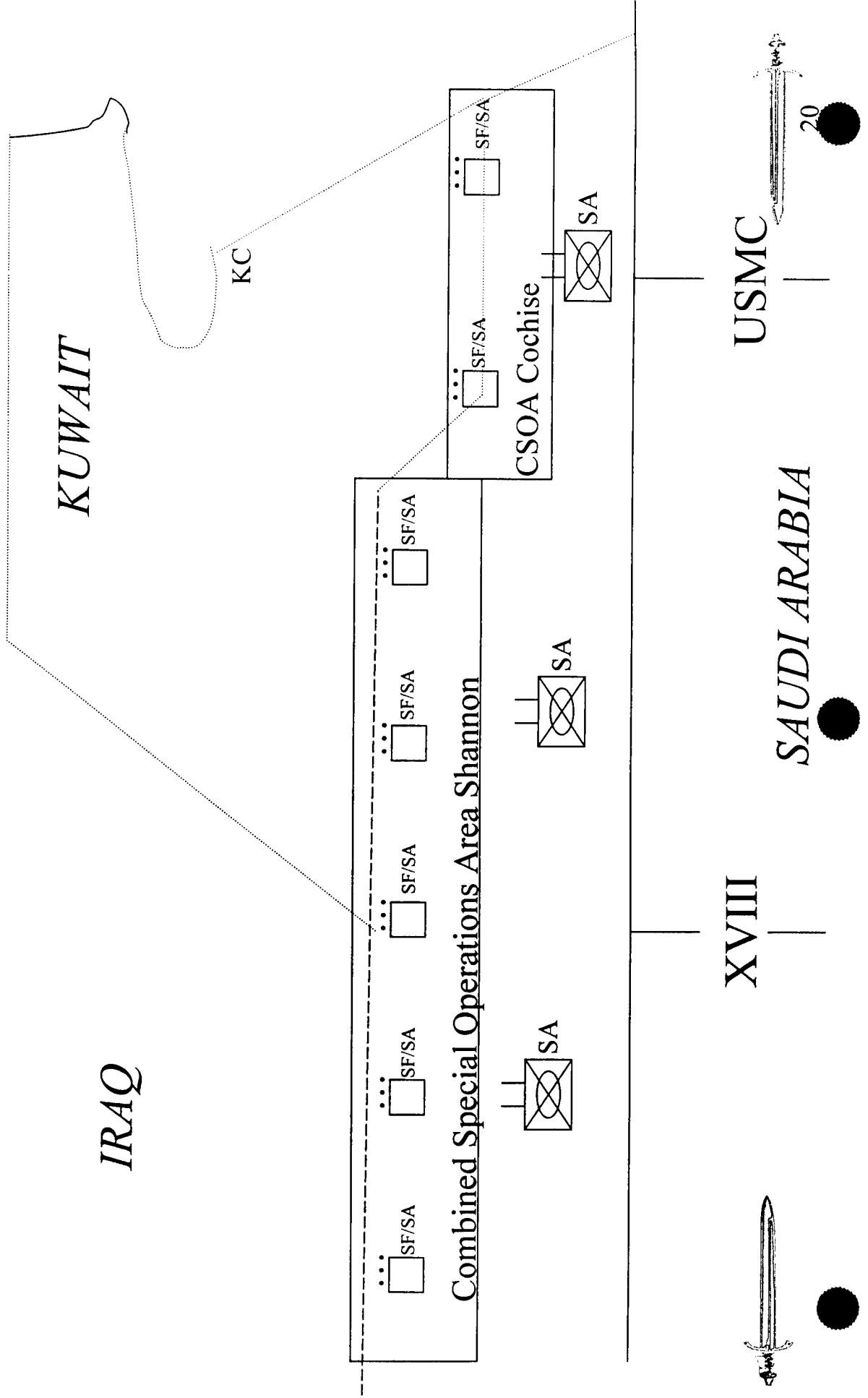

IRAQ

KUWAIT

KC

Combined Special Operations Area Shannon

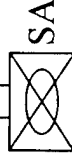
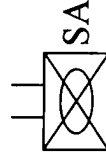
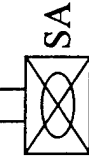

XVIII

SAUDI ARABIA

USMC



Initial Activities

- Patrolling along Kuwaiti/Iraqi Border
- Reconnaissance
- Assessing Pan Arab forces
- Training, training, training
- Begin reconstituting Kuwaiti Army



Training With Coalition Forces

- Individual, Collective and Leader Tasks
 - Staffing organization and procedures
 - Defensive and Offensive Operations
 - Mobility / Counter Mobility
 - Maintenance
 - NBC warfare
 - Logistics



● ● ● Training With Coalition Forces

(cont'd)

- Communications
- Battlefield Coordination
- Reconnaissance TTP
- Tank Gunnery
- Mission Planning
- MOUT



Training with Coalition Forces

(Cont)

- Limited visibility operations
- Clearing obstacles (mine fields)/ Crossing trench lines
- Map reading and US/NATO graphics
- Integration of CAS
- Fire Support



Desert Storm Activities

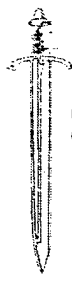

IRAQ

KU

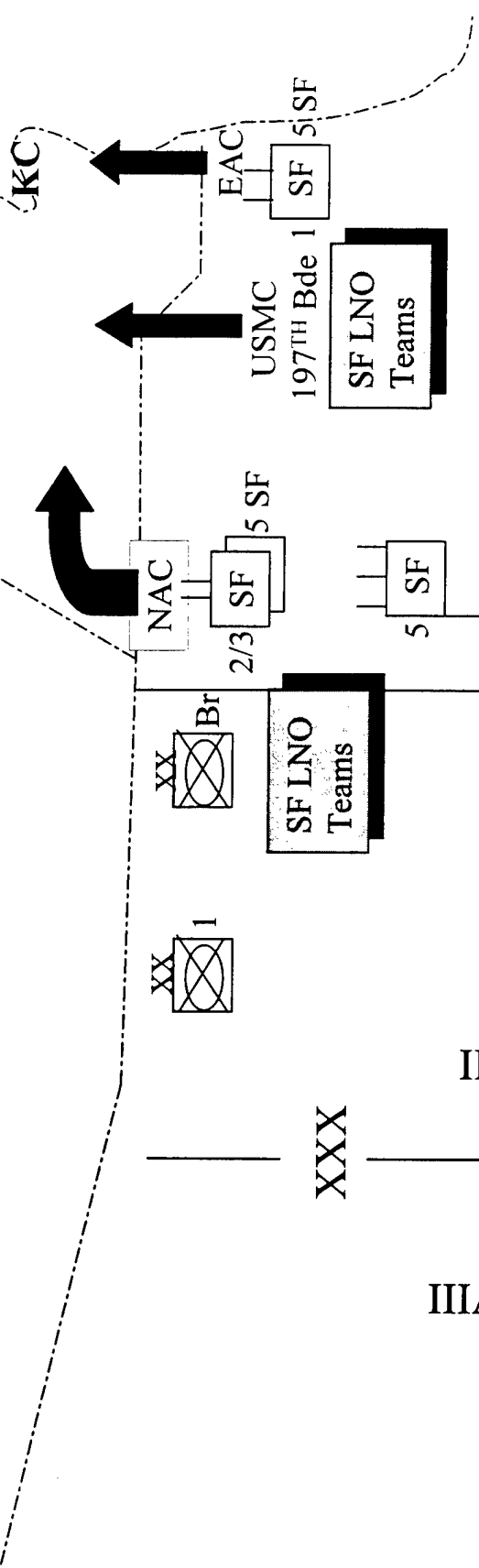

- SF LNO Teams
- USMC Divisions x 2
 - US Corps X 2
 - Br Div X 1
 - 82nd Airborne Div
 - French Foreign Legion

- NAC
- Egyptian Corps (-)
 - Egyptian Ranger Rgt
 - Syrian Div
 - Syrian SF Bde
 - Saudi Div (-)
 - Kuwaiti Bdes x 3

- EAC
- Saudi Bde x 3
 - Kuwaiti Bde x 3
 - Omani Bn
 - Qatar Bn

NAC + EAC = APP 7 DIV

Special Reconnaissance Teams

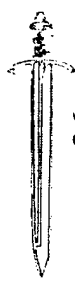

ARSOTF Command and Control

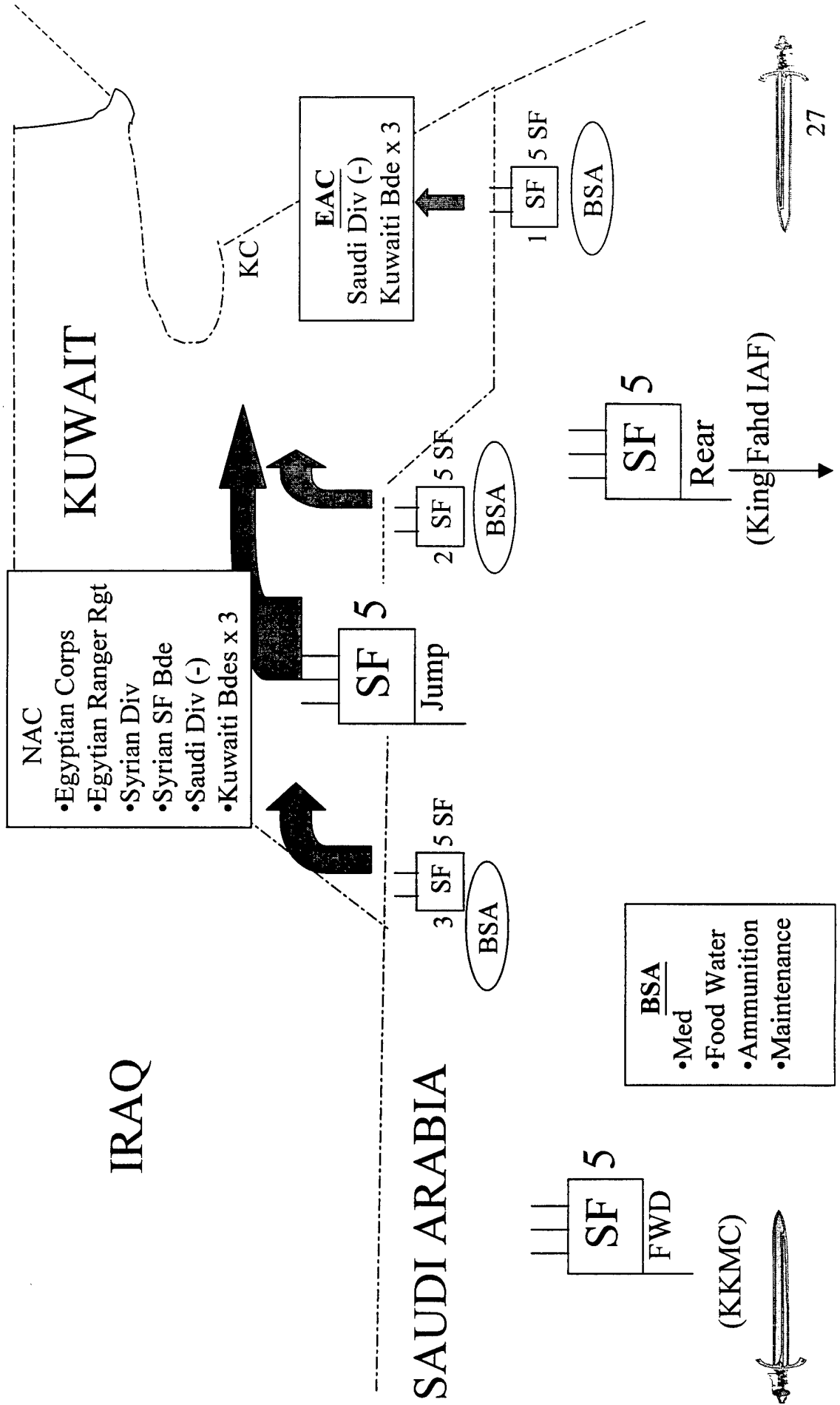

Coalition Support

- Close Air Support
 - Active
 - Passive
- Navigation
- Command and Control
- Passage of lines
- CS/CSS



ARSOTF Activities Desert Storm

- REPORTING (Ground Truth)
 - LOCATION
 - ACTIVITIES
 - INTENTIONS
 - CAPABILITIES BY BOS
- Coordination with Adjacent Units
- Counter Revenge Measures

(109 Teams – down to battalion)



Obstacle Belts

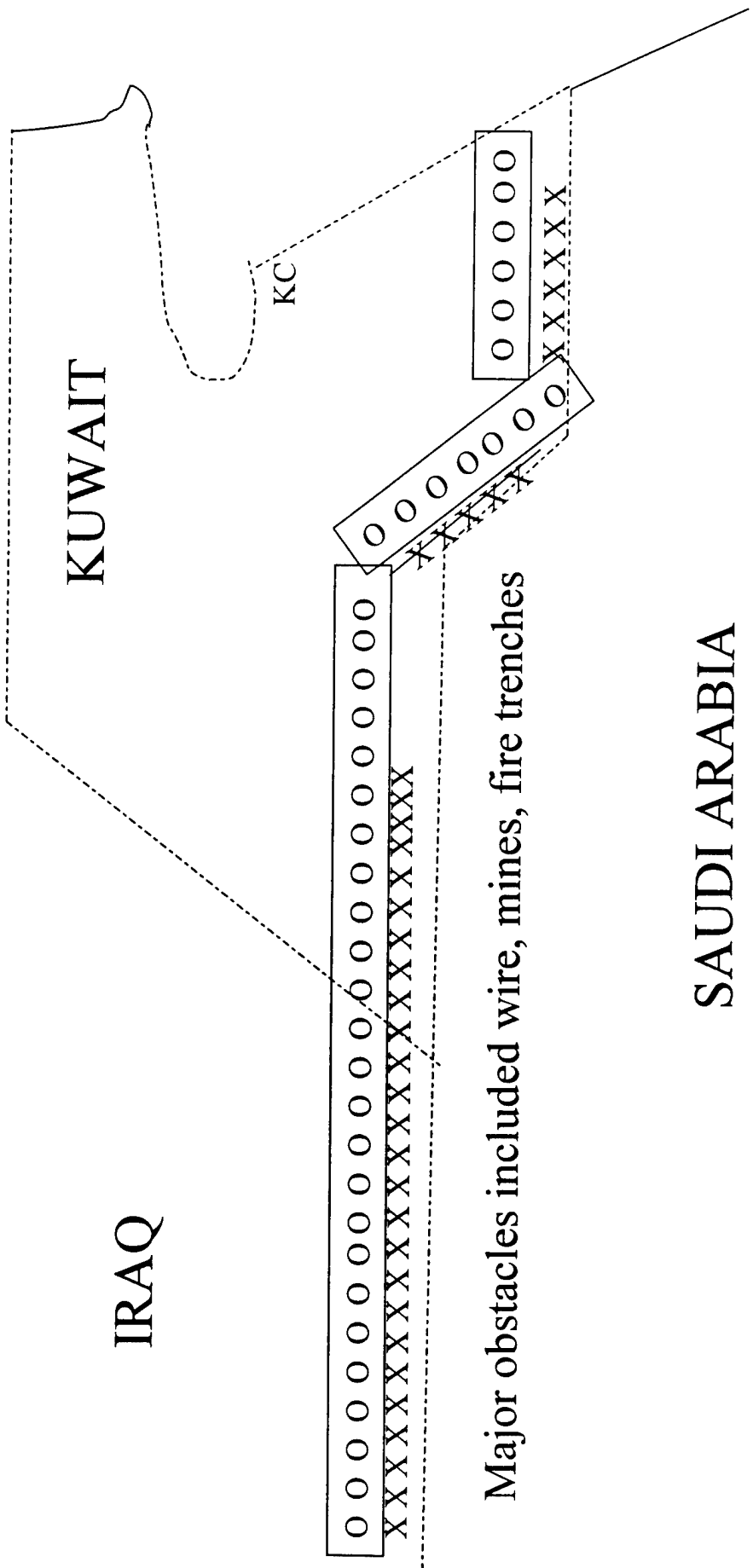

IRAQ

KUWAIT

KC

Major obstacles included wire, mines, fire trenches

SAUDI ARABIA

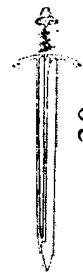

30



PanArab Forces

- Egyptian Corps
 - 2 x Div
 - RGR Rgt
- Syrian Div
 - 2 x Ar Bde
 - SF Rgt

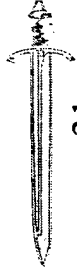
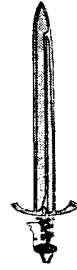

PanArab Forces (Cont)

- Saudi Forces
 - 6 Bdes
- Kuwaiti Forces
 - 6 Bdes
- Other
 - Omani
 - Bangladeshi
 - UAE



Special Reconnaissance

- Deep into Iraq
- Supported 2 x US Corps
- Mission to let Corps Commanders know of enemy movements in/out of AO

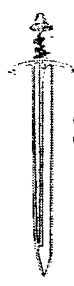

Combat Search and Rescue

- 3 – 160 SOAR
- Placed SF Teams personnel on board to:
 - Provide local security at suspected pickup point
 - Search for downed aviator
 - Assist downed pilot to aircraft, if injured
- Picked up one AF pilot



Combating Terrorism

- Ad Hoc mission
- Prepared and launched to assist US Embassy in Somalia

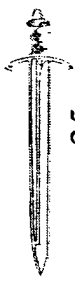

Direct Action

- Planned Destruction of Train carrying Missiles
- Laser designation operations
- Building clearing operations
- Combat operations



Civil Affairs

- Kuwait City Clearing Operations: non-combatants
 - Established evacuation routes
 - Established collection points
 - Established assembly areas
- Established food/water distribution points in KC
- Distributed food/water to noncombatants
- 352 Civil Affairs Group handled majority of CA missions



Other Issues

- Emphasis on not taking revenge against real or suspected collaborators
- Counter fratricide measures



Psychological Operations

- Loudspeaker Operations
- Theme Development
- Leaflet Testing
- 4th POG handled the bulk of PsyOps



Other Special Operations

- SCUD Hunting
- Downed Pilot Recovery (N. Iraq)

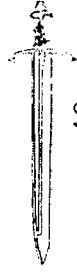

Lessons Learned

- **SF are ideally suited for this mission (competent, resourceful, professional)**
- **Reliable communications are critical**
 - **More/simpler/PTT radios (throw aways) need to be developed**
 - **Need to explore common communications systems**
- **Intelligence sharing requires a lot of imagination**
- **Maps are not available to all players**
- **Development of a set of basic individual and collective tasks for coalition partners are a must**



PROGRAMS AND TECHNOLOGIES FOR FUTURE CHALLENGES



SPECIAL OPERATIONS
ACQUISITION EXECUTIVE

MR. HARRY SCHULTE

13 FEBRUARY 2001



TECHNOLOGY AREAS

- Air, Land, Sea, Space Systems
- Biomedical
- Chem/Bio Defense and Nuclear
- Computing/Modelling & Simulation
- Command, Control, and Communications
- Human Systems
- Information Operations



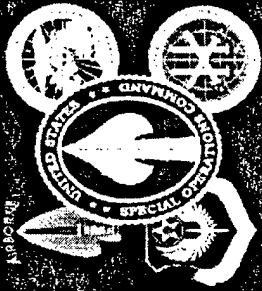

TECHNOLOGY AREAS

- **Materials/Processes**
- **Weapons/Munitions/Directed Energy**
- **Sensors, Electronics, Battlespace Environment**
- **Power Sources**

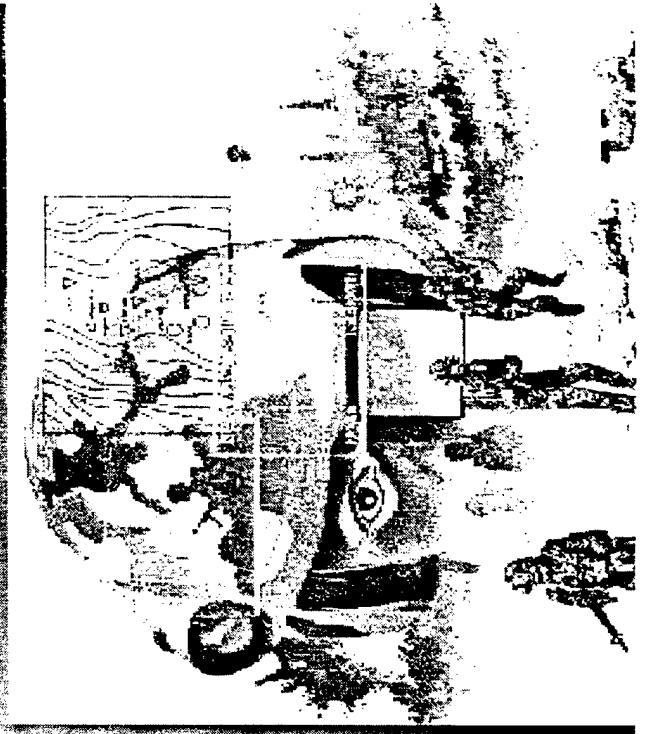



TECHNOLOGY AREA

Air, Land, Sea, Space Systems



Capabilities/Areas of Concern:

- Conduct undetectable ground, sea, air, and space mobility operations
- Longer range/global response projection and protection from threats
- Interface and operate within the space surveillance network including UAV networks

Projects:

- Reduced Signature
- Active Noise Cancellation
- Millimeter Wave Electronic Technology
- Improved Special Operations Craft

TECHNOLOGY AREA

Biomedical



Capabilities/Areas of Concern:

- Hemorrhage control techniques
- Resuscitation fluids
- Card diagnostics
- Combat casualty care devices
- Medical planning tools
- Electronic med ref system

Projects:

- Injectable Hemostatic Drugs
- Casualty Evacuation
- Casualty Retrieval Device
- Enhancement of SO Training using Human Simulators
- Operational Medicine CD ROM



TECHNOLOGY AREA

Chemical, Biological Defense and Nuclear

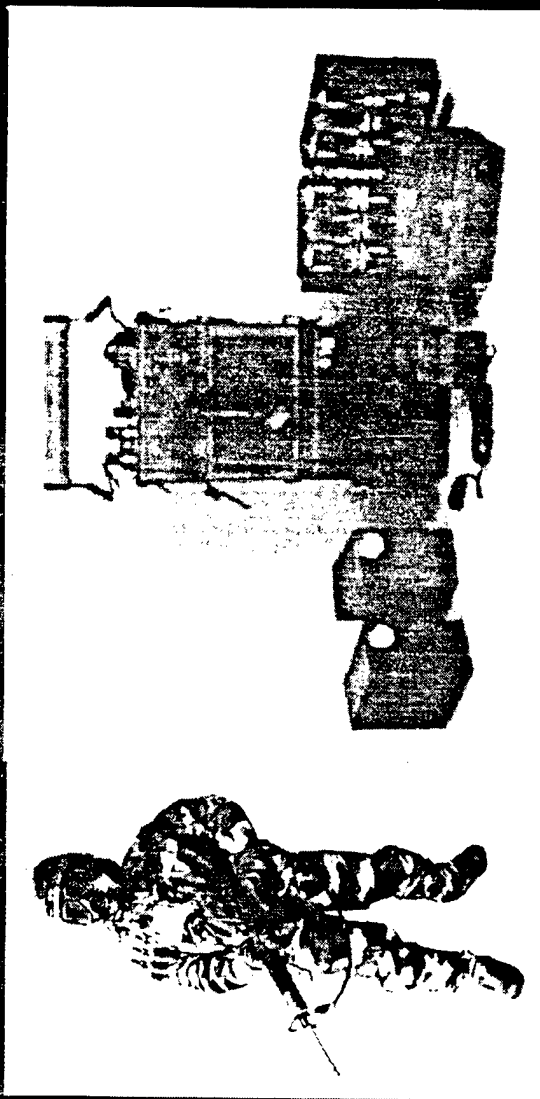
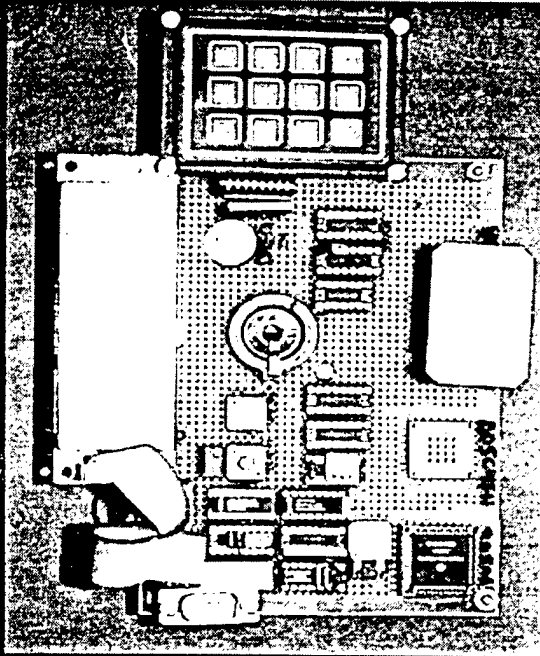

Capabilities/Areas of Concern:

- Detect, discriminate, identify NBC material at standoff ranges
- Detect WMD-specific means of delivery and infrastructure
- Destroy and/or neutralize WMD
- Handle, containerize, and transport WMD and NBC material

Projects:

- Hand-Portable Waterless Decontamination System
- Advanced Lightweight NBC Protective Clothing
- Advanced Chemical Alarm

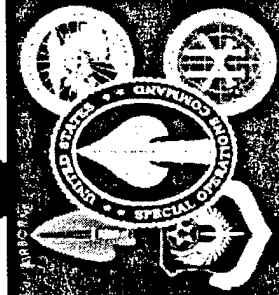

TECHNOLOGY AREA

Computing/Modeling & Simulation

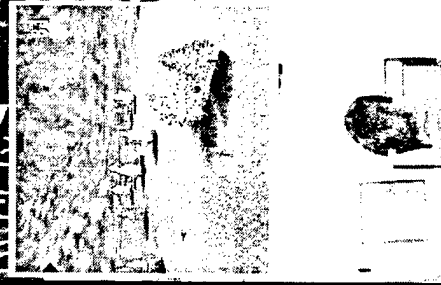
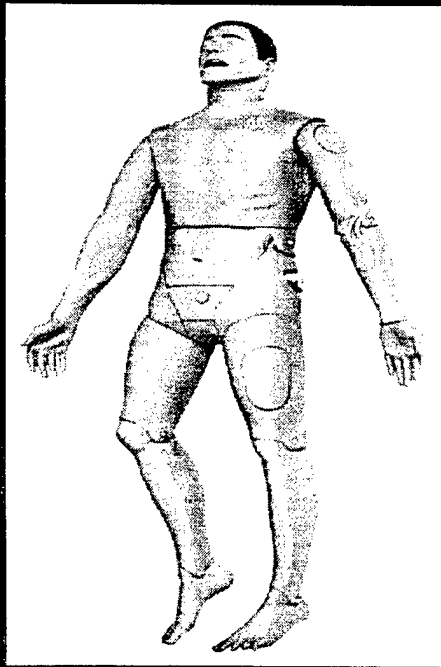

Capabilities/Areas of Concern:

- Systems will need to accommodate excursions for simulation, rehearsal, and training
- Provide user-friendly portable, medical reference software and databases

• SIE-supporting technologies

25-JAN-01

Projects:

- Human Patient Simulators
- Tactical Simulator for SOF
- Advanced SO Planning & Rehearsal Parachute Simulation
- Cognitive Learning Strategies for SOF

SOAL-T

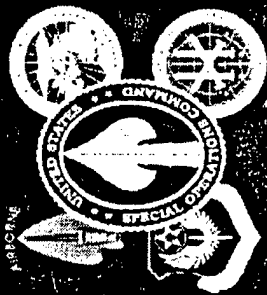

TECHNOLOGY AREA

Command, Control, and Communications

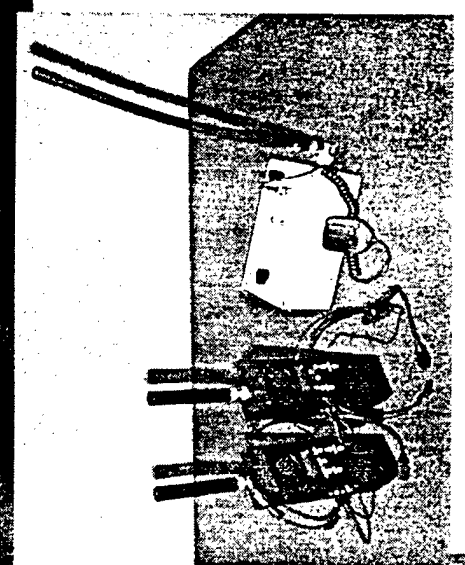
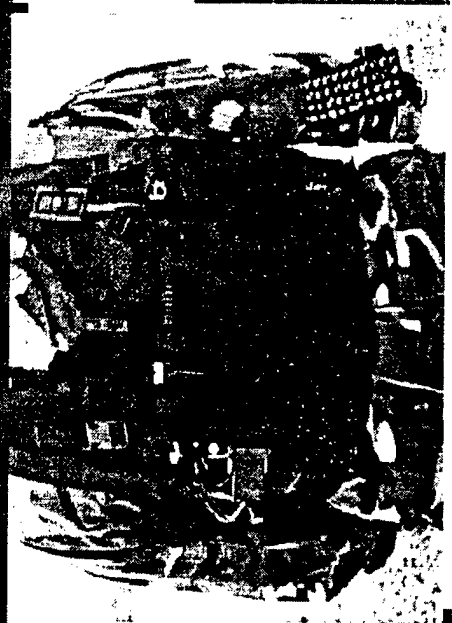
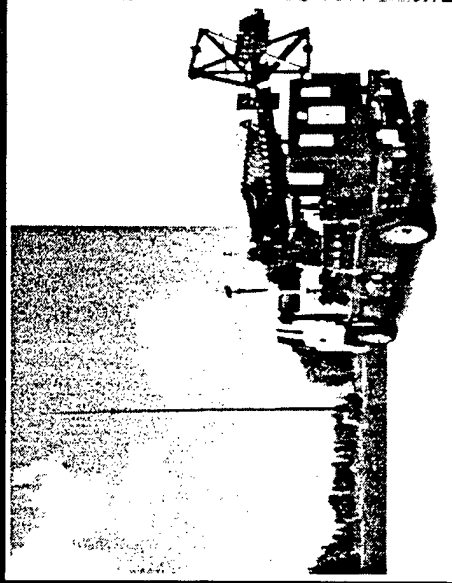

Capabilities/Areas of Concern:

- Uninterrupted information exchange
- Embedded COMSEC and sensor integration
- Automated comms & mission mgt
- Share large amounts of data in real-time

Projects:

- Antenna Enhancements
- Tactical Personal Computer
- LPI/LPD Imagery Link
- PSYOP Broadcast System
- Undersea Communications Node



TECHNOLOGY AREA

Human Systems

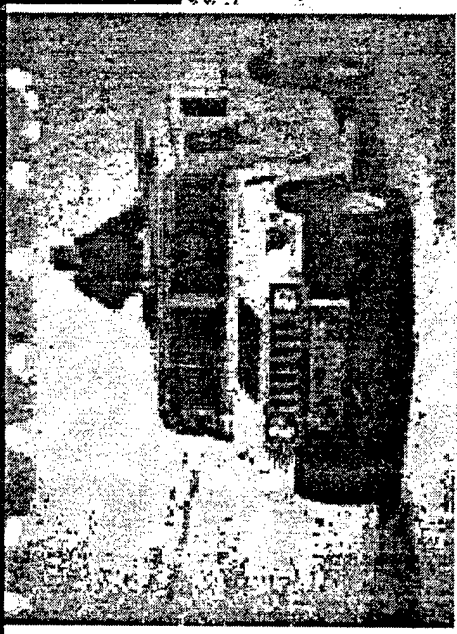
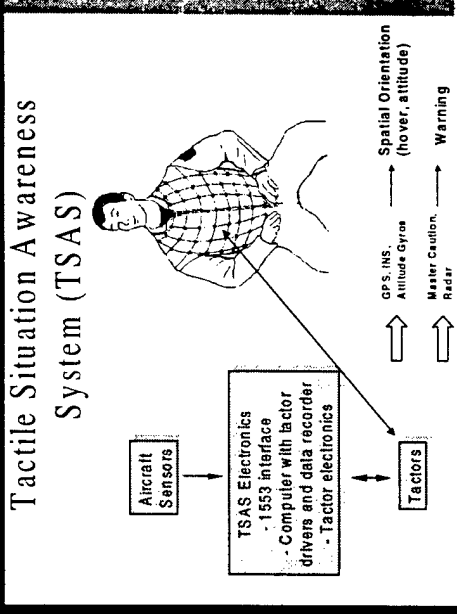

Capabilities/Areas of Concern:

- Improve survivability of personnel conducting special operations
- Enhance performance, sustainment, and situational awareness

Projects:

- Tactile Situation Awareness System
- NVEO Enhancements
- Advanced Technology Exposure Suit
- SOF Tactical Decision Aids

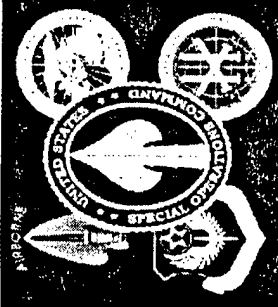

TECHNOLOGY AREA

Information Operations

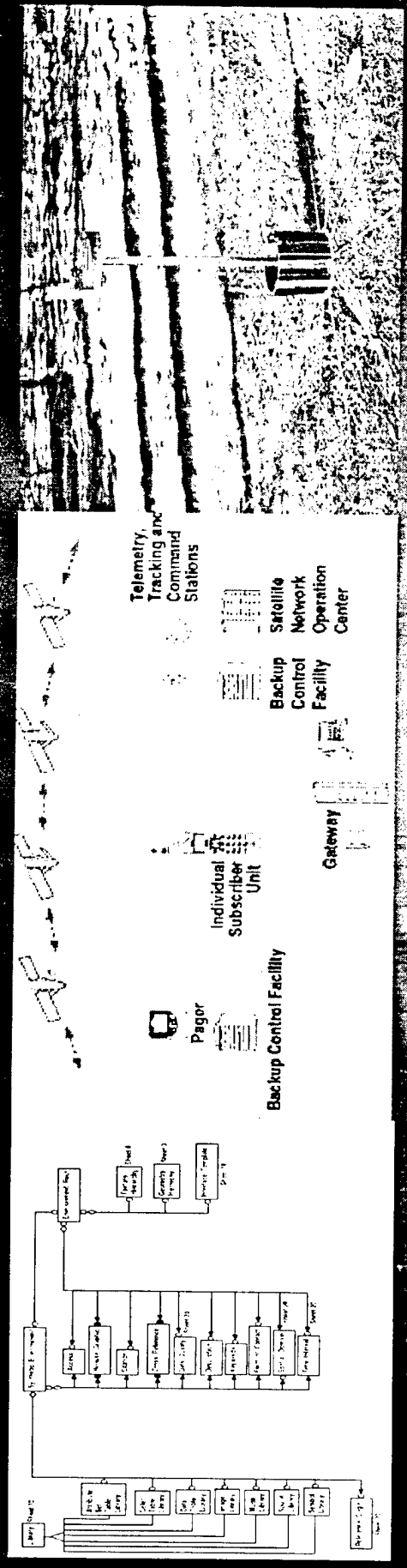

Capabilities/Areas of Concern:

- Reduce adversary's ability to use information and influence situations to support mission
- Ensure all measures of defense to protect systems
- Network PSYOP systems
- SIE-supporting technologies

Projects:

- Database Conversion Software
- Emergency Locator Transmitter Devices
- Remote Miniature Weather Station
- Burst Communications & LPD Antenna

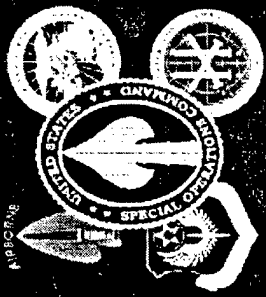

TECHNOLOGY AREA

Materials/Processes

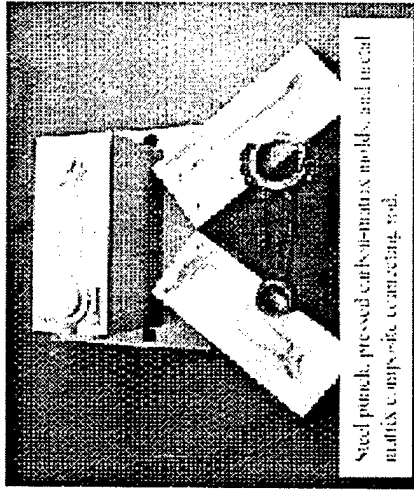
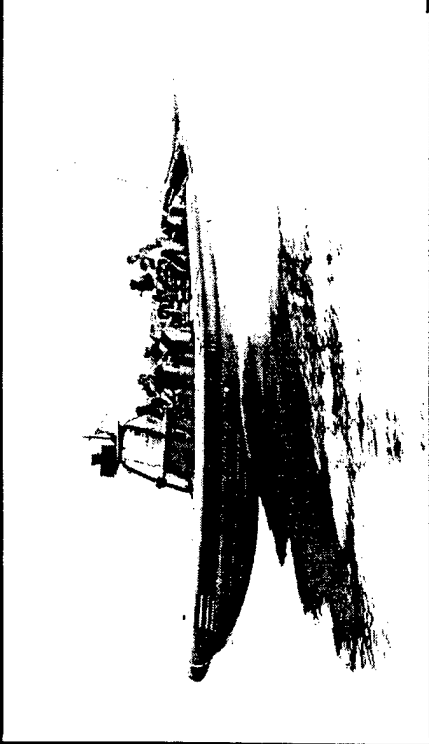

Steel punch, pressed carbon-fiber matrix composites.

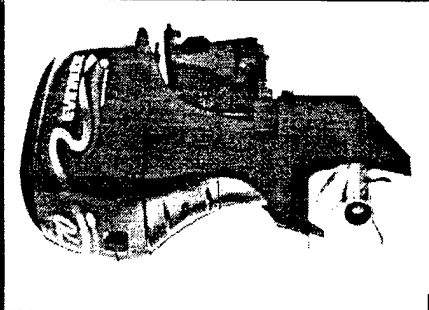

Capabilities/Areas of Concern:

- Take advantage of advanced materials and processes to produce lighter, faster, and stronger systems while reducing the acoustic, magnetic, and visual image of the system

Projects:

- Maritime Ballistic Protection
- Advanced Propulsion System
- Emerging Outboard Engine Technology
- Signature Evaluation of Composite Engine

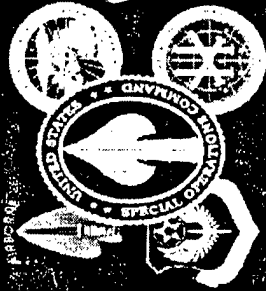

TECHNOLOGY AREA

Weapons, Munitions, Directed Energy

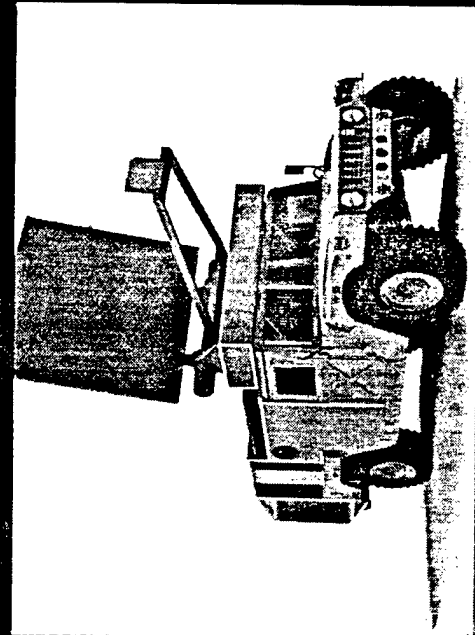
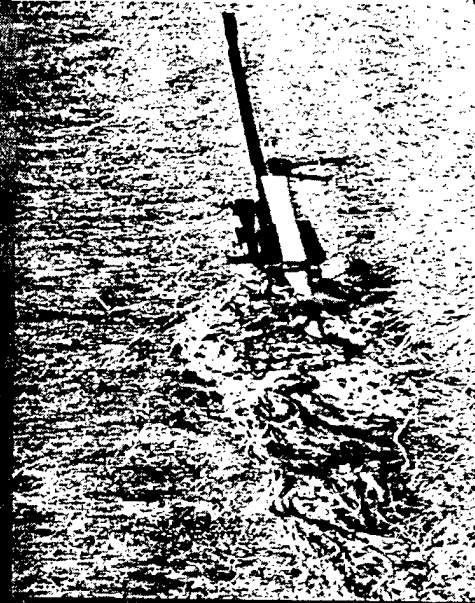

Capabilities/Areas of Concern:

- Multirole/multipurpose weapons with target discrimination
- Ability to produce a broader range of effects, from non-lethal to hard target kill
- Precision guidance and non-line-of-sight capability

Projects:

- AC-130 105mm Smart Round
- Anti-Material Payload Rifle
- Active Denial Technology, and HPM
- Remote Sighting System for Weapons
- Shoulder Fire Smart Round

TECHNOLOGY AREA

Sensors, Electronics, Battlespace

Environment

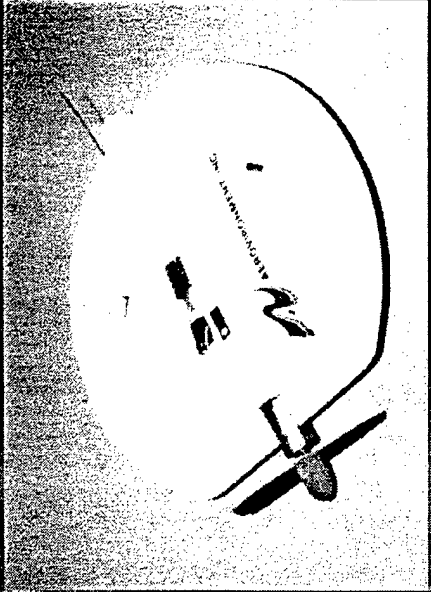
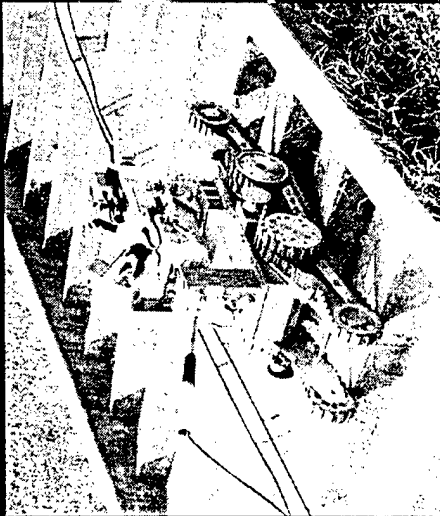
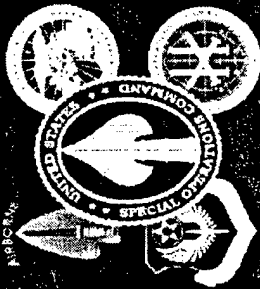

Capabilities/Areas of Concern:

- Significantly enhance human sensory functions
- See through walls, foliage, soil, and severe weather
- Near-total situational awareness
- Detecting, classifying, locating, and cueing other systems

Projects:

- Minaturized Robotics
- Remotely Monitored Battlefield Sensor Technology
- Micro Unmanned Vehicles
- Radar Sensor for Wide Area Surv



TECHNOLOGY AREA

Power Sources

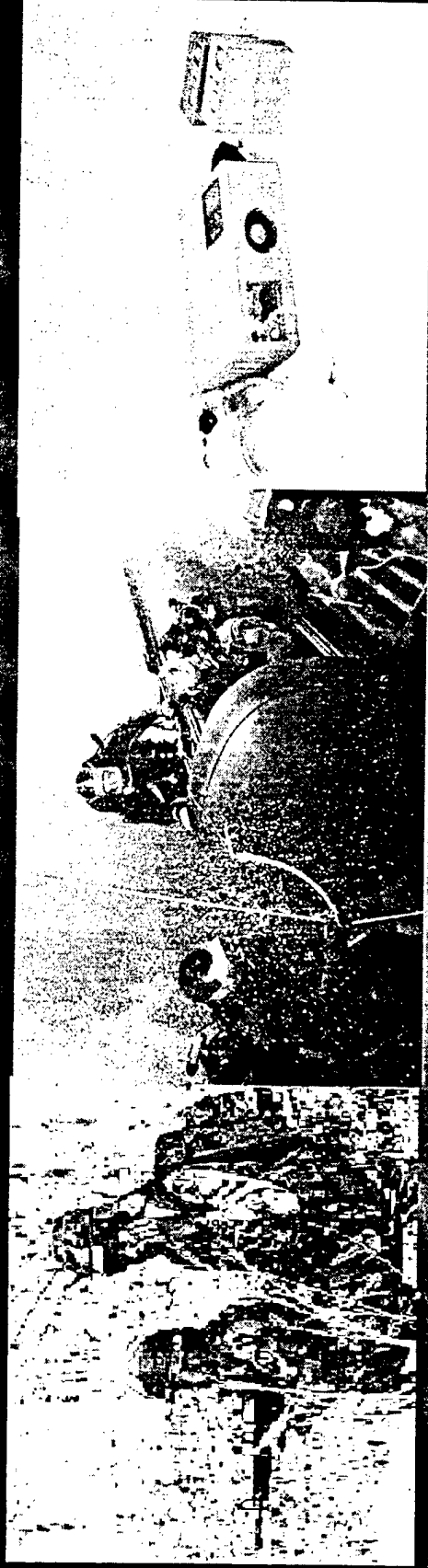

Capabilities/Areas of Concern:

- Power sources and power management for man-portable systems in remote operations
- Reduce size, number, and weight of power sources

Projects:

- State of Battery Health Test Set for SOF Equipment Batteries
- Battery Recharging System
- Power Source for ASDS/SDV



FUTURE CHALLENGES

- Unconventional Threats and Missions
- Special Operations Forces More Involved Day by Day Executing NMS
- Smaller, Lighter, Better—Not a Slogan
- Increased Dependence on Industry
 - Cost Constrained Environment
 - Utilization of COTS Components
 - Key Technologies Developed by Industry
 - Performance is the Warfighter's Concern



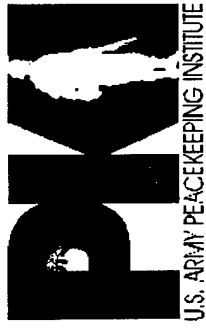

COMBINED SOF IN PEACE OPERATIONS

14 February 2001

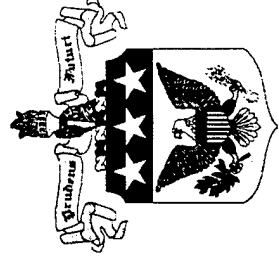

OVERVIEW

- ◆ **ADVANTAGES & DISADVANTAGES**
- ◆ **BASIC DOCTRINE ISSUES**
- ◆ **PROPOSED WAY AHEAD**

BASIC ASSUMPTION

- ◆ **COMBINED SPEC OPS ARE BEING CONDUCTED NOW**
- ◆ **COMBINED SOF WILL BE A FACTOR IN FUTURE ENGAGEMENTS**

BALANCE SHEET

- ◆ ADVANTAGES
 - POLITICAL
 - COMMITMENT
 - ACCESS
 - KNOWLEDGE
 - SKILLS
 - FLEXIBILITY
 - MISSION
 - COVERAGE
- ◆ DISADVANTAGES
 - MULTI-C2
 - ✦ RED CARD
 - INTEGRATION
 - TECHNICAL GAP
 - RESOURCE GAP
 - ABILITY GAP

POLICY AND DOCTRINAL ISSUES

- ◆ **LEAD NATION**
- ◆ **UNI-NATIONAL TACTICAL OPS**
- ◆ **EMPLOYMENT PARAMETERS**
- ◆ **INTELLIGENCE SHARING**
- ◆ **COMPARTMENTED OPS**
- ◆ **INFORMATION OPS**
- ◆ **INTERAGENCY/ CIVIL INTERFACE**

WAY AHEAD

- ◆ **DEVELOP DOCTRINE**
- ◆ **DEVELOP DATA BASE**
- ◆ **CONDUCT MULTINATIONAL
FORCE DEVELOPMENT**
- ◆ **DEVELOP BASIC PROCEDURES**
- ◆ **FOCUS ON C4I INTEROPERABILITY**

PAKE

U.S. ARMY PEACEKEEPING INSTITUTE

Serving the U.S. Military in the Interest of Peace

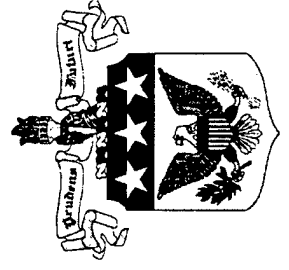

100 Best Novels

The board's list

The reader's list

- | | |
|-----------------------------------------------------------|-----------------------------------------------------|
| 1. ULYSSES by James Joyce | 1. ATLAS SHRUGGED by Ayn Rand |
| 2. THE GREAT GATSBY by F. Scott Fitzgerald | 2. THE FOUNTAINHEAD by Ayn Rand |
| 3. A PORTRAIT OF THE ARTIST AS A YOUNG MAN by James Joyce | 3. BATTLEFIELD EARTH by L. Ron Hubbard |
| 4. LOLITA by Vladimir Nabokov | 4. THE LORD OF THE RINGS by J.R.R. Tolkien |
| 5. BRAVE NEW WORLD by Aldous Huxley | 5. TO KILL A MOCKINGBIRD by Harper Lee |
| 6. THE SOUND AND THE FURY by William Faulkner | 6. 1984 by George Orwell |
| 7. CATCH-22 by Joseph Heller | 7. ANTHEM by Ayn Rand |
| 8. DARKNESS AT NOON by Arthur Koestler | 8. WE THE LIVING by Ayn Rand |
| 9. SONS AND LOVERS by D.H. Lawrence | 9. MISSION EARTH by L. Ron Hubbard |
| 10. THE GRAPES OF WRATH by John Steinbeck | 10. FEAR by L. Ron Hubbard |
| 11. UNDER THE VOLCANO by Malcolm Lowry | 11. ULYSSES by James Joyce |
| 12. THE WAY OF ALL FLESH by Samuel Butler | 12. CATCH-22 by Joseph Heller |
| 13. 1984 by George Orwell | 13. THE GREAT GATSBY by F. Scott Fitzgerald |
| 14. I, CLAUDIUS by Robert Graves | 14. DUNE by Frank Herbert |
| 15. TO THE LIGHTHOUSE by Virginia Woolf | 15. THE MOON IS A HARSH MISTRESS by Robert Heinlein |

16. AN AMERICAN TRAGEDY by Theodore Dreiser
17. THE HEART IS A LONELY HUNTER by Carson McCullers
18. SLAUGHTERHOUSE-FIVE by Kurt Vonnegut
19. INVISIBLE MAN by Ralph Ellison
20. NATIVE SON by Richard Wright
21. HENDERSON THE RAIN KING by Saul Bellow
22. APPOINTMENT IN SAMARRA by John O'Hara
23. U.S.A. (trilogy) by John Dos Passos
24. WINESBURG, OHIO by Sherwood Anderson
25. A PASSAGE TO INDIA by E.M. Forster
26. THE WINGS OF THE DOVE by Henry James
27. THE AMBASSADORS by Henry James
28. TENDER IS THE NIGHT by F. Scott Fitzgerald
29. THE STUDS LONIGAN TRILOGY by James T. Farrell
30. THE GOOD SOLDIER by Ford Madox Ford
31. ANIMAL FARM by George Orwell
32. THE GOLDEN BOWL by Henry James
33. SISTER CARRIE by Theodore Dreiser
34. A HANDFUL OF DUST by Evelyn Waugh
16. STRANGER IN A STRANGE LAND by Robert Heinlein
17. A TOWN LIKE ALICE by Nevil Shute
18. BRAVE NEW WORLD by Aldous Huxley
19. THE CATCHER IN THE RYE by J.D. Salinger
20. ANIMAL FARM by George Orwell
21. GRAVITY'S RAINBOW by Thomas Pynchon
22. THE GRAPES OF WRATH by John Steinbeck
23. SLAUGHTERHOUSE FIVE by Kurt Vonnegut
24. GONE WITH THE WIND by Margaret Mitchell
25. LORD OF THE FLIES by William Golding
26. SHANE by Jack Schaefer
27. TRUSTEE FROM THE TOOLROOM by Nevil Shute
28. A PRAYER FOR OWEN MEANY by John Irving
29. THE STAND by Stephen King
30. THE FRENCH LIEUTENANT'S WOMAN by John Fowles
31. BELOVED by Toni Morrison
32. THE WORM OUROBOROS by E.R. Eddison
33. THE SOUND AND THE FURY by William Faulkner
34. LOLITA by Vladimir Nabokov

35. AS I LAY DYING by William Faulkner
35. MOONHEART by Charles de Lint
36. ALL THE KING'S MEN by Robert Penn Warren
36. ABSALOM, ABSALOM! by William Faulkner
37. THE BRIDGE OF SAN LUIS REY by Thornton Wilder
37. OF HUMAN BONDAGE by W. Somerset Maugham
38. HOWARDS END by E.M. Forster
38. WISE BLOOD by Flannery O'Connor
39. GO TELL IT ON THE MOUNTAIN by James Baldwin
39. UNDER THE VOLCANO by Malcolm Lowry
40. THE HEART OF THE MATTER by Graham Greene
40. FIFTH BUSINESS by Robertson Davies
41. LORD OF THE FLIES by William Golding
41. SOMEPLACE TO BE FLYING by Charles de Lint
42. DELIVERANCE by James Dickey
42. ON THE ROAD by Jack Kerouac
43. A DANCE TO THE MUSIC OF TIME (series) by Anthony Powell
43. HEART OF DARKNESS by Joseph Conrad
44. POINT COUNTER POINT by Aldous Huxley
44. YARROW by Charles de Lint
45. THE SUN ALSO RISES by Ernest Hemingway
45. AT THE MOUNTAINS OF MADNESS by H.P. Lovecraft
46. THE SECRET AGENT by Joseph Conrad
46. ONE LONELY NIGHT by Mickey Spillane
47. NOSTROMO by Joseph Conrad
47. MEMORY AND DREAM by Charles de Lint
48. THE RAINBOW by D.H. Lawrence
48. TO THE LIGHTHOUSE by Virginia Woolf
49. WOMEN IN LOVE by D.H. Lawrence
49. THE MOVIEGOER by Walker Percy
50. TROPIC OF CANCER by Henry Miller
50. TRADER by Charles de Lint
51. THE NAKED AND THE DEAD by Norman Mailer
51. THE HITCHHIKER'S GUIDE TO THE GALAXY by Douglas Adams
52. PORTNOY'S COMPLAINT by Philip Roth
52. THE HEART IS A LONELY HUNTER by Carson McCullers
53. PALE FIRE by Vladimir Nabokov
53. THE HANDMAID'S TALE by

54. LIGHT IN AUGUST by William Faulkner
Margaret Atwood
54. BLOOD MERIDIAN by Cormac McCarthy
55. ON THE ROAD by Jack Kerouac
55. A CLOCKWORK ORANGE by Anthony Burgess
56. THE MALTESE FALCON by Dashiell Hammett
56. ON THE BEACH by Nevil Shute
57. PARADE'S END by Ford Madox Ford
57. A PORTRAIT OF THE ARTIST AS A YOUNG MAN by James Joyce
58. THE AGE OF INNOCENCE by Edith Wharton
58. GREENMANTLE by Charles de Lint
59. ZULEIKA DOBSON by Max Beerbohm
59. ENDER'S GAME by Orson Scott Card
60. THE MOVIEGOER by Walker Percy
60. THE LITTLE COUNTRY by Charles de Lint
61. DEATH COMES FOR THE ARCHBISHOP by Willa Cather
61. THE RECOGNITIONS by William Gaddis
62. FROM HERE TO ETERNITY by James Jones
62. STARSHIP TROOPERS by Robert Heinlein
63. THE WAPSHOT CHRONICLES by John Cheever
63. THE SUN ALSO RISES by Ernest Hemingway
64. THE CATCHER IN THE RYE by J.D. Salinger
64. THE WORLD ACCORDING TO GARP by John Irving
65. A CLOCKWORK ORANGE by Anthony Burgess
65. SOMETHING WICKED THIS WAY COMES by Ray Bradbury
66. OF HUMAN BONDAGE by W. Somerset Maugham
66. THE HAUNTING OF HILL HOUSE by Shirley Jackson
67. HEART OF DARKNESS by Joseph Conrad
67. AS I LAY DYING by William Faulkner
68. MAIN STREET by Sinclair Lewis
68. TROPIC OF CANCER by Henry Miller
69. THE HOUSE OF MIRTH by Edith Wharton
69. INVISIBLE MAN by Ralph Ellison
70. THE ALEXANDRIA QUARTET by Lawrence Durrell
70. THE WOOD WIFE by Terri Windling
71. A HIGH WIND IN JAMAICA by
71. THE MAGUS by John Fowles

- Richard Hughes
72. A HOUSE FOR MR BISWAS by V.S. Naipaul
73. THE DAY OF THE LOCUST by Nathanael West
74. A FAREWELL TO ARMS by Ernest Hemingway
75. SCOOP by Evelyn Waugh
76. THE PRIME OF MISS JEAN BRODIE by Muriel Spark
77. FINNEGANS WAKE by James Joyce
78. KIM by Rudyard Kipling
79. A ROOM WITH A VIEW by E.M. Forster
80. BRIDESHEAD REVISITED by Evelyn Waugh
81. THE ADVENTURES OF AUGIE MARCH by Saul Bellow
82. ANGLE OF REPOSE by Wallace Stegner
83. A BEND IN THE RIVER by V.S. Naipaul
84. THE DEATH OF THE HEART by Elizabeth Bowen
85. LORD JIM by Joseph Conrad
86. RAGTIME by E.L. Doctorow
87. THE OLD WIVES' TALE by Arnold Bennett
88. THE CALL OF THE WILD by Jack London
89. LOVING by Henry Green
72. THE DOOR INTO SUMMER by Robert Heinlein
73. ZEN AND THE ART OF MOTORCYCLE MAINTENANCE by Robert Pirsig
74. I, CLAUDIUS by Robert Graves
75. THE CALL OF THE WILD by Jack London
76. AT SWIM-TWO-BIRDS by Flann O'Brien
77. FARENHEIT 451 by Ray Bradbury
78. ARROWSMITH by Sinclair Lewis
79. WATERSHIP DOWN by Richard Adams
80. NAKED LUNCH by William S. Burroughs
81. THE HUNT FOR RED OCTOBER by Tom Clancy
82. GUILTY PLEASURES by Laurell K. Hamilton
83. THE PUPPET MASTERS by Robert Heinlein
84. IT by Stephen King
85. V. by Thomas Pynchon
86. DOUBLE STAR by Robert Heinlein
87. CITIZEN OF THE GALAXY by Robert Heinlein
88. BRIDESHEAD REVISITED by Evelyn Waugh
89. LIGHT IN AUGUST by William Faulkner

90. MIDNIGHT'S CHILDREN by Salman Rushdie
91. TOBACCO ROAD by Erskine Caldwell
92. IRONWEED by William Kennedy
93. THE MAGUS by John Fowles
94. WIDE SARGASSO SEA by Jean Rhys
95. UNDER THE NET by Iris Murdoch
96. SOPHIE'S CHOICE by William Styron
97. THE SHELTERING SKY by Paul Bowles
98. THE POSTMAN ALWAYS RINGS TWICE by James M. Cain
99. THE GINGER MAN by J.P. Donleavy
100. THE MAGNIFICENT AMBERSONS by Booth Tarkington
90. ONE FLEW OVER THE CUCKOO'S NEST by Ken Kesey
91. A FAREWELL TO ARMS by Ernest Hemingway
92. THE SHELTERING SKY by Paul Bowles
93. SOMETIMES A GREAT NOTION by Ken Kesey
94. MY ANTONIA by Willa Cather
95. MULENGRO by Charles de Lint
96. SUTTREE by Cormac McCarthy
97. MYTHAGO WOOD by Robert Holdstock
98. ILLUSIONS by Richard Bach
99. THE CUNNING MAN by Robertson Davies
100. THE SATANIC VERSES by Salman Rushdie

100 Best: Novels List | [Nonfiction List](#) | [Rival List](#) | [Talking Points](#)

[Home](#) | [Classics](#) | [Series](#) | [Chronicles](#) | [Authors](#) | [ebooks](#) | [Search](#)

Copyright © 2000 Random House, Inc. All rights reserved.



COMBINED SPECIAL OPERATIONS IN KOREA



Purpose

**To provide an overview of
combined ROK/US
special operations in Korea**



Topics



- **Threat Overview**
- **SOCKOR / CUWTF Overview**
- **Combined Special Operations**



The Threat



A Willingness To Fight & Die



UNCLASSIFIED



nK Objectives

- Survival of the Regime



UNCLASSIFIED



nK Objectives

- Survival of the Regime
- Unify the Peninsula



SECRET/ROKUS



nK Objectives

- Survival of the Regime
- Unify the Peninsula
- International Recognition



nK Capability, Proximity and Mass.....

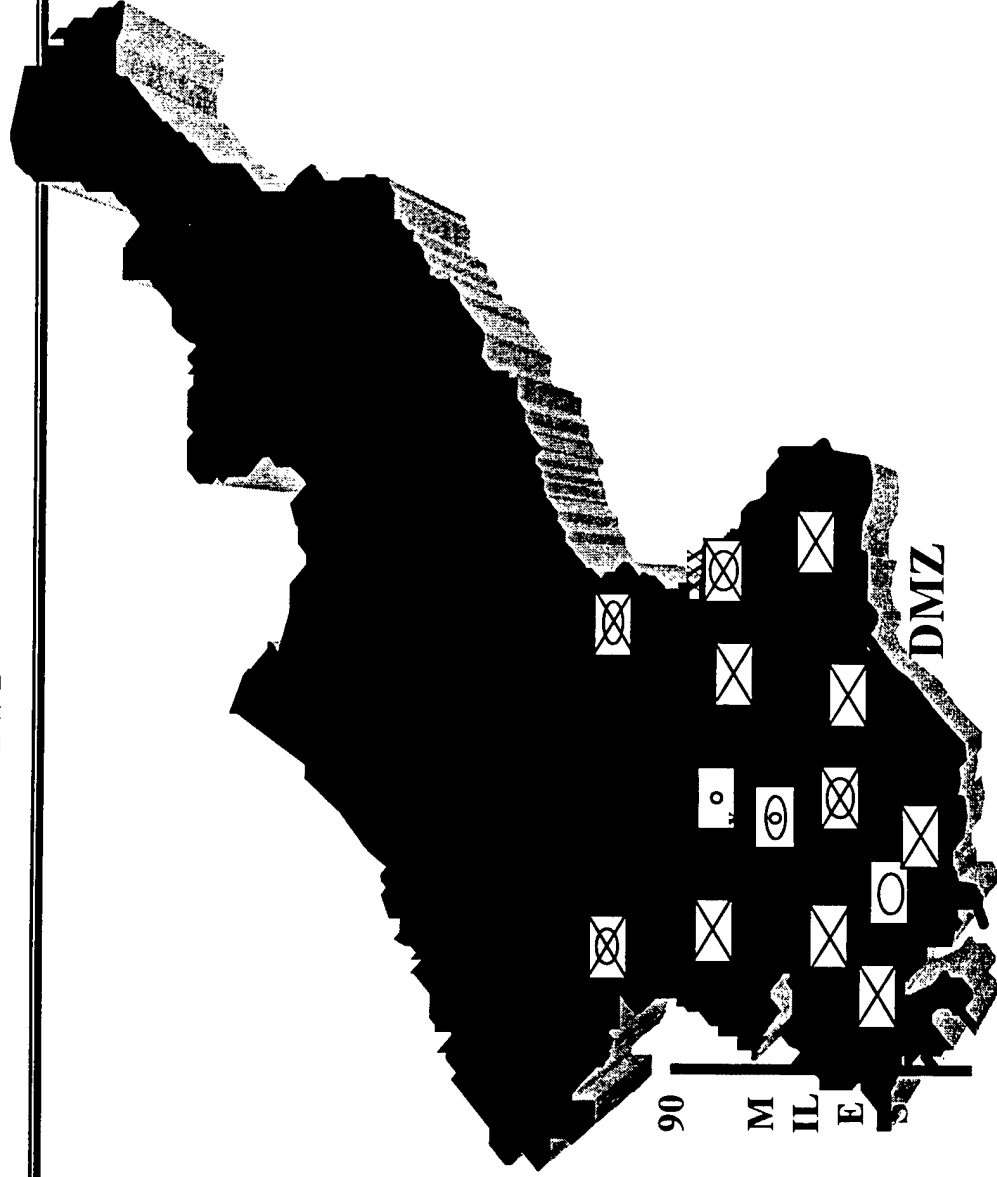

nK Asymmetric Capabilities



- **Special Operations Forces**
- **Weapons of Mass
Destruction**
- **Theater Ballistic Missiles**
- **Terrorism**

KOREAN THAW



WHERE WE HAVE BEEN

- FIRST EVER N-S SUMMIT BETWEEN N-S LEADERS
- FIRST EVER N-S DEFENSE MINISTERS MEETING
- RENEWED FAMILY REUNIONS - 1984



- RENEWED MINISTERS' MEETING

➤ 1972, 1992, 2000

- NEW N-S TRANSPORTATION CORRIDOR THROUGH DMZ

➤ MINE-CLEARING

- FIRST EVER TALKS BETWEEN US SEC STATE & NORTH KOREA'S LEADER



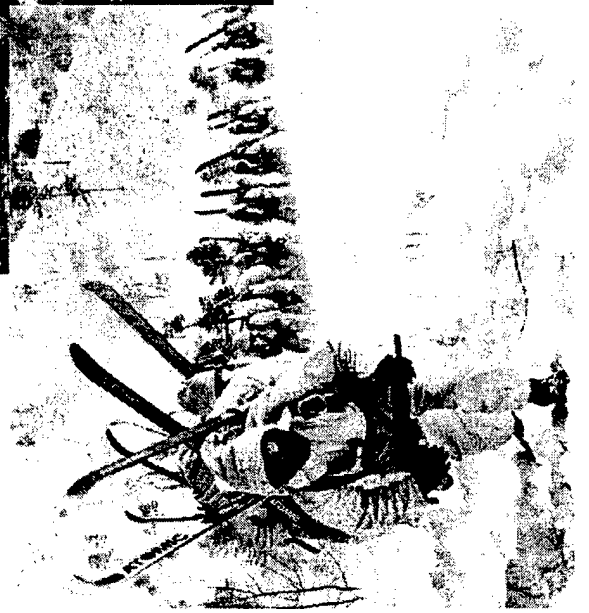

COMMUNICATIONS



Nested Command Structures

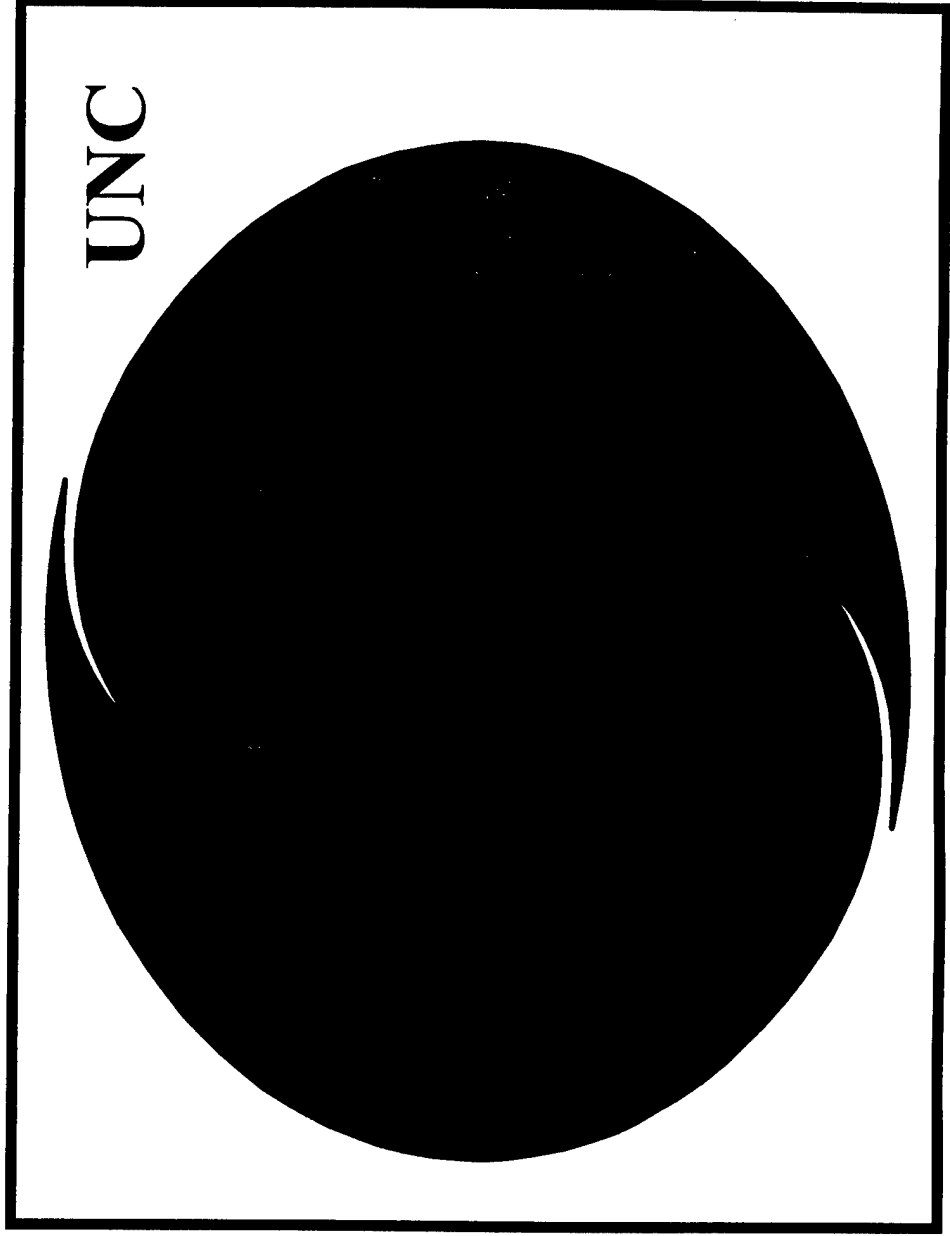



CUWTF Mission

- **On order, CUWTF supports CINCUNC/CFC in a phased defense of the ROK.**
- **Upon conclusion of hostilities, CUWTF forces will assist the restructuring plans of the ROK and US NCMAs**





ROK SOF to CUWTF

ROKAF

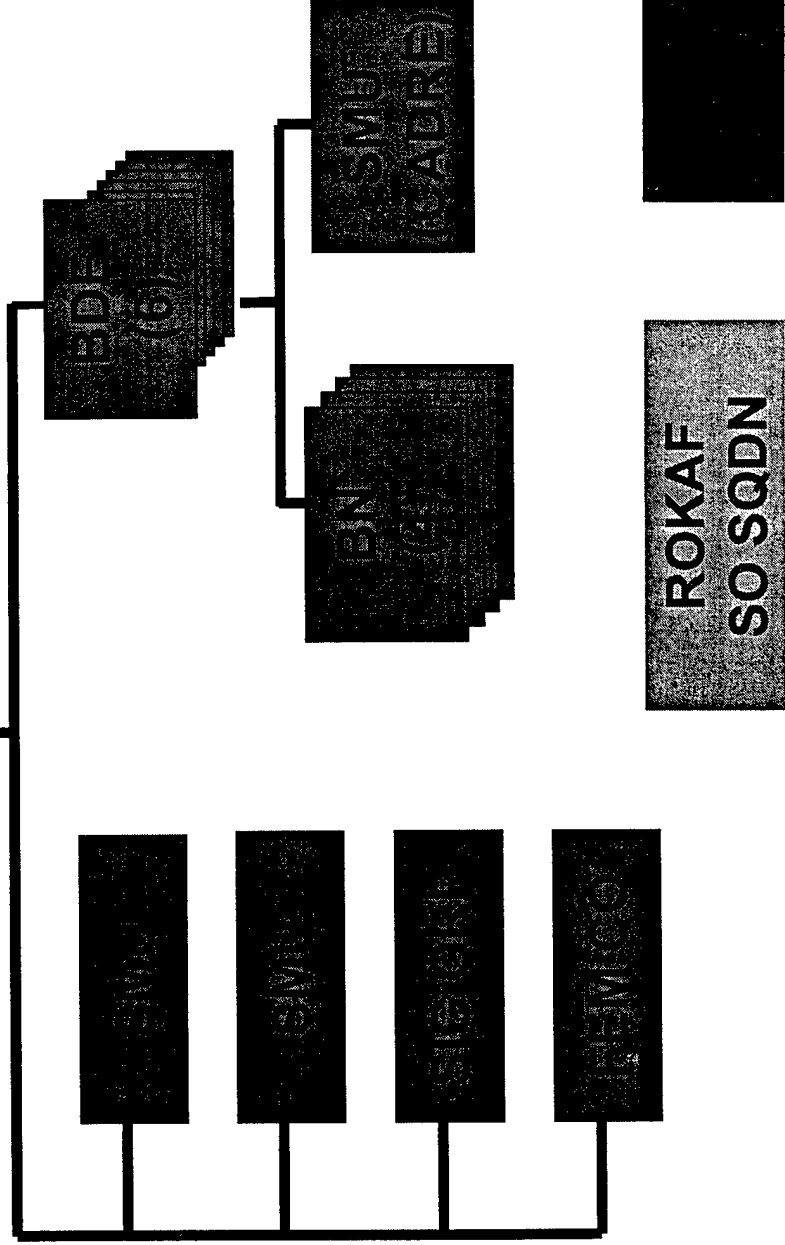

ROKAF
SO SQDN

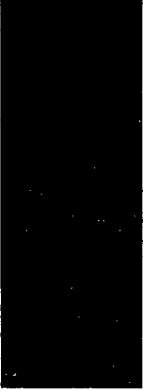



Parallel Staff Structure

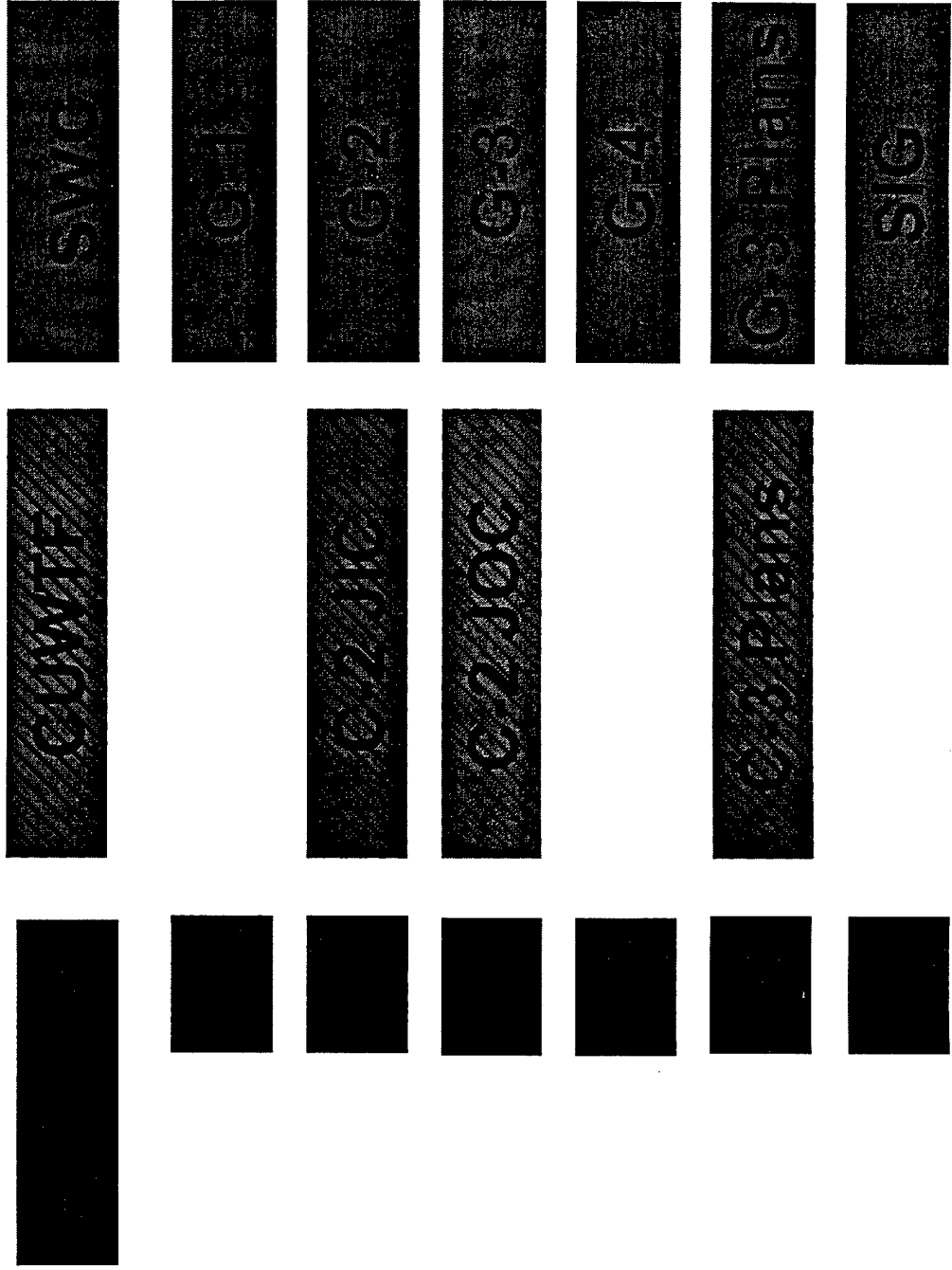



SECRET ROKUS

COMBAT EMPLOYMENT



DEEP

Create 2d Front
Disrupt reinforcing /
retreating KPA

"CLOSE"

Support Field Armies
(SR/DA)

KEY MISSIONS

Support CLF/CMEF
Deny sanctuary to KPA
SR/DA/TGO
UW Ops
PR

REAR

Support
Counter-SOF

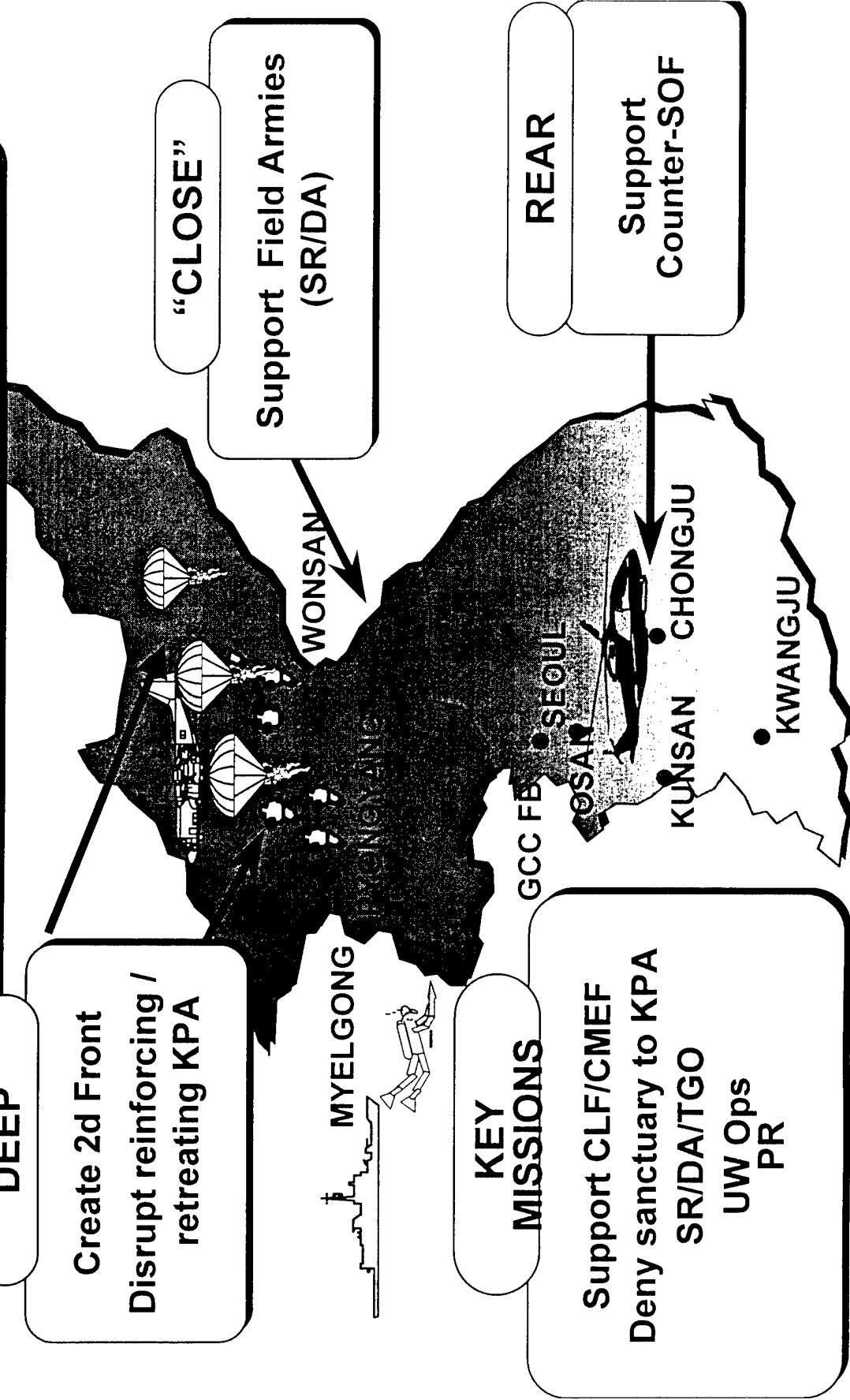

Combined SOF Key Tasks



- **SR/DA/TGO against targets of strategic and operational significance**
- **SOF LNOs at UNC/CFC Components, Field Armies, and ROK SF Brigades**
- **Unconventional Warfare focusing on separating the population from the regime**
- **Personnel Recovery**
- **Training, advising, assisting ROK forces in Rear Area Defense**

Key US SOF Tasks



- **As US Element of CUWTF, plan and conduct joint/combined SO in CINCUNC/CFC AOR**
- **As UNC SOF HQ, integrate Third Country SOF into theater organizations**
- **As SOCKOR, establish US JTF for COMUSKOREA**

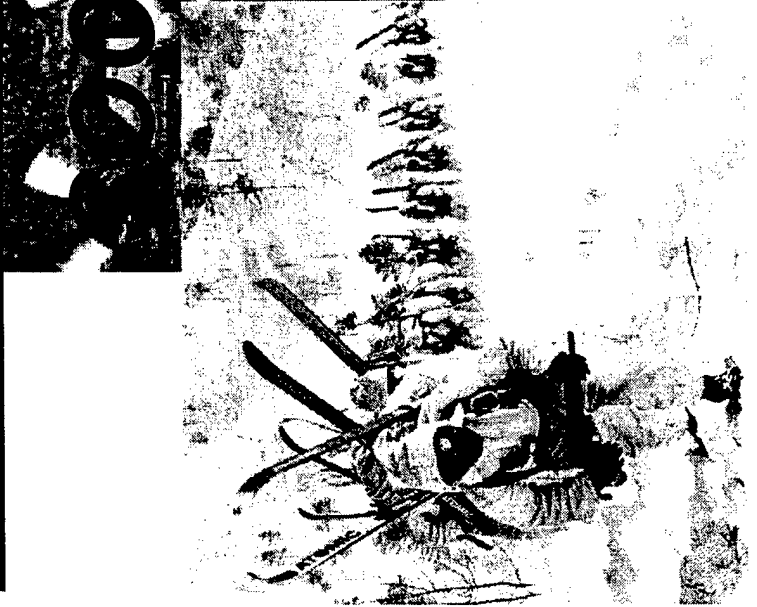

WOODROW WILSON

SOCKOR Organization Under USFK

Assigned Strength of 44 personnel

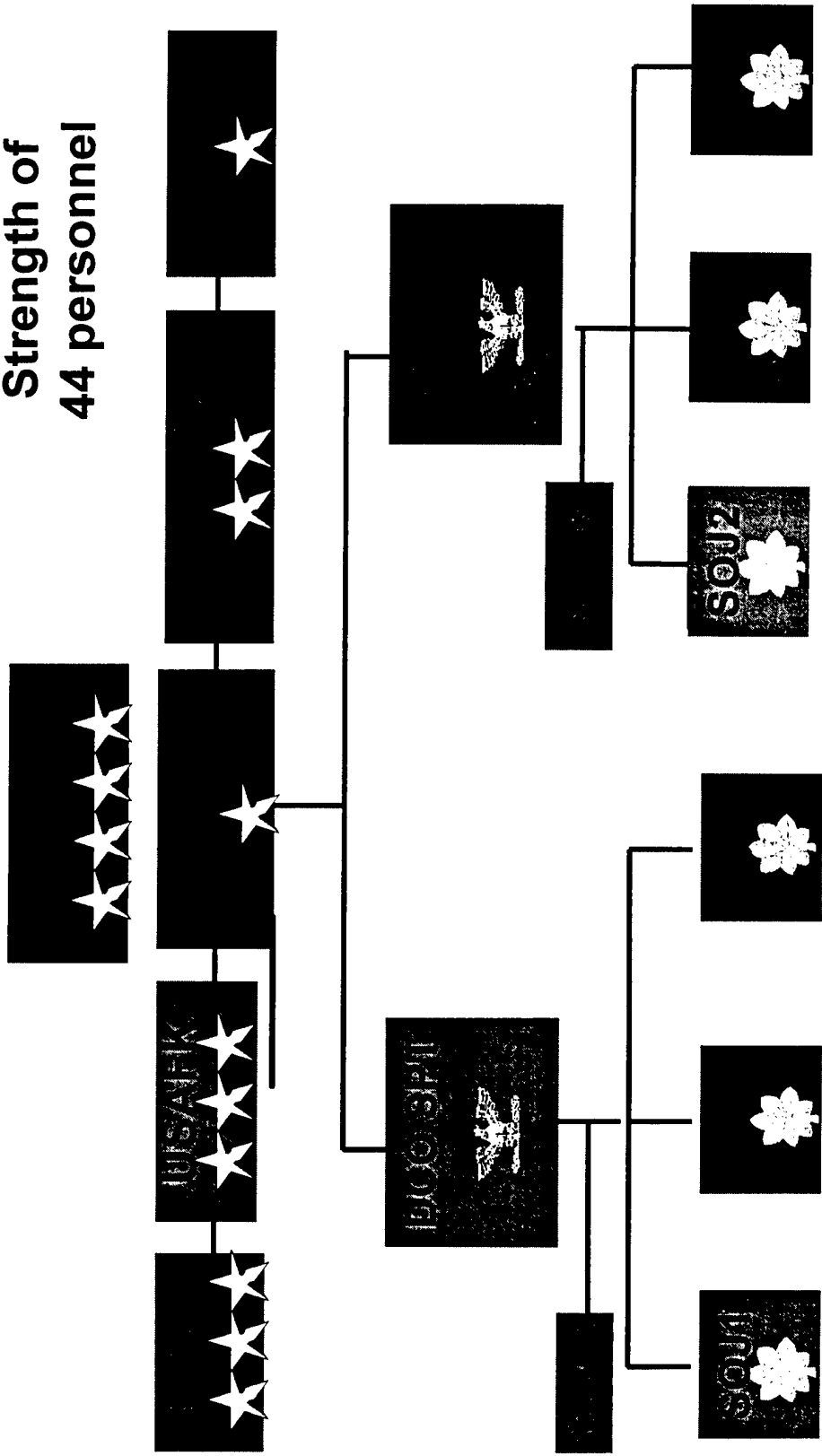

★ JTMD: Additional 434 Wartime Requirements

SOCKOR Mission



- **SOCKOR plans and conducts Special Operations, which include Psychological Operations, Civil Affairs, and selected collateral activities, in support of COMUSKOR / CINCUNC in armistice and crisis.**
- **On order, SOCKOR combines with ROK SOF to establish the CUWTF and conducts operations ISO CINCUNC/CFC**

Special Forces Detachment Korea (SFD-K)



- **Mission:** SFD-K enhances ROK/US interoperability by providing liaison between US SOF and ROK SF during armistice, crisis, and war.
- **Key Tasks:**
 - **Armistice:**
 - Advise and assist ROKA SF Brigades Interoperability
 - Coordinate US air support during armistice contingency / war:
 - Provide liaison: ROK SF, CJSOAC, UNC/CFC
 - Deconflict special operations



The Future

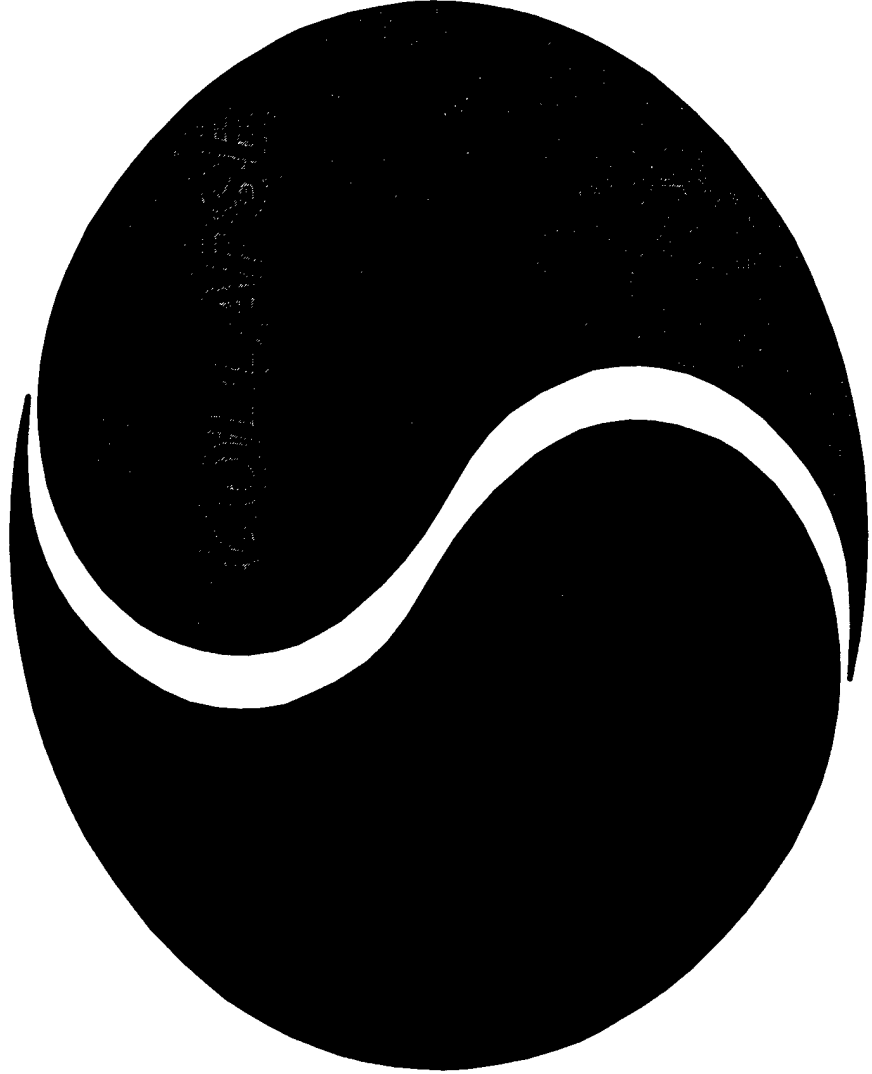

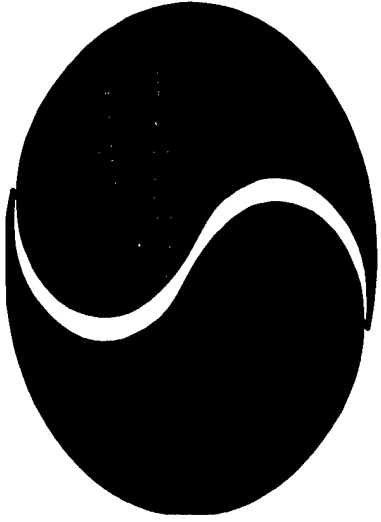

Challenges of a failed north Korea - Collapse or Post Hostilities

- Political - social - economic breakdown
- Violence and lawlessness
- Atrocities
- Refugees
- Humanitarian suffering
- Civil war & chaos
- Disposition of WMD/U XO



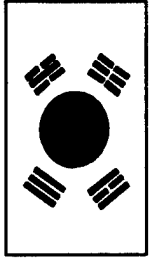

Emerging ROK SOF Vision



- **SOF will play a significant role in stabilizing and restoring north Korea following hostilities or a regime collapse**
 - **SOF is key to influencing the critical population factors**
 - **SOF must focus on the “human terrain”**
 - **SOF can help ensure internal stability**
- Maintain Future ROK SOF relevance***

Prepare Now

For an uncertain future



- Two threats on the Korean Peninsula
 - War and Collapse
- It is certain that some conflict will occur
 - ROK/US forces train for this certainty
- It is uncertain what post-hostilities or collapse will look like
 - ROK/US forces must educate for this uncertainty
- Uncertainty is complicated by the human element
- This is a niche for Combined SOF in Korea





Conclusion

- **North Korean situation is uncertain and complex**
 - **War on the peninsula will be characterized by unparalleled suffering**
 - **Collapse will be hard to distinguish from war**
- **Combined SOF will be a major player in any scenario**
- **SOCKOR integrates US SOF to contribute to Combined SOF's success**

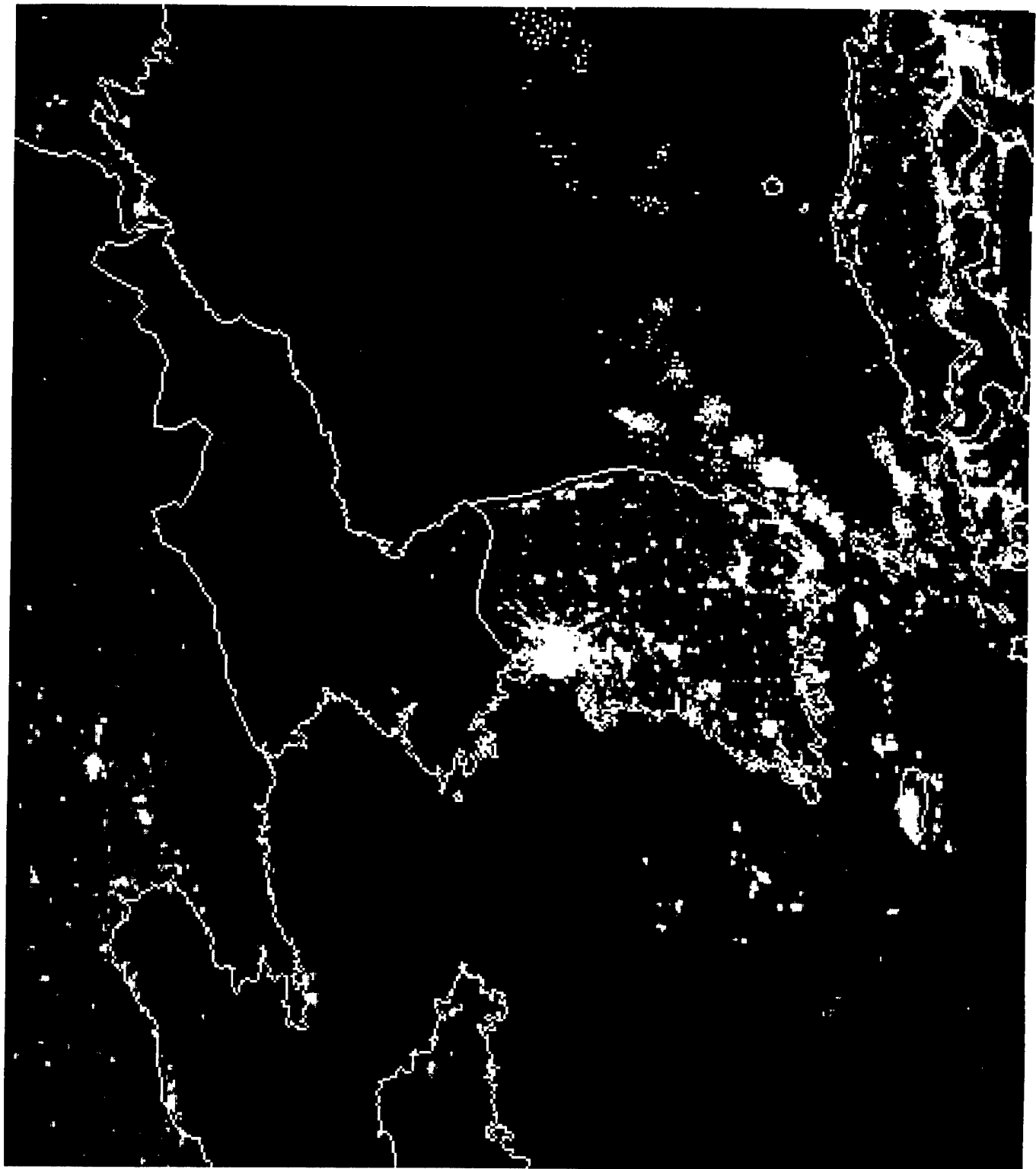

**SPECIAL OPERATIONS COMMAND KOREA
(SOCKOR)**



QUESTIONS

NDIA SO/LIC SYMPOSIUM:

SO/LIC ROLE IN MULTINATIONAL WARFARE

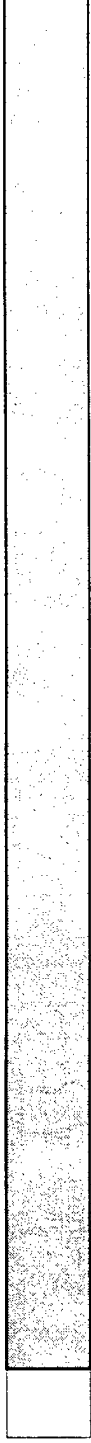

“THE BALKAN EXPERIENCE”

COL. PETER GUSTAITIS

DEPUTY FOR SPECIAL OPERATIONS

J-33, JOINT STAFF



AGENDA



INTRODUCTION

BOSNIA CONFLICT
SFOR THEN/SFOR TODAY

THE MILITARY RESPONSE

SFOR

CJSOTF

SOF TASK ORGANIZATION
COMMAND AND CONTROL

LESSONS LEARNED



UNCLASSIFIED

(S) MUP Police on Patrol. The MUP's behavior in the Presovo Valley suggests the Serbs are adapting a more sophisticated approach to counterinsurgency.

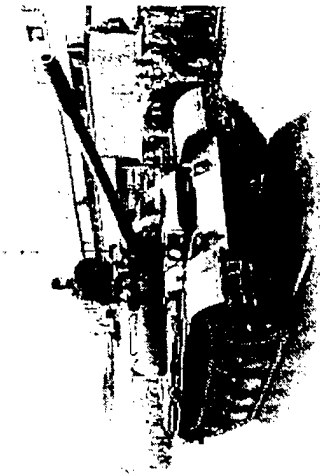

CONFLICT HISTORY

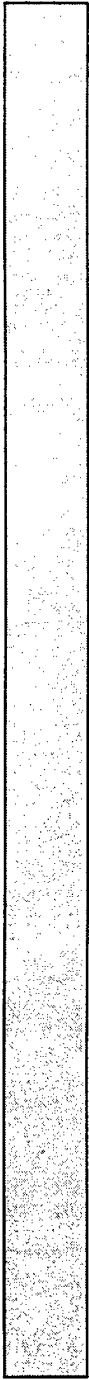

- **PRESENT BOUNDARIES
EMERGED IN MID-1800'S**
- **IMPETUS WAS NATIONALISM
AND HOPE FOR DEMOCRACY**
- **NATIONALISM BASED UPON:
COMMON LANGUAGE
ETHNICITY/ RELIGION
AWAKENED BY EUROPEAN REVOLUTIONS**
- **DEMOCRACY BASED UPON:
CIVIL RIGHTS
DISTRIBUTION OF POWER AND WEALTH
REPRESENTATION**

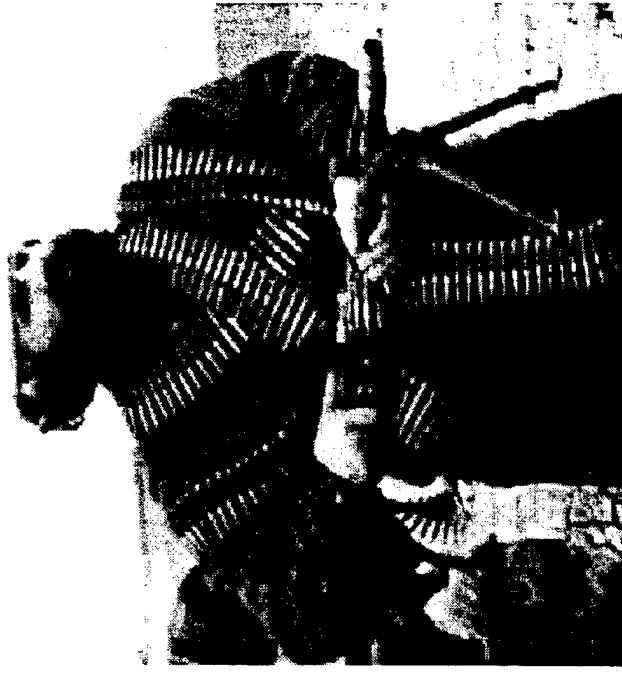

COMMUNIST FORMER YUGOSLAVIA

TITO DAYS

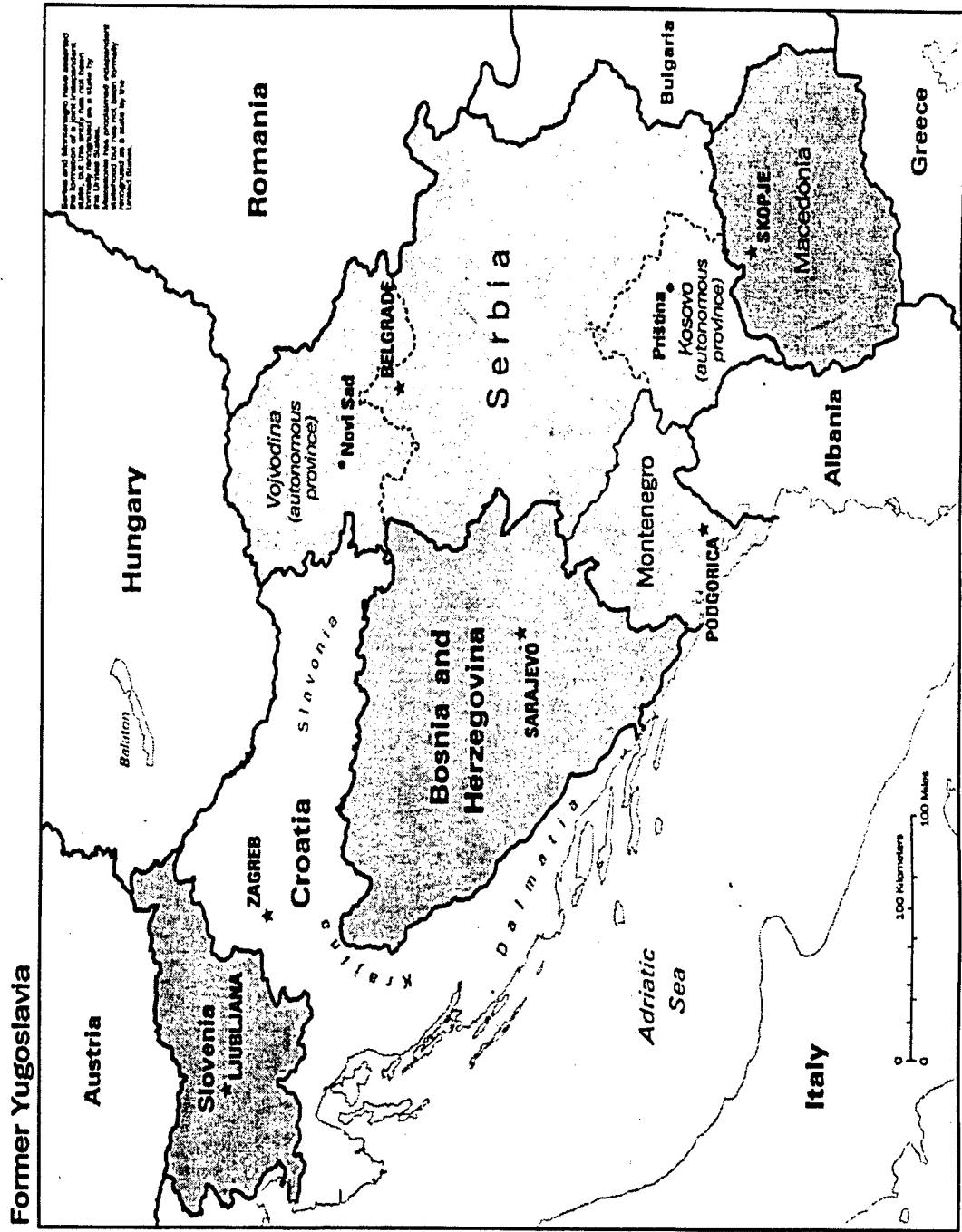

CONFLICT HISTORY

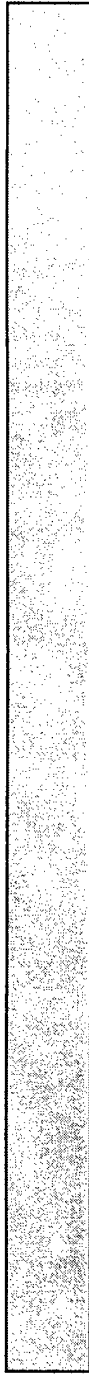

- BREAK-UP OF YUGOSLAVIA
- INDEPENDANT COUNTRIES
- ETHNIC STRIFE
- INTERNATIONAL ISSUE
- DAYTON PEACE ACCORDS

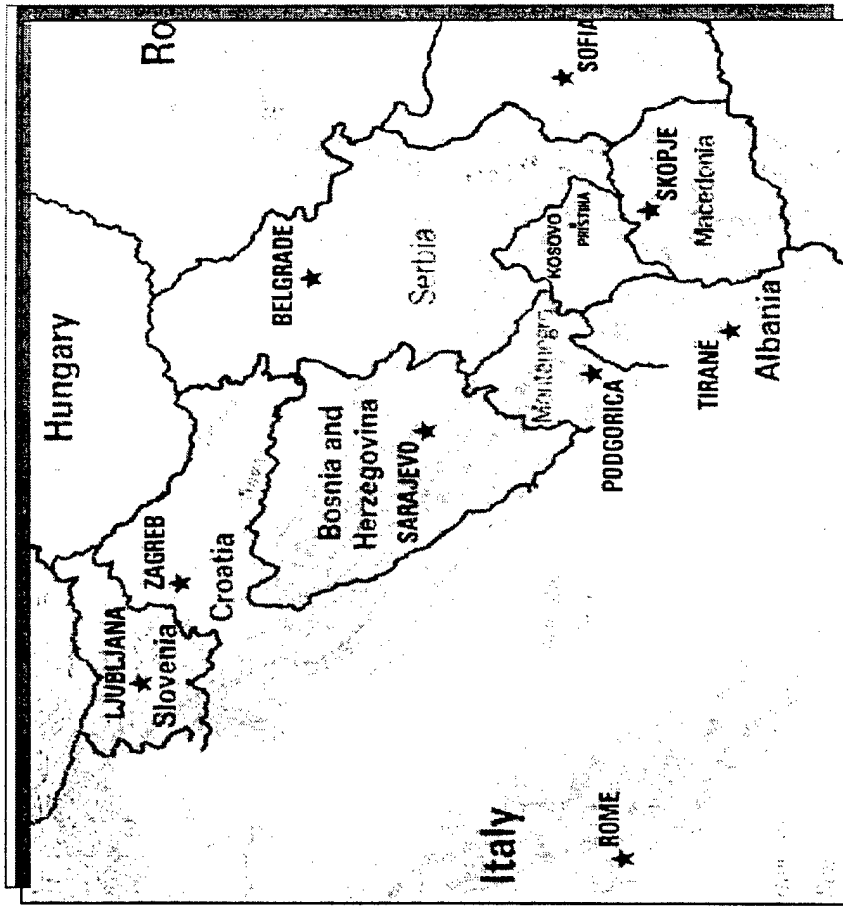
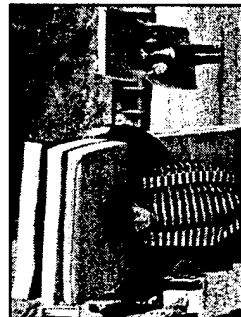



SFOR



- UNIQUE MISSION
- TASK ORGANIZATION
- AREAS OF RESPONSIBILITY
- CHALLENGES

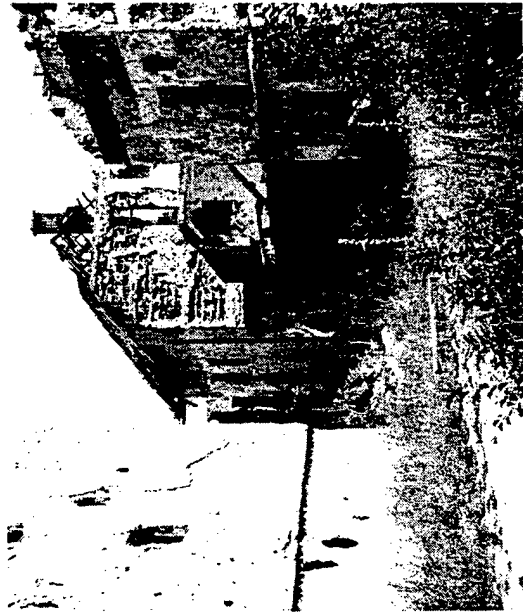

S
F
O
R



OPERATIONS



SFORCSOTT

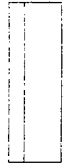

MULTINATIONAL DIVISIONS



- JOINT COMMISSION OBSERVER (JCO)
- TASK ORGANIZATION
- MISSIONS
- SUCCESSES

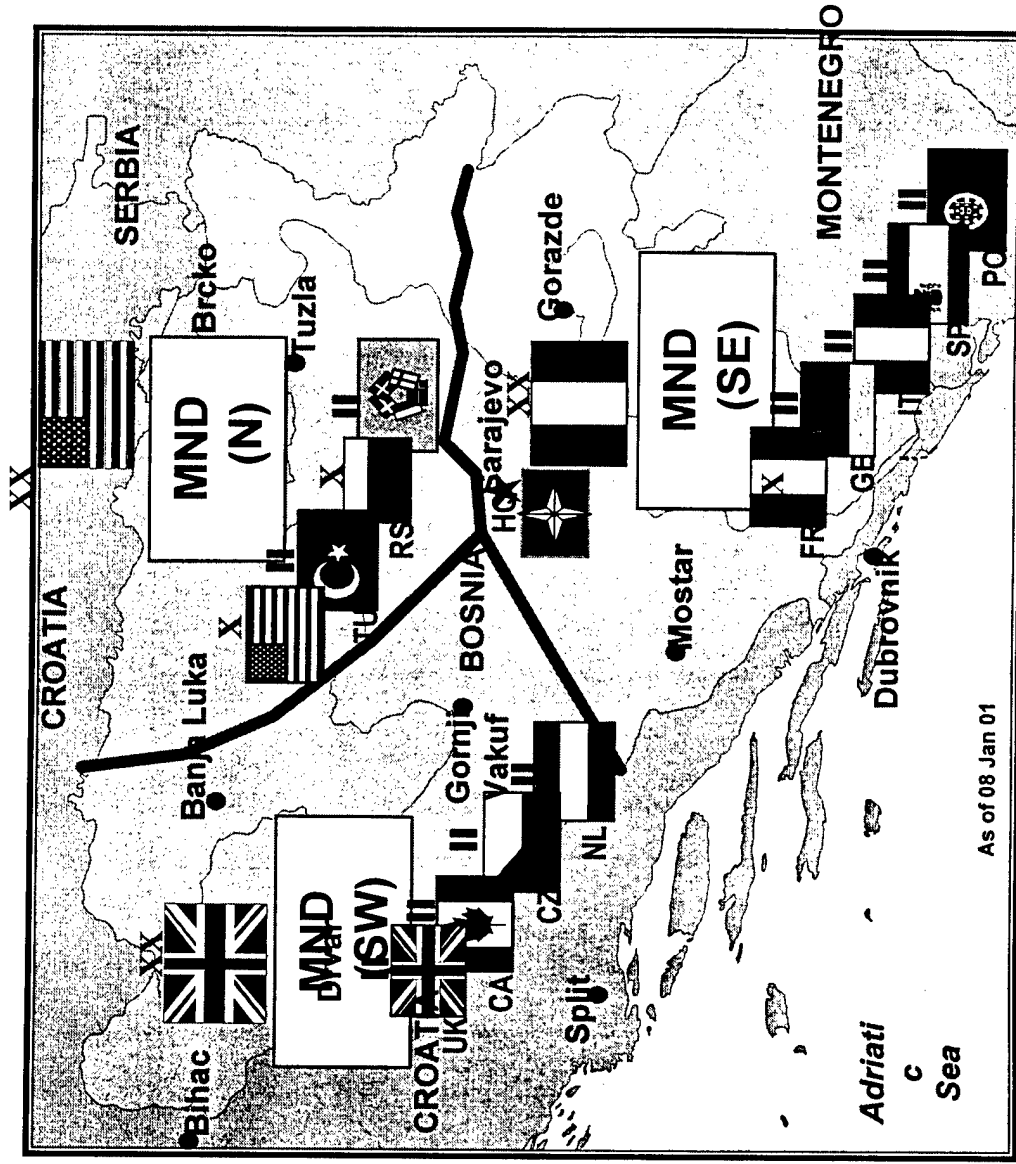

JCO HOUSE

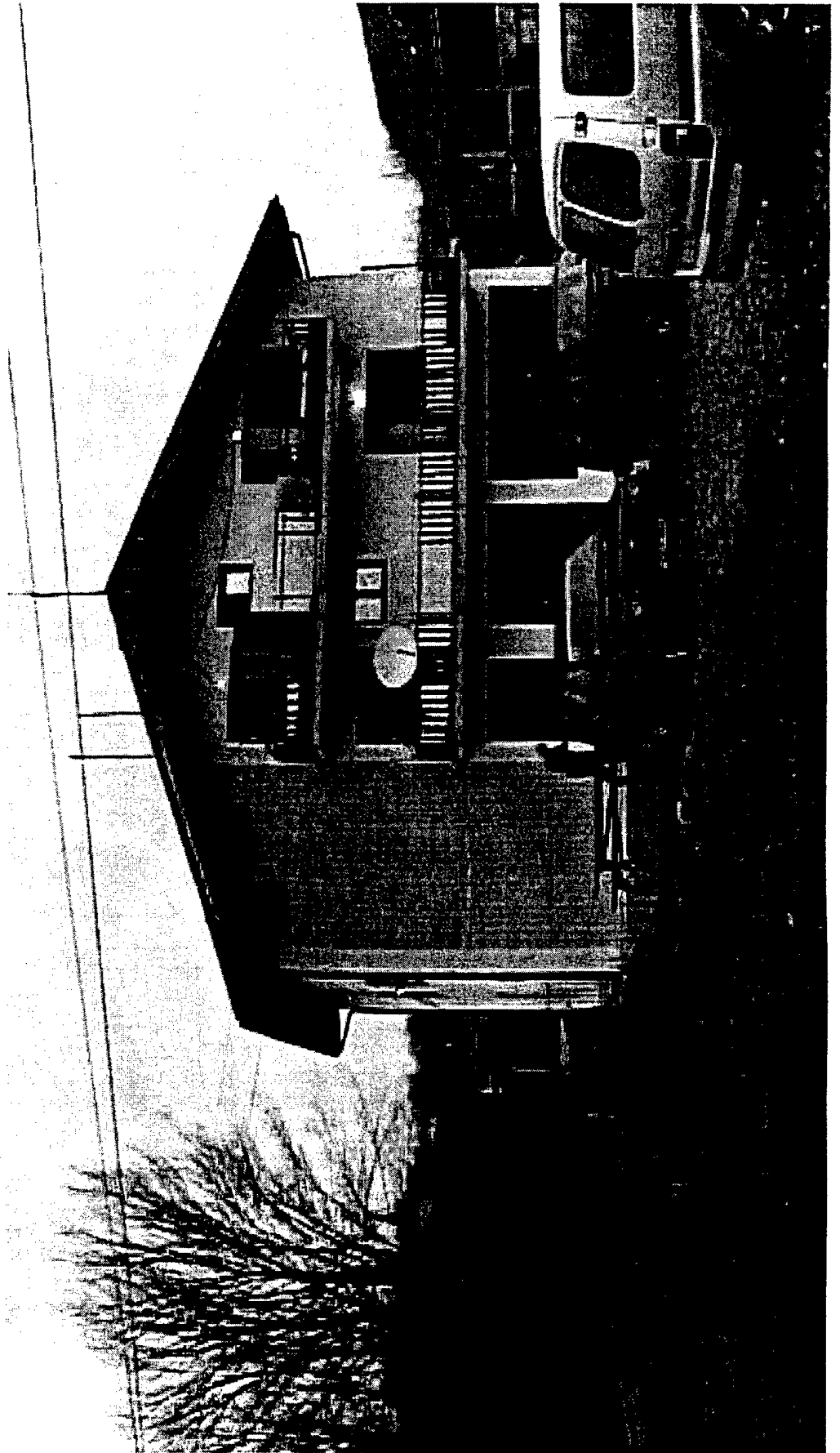
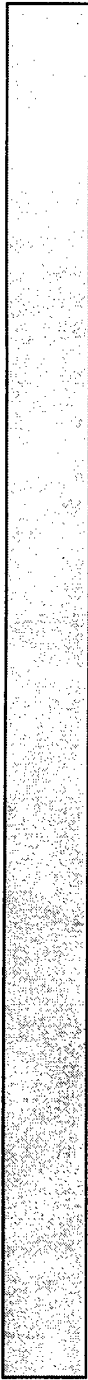



COMBINED JOINT OPERATIONS TASK FORCE (SARAJEVO)

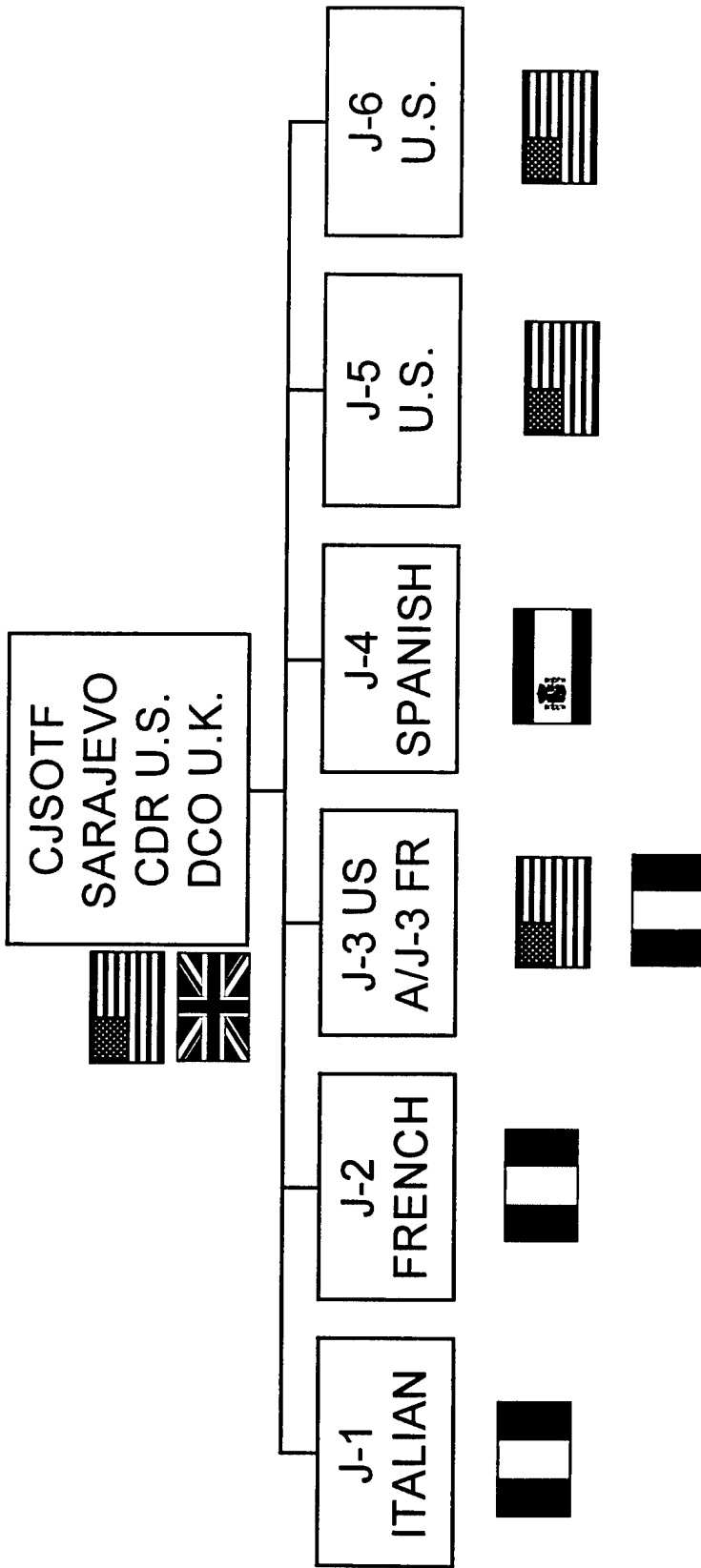
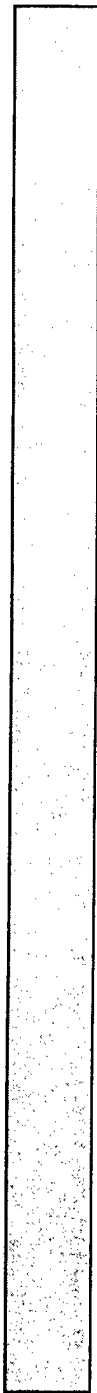



LESSONS LEARNED

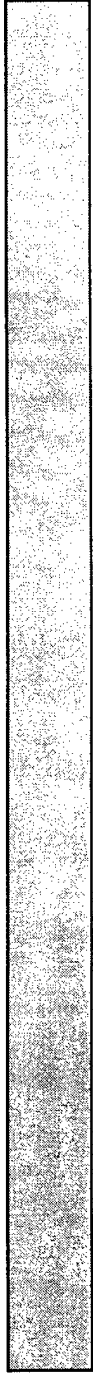

- CHALLENGES OF COMBINED SOF OPERATIONS
OPERATIONAL ENVIRONMENT
POLITICAL IMPLICATIONS
WAY AHEAD
NEED FOR COMBINED TRAINING
FLEXIBILITY

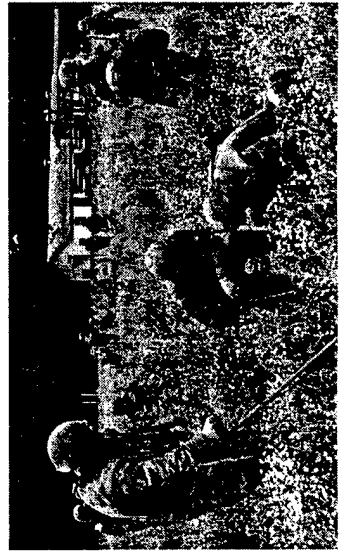

THEN AND NOW

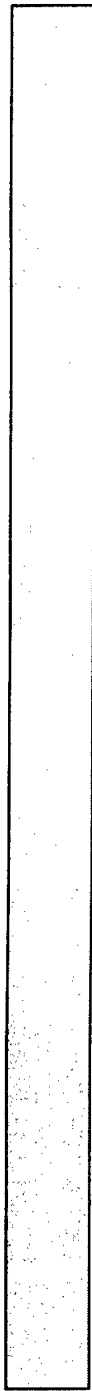

OLD



NEW

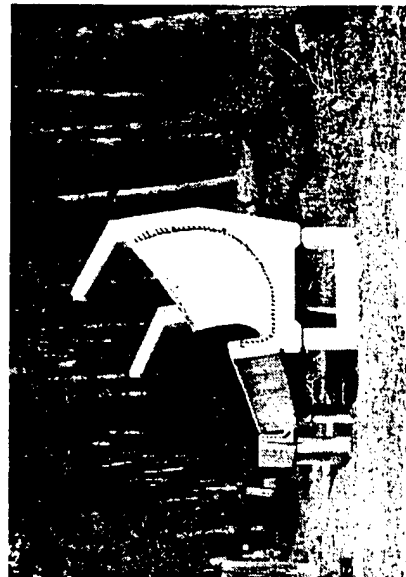

Seminar #6. Marine Expeditionary Unit, Special Operations Capable MEU (SOC)
Organization, Mission and Capabilities

The MEU (SOC) mission is to provide a forward deployed, flexible, sea based, Marine Air Ground Task Force, capable of rapidly executing Amphibious Operations, designated Maritime Special Operations, Military Operations Other Than War, and Supporting Operations to include enabling the introduction of follow-on-forces. This seminar will address the primary characteristics as well as the core competencies of the MEU (SOC)s ability to provide the regional CINCs with a certified, versatile, ready force.

Brigadier General Gordon C. Nash, USMC
Director, Operations Division, Headquarters Marine Corps

Brigadier General Richard F. Natonski, USMC
Director, Strategy & Plans Division, Headquarters Marine Corps

Brigadier General (S) Walter E. Gaskin, USMC
Director, Training Command, MCCDC-Quantico

Colonel Richard T. Tryon, USMC
Commanding Officer - Marine Barracks, 8th & I - Washington, DC

Lieutenant Colonel Drew M. Watson, USMC
Executive Officer - Coalition & Special Warfare, MCCDC - Quantico

Major J. R. Brown III, USMC
MAGTF - Special Operations, Operations Division, Headquarters Marine Corps

Moderator: Lieutenant Colonel Mike Janay, USMC (Ret)

The MAGTF

Marine Air Ground

Task Force

BGen NASH

What Is A MAGTF?

“A task organization of Marine forces under a single command and structured to accomplish a specific mission.”

JP 1-02, DOD Dictionary

MAGTF Organization

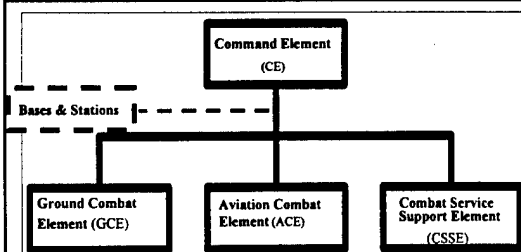

Command Element Functions

- Command and Control
- Planning
- Intelligence
- Communications
& Info Systems
- Liaison



Ground Combat Element

- Infantry
- Artillery
- Combat Engineers



Ground Combat Element

- Armor
- Light Armor
- Assault
Amphibians
- Reconnaissance



Aviation Combat Element

- **Fixed Wing**
 - Fighter/Attack
 - Attack
 - Electronic Warfare
 - Refueling/Transport
- **Rotary Wing**
 - Attack
 - Transport
 - Utility
- **UAVs**



Aviation Combat Element



- **Aviation C²**
- **Air Defense**
- **Marine Wing Support Group (MWSG)**



Combat Service Support Element

- **Supply**
- **Maintenance**
- **Transportation**
- **Landing Support**
- **General Engineering**
- **Health Services**
- **Services**

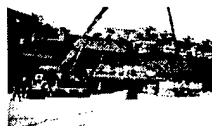

Bases and Stations

- Training
- Maintenance
- Platforms



MAGTF Characteristics

- Ready to Fight and Win
- Expeditionary Culture
- Combined-Arms Operations
- Task Organized
- Reserve Integration Expertise
- Forcible Entry from the Sea
- Marines are Naval in Character
- Joint Competency

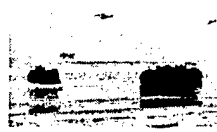

Marines Are Naval In Character

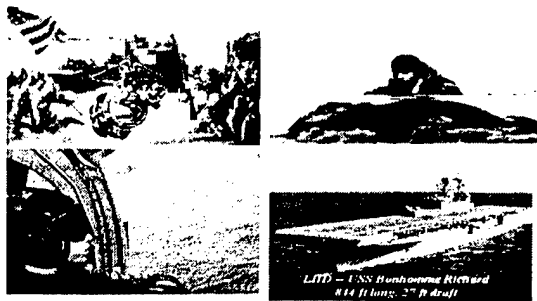

Joint Competency

- MEU Provides JTF Enabler
- MEF/MEB CE Provides Nucleus of JTF HQs
- MEF Can Act as the JFACC, JFLCC, & JFMCC



Marine Expeditionary Unit

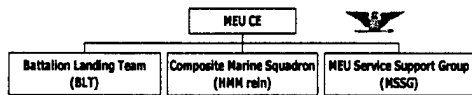

- 2200+ Personnel
- 26 Aircraft
- 15 Days Sustainability
- Deploys on 3 Ship ARG

MEU(SOC) Capabilities

- Raids- Helo & Amphibious
- Non-Combatant Evacuation
- Humanitarian Assistance
- Peace Keeping/Enforcement
- Security Ops
- Non-Lethal Weapons
- Tactical Recovery of Aircraft & Personnel (TRAP)
- JTF Enabler



MEU Locations

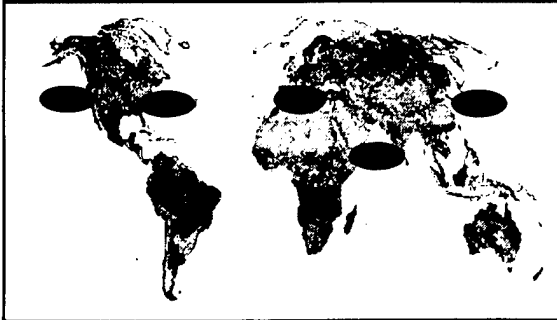

Marine Expeditionary Brigade

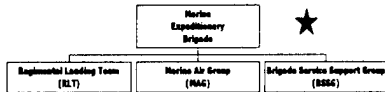

- 14,000-17,000 Personnel
- Most Flexible Organization
- Deploys as MPF or Amphibious MAGTF
- 30 Days Sustainability
- Smallest MAGTF Capable of Forcible Entry

Marine Expeditionary Force

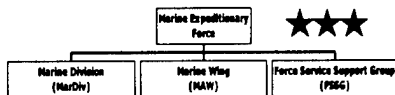

- 45,000-50,000 Personnel
- Principle Warfighting Organization
- 60 Days Sustainability

Amphibious MEB

- Forcible Entry
- 14,000-16,000 Personnel
- 5-15 Amphib Ships
- 7-30 Day Response



MPF MAGTF

- 3 X 5 ship MPS
- 1 MPS equips 1 MEB
- Fly-in echelon ~ 19,000
- 7-14 Day Response Time
- Needs Secure Port & Airfield



MPS Locations

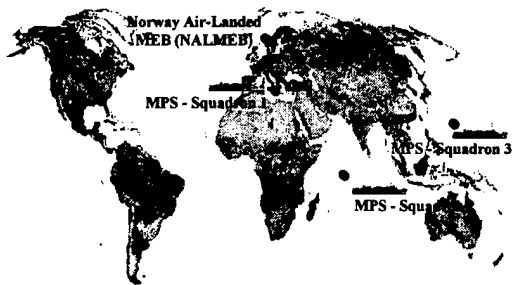

MAGTF Deployment

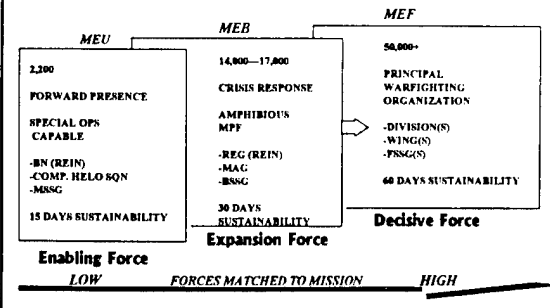

The MAGTF

QUESTIONS??

Marine Expeditionary Unit (Special Operations Capable)

MEU (SOC)
&
MISSION
CAPABILITIES

Mission

"Provide a forward deployed, flexible, sea based, Marine Air Ground Task Force, capable of rapidly executing Amphibious Operations, designated Maritime Special Operations, Military Operations Other Than War, and Supporting Operations to include enabling the introduction of follow-on-forces.

MCO 3120.9

Marine Expeditionary Unit (MEU)

- COLONEL
- 2200 MARINES / SAILORS
 - reinforced infantry battalion (GCE)
 - reinforced helicopter squadron (ACE) (on call KC-130 detachments)
 - MEU Service Support Group (MSSG)
- 15 days sustainability
- Special Operations Capable (SOC)
- Routinely Deployed

Current MEU's

- Camp Pendleton (PACOM/CENTCOM)
- 11th MEU Deploys Mar 01
 - 13th MEU Deployed Returns Feb 01
 - 15th MEU Down cycle
 - Camp Lejeune (EUCOM)
 - 22d MEU Deployed Returns May 01
 - 24th MEU Deploys April 01
 - 26th MEU Down cycle
 - Okinawa Japan (PACOM)
 - 31st MEU Forward Based

**Marine Expeditionary Unit
(Special Operations Capable)**

**MEU (SOC)
TRAINING PROGRAM**

HISTORY

- SEC DEF DIRECTED REVIEW OF SPECIAL OPERATIONS CAPABILITIES IN LOW INTENSITY CONFLICT
- HOLLOWAY COMMISSION REPORT
- JCS & USMC URGENT FURY STUDIES

**MEU (SOC) PROGRAM
INITIATED**

- CMC directed a study in 1984 to explore:
 - » *"Special Operations in a maritime environment"*
 - Based upon traditional expeditionary and amphibious Marine Corps roles and functions
- Formally instituted MEU(SOC) program 1985
 - Requiring realistic and rigorous PreDeployment Training Program and Special Operations Capable Exercise (SOCEX)

**PRE-DEPLOYMENT
TRAINING PROGRAM (PTP)**

- BUILD UPON & ENHANCE CONVENTIONAL EXPEDITIONARY AND MARITIME CAPABILITIES INHERENT IN THE MEU/ARG TEAM
- SYSTEMATIC APPROACH TO TRAINING
- CAPABILITIES-DRIVEN & STANDARDS-BASED PROCESS
- *SIX MONTHS IN DURATION*
- PLAYBOOKS DESIGNED TO SUPPORT MISSION PROFILES

CORNERSTONES

- STABILIZATION
 - PERSONNEL & EQUIPMENT
- STANDARDIZATION
 - TRAINING, EQUIPMENT, PROCEDURES
 - RAPID RESPONSE PLANNING PROCESS COMMENCE OPERATIONS WITHIN **6 HOURS** OF RECEIPT OF WARNING/ALERT ORDER
 - STANDARD OPERATION PROCEDURES PLAYBOOKS DESIGNED TO SUPPORT MISSION PROFILES
- INTEGRATION
 - MEU, PHIBRON, CVBG

**NORMAL CYCLE
= 13 MONTHS**

- **6 Months in CONUS**
 - All attached units and personnel, doing MEU(SOC) work-up
 - Building block approach (Three Phases)
- **6 Months Deployed**
 - Forward deployed.... Crisis Response
- **1 Month re-deployed to CONUS**
 - Stand by Amphibious Force
 - MEU is disbanded, & MSEs return to parent units
 - CE Prepare to begin next work-up

INITIAL PHASE (10wks)

"Individual and Small Unit Focus"

- ARG/MEU(SOC) WORKSHOP
- OPS/INTEL SEMINAR
- AMPHIBIOUS RAIDS PKG
- CQB COURSE
- SECURITY/COVERING FORCE TRNG
- APPLIED BREECHERS
- URBAN SNIPER COURSE
- ASSAULT CLIMBERS CRS
- URBAN RECONNAISSANCE
- SCOUT SWIMMERS COURSE
- LONG RANGE NAVIGATION
- AMPHIBIOUS INDOCTRINATION
- HELO ROPE SUSPENSION TRNG
- FIRE SUPPORT COORDINATION
- STX'S

INTERMEDIATE PHASE (8WKS)

"Collective - Integration Focus"

- Interoperability Period
 - MSPF, SEALs
- MIO & GOPLAT Training
- Training in an Urban Environment (TRUE)
 - LA, Philadelphia, New Orleans, Long Beach, Guam
 - FBI Support
 - Exceptional Helicopter, R&S Opportunity
- MEUEX
 - Mission Profile Exercise
 - CE, GCE, ACE, CSSE Interaction
 - Pre SOCEX Evaluation

FINAL PHASE (8WKS)

"Evaluation Focus"

- SOCEX (FORMAL CERTIFICATION)
 - AMPHIBIOUS RAID (BOAT-HELO-MECH)
 - NEO (SINGLE & MULTI-SITE)
 - SECURITY OPS
 - DIRECT ACTION
 - TRAP
 - VBSS
 - GOPLAT
 - HUMANITARIAN / CIVIC ASSISTANCE
 - R2P2 (RAPID RESPONSE PLANNING PROCESS)
 - CLANDESTINE RECONNAISSANCE
 - LONG RANGE RAID (W/ FARP OPS)
 - MASS CASUALTY DRILL
 - AIRFIELD SEIZURE

FINAL PHASE (8WKS)

“Embarkation Focus”

- FLEET EX, SAC EX
- PRE EMBARKATION ACTIVITIES
 - MESSAGE SENT TO CMC, CINCs, FLEET COMMANDERS, ARG COMMANDERS
- WASH, D.C. COMMANDERS BRIEF
- UNDERWAY!

**Marine Expeditionary Unit
(Special Operations Capable)**

**OPERATIONAL
EMPLOYMENT**

Operational Employment

- PRAYING MANTIS
 - PERSIAN GULF (4-88) GOPLAT
- UN TRADE EMBARGO
 - PERSIAN GULF (10-90) MIO
- SHARP EDGE
 - LIBERIA (5-90/1-91) NEO
- EASTERN EXIT
 - SOMALIA (1-91) NEO-SECURITY

Operational Employment

- FIERY VIGIL
 - PHILIPPINES (6-91) Humanitarian
- PROVIDE COMFORT
 - N. IRAQ (7-91) Humanitarian
- RESTORE HOPE
 - SOMALIA (12-92) Humanitarian

Operational Employment

- BASHER 52 RECOVER
 - BOSNIA (6-95) TRAP
- SILVER WAKE
 - ALBANIA (3-97) NEO
- JOINT GUARDIAN
 - KOSOVO (6-99) ENABLING FORCE

SOF INTERFACE

- "The MEU(SOC) is organized, trained, and equipped in a manner that makes it capable of performing certain SO missions when it is the most opportune force available. MEU(SOC) capabilities can complement the DA or CT missions of SOF..."

Joint Pub 3-05.3

MEU (SOC) & SOF

- | | |
|------------------------|-------------------------------|
| • SOF | • MEU (SOC) |
| PERMANENT ORGANIZATION | TASK ORGANIZATION |
| CONTINUOUS CAPABILITY | FORWARD DEPLOYED CAPABILITY |
| WIDE SPECTRUM / FOCUS | CONVENTIONAL / MARITIME FOCUS |

NOT IN COMPETITION

NOT A DUPLICATION

COMPLIMENTARY CAPABILITIES

- Sea based Forward Operating Bases
- Logistics Sustainment
- Security Forces
- Reconnaissance and Surveillance
- Medical Unit
- Allows SOF to Enter w/Smaller Footprint
- Emergency Assault Capability

KEY POINTS

- **MEU (SOC) = MAGTF**
 - CE -COMMAND & CONTROL
 - GCE -FLEXIBILITY, FIREPOWER
 - ACE -MANEUVERABILITY, FIREPOWER
 - CSSE -SUSTAINABILITY
- **CAPABLE, RELIABLE, VERSATILE, FLEXIBLE, SUSTAINABLE**
- **MEU (SOC) PTP**
 - Stabilization-Standardization-Integration
 - Enhances Inherent Amphibious/Expeditionary Conventional Capabilities
 - Select Maritime Special Capabilities

24th MARINE EXPEDITIONARY UNIT

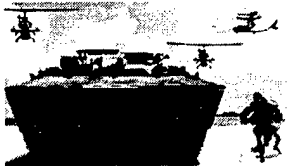

Oct 95 – May 98

TIP OF THE SPEAR

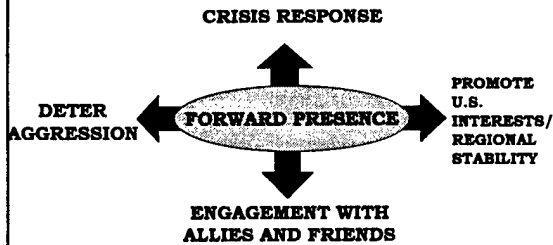

SAIPAN ARG (Jun-Dec 96)



USS SAIPAN (LHA-2)



USS GUNSTON HALL (LSD 44)



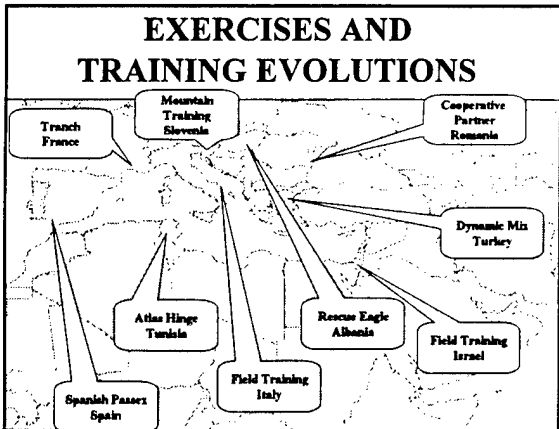

USS AUSTIN (LPD-4)



OPERATIONS

- IFOR Reserve
- Operation Decisive Endeavor
 - TRAP
 - Fixed/Rotary Wing Aviation Support
- Operation Joint Endeavor
 - Drina River Bridge

GUAM ARG (Oct 97 - Apr 98)



USS GUAM (LPH-9)



USS ASHLAND (LSD-48)



USS SHREVEPORT (LPD-12)



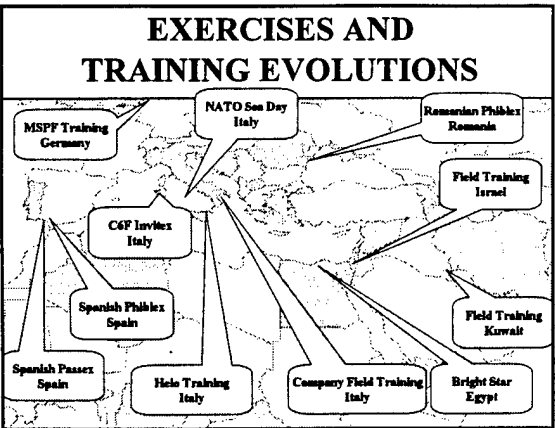

USS OAK HILL (LSD-51)



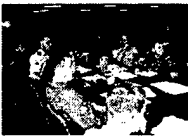

OPERATIONS

- SFOR Strategic Resolve (Med Oct 97-Jan 98)
- Operation Desert Thunder (Persian Gulf Feb-Mar 98)
 - Phase I (Afloat)
 - Security Operations (AMEMB)
 - TRAP
 - NEO
 - VBSS
 - Phase II (Ashore) on order
 - Defense of Kuwait City
 - MEU (SOC) Missions, As Directed

LESSONS LEARNED

- ANGLICO
- SOCOM Interface
- Night Operations
- Force Protection
- Split ARG Operations/Communications
- Operational Security vs. Internet
- Non Lethal Weapons



QUESTIONS?





22nd MARINE EXPEDITIONARY UNIT

JAN - JUL 96

BATTALION
LANDING TEAM
2/2

COL W. E. GASKIN



Organization

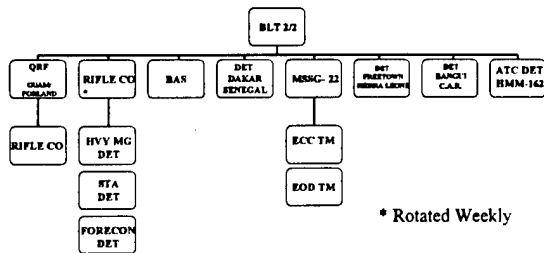

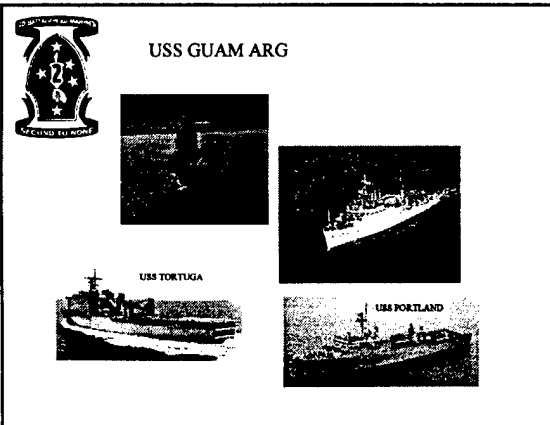

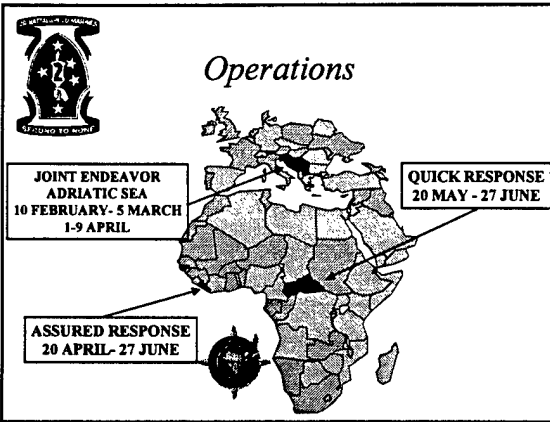

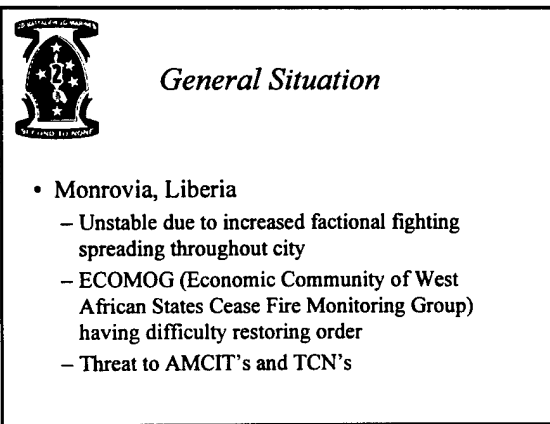

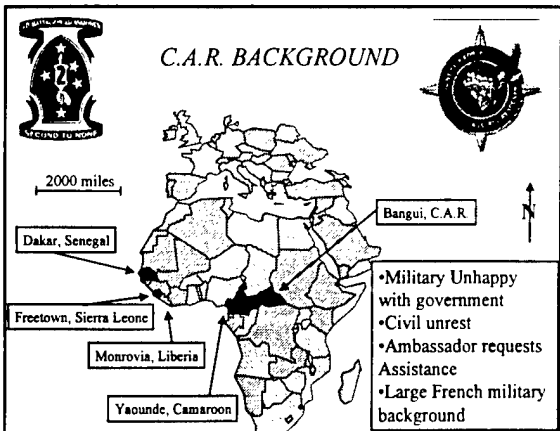

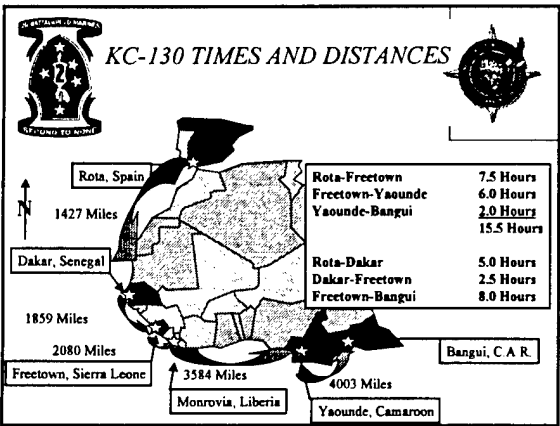

Personnel Evacuated

PLACE	DATE	AMCITS	TCNs (COUNTRIES)	TOTAL
MONROVIA	20 Apr-26 Jun	49	260 (32)	309
BANGUI	21-26 May	190	258 (21)	448
TOTAL		239	518	757

**22nd MARINE
EXPEDITIONARY
UNIT**



SEP 99 – MAR 00

**MEET THE NEEDS OF THE NATION
ACROSS THE
SPECTRUM OF CONFLICT**

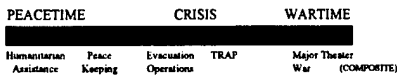

MEU(SOC) CAPABILITIES AND MISSIONS

- OPERATIONS OTHER THAN WAR
(i.e. Peace Keeping, Humanitarian Assistance)
- AMPHIBIOUS OPERATIONS
(i.e. Demonstration, Raid, Assault)
- SUPPORTING OPERATIONS
(i.e. Tactical Deception, MOUT, Show of Force)
- DIRECT ACTION
(i.e. TRAP, Precision Raid)

22 MEU(SOC)

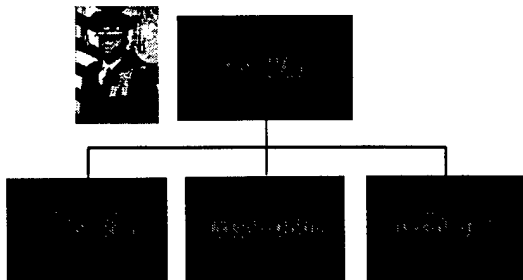

BATAAN ARG



USS BATAAN



USS SHREVEPORT



USS WHIDBEY ISLAND

USS BATAAN

- MEU CE
 - DET, 8TH COMM BN (JTF ENABLER)
 - DET, RADBN (MEWSS VEH)
 - PLT, FORCE RECON
- BLT 3/6 (-) (REIN)
 - H&S CO (-) (REIN)
 - PLT, RECON BN
 - ENG PLT
 - CO I (HELO CO)
 - WPNS CO
 - PLT 81MM MORTAR
 - PLT DRAGON
 - PLT CAAP (-)
 - LAR PLT, 2D LAR BN
- HMM-261 (REIN)
 - MACG
 - DET, LAAD BN
- MSSG-22
 - ECC DET, GOLD







3 LCACS

CLASS IX BLOCK (170) PALCONS (85%)

USS SHREVEPORT



- DET, BLT 3/6
 - CO L (BOAT CO)
 - DET, CAAP
- MSSG-22 (-) (REIN)
 - ECC DET, SCARLET
 - LFSP
- SEAL TEAM 2 PLT C
- SBU (11m RHIBS)



1 LCU

15% CLASS IX BLOC

USS WHIDBEY ISLAND

- DET, BLT 3/6
 - CO K (MECH)
 - BTRY B, 1ST BN, 10TH MAR
 - AAV PLT, 2D AAV BN
 - TANK PLT, 2D TANK BN

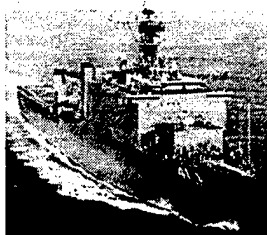

2 EMPTY LCACS: 1 WITH PTM

EXERCISES AND OPERATIONS



QUESTIONS?





LF6F 1-99 Review

24th MEU (SOI)

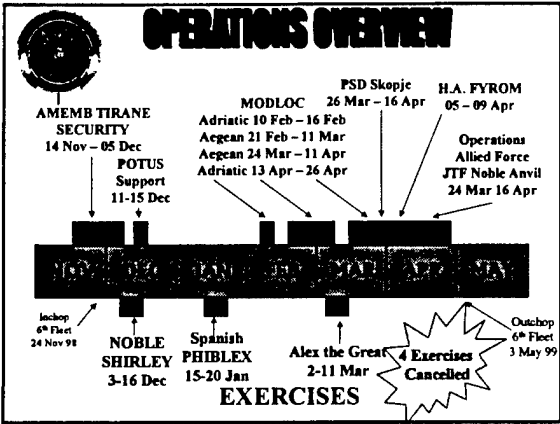

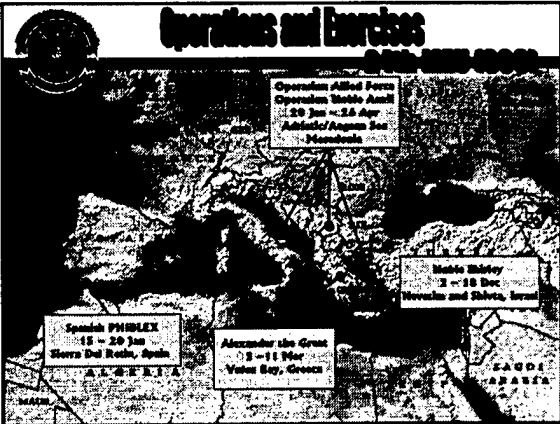



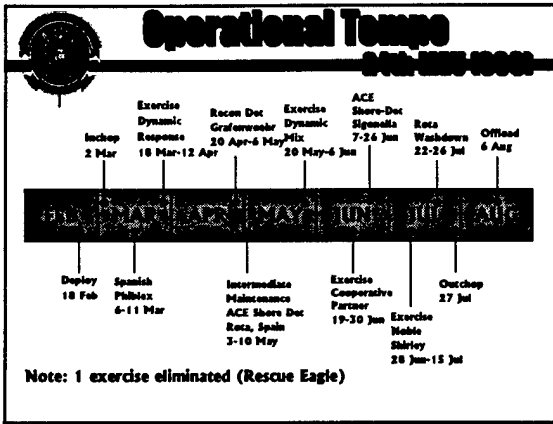

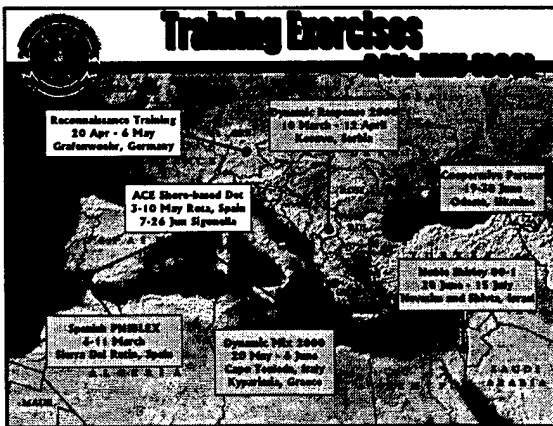

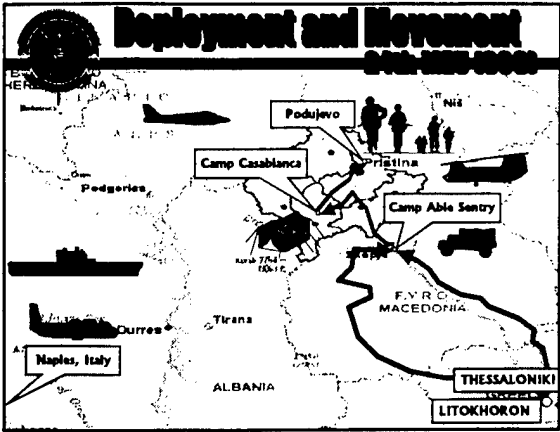

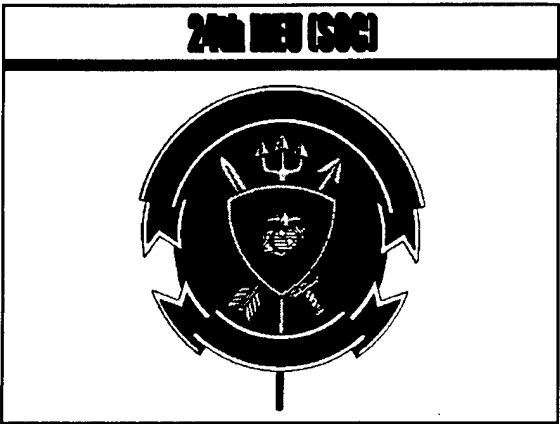

Brigadier General Gordon C. Nash

**Director, Operations Division
Plans, Policies, and Operations HQMC**



Brigadier General Nash was born August 9, 1947 in Honolulu, Hawaii. He graduated from Hampden-Sydney College in June 1971 with a Bachelor of Arts Degree in Political Science. He received his commission in December 1971 upon the completion of Officer Candidate School.

After graduating from the Basic School in July 1972, he reported for duty with the 3rd Marine Division and served as a Platoon Commander and Company Executive Officer with 1st Battalion, 4th Marines.

In October 1973, Brigadier General Nash transferred to the 2nd Marine Division where he served with the 2nd Reconnaissance Battalion as a Platoon Commander, Company Executive Officer, and Battalion S-4. He deployed with BLT 3/2 as part of the Caribbean Ready Force. Reassigned within the Division in September 1975, Brigadier General Nash served as the Assistant Operations Officer and as a Rifle Company Commander with 2nd Battalion, 2nd Marines. He deployed with BLT 2/2 in support of LF6F operations. In May 1977, he transferred to Quantico, Va., where he served as an Officer Candidate School Platoon Commander and attended Amphibious Warfare School. In May 1978, he reported for duty with the Officer Assignment Branch, Headquarters Marine Corps.

Brigadier General Nash's next assignment was with the United Nations Truce Supervision Organization-Palestine, where he served as an observer and special negotiator with Observer Group Lebanon. In October 1982, he reported to the U.S. Army John F. Kennedy Special Warfare Center at Fort Bragg, N.C. After graduating from the Special Forces Qualification course on the Commandant's List, he was ordered to be the Officer-in-Charge, Special Forces Officer Qualification Course and Marine Corps representative to the U.S. Army Airborne and Special Operations Test Board. In August 1985, Brigadier General Nash returned to Quantico to attend the Marine Corps Command and Staff College from which he was an honor graduate. His next assignment was with the 1st Marine Division where he served as the Operations Officer, 7th Marine Regiment until August 1986, when he was directed to reactivate and command the 1st Force Reconnaissance Company. Upon relinquishing command, Brigadier General Nash served as the Executive Officer, 1st Battalion, 7th Marines.

In the fall of 1989, Brigadier General Nash reported for duty at Headquarters Marine

Corps, Plans, Policies, and Operations Division, Western Regional Branch. Brigadier General Nash attended the National War College and graduated with the class of 1991. His next assignment was with the Joint Special Operations Command, Fort Bragg, N.C., where he performed the duties of Deputy Director for Operations, Director for Operations, and Chief of Staff. During this period, he also served as the J-3 for Task Force Ranger during combat operations in Somalia. In June 1994, he reported for duty at Camp Lejeune and has served as the Assistant Chief of Staff for Operations (G-3) for both II Marine Expeditionary Force and U. S. Marine Corps Forces, Atlantic. In July 1997, Brigadier General Nash assumed command of the 2nd Marine Regiment, 2nd Marine Division. During this period, he also served as the Operations Officer for the Downing Task Force which investigated the Khobar Towers bombing and as the Commander of Joint Task Force Auburn Endeavor, which supported Department of Energy operations in Tbilisi, Ga. In July 1998, he was assigned as Commanding General, 3d Force Service Support Group, Okinawa, Japan.

Brigadier General Nash's personal awards include the Defense Superior Service Medal, the Legion of Merit, the Defense Meritorious Medal with Oak Leaf Cluster, the Meritorious Service Medal with Gold Star, the Army Achievement Medal with Oak Leaf Cluster, the Navy and Marine Corps Achievement Medal, the Combat Action Ribbon, the Army Special Forces Tab, the Army Master Parachutist Insignia, and the British Army Parachutist Insignia.
(Revised Apr. 23, 1999 HQMC)

By: Headquarters Marine Corps, Division of Public Affairs, Marine Corps News, Washington, D.C.
20380-1775, (703) 614-7678 / 7679

**Brigadier General
Richard F. Natonski**
**Director, Strategy and Plans Divison,
Plans, Policies, and Operations,
HQMC**



Brigadier General Natonski is currently assigned as the Director, Strategy and Plans Division, Headquarters, U.S. Marine Corps.

Brigadier General Natonski grew up in New Canaan, CT. He graduated from the University of Louisville in 1973 with a B.A. degree in History, and was commissioned a second lieutenant in the Marine Corps.

Upon completion of The Basic School in 1974, Lieutenant Natonski served as a platoon commander and executive officer with Hotel Company, 2d Battalion, 4th Marines. There he participated in Operations EAGLE PULL (Cambodia) and FREQUENT WIND (South Vietnam).

Transferring to the Marine Corps Recruit Depot, San Diego in July 1975, Lieutenant Natonski was assigned as a series commander in Company A, 1st Recruit Training Battalion and subsequently as the battalion operations officer. In April 1978, Captain Natonski was transferred to Marine Barracks, 8th and I, where he served as executive and commanding officer of Company B.

Upon completion of this tour in Washington, D.C. in 1981, he spent the summer as a platoon commander at Officer Candidate's School prior to attending the Amphibious Warfare School in Quantico, Va.

In July 1982, he was assigned as the operations officer for 1st Battalion, 5th Marines at Camp Pendleton, Calif. Subsequent to his tour in 1st Marine Division Major Natonski was transferred to Headquarters Marine Corps in July 1984, where he served in the Ground Combat Requirements Branch of the Plans, Policy, and Operations Department. From 1987 to 1988, he attended the Marine Corps Command and Staff College.

Following his instruction at Quantico, he was assigned as an Observer to the United Nations Truce Supervision Organization in Middle East. Upon completion of this tour in June 1989, he was transferred to the 2d Marine Aircraft Wing at Cherry Point, N.C., where he was assigned as the plans officer.

In July 1991, Lieutenant Colonel Natonski was transferred to 2d Marine Division, where he

served as the executive officer of the 2d Marine Regiment until assuming command of 1st Battalion, 2d Marines in May 1992. As commanding officer, he participated in Operations GTMO, a humanitarian relief mission for Haitian migrants in Cuba and Operation's RESTORE HOPE and CONTINUE HOPE in Somalia. He completed his tour in the Division as the deputy G-3.

From 1994 to 1995 he attended the NATO Defense College in Rome, Italy. Colonel Natonski served in the II MEF Operations Section until assuming command of 24th Marine Expeditionary Unit (MEU) in October 1995. Colonel Natonski made two deployments as MEU commander supporting operations in Bosnia and Kuwait. In May 1998 he gave up command of the MEU and reported to the Joint Staff in the Pentagon where he was assigned duties as the chief of the CENTCOM Division, Joint Staff (J-3) Operations Directorate and subsequently the Deputy Director for Operations in the National Military Command Center.

Brigadier General Natonski's decorations include the Defense Superior Service Medal, Legion of Merit, Defense Meritorious Service Medal with one oak leaf cluster, Meritorious Service Medal, Navy and Marine Corps Commendation Medal with two gold stars, Army Commendation Medal and Combat Action Ribbon.

United States Marine Corps

Brigadier General (Select)

Walter E. Gaskin

Commanding General, Training Command



Colonel Walter E. Gaskin graduated from Savannah State University NROTC Scholarship Program with a Bachelor of Science in 1974, and later earned a Master of Public Administration from the University of Oklahoma in 1992.

He was commissioned a second lieutenant on June 2, 1974. After graduation from The Basic School, he was assigned to the 2d Marine Division where he served as a 106 recoilless rifle platoon commander and executive officer for Company K, 3d Bn, 2d Marines.

In May 1977, he was ordered to Okinawa where he served as the S-3 for Logistic Support Units (LSU) Echo and Foxtrot, 3d Force Service support Group. He also served as the senior watch officer in 3d Marine Division Command Center.

In May 1978, he reported to Marine Corps Recruit Depot, Parris Island, S.C. where he served as a series commander, executive officer and commanding officer of Company F, 2d Recruit Training Bn. In 1980, he was assigned as the Marine Officer NROTC Instructor at Savannah State University until ordered to Amphibious Warfare School, Quantico, VA in 1983. In July 1984, Colonel Gaskin joined 1st Bn, 2d Marines where he served as the Battalion Operations Officer. He was selected to attend the U.S. Army Command and Staff College, Fort Leavenworth, Kansas, in July 1986.

From 1987 until 1990 Colonel Gaskin served as an action officer at Headquarters, U.S. Marine Corps and Marine Corps Combat Development Command in charge of Unit Environmental Training Programs (jungle, cold weather and combined arms exercises). In 1990, he was assigned to the Combined Forces Command, Seoul, Korea where he served as head, Ground Forces Branch, Operations Division. In July 1992, he reported to II Marine Expeditionary Force where he served as Current Operations Action Officer and Operations Officer for II MEF (Forward) during the planning and execution of Battle Griffin Exercise in Norway.

In July 1993, Colonel Gaskin attended the Army War College, Carlisle Barracks, Carlisle, PA. After Graduation in June 1994, he was assigned to 6th Marines, 2d Marine Division.

In April 1995, he assumed command of 2d Bn, 2d Marines. In January 1996, he deployed with Battalion Landing Team 2/2 as part of the 22d MEU to the Mediterranean Sea for a Landing Force Sixth Fleet deployment, during which he participated in Operation Assured Response and Quick Response in defense of American Embassies in Liberia and the Central African Republic.

From September 1996 to July 1998, Colonel Gaskin served as the Ground Colonel's Monitor at Headquarters, U.S. Marine Corps. He served as Head, Expeditionary Operation, Operations Division, II MEF from August 1998 until assuming command of the 22d MEU in January 1999.

In September 1999, Colonel Gaskin deployed with the 22d MEU (SOC) to the Mediterranean Sea for a Landing Force Sixth Fleet deployment, during which he participated in Operation Joint Forge in

support of peacekeeping operations to implement the Dayton Peace Accords. He relinquished command in May 2000, and will assume the duties as the Commanding General, Training Command on 1 July 2000.

His personal decorations include the Legion of Merit gold star in lieu of 2nd award, Bronze Star with combat V, Defense Meritorious Service Medal, Meritorious Service Medal, Navy and Marine Corps Commendation Medal with two gold stars in lieu of 2nd, 3rd and 4th awards, Navy and Marine Corps Achievement Medal and the Combat Action Ribbon.

(Revised June 5, 2000)

Digital Photo Attachments Below:



lowres.jpg

Marine Barracks

Washington, District of Columbia

[Home](#) [Parades](#) [Organizations](#) [History](#) [Press Info](#) [Leaders](#) [Images](#)

Colonel Richard T. Tryon



[Enlarge Pic](#) +

Colonel Richard T. Tryon assumed command of Marine Barracks, Washington D.C., during a ceremony held on the historic parade grounds of "8th and I," Sept. 18 2000.

Colonel Tryon reports to Washington, D.C. after completing two successful deployments as the Commanding Officer of the 24th Marine Expeditionary Unit.

Colonel Tryon enlisted in the Navy in 1970, and was subsequently commissioned a second lieutenant in June 1975, upon graduating from the U.S. Naval Academy.

After completing The Basic School in April 1976, he held a variety of company grade assignments in 3d Battalion, 5th Marines, served as Aide de Camp to the Commanding General I MAF/1st Marine Division, and completed a tour as company Commander, Headquarters Company, 4th Marines in Okinawa. Upon returning to the United States, he served at Recruiting Station New York City until attending Amphibious Warfare School in 1983. Following completion of AWS, he joined 2d Battalion, 5th Marines where he served as company commander and battalion operations officer. He subsequently attended the U.S. Army Command and General Staff College, Ft. Leavenworth, Kan., in 1987, where he concurrently earned a masters degree in management.

During June 1988, he transferred to the Special Operations Command, Europe in Stuttgart, Germany, where he was assigned to the J-3 as a contingency operations officer. He deployed in support of Operations Desert Shield and Desert Storm and served as assistant operations officer, Joint Special Operations Task Force, JTF Proven Force. Following Operation Desert Storm, he deployed as a member of Joint Special Operations Task Force Provide Comfort operating in Northern Iraq and Southern Turkey.

In July 1991, he was assigned to the Special Operations Training Group, II Marine Expeditionary Force for duty as the director of the Special Missions Branch. Reassigned during March 1993, he served as Commanding Officer of 2d Battalion, 8th Marines until February 1995. Following his tour with the 2d Marine Division, he was assigned to the Joint Staff as Deputy Executive Assistant to the Vice Chairman until August 1997. From September 1997, to April 1998, he attended The Johns Hopkins University School of Advanced International Studies and subsequently completed the requirements for a master of arts degree in international public policy.

Colonel Tryon served as Commanding Officer, 24th Marine Expeditionary Unit from May 1, 1998 to August 25, 2000.

Colonel Tryon's personal decorations include the Defense Superior Service Medal, the Legion of Merit, the Defense Meritorious Service Medal, the Meritorious Service Medal with gold star in lieu of second award, the Navy and Marine Corps Commendation Medal, the Navy and Marine Corps Achievement Medal.

Marine Barracks, Washington, D.C.
 (202)433.4173 :: www.mbw.usmc.mil
[Feedback](#) | [Site Info](#)

[top](#)

Lieutenant Colonel Drew M. Watson

**Deputy Director, Coalition & Special Warfare Center
Training and Education Command, MCCDC**

Lieutenant Colonel Watson was born at Fort Bragg, NC. He was commissioned following graduation from the State University of New York at Binghamton in May 1979. After completing The Basic School and Infantry Officer Course at Quantico, VA, his first assignment was with the 1st Bn, 9th Marine Regiment at Camp Pendleton, CA, serving as a rifle platoon leader from March 1980 - April 1982. While serving with 1/9, Lieutenant Watson was deployed to the Far East for a six-month period.

During May 1982, he was transferred to the Marine Corps Recruit Depot, San Diego, CA for duty with the Recruit Training Regiment. His assignments included Series Commander, Adjutant, and "F" Company Commander, in 2nd Bn, RTR until April 1985. He was promoted to captain during this period.

Returning to the Fleet Marine Force in April 1985, Captain Watson was assigned to 1st Reconnaissance Battalion, serving as "B" Company Commander until September 1987. His next assignment was with the Eleventh Marine Expeditionary Unit, where he served as Special Operations Officer/Maritime Special Purpose Force Commander, until June 1988. During this period, he was selected to attend the Amphibious Warfare School in Quantico, VA, graduating in May 1989.

While attending AWS, Captain Watson was selected to serve as the USMC ground exchange officer with Britain's Royal Marines, serving with the Commandos from May 1989 - July 1991. Upon completion of the Commando Course, Captain Watson initially served as Training Officer, 42 Commando. In July 1990 Captain Watson assumed command of "K" Company, 42 Commando, 3 Commando Brigade, serving with the Brigade on its operational deployment to Iraq. Selected for promotion to major during this period, he returned to CONUS in July 1991.

From August 1991 - June 1994 Major Watson served at the Marine Corps Combat Development Command, Quantico, VA, as both instructor and student. He served consecutively as Deputy Chief Instructor, Instructional Group, then "A" Company Commander, at The Basic School. He then attended the Marine Corps Command and Staff College, graduating in June 1994.

In June 1994 Major Watson assumed command of 1st Force Reconnaissance Company, I Marine Expeditionary Force, Camp Pendleton, CA. He commanded this unit until February 1996, when he was reassigned as Operations Officer, Eleventh MEU, deploying for another six-month period for operations in the Arabian Gulf. He returned to CONUS during June 1997, and was ordered to MCCDC.

Lieutenant Colonel Watson is currently serving as the Deputy Director at the Coalition & Special Warfare Center, TECOM, MCCDC, Quantico, VA. In this capacity, he was temporarily assigned to the Special Operations Command, Europe during Operation Allied Force, serving as Special Operations Force planner with the Joint Special Operations Task Force in Brindisi, Italy; with the Joint Task Force in Naples; and with the Combined/Joint Special Operations Task Force in Sarajevo, from May to September 1999.

Lieutenant Colonel Watson holds a Master of Science degree from Old Dominion University, and is a graduate of numerous U.S. and allied service courses. His personal decorations include the Meritorious Service Medal, Joint Service Commendation Medal, Navy/Marine Corps Commendation Medal and the Navy/Marine Corps Achievement Medal, as well as several unit and campaign awards.

AFM-USA, Inc.

12350 Barbee Road

Bristow, Virginia 20136

Metro: (703) 266-0356

Fax: - (703) 330-5120

E-mail: mike.janay@timedomain.com

FAX TRANSMISSION COVER SHEET

TO: Al De Prospero - ADG

FAX #: 410/272-3302

FROM: Michael Janay

Urgent

Reply ASAP

SUBJECT: Plaques for SO/LIC Symposium

X

Please Review

Please Comment

No. of Pages (including this page): _____

TRANSMISSION: Date: January 27, 2001 Time: 2:00 p.m.

COMMENTS:

1. The following names are submitted for the MEU(SOC) Panel #6.
 - a. Brigadier General Gordon C. Nash USMC
Director, Operations Division, Headquarters Marine Corps
 - b. Brigadier General Richard F. Natonski USMC
Director, Strategy & Plans Division, Headquarters Marine Corps
 - c. Brigadier General Walter E. Gaskin USMC
Director, Training Command, MCCDC-Quantico
 - d. Colonel Richard T. Tryon USMC
Commanding Officer – Marine Barracks, 8th & I – Washington, D.C.
 - e. Lieutenant Colonel Drew M. Watson USMC
Executive Officer – Coalition & Special Warfare, MCCDC – Quantico
 - f. Major J. R. Brown, III USMC
MAGTF – Special Operations, Operations Division, Headquarters Marine Corps

2. In addition, the following personnel are listed:

- a. Colonel Scot Crerar USA (Ret.) – SO/LIC Executive Board Historian, NDIA
- b. John C. Kuntzman – Editor, SO/LIC Division Newsletter, NDIA
- c. Charles Wilkins – Marketing Manager, NDIA
- d. Doctor David Silbergeld (SEAL & SOF) – SO/LIC Executive Board

Sincerely,

Michael R. Janay

P.S. Colonel Jim Kraus USA (Ret.), Symposium Co-Chairman – SO/LIC Division, NDIA
Colonel Ron Henderson USAF (Ret.) Symposium Co-Chairman – SO/LIC Division, NDIA

Mission. Provide a forward deployed, flexible, sea based, Marine Air Ground Task Force, capable of rapidly executing Amphibious Operations, designated Maritime Special Operations, Military Operations Other Than War, and Supporting Operations to include enabling the introduction of follow-on-forces.

Characteristics: MEU(SOC)s provide the regional CINCS with a certified, versatile, ready force that provides four primary characteristics:

- (1) **Forward presence with operational flexibility:** The ability to provide continuous presence and credible, but non-provocative, combat power, for rapid employment as the initial response to a crisis. Signals U.S. commitment to the region and is a visible reminder to those who would threaten U.S. interests. Includes engagement activities that shape and promote regional stability.
- (2) **Rapid response:** The ability to plan and commence execution of a mission within 6 hours of receiving an alert, warning or execute order. Includes the ability to enable the introduction of follow-on-MAGTF (e.g., MPF operations, MEB) or joint and or combined forces by securing a staging areas ashore, provide critical communication or conduct supporting operations.
- (3) **Task organized for multiple missions:** The ability to execute a full range of conventional operations-- from amphibious assault to humanitarian assistance/disaster relief—as well as selected maritime special operations, across the entire spectrum of conflict, either independently or as an integral part of a joint campaign, and transition between operational environments on a moment's notice.
- (4) **Sea-based, strategic reach with inherent force protection:** The ability to operate from ships (independent of established airfields, basing agreements, and overflight rights), provides unimpeded and politically unencumbered access to potential trouble spots around the world. Includes the ability to remain on station, over the horizon of a potential adversary, without revealing exact destinations and/or intentions. Also includes the ability to withdraw rapidly at the conclusion of operations.

Core Capabilities. The inherent core capabilities of a forward-deployed MEU(SOC) are divided into four broad categories: Amphibious Operations, Maritime Special Operations, Military Operations Other Than War (MOOTW), and Supporting Operations.

FOREWORD



Robert J. Newberry
Principal Deputy Assistant Secretary of Defense
(Special Operations/Low-Intensity Conflict)



General Charles R. Holland
Commander in Chief
U.S. Special Operations Command

In the next century, the spread of information, the development of and access to new technologies, and an increasing recognition of global problems will present vast opportunities for economic growth, regional integration, and global political cooperation. Yet for all of this promise, the world remains a complex, dynamic, and dangerous place. It will continue to be an uncertain security environment, one for which U.S. special operations forces (SOF) are uniquely suited, offering the capabilities to avert emerging threats and providing unprecedented opportunities to address the challenges in ways that advance U.S. interests.

Our national military strategy challenges us to “shape the international environment and respond to crises while preparing now for an uncertain future.” No small feat, but SOF are doing that right now. In 2000, SOF conducted engagement operations in over one hundred countries. When crisis response scenarios developed, SOF were already on the ground in many of those situations. SOF were shaping the environment by their presence, providing regionally and culturally trained forces to facilitate the theater commander’s response. Unique SOF abilities give our National Command Authorities expanded options, tailored to task, that are not available elsewhere.

Some of America’s most dedicated men and women are at the core of these unique capabilities. They are mature officers and enlisted personnel, drawn from the military services, trained in the special skills unique to their mission, and then seasoned with real-world operations. We must continue to focus on selecting the right people and training them for the demanding tasks that SOF perform.

In addition, as we prepare for an uncertain future, we must continue a robust modernization program, leveraging technology, to enhance the human dimension. We express the concept simply as “equipping the man, not manning the equipment.” Merging technology with the human dimension will improve the SOF warrior’s survivability, lethality, mobility, and ability to access and use all relevant information sources.

We look forward to meeting the security challenges of this new century as we work to ensure that America’s SOF remain the most carefully selected, most fully prepared, and best-equipped and trained special Operations fighting force in the world. Our country deserves no less.



COL Donald Kropp
US Army Special Operations Command
Deputy Chief of Staff
For Information Management

Colonel Donald Kropp was born in Chicago, Illinois on November 13th, 1951. He holds a Bachelor of Science Degree from Arizona State University and Master of Science Degrees from Central Michigan University and The US Naval War College. Colonel Kropp entered the Army through the ROTC program in January 1974 where he was granted a Regular Army commission in the Signal Corps.

His professional training and education includes attendance of the Army Signal Officer Basic and Advanced Courses, The USAF Telecommunications Systems Staff Officer Course, US Army Command and General Staff College and US Naval War College. He has also graduated from the US Army Airborne and Jumpmaster courses, Ranger training, Pathfinder School and Special Forces Course.

Colonel Kropp has served in a variety of command and staff positions prior to his current assignment. Other assignments include: Chief of Armistice Affairs, United Nations Command Military Armistice Commission (UNCMAC) Korea; Deputy Commander, 1st Signal Brigade (Korea); Deputy, CofS for Information Management, US Army Special Operations Command; Commander, 112th Special Operations Signal Bn (Abn); Chief of Project Implementation Branch, CE Division, Allied Forces Central Europe (AFCENT); Transmission Systems Operations Officer, Central Region Signal Group AFCENT; Tactical Signal Officer, 1st Special Operations Command (Abn); Executive Officer and Operations Officer, 112th Special Operations Signal Battalion (Abn); Signal Officer, 4th Psychological Operations Group (Abn); Assistant Professor of Military Science, Davidson College, NC; Plans Officer, J6 Plans Division, US Forces Korea; Commander, Signal Company 7th Special Forces Group (Abn); Signal Officer, 7th Special Forces Group (Abn); Platoon Leader, Signal Company 7th SFG (Abn); Platoon Leader 51st Signal Battalion (I Corps, Korea).

Colonel Kropp's awards include the Defense Superior Service Medal, Defense Meritorious Service Medal, Army Meritorious Service Medal (with 5 Oak Leaf Clusters), Army Commendation Medal (with 1 OLC), Joint Service Achievement Medal, Army Achievement Medal (with 1 OLC), Armed Forces Expeditionary Medal, National Defense Service Medal (with Bronze Star), Humanitarian Service Medal, Military Outstanding Voluntary Service Medal, Republic of Korea, Presidential, "Sam-II" Medal, Master Parachutist Badge, Pathfinder Badge, Ranger Tab and Special Forces Tab.

Colonel Kropp is married to Myong Sun Kropp. They have an 18-year-old son (in college) named Chris and a cat called "Tuxedo".

Commander Robert S. Winneg is the Deputy Director of the Plans and Support Directorate for the Department of Defense's Coordinator for Drug Enforcement Policy and Support. He was commissioned in 1980 through the Navy ROTC Program and was designated a Naval Flight Officer in 1981.

Qualified as a Patrol Plane Tactical Coordinator and Mission Commander, he has served in several Pacific Fleet P-3 squadrons. He deployed with those squadrons to the Persian Gulf, Indian Ocean, and the western Pacific. While assigned to the aircraft carrier USS Dwight D. Eisenhower, he deployed to the Mediterranean Sea. He commanded Patrol Squadron One based at Naval Air Station Whidbey Island, Washington.

His shore assignments include tours on the staff of the Chief of Naval Personnel, the Commander, Patrol Wings, U.S. Pacific Fleet, and the Commander, Patrol Wing Ten. Commander Winneg is a graduate of the U.S. Naval War College and the Armed Forces Staff College.

Dr. Kenneth Allard is a former US Army Colonel, and the vice president of STRATFOR Inc., an Internet-based, business-intelligence company. He also serves as an adjunct professor at Georgetown University and a Senior Associate at the Center for Strategic & International Studies. Dr. Allard is best known as a frequent television and radio commentator on foreign policy and security issues, especially as a military analyst with NBC News and MSNBC. His numerous publications include two books, Somalia Operations: Lessons Learned, and Command, Control and the Common Defense, winner of the 1991 National Security Book Award. His 26-year military career included service as an intelligence officer in Germany during the Cold War, as a member of the West Point faculty, and as Special Assistant to the Chief of Staff, United States Army. After serving as Dean of Students at the National War College, Colonel Allard volunteered for special assignment in 1996 with US Forces in Bosnia. In addition to his military decorations, his alma mater, Lycoming College, recognized his public service career with its 1999 Outstanding Achievement Award.

Captain Joseph A. Conroy, Jr.
United States Coast Guard

CAPT Joseph A. Conroy, Jr. assumed the duties of Chief, Office of Law Enforcement, U.S. Coast Guard Headquarters, Washington, DC in June, 2000. Immediately prior to this assignment, he served as Deputy Commander, Coast Guard Personnel Command.

Before coming to Washington in August, 1999, CAPT Conroy served as Commanding Officer of USCGC GALLATIN (WHEC 721), based in Charleston, SC. His previous commands include assignments as Commanding Officer of USCGC CAPE KNOX (WPB 95312), in Miami, Florida and USCGC VIGILANT (WMEC 617), in Port Canaveral, Florida.

CAPT Conroy was born in Appleton, Wisconsin and grew up in Rolling Meadows, Illinois. A 1974 graduate of the Coast Guard Academy, CAPT Conroy began his career as a Deck Watch Officer aboard the USCGC DAUNTLESS (WMEC 624) in Miami, Florida. Other afloat assignments include duty as Operations Officer aboard USCGC DALLAS (WHEC 716) in Governors Island, New York, and as Executive Officer of USCGC DILIGENCE (WMEC 616) in Port Canaveral, Florida.

CAPT Conroy's shoreside assignments include: duty as a Controller in the Seventh Coast Guard District Operations Center in Miami, Florida; as the Chief of the COMLANTAREA Operations Center in Governors Island, New York; as Special Assistant to the Commander in Chief, U.S. Southern Command in Panama; as Chief of the Drug and Migrant Interdiction branches at Coast Guard Headquarters in Washington, DC; and as Coast Guard Liaison to the Department of State in Washington, DC.

CAPT Conroy holds a Bachelor of Science degree from the U.S. Coast Guard Academy; and a Master of Public Administration degree, earned at the George Washington University. Military awards include the Defense Meritorious Service Medal, five Meritorious Service Medals, two Coast Guard Commendation Medals, the Coast Guard Achievement Medal, and the Commandant's Letter of Commendation.

CAPT Conroy and his wife, Eugenie, currently reside in Herndon, Virginia. They have three sons, Joseph, Ryan, and Christopher.



BIOGRAPHY

JOHN C. "DUCK" MOSBEY

Colonel John C. Mosbey is Director of the National Guard Counterdrug Program which has primary responsibility for all Army and Air Guard Counterdrug activities; including plans, programs, budget and coordination of all phases of CD operations in support of the Governor's State Plans, substance abuse testing and education; as well as Air Guard support to Department of Defense detection and monitoring missions throughout the Western Hemisphere. Colonel Mosbey was appointed to this position by the Chief of the National Guard Bureau, upon recommendation of the Counterdrug Advisory Board, in July 1997.

Colonel Mosbey began his military career in 1969 as an enlisted soldier in the United States Army and later transferred to the Air National Guard (ANG). He was commissioned in 1974, upon graduation from the ANG Academy of Military Science. Colonel Mosbey has served as a Weapons Systems Officer and Instructor with over 2,000 hours in the RF-4C, F4D and F4E Phantom II aircraft. He was assigned to the 187th Tactical Fighter Group (TFG), Alabama and later to the 184th TFG, McConnell Air Force Base (AFB), Kansas. In 1987, he was assigned to the ANG Support Center at Andrews AFB, Maryland, in the Operations Division, where he was selected to head the Flying Training Branch. The Colonel joined Counterdrug Operations in 1990 serving as Liaison to the Joint Staff (JCS J-3), the Pentagon, then to Forces Command at Fort McPherson, Georgia. In 1994 he became Liaison to the Department of Justice, Washington, DC. In 1996 he assumed duties as Chief of Counterdrug Air Operations, with responsibility for all NG Counterdrug operations outside the continental United States, as well as the continental U.S. NG Counterdrug Aircraft, Radar and Digital Mapping programs. Col Mosbey served a special assignment in 1996 as the National Guard Liaison to the Joint Olympic Task Force in Atlanta, Georgia.

A Graduate of the College of Naval Warfare, Air Command and Staff College and Squadron Officers School; Colonel Mosbey also holds Bachelor's Degrees in both Education and Criminal Justice, and Master's Degrees in Criminal Justice, and National Security and Strategic Studies.

Current as of 6 April 2000

ROBERT E. BROWN, JR.
OFFICE OF NATIONAL DRUG CONTROL POLICY (ONDCP)

Mr. Brown is the Acting Deputy Director, Office of Supply Reduction, ONDCP. He served 27 years as an Army officer where his overseas posts included two tours in Vietnam and Army Foreign Area Officer assignments with JUSMAAG, Spain, and as the Commander, U.S. Military Group, La Paz, Bolivia. He also served as the first Department of Defense Liaison Officer to the Drug Enforcement Administration (DEA), in Washington; and as Branch Chief, Latin America/Africa Operations, Defense Security Assistance Agency (DSAA), the Pentagon. After retirement as a Colonel, 1990, he entered the U.S. Civil Service where he served four years as the Director, Washington Field Office, United States Southern Command. He joined General McCaffrey at ONDCP in March, 1996, where his current responsibilities involve the coordination of international and assessment of drug policy.



Robert J. Newberry

Principal Deputy Assistant Secretary of Defense
Special Operations and Low-Intensity Conflict

Mr. Robert J. Newberry assumed his current position as the Principal Deputy Assistant Secretary of Defense for Special Operations and Low Intensity Conflict (SO/LIC) in July 2000.

Before his present assignment, Mr. Newberry served within SO/LIC as the Deputy Assistant Secretary of Defense for Combating Terrorism Policy and Support. He orchestrated the development of this new organization to provide policy oversight for the Department's support in Counterterrorism, Anti-Terrorism, and International Terrorism Consequence Management, and consolidated the Department's Combating Terrorism Activities into a single Congressional Justification Book. Mr. Newberry also served within SO/LIC as the Principal Director for Drug Enforcement Policy and Support. He assisted in the formulation and support of numerous international and domestic counterdrug programs and in the preparation and execution of the Department's counterdrug budget.

Mr. Newberry served for 26 years in the U.S. Air Force before entering civilian service. While in the Air Force, he flew the F-4 and A-10, had an exchange tour with the U.S. Marine Corp, and had assignments in the Operations Directorates of U.S. European Command and the Joint Staff. He also completed the Army Command and General Staff College and the Air War College. After retiring from the U.S. Air Force, Mr. Newberry worked as a program manager at WinTec, Inc., in Maryland.

Mr. Newberry graduated from Texas A&M University in 1967 with a degree in Aerospace Engineering and later obtained a Masters in Political Science from New Mexico State University.