

REPORT DOCUMENTATION PAGE			Form Approved OMB No. 0704-0188	
Public reporting burden for this collection of information is estimated to average 1 hour per response, including the time for reviewing instructions, searching existing data sources, gathering and maintaining the data needed, and completing and reviewing this collection of information. Send comments regarding this burden estimate or any other aspect of this collection of information, including suggestions for reducing this burden, to Department of Defense, Washington Headquarters Services, Directorate for Information Operations and Reports (0704-0188), 1215 Jefferson Davis Highway, Suite 1204, Arlington, VA 22202-4302. Respondents should be aware that notwithstanding any other provision of law, no person shall be subject to any penalty for failing to comply with a collection of information if it does not display a currently valid OMB control number. PLEASE DO NOT RETURN YOUR FORM TO THE ABOVE ADDRESS.				
1. REPORT DATE		2. REPORT TYPE Viewgraphs	3. DATES COVERED	
4. TITLE AND SUBTITLE P-3C SLAP Emerging Technology Evaluations			5a. CONTRACT NUMBER	
			5b. GRANT NUMBER	
			5c. PROGRAM ELEMENT NUMBER	
6. AUTHOR(S) Paul Kulowitch; Donald Pettit; Douglas Van Otterloo			5d. PROJECT NUMBER	
			5e. TASK NUMBER	
			5f. WORK UNIT NUMBER	
7. PERFORMING ORGANIZATION NAME(S) AND ADDRESS(ES) Naval Air Warfare Center Aircraft Division 22347 Cedar Point Road, Unit #6 Patuxent River, Maryland 20670-1161			8. PERFORMING ORGANIZATION REPORT NUMBER	
9. SPONSORING/MONITORING AGENCY NAME(S) AND ADDRESS(ES)			10. SPONSOR/MONITOR'S ACRONYM(S)	
			11. SPONSOR/MONITOR'S REPORT NUMBER(S)	
12. DISTRIBUTION/AVAILABILITY STATEMENT Approved for public release; distribution is unlimited.				
13. SUPPLEMENTARY NOTES				
14. ABSTRACT				
15. SUBJECT TERMS				
16. SECURITY CLASSIFICATION OF:		17. LIMITATION OF ABSTRACT	18. NUMBER OF PAGES	19a. NAME OF RESPONSIBLE PERSON
a. REPORT	b. ABSTRACT			c. THIS PAGE
			36	19b. TELEPHONE NUMBER (include area code) (301) 342-8020

Standard Form 298 (Rev. 8-98)
Prescribed by ANSI Std. Z39-18

20010716 019



P-3C SLAP

Emerging Technology Evaluations



Paul Kulowitch
Naval Air Warfare Center
Aircraft Division
Patuxent River, MD

Donald E. Pettit
Lockheed-Martin Aerospace Corp.
Marietta, GA

Douglas L. Van Otterloo
Lockheed-Martin Aerospace Corp.
Marietta, GA



P-3C SLAP Program Background



- P-3C SLAP is a three Phase Program
 - U.S. Navy, Canadian Forces, Royal Australian Air Force, and Royal Netherlands Navy
- Goal: To determine the structural modifications, replacements & redesigns necessary to extend life to 2015
- Phase I was completed by LMAero in 1998
 - Develop loads, baseline usage & criteria, select critical areas, preliminary fatigue & finite element analysis, define preliminary SLEP kit candidates, & identify 50 highest potential fatigue critical areas (FCA)



P-3C SLAP Program Background



- **Phase II awarded to LMAero in 1999**
 - **Develop detailed test spectra for actual useage**
 - **Design & fabricate structural parts/assemblies for SLEP modifications kits**
 - **Develop & characterize corrosion resistant alternate material to replace 7075-T6**
 - **Conduct a full-scale fatigue test on a P-3C SRP aircraft with SLEP kits to 2 times desired life**



P-3C SLAP Program Background



- **NDI applications an integral part of Phase II**
 - **Baseline inspections define test start condition**
 - **Develop detailed NDI procedures for all FCAs**
 - **Assess potential application of emerging NDI**
 - **Use as test bed for emerging remote sensors**
 - **Apply emerging and conventional NDI techniques to test articles during the fatigue tests.**



- **Phase III: Inspection & Teardown of the full-scale fatigue test article**
 - **Optional extended testing**
 - **Optional damage tolerance testing**
 - **Teardown and inspection of all fatigue critical areas**
 - **Application of conventional and emerging technologies**



P-3C SLAP MAJOR TEST MILESTONES

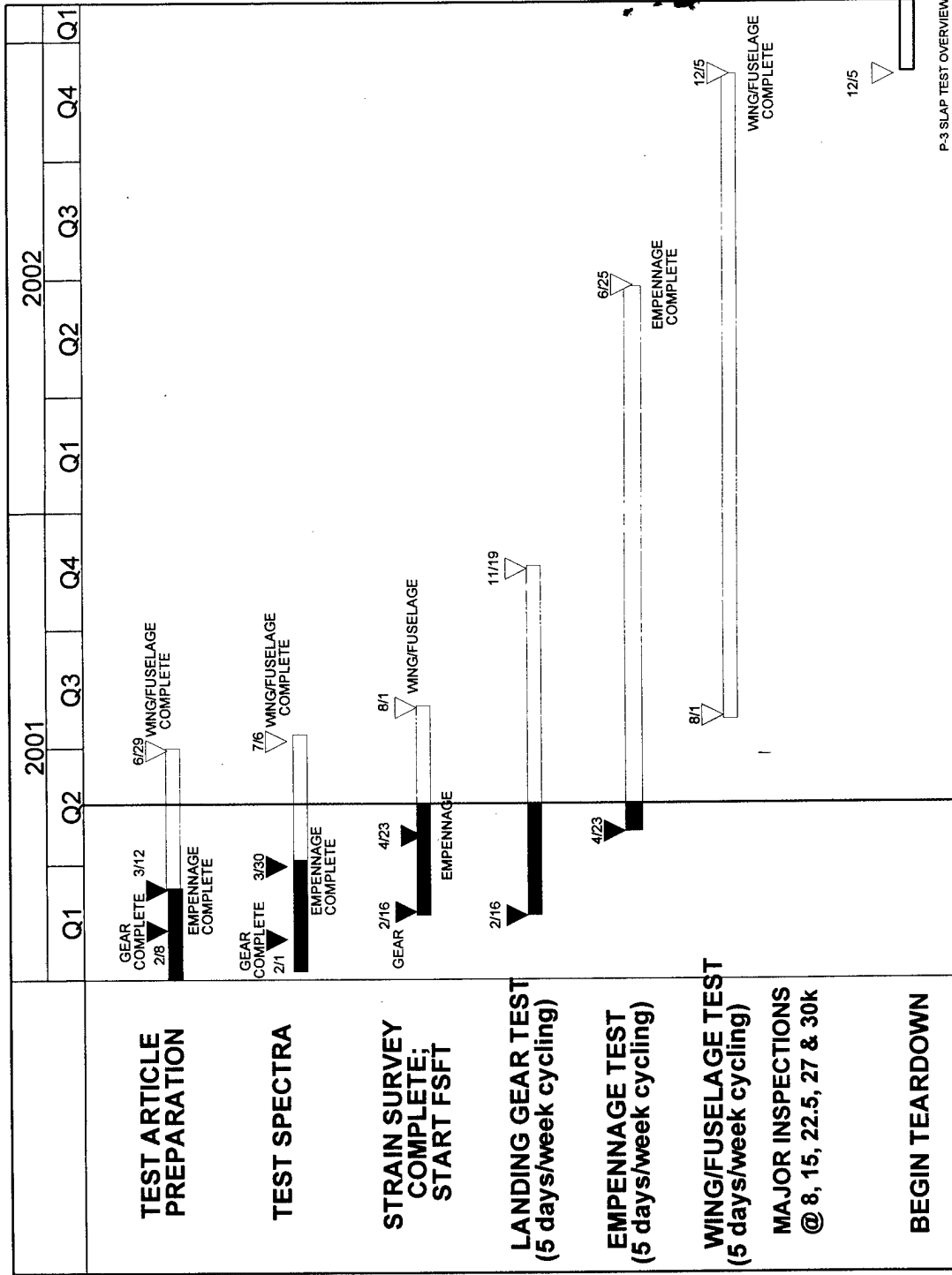



Inspection Plan for the Full-Scale Fatigue Test



- **Pre-Test Inspection of Full-Scale Fatigue Test (FSFT) Article**
 - Engineering Visual Assessment (complete)
 - Scheduled Depot Level Maintenance (SDLM) Inspections (complete).
 - Baseline Instrumental Inspection of All Fatigue Critical Locations (complete).
- **Component Test Periodic Inspections**
 - WS 167 Lower Front Beam Component Test
 - Scheduled to begin at NRC in Ottawa, Canada in June 2001.
 - EC surface scanning, shear wave ultrasonics and MWM will be performed/queried at specified intervals.
 - BL-65 Component Test
 - Test will be conducted at NRC in Ottawa, Canada in June 2001.
 - EC surface scanning, MWM, and AE will be performed/queried at specified intervals



Inspection Plan for the Full-Scale Fatigue Test



- **Walk Around Visual Inspection:** Performed every shift while testing continuous.
- **General Visual Inspection:** Performed every 1000 Hours. Test is stopped. All accessible structure (no removals) is inspected.
- **Emerging Technology: M (Meandering Winding Magnetometer), A (Acoustic Emission), C (Crack Gage):** Remote monitoring technologies will be queried at 1000 hour intervals at the start of the test and will be queried more frequently as the test progresses.
- **Pretest Inspections:** Inspection has been completed under the headings of pretest assessment, modified SDLM procedures, SRP verification and baselining of the FCA procedures. In general, inspection has been conducted to identify, quantify, and repair (if required) any existing damage, corrosion, or cracks present in the as-received P-3C aircraft. In addition, inspection of the mating joints to the backup structure was conducted for both test articles.
- **Minor Inspections:** External FCA Instrumented NDT/I is performed on external structure only where accessible with limited fixture removals. These inspections will be performed at 2000 hour intervals on the 9 most critical areas.
- **Major Inspections:** Instrumented NDT/I will be performed on all fatigue critical areas (FCA), major repairs and any watch list or known damaged areas of the test structure at the completion of 1, 1.5, 1.75 and 2 lifetimes of testing. Loading fixtures that are not bonded to the test article (loading cradles, etc.) will be moved away from the test structure to allow maximum access. Secondary structure will be carefully removed to improve access to key inspection areas and access doors opened as necessary. Fuel tank access panels will be opened for inspection of the internal wing structure. All zonal and general visual inspection will be conducted to identify any anomalous damage or corrosion.



FSFT Post-Test Inspections



- Rescan outer wings with Ultra Image System
- Complete disassembly of outer right-hand wing
- Remove fasteners from other fatigue-critical areas
- Visually inspect all structure
- Inspect selected structure with Acoustic-Thermography
- Perform bolt-hole eddy current on all holes in a 1' radius around all fatigue-critical areas
- Magnetic Particle inspect all magnetizeable parts
- Surface scan (eddy current) or penetrant inspect as required.



NDT Technologies Used on the FSFT

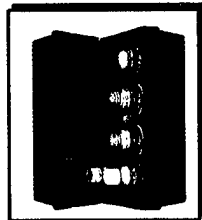

Penetrant



Ultrasonics



Eddy Current

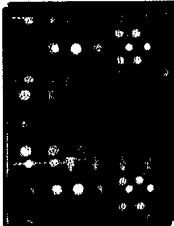

Radiography

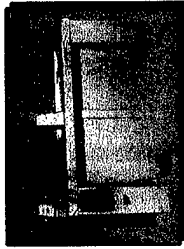

Magnetic Particle

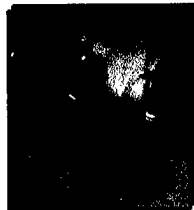

Magneto Optical Imaging (MOI)

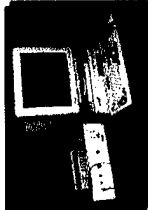

Acoustic Emission



Fiber Optic Strain Gauges

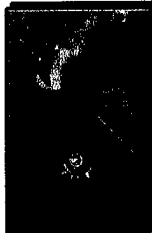

Visual-Borescope

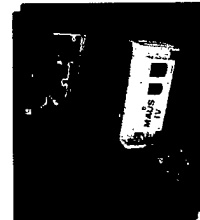

Mobile Automated Scanner (MAUS)



Meandering Winding Magnetometer (MWM)



Andscan Eddy Current and Ultrasonic



Thermal Imaging



Emerging Technology Demonstrations



- Emerging NDI Technology Assessment
 - Meandering Winding Magnetometer (Jentek)
 - Acoustic Emission (Dunnegin)
 - Ultrasonics
 - Shear Wave C-Scan (SAIC Ultra Image International)
 - Ultrasonic Real-time Imaging (Imperium)
 - Phased Array UT (RD Tech/USAF)
 - Low Frequency Eddy Current (Hocking/KB)
 - Sonic (Vibro) Thermography (Thermal Wave Imaging/Wayne State/NAWCADPAX)



REMOTE MONITORING SENSORS



- JENTEK MWM Remote sensor design completed and the prototypes have been delivered. Application to component tests is pending.
- Dunningin Engineering Acoustic Emission system has been delivered and demonstration on component tests is pending.
- Examining KRAK Gages for use in some critical locations with difficult access. Current plan is to use these to monitor probable cracking locations inside the fuel tank.



Emerging NDI MWM Sensors



- Demonstration was successful
 - Surface breaking cracks of ~0.050” past the fastener head were easily detectable and could be tracked as they grew
- System Configuration
 - MC-ERIM
 - 18 surface mountable sensors delivered for use on the component and FSFT



JENTEK's MWM-Rosette for Monitoring Crack Initiation and Growth

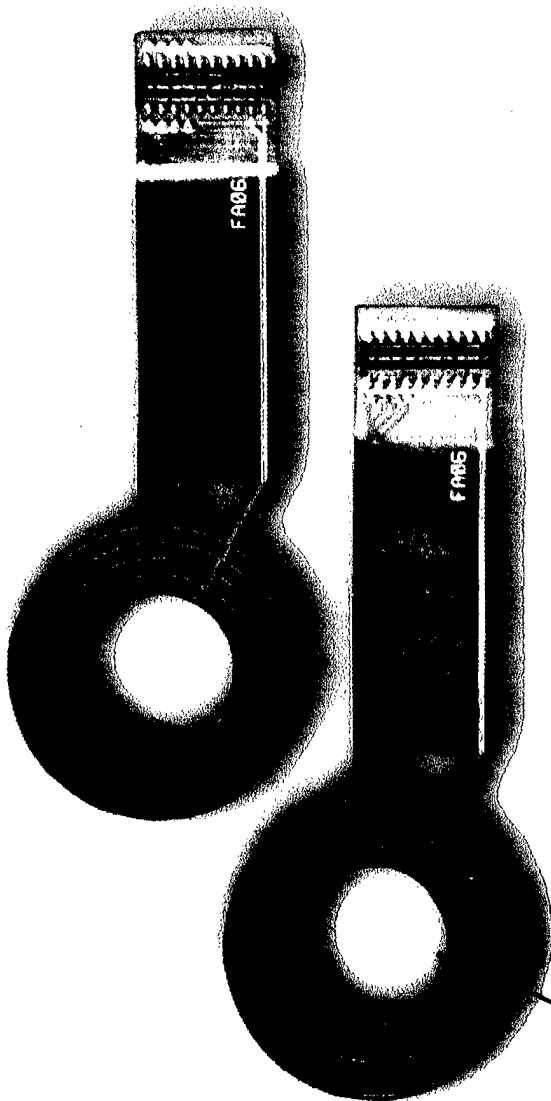

- Crack Detection
- 4 Sensing Element Array
- Mountable on Surfaces and Between Layers (e.g. Aircraft Skins)

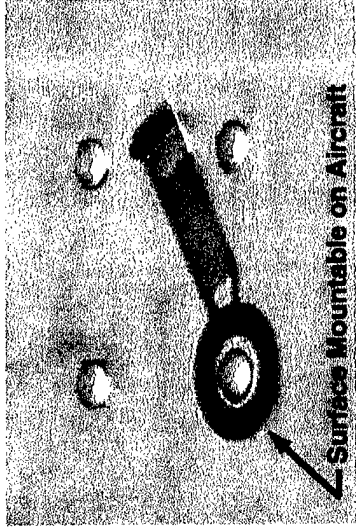

Optional 10 meter cable
for inspecting
difficult-to-access locations



W-M-Rosette with Seven Sensing Elements

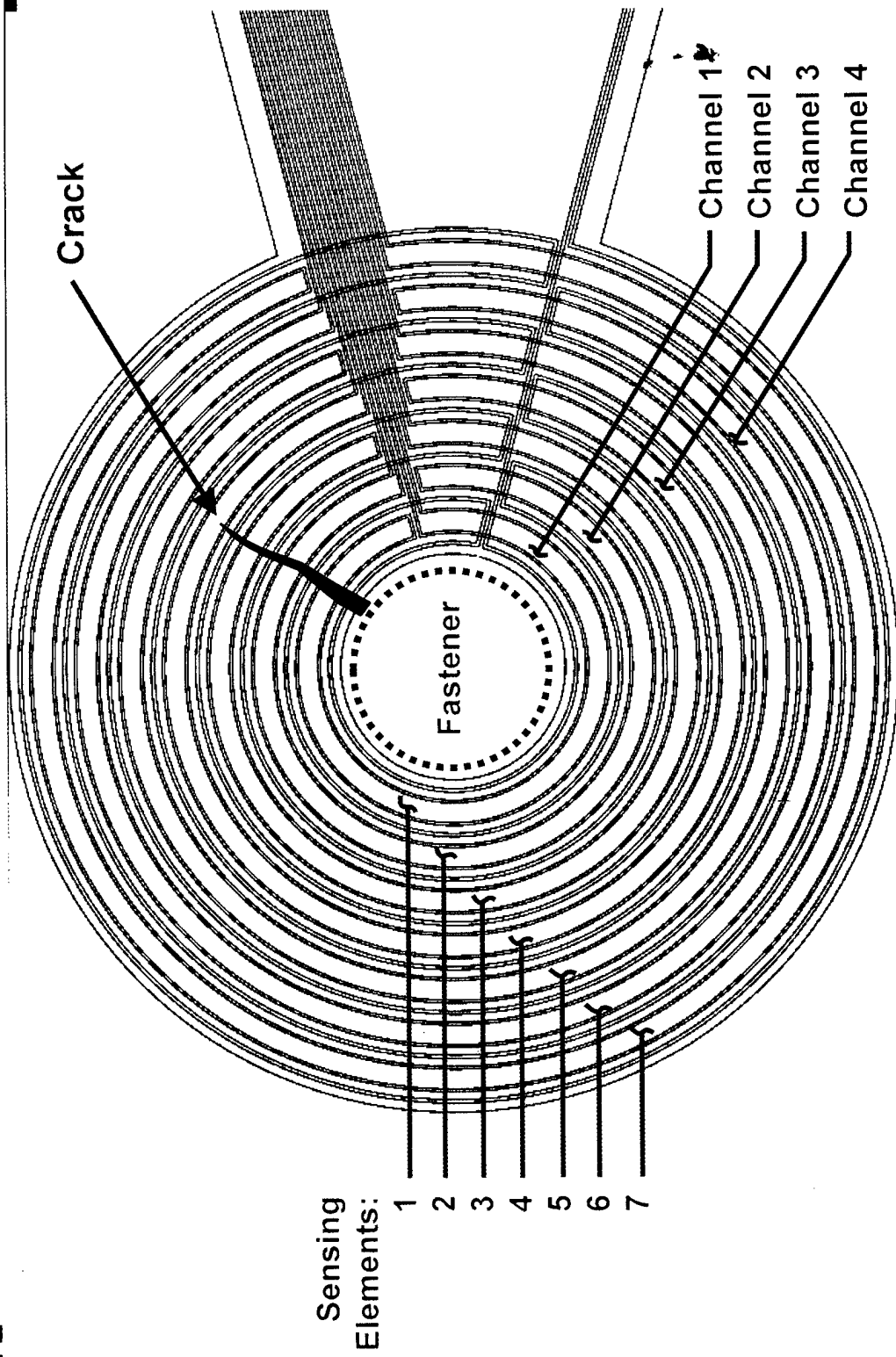



MWM-Rosette Conductivity Plot

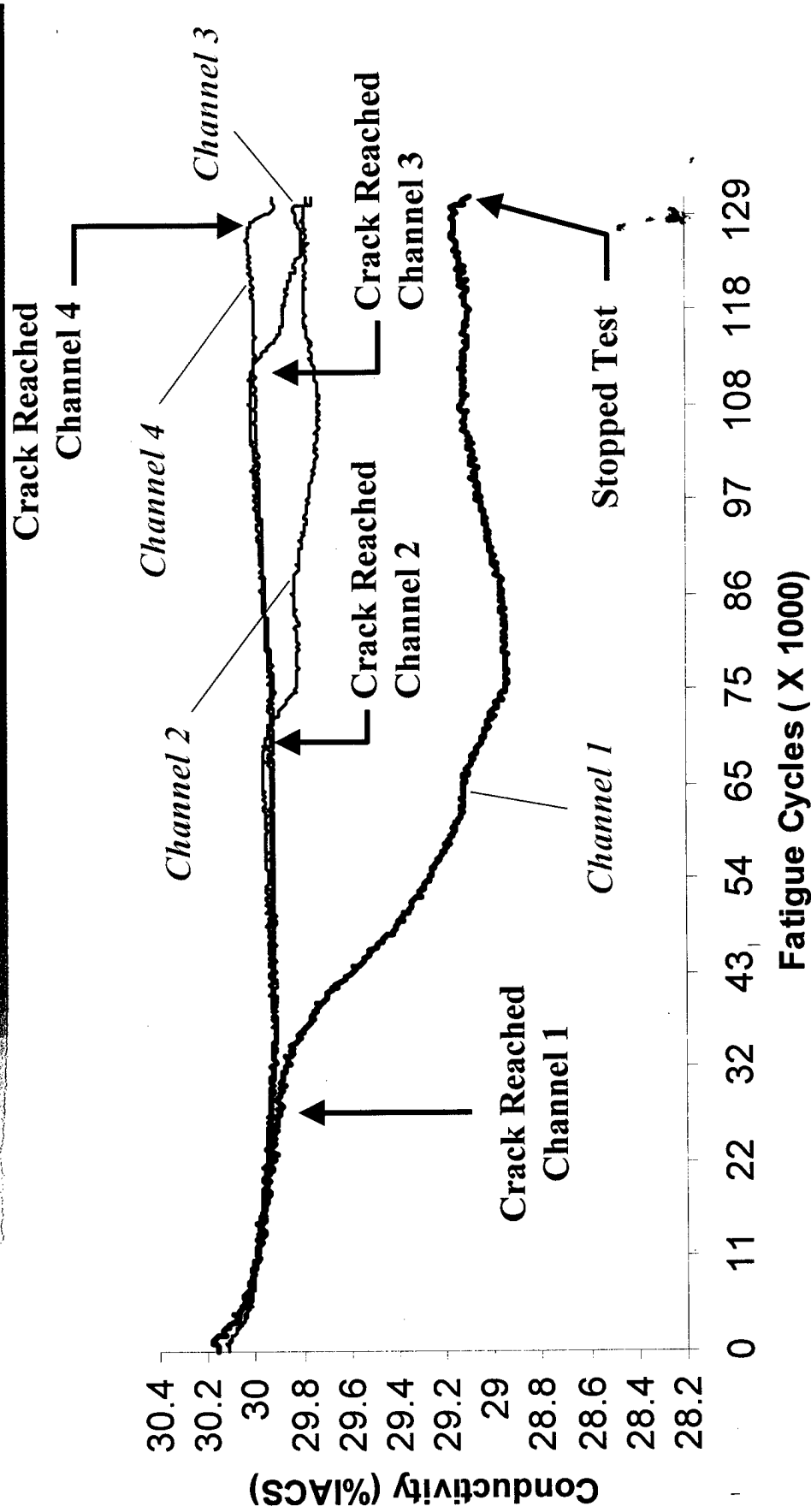



Estimated Crack Length vs. Number of Cycles

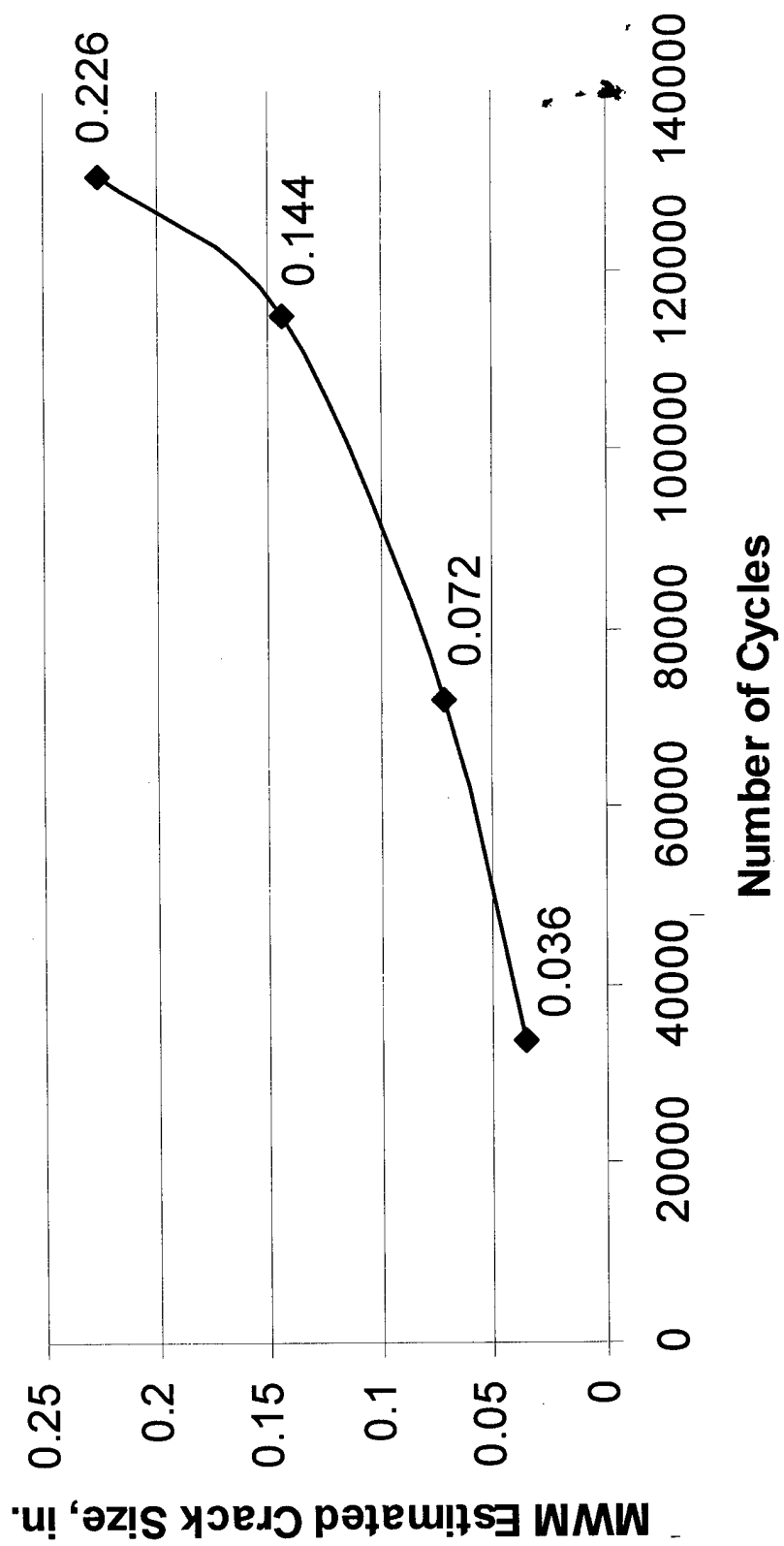



Planned Application of Jentek Sensors to FSFT



Using sensor as a scanning probe

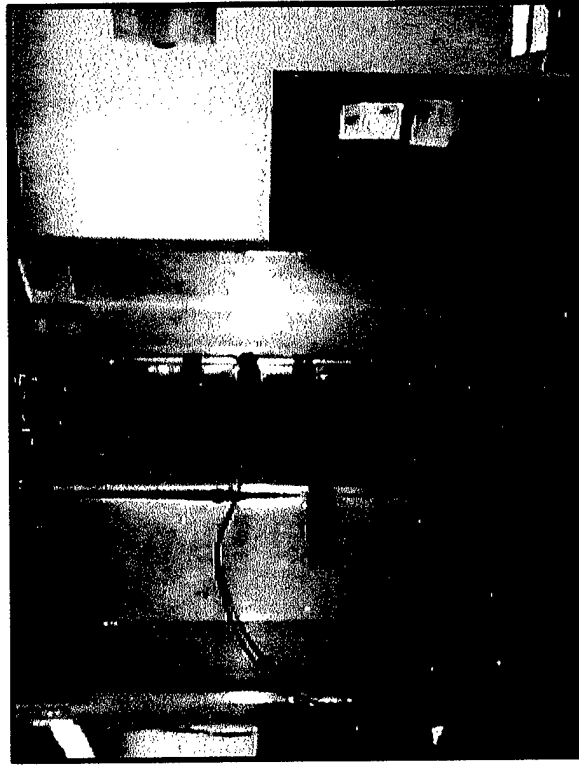

Acceptance demonstration using mounted sensor configuration



MWMI Sensor Locations

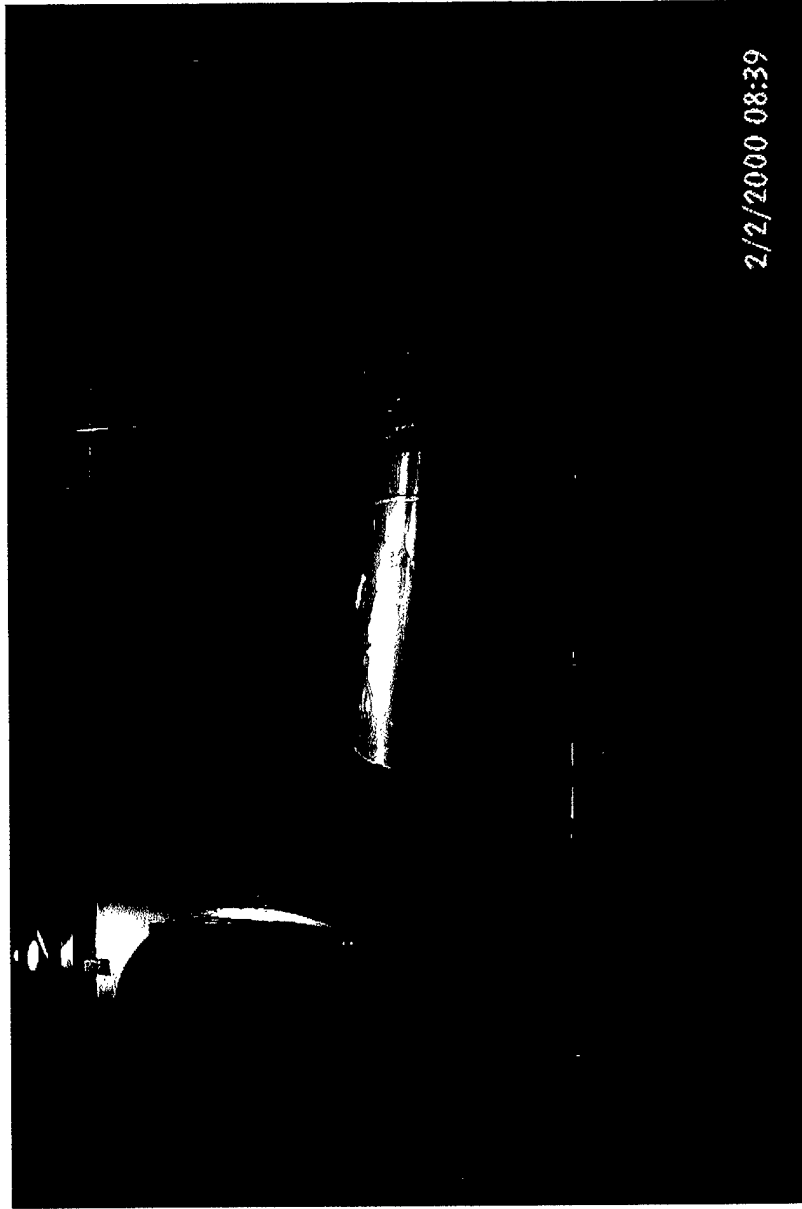

WS 167

BL 65
Wing Joint



Emerging NDI Acoustic Emission



- **Selected Acoustic Emission Technique**
 - **Dunegan Engineering Consultants**
 - **AESmart 2000 Fixed Asset System with 2 lines of 12 sensors each**
 - **Low cost system**
 - **Simple discrimination of noise and cracking**
 - **Successful demonstraton on skewed panel component test**
 - **Will be applied on the BL 65 lower front spar joint component test to refine final sensor placement**



Emerging NDI - Acoustic Emission



- Sample Test based on BL 65 area

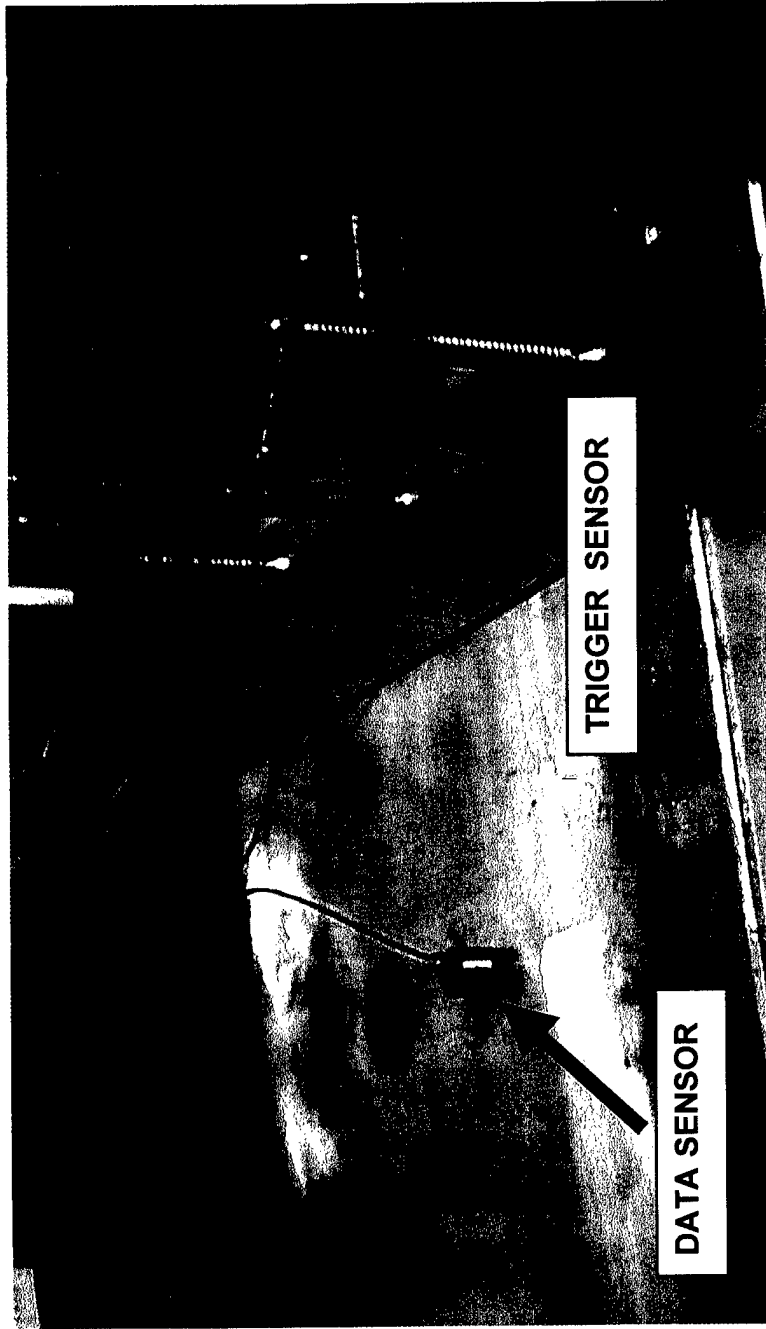



Emerging NDI - UT Imaging



- Ultra Image UT System (SAIC)
 - Scanning system for wing panel splice through sealant for 1st & 2nd layer crack detection
 - Baseline Scan completed in December

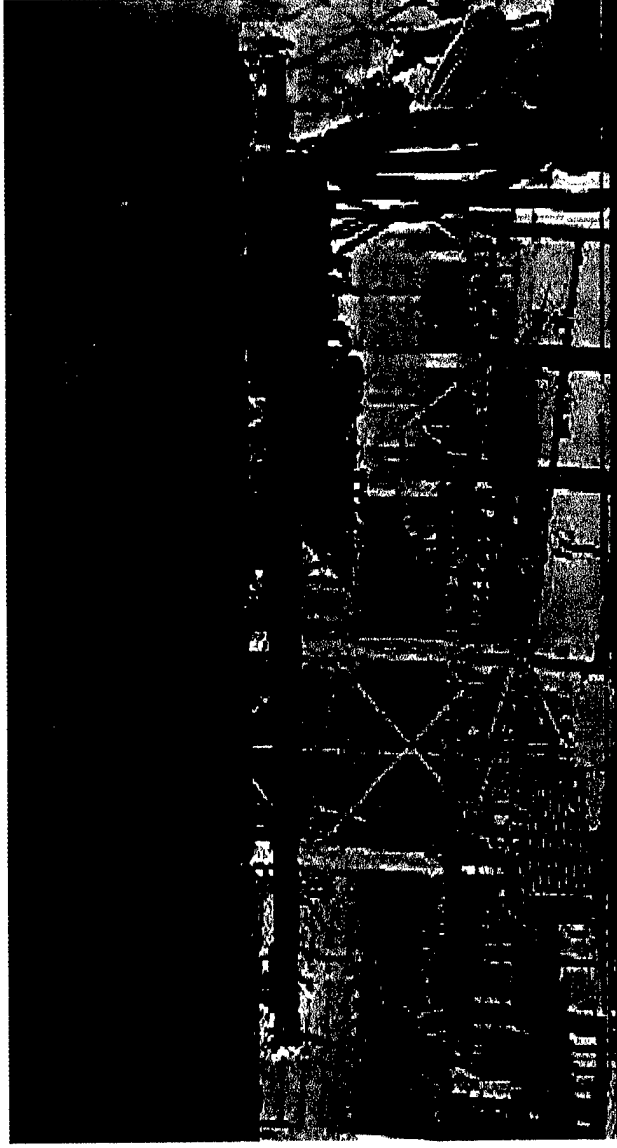

UT Imaging

(1st/2nd layer crack detection)

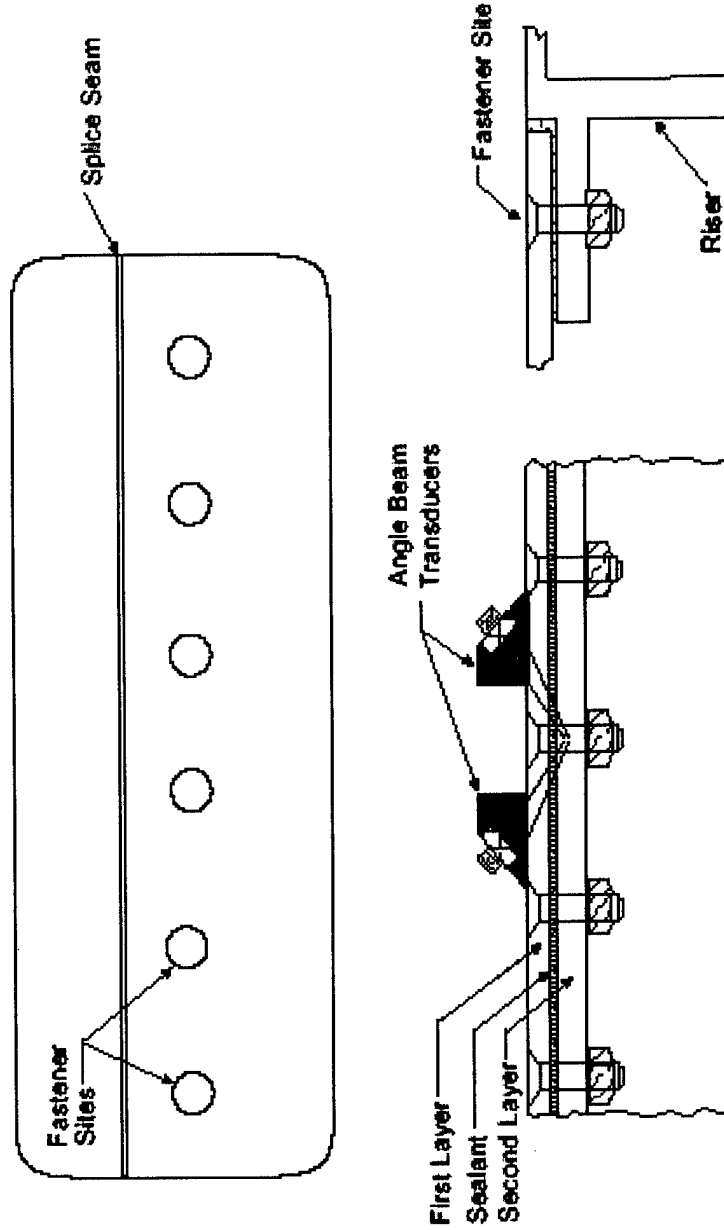

Ultrasonic Scan Set-up



UT Imaging

(1st/2nd layer crack detection)



Application to the P-3C SLAP Aircraft



UT Imaging

(1st/2nd layer crack detection)



C-Scan Image of Two Fasteners

(one with and one without a crack indication)

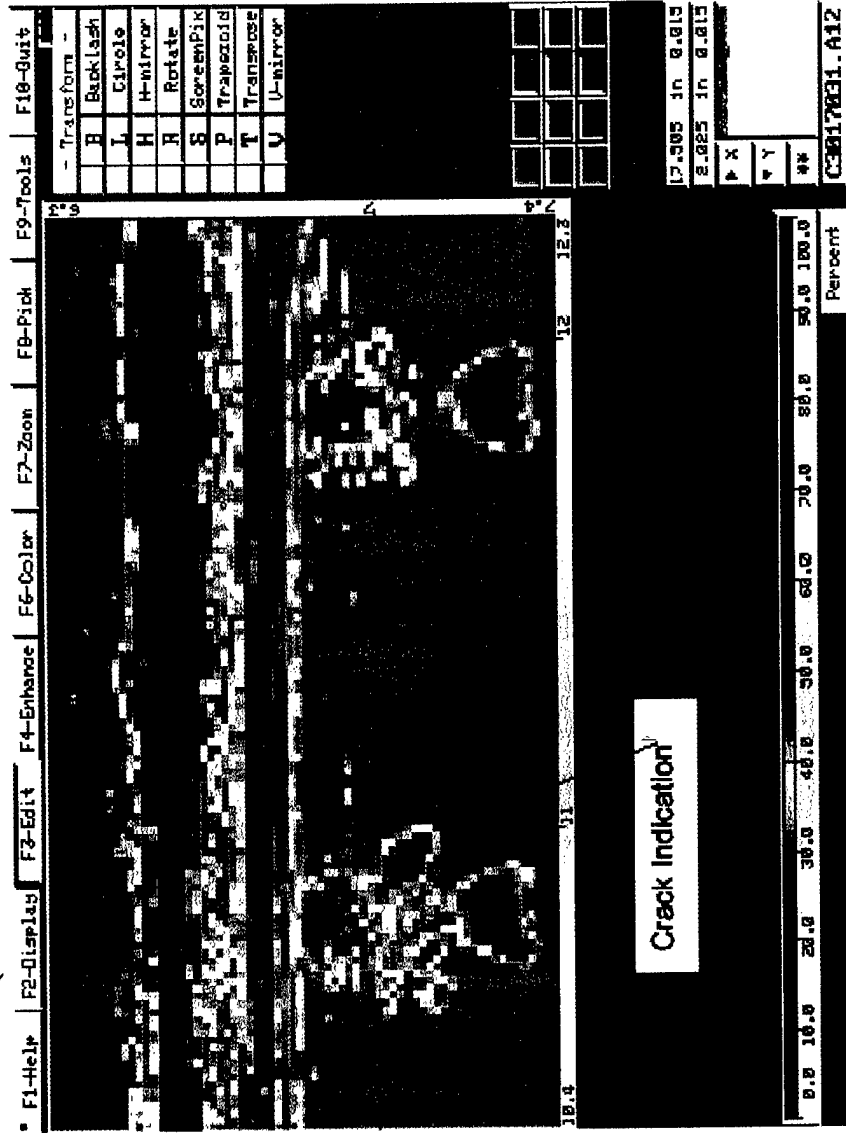



UT Imaging (1st/2nd layer crack detection)

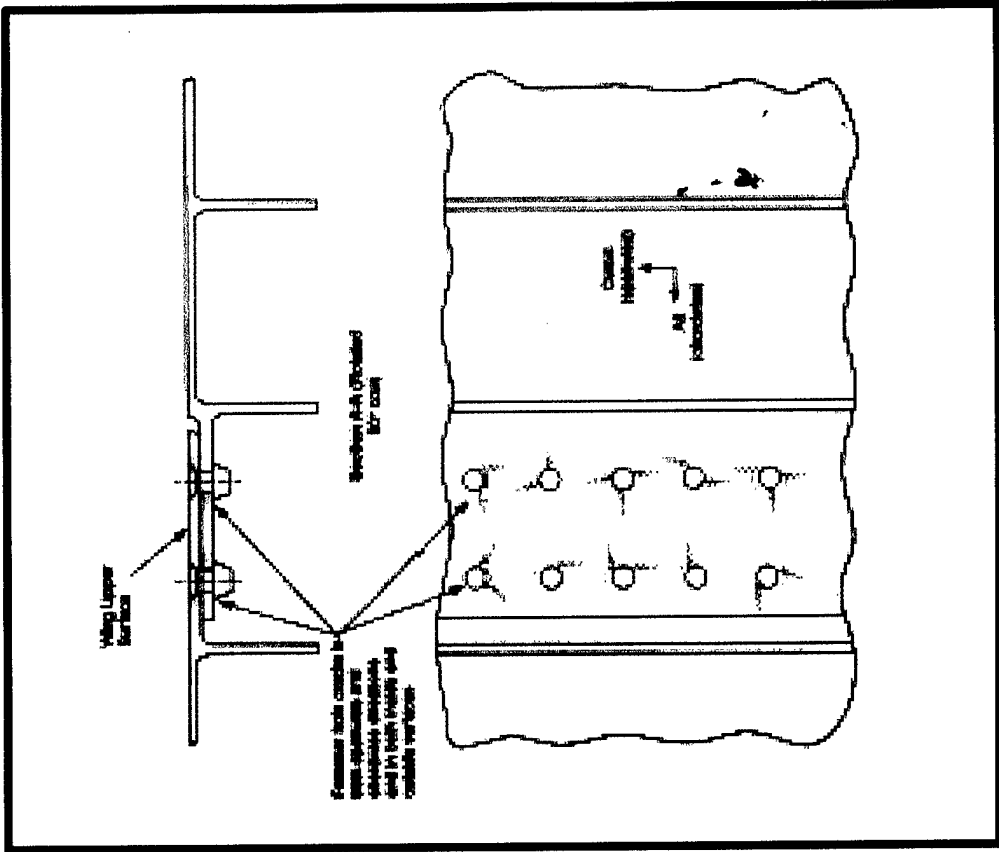
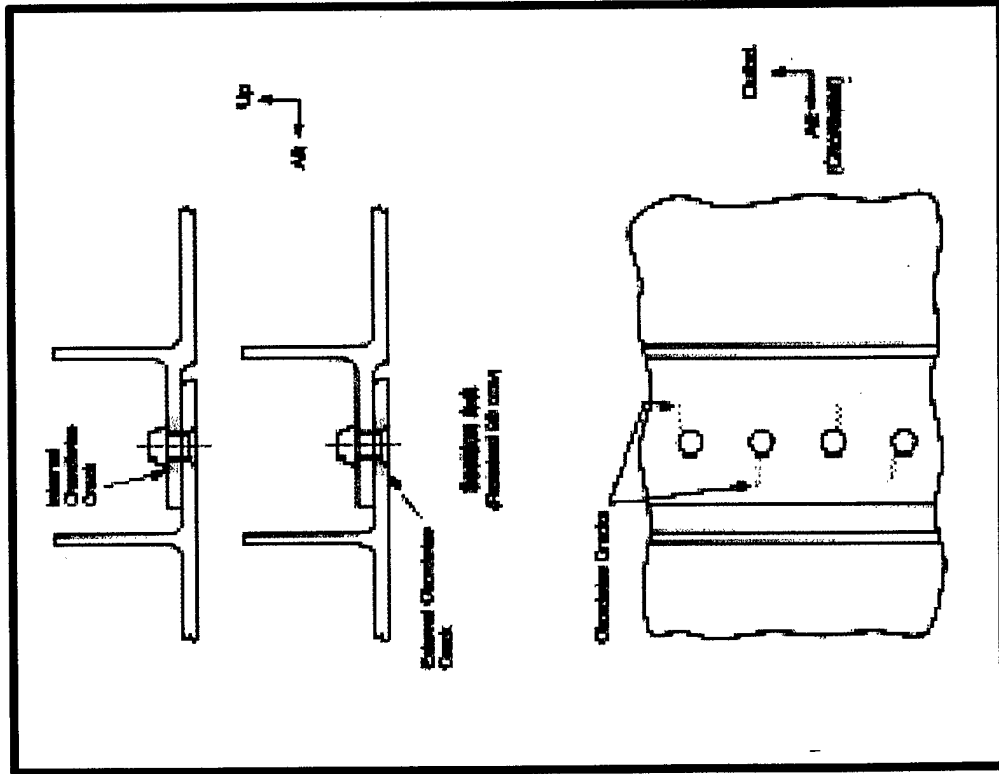



Emerging NDI - UT Imaging



- **ULTRA IMAGE IV** baseline performed. Post-test re-inspection planned
- **Imperium Ultrasonic Real-time Imaging System** will be applied when single-sided method is refined for detecting cracks under fasteners
- **RD Tech - Phased Array Probe:**
 - Prototype is being developed under an USAF sponsored program.
 - Prototype 1/4 circle array proof of concept tests (in water tank) - successful
 - Full system ECD May 15 for POD study at Sandia Laboratories



Reflection Imaging - Beamsplitter

(Imperium, Inc.)

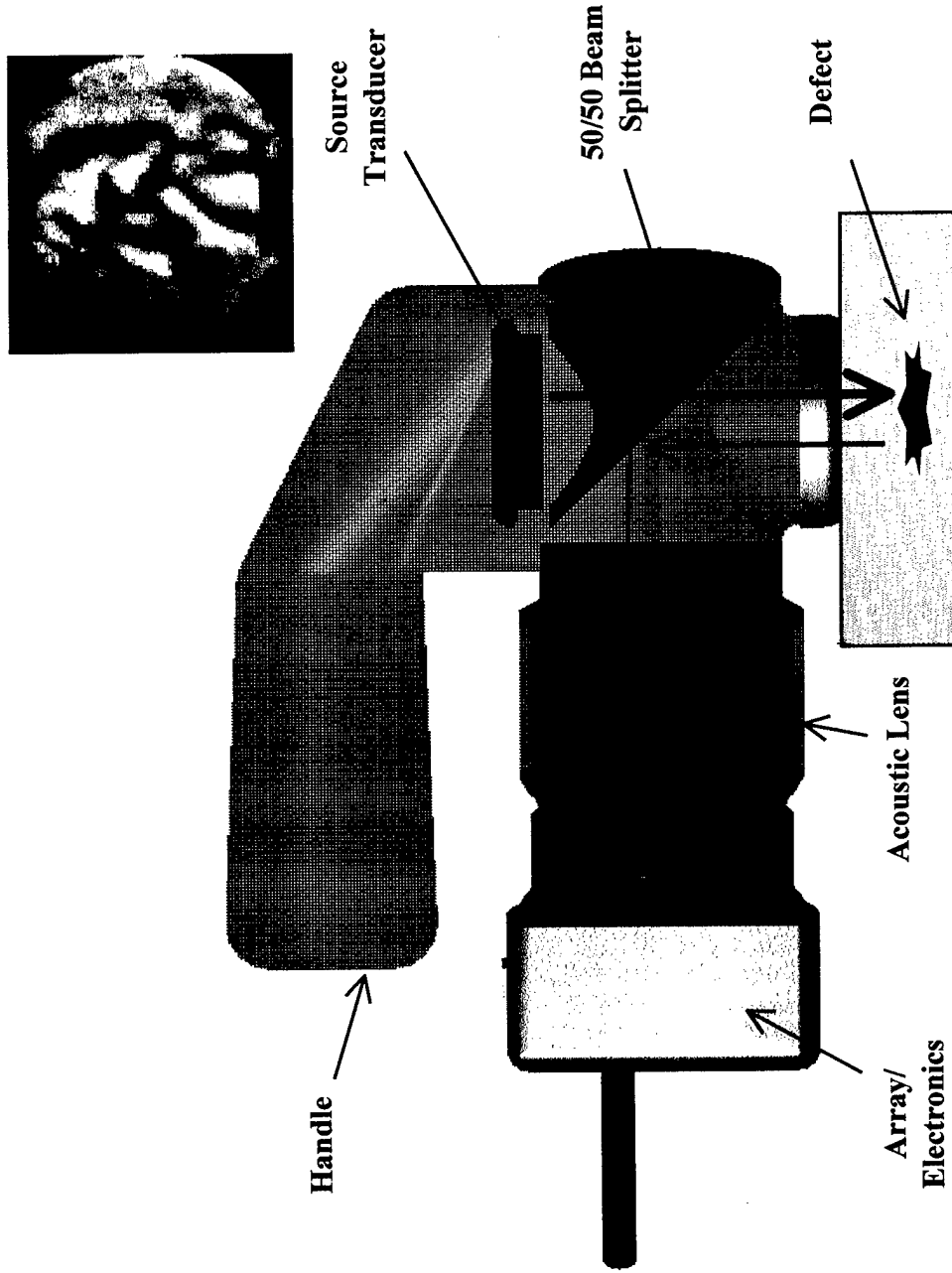



Improved Imaging System



- **High sensitivity, resolution, & dynamic range**
- **Range gating**
- **Small, portable (under 8 lbs.)**
- **Low power, battery operation**
- **PC based**
- **Minimum sensitivity 70 times I**
- **60 - 70 dB instantaneous dynamic range**
- **Up to 60 frames per second**
- **Range gate to 500 nanoseconds**

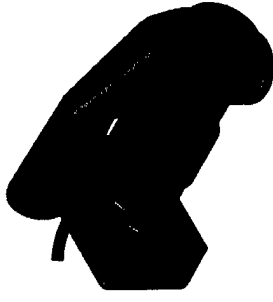



Emerging NDI/Sensors R/D Tech Phased Array

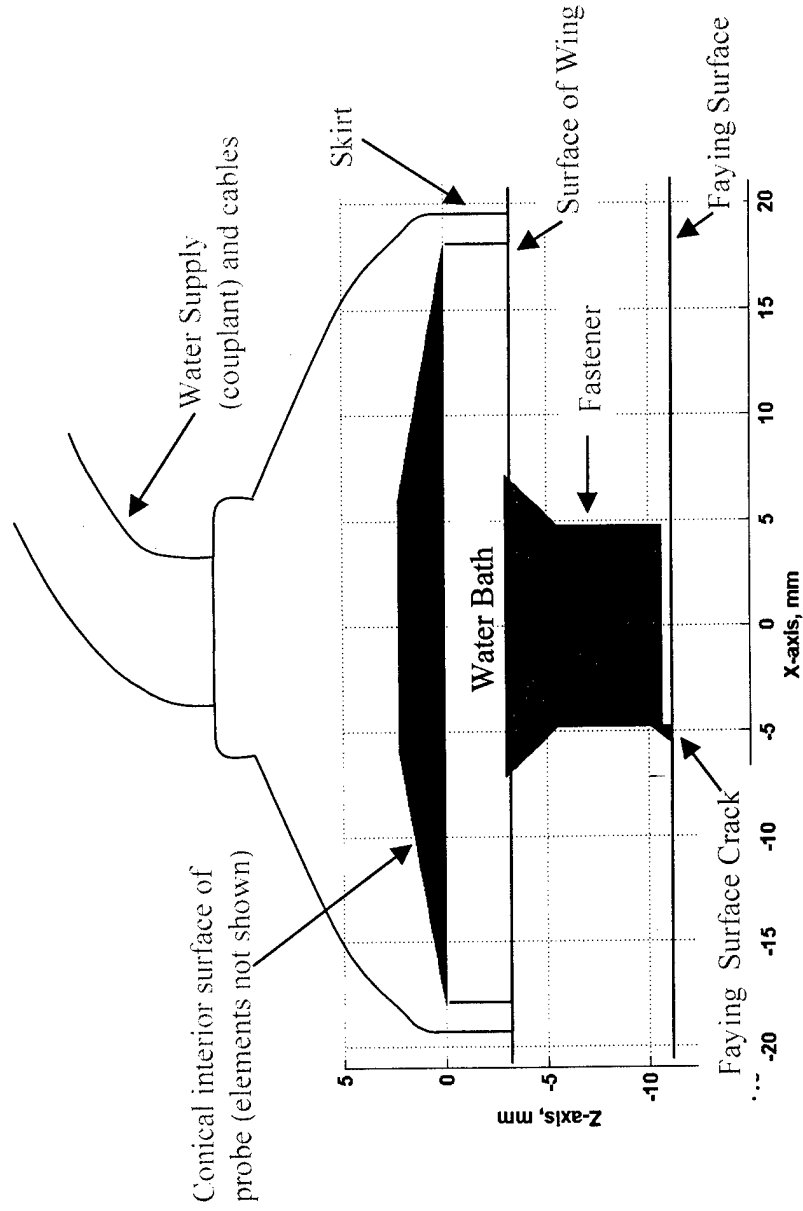



Operating Principle - Conical Matrix Array



Top View

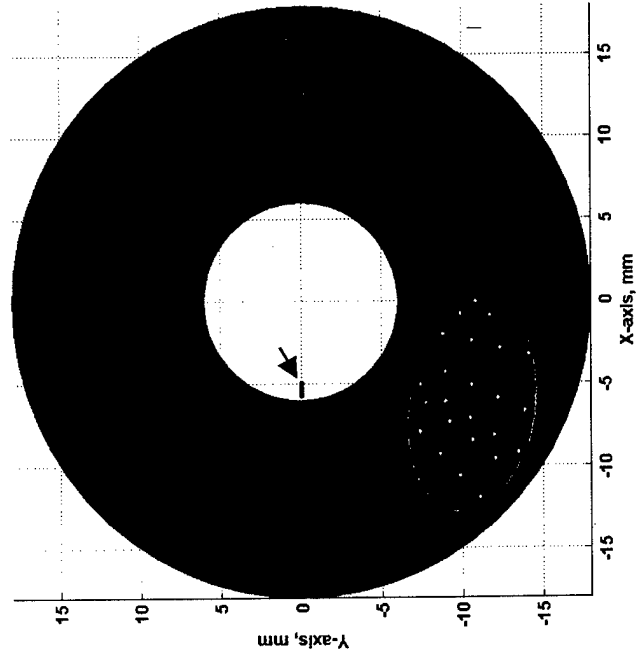

Side View

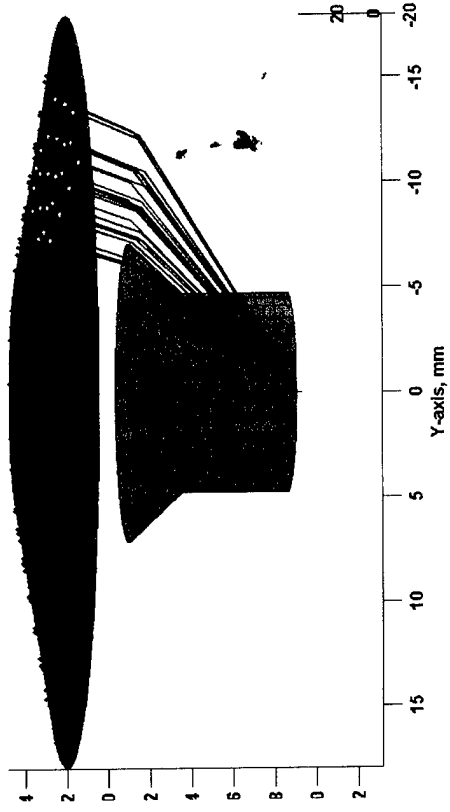



Emerging NDI/Sensors

(Low Frequency Eddy Current)



- **Hocking FastScan EC System procured for crack detection under fasteners**
- **0.060 crack detection capability in first layer (under fastener)**
- **Preliminary tests showed system to be limited to applications with fastener to fastener or fastener to edge spacing > 1 inch**
- **Design of custom dual frequency probe in work to minimize edge effects**



Hocking FastScan

(Eddy Current for Cracks under Fasteners)

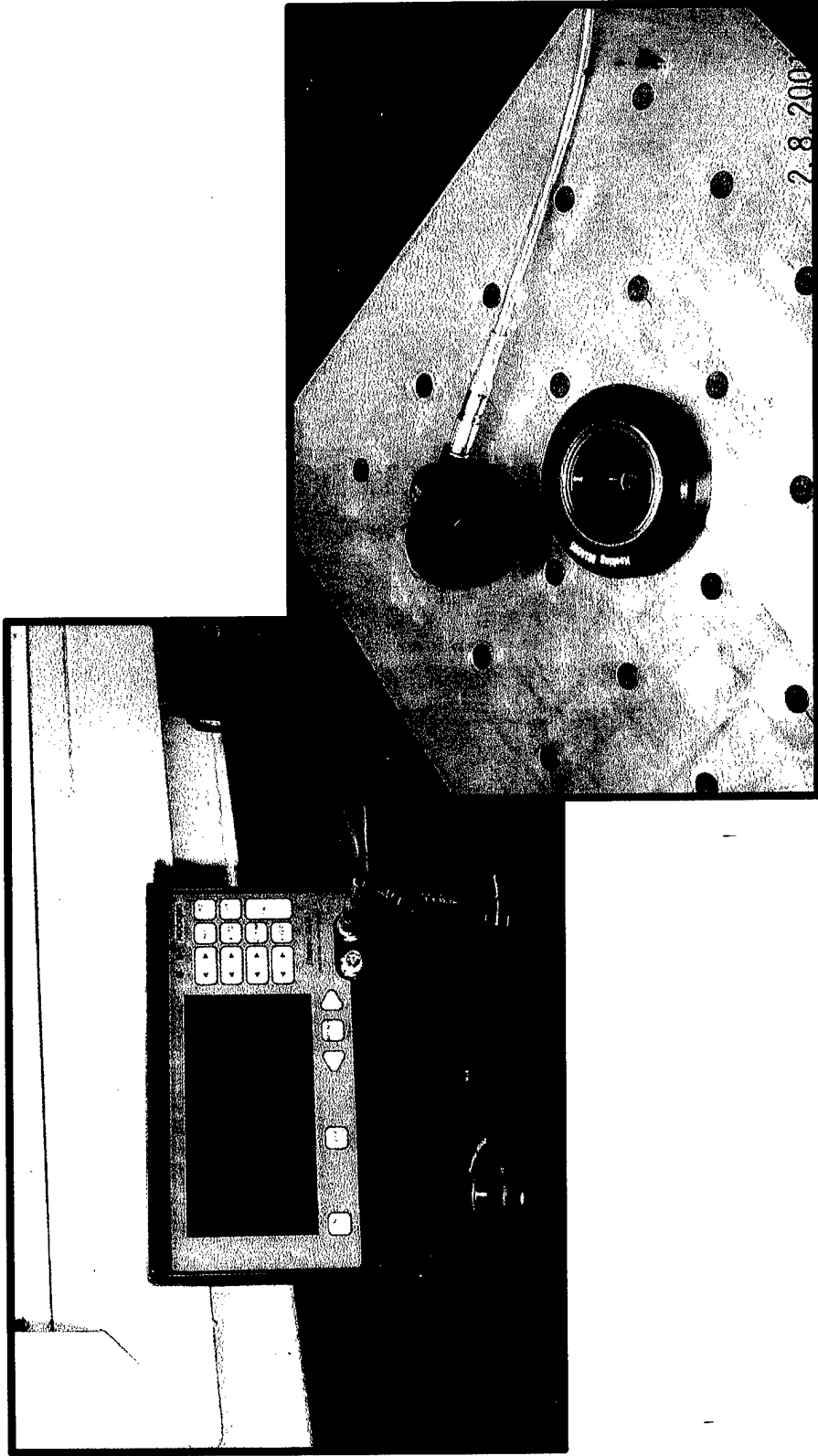



Status

• Emerging/Remote Sensing NDI

– Acoustic-thermography

- Utilizes high-energy ultrasonic energy induces rubbing at crack faces which generates enough heat to be detected by the infrared camera.
- Technology is extremely promising but not ready for transition.
- The US Navy has partnered with Boeing/Thermal Wave Imaging and Wayne State University in a Total Ownership Cost Program to transition this technology within 4 years.
- Application of acoustic-thermography is planned during the teardown inspections, which will be conducted in 2002.



ACCOMPLISHMENTS

Sonic Thermography



Inspection of Compressor Disk Section at Patuxent River NAS

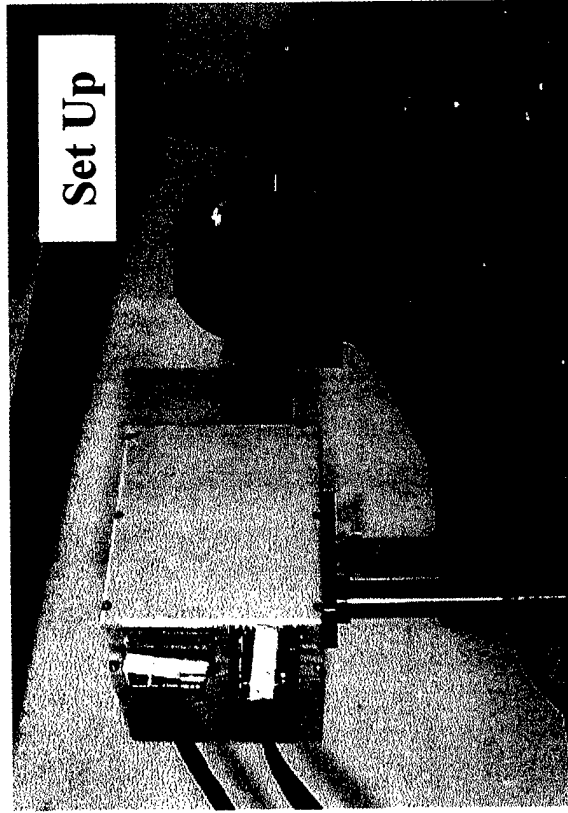

Test Piece



Two large cracks and two previously unsuspected cracks found



Fabry-Perot Interferometry Fiber Optic Strain Sensors

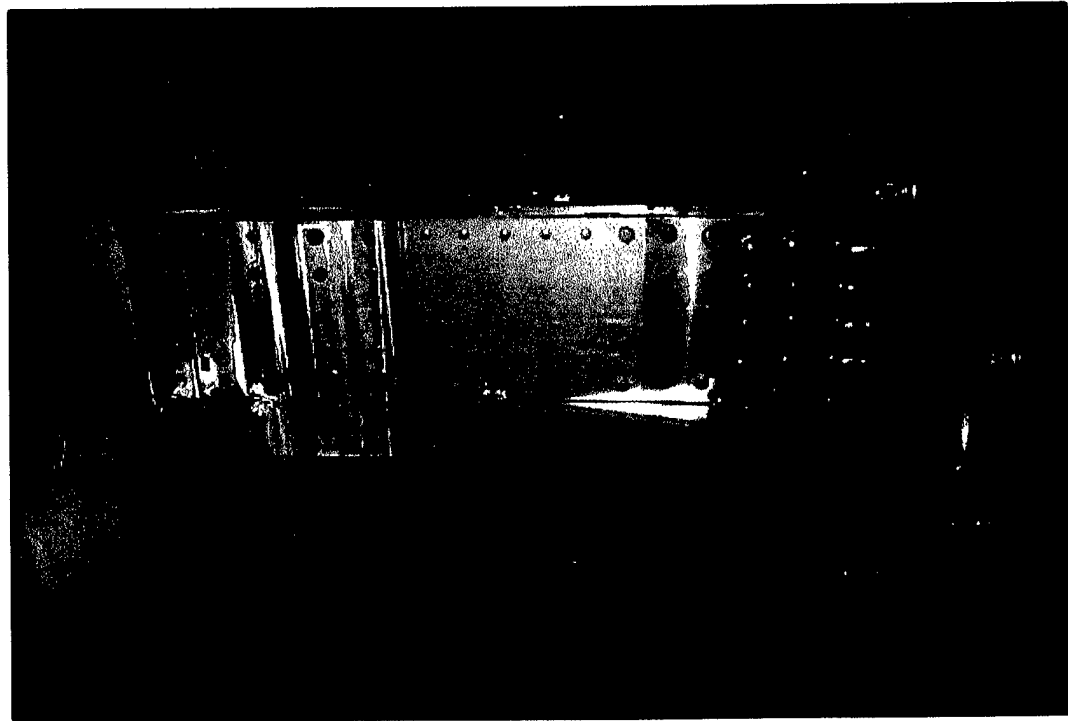

- Fiber optic strain sensors will be positioned on the wing/fuselage test article to investigate their suitability for instrumenting future fatigue-and flight-test aircraft
- Advantages are low weight, EMI immune, and ability to link multiple sensor on a single sensor string
- Issues include accuracy, durability, bonding, reliability, routing ease, and overall system weight.
- Other fiber optic sensors (including Bragg & LPG) that are currently available or under development:
 - Acoustic Emission Sensors
 - Chemical/Corrosion Sensors
 - Biological Sensors
 - Temperature Sensors
 - Pressure Sensors
 - Acceleration Sensors