

DOT/FAA/AR-01/13

Office of Aviation Research
Washington, D.C. 20591

Anti-Icing Endurance Time Tests of Two Certified SAE Type I Aircraft Deicing Fluids

DISTRIBUTION STATEMENT A
Approved for Public Release
Distribution Unlimited

April 2001

Final Report

This document is available to the U.S. public
through the National Technical Information
Service (NTIS), Springfield, Virginia 22161.



U.S. Department of Transportation
Federal Aviation Administration

20010802 045

NOTICE

This document is disseminated under the sponsorship of the U.S. Department of Transportation in the interest of information exchange. The United States Government assumes no liability for the contents or use thereof. The United States Government does not endorse products or manufacturers. Trade or manufacturer's names appear herein solely because they are considered essential to the objective of this report. This document does not constitute FAA certification policy. Consult your local FAA aircraft certification office as to its use.

This report is available at the Federal Aviation Administration William J. Hughes Technical Center's Full-Text Technical Reports page: actlibrary.tc.faa.gov in Adobe Acrobat portable document format (PDF).

1. Report No. DOT/FAA/AR-01/13		2. Government Accession No.		3. Recipient's Catalog No.	
4. Title and Subtitle ANTI-ICING ENDURANCE TIME TESTS OF TWO CERTIFIED SAE TYPE I AIRCRAFT DEICING FLUIDS				5. Report Date April 2001	
				6. Performing Organization Code	
7. Author(s) Kathy Bouchard, Jean-Louis Laforte, and Arlene Beisswenger				8. Performing Organization Report No.	
9. Performing Organization Name and Address Anti-icing Materials International Laboratory Université du Québec à Chicoutimi 555, boulevard de l'Université Chicoutimi, Québec G7H 2B1				10. Work Unit No. (TRAIS)	
				11. Contract or Grant No.	
12. Sponsoring Agency Name and Address U.S. Department of Transportation Federal Aviation Administration Office of Aviation Research Washington, DC 20591				13. Type of Report and Period Covered Final Report	
				14. Sponsoring Agency Code AFS-200	
15. Supplementary Notes The FAA William J. Hughes Technical Center COTR was Paul Boris.					
16. Abstract <p>This report presents the results of Anti-Icing Endurance Time (AET) tests performed with unsheared samples of two certified SAE Type I aircraft deicing fluids from September 5 to October 15, 1999, at the Anti-Icing Materials International Laboratory (AMIL). Over 100 tests, including 25 calibration and 50 fluid tests, were conducted at various temperatures and icing intensities, under the six environmental conditions addressed in the holdover time (HOT) guidelines published by the SAE as part of the ARP 4737: frost (3), freezing fog (6), snow (6), freezing drizzle (4), light freezing rain (4) and rain on a cold-soaked wing (2).</p> <p>The results obtained demonstrate the feasibility of performing the six AET testing procedures within the prescribed accuracy and repeatability. Indeed, environmental parameters in AET calibration and fluid tests were kept within the target values with variations within the allowable drifts. Moreover, AET results showed an expected inverse relationship between endurance times and precipitation rate; the shortest and longest failure times being obtained respectively under the highest and lowest icing rates.</p> <p>The AET test results were also compared and discussed with HOT data obtained in a parallel test set performed in July 1999 by APS Aviation (APS) at the Canadian National Research Council (NRC) facility. These tests include freezing fog, snow, freezing drizzle, and light freezing rain tests at -10°C, and rain on a cold-soaked wing at +1°C. However, their testing methods are somewhat different. AMIL failure times are systematically found to be 1 to 2 minutes shorter than APS's measured values for mean variation up to 30%, depending on test conditions. These lower failure times can be partially attributed to differences in procedures used during the test performance. This includes the effect of delay between fluid application and start of precipitation and the effect of volume of fluid applied on the anti-icing endurance time were checked.</p> <p>The results obtained will be useful to discuss the differences between test methods and, ultimately, obtain a single set of standardized procedures which reflect reality, allowing any testing facility to perform AET tests, and thus obtain the failure time intervals to be used to fill cells of the Type I holdover time table of the ARP 4737 guidelines.</p>					
17. Key Words Frost, Freezing fog, Freezing drizzle, Freezing rain, Snow, Anti-icing endurance time, Precipitation simulation, Holdover time, HOT table				18. Distribution Statement This document is available to the public through the National Technical Information Service (NTIS) Springfield, Virginia 22161.	
19. Security Classif. (of this report) Unclassified		20. Security Classif. (of this page) Unclassified		21. No. of Pages 68	
				22. Price	

TABLE OF CONTENTS

	Page
EXECUTIVE SUMMARY	ix
1. INTRODUCTION	1
1.1 Purpose	1
1.2 Background	1
2. SET OF TESTS AND CONDITIONS	2
2.1 Determination of the Set of Tests	2
2.2 Anti-Icing Endurance Time Test Condition Selection	5
3. EQUIPMENT, PRECIPITATION SIMULATION, AND CALIBRATION	5
3.1 Climatic Chambers	5
3.2 Frost Generation	5
3.3 Supercooled Precipitation Simulation	6
3.3.1 Freezing Fog Water Spray	7
3.3.2 Freezing Drizzle, Light Freezing Rain, and Rain on a Cold-Soaked Wing Water Spray	8
3.4 Snow Making, Storage, and Distribution System	9
3.4.1 Snow Making	9
3.4.2 Snow Storage	10
3.4.3 Snow Distribution System	10
3.5 Plate Setups	14
3.5.1 Frost Tests	14
3.5.2 Freezing Fog, Freezing Drizzle, and Light Freezing Rain	15
3.5.3 Rain on a Cold-Soaked Wing Test	18
3.6 Measured Parameters	18
3.7 Calibration	18
3.7.1 Frost Calibration	19
3.7.2 Freezing Fog, Freezing Drizzle, Light Freezing Rain, and Rain on a Cold-Soaked Wing Calibration	20

3.7.3	Snow Calibration	21
4.	RESULTS	21
4.1	Water Spray and High Humidity Endurance Tests (WSET and HHET)	21
4.2	Anti-icing Endurance Time Test Results	24
4.2.1	Methodology	24
4.2.1.1	Sample Dilution Preparation	24
4.2.1.2	Failure Criterion and Type	25
4.2.1.3	Measurements and Failure Recordings	26
4.2.2	Frost Tests	26
4.2.3	Freezing Fog Tests	29
4.2.4	Snow	32
4.2.5	Freezing Drizzle	35
4.2.6	Light Freezing Rain	38
4.2.7	Rain on a Cold-Soaked Wing	41
5.	COMPARISON BETWEEN AMIL AND APS RESULTS	45
5.1	Scope	45
5.2	Comparison of AMIL and APS Data	45
5.3	Comparison of AMIL and APS Testing Procedure	47
5.3.1	Sample Dilution	49
5.3.2	Amount of Fluid Applied and 5-Minute Delay	50
5.3.2.1	Five-Minute Delay Effect	53
5.3.2.2	One Thousand mL vs Five Hundred mL Applied Fluid Effect	53
5.3.3	Comparison of Endurance Time Under Similar Conditions	54
6.	CONCLUSIONS	54
7.	REFERENCES	55
8.	ADDITIONAL INFORMATION	56

LIST OF FIGURES

Figure		Page
1	Humidity Generator (Bird's Eye View of Bath)	6
2	Freezing Fog Water Droplet Size Distribution	7
3	Freezing Drizzle Water Droplet Size Distribution	8
4	Light Freezing Rain Water Droplet Size Distribution	9
5	Snow Box Mounted in its Support Above Test Plate	11
6	Snow Box on Track of Support	11
7	Cross Section of Snow Box	12
8	Side Views and Cross Section of Acetal Cylinder With Six Rows of Three Cavities Which Transfer Snow From the Box to the Test Plate	13
9	Frost Setup	14
10	Frost Test Plate Arrangement	14
11	Test Plate Supports Used for Freezing Drizzle and Light Freezing Rain Tests	15
12	Plate Arrangement in Freezing Drizzle and Light Freezing Rain Tests	16
13	Plate Arrangement in Freezing Fog Test	17
14	Cold Soak Box Plate Setup	18
15	Ice Catch Pan Arrangement in Freezing Drizzle and Light Freezing Rain Calibration Tests	19
16	Anti-Icing Endurance Time as Measured in WSET and HHET Tests	23
17	Frost Anti-Icing Endurance Times	28
18	Ice Front at -10°C, Typical of a Frost Failure	29
19	Ice Front at -10°C, Typical of a Failure in a Freezing Fog Test	31
20	Freezing Fog Endurance Times	32
21	Snow Anti-Icing Endurance Times	34
22	Slush at -10°C, Typical Snow Test Failure	35

23	Freezing Drizzle Endurance Times	37
24	Ice Front at -10°C, Typical of a Failure in a Freezing Drizzle Test	38
25	Light Freezing Rain Endurance Times	40
26	Speckled Ice Front at -10°C, Typical of a Failure in a Light Freezing Rain Test	41
27	Rain on a Cold-Soaked Wing Endurance Times	43
28	Failure in Rain on a Cold-Soaked Wing at +1°C	44
29	Air and Plate Temperature Recordings (a) Test With 5-Minute Delay and (b) Test Without Delay	51
30	Air and Plate Temperature Recordings (a) Test With 500 mL of Fluid Applied and (b) Test With 1000 mL of Fluid Applied	52

LIST OF TABLES

Table		Page
1	Society of Automotive Engineers Type I Fluid Holdover Table	3
2	Icing Intensity Corresponding to Time Values Given in the SAE HOT Type I Table	4
3	Selected AET Test Conditions With Their Allowable Fluctuations	5
4	Allowable Variation in Temperature and Icing Intensity for a Calibration Test	20
5	Water Spray and High Humidity Endurance Tests Results for OCTAFLO and ADF Concentrate Deicing Fluids	22
6	Fluid Dilution Selection and Identification	25
7	Frost Tests Results	27
8	Freezing Fog Results	30
9	Snow Test Results	33
10	Freezing Drizzle Test Results	36
11	Light Freezing Rain Test Results	39

12	Rain on a Cold Soak Box Test Results	42
13	Comparison of AMIL and APS Results	46
14	Anti-Icing Materials International Laboratory vs APS/NRC Test Conditions	48
15	Comparison of Differences Between OCTAFLO and ADF Values	49
16	Five-Minute Delay and Volume of Applied Fluid Effects	53
17	Light Freezing Rain vs Freezing Drizzle at 13 g/dm ² h	54

LIST OF SYMBOLS AND ACRONYMS

μm	micrometer (micron)
AET	Anti-Icing Endurance Time
AMIL	Anti-Icing Materials International Laboratory
APS	APS Aviation
CSW	Rain on a Cold-Soaked Wing
FAA	Federal Aviation Administration
FIE	First Ice Event
FOG	Freezing Fog
FP	Freezing Point
FRST	Frost
HHET	High Humidity Endurance Test
HOT	Holdover Time
kPa	Kilo Pascal
LZR	Light Freezing Rain
MIT	Mean Icing Time
MVD	Median Volume Diameter
NRC	National Research Council
OAT	Outside Air Temperature
PIL	Plate Icing Length
Rh	Relative Humidity
SAE	Society of Automotive Engineers
SNW	Snow
T_{air}	Air Temperature
T_{plate}	Plate Temperature
WSET	Water Spray Endurance Test
ZL	Freezing Drizzle

EXECUTIVE SUMMARY

This report presents the results of 50 anti-icing endurance time (AET) tests performed at the Anti-Icing Materials International Laboratory (AMIL) with unshered samples of two certified Society of Automotive Engineers (SAE) Type I aircraft deicing fluids: OCTAFLO of Octagon Process Inc. (propylene glycol-based) and ADF Concentrate of Union Carbide (ethylene glycol-based). The two candidate fluids were subjected to six different types of icing precipitation under various conditions of temperature and icing rate: frost (3 conditions), freezing fog and snow (6 conditions each), freezing drizzle and light freezing rain (4 conditions each), rain on a cold-soaked wing (2 conditions). Each type of precipitation with its specific condition are addressed in the holdover time (HOT) guidelines published by SAE as part of the ARP 4737 document to help the pilot and transport management assess the protection times of SAE Type I deicing fluids. The SAE G-12 Holdover Time Subcommittee is charged with establishing and updating these guidelines.

The first objective of this laboratory work was the determination of the anti-icing endurance times of two certified SAE Type I aircraft deicing fluids, under frost, freezing fog, snow, freezing drizzle, light freezing rain, and rain on a cold-soaked wing conditions at various temperatures and icing intensities. The second objective was the establishment of a comprehensive basis to analyze, compare, and discuss HOT data obtained by APS Aviation (APS) at the Canadian National Research Council (NRC) facility and, ultimately, the finalization of AET standardized procedures.

The laboratory tests were conducted from September 5 to October 15, 1999, under a Federal Aviation Administration (FAA) award following a recommendation made by the SAE G-12 Fluid Subcommittee meeting in Toronto on May 19, 1999, in order to investigate the difference between HOT testing methods and facilities. The AET testing procedures are based on the laboratory testing protocol established at the Montreal Fluid Subcommittee meeting held in March 1999 and revised accordingly in two subsequent meetings between APS/NRC and AMIL, the first held at Montreal on July 30, 1999, and the second at Chicoutimi on October 6, 1999.

The air temperature conditions in the AET tests are -3° and -10°C for freezing drizzle and light freezing rain; -3° , -10° , and -25°C for freezing fog and snow; 0° , -10° , and -25°C for frost; and $+1^{\circ}\text{C}$ for rain on a cold-soaked wing. For frost, fluids are tested at only one icing intensity at each temperature, i.e., -3° , -10° , and -25°C . For all other types of precipitation, fluids are tested at two precipitation rates corresponding to light and moderate icing intensities. All tests were conducted in climatic chambers with specialized equipment and a valid calibration test. To determine the distribution of icing intensity, an individual calibration was conducted before testing a fluid under each AET condition.

Frost requires a humidity generating system consisted of a water bath and a "frosticator" which cools the test panels to a temperature 3°C below that of the air during a test. Freezing fog, freezing drizzle, and light freezing rain tests are conducted similarly, with the height and the size of the supercooled water droplets different for each type of precipitation. The snow tests were conducted in a two step process: the first of which consists of making artificial snow in the form of agglomerates of tiny frozen droplets of about 20-40 μm in diameter. The second step consists of distributing the snow in an even manner over the test plate by means of an automated system.

For the rain on a cold-soaked wing simulation, a cold soak box is used to cool the test plate below the air temperature.

For all tests but frost, the fluid test panels were 500 mm long, 300 mm wide and 3.2 mm thick. For frost, the panels are 300 mm long, 100 mm wide and 1.6 mm thick. They were at the air temperature at the beginning of the test but are free to vary during the test. For frost, test plates are maintained at a prescribed temperature throughout the test by means of a special cooling system. For rain on a cold-soaked wing, the test plate is at -10°C at the beginning of the test and is free to vary during the test. In all AET tests with the exception of frost, failure is called when 30% of the plate is covered with frozen contamination. In frost tests, failure is called when there is a 50% ice-covering of the plate because of the smaller plates. The following measurements are performed for each AET tests: icing intensity, anti-icing endurance times, photographs of the ice front at failure as well as continuous recordings of air and plate temperature and humidity.

Sheared and unsheared samples of the two candidate fluids, were first subjected to two standard laboratory tests: the Water Spray Endurance Test (WSET) and the High Humidity Endurance Test (HHET), to ensure that anti-icing endurance times exceed the minimum prescribed values of 3 and 20 minutes respectively, confirming they are SAE Type I approved fluids. For both fluids, the First Ice Event (FIE) or AET exceeded the minimum values specified for WSET and HHET for an SAE Type I fluid.

In the AET tests of OCTAFLO and ADF Concentrate, when results of the two tested samples are compared, time variations of 1 minute or less are generally observed between the endurance times measured with the same sample. These variations do not appear dependent on the fluid nor the testing temperature. The 1-minute variation is considered to be within the experimental error of measurement.

The AET results were also compared and discussed with HOT data obtained by APS in a parallel test set conducted in July 1999 at the NRC facility using a somewhat different test method. The compared tests include freezing fog, freezing drizzle, light freezing rain, and snow tests performed at -10°C , and for rain on a cold-soaked wing at $+1^{\circ}\text{C}$. AMIL failure times were generally 1 to 2 minutes shorter than APS's measured values, resulting in an average difference of 30% (depending on tests). As the failure times obtained with Type I fluids are shorter, when compared to those of Type II and IV fluids, the relatively short times have the effect to overvalue these differences when expressed as percentages. Considering a 1-minute time variation could be within the expected acceptable experimental error of measurement.

An examination of APS and AMIL testing procedures allows for the identification of thirteen differences, among which the following six can be judged more significant: the plate working area, the sample dilution, the failure call, the precipitation rate measurement method, the amount of fluid applied and finally, the 5-minute delay prior to the start of precipitation. The last two factors may partially explain the 1 to 2 minutes lower failure times observed. This interpretation is supported by the results obtained by two tests in which effects of these two factors were compared.

These results will be useful in evaluating differences between APS/NRC and AMIL procedures in order to ultimately finalize a single set of procedures to be approved and published. As a consequence, any testing facility, with the appropriate capability, could perform AET tests according to an approved procedure and thus obtain the HOT values which can be used by the SAE committees responsible of substantiating the HOT tables of the current ARP 4737 guidelines. On the basis of the test results obtained with the two Type I fluids, individual cells of the Type I HOT table substantiated using the APS and AMIL data, would show lower time intervals by comparison to numbers of the generic Type I HOT table actually in use.

In the process of reducing the number of parameters which are not the same in the APS/NRC and AMIL procedures, it is recommended that each parameter for which a difference is identified in this report be analyzed and discussed. In order to realize this, real conditions and actual practices of using fluids in airports during deicing and anti-icing operations should be taken into consideration, as well as the feasibility of performing reproducible tests in a laboratory.

1. INTRODUCTION.

1.1 PURPOSE.

The first objective of this work is the determination of anti-icing endurance times (AET) of two certified Society of Automotive Engineers (SAE) Type I aircraft deicing fluids under the following six environmental conditions: frost, freezing fog, snow, freezing drizzle, light freezing rain, and rain on a cold-soaked wing. Each of these conditions are addressed in the holdover time (HOT) tables published by SAE as part of the ARP 4737 standard as guidelines to help pilots and transport management assess the protection time of certified deicing and anti-icing fluids. Results obtained by these AET tests with two Type I deicing fluids are to be compared with HOT values of the current Type I table published by SAE and cells not in agreement with the table will be identified. The Holdover Time SAE G-12 Subcommittee is in charge of establishing and updating these guidelines.

The second objective is the establishment of a comprehensive basis to compare and discuss data obtained by APS Aviation (APS) in the National Research Council (NRC) laboratory and ultimately to finalize standardized Anti-icing Endurance Time test procedures. The discussion and the finalization of AET procedures are to be done among representatives of Anti-Icing Materials International Laboratory (AMIL) and APS with the presence of the Federal Aviation Administration (FAA), Transportation Development Center (TDC) and the SAE G-12 Holdover Time subcommittee.

The laboratory tests were conducted from September 5 to October 15, 1999, under a Federal Aviation Administration (FAA) award following a recommendation made by the SAE G-12 Fluid Subcommittee meeting in Toronto on May 19, 1999, [1] in order to investigate on the difference between HOT testing methods and facilities. The AET testing procedures are based on the laboratory testing protocol established at the Montreal Fluid Subcommittee meeting held in March 1999 [2] and revised accordingly in two subsequent meetings between APS/NRC and AMIL, the first held at Montreal on July 30, 1999, [3] and the second at Chicoutimi on October 6, 1999 [4]. The procedures are detailed in reference 5.

Appendices referenced in this report contain details pertaining to various aspects of the test program. Due to the combined length of all the appendices, they are not appended to this report. The details noted in these appendices are referenced in the body of the text and are not necessary for the overall comprehension of the tests and results described.

1.2 BACKGROUND.

Deicing and anti-icing fluids are commonly used during the winter to remove and prevent aircraft contamination by any frozen deposit while on the ground. Anti-icing fluids are able to protect the aircraft for a time period that depends on environmental conditions including the nature of precipitation, the outside air temperature (OAT), and the precipitation intensity.

The FAA's William J. Hughes Technical Center continues to support research and related efforts directed toward the improvement of aircraft deicing methods and practices. One such effort is the standardization of HOT test procedures for deicing fluids. In the past, HOT testing has

largely been performed by APS of Montreal, Canada. In general the international aviation community has accepted the APS results. AMIL an accredited anti-icing laboratory, was tasked by the SAE G-12 Holdover Time Subcommittee meeting in Zurich on May 21, 1996, [6] to prepare HOT test procedures that could be performed in a laboratory environment. In the review of these procedures, discrepancies were noted between HOT values obtained by the two facilities, i.e., APS/NRC and AMIL. This points out the necessity to standardize the testing method, procedures, environmental test conditions, and interpretation of fluid failure in order to eliminate disagreements among testing facilities. Such standardization would allow any testing facility, with the appropriate capability, to perform HOT testing by adhering to an approved published procedure.

HOT tables for SAE Type I fluids have virtually remained unchanged since they were initially published in 1992. Some of the fluids that were used to establish this table are no longer in production; and new fluids that have been introduced since are assumed to meet the holdover time guidelines of this table. As a first step in the standardization of holdover time testing, following the May 1999 recommendation of the SAE G-12 Fluid Subcommittee [7], the FAA proposed to subject two currently approved Type I fluids, one ethylene glycol-(EG) and one propylene glycol-(PG) based, to the anti-icing endurance time methods and procedures at AMIL. Prior to testing, the procedures were discussed and coordinated between AMIL and APS with the concurrence of the FAA and TDC in two meetings; the first held at Montreal on July 30, 1999, [3] and the second at Chicoutimi on October 6, 1999 [4]. This is a draft version to be discussed further in subsequent SAE Fluids, and Holdover Time Subcommittee meetings.

The intent of this work is, ultimately, to determine the variation between the two methods and facilities and to compare, reconcile, and ideally, establish a single set of procedures to be published after concurrence by the SAE G-12 Fluids and Holdover Time subcommittees. One of the expected outcomes of such testing will be the substantiation of the current Type I HOT table. Once substantiated, new fluids will have to be tested according to the AET set of tests and the generic table adjusted accordingly prior to their use.

2. SET OF TESTS AND CONDITIONS.

2.1 DETERMINATION OF THE SET OF TESTS.

The set of tests to be conducted was determined in accordance with the first objective, that is, the determination of the anti-icing endurance times of two certified SAE Type I aircraft deicing fluids under the six different types of iced precipitation shown in the SAE Type I holdover time (HOT) table: frost, freezing fog, snow, freezing drizzle, light freezing rain, and rain on a cold-soaked wing. The most recent version of the SAE Type I fluid HOT table published in August 1999 is presented in table 1. This is a generic table which applies to all certified SAE Type I fluids.

Each column of table 1 corresponds to one type of icing precipitation, and is divided into one to three individual cells. With the exception of the frost, each cell is dependent on the OAT and comprises two numbers. These numbers correspond to time values expressed in minutes which delimit the interval of the protection times which can be expected for a SAE Type I fluid at that OAT. The larger number corresponds to HOT values expected under light icing conditions at the

TABLE 1. SOCIETY OF AUTOMOTIVE ENGINEERS TYPE I FLUID HOLDOVER TABLE

SAE TYPE I FLUID HOLDOVER TABLE

Guideline for Holdover Times Anticipated for SAE Type I Fluid Mixture as a Function of Weather Conditions and OAT

THE RESPONSIBILITY FOR THE APPLICATION OF THESE DATA REMAINS WITH THE USER

OAT		Approximate Holdover Times Under Various Weather Conditions (hours:minutes)						
°C	°F	FROST ¹	FREEZING FOG	MODERATE SNOW	FREEZING DRIZZLE ²	LIGHT FREEZING RAIN	RAIN ON COLD SOAKED WING	OTHER ³
above 0°	above 32°	0:45	0:12 - 0:30	0:06 - 0:15	0:05 - 0:08	0:02 - 0:05	0:02 - 0:05	
0 to -10	32 to 14	0:45	0:06 - 0:15	0:06 - 0:15	0:05 - 0:08	0:02 - 0:05		
below -10	below 14	0:45	0:06 - 0:15	0:06 - 0:15				

CAUTION:
No holdover time
guidelines exist

°C = Degrees Celsius OAT = Outside Air Temperature
°F = Degrees Fahrenheit FP = Freezing Point

NOTES

- 1 During conditions that apply to aircraft protection for ACTIVE FROST.
- 2 Use light freezing rain holdover times if positive identification of freezing drizzle is not possible.
- 3 Heavy snow, snow pellets, snow grains, ice pellets, moderate and heavy freezing rain, and hail.

SAE Type I Fluid / Water Mixture is selected so that the FP of the mixture is at least 10°C (18°F) below OAT.

CAUTIONS:

THE TIME OF PROTECTION WILL BE SHORTENED IN HEAVY WEATHER CONDITIONS, HEAVY PRECIPITATION RATES OR HIGH MOISTURE CONTENT. HIGH WIND VELOCITY OR JET BLAST MAY REDUCE HOLDOVER TIME BELOW THE LOWEST TIME STATED IN THE RANGE. HOLDOVER TIME MAY ALSO BE REDUCED WHEN AIRCRAFT SKIN TEMPERATURE IS LOWER THAN OAT. THE ONLY ACCEPTABLE DECISION CRITERIA TIME IS THE SHORTEST TIME WITHIN THE APPLICABLE HOLDOVER TIME TABLE CELL.

FLUIDS USED DURING GROUND DEICING ARE NOT INTENDED FOR AND DO NOT PROVIDE ICE PROTECTION DURING FLIGHT.

cell temperature while the smaller one is the protection time expected under moderate icing conditions. Light, moderate, and heavy or severe are relative terms and could be confusing. Although these terms appear in various meteorological charts, frequently with associated intensity criteria, it, nevertheless, can be a source of dispute. Therefore, for this report, the extremes of icing intensity for each precipitation test condition will be referred to as the lower and the higher icing intensity.

The values of anti-icing endurance times obtained in AET tests performed in the present work are to be used to fill individual cells of the HOT table shown in table 1. Intensities regarding the shortest and longest times to consider are noted in table 2. They have been tentatively established at the November 97 SAE G-12 Subcommittee meeting held in Montreal [2] with the latest revision issued after a meeting held in Chicoutimi on October 6, 1999 [4].

- The shortest time will represent the holdover time obtained with a fluid tested at the highest icing intensity for this cell;
- The longest time will represent the holdover time obtained with a fluid tested at the lowest icing intensity for this cell;
- The high and low icing intensity are to be determined by meteorological standards modified to take into account the likelihood of an icing intensity at a given temperature.

The set of icing intensity intervals was selected on this basis for each cell of the table 1. The conditions which are specifically applicable for an SAE Type I fluid are in table 2. For a Type I fluid, three temperature intervals are currently given in the HOT table depending on the type of precipitation: above 0°C, 0° to -10°C, and below -10°C. In each cell of this table, the high and low icing intensity values are shown in **bold** and *italics*, respectively. For frost, only one value is presented in each cell and the temperature corresponds to the air temperature (except for -3°C) while the plate temperature is 3°C below this value.

TABLE 2. ICING INTENSITY CORRESPONDING TO TIME VALUES
GIVEN IN THE SAE HOT TYPE I TABLE

Test Temp. (°C)	Icing Intensities Under Various Weather Conditions, g/dm ² h					
	Frost	Freezing Fog	Snow	Freezing Drizzle	Light Freezing Rain	Rain on a Cold-Soaked Wing*
-3 ⁽¹⁾	0.2	5 - <i>2</i>	25 - <i>10</i>	13 - <i>5</i>	25 - <i>13</i>	75 - <i>5</i>
-10 ⁽²⁾	0.15	5 - <i>2</i>	25 - <i>10</i>	13 - <i>5</i>	25 - <i>13</i>	
-25 ⁽³⁾	0.06	5 - <i>2</i>	25 - <i>10</i>			

For Frost, ⁽¹⁾T_{air} = 0°C T_{plates} = -3°C, ⁽²⁾T_{air} = -10°C T_{plates} = -13°C, ⁽³⁾T_{air} = -25°C T_{plates} = -28°C

*For rain on a cold-soaked wing, T_{air} = +1°C

2.2 ANTI-ICING ENDURANCE TIME TEST CONDITION SELECTION.

Table 3 presents the particular environmental conditions of temperature and icing intensities with their allowable variations that were retained for the different AET tests selected for the present testing program. For frost, the plate temperature is -3°C lower than the air temperature. For the five other tests, plate temperature is the same as the air temperature.

TABLE 3. SELECTED AET TEST CONDITIONS WITH THEIR ALLOWABLE FLUCTUATIONS

Test Temp. ($^{\circ}\text{C}$)	Icing Intensities Under Various Weather Conditions, $\text{g}/\text{dm}^2\text{h}$					
	Frost	Freezing Fog	Snow	Freezing Drizzle	Light Freezing Rain	Rain on a Cold-Soaked Wing*
$-3 \pm 0.5^{(1)}$	0.2 ± 0.02	2 ± 0.2	10 ± 0.5	5 ± 0.2	13 ± 0.5	5 ± 0.2
		5 ± 0.3	25 ± 1.0	13 ± 0.5	25 ± 1.0	75 ± 3.0
$-10 \pm 0.5^{(2)}$	0.15 ± 0.02	2 ± 0.2	10 ± 0.5	5 ± 0.2	13 ± 0.5	
		5 ± 0.3	25 ± 1.0	13 ± 0.5	25 ± 1.0	
$-25 \pm 1.0^{(3)}$	0.06 ± 0.01	2 ± 0.2	5 ± 0.2			
		5 ± 0.3	10 ± 0.5			

For frost, $^{(1)}T_{\text{air}} = 0^{\circ}\text{C}$ $T_{\text{plates}} = -3^{\circ}\text{C}$, $^{(2)}T_{\text{air}} = -10^{\circ}\text{C}$ $T_{\text{plates}} = -13^{\circ}\text{C}$, $^{(3)}T_{\text{air}} = -25^{\circ}\text{C}$ $T_{\text{plates}} = -28^{\circ}\text{C}$

*For rain on a cold-soaked wing, $T_{\text{air}} = +1^{\circ}\text{C}$

There are three conditions for frost, six for freezing fog and snow, four for freezing drizzle and light freezing rain and, finally, two for rain on a cold-soaked wing. For each condition, the testing program consists of a single AET test using two plates, giving a total of 25 calibration tests without fluid and 50 tests with the two candidate Type I fluids, i.e., 25 tests with each fluid. Should the allowable variation be exceeded during the course of the test, the test was terminated and repeated. Only tests performed within the allowable variations are included in the report.

3. EQUIPMENT, PRECIPITATION SIMULATION, AND CALIBRATION.

3.1 CLIMATIC CHAMBERS.

The AET tests were performed in the AMIL climatic chambers at the Université du Québec à Chicoutimi (UQAC). The choice of the chamber for each type of precipitation was determined by its volume and height. The freezing fog and frost tests were conducted in the smaller chambers whereas freezing drizzle, light freezing rain, and rain on a cold-soaked wing tests were performed in the 9-meter-high climatic chamber. For convenience, the artificial snow was made in a small environmental chamber that was different from the one in which the fluid and snow calibration tests were performed.

3.2 FROST GENERATION.

Frost is generated when a mass of humid air comes in contact with a surface colder than the air. The quantity of frost accumulated depends on the level of humidity in the air and the temperature

differential between the air and the surface of deposition. To obtain the high level of water moisture required in frost tests, a humidity generator, consisting of a 90-cm-long, 60-cm-wide, and 30-cm-deep bath of water which is maintained at a temperature warmer than air, is used. Forced air circulates throughout the bath to increase surface area and promote evaporation of the water. The humidity generator is shown in figure 1.

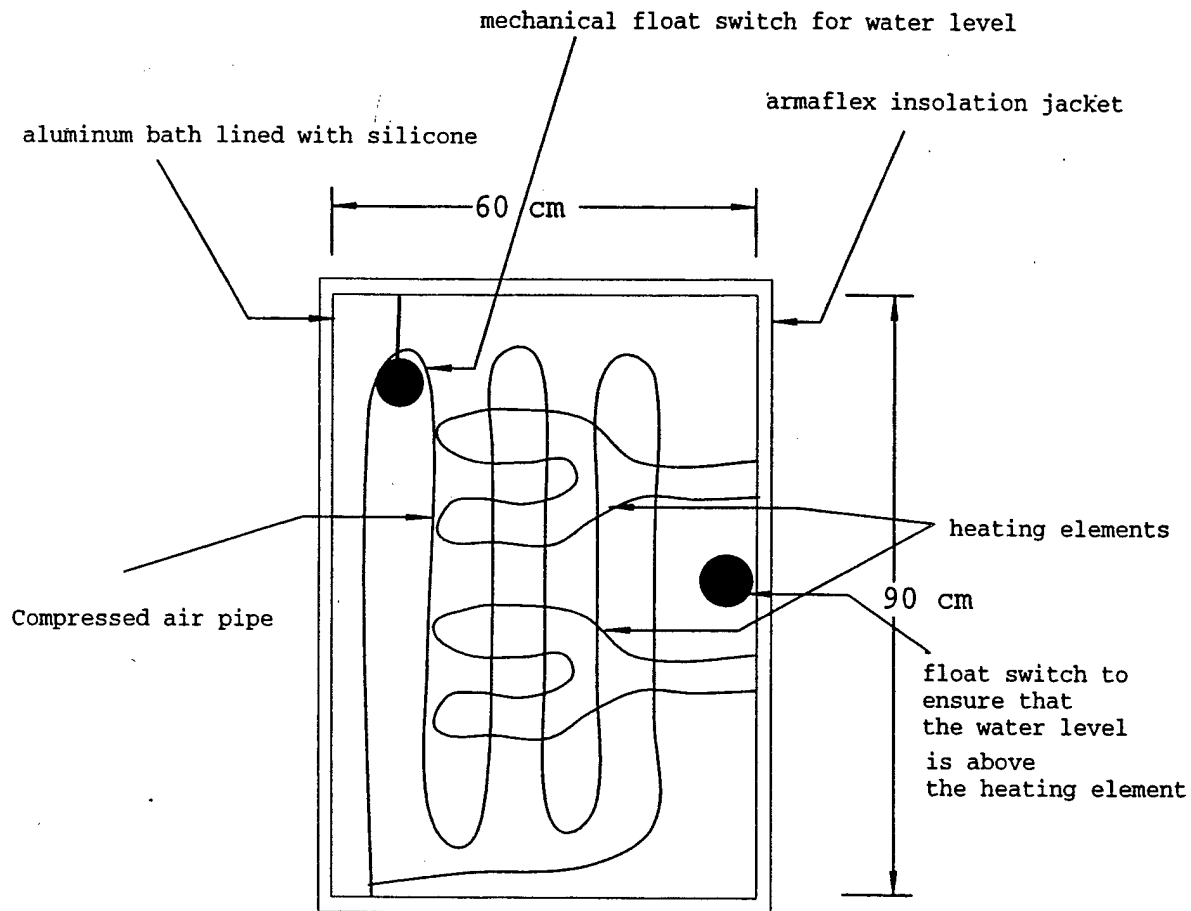

Notes: The bath is about 30 cm deep
 Compressed air is injected into the water by means of a copper pipe with small holes on its underside, which blows air bubbles into the water

FIGURE 1. HUMIDITY GENERATOR (BIRD'S EYE VIEW OF BATH)

3.3 SUPERCOOLED PRECIPITATION SIMULATION.

For supercooled liquid precipitation, two different types of water spray systems were used: the first is a pneumatic spray system for the freezing fog tests, and the second consists of different hydraulic nozzles for the freezing drizzle, light freezing rain, and rain on a cold-soaked wing tests. All systems use ASTM D1193 Type IV water.

3.3.1 Freezing Fog Water Spray.

The system used for the freezing fog tests consists of a pneumatic water spray nozzle oscillating over the test area. The nozzle, supplied with water and compressed air at 270 kPa pressure, located 1.45 m above the test plate support, allows for the continuous production of a water spray of very fine droplets presenting a $23 \pm 5 \mu\text{m}$ median volume diameter (MVD) (see histograms and droplet size cumulative frequency shown in figure 2).

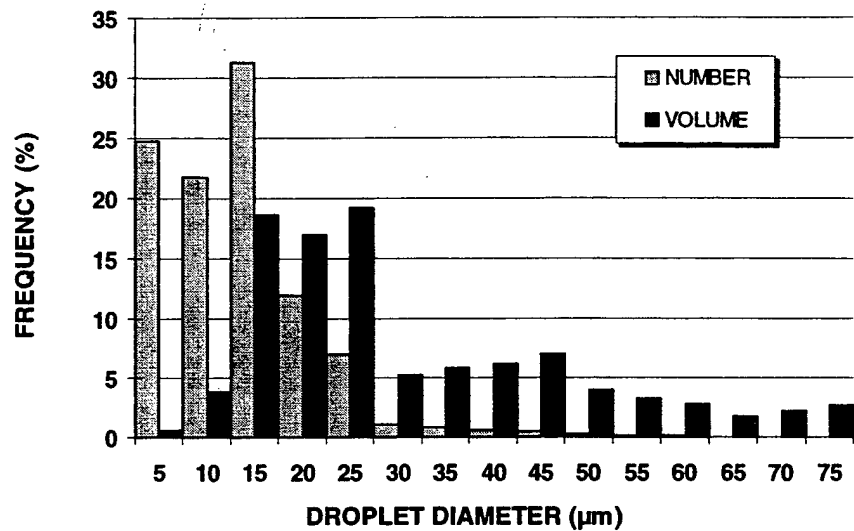

(a) Droplet Size Histogram

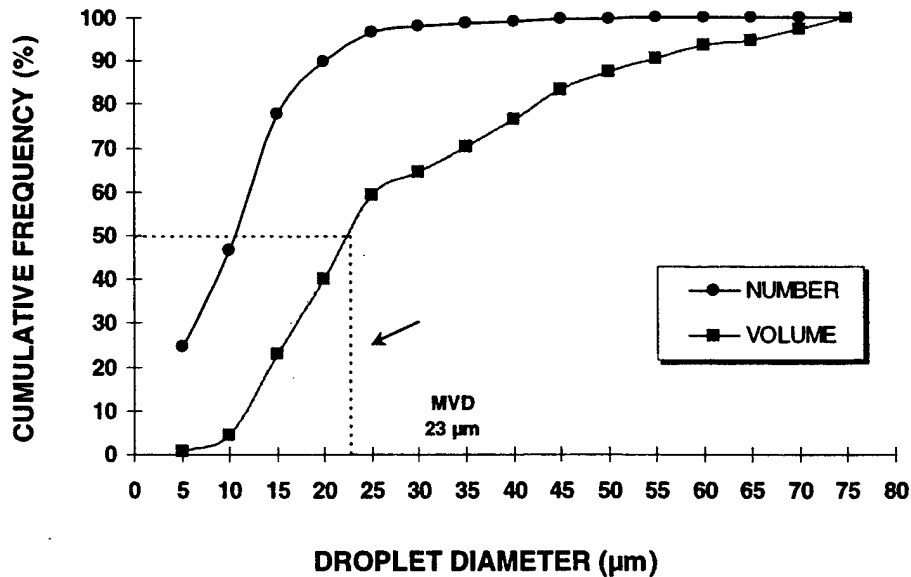

(b) Droplet Size Cumulative Frequency

FIGURE 2. FREEZING FOG WATER DROPLET SIZE DISTRIBUTION

3.3.2 Freezing Drizzle, Light Freezing Rain, and Rain on a Cold-Soaked Wing Water Spray.

The system used for generating the freezing drizzle, light freezing rain, and rain on a cold-soaked wing tests consisted of one or two hydraulic water spray nozzles oscillating over the test area. The nozzles, located about 7.0 m above the test plate, allow for the production of droplets presenting MVD between 150 and 1400 μm , depending on the orifice diameter of the nozzle selected for the test. The water spray intensity for a given nozzle is controlled by varying the time sequence of "on/off" pulses.

For the freezing drizzle tests performed, the measured droplet MVD is $237 \pm 20 \mu\text{m}$ (see the histogram and droplet size cumulative frequency in figure 3). For the light freezing rain, the measured droplet MVD is 970 μm (see the histogram and droplet size cumulative frequency in figure 4).

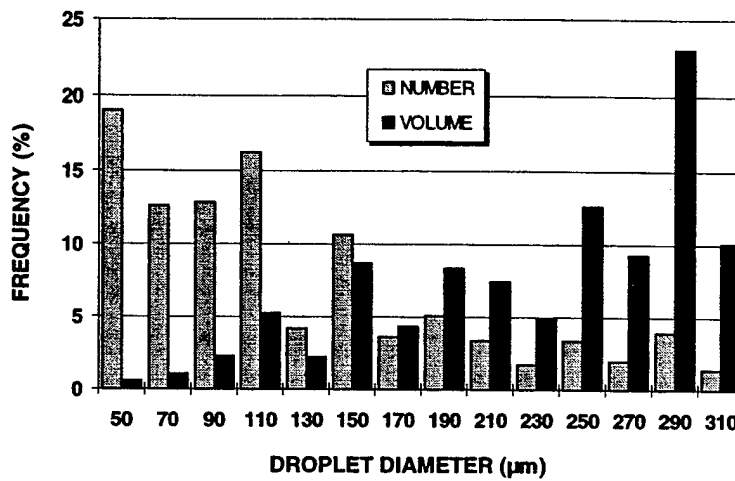

(a) Droplet Size Histogram

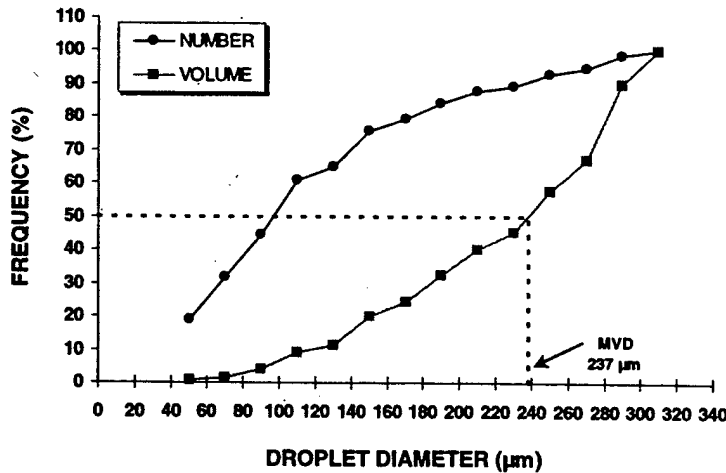

(b) Droplet Size Cumulative Frequency

FIGURE 3. FREEZING DRIZZLE WATER DROPLET SIZE DISTRIBUTION

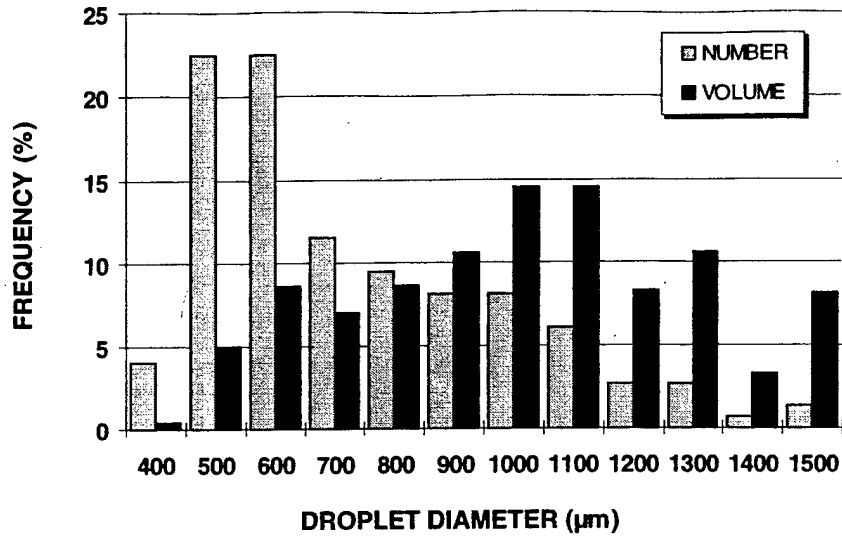

(a) Droplet Size Histogram

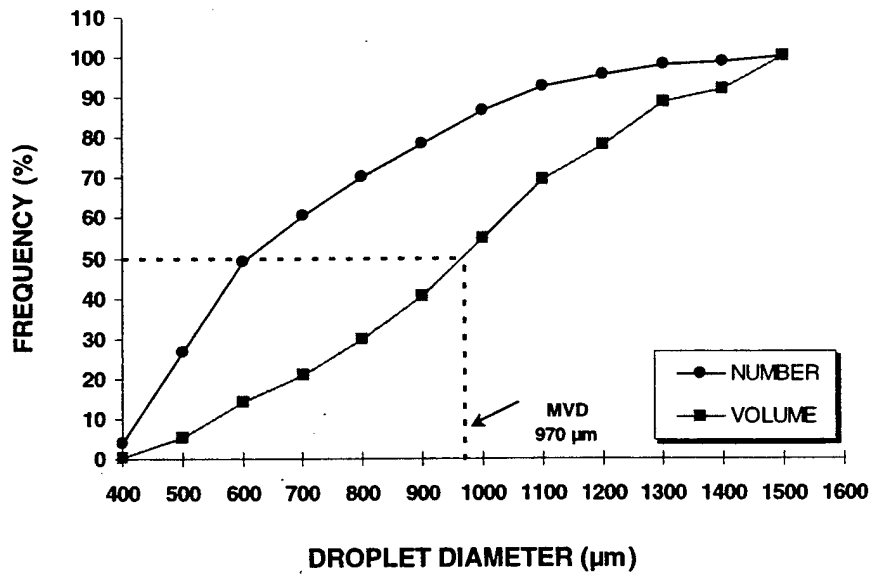

(b) Droplet Cumulative Size Frequency

FIGURE 4. LIGHT FREEZING RAIN WATER DROPLET SIZE DISTRIBUTION

3.4 SNOW MAKING, STORAGE, AND DISTRIBUTION SYSTEM.

3.4.1 Snow Making.

The artificial snow was made in a cold chamber by means of a pneumatic water spray nozzle supplied with water and compressed air. The nozzle produces a spray of very fine water droplets which becomes supercooled in cold air and freezes to form solid ice crystals on contact with a

collection plate on the chamber floor. Water flow and air pressure are adjusted to ensure the ice crystals conform to the requirements of the laboratory-made snow. Typical parameters are:

- Air temperature: $-20^{\circ} \pm 5^{\circ}\text{C}$
- Water droplet size: $22 \pm 3 \mu\text{m MVD}$
- Water flow rate to nozzle: 70 mL/minute
- Air pressure to nozzle: 260 kPa
- Artificial snow density 0.1 g/cm^3

3.4.2 Snow Storage.

The laboratory-made snow is placed in an insulated heat container, which is stored in a cooler kept at a temperature below -10°C . The snow quality is verified prior to each test by means of a density measurement. Furthermore, if the artificial snow shows any evidence of sintering, agglomeration, or crystallization, it is not used for the snow tests.

3.4.3 Snow Distribution System.

For the snow tests, the snow is distributed as ice particles in the form of clusters in the range of intensities specified in table 3. The snow distribution system was designed so that the mass of each cluster is 0.03 g or less. The snow is placed in a U-shaped aluminum box, 320 mm long, 253 mm high, and 132 mm wide at the top, with a 65-mm high drawer at the top with a sliding base which allows the addition of snow in between tests, above the test plate (figure 5). The box is suspended from a track around 760 mm above the center of the test plate (figure 6). The track is attached to a motor which provides the lateral movement of the snow box. The lateral displacement speed depends on the desired snow intensity. The snow is continually stirred inside the box by a rotating system consisting of three blades, aligned at 120° angles from each other (figure 7). Each blade measures 50 x 300 mm and consists of a frame housing a wire mesh. The continued rotation of the blades prevents clumping of the snow prior to dispensing. The box contains an opening at the base, 10 mm wide along the length of the box. This opening houses a 32-mm diameter Acetal cylinder, which contains 18 cavities arranged in six rows of three cavities each at 60° spacing (figure 8). Each cavity has a diameter of 11 mm and is drilled to a U-shape. The cavities on each row are spaced at 87-mm intervals and out of phase with each other row. The cylinder, turns after a given time interval thus dispensing snow clusters onto the test plate. The rotation speed of the cylinder is predefined to accommodate the desired snow intensity.

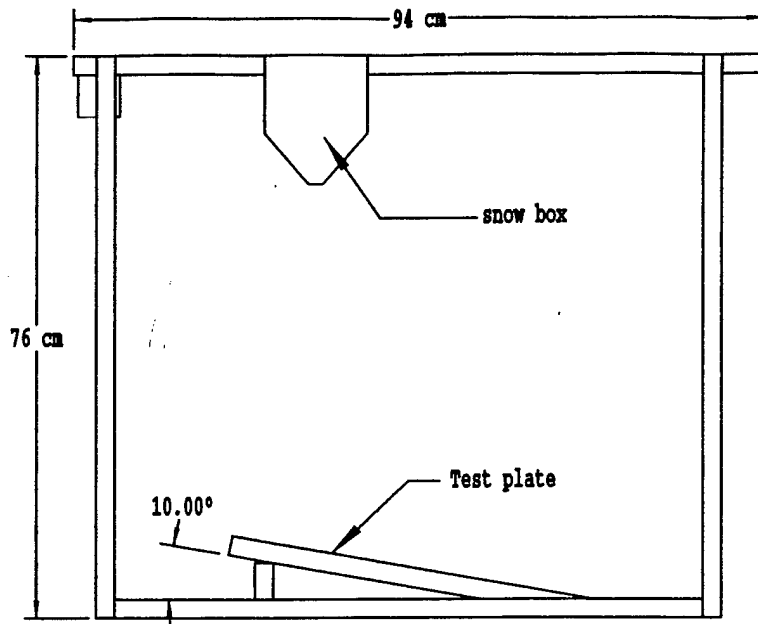

FIGURE 5. SNOW BOX MOUNTED IN ITS SUPPORT ABOVE TEST PLATE

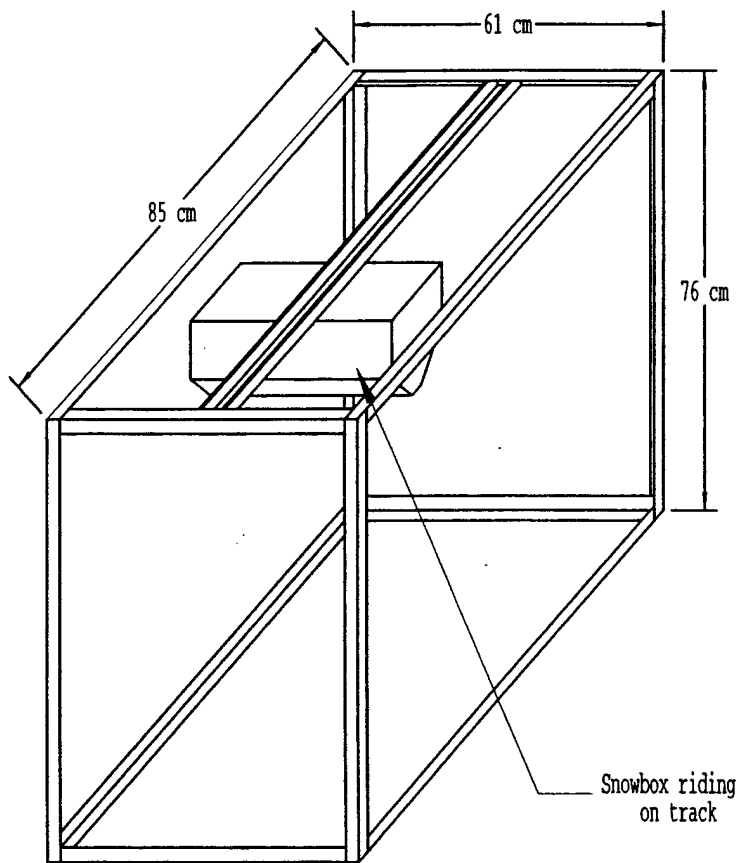

FIGURE 6. SNOW BOX ON TRACK OF SUPPORT

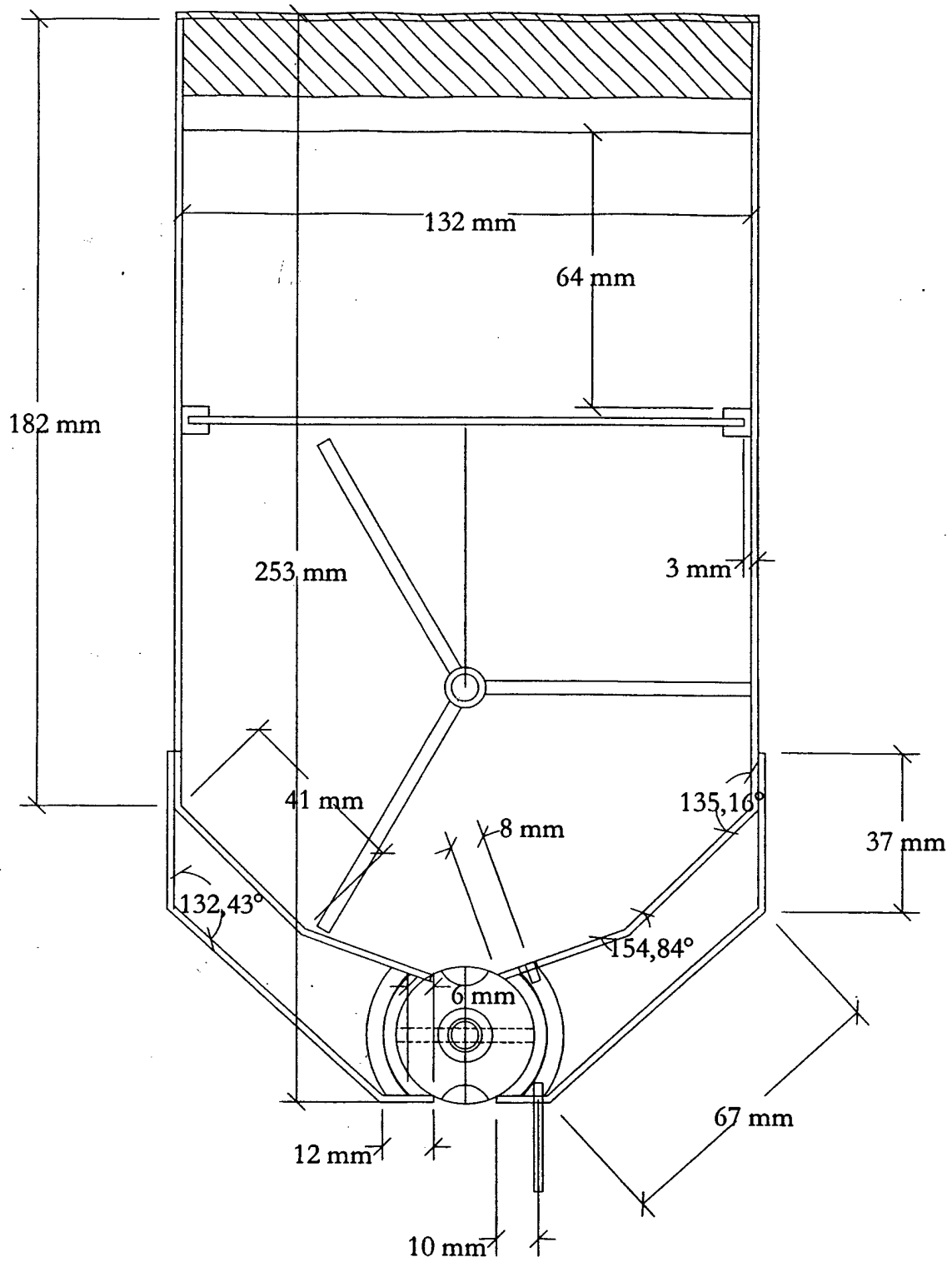

FIGURE 7. CROSS SECTION OF SNOW BOX

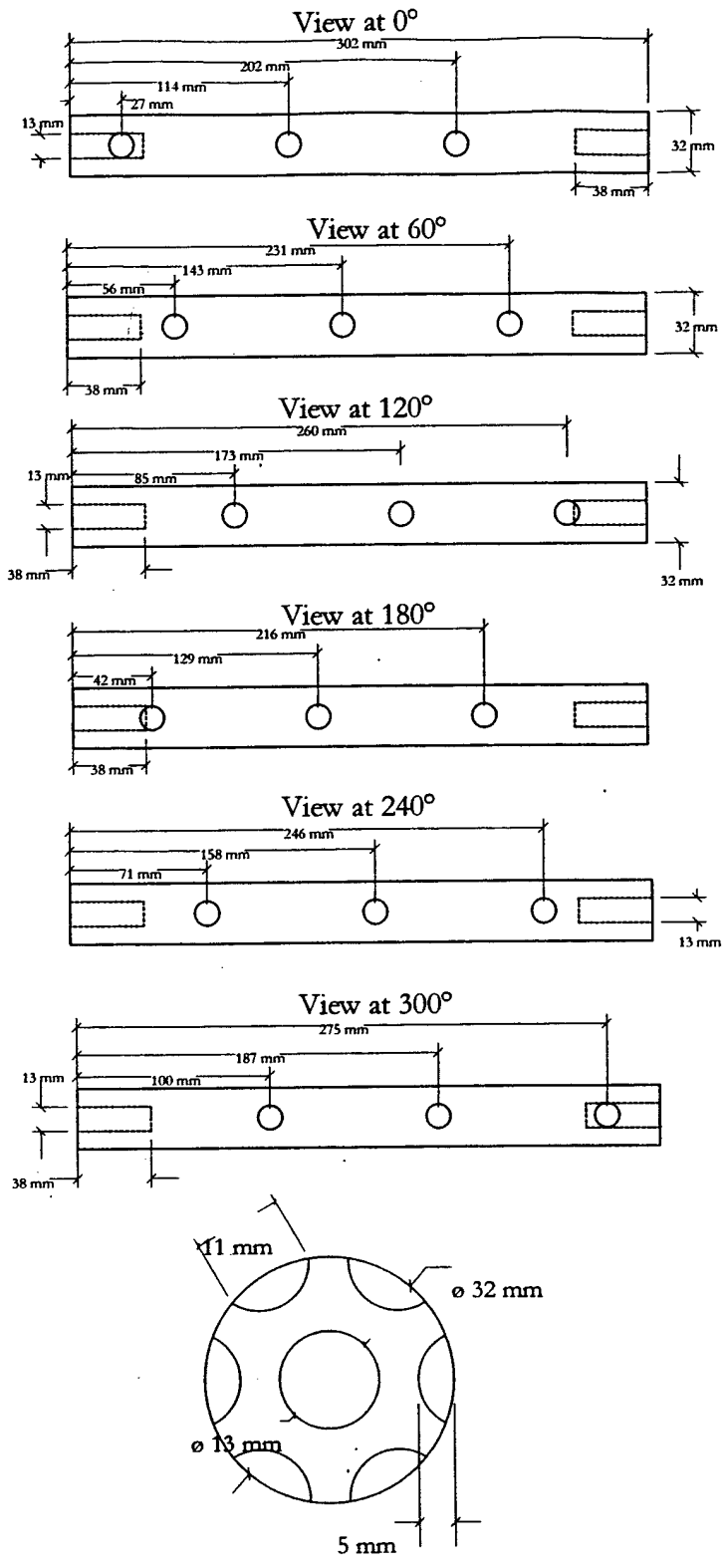

FIGURE 8. SIDE VIEWS AND CROSS SECTION OF ACETAL CYLINDER WITH SIX ROWS OF THREE CAVITIES WHICH TRANSFER SNOW FROM THE BOX TO THE TEST PLATE

3.5 PLATE SETUPS.

3.5.1 Frost Tests.

Frost tests are conducted using the frosticator shown in figure 9. It consists of a support, the top of which is inclined at an angle of 10°. On the support is placed a set of six plates 300 long by 100 wide by 1.6 mm thick. The support is maintained throughout the test at -3°C below the prescribed air temperature by a cooling system.



FIGURE 9. FROST SETUP

For frost tests, the frosticator is covered with three polished AMS 4037 aluminum alloy plates coated with the candidate fluid and nine small 100- by 100- by 1.6-mm bare aluminum plates placed adjacent to the fluid-coated plates to measure ice catch (figure 10). The mirror polished surface of test plates corresponds to a roughness between 0.1 and 0.2 μm. For ice calibration tests, eighteen 100- by 100-mm bare aluminum ice catch plates are used to measure the frost intensity.

F L U I D	ICE	F L U I D	ICE	F L U I D	ICE
	ICE		ICE		ICE
	ICE		ICE		ICE

(a) Fluid Tests

ICE	ICE	ICE	ICE	ICE	ICE
ICE	ICE	ICE	ICE	ICE	ICE
ICE	ICE	ICE	ICE	ICE	ICE

(b) Ice Catch Calibration Tests

FIGURE 10. FROST TEST PLATE ARRANGEMENT

3.5.2 Freezing Fog, Freezing Drizzle, and Light Freezing Rain.

For freezing fog, freezing drizzle, and light freezing rain tests, movable stands were used which could accommodate a removable 500- by 300- by 3.2-mm-thick AMS 4037 aluminum alloy mirror-polished panels at a 10° inclination. Each test plate stand is designed to minimize the contact between the test surface and the support (see figure 11). As with the plates used in the frost test, the measured average roughness of the panel surface is between 0.1 and 0.2 μm . For fluid testing, the two panels are coated with the candidate fluid and they are surrounded with at least eight 100- by 100-mm small aluminum pans or plates used to measure icing intensity and distribution (see figure 12).

The ice catch pans are made of 0.8-mm-thick aluminum foil surrounded by a 15-mm-high rim, while the ice catch plates are 1.6-mm-thick aluminum without a rim. Pans are used for freezing drizzle, light freezing rain, or rain on a cold-soaked wing where the water droplets do not freeze immediately on impact and run down slope. However, when the temperature is sufficiently low, droplets freeze on impact; for example, freezing drizzle calibration tests performed at -10°C showed that there was no significant difference between the ice catch on plates or in pans. For this reason, in freezing fog and frost tests, where the ice is formed on contact with the plate, ice catch plates are used instead of pans.

Eight pans are positioned around each test plate for the freezing drizzle and light freezing rain tests (figures 11 and 12) and eight plates for the freezing fog tests (figure 13). For the ice catch calibration tests, each panel is covered with twelve 100- by 100-mm ice catch plates or pans (figures 12b and 13b). For convenience, the term "plate" will be used in this section to refer to both plates and pans used for ice catch measurements.

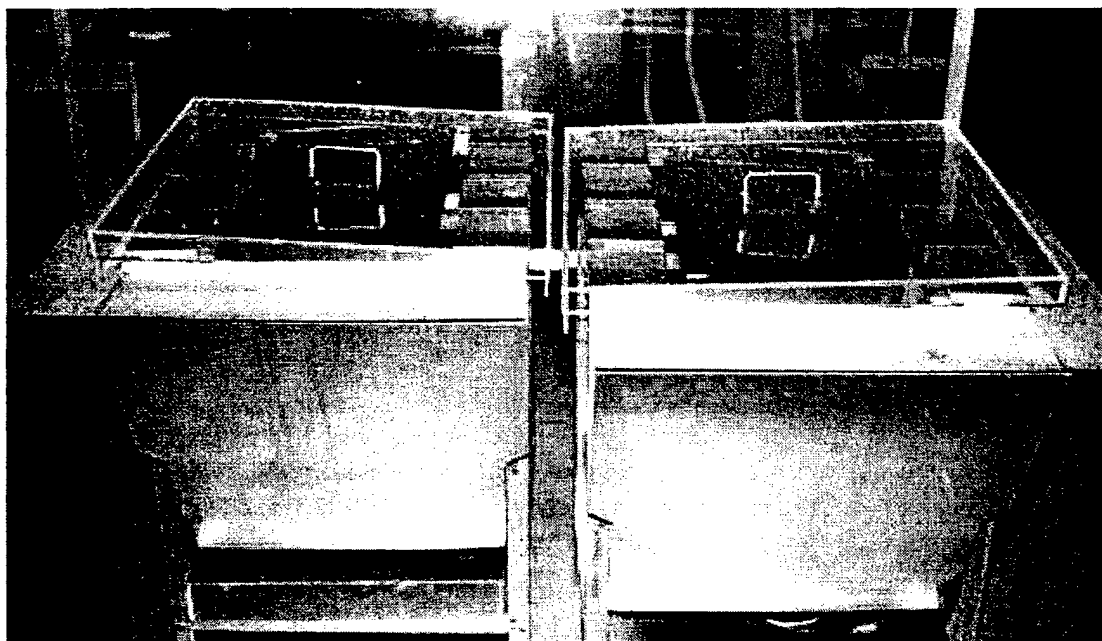
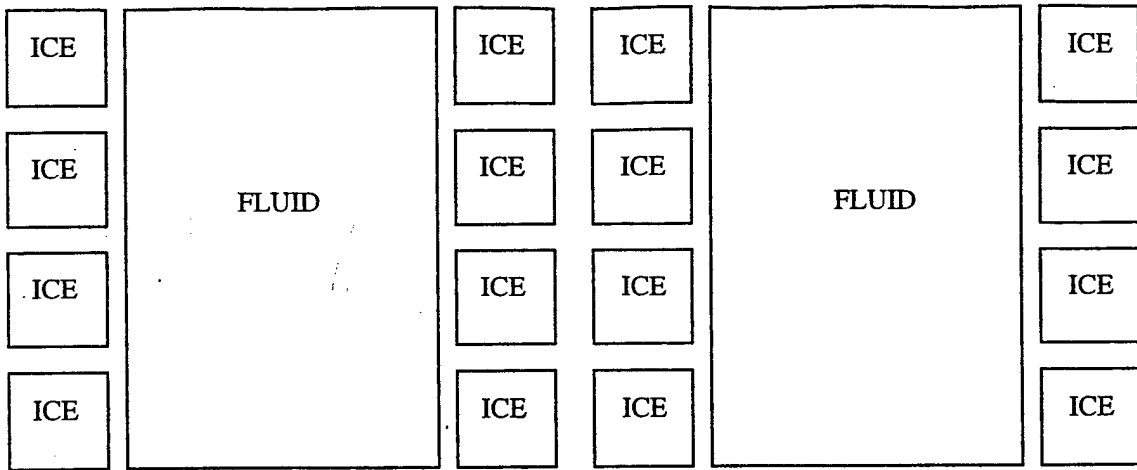
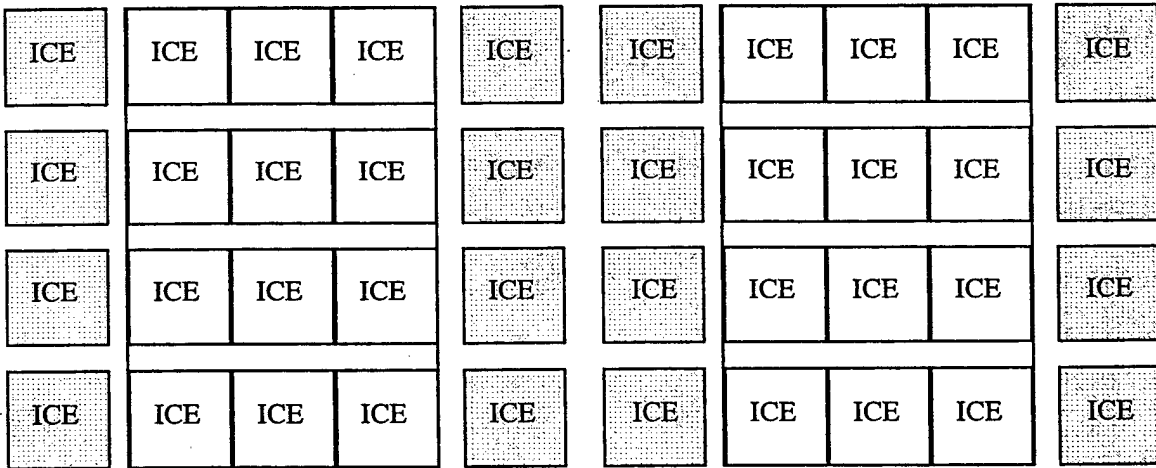

FIGURE 11. TEST PLATE SUPPORTS USED FOR FREEZING DRIZZLE AND LIGHT FREEZING RAIN TESTS



(a) Fluid Test



(b) Ice Catch Calibration Tests

FIGURE 12. PLATE ARRANGEMENT IN FREEZING DRIZZLE AND LIGHT FREEZING RAIN TESTS

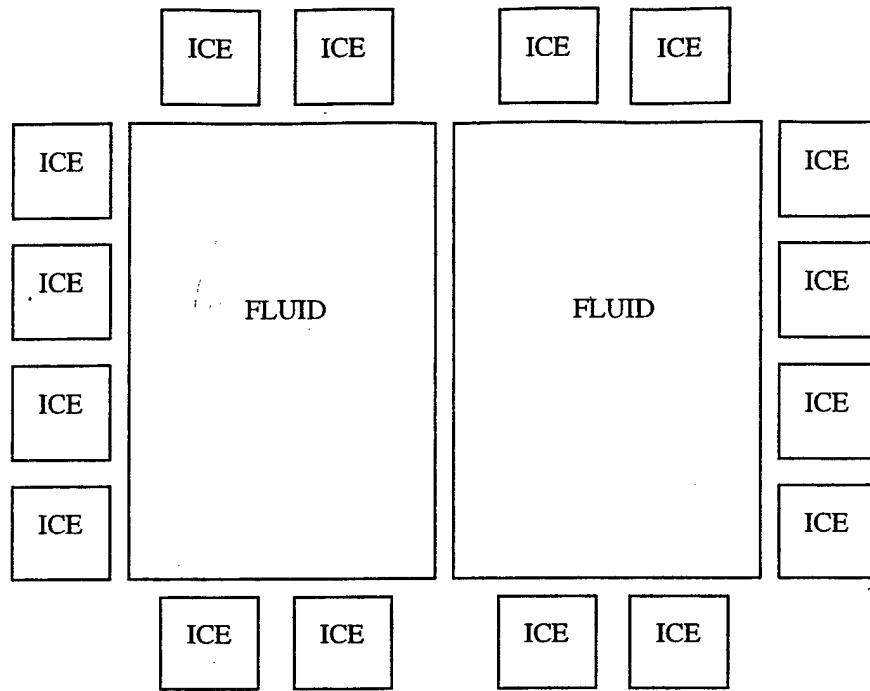

(a) Fluid Tests

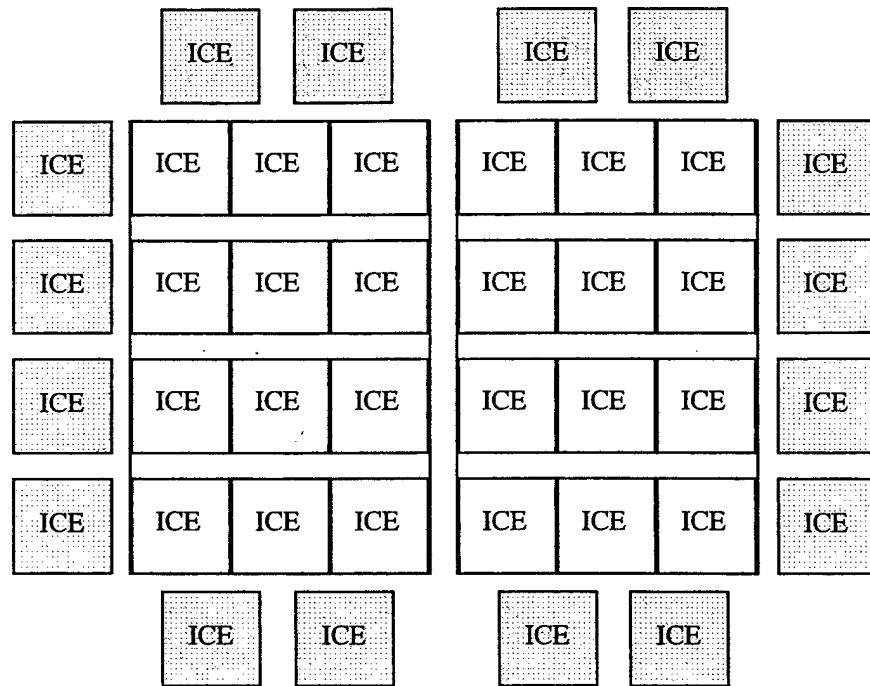

(b) Ice Catch Calibration Tests

FIGURE 13. PLATE ARRANGEMENT IN FREEZING FOG TEST

3.5.3 Rain on a Cold-Soaked Wing Test.

For the rain on a cold-soaked wing test, the plate setup consists of a cold soak box filled with a 65/35 propylene glycol/water volume ratio mixture on to which the test panel is placed (see figure 14). The box is contained within a 25-mm-thick polystyrene insulating jacket equivalent to a thermal resistance RSI equal to 1.3. During a calibration test, the panel is covered with twelve 100- by 100-mm pans.

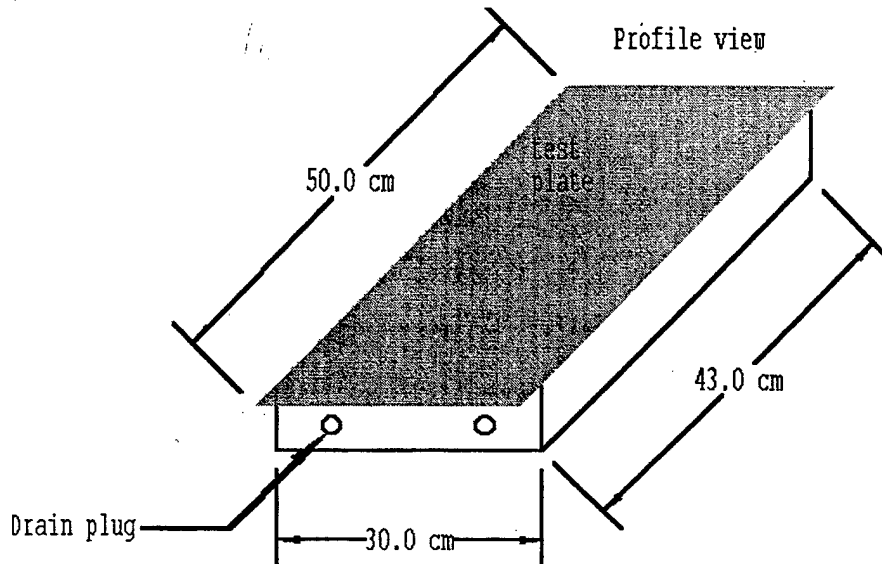

FIGURE 14. COLD SOAK BOX PLATE SETUP

3.6 MEASURED PARAMETERS.

The validity of the tests depends essentially on the three following environmental parameters: icing intensity, air, and plate temperatures. Recordings of the air and plate temperatures ensure that they are maintained during the test at target values within the prescribed allowable variations. Air temperature and humidity sensors are located within 1.5 meters from the test plates. The plate temperature sensors consist of thermocouples and platinum resistance temperature detectors (RTD) fixed to the underside of the test plate 150 mm from the top and the side edges. All these sensors are linked to a data acquisition system computer which records and logs test data in real time throughout the course of a test at the sampling rate of two data per second.

3.7 CALIBRATION.

Calibration tests are conducted for each condition of AET tests in order to establish that even and reproducible ice formation occurs over the surface of the test plates, i.e.,

- The target icing intensity for the test is within an acceptable range, and
- The icing intensity over the surface of the panels exhibits a good distribution.

The allowable variations in temperature and icing rates are shown in table 4. Calibration tests consist of measuring the icing intensity by means of small 100- by 100-mm ice catch plates or pans placed on test panels. Figure 15 shows the arrangement of 20 pans used for calibration tests of freezing drizzle and light freezing rain. These pans or plates are weighed prior to and on completion of each test and the difference in the recorded weights is the ice catch for that plate. The icing intensity I for each plate is then calculated using the following relation:

$$I \text{ (g/dm}^2\text{h)} = \frac{\text{Ice weight (g)}}{[\text{ice catch plate area (dm}^2\text{) x calibration test duration (h)}]}$$

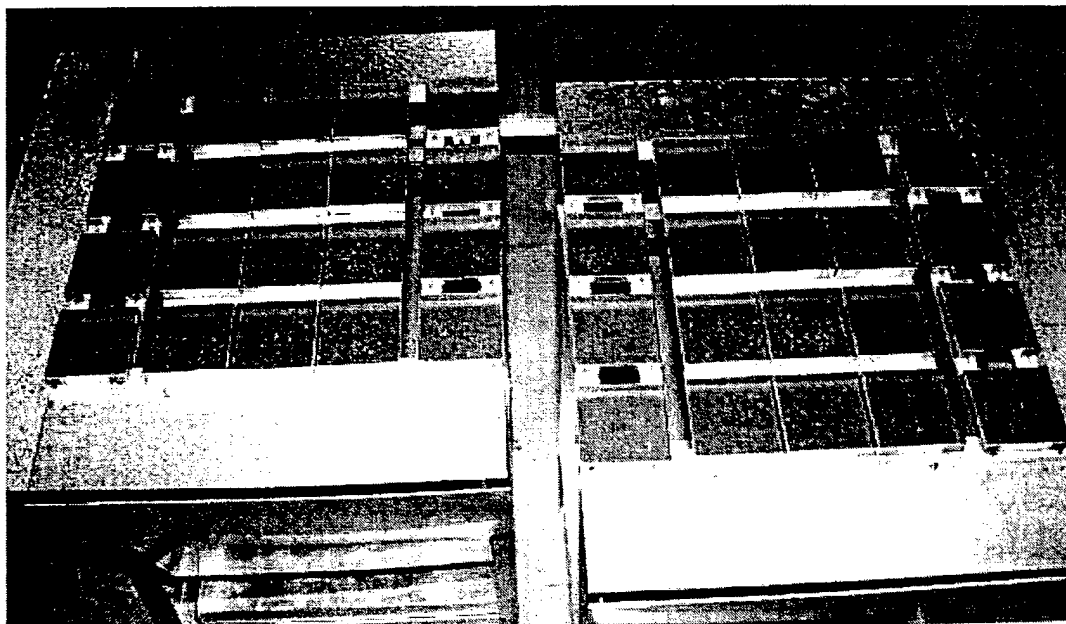

FIGURE 15. ICE CATCH PAN ARRANGEMENT IN FREEZING DRIZZLE AND LIGHT FREEZING RAIN CALIBRATION TESTS

For a calibration test to be considered valid, the average icing intensity over the whole test panel surface must correspond to the value prescribed for that particular test condition and variations shall be within the limits specified in table 4. If not, calibration tests are repeated varying parameters until the required ice catch and distribution is obtained. Therefore, before conducting a fluid test under a given condition, a valid calibration test is conducted in that particular condition.

3.7.1 Frost Calibration.

A total of eighteen 100- by 100-mm small ice catch plates are used in the frost calibration tests performed for each temperature condition. This includes nine ice catch plates replacing the three 300- by 100-mm test plates and nine others used to control icing intensity during fluid test. The average ice catch over the test surface corresponds to the frost accumulation for that plate. The average ice catch over the whole test surface corresponds to frost accumulation for that particular test condition and variation must be within the limits specified in table 4 for the calibration test to be considered acceptable.

TABLE 4. ALLOWABLE VARIATION IN TEMPERATURE AND ICING INTENSITY FOR A CALIBRATION TEST

Test Temperature (°C)	Icing Intensities Under Various Weather Conditions, g/dm ² h					
	Frost	Freezing Fog	Snow	Freezing Drizzle	Light Freezing Rain	Rain on a Cold-Soaked Wing*
-3 ±0.5 ⁽¹⁾	0.2 ±0.02 (±0.03)	2 ±0.2 (±0.2)	10 ±0.5 (±0.5)	5 ±0.2 (±0.3)	13 ±0.5 (±0.7)	5 ±0.2 (±0.3)
		5 ±0.3 (±0.3)	25 ±1.0 (±1.5)	13 ±0.5 (±0.7)	25 ±1.0 (±1.5)	75 ±3.0 (±4.5)
-10 ±0.5 ⁽²⁾	0.15 ±0.02 (±0.03)	2 ±0.2 (±0.2)	10 ±0.5 (±0.5)	5 ±0.2 (±0.3)	13 ±0.5 (±0.7)	
		5 ±0.3 (±0.3)	25 ±1.0 (±1.5)	13 ±0.5 (±0.7)	25 ±1.0 (±1.5)	
-25 ±1.0 ⁽³⁾	0.06 ±0.01 (±0.01)	2 ±0.2 (±0.2)	5 ±0.2 (±0.2)			
		5 ±0.3 (±0.3)	10 ±0.5 (±0.5)			

For frost, ⁽¹⁾T_{air} = 0° ±0.5°C T_{plates} = -3° ±0.5°C, ⁽²⁾T_{air} = -10°C T_{plates} = -13° ±0.5°C,
⁽³⁾T_{air} = -25°C T_{plates} = -28° ±1.0°C

*For rain on cold-soaked wing, T_{air} = +1° ±0.5°C

3.7.2 Freezing Fog, Freezing Drizzle, Light Freezing Rain, and Rain on a Cold-Soaked Wing Calibration.

For freezing fog, freezing drizzle, light freezing rain, and rain on a cold-soaked wing calibration tests, each test plate is replaced with twelve ice catch plates, which, in turn, are surrounded by at least eight additional reference ice catch plates (shaded on figures 12b and 13b), for a total of at least twenty 100- by 100-mm ice catch plates. Like in the frost tests, these plates are weighed prior to and on completion of each test and the recorded weight difference is the ice catch for that plate. The average ice catch is calculated on the ice catch plates placed over test plates as well as on the small reference plates surrounding them. It is the *Ratio* between these two calculated values that is used to estimate the icing intensity during a fluid test run, when only the reference pans are available, i.e.,

$$Ratio = \frac{I_{plate}}{I_{ref}}$$

I_{plate} is the average ice catch on the pans over the test panel,
I_{ref} is the average ice catch on the reference plates.

During the course of a fluid test, the ice catch is measured on the reference surrounding plates and this value is then multiplied by the *Ratio* calculated above in previous calibration tests

performed under the same conditions. The resulting value is the estimated icing intensity (I_{plate}) over the test panel.

For the fluid test run:

$$\text{Estimated } I_{plate} = I_{ref} \times \text{Ratio}$$

Where I_{ref} is measured during a fluid test and *Ratio* has been determined in a previous valid calibration test.

3.7.3 Snow Calibration.

The snow distribution box was built to accommodate only one test panel at a time without using any surrounding reference ice catch pans. Therefore, for a snow calibration test, ten snow catch 150- by 100-mm pans with a 15-mm edge are used for each set of conditions, which are placed over the test panel surface. As with ice catch plates, the snow catch pans are weighed prior to and on completion of each test and the difference corresponds to the snow intensity for that particular test condition. The snow intensity is the average of the snow catch collected in the ten pans with a calculated standard deviation. This average value should be within the target values specified for each test condition of table 3, whereas the calculated standard deviation from the ten snow catch pans must fall within the variations given in table 4. The degree of reproducibility is checked by performing not less than two successive calibration tests before a test run in the same condition.

4. RESULTS.

4.1 WATER SPRAY AND HIGH HUMIDITY ENDURANCE TESTS (WSET AND HHET).

The first task was to perform WSET and HHET standard tests on a 50/50 dilution sample of the two candidate fluids to verify whether they can be considered as approved SAE Type I fluids. After receiving the two candidate fluids, ADF on June 23, 1999, and OCTAFLO on July 12, 1999, dilutions were prepared according to the sample selection procedures and each fluid was tested sheared and unsheared using a set of three standard plates according to Annex A of AMS 1424 B. Full WSET and HHET test description and procedures are detailed in reference 8.

WSET and HHET results are presented in table 5 and figure 16. For both tests, ice catch measured on the reference plates is within the prescribed target values, which are 5.0 ± 0.2 g/dm²h in the case of the WSET and 0.30 ± 0.05 g/dm²h in the case of the HHET. For both fluids, the first ice event (FIE), the numbers in bold in the table 5, exceed the 3 and 20 minutes minimum values specified for WSET and HHET respectively for an SAE Type I fluid to be approved. In WSET tests, sheared samples (solid points) show failure times varying by about ± 30 seconds of values of fluids tested unsheared (open points). In HHET tests, failure times of sheared samples are 1 to 4 minutes lower than those observed with the fluid tested unsheared, EG times being a little shorter than PG times. However, these differences are within the range of the experimental error and thus are not considered to be significant. The experimental error in the WSET is estimated to be 1 min for Type I fluids. Even if the ice

TABLE 5. WATER SPRAY AND HIGH HUMIDITY ENDURANCE TESTS RESULTS FOR OCTAFLO AND ADF CONCENTRATE DEICING FLUIDS

Fluid Shearing	Test Code	Date (y-m-d)	ICE DATA		FLUID DATA			
			Plate	Intensity (g/dm ² h)	Plate	FIE ¹ (min:sec)	MIT ² (min:sec)	PIL ³ (mm)
OCTAFLO 50/50 DILUTION—WATER SPRAY ENDURANCE TEST								
Unsheared	WS2081	99-08-26	P1	4.98 ±0.10	P2	5:45	6:30	300
			P3	4.95 ±0.11	P4	5:45	6:30	300
			P5	4.96 ±0.12	P6	5:50	6:30	300
Sheared	WS2082	99-08-26	P1	5.02 ±0.10	P2	5:15	6:15	300
			P3	4.98 ±0.09	P4	5:20	6:15	300
			P5	4.97 ±0.09	P6	5:20	6:15	300
OCTAFLO 50/50 DILUTION—HIGH HUMIDITY ENDURANCE TEST								
Unsheared	HH1148	99-09-10	P1	0.31 ±0.01	P2	30:37	32:20	300
			P3	0.29 ±0.00	P4	33:38	35:52	300
			P5	0.30 ±0.01	P6	34:30	35:20	300
Sheared	HH1150	99-09-13	P1	0.34 ±0.00	P2	29:05	33:40	300
			P3	0.31 ±0.01	P4	29:45	35:30	300
			P5	0.31 ±0.02	P6	32:20	34:10	300
ADF CONCENTRATE 50/50 DILUTION—WATER SPRAY ENDURANCE TEST								
Unsheared	WS2079	99-08-25	P1	5.03 ±0.09	P2	3:10	5:35	n.m.
			P3	5.06 ±0.09	P4	4:20	5:35	n.m.
			P5	5.01 ±0.11	P6	4:05	5:30	n.m.
Sheared	WS2080	99-08-25	P1	5.03 ±0.09	P2	3:45	5:45	300
			P3	5.01 ±0.08	P4	4:20	5:55	300
			P5	4.99 ±0.09	P6	4:30	5:45	300
ADF CONCENTRATE 50/50 DILUTION—HIGH HUMIDITY ENDURANCE TEST								
Unsheared	HH1201	99-10-28	P1	0.32 ±0.00	P2	31:05	31:50	300
			P3	0.27 ±0.01	P4	34:05	35:40	300
			P5	0.27 ±0.01	P6	33:55	35:15	300
Sheared	HH1212	99-11-30	P1	0.32 ±0.00	P2	27:55	33:20	300
			P3	0.29 ±0.01	P4	30:45	32:05	300
			P5	0.30 ±0.01	P6	28:50	32:50	300

¹ FIE: First Ice Event: time for the first ice crystal to reach 25 mm in length.

² MIT: Mean Icing Time: time for the ice to reach a mean length of 25 mm.

³ PIL: Plate Icing Length: Length of plate covered by ice at the end of the test.

intensity varies only 4%, the main error comes from the nucleation time which can be 30 seconds to 1 min. In the HHET, in which holdover time is over 20 minutes, the experimental error is estimated to the 3 minutes corresponding to the variation in icing intensity. According to the sample selection procedures [8], the two candidate fluids selected for the AET testing program can be considered as approved SAE Type I fluids and consequentially are suitable for the present study.

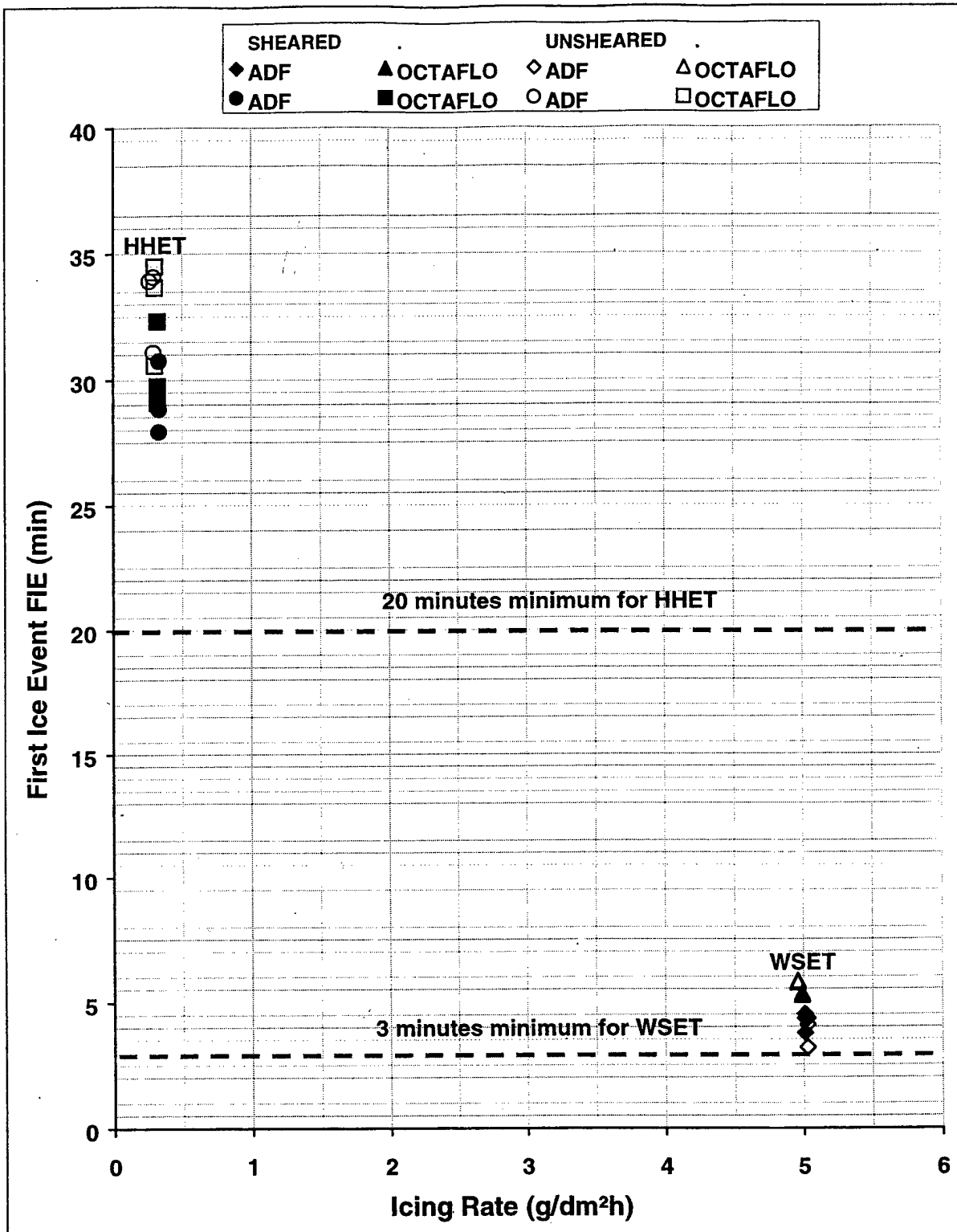

FIGURE 16. ANTI-ICING ENDURANCE TIME AS MEASURED IN WSET AND HHET TESTS

4.2 ANTI-ICING ENDURANCE TIME TEST RESULTS.

4.2.1 Methodology.

The AET testing procedures used in this study are based on the procedures discussed at the Montreal G-12 Fluid Subcommittee meeting held in March 1999 [9] and revised at two subsequent meetings held between APS and AMIL representatives with the participation of the FAA and TDC, the first in Montreal on July 30, 1999, [3] and the second in Chicoutimi, on October 6, 1999 [4].

These testing procedures detail general testing conditions, including fluid preparation and fluid failure criterion. General testing conditions and fluid application can be summarized as follows:

- Test plates and panels: 300- by 100-mm mirror polished plates for frost tests and 500- by 300-mm mirror polished panels in all other AET tests;
- Volume of fluid applied: 120 mL applied on 300- by 100-mm plates and 500 mL on 500- by 300-mm panels;
- Fluid temperature at application and shearing condition: all fluids are applied at $20^{\circ} \pm 5^{\circ}\text{C}$, unsheared;
- Exposure to freezing precipitation: there is a 5-minute delay between fluid application and exposure of fluid-coated plate to icing;
- Water quality: all supercooled precipitation was generated using ASTM D1193 Type IV water.

4.2.1.1 Sample Dilution Preparation.

Fluid dilutions were prepared using hard water¹, as per AMS 1424 B paragraph 3.3.3.1, diluted, as when applied on an aircraft, to a 10°C buffer from the OAT. The 10°C buffer was calculated using charts supplied by each manufacturer giving freezing point versus dilution.

Table 6 depicts the identification number and water dilution ratios selected for the six different samples prepared for AET tests. The ADF fluid was diluted by increments of 1% whereas OCTAFLO samples were prepared using 5% dilution increments as specified by the manufacturer regarding fluid usage. As can be seen on the calculated buffer given in table 6, freezing points of ADF diluted samples are exactly 10°C below test temperatures whereas OCTAFLO dilution have freezing points of more than 10°C below the testing temperatures. For instance, the OCTAFLO 60/40 dilution used in AET tests at -25°C has a buffer of 5°C higher than the 10°C buffer, while the 45/55 and 35/65 dilutions used in tests at -10° and -3°C present a buffer of 2°C higher than the target value of 10°C .

¹ Composition of hard water: dissolve 400 mg ± 5 calcium acetate dihydrate ($\text{Ca}(\text{C}_2\text{H}_3\text{O}_2)_2 \cdot 2\text{H}_2\text{O}$), and 280 mg ± 5 magnesium sulfate heptahydrate ($\text{MgSO}_4 \cdot 7\text{H}_2\text{O}$), both of analytical reagent quality, in 1 liter of ASTM D 1193, Type IV, water.

TABLE 6. FLUID DILUTION SELECTION AND IDENTIFICATION

No	AMIL Code	Manufacturer	Fluid	Lot No.	Dilution	Freezing Point	Buffer
1.0	C418	OCTAGON	OCTAFLO	F-21104R	NEAT	—	—
1.1	C480	OCTAGON	OCTAFLO	F-21104R	60/40	-40°C	15°C
1.2	C481	OCTAGON	OCTAFLO	F-21104R	45/55	-22°C	12°C
1.3	C482	OCTAGON	OCTAFLO	F-21104R	35/65	-15°C	12°C
1.4	C512	OCTAGON	OCTAFLO	F-21104R	30/70	-11°C	12°C
1.5	C500	OCTAGON	OCTAFLO	F-21104R	50/50	-28°C	—
2.0	C397	UCAR	ADF	67-CHC-12-B	NEAT	-28°C	—
2.1	C483	UCAR	ADF	67-CHC-12-B	51/49	-35°C	10°C
2.2	C484	UCAR	ADF	67-CHC-12-B	36/64	-20°C	10°C
2.3	C485	UCAR	ADF	67-CHC-12-B	28/72	-13°C	10°C
2.4	C511	UCAR	ADF	67-CHC-12-B	21/79	-9°C	10°C
2.5	C499	UCAR	ADF	67-CHC-12-B	50/50	-34°C	—

4.2.1.2 Failure Criterion and Type.

In all the AET tests with the exception of frost, failure is called when 30% of the plate is covered with frozen contamination. In frost tests, failure is called when 50% of the plate is covered by ice. Pen marks on the plate are used to estimate the area of failure. For instance, a line drawn across the 300- by 500-mm panel at 150 mm from the top edge will delineate an area corresponding to 30% of the plate.

The frozen contamination at failure may appear under different forms. Examples of such appearances include, but are not limited to:

- Ice front
- Ice sheet
- Slush, in clusters or as a front
- Disseminated fine ice crystals
- Frost on surface
- Clear ice pieces partially or totally imbedded in fluid

Usually, Type I fluid failure appears as an ice front, except in snow tests which involve slush in clusters. Normally, in the case of an ice front, the ice grows slowly, beginning at the top of the plate and moving down at a rate dependent on the failure time of the fluid. In some cases, however, a thin layer of fluid on the plate may freeze spontaneously, with no gradual growth. In such cases, nucleation may need to be initiated and the test repeated. In either case, should the ice cover more than 30% of the plate, the test is valid and must be repeated. No suspected delayed nucleation was observed during this study.

4.2.1.3 Measurements and Failure Recordings.

The following measurements were performed: recordings during the course of each AET test of air and plate temperatures, relative humidity, icing intensity, anti-icing endurance times, and photographs of ice fronts at failure.

Over one hundred tests, including twenty-five calibration and fifty fluid tests, were conducted under various temperature and icing intensity conditions as prescribed in the AET procedures [5]. Tested fluids and dilutions are identified in table 6.

4.2.2 Frost Tests.

Frost tests include three calibration and six fluid tests with the results being summarized in table 7. In frost tests, the failure is called when the observed ice front covers 50% of the plate. The dilution level of each sample is given in the fluid label column. Measured anti-icing endurance times are shown in bold on table 7, where they can be compared to the times taken to cover 30% and 100% of the plate. All measured icing intensities and temperatures correspond to target values, varying well within the prescribed variations of $\pm 0.5^{\circ}\text{C}$ for temperature and $\pm 0.02\text{ g/dm}^2\text{h}$ ($0.01\text{ g/dm}^2\text{h}$ at -25°C) for the icing intensity.

Anti-icing endurance times measured with both fluid samples at air temperatures of 0°C (triangles), -10°C (diamonds), and -25°C (circles) are plotted in figure 17 as a function of the icing intensities. The lowest value of icing intensity ($0.06\text{ g/dm}^2\text{h}$) is obtained at the lowest temperature of -25°C . OCTAFLO samples are represented using solid shapes while ADF fluids are identified by open shapes. The maximum variation observed in the measured anti-icing endurance times between the three plates is during tests performed at 0°C . Here the variation is of $\pm 6\text{ min}$ with OCTAFLO and $\pm 5\text{ min}$ with ADF corresponding to 7%. The smallest variation of about $\pm 3\%$ observed with the two fluids is at -25°C , the lowest testing temperature.

The holdover times of the current SAE Type I fluid HOT table (table 1) are represented in figure 17 by a dotted line for all temperatures. Most of the measured anti-icing endurance times fall above this line, with the exception of ADF at -10° and -25°C .

As shown in figure 17, OCTAFLO samples present endurance times generally greater than ADF fluids, the difference increasing in average from 8 min at 0°C , to 17 and 48 min at -10° and -25°C respectively. For both fluids, endurance times reach a minimum value at -10°C to increase at -25° and 0°C . This behavior can be explained by two factors which contribute to increase anti-icing times when temperature decreases: the higher glycol concentration of fluid, which lowers the freezing point of the sample when the test temperature is lowered and the frost intensity that is lower for lower temperatures. The greater endurance times of OCTAFLO as compared to ADF samples could be explained, in part, by its freezing point which is 5°C lower than the ADF dilution used in tests at -25°C , due to the fact that the fluid is more concentrated.

TABLE 7. FROST TESTS RESULTS

CALIBRATION TESTS

Test Code	Air Temp. Plate Temp. (°C)	Date (y-m-d)	Intensity (g/dm ² h)
CAFRSTA	0.0 ±0.0 -3.0 ±0.1	99-10-05	0.19 ±0.02
CAFRSTC	-9.9 ±0.1 -12.9 ±0.2	99-10-09	0.15 ±0.01
CAFRSTE	-25.2 ±0.5 -28.3 ±0.1	99-10-14	0.08 ±0.01

OCTAFLO (12° AND 15°C BUFFER DILUTION)

Sample Dilution (fluid/water)	Test Code (date)	Air Temp. Plate Temp. (°C)	Ice Data		Fluid Data			
			Plate	Intensity (g/dm ² h)	Plate	30% ¹ (min)	50% ² (min)	100% ³ (min)
C482 35/65	FRSTA001 (99-10-06)	0.0 ±0.0 -2.9 ±0.1	P1	0.21 ±0.01	P2	n.m. ⁴	74	82
			P3	0.20 ±0.01	P4	n.m.	86	99
			P5	0.20 ±0.01	P6	n.m.	79	95
C481 45/55	FRSTC003 (99-10-09)	-9.9 ±0.1 -12.9 ±0.2	P1	0.16 ±0.00	P2	43	46	60
			P3	0.15 ±0.00	P4	46	51	68
			P5	0.15 ±0.01	P6	45	51	66
C480 60/40	FRSTE005 (99-10-14)	-25.0 ±0.7 -27.9 ±0.4	P1	0.07 ±0.00	P2	62	84	n.m.
			P3	0.06 ±0.01	P4	60	87	n.m.
			P5	0.06 ±0.01	P6	61	86	n.m.

ADF (10°C BUFFER DILUTION)

Sample Dilution (fluid/water)	Test Code (date)	Air Temp. Plate Temp. (°C)	Ice Data		Fluid Data			
			Plate	Intensity (g/dm ² h)	Plate	30% ¹ (min)	50% ² (min)	100% ³ (min)
C485 28/72	FRSTA002 (99-10-06)	0.0 ±0.0 -2.9 ±0.1	P1	0.19 ±0.01	P2	55	67	79
			P3	0.18 ±0.01	P4	59	77	91
			P5	0.19 ±0.01	P6	60	72	90
C484 36/64	FRSTC004 (99-10-09)	-9.9 ±0.1 -12.9 ±0.3	P1	0.14 ±0.01	P2	28	31	39
			P3	0.13 ±0.00	P4	31	33	45
			P5	0.14 ±0.00	P6	29	32	43
C483 51/49	FRSTE006 (99-10-15)	-25.7 ±0.2 -27.9 ±0.4	P1	0.07 ±0.00	P2	34	37	57
			P3	0.06 ±0.01	P4	34	36	57
			P5	0.07 ±0.01	P6	33	35	56

¹ 30%: Time for the ice to cover 30% of the test plate.

² 50%: Anti-icing endurance time (failure): Time for the ice to cover 50% of the test plate.

³ 100%: Time for the ice to cover 100% of the test plate.

⁴ n.m. means not measured

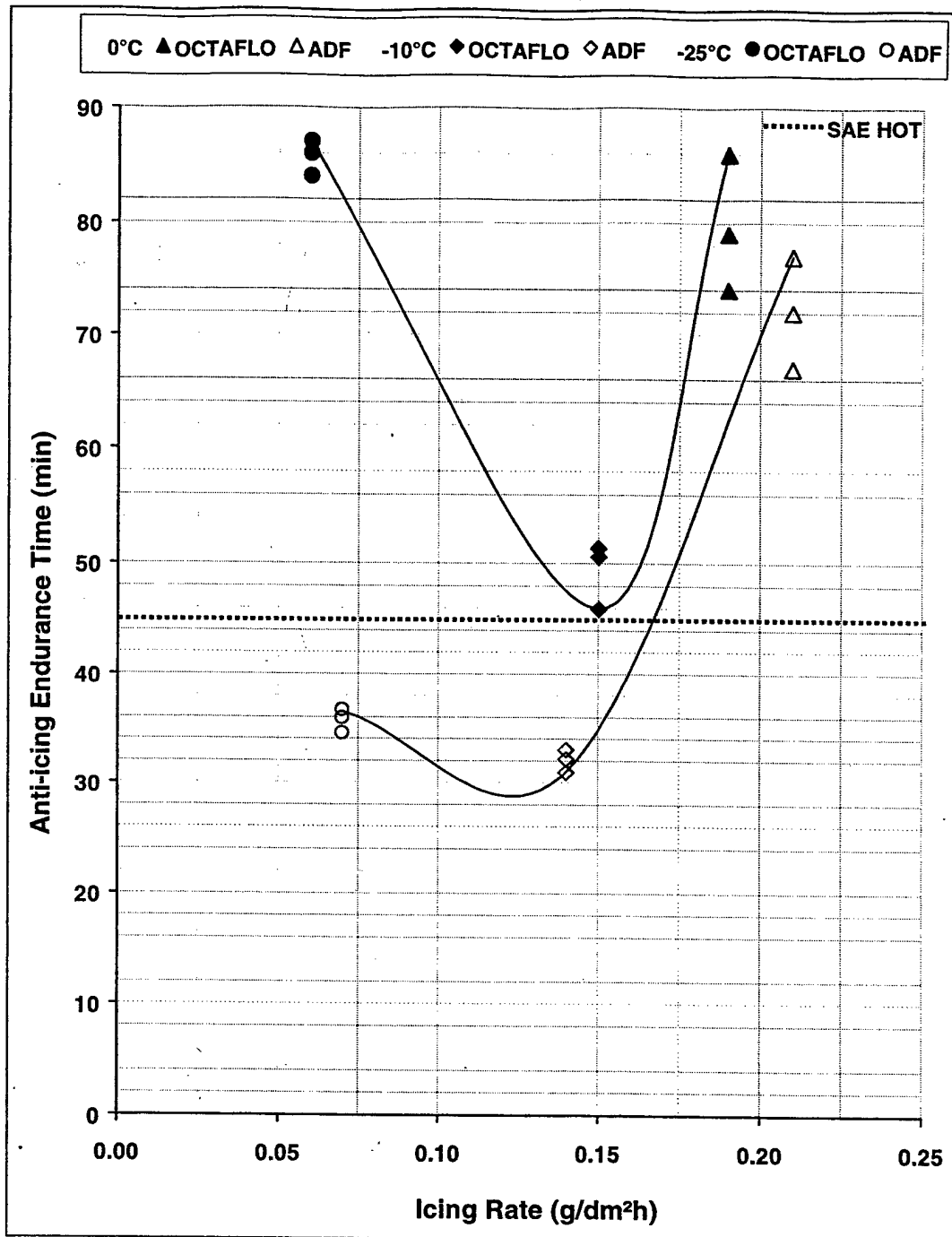

FIGURE 17. FROST ANTI-ICING ENDURANCE TIMES

Failure appears in each frost test as a very thin ice front because of the relatively low icing intensity involved. The failure is illustrated in figure 18 which shows the ice as observed in the frost test performed with ADF samples at -10°C. This picture is typical of the failure observed with frost, which consists of a thin ice deposit grown from surrounding water vapor. This process is entirely different from the others in which ice is accreted from the freezing of supercooled droplets as observed in freezing fog and freezing drizzle tests.

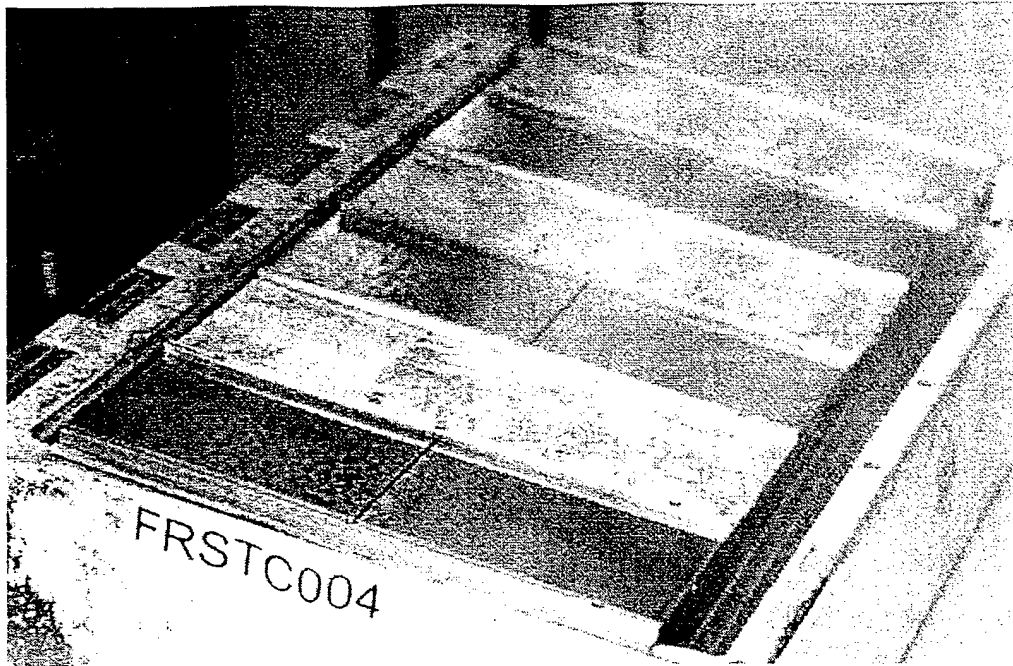

FIGURE 18. ICE FRONT AT -10°C , TYPICAL OF A FROST FAILURE

4.2.3 Freezing Fog Tests.

Freezing fog tests comprise 6 calibration and 12 fluid tests performed at air temperatures of -3° , -10° , and -25°C and icing intensities of 2.0 ± 0.2 and $5.0 \pm 0.3 \text{ g/dm}^2\text{h}$. Results of these tests involving two plates per test are summarized in table 8. In freezing fog tests, the failure is called when the observed ice front covers 30% of the plate, the area being estimated by means of a straight line drawn across a plate 150 mm down from the top edge (see figure 19). The time measured at failure was in minutes and seconds. The dilution level of each sample is given in the fluid label column of table 8. All measured icing intensities correspond to target values of 2.0 and $5.0 \text{ g/dm}^2\text{h}$ with variations maintained well within the prescribed tolerances of ± 0.2 for $2.0 \text{ g/dm}^2\text{h}$, and ± 0.3 for $5.0 \text{ g/dm}^2\text{h}$. Measured plate and air temperatures are also within the target values with variations within the allowable value of $\pm 0.5^{\circ}\text{C}$.

Anti-icing endurance times measured with both fluids at the two icing intensities and air temperatures of 0°C (triangles), -10°C (diamonds), and -25°C (circles) are plotted in figure 20. OCTAFLO samples are represented using solid shapes whereas ADF fluids are identified by open shapes. In the tests performed with OCTAFLO and ADF samples, differences of less than 30 seconds are observed between the anti-icing endurance times measured on the two different panels.

The holdover times of the current SAE Type I fluid HOT table (table 1) are represented in figure 20 by two dotted lines, for 0° to -10°C and below -10°C ranges. All anti-icing endurance times measured fall between or above these lines, with the exception of ADF at -25°C and $5.0 \text{ g/dm}^2\text{h}$.

TABLE 8. FREEZING FOG RESULTS

CALIBRATION TESTS

Test Code	Temp. (°C)	Date (y-m-d)	Ice Data	
			Plate	Intensity (g/dm ² h)
CAFOGA	-3.0 ±0.0	99-10-11	A	2.01 ±0.05
			B	2.05 ±0.04
CAFOGB	-3.0 ±0.1	99-10-06	A	4.9 ±0.2
			B	4.7 ±0.2
CAFOGC	-9.9 ±0.0	99-10-08	A	1.82 ±0.04
			B	1.89 ±0.06
CAFOGD	-9.9 ±0.0	99-10-07	A	5.2 ±0.3
			B	4.9 ±0.2
CAFOGE	-26.0 ±0.1	99-10-12	A	2.06 ±0.08
			B	2.04 ±0.07
CAFOGF	-25.5 ±0.3	99-10-13	A	4.9 ±0.1
			B	4.8 ±0.1

OCTAFLO, 12° AND 15°C BUFFER DILUTION

Sample Dilution (fluid/water)	Test Code (date)	Temp. (°C)	Ice Data		Fluid Data	
			Plate	Intensity (g/dm ² h)	Plate	30% ¹ (min:sec)
C482 35/65	FOGA001 (99-10-11)	-3.1 ±0.1	A	1.99	A	19:30
			B	2.06	B	19:30
C482 35/65	FOGB003 (99-10-06)	-3.0 ±0.1	A	4.7	A	10:10
			B	4.8	B	10:05
C481 45/55	FOGC005 (99-10-09)	-9.9 ±0.0	A	1.90	A	12:30
			B	2.03	B	12:30
C481 45/55	FOGD007 (99-10-07)	-9.9 ±0.0	A	5.2	A	6:45
			B	5.0	B	6:45
C480 60/40	FOGE009 (99-10-13)	-25.5 ±0.6	A	1.93	A	10:30
			B	1.87	B	10:30
C480 60/40	FODF011 (99-10-14)	-25.0 ±0.5	A	4.8	A	6:30
			B	4.8	B	6:30

ADF CONCENTRATE, 10 °C BUFFER DILUTION

Sample Dilution (fluid/water)	Test Code (date)	Temp. (°C)	Ice Data		Fluid Data	
			Plate	Intensity (g/dm ² h)	Plate	30% ¹ (min:sec)
C485 28/72	FOGA002 (99-10-11)	-3.0 ±0.0	A	1.97	A	18:30
			B	2.02	B	18:30
C485 28/72	FOGA004 (99-10-06)	-3.0 ±0.0	A	4.7	A	10:30
			B	4.6	B	10:15
C484 36/64	FOGC006 (99-10-09)	-9.9 ±0.0	A	1.88	A	12:00
			B	1.98	B	12:00
C484 36/64	FOGD008 (99-10-08)	-9.9 ±0.0	A	5.3	A	6:35
			B	4.8	B	6:45
C483 51/49	FOGE010 (99-10-13)	-25.2 ±0.4	A	1.90	A	7:00
			B	1.95	B	7:00
C483 51/49	FOGF012 (99-10-14)	-23.6 ±0.9	A	4.9	A	4:30
			B	4.8	B	4:30

¹ Anti-icing endurance time (failure): Time for the ice to cover 30% of the test plate.



FOGD008

FIGURE 19. ICE FRONT AT -10°C , TYPICAL OF A FAILURE IN A FREEZING FOG TEST

According to figure 20, endurance times of OCTAFLO and ADF samples are very comparable at temperatures of -3° and -10°C . Indeed, the less than 1 min variations observed are within experimental error, even if the difference could be the results of its 12°C buffer for OCTAFLO as compared to that of 10°C of the ADF samples. However, at -25°C , endurance times of OCTAFLO are between 2 to 3 minutes longer than those obtained with ADF fluids. The greater endurance times of OCTAFLO as compared to ADF samples could partially be explained by its 5°C higher buffer than the prescribed value of 10°C at -25°C . As expected for both fluids, measured endurance times are shorter at the lower temperatures and higher icing intensity.

Failure appears in freezing fog tests as an ice front with separated pieces of ice. Indeed, ice deposit in the freezing fog test forms and grows from supercooled droplets freezing upon the plate, whereas under frost conditions, ice forms from water vapor condensing on the plate maintained a few degrees below the air temperature.

The ice front formed in the freezing fog tests for ADF at -10°C is illustrated in figure 19. The photo was taken when the ice front and separated pieces of ice covered the 30% failure area. This picture is typical of failures observed in freezing fog tests performed that consist of an ice front at the top and side edge with an ice sheet on the fluid surface.

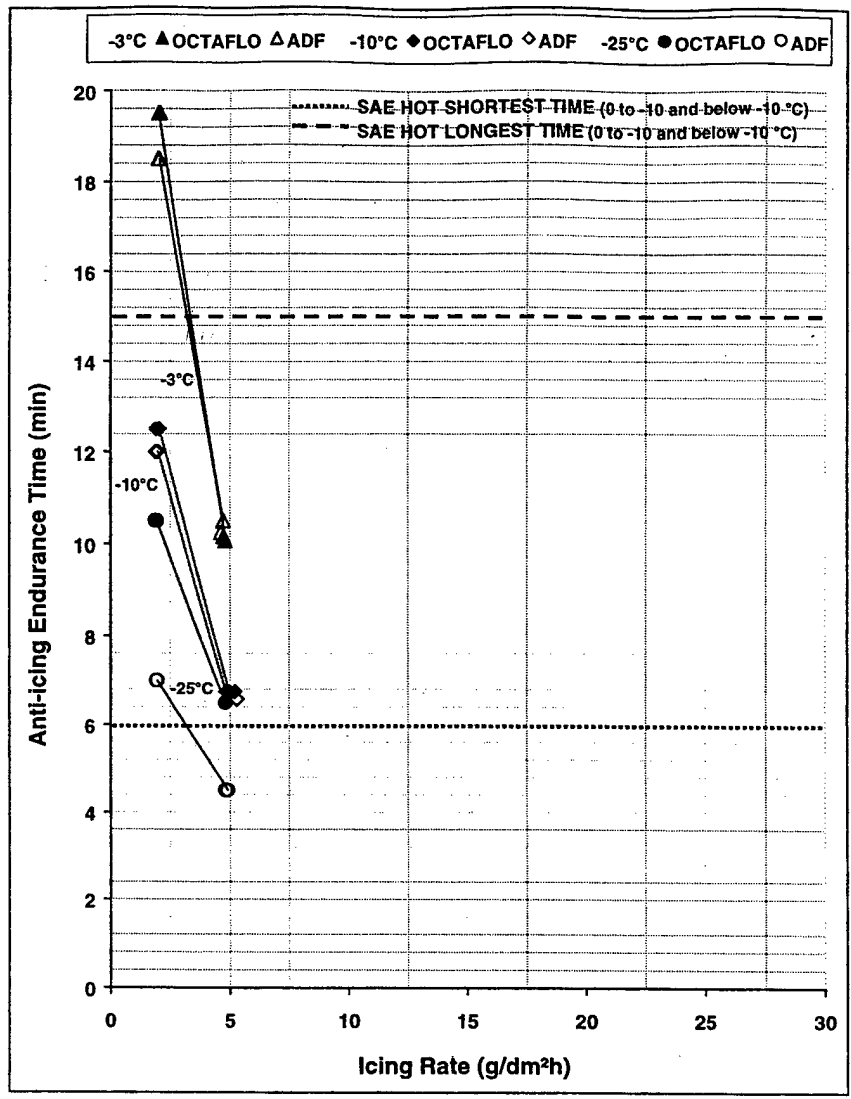

FIGURE 20. FREEZING FOG ENDURANCE TIMES

4.2.4 Snow.

Snow tests consist of 5 calibration and 10 fluid tests performed at air temperatures of -4°, -10° and -25°C and icing intensities of 5.0 ± 0.3 , 10.0 ± 0.5 and 25.0 ± 1.0 g/dm²h. Although the current requirement of the proposed procedures specify -3°C as a test temperature, this test was conducted at -4°C due to difficulty in maintaining proper calibration. Reducing the temperature by 1°C eliminated this difficulty and the proper snow parameters were achieved. Each test involves two fluid-coated panels subjected to artificial snow one at a time. A fluid snow test is performed immediately following a validated calibration test under the specified icing condition. Results of the snow calibration and fluid tests are summarized in table 9. For snow tests, the failure is called when the fluid fails to absorb snow covering 30% of the test panel, which is estimated by an area delineated by a straight line drawn across plate 150 mm down from the top edge. The failure time is measured in minutes and seconds. The dilution level of each sample is given in the fluid label column.

TABLE 9. SNOW TEST RESULTS

CALIBRATION TESTS

Test Code	Temp. (°C)	Date (y-m-d)	Intensity (g/dm ² h)
CASNWA	-4.2 ±0.0	99-10-15	9.9 ±1.0
CASNWB	-4 ±?	99-10-15	24.8 ±2.0
CASNWC	-10.0 ±0.0	99-10-13	9.9 ±0.8
CASNWD	-10 ±?	99-10-11	25.4 ±1.6
CASNWE	-25 ±?	99-10-05	4.9 ±0.3

OCTAFLO, 12° and 15°C BUFFER DILUTION

Sample Dilution (fluid/water)	Test Code	Temp. (°C)	Ice Data		Fluid Data	
			Plate	Intensity (g/dm ² h)	Plate	30% ¹ (min:sec)
C482	SNWA001	-4.1 ±0.0	A	9.9	A	4:35
35/65	SNWA002	-4.1 ±0.0	B	9.9	B	4:30
C482	SNWB005	-4.1 ±0.0	A	24.8	A	2:00
35/65	SNWB006	-4.1 ±0.0	B	24.8	B	2:00
C481	SNWC009	-10.0 ±0.0	A	9.8	A	2:30
45/55	SNWC010	-10.0 ±0.0	B	9.8	B	2:35
C481	SNWD013	-10.0 ±0.1	A	25.4	A	1:25
45/55	SNWD014	-10.0 ±0.0	B	25.4	B	1:30
C480	SNWE017	-25 ±?	A	4.9	A	4:40
60/40	SNWE018	-24.9 ±0.1	B	4.9	B	4:50

ADF CONCENTRATE, 10°C BUFFER DILUTION

Sample Dilution (fluid/water)	Test Code	Temp. (°C)	Ice Data		Fluid Data	
			Plate	Intensity (g/dm ² h)	Plate	30% ¹ (min:sec)
C485	SNWA003	-4.1 ±0.0	A	9.9	A	4:10
28/72	SNWA004	-4.1 ±0.0	B	9.9	B	4:10
C485	SNWB007	-4.1 ±0.0	A	24.8	A	2:15
28/72	SNWB008	-4.1 ±0.0	B	24.8	B	2:10
C484	SNWC011	-10.0 ±0.0	A	9.8	A	2:45
36/64	SNWC012	-10.0 ±0.0	B	9.8	B	2:40
C484	SNWD015	-10.0 ±0.0	A	25.4	A	1:30
36/64	SNWD016	-10.0 ±0.0	B	25.4	B	1:30
C483	SNWE019	-24.9 ±0.1	A	4.9	A	4:30
51/49	SNWE020	-24.9 ±0.1	B	4.9	B	4:25

¹ Anti-icing endurance time (failure): Time for the fluid to fail to absorb snow covering 30% of the plate.

All measured icing intensities correspond to target values of 5.0, 10.0, and 25.0 g/dm²h with variations kept well within the prescribed tolerances of ±0.3 at 5.0 g/dm²h, ±0.5 at 10.0 g/dm²h, and ±1.0 at 25 g/dm²h. Measured air temperatures are also within the target values with variations smaller than the allowable value of ±0.5°C, with the exception of the snow test at -3.0°C. Under that particular temperature condition, it was very difficult to obtain an even snow distribution, so tests were performed at -4°C where the prescribed even icing intensity could be achieved.

The holdover times of the current SAE Type I fluid HOT table (table 1) are represented in figure 21 by two dotted lines for all temperatures. All anti-icing endurance times measured are shorter than the minimum SAE Type I fluid HOT table values.

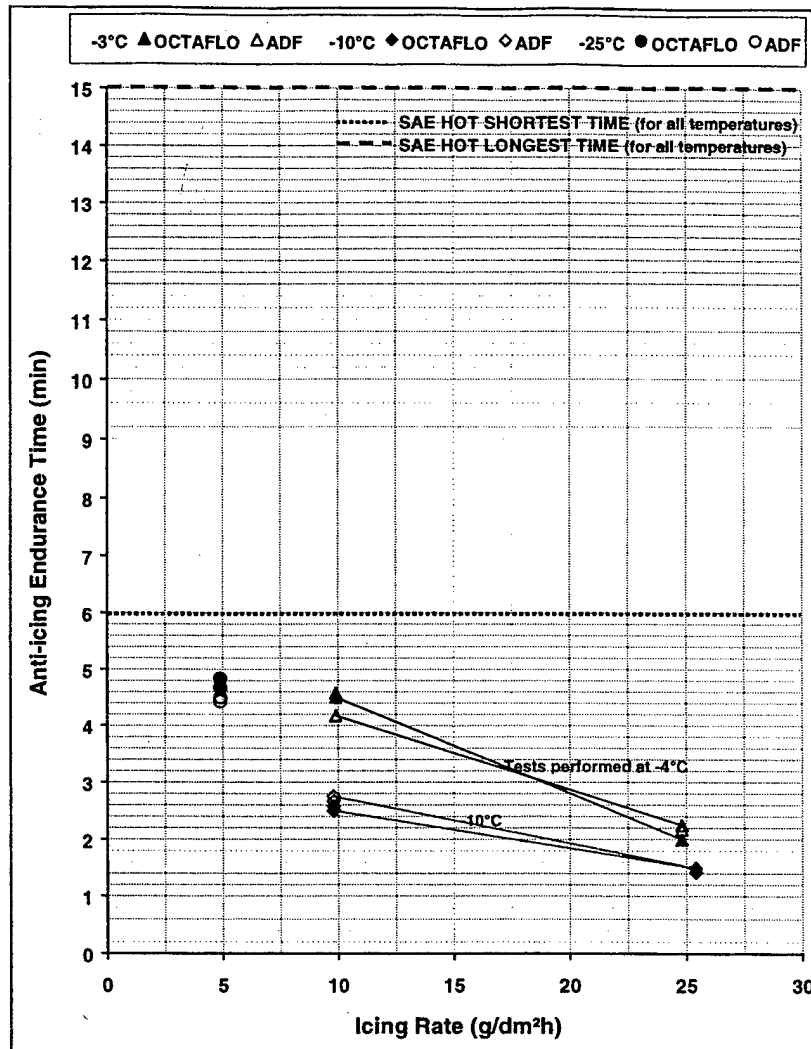

FIGURE 21. SNOW ANTI-ICING ENDURANCE TIMES

Anti-icing endurance times measured with the two fluids at the three values of icing intensities and air temperatures are plotted in figure 21. Triangles, diamond, and circles correspond to tests performed at 0°, -10° and -25°C respectively. OCTAFLO samples are represented using solid shapes whereas ADF fluids are identified by open shapes. In the ten tests performed with OCTAFLO and ADF samples, time variations of less than 1 minute are observed between anti-icing endurance times measured on two different panels coated with the same fluid. These variations do not appear to be dependent on fluid nor the testing temperature, but are within the experimental error of measurement.

OCTAFLO endurance times are 30 sec to 2 min longer than ADF values (figure 21) at the three test temperatures of -3°, -10°, and -25°C. As expected with both fluids, measured endurance

times are shorter at lower temperatures and at higher icing intensities, with the exception of the tests performed at -25°C for $5\text{ g/dm}^2\text{h}$.

As opposed to the frost and freezing fog tests, snow tests involve solid ice particles impacting the fluid surface. In the first minutes that the fluid is exposed to the artificial snow, ice particles are easily dissolved in the fluid. Depending on the air temperature and the intensity of the snowfall, after a few minutes, ice particles take more and more time to be absorbed and a slush begins to form on top of and within the fluid. Therefore, ice contamination at failure consists mainly of slush, which is a mixture of partially diluted fluid and artificial snow particles. The artificial snow particles are both embedded in the fluid and floating on its surface. Even if the amount of observed slush usually is greater at the top of the plate, where the film of fluid is thinner, failure may appear anywhere on the test plate and is called when the fluid fails to absorb snow covering 30% of the test panel surface.

The slush formed in snow tests is shown in figure 22, which shows the ice contamination formed during the snow test performed at -10°C with ADF. The photo was taken when slush covered 30% of the plate, i.e., at failure. This picture is typical of slush in clusters—failure observed in all ten snow tests performed. The percentage of contamination is evaluated in the course of the test by an observer inside the test chamber.

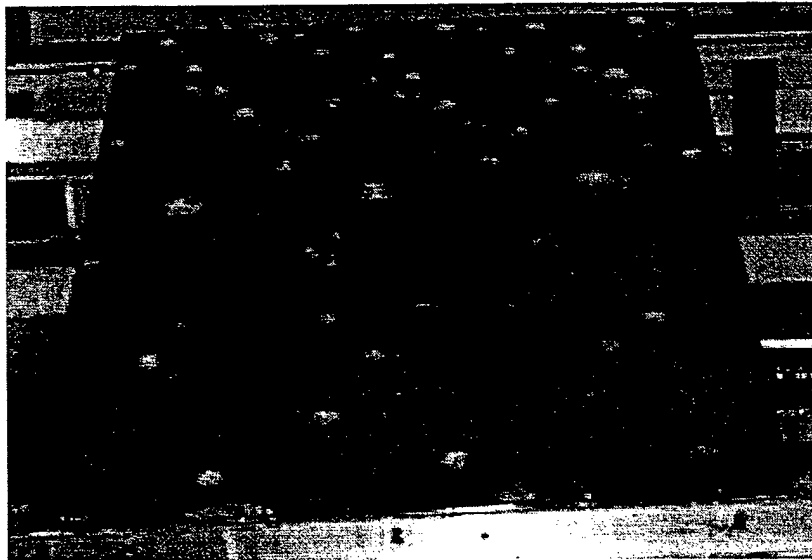

SNWC010

FIGURE 22. SLUSH AT -10°C , TYPICAL SNOW TEST FAILURE

4.2.5 Freezing Drizzle.

Freezing drizzle tests include four calibration and eight fluid tests performed at air temperatures of -3° , and -10°C and icing intensities of 5.0 ± 0.3 and $13.0 \pm 0.5\text{ g/dm}^2\text{h}$. Each test involves two fluid-coated panels, labeled A and B, placed side by side in the test icing area. Results of these tests are summarized in table 10. In freezing drizzle tests, the failure is called when the observed ice front covers 30% of the plate, as in the freezing fog and snow tests. The dilution level of

each sample is given in the fluid label column of table 10. All measured icing intensities correspond to target values of 5.0 and 13.0 g/dm²h with variations kept well within or much less than the prescribed tolerances of ± 0.3 at 5.0 g/dm²h and ± 0.5 at 13.0 g/dm²h. Measured plate and air temperatures are also within the target values with variations smaller than the allowable value of $\pm 0.5^\circ\text{C}$.

TABLE 10. FREEZING DRIZZLE TEST RESULTS

CALIBRATION TESTS

Test Code	Temp. (°C)	Date (y-m-d)	Ice Data	
			Plate	Intensity (g/dm ² h)
CAZLA	-3.0 \pm 0.1	99-09-22	A	4.9 \pm 0.2
			B	4.9 \pm 0.1
CAZLB	-3.0 \pm 0.1	99-09-10	A	13.0 \pm 0.6
			B	13.4 \pm 0.5
CAZLC	-10.0 \pm 0.0	99-09-20	A	5.0 \pm 0.3
			B	4.9 \pm 0.3
CAZLD	-10.0 \pm 0.1	99-09-07	A	13.0 \pm 0.7
			B	13.2 \pm 0.4

OCTAFLO, 12° AND 15°C BUFFER DILUTION

Sample Dilution (fluid/water)	Test Code (date)	Temp. (°C)	Ice Data		Fluid Data	
			Plate	Intensity (g/dm ² h)	Plate	30% ¹ (min:sec)
C482 35/65	ZLA001 (99-09-22)	-3.0 \pm 0.0	A	4.9	A	11:50
			B	4.9	B	12:40
C482 35/65	ZLA001A (99-09-23)	-3.0 \pm 0.0	A	5.1	A	14:00
			B	4.9	B	15:10
C482 35/65	ZLB003 (99-09-10)	-3.0 \pm 0.1	A	12.5	A	6:45
			B	12.6	B	6:40
C481 45/55	ZLC005 (99-09-21)	-10.0 \pm 0.0	A	5.1	A	7:50
			B	5.0	B	7:00
C481 45/55	ZLD007 (99-09-09)	-10.0 \pm 0.2	A	12.7	A	4:00
			B	12.8	B	3:50

ADF CONCENTRATE, 10°C BUFFER DILUTION

Sample Dilution (fluid/water)	Test Code (date)	Temp. (°C)	Ice Data		Fluid Data	
			Plate	Intensity (g/dm ² h)	Plate	30% ¹ (min:sec)
C485 28/72	ZLA002 (99-09-22)	-3.0 \pm 0.0	A	4.9	A	10:50
			B	4.8	B	10:10
C485 28/72	ZLB004 (99-09-11)	-3.0 \pm 0.1	A	12.8	A	5:10
			B	13.5	B	6:00
C484 36/64	ZLC006 (99-09-20)	-10.0 \pm 0.1	A	5.1	A	6:40
			B	4.9	B	6:35
C484 36/64	ZLD008 (99-09-09)	-10.0 \pm 0.1	A	12.8	A	3:30
			B	13.5	B	3:20

¹ Anti-icing endurance time (failure): Time for the ice to cover 30% of the test plate.

Anti-icing endurance times measured with the two candidate fluids at the two icing intensities and air temperatures of -3° and -10°C are plotted in figure 23 where air temperatures of -3° and -10°C are represented by triangles and diamonds respectively. OCTAFLO samples correspond to solid shapes whereas ADF fluids are identified by open shapes. In the eight tests performed with OCTAFLO and ADF samples, endurance time variations of 1 minute or less are observed between the anti-icing endurance times measured on the two different panels. These variations do not appear to be dependent on the fluid nor the testing temperature and are within experimental error of measurement.

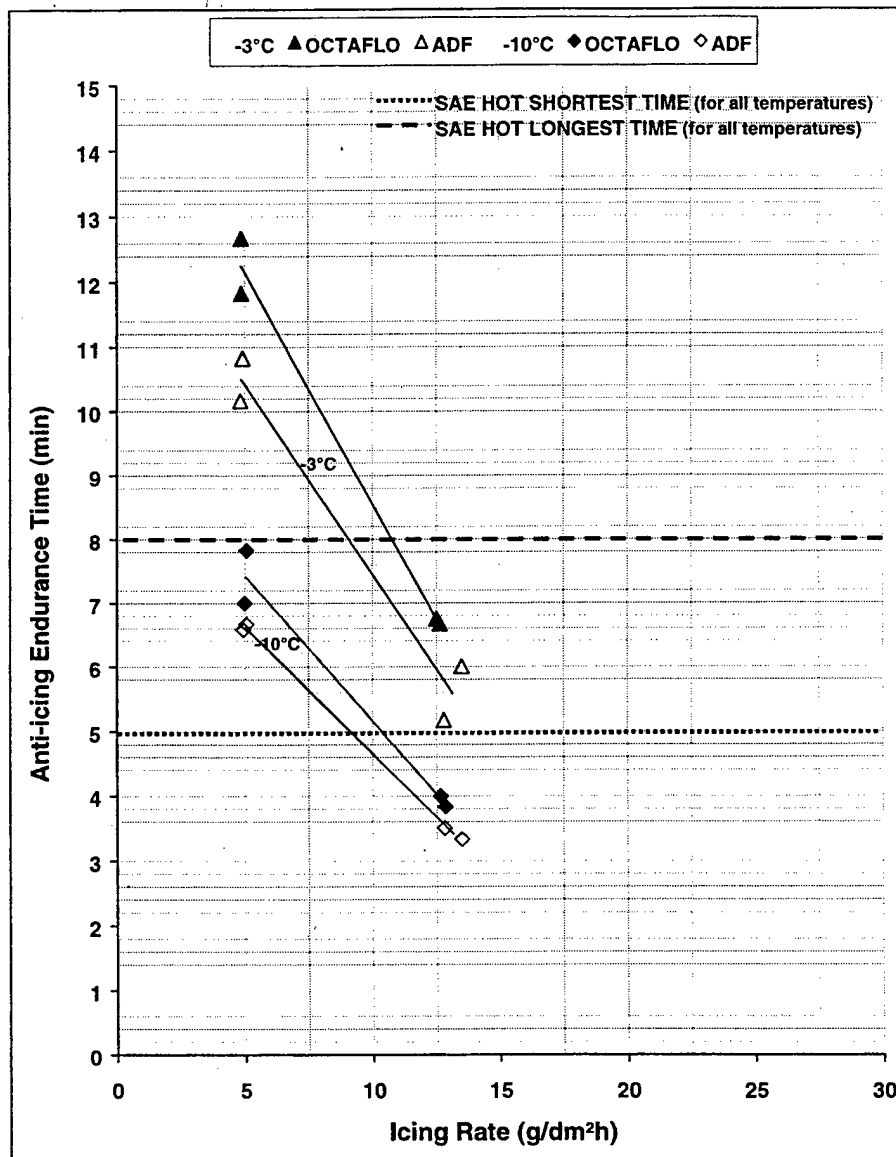

FIGURE 23. FREEZING DRIZZLE ENDURANCE TIMES

The holdover times of the current SAE Type I fluid HOT table (table 1) are represented in figure 23 by two dotted lines for all temperatures. All anti-icing endurance times measured fall between or above these lines, with the exception of both fluids at -10°C and $13.0\text{ g/dm}^2\text{h}$.

According to results shown in figure 23, OCTAFLO endurance times observed under these conditions of temperature and icing intensity are found to be between 1 and 2 minutes longer than those obtained with ADF samples. As expected for both fluids, measured endurance times are shorter at lower temperatures and higher icing intensities.

In freezing drizzle tests, failure appears as an ice front, similar to the freezing fog tests. Moreover, as in the freezing fog tests, ice deposits in freezing drizzle tests, form and grow from supercooled droplets freezing upon plate, the difference being the droplet sizes which are 10 to 20 times larger than those of freezing fog.

The ice front as formed in freezing drizzle for OCTAFLO at -10°C is illustrated in figure 24. This photo was taken when the ice front covered 30% of the area. This photo is typical of the ice contamination observed at failure in other freezing drizzle tests.

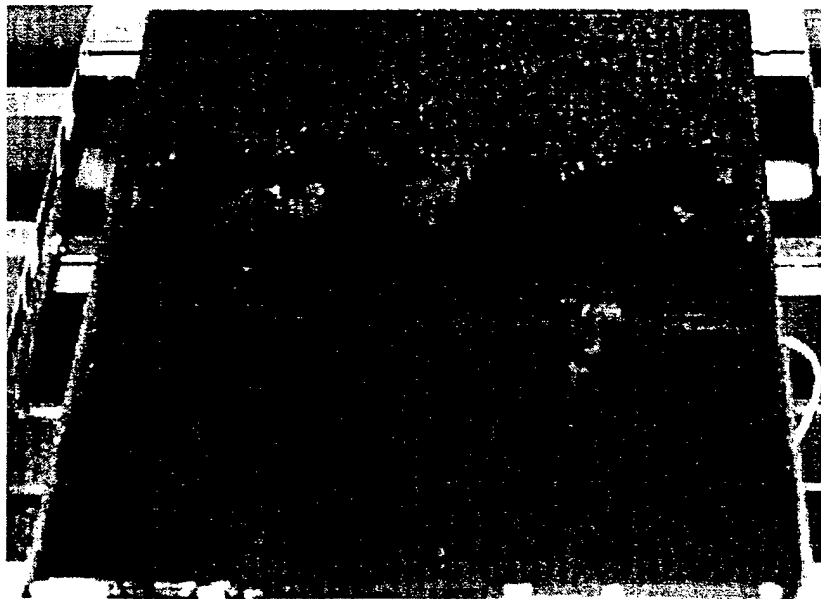

ZLC005

FIGURE 24. ICE FRONT AT -10°C . TYPICAL OF A FAILURE IN A FREEZING DRIZZLE TEST

4.2.6 Light Freezing Rain.

Light freezing rain tests consist of four calibration and eight fluid tests performed at air temperatures of -3° and -10°C and icing intensities of 13.0 ± 0.5 and $25.0 \pm 1.0 \text{ g/dm}^2\text{h}$. Each fluid test involves two panels placed side by side exposed to the freezing rain. Results of calibration and fluid tests are summarized in table 11. In light freezing rain tests, the failure is called when the ice is covering 30% of the plate, as in the freezing drizzle tests. All measured icing intensities correspond to targeted values of 13.0 and 25.0 $\text{g/dm}^2\text{h}$ with variations well within the prescribed tolerances of ± 0.5 at 13.0 $\text{g/dm}^2\text{h}$ and ± 1.0 at 25.0 $\text{g/dm}^2\text{h}$. Measured plate and air temperatures are also within the target values with variations smaller than the allowable value of $\pm 0.5^{\circ}\text{C}$.

TABLE 11. LIGHT FREEZING RAIN TEST RESULTS

CALIBRATION TESTS

Test Code	Temp. (°C)	Date (y-m-d)	Ice Data	
			Plate	Intensity (g/dm ² h)
CALZRA	-3.0 ±0.0	99-10-04	A	13.5 ±0.5
			B	13.0 ±0.4
CALZRB	-3.0 ±0.1	99-10-01	A	25.3 ±1.1
			B	24.1 ±0.6
CALZRC	-10.0 ±0.1	99-10-03	A	13.4 ±0.6
			B	13.0 ±0.5
CALZRD	-10.0 ±0.1	99-09-30	A	24.8 ±1.1
			B	24.3 ±0.6

OCTAFLO, 12° AND 15°C BUFFER DILUTION

Sample Dilution (fluid/water)	Test Code (date)	Temp. (°C)	Ice Data		Fluid Data	
			Plate	Intensity (g/dm ² h)	Plate	30% ¹ (min:sec)
C482 35/65	LZRA001 (99-10-05)	-3.0 ±0.0	A	13.2	A	7:00
			B	12.6	B	7:00
C482 35/65	LZRA001A (99-10-05)	-3.0 ±0.0	A	12.7	A	7:00
			B	12.5	B	7:30
C482 35/65	LZRB003 (99-10-01)	-3.0 ±0.1	A	24.9	A	4:20
			B	24.1	B	5:00
C481 45/55	LZRC005 (99-10-03)	-10.0 ±0.2	A	13.1	A	3:30
			B	13.1	B	3:25
C481 45/55	LZRD007 (99-09-30)	-10.0 ±0.1	A	25.9	A	2:20
			B	25.1	B	2:30

ADF CONCENTRATE, 10°C BUFFER DILUTION

Sample Dilution (fluid/water)	Test Code (date)	Temp. (°C)	Ice Data		Fluid Data	
			Plate	Intensity (g/dm ² h)	Plate	30% ¹ (min:sec)
C485 28/72	LZRA002 (99-10-04)	-3.0 ±0.0	A	12.9	A	5:40
			B	13.1	B	5:50
C485 28/72	LZRB004 (99-10-01)	-3.0 ±0.0	A	25.9	A	4:20
			B	25.4	B	4:30
C484 36/64	LZRC006 (99-10-03)	-10.0 ±0.1	A	13.4	A	2:30
			B	13.5	B	2:30
C484 36/64	LZRD008 (99-09-30)	-10.0 ±0.1	A	24.7	A	2:00
			B	25.3	B	2:00

¹ Anti-icing endurance time (failure): Time for the ice to cover 30% of the test plate.

Anti-icing endurance times measured with the two candidate fluids at the two icing intensities and air temperatures of -3° and -10°C, are plotted in figure 25 where air temperatures of -3° and -10°C correspond to triangles and diamonds respectively. The OCTAFLO samples are identified by solid shapes, and the ADF samples are identified by open shapes. In the eight tests performed with OCTAFLO and ADF samples, time variations of 1 minute or less are observed between the anti-icing endurance times measured on the two different panels. These variations do not appear

to be dependent of the fluid nor the testing temperature and can be attributed to experimental error of measurement.

The holdover times of the current SAE Type I fluid HOT table (table 1) are represented in figure 25 by two dotted lines for all temperatures. All anti-icing endurance times measured fall between or above these lines.

According to results shown in figure 25, endurance times of OCTAFLO are, like in freezing drizzle tests, 1 to 2 minutes longer than those obtained with ADF samples. As expected for both fluids, measured endurance times are lower at lower temperatures and higher icing intensities.

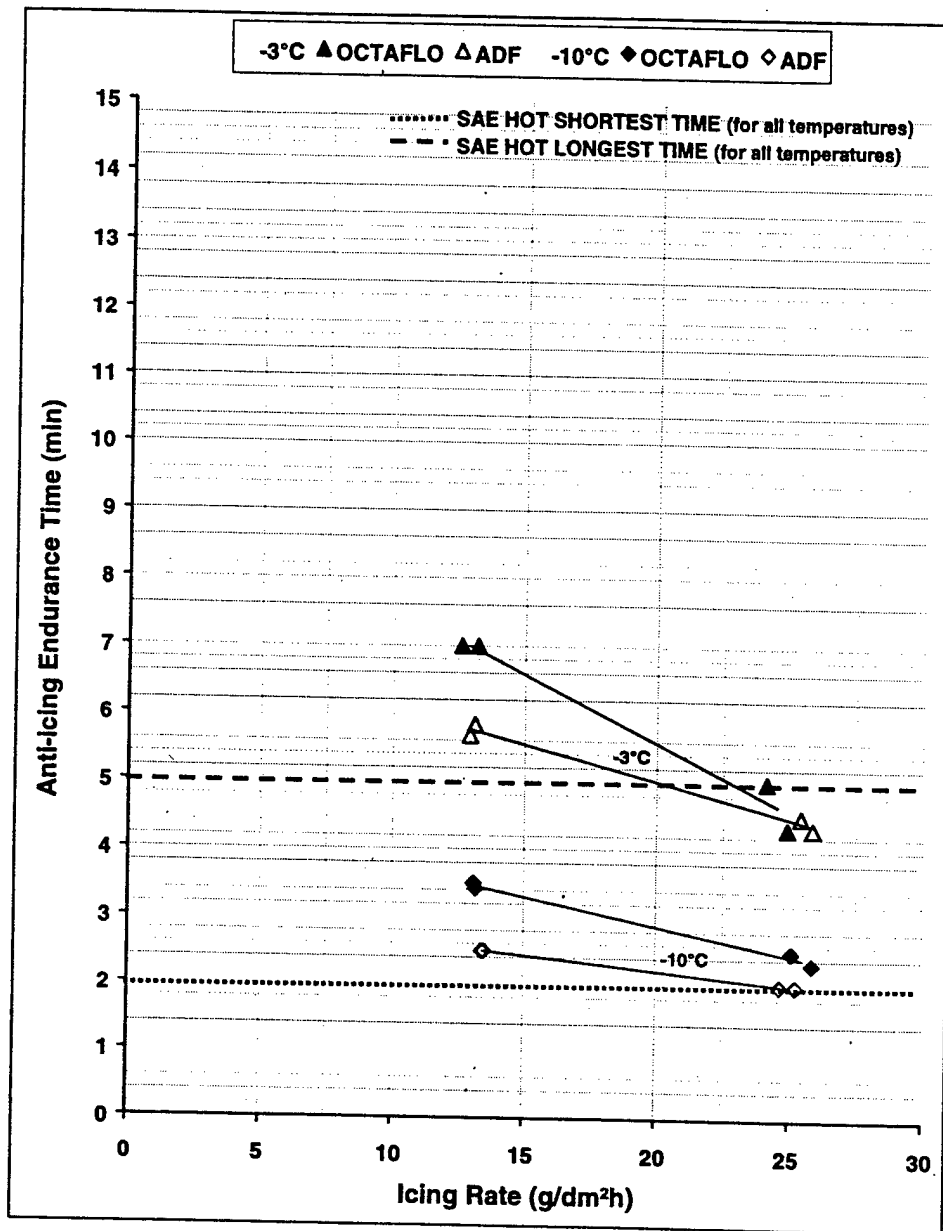
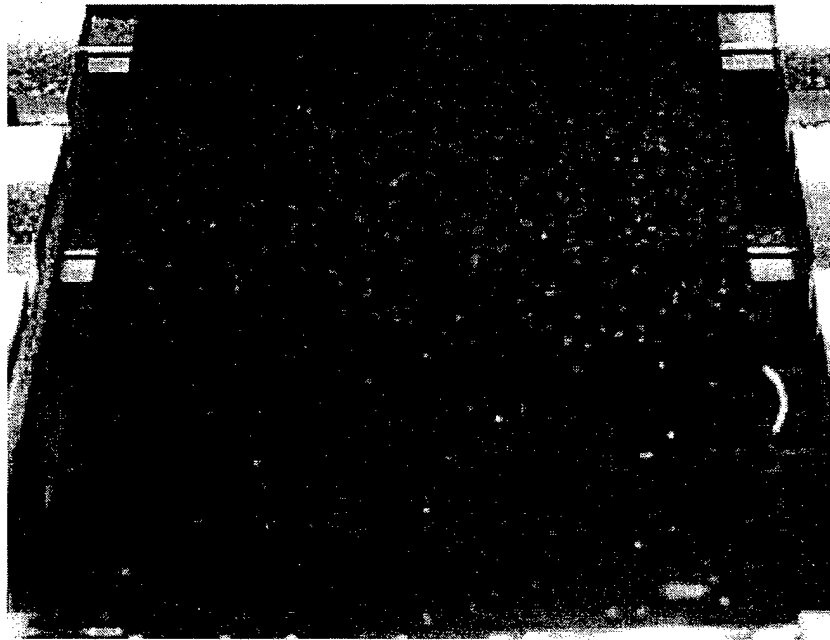

FIGURE 25. LIGHT FREEZING RAIN ENDURANCE TIMES

In light freezing rain tests, failure appears as a speckled ice front. Ice deposits, in light freezing rain tests, form and grow from supercooled droplets freezing on the plate.

The speckled ice front as formed in light freezing rain with OCTAFLO at -10°C is illustrated in figure 26. This photo was taken when the ice front covered 30% of the area. This picture is typical of the speckled ice front observed at failure in other light freezing rain tests.



LZRB003

FIGURE 26. SPECKLED ICE FRONT AT -10°C , TYPICAL OF A FAILURE IN A LIGHT FREEZING RAIN TEST

4.2.7 Rain on a Cold-Soaked Wing.

Rain on a cold-soaked wing tests consist of two calibration and four fluid tests performed at an air temperature of $+1^{\circ}\text{C}$ and icing intensities of 5.0 ± 0.3 and 75 ± 3.0 $\text{g}/\text{dm}^2\text{h}$. Two water droplet sizes are used to produce the freezing rain: $237 \mu\text{m}$ MVD at $5 \text{ g}/\text{dm}^2\text{h}$ and $1400 \mu\text{m}$ MVD at $75 \text{ g}/\text{dm}^2\text{h}$. For this AET testing procedure, the cold soak box is first chilled to $-17^{\circ} \pm 0.5^{\circ}\text{C}$ then the test panel is placed on it. After the panels top surface is adequately covered to prevent frost formation due to condensation, the cold box is allowed to warm up. When the temperature sensor that is located between the panel and the cold box surface reads -10°C , the test plate is coated with the fluid sample and exposed to freezing rain after the standard 5-minute delay.

Each fluid test involves two panels placed one at a time on the cold-soaked stand. The fluids used for these tests are ADF 21/79 (fluid/water) diluted samples with a freezing point of -9°C and OCTAFLO 30/70 dilution with a freezing point of -11°C . For comparison purpose, the two fluid tests were also performed at $5.0 \text{ g}/\text{dm}^2\text{h}$ icing intensity with a 10°C buffer with respect to the cold soak box temperature of -10°C ; one with ADF 36/64 diluted samples (F.P. = -20°C) and

the other with OCTAFLO 45/55 dilution (F.P. = -22°C). A valid ice catch calibration test at the two prescribed icing intensities is performed prior to each test condition.

The holdover times of the current SAE Type I fluid HOT table (table 1) are represented in figure 27 by two dotted lines for all temperatures. Anti-icing endurance times measured at 5 g/dm²h fall between or above these lines and those measured at 75 g/dm²h are shorter than the SAE Type I fluid HOT table values.

Results of calibration and fluid tests are summarized in table 12. The failure is called when the observed ice front covers 30% of the test panel. All measured icing intensities correspond to target values of 5.0 and 75 g/dm²h with variations kept within the prescribed ±0.3 at 5.0 g/dm²h and ±3.0 at 75 g/dm²h. Measured plate and air temperatures are also at the target value of +1°C with variations smaller than the allowable value of ±0.5°C.

TABLE 12. RAIN ON A COLD SOAK BOX TEST RESULTS

CALIBRATION TESTS

Test Code	Temp. (°C)	Date (y-m-d)	Ice Data	
			Plate	Intensity (g/dm ² h)
CACSWA	1.0 ±0.0	99-10-07	A	4.9 ±0.2
CACSWB	0.9 ±0.1	99-10-11	A	76 ±3

OCTAFLO, 12° AND 23°C BUFFER DILUTION

Sample Dilution (fluid/water)	Test Code (date)	Temp. (°C)	Ice Data		Fluid Data	
			Plate	Intensity (g/dm ² h)	Plate	30% ¹ (min:sec)
C512 30/70	CSWA001 (99-10-08)	1.0 ±0.0	A	4.9	A	6:05
			B	5.2	B	5:00
C481 45/55	CSWA003 (99-10-09)	1.0 ±0.0	A	5.0	A	7:50
C512 30/70	CSW B005 (99-10-12)	1.0 ±0.0	A	75.4	A	00:47
			B	72.1	B	00:42

ADF CONCENTRATE, 10° AND 21°C BUFFER DILUTION

Sample Dilution (fluid/water)	Test Code (date)	Temp. (°C)	Ice Data		Fluid Data	
			Plate	Intensity (g/dm ² h)	Plate	30% ¹ (min:sec)
C511 21/79	CSWA002 (99-10-09)	1.0 ±0.0	A	4.8	A	2:20
			B	5.1	B	2:00
C484 36/64	CSWA004 (99-10-09)	1.0 ±0.0	A	5.2	A	7:00
C511 21/79	CSWB006 (99-10-12)	1.0 ±0.0	A	74.5	A	00:35
			B	73.6	B	00:30

¹ Anti-icing endurance time (failure): Time for the ice to cover 30% of the test plate.

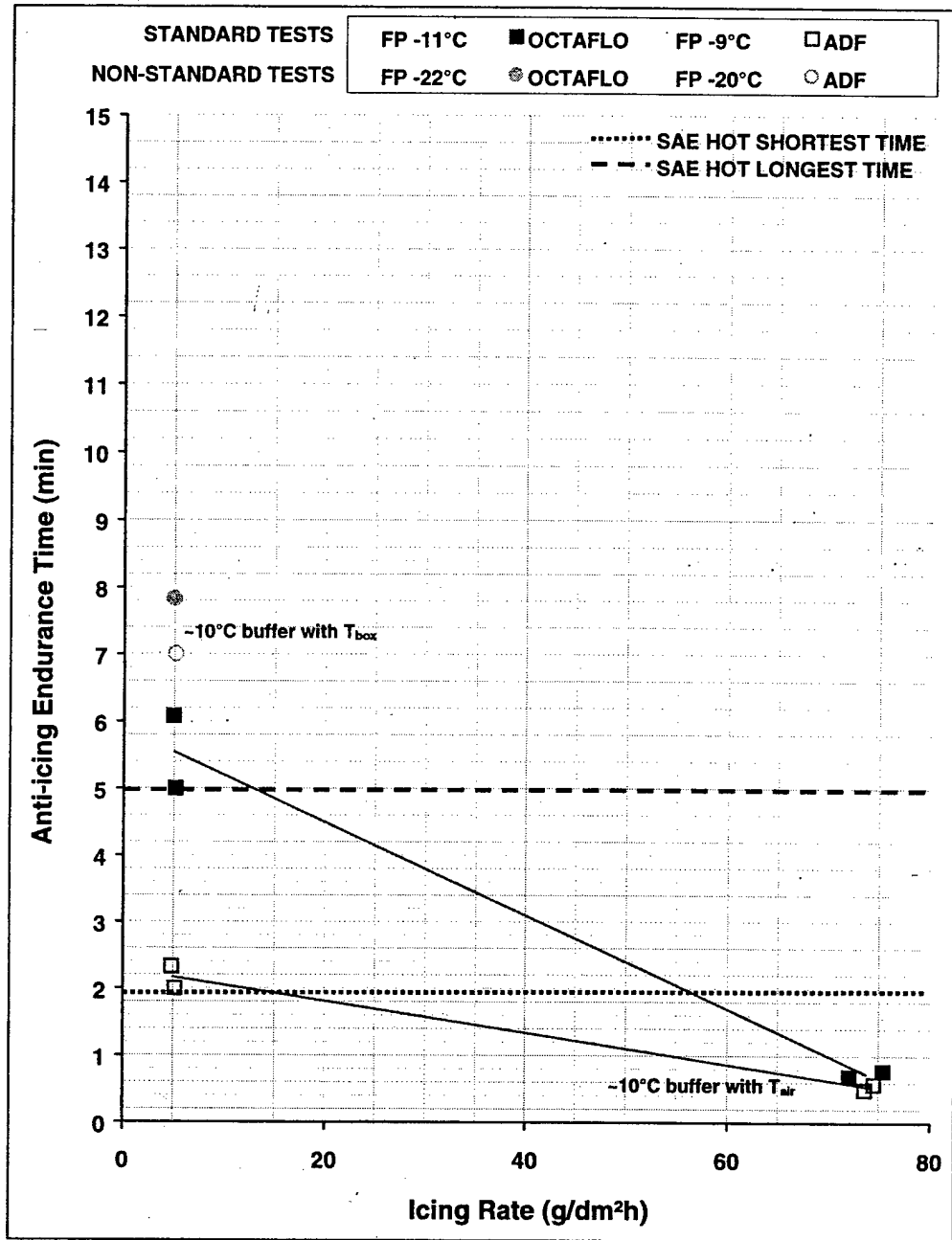

FIGURE 27. RAIN ON A COLD-SOAKED WING ENDURANCE TIMES

Anti-icing endurance times measured with the two diluted samples are shown in figure 27 for the icing intensities of 5 and 75 g/dm²h. The OCTAFLO are identified by using solid shapes, and the ADF samples are identified by open shapes. Diluted samples with freezing point of -10° ±1°C are identified by using squares, whereas those with freezing points near -20°C are identified by circles. In the tests performed with samples of the same fluid, time variations of less than 1 minute are observed between the anti-icing endurance times measured on the two different panels. These variations do not appear to be dependent on the fluid nor the testing temperature and are within the experimental error of measurement.

As shown in figure 27, OCTAFLO and ADF endurance times in tests performed at the 75 g/dm²h icing intensity are comparable within the experimental error, which can be estimated to less than 30 sec. However, at the low 5 g/dm²h icing intensity, OCTAFLO endurance times are found to be 3 to 4 minutes longer than those obtained with ADF samples. Nevertheless, the number of tests, limited to only two is not sufficient to analyze this discrepancy, these tests need to be repeated. As expected for both fluids, endurance times are shorter with higher icing intensity.

The endurance times observed with the fluids diluted to a freezing point around -20°C (circles in figure 27) are 2 and 5 minutes longer with OCTAFLO and ADF respectively as compared to dilutions with a freezing point about 10°C higher. As mentioned before, the number of tests is not sufficient to analyze this difference.

In rain, on a cold-soaked wing test, failure appears as an ice front, as observed in other AET tests, with the exception of snow. Although freezing fog and freezing drizzle consists of supercooled droplets which freeze on impact, ice contamination in rain on a cold-soaked wing test was formed in a similar manner. For the latter, rain droplets freeze because of contact with a surface whose temperature is below freezing.

The ice front as observed in rain on a cold-soaked wing test for OCTAFLO at +1°C and 5 g/dm²h, is illustrated in figure 28. This photo was taken when the ice front covered 30% of the test plate area. This picture is typical of the ice fronts observed at failure in other rain on a cold-soaked wing tests in which an appreciable ice contamination were initiated on the edges and at the top of the plate. This phenomenon is called the edge effect.

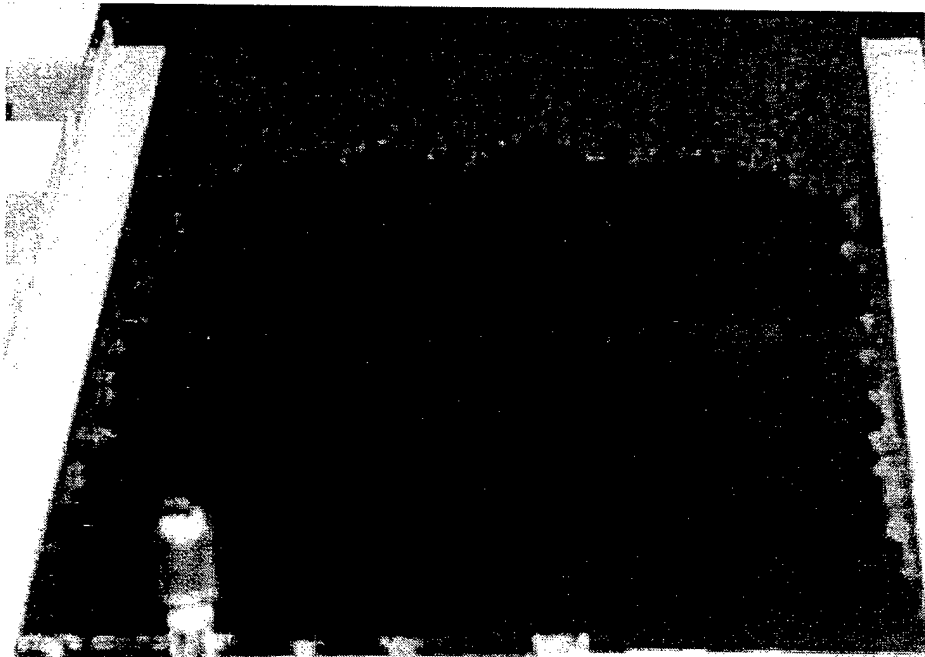

CASWA001B

FIGURE 28. FAILURE IN RAIN ON A COLD-SOAKED WING AT +1°C

5. COMPARISON BETWEEN AMIL AND APS RESULTS.

5.1 SCOPE.

One of the objectives of this study is to establish a comprehensive basis to compare and analyze results obtained by APS in the NRC laboratory with those of this study in order to determine the variation between the two methods and facilities, and to reconcile and establish a single set of standardized procedures. The procedures are, ultimately, to be published after concurrence with the SAE G-12 Fluids and Holdover Time Subcommittees. This way, any testing facility with the appropriate equipment will be able to perform AET tests by adhering to an approved published set of procedures.

Another expected outcome of this study is the substantiation of the current generic Type I fluid HOT table. Indeed, once substantiated, new fluids will have to be tested according to the AET set of standardized tests, and the generic table will be adjusted accordingly prior to the use of the fluid. As with the establishment and the publication of approved standardized procedures, the substantiation of generic and specific HOT tables is also under the responsibility of the SAE G-12 Fluids and Holdover Time Subcommittees. This is why the results obtained in the present work are to be further discussed in subsequent subcommittee meetings.

5.2 COMPARISON OF AMIL AND APS DATA.

During the month of July 1999, APS conducted tests in NRC laboratory with samples of the same two Type I fluids. In fact, the two manufacturers sent a sample of the same lot to AMIL and APS to be sure that both facilities will perform tests on identical fluids. In the APS work program, Type I diluted samples were tested according to procedures which are similar or comparable to five of the six AET procedures used in the present work. APS, however did not test for frost. Since APS tests were performed prior to the meeting held in Montreal on July 30, 1999 [3], the APS/NRC procedures were not subjected to any discussion with AMIL representatives.

Results of APS/NRC tests performed with the two Type I fluids were forwarded to AMIL in mid-November 1999. The information released by APS did not contain the variations in icing intensities and air temperatures, which should be expressed by the standard deviation.

The analysis of APS data obtained in the five different types of icing precipitation tested reveals that the aimed comparison is limited to tests performed at -10°C under freezing fog, snow, freezing drizzle, and light freezing rain conditions and at $+1^{\circ}\text{C}$ with rain on a cold-soaked wing test. The anti-icing endurance times, as measured by AMIL and APS in these five testing conditions, judged comparable, are presented in table 13. The difference between AMIL and APS failure times, expressed in absolute and percentage values, are shown in the two last columns of the table.

TABLE 13. COMPARISON OF AMIL AND APS RESULTS

AMIL				APS				Comparison	
Fluid Identification	Failure time (min)	Icing Intensity (g/dm ² h)	Test Temp. (°C)	Fluid Identification	Failure time (min)	Icing Intensity (g/dm ² h)	Test Temp. (°C)	Δ Fail. Time (min)	Δ %
FREEZING FOG									
OCTAFLO 45/55	6.8	5.2	-9.9	OCTAFLO 42/58	7.4	5.5	-10.6	0.7	9%
OCTAFLO 45/55	6.8	5.0	-9.9	OCTAFLO 42/58	7.1	5.8	-10.5	0.3	5%
OCTAFLO 45/55	12.5	1.9	-9.9	OCTAFLO 42/58	13.3	1.4	-10.5	0.8	6%
OCTAFLO 45/55	12.5	2.0	-9.9	OCTAFLO 42/58	12.8	1.9	-10.5	0.3	3%
ADF 36/64	12.0	1.9	-9.9	ADF 36/64	11.5	1.7	-10.5	-0.5	-4%
ADF 36/64	12.0	2.0	-9.9	ADF 36/64	11.8	1.7	-10.5	-0.3	-2%
ADF 36/64	6.6	5.3	-9.9	ADF 36/64	6.7	4.8	-10.6	0.1	1%
ADF 36/64	6.8	4.8	-9.9	ADF 36/64	5.8	5.3	-10.6	-0.9	-16%
SNOW									
OCTAFLO 45/55	1.4	25.4	10.0	OCTAFLO 42/58	2.8	24.2	-10.0	1.4	50%
OCTAFLO 45/55	1.5	25.4	10.0	OCTAFLO 42/58	2.8	24.2	-10.0	1.3	46%
ADF 36/64	1.5	25.4	10.0	ADF 36/64	2.7	24.4	-10.7	1.2	44%
ADF 36/64	1.5	25.4	10.0	ADF 36/64	2.7	26.8	-10.6	1.2	44%
FREEZING DRIZZLE									
OCTAFLO 45/55	7.8	5.1	-10.0	OCTAFLO 42/58	8.2	5.6	-10.0	0.3	4%
OCTAFLO 45/55	7.0	5.0	-10.0	OCTAFLO 42/58	7.8	5.4	-10.5	0.8	11%
OCTAFLO 45/55	4.0	12.7	-10.0	OCTAFLO 42/58	5.7	12.8	-10.8	1.7	29%
OCTAFLO 45/55	3.8	12.8	-10.0	OCTAFLO 42/58	5.4	12.8	-10.9	1.6	29%
ADF 36/64	6.7	5.1	-10.0	ADF 36/64	8.6	4.9	-10.0	1.9	22%
ADF 36/64	6.6	4.9	-10.0	ADF 36/64	8.3	4.7	-10.4	1.7	20%
ADF 36/64	3.5	12.8	-10.0	ADF 36/64	6.0	12.0	-10.9	2.5	42%
ADF 36/64	3.3	13.5	-10.0	ADF 36/64	5.7	12.6	-10.9	2.3	41%
LIGHT FREEZING RAIN									
OCTAFLO 45/55	3.5	13.1	-10.0	OCTAFLO 42/58	5.3	12.0	-9.7	1.8	33%
OCTAFLO 45/55	3.4	13.2	-10.0	OCTAFLO 42/58	5.2	12.0	-10.0	1.7	34%
OCTAFLO 45/55	2.3	25.9	-10.0	OCTAFLO 42/58	4.0	26.3	-10.1	1.7	42%
OCTAFLO 45/55	2.5	25.1	-10.0	OCTAFLO 42/58	4.2	26.3	-10.1	1.7	40%
ADF 36/64	2.5	13.4	-10.0	ADF 36/64	5.2	12.5	-9.6	2.7	52%
ADF 36/64	2.5	13.5	-10.0	ADF 36/64	4.8	12.4	-10.0	2.1	48%
ADF 36/64	2.0	24.7	-10.0	ADF 36/64	4.1	24.8	-10.1	2.1	51%
ADF 36/64	2.0	25.3	-10.0	ADF 36/64	4.0	25.1	-10.1	2.0	50%
RAIN ON A COLD SOAK BOX									
OCTAFLO 30/70	6.1	4.9	1.0	OCTAFLO 27.5/72.5	6.2	4.9	1.7	0.1	1%
OCTAFLO 30/70	5.0	5.2	1.0	OCTAFLO 27.5/72.5	6.3	4.8	1.5	1.3	20%
OCTAFLO 30/70	0.8	75.4	1.0	OCTAFLO 27.5/72.5	1.9	65.9	1.7	1.1	59%
OCTAFLO 30/70	0.7	72.1	1.0	OCTAFLO 27.5/72.5	2.1	65.4	1.7	1.4	66%
ADF 21/79	2.3	4.8	1.0	ADF 21.5/78.5	6.3	5.4	1.5	4.0	63%
ADF 21/79	2.0	5.1	1.0	ADF 21.5/78.5	6.0	5.4	1.5	4.0	67%
ADF 21/79	0.6	74.5	1.0	ADF 21.5/78.5	2.0	65.9	1.2	1.4	71%
ADF 21/79	0.5	73.6	1.0	ADF 21.5/78.5	1.8	63.8	1.4	1.3	71%

In all cases, with the exception of freezing fog, APS endurance times, when expressed in percentage, are longer than AMIL measurements. Indeed, with freezing fog tests, APS-measured endurance times are very comparable to AMIL values, the time differences ranging from -16% to +9%, for a $\pm 10\%$ variation. With the four other types of tests, HOT values measured by APS are found to be, on average, 30% longer than those obtained by AMIL. That increase seems to depend on the nature and the intensity of the iced precipitation. In the snow tests, the average increase is 45%; in freezing drizzle and light freezing rain tests, increases range from low values of 4% to 33%, respectively, to high values of 42% to 50% for an average increase of 23% in freezing drizzle and 41% in light freezing rain. In rain on a cold-soaked wing tests, APS endurance times are found to be longer by 1% to 71%, corresponding to an increase averaging of 36%.

These endurance time differences, when expressed in percentage, correspond to very large values. However, in absolute values, i.e., in minutes, the time differences are 0.1 to 4 minutes. When the 4 min. differences, observed in the two rain on a cold-soaked wing tests with ADF samples, are excluded (see section 4.2.7), APS endurance times are on average 1.3 min. longer than AMIL values; more precisely, +0.5 min. in the case of freezing fog tests, +1.3 min. in the case of snow tests, +1.6 min. in the case of freezing drizzle tests, +2.0 min. in the case of light freezing rain tests, and +1.8 min. in the case of rain on a cold-soaked wing tests. Since the failure times of Type I fluids are rather short as compared to those of Type II and IV fluids, the relatively short times has the effect to overvalue the increase, considering a 1 minute time variation could be within the acceptable experimental error of measurement.

Among the five AET tests conducted, freezing fog tests are those with the longest endurance times and for which the variations are the smallest as expressed in percentage. It is not, therefore, a surprise that APS and AMIL freezing fog tests are those for which the agreement is closest of the five types of icing tests. On the basis of this agreement, the experimental error, which includes observer evaluation of percent of ice coverage at failure can be approximated at about 15%.

Nevertheless, even if the measured time differences, 1 to 2 minutes, are shorter, it appears to be systematic. At this point, we can look attentively at the testing procedures used in the two facilities to identify and isolate the main factors which could be at the source of that 1 to 2 min. differences.

5.3 COMPARISON OF AMIL AND APS TESTING PROCEDURE.

Thirteen test parameters of AMIL and APS/NRC are compared in table 14. These factors vary from the environmental conditions, plate and panel alloy, surface roughness to fluid dilution, sample application, and plate cleaning. Among these factors, only four parameters, i.e., testing of unsheared samples, use of hard water for dilution, fluid temperature at application, and freezing points of ADF samples dilution can be considered identical.

TABLE 14. ANTI-ICING MATERIALS INTERNATIONAL LABORATORY VS APS/NRC TEST CONDITIONS

Parameters	AMIL	APS/NRC	Different	Same
1. Test temperatures	+1°, -3°, -10° and -25°C	+1°, -10° and -30°C	✓	
2. Relative humidity	—	> 70%	✓	
3. Fluid shearing	Not sheared	Not sheared		✓
4. Water used for dilution	Hard water AMS 1424B § 3.3.3.1	Hard water AMS 1424B § 3.3.3.1		✓
5. Fluid application temperature	20° ±5°C	20° ±5°C		✓
6. Volume of fluid applied	500 mL	1000 mL	✓	
7. Delay between application and exposure to water spray	5 minutes	No delay	✓	
8. Water for precipitation	ASTM D 1193 Type IV water	Well water from NRC test site	✓	
9. Test plate alloy and finish surface	Aluminum alloy AMS 4037 (2024-T3) Ra = 0.1 to 0.2 μm	Alclad Aluminum 2024-T6 or 5052-H32 polished standard roll mill finish	✓	
10. Plate size and working area	300 x 500 x 3.2 mm with working area of 300 x 500 mm	300 x 500 x 3.2 mm with working area of 250 x 450 mm	✓	
11. Test plate cleaning	Plate cleaned with ethanol and hot water	Scrape up and squeegee. Rinse with fluid and squeegee again	✓	
12. Icing rate measurement	Calibration before test and calibration plates during test	Weigh pans exposed to precipitation at different times during test	✓	
12. Dilution ratio (buffer)				
Tests -10°C OCTAFLO	45/55 (F.P. = -22°C)	42/58 (F.P. = -20°C)	✓	
Tests -10°C ADF	36/64 (F.P. = -20°C)	36/64 (F.P. = -20°C)		✓
Tests +1°C OCTAFLO	30/70 (F.P. = -11°C)	27.5/72.5 (F.P. = -9°C)	✓	
Tests +1°C ADF	21/79 (F.P. = -9°C)	21.5/78.5 (F.P. = -9°C)		✓

The factors which are different can be divided into two groups. In the first group, there are factors judged secondary which are judged to have nonsignificant or minor effects. These secondary factors include the water used for icing generation, and the plate cleaning and roughness. In the second group, there are the factors judged relatively important and susceptible to cause measurable effects. These more important factors consist of the plate working area, the sample dilution, the precipitation rate measurement method, the sample dilution, the amount of fluid applied, and the 5-minute delay prior to the start of precipitation. As shown in table 14, there are many parameters which can influence the anti-icing endurance time, probably with a relative importance. Some of these factors were studied and reported in previous investigations [10, 11 and 12]. Unfortunately, most of these studies were done on Type II and Type IV fluids,

and therefore, there is limited test information regarding Type I fluids. The following discussion is devoted to the three factors judged more important to explain and understand the observed differences.

5.3.1 Sample Dilution.

A sample selection procedure for SAE Type I fluids was approved as part of the AET testing procedure [8] and was recommended at the May 1999 Toronto Fluid Subcommittee meeting [6]. In it, it states that the sample selected has to be diluted to a 10°C freezing point buffer. At AMIL, the buffer recommended by the manufacturer was used for each temperature. For the ADF fluid, Union Carbide recommends to dilute the fluid in 1% increments to always have a 10°C buffer; this is how they recommend customers to use the fluid. For the OCTAFLO fluid, Octagon Process Inc. recommends to dilute the fluid in 5% increments; again, this is how they recommend customers to use the fluid. At APS, they diluted both fluids (ADF and OCTAFLO) to a buffer of exactly 10°C; therefore, in the case of ADF, both laboratories tested the same dilutions. Whereas, in the case of OCTAFLO, the dilutions prepared by AMIL are somewhat more concentrated. For example, at -10°C the OCTAFLO dilution had a freezing point 2°C lower at AMIL than APS. This extra 2°C buffer may be, in part, responsible for the longer endurance times of OCTAFLO as compared to ADF. It is also important to do not forget they are two different fluids, made with different kinds of glycol.

Table 15 shows that the differences between AMIL and APS endurance times are usually larger for ADF than OCTAFLO, with the exception of freezing fog and snow tests. This fact can possibly be attributed to the 2°C higher buffer used by AMIL for their dilutions. However, it does not explain the longer times observed by APS with respect to AMIL; on the contrary it should lead to longer endurance times for AMIL.

TABLE 15. COMPARISON OF DIFFERENCES BETWEEN OCTAFLO AND ADF VALUES

Condition	Fluid	Average Difference Between Laboratories (min)	Difference OCTAFLO—Difference ADF (min)
Freezing Fog	OCTAFLO	0.5	0.9
	ADF	-0.4	
Snow	OCTAFLO	1.4	0.2
	ADF	1.2	
Freezing Drizzle	OCTAFLO	1.1	-1.0
	ADF	2.1	
Light Freezing Rain	OCTAFLO	1.7	-0.5
	ADF	2.2	
Rain on a Cold-Soaked Wing	OCTAFLO	0.9	-1.7
	ADF	2.6	

5.3.2 Amount of Fluid Applied and 5-Minute Delay.

In the APS/NRC testing procedures, a volume in the order of 1L of fluid is applied on the test panel while it is exposed to precipitation during its application. In the procedures used by AMIL, the amount of fluid applied is limited to 500 mL, and the fluid-coated plate is exposed to precipitation only 5 minutes after fluid application. Five hundred mL of fluid is equivalent to a fluid thickness of 3 mm. The 5-minute wait allows the fluid to settle, coat the plate well, and further reduce in thickness for a representative surface. One L of fluid is equivalent to a fluid thickness of 7 mm. Because there was no wait time at APS, implies that full thickness of fluid was there at the start of the test. The 5-minute wait is a practice commonly used in standard tests like WSET and HHET. It contributes to obtain at the start of the test a settled fluid coating which is not disturbed by the falling precipitation. Moreover, previous AMIL experiments have shown that the thickness of the fluid film left on the plate after a 5-minute settling time was independent of the volume of fluid applied.

In order to investigate whether these two specific factors had an effect, two AET tests were performed at -3°C with OCTAFLO 35/65 (FP of -15°C) samples: a freezing drizzle test at $5\text{ g/dm}^2\text{h}$ in which the fluid is applied under icing, and a light freezing rain test at $13\text{ g/dm}^2\text{h}$ in which 1000 mL of fluid is applied on the panels and allowed to settle for 5 minutes. Freezing drizzle temperature recordings (ZLA001 and ZLA001A), illustrating the effect of the 5-minute delay, are shown in figure 29; whereas those of light freezing rain tests (LZRA001 and LZRA001A), showing the effect of a 500 mL additional volume of applied fluid, are depicted in figure 30.

Air and plate temperatures recorded in the four tests present all the same pattern. Air temperature is maintained exactly at the targeted value of $-3.0^{\circ} \pm 0.1^{\circ}\text{C}$ during the course of the test; whereas plate temperature, as measured by a RTD sensor located on the underside of the test plate, varies considerably once the fluid is applied at room temperature. Indeed, plate temperature, which is at $-3.0^{\circ} \pm 0.5^{\circ}\text{C}$ just before fluid application, rises sharply during fluid application to reach a maximum value and decrease thereafter. During this period, the fluid film is cooled by air convection and impacting supercooled water droplets. At the time of the failure call, the plate temperature reaches a minimum value which increases thereafter to the end of the test. This temperature rise is due to the latent heat released during the solidification of water.

The effects of both factors are summarized in table 16. It can be noted that the time at the minimum temperature of the four recordings corresponds to the measured endurance time values.

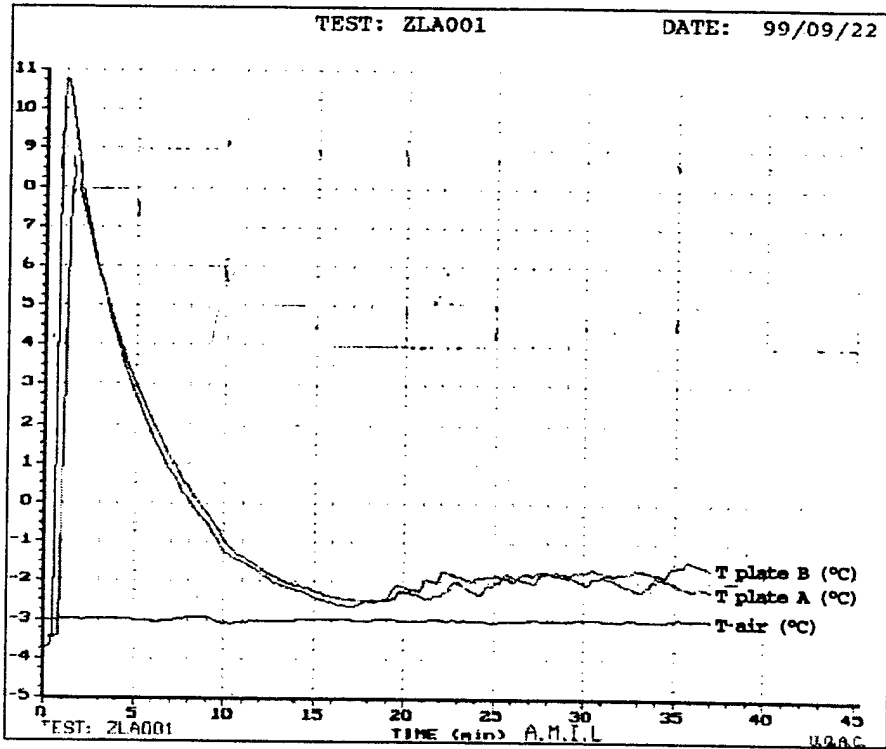

(a) Test with 5-minute delay

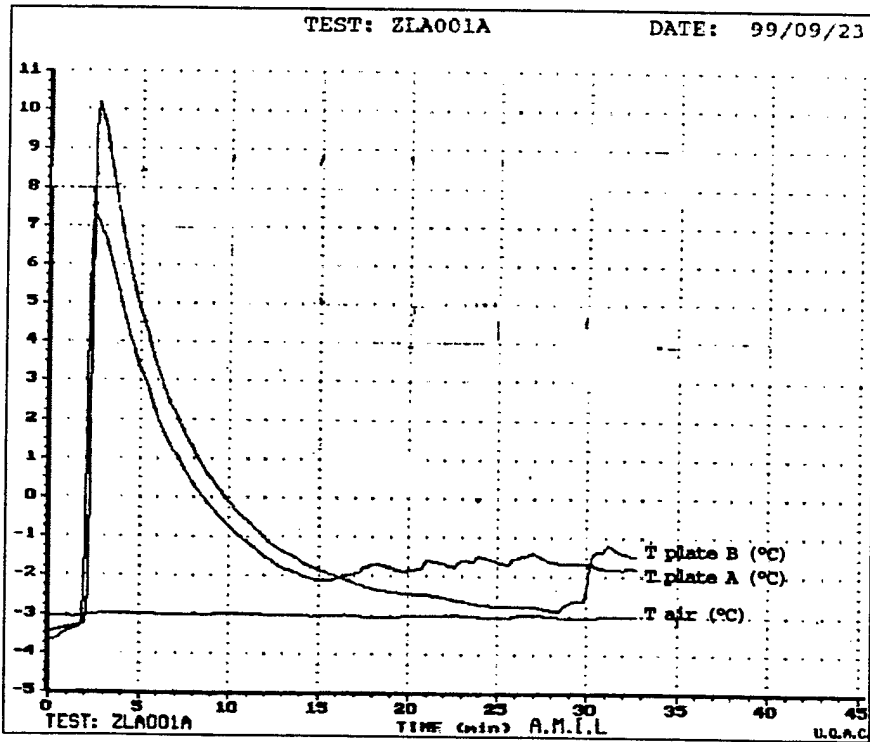

(b) Test without delay

FIGURE 29. AIR AND PLATE TEMPERATURE RECORDINGS (a) TEST WITH 5-MINUTE DELAY AND (b) TEST WITHOUT DELAY

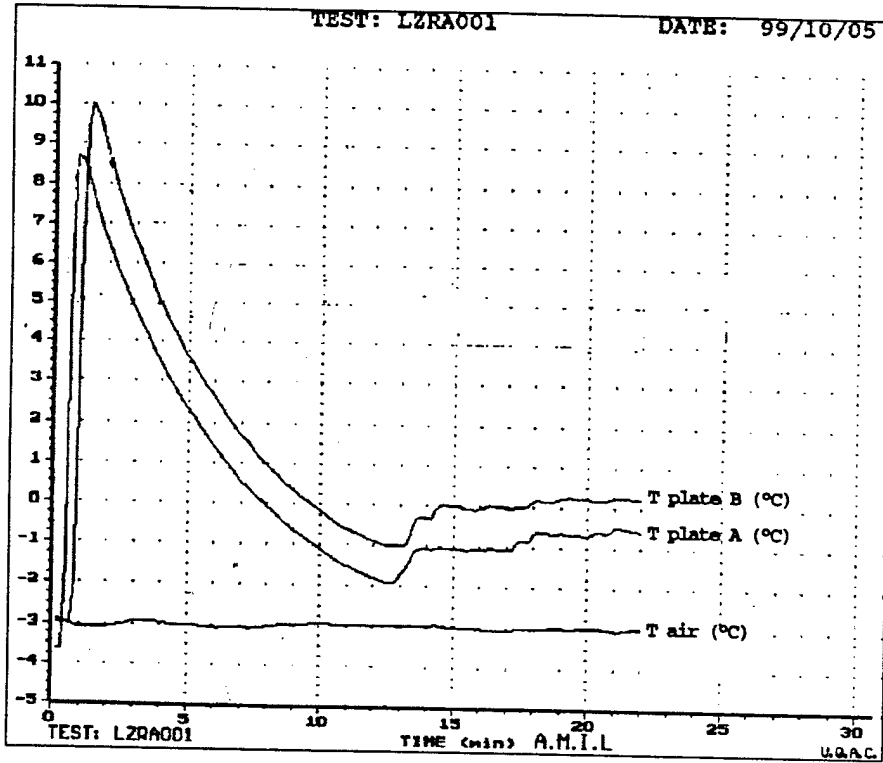

(a) Test with 500 mL of fluid applied

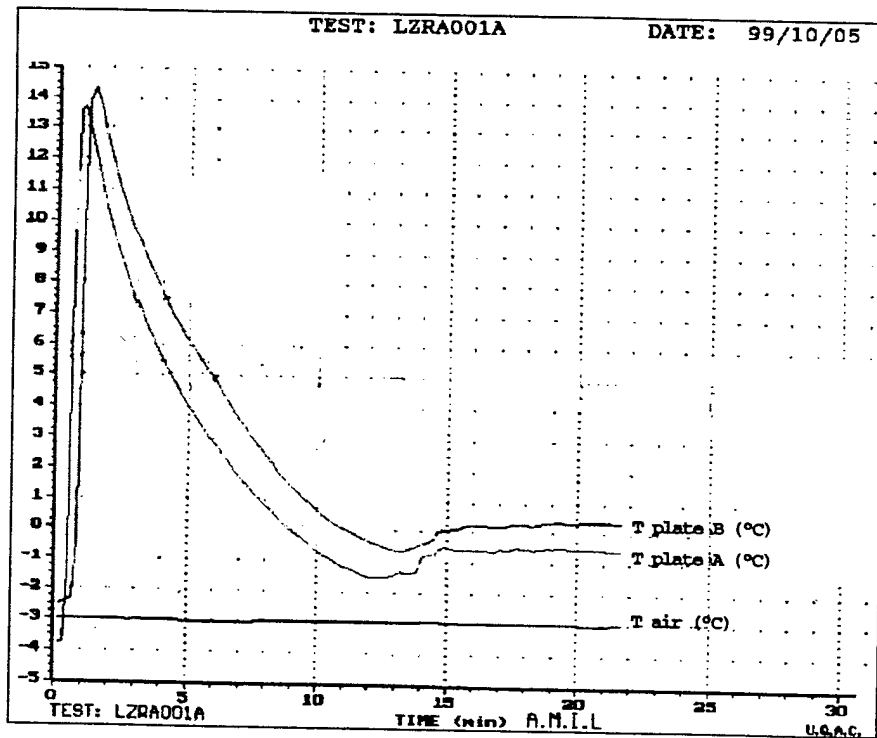

(b) Test with 1000 mL of fluid applied

FIGURE 30. AIR AND PLATE TEMPERATURE RECORDINGS (a) TEST WITH 500 mL OF FLUID APPLIED AND (b) TEST WITH 1000 mL OF FLUID APPLIED

TABLE 16. FIVE-MINUTE DELAY AND VOLUME OF APPLIED FLUID EFFECTS

Waiting Time Volume of Fluid	Test Label	Plate	T _{air}	T _{max}	T _{start}	T _{failure}	AET _{failure time}	Average Difference	% Difference
5 minutes 500 mL	ZLA001	A	-3.0	8.3	2.5	-2.5	11m50s	2m45s	+18
		B	-3.0	10.8	2.5	-2.5	12m40s		
0 minutes 500 mL	ZLA001A	A	-3.0	7.3	7.3	-2.0	14m50s		
		B	-3.0	10.2	10.2	-2.0	15m10s		
5 minutes 500 mL	LZRA001	A	-3.0	8.8	2.0	-0.9	7m00s	0m15s	+3
		B	-3.0	10.0	2.5	-1.8	7m00s		
5 minutes 1000 mL	LZRA001A	A	-3.0	13.8	5.0	-1.3	7m00s		
		B	-3.0	14.5	6.0	-0.5	7m30s		

5.3.2.1 Five-Minute Delay Effect.

In the test conditions for freezing drizzle at -3.0°C, using a 5-minute settling time shortens the measured endurance times by 2 to 3 minutes. This decrease can be understood by the differences in the cooling and draining of the fluid coating which differs whether or not it is exposed to icing. According to table 16, the test without the 5-minute delay (test ZL001A) began when the thickness of the fluid film and the temperature of fluid-coated plate are both at their maximum. The fluid film at the start of the test is then about 6°C higher and thicker without the 5-minute delay than with it. The fluid is cooled by air convection and by impacting supercooled droplets. Because of the higher fluid temperature and the thicker fluid film, more water is required, i.e., a longer time, for the fluid to be cooled and diluted to a freezing point at -2.0°C. For the test with the 5-minute delay, the fluid thickness and temperature are smaller (by 6°C for the temperature) than for the test without the 5-minute delay. As a result, it takes less time, i.e., a smaller amount of supercooled water, for the fluid film to be diluted and cooled by air convection to a freezing temperature of -2.5°C. On the basis of these test results, the delay of 5 minutes used by AMIL in AET procedures appears to have contributed to shortening the measured failure times, in an order of magnitude of 2 to 3 minutes with respect to the APS/NRC results.

5.3.2.2 One Thousand mL vs Five Hundred mL Applied Fluid Effect.

In the test conditions of light freezing rain at -3.0° (table 16), the fact that 1000 mL instead of 500 mL was applied, with a 5-minute delay, appears not to have any significant effect on the measured failure times. The fact that no significant effect is observed, even if the fluid temperature at the start of the test obtained with 1000 mL of applied fluid is by about 3°C higher than that observed with an applied volume of 500 mL, seems to indicate that the factor which is important will be the amount of fluid on the plate at the start of the test rather than the air cooling by convection. According to results of the preceding test, it can be assumed that, if testing was done without the 5-minute delay, the increase volume would likely have the effect of increasing the time to fail, mainly because of the greater amount of fluid at the start of the test, giving then a much thicker coating. However, no tests were performed to investigate this factor in AET tests, and therefore, the determination of the full importance of the volume of the fluid applied would require additional tests conducted in conjunction with the 5-minute delay.

5.3.3 Comparison of Endurance Time Under Similar Conditions.

It is interesting to compare values of the endurance times measured under similar conditions, for instance, those obtained at 13 g/dm²h icing intensity in light freezing rain and freezing drizzle tests. Endurance time values measured in the two tests at -3° and -10°C (printed in bold in tables 10 and 11) are listed in table 17.

Table 17 shows that endurance times as measured in freezing drizzle and light freezing rain tests are similar, within the experimental error of measurement.

TABLE 17. LIGHT FREEZING RAIN VS FREEZING DRIZZLE AT 13 g/dm²h

	-3°C LZR	-3°C ZL	-10°C LZR	-10°C ZL
OCTAFLO	7:00	6:45	3:30	3:55
ADF	5:45	5:45	2:30	3:25

In light freezing rain tests, failure appears as an ice front, as with freezing fog tests. Moreover, as freezing fog and freezing drizzle tests, ice deposits formed in light freezing rain tests grows from supercooled droplets freezing the plate. The difference between freezing drizzle and light freezing rain is the water droplet size, the latter involves drops of 1000 µm, 5 to 10 times larger than those of freezing drizzle (MVD of 250 µm). Table 17 shows that the size of droplets, in the range of the ones generated in this study, do not significantly affect the measured anti-icing endurance times.

6. CONCLUSIONS.

On the basis of the results of AET tests performed on two certified SAE Type I aircraft deicing fluids, the following conclusions can be drawn:

- The results obtained demonstrate the feasibility and the practicability of performing all six AET testing procedures within the prescribed accuracy and repeatability. Indeed, environmental parameters in AET calibration and fluid tests were within the target values with variations within the prescribed allowable drifts.
- Moreover, AET results obtained under the six environmental conditions showed an expected inverse relationship between endurance times and precipitation rate, the shortest and longest failure times being obtained respectively under the highest and lowest icing rates.
- Time variations of 1 minute or less were generally observed between the endurance times measured with the same sample. These variations do not appear to be dependent on the fluid nor the testing temperature; the 1-minute variation is considered to be within the experimental error of measurement.

- When the AET results were compared with HOT test data obtained by APS in the NRC facility using a somewhat different testing method, AMIL failure times were 0.1 to 4 minutes shorter than APS's measured values, with the exception of freezing fog tests. Indeed, with freezing fog tests, APS's measured endurance times are very comparable to AMIL's values; the time difference range being from -16% to +9%, with a $\pm 10\%$ variation. With the four other types of tests, HOT values measured by APS are found to be on average 30% (about 1 to 2 minutes in most cases) longer than those obtained by AMIL.
- Examination of APS and AMIL testing procedures allows for the identification of 13 differences, among which the following six can be judged more significant:
 - the plate working area
 - the sample dilution
 - the failure call
 - the precipitation rate measurement method
 - the amount of fluid applied
 - the 5-minute delay prior to the start of precipitation

The last two factors may partially explain the lower failure times observed in the AMIL facility. This interpretation is supported by the results obtained by two tests in which effects of these two parameters were compared.

In the process of reducing the number of parameters which are not the same in the APS/NRC and AMIL procedures, it is recommended that each parameter for which a difference is identified in this report shall be analyzed and discussed. In order to realize this, real conditions and actual practices of using fluids in airports during deicing and anti-icing operations should be taken into consideration, as well as the feasibility of performing reproducible tests in a laboratory.

7. REFERENCES.

1. SAE Aerospace, Unconfirmed Minutes, G-12 Holdover Time Subcommittee Meeting, May 17-18, 1999, Toronto, Ontario.
2. SAE Aerospace, Workgroup on Laboratory Methods to Derive Holdover Time Guidelines, November 20-21, 1997, Dorval, Quebec, 21 pages.
3. SAE Aerospace, Workgroup on Laboratory Methods for Experimental Endurance Time Testing Meeting, July 30, 1999, Montreal, Quebec.
4. SAE Aerospace, Workgroup on Laboratory Methods for Experimental Endurance Time Testing Meeting, October 6, 1999, Chicoutimi, Quebec.
5. Leroux, Jacques, Aerospace Standard 5485, "Draft Endurance Time Tests for Aircraft Deicing/Anti-Icing Fluid SAE Type I, II, III, and IV," October 17, 1999, 50 pages.

6. SAE Aerospace, Unconfirmed Minutes, G-12 Holdover Time Subcommittee Meeting, May 21, 1996, Zurich, Switzerland.
7. SAE Aerospace, Unconfirmed Minutes, G-12 Fluids Subcommittee Meeting, May 18-19, 1999, Toronto, Ontario.
8. SAE Aerospace, Sample Selection Procedure for Endurance Time Testing for Fluids Meeting the Requirements of SAE AMS 1424, May 27, 1999, 3 pages.
9. SAE Aerospace, Workgroup on Laboratory Methods for Experimental Endurance Time Testing Meeting, March 18-19, 1999, Montreal, Quebec.
10. Bernardin, S., Dubuisson, C., and Laforte, J.L., "Aircraft Ground De/Anti-Icing Fluid Holdover Time Laboratory Test Program: Freezing Drizzle and Freezing Rain," report prepared for Transport Canada, TP13036E, May 1997, 60 pages.
11. Bernardin, S., Dubuisson, C., and Laforte, J.L., "Development of Laboratory Test Procedures to Replace Field Anti-Icing Fluid Tests," report prepared for Transport Canada, TP3141E, November 1997, 110 pages.
12. Bernardin, S., Beisswenger, A., and Laforte, J.L., "Holdover Time Field Tests," report prepared for Transport Canada, TP13590E, May 1999, 57 pages.

8. ADDITIONAL INFORMATION.

1. Dawson, P., D'Avirro, J., and Potter, R.V., "Validation of a Methodology for Simulating a Cold-Soaked Wing," report prepared for Transport Canada, TP12899E, October 1996, 92 pages.
2. SAE Aerospace, Unconfirmed Minutes, G-12 Fluids Subcommittee Meeting, May 12-13, 1998, Vienna, Austria.
3. SAE Aerospace, Unconfirmed Minutes, G-12 Holdover Time Subcommittee Meeting, May 11-12, 1998, Vienna, Austria.
4. SAE Aerospace, Unconfirmed Minutes, G-12 Fluids Subcommittee Meeting, October 22-23, 1997, Atlanta, Georgia.
5. SAE Aerospace, Unconfirmed Minutes, G-12 Holdover Time Subcommittee Meeting, June 10, 1997, Pittsburgh, Pennsylvania.
6. SAE Standard AMS 1424B - Deicing/Anti-Icing Fluid, Aircraft, SAE Type I.