



TACOM

Lethality, Survivability, Mobility and Sustainment for America's Army



***Legacy System
Improvements for the
Objective Force***

JSSA Symposium

14 August 2001

**LTC Gil Brown
PM Small Arms**

Tank-automotive & **A**rmaments **COM**mand
Committed to Excellence

Report Documentation Page

Report Date 13Aug2001	Report Type N/A	Dates Covered (from... to) -
Title and Subtitle Legacy System Improvements for the Objective Force	Contract Number	
	Grant Number	
	Program Element Number	
Author(s) Brown, Gil	Project Number	
	Task Number	
	Work Unit Number	
Performing Organization Name(s) and Address(es) PM Small Arms	Performing Organization Report Number	
Sponsoring/Monitoring Agency Name(s) and Address(es) NDIA (National Defense Industrial Association) 211 Wilson Blvd, STE. 400 Arlington, VA 22201-3061	Sponsor/Monitor's Acronym(s)	
	Sponsor/Monitor's Report Number(s)	
Distribution/Availability Statement Approved for public release, distribution unlimited		
Supplementary Notes Proceedings from the 2001 Joint Services Small Arms Symposium, Exhibition & Firing Demonstration 13-16 August 2001 Sponsored by NDIA		
Abstract		
Subject Terms		
Report Classification unclassified	Classification of this page unclassified	
Classification of Abstract unclassified	Limitation of Abstract UU	
Number of Pages 33		

OUTLINE

- **TACOM Organization**
 - DSA Structure
 - Transformation Support
- **OPMSA Overview**
 - ARDEC Support for Transformation
 - OPMSA Support for Transformation
 - Small Arms Impact Across the Weapons Spectrum
 - Example: A Heavy Division
 - System Improvements in all Phases
 - Individual Weapons
 - Crew Served Weapons
 - Ammo
- **Questions?**

TACOM Organizational Structure



VISION

The U.S. Army Tank-automotive Armaments Command

- Provides Ground Combat, Automotive, Marine, and Armaments Technologies, and Systems
- Generates, Provides and Sustains, Mobility, Lethality, and Survivability for Soldiers, Other
- Services and Our Allies

MISSION

Providing our Soldiers With Overwhelming Lethality, Mobility and Survivability for Battlefield Dominance.

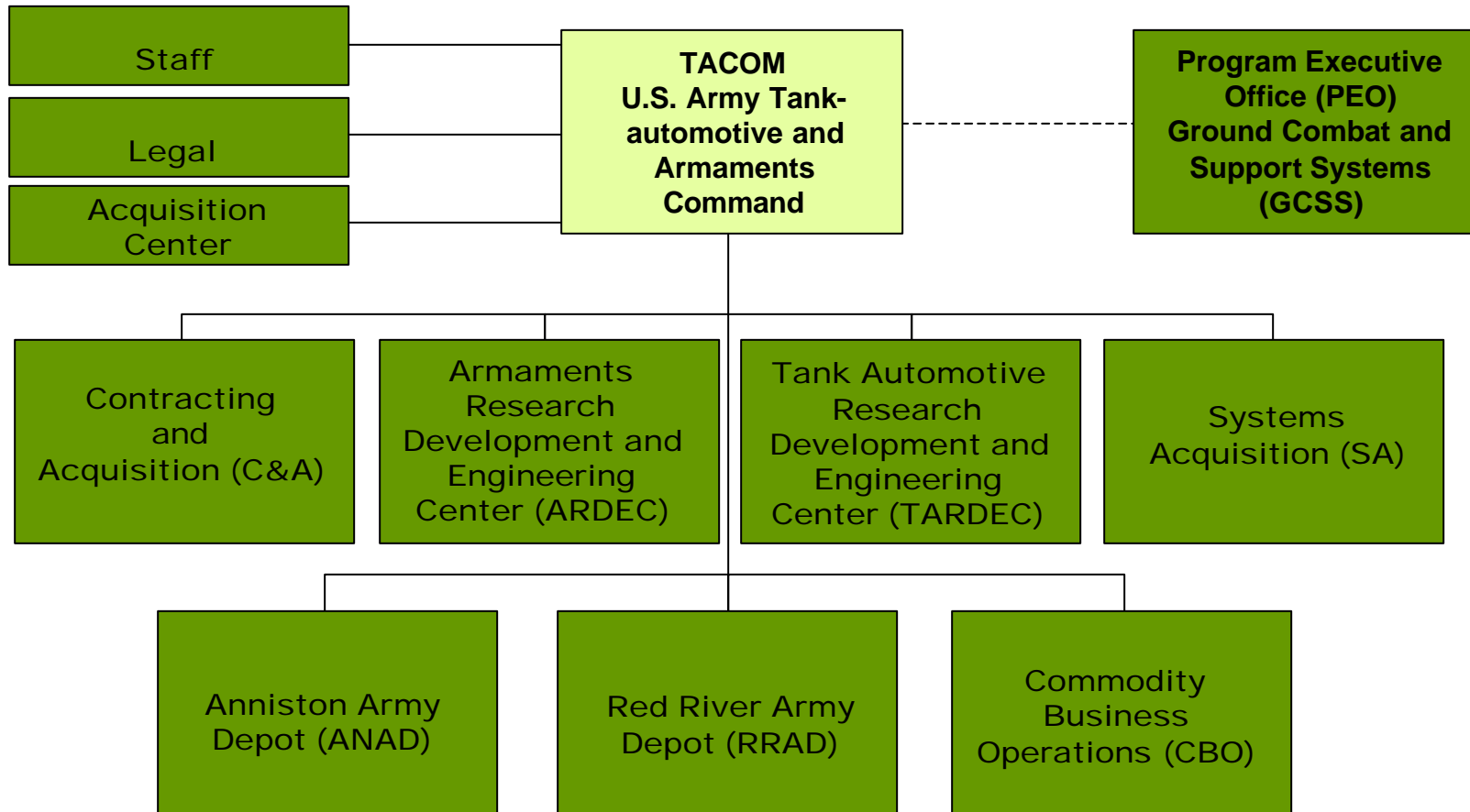

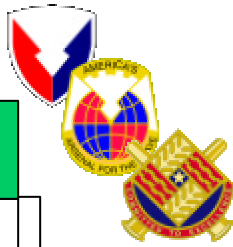

Vision

Leading Acquisition
Continuously Improving
Warfighter Focused



Mission

Develop, Acquire, Produce, Field and Sustain
Safe, Reliable, Effective and Supportable Warfighting
Systems

PM Combat Mobility Systems

COL Michael Asada

- ◆ Wolverine
- ◆ Grizzly
- ◆ M9ACE
- ◆ HERCULES
- ◆ M113 FOV
- ◆ AVLB

PM Force Projection

COL Gino Dellarocco

- ◆ Army Watercraft Systems
- ◆ Petroleum and Water Systems
- ◆ Intratheater Mobility Systems
- ◆ Construction/ Materials Handling Equipment

PM Light Armored Vehicles

Col Thomas Lytle

- ◆ LAV 25
- ◆ Anti-Tank
- ◆ Logistics
- ◆ Personnel
- ◆ Recovery
- ◆ Ambulance
- ◆ Engineer
- ◆ Air Defense
- ◆ Command & Control
- ◆ Mortar

PM Mines, Countermine and Demolitions

COL Bud Irish

- ◆ Volcano
- ◆ WAM (HORNET)
- ◆ SLAM
- ◆ PAM
- ◆ RAMS
- ◆ GSTAMIDS
- ◆ HSTAMIDS
- ◆ NSD-A
- ◆ SOF Demo Kit
- ◆ RADAM
- ◆ PVAB
- ◆ MCCM
- ◆ ESMC
- ◆ ASTAMIDS
- ◆ RATTLER
- ◆ CMCS
- ◆ APOBS
- ◆ FPE
- ◆ MDI
- ◆ Non-Lethal Capability Set
- ◆ Sympathetic Detonators

PM Paladin/FAASV

LTC Joe Stenkamp

- ◆ Paladin, Howitzer 155mm
- ◆ Field Artillery Ammunition Support Vehicle (FAASV)

PM Heavy Tactical Vehicles

Mr. Jim Sutton

- ◆ HEMTT (ESP, LHS)
- ◆ HETS
- ◆ PLS
- ◆ FRS
- ◆ Standard & Improved Ribbon Bridge
- ◆ Tactical Fire Fighting Truck
- ◆ Rapidly Emplaced Bridging System
- ◆ Multi-Role Bridge Systems (MGB, HDSB, CBT)
- ◆ Flatracks, CHU, CROP
- ◆ Engineer Mission Modules

PM Light Tactical Vehicles

Ms. Debra Davis

- ◆ Armored Security Vehicle (ASV)
- ◆ High Mobility Trailer
- ◆ High Mobility Multi-purpose Wheeled Vehicle (HMMWV)
- ◆ Up-Armored HMMWV
- ◆ Hybrid Electric HMMWV
- ◆ M939
- ◆ Light/Medium Lunette Trailers

PM Mortars

LTC Larry Hollingsworth

- ◆ 120mm Mortar Weapon System
- ◆ Fuzes
- ◆ Ammunition (120mm, 81mm, 60mm)
- ◆ Advanced Mortar Munitions
- ◆ Mortar Ballistic Computer
- ◆ Mortar Fire Control System

PM Small Arms

LTC Gil Brown

- ◆ Rifles
- ◆ Carbines
- ◆ Machine Guns
- ◆ Shotguns
- ◆ Pistols
- ◆ Grenade Launchers
- ◆ Ammunition & Grenades
- ◆ Optics & Fire Control
- ◆ Objective Individual Combat Weapon

Committed to Excellence

Office of the Product Manager Small Arms

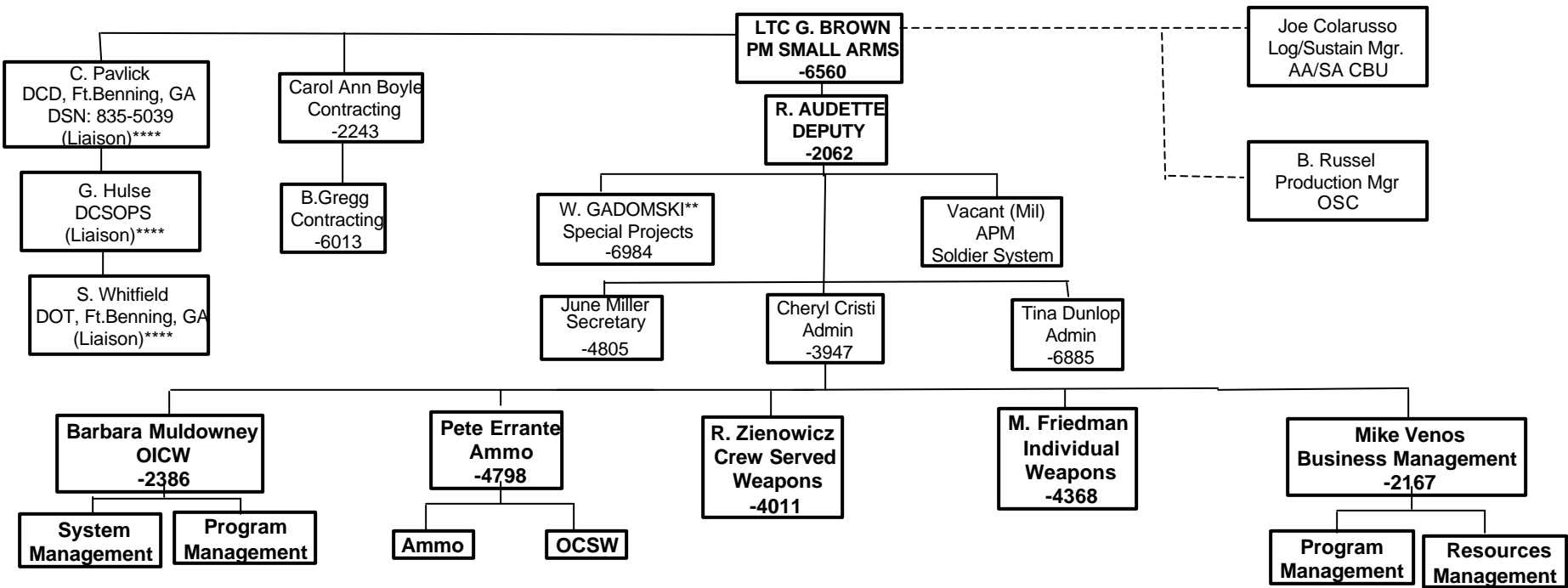

Core Personnel	22
Matrix Personnel	13
Contractor	8
Matrix Not Co-located	3
Contractor Not Co-located	3

TACOM SA Operates at the Heart of Army Transformation

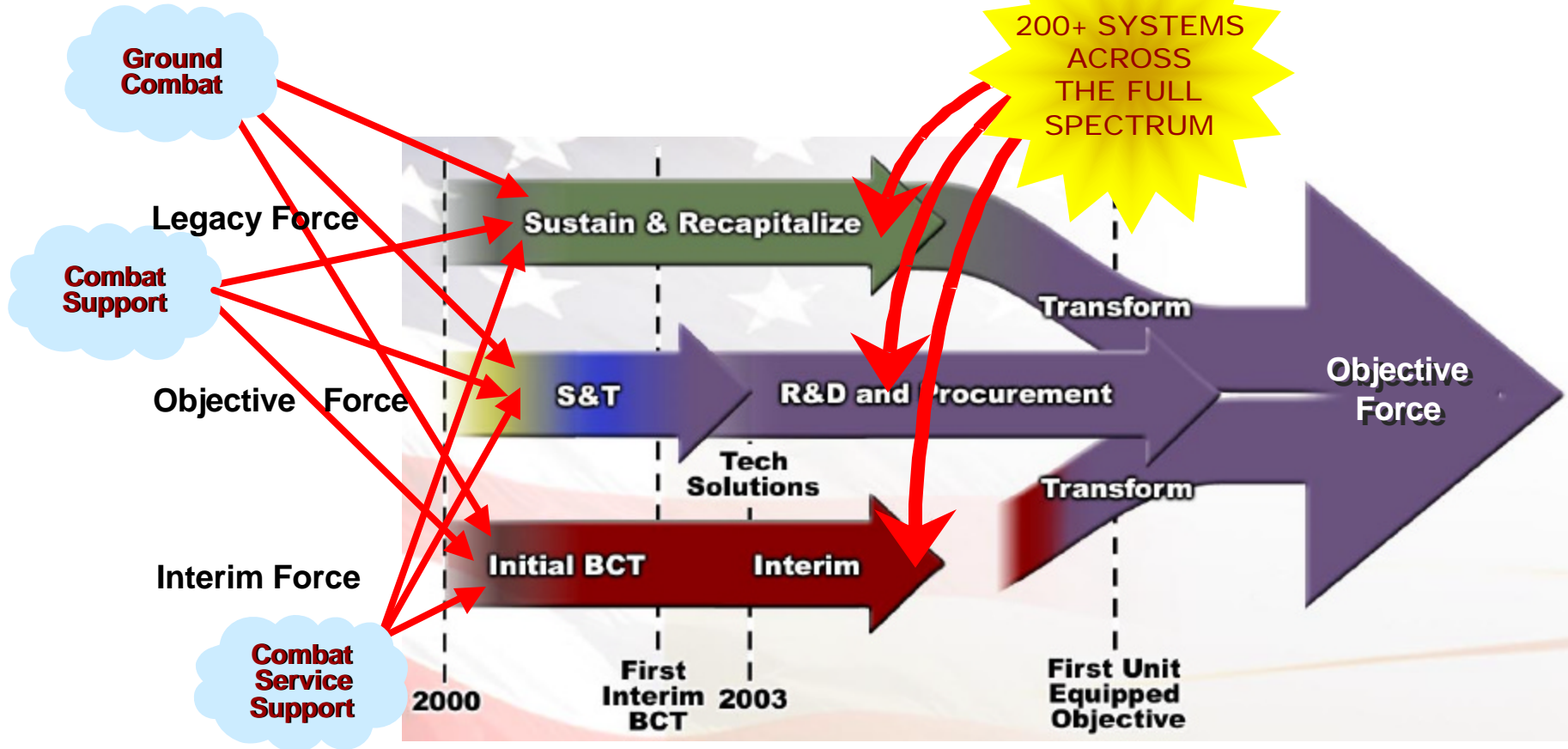

TACOM Support to Army Transformation

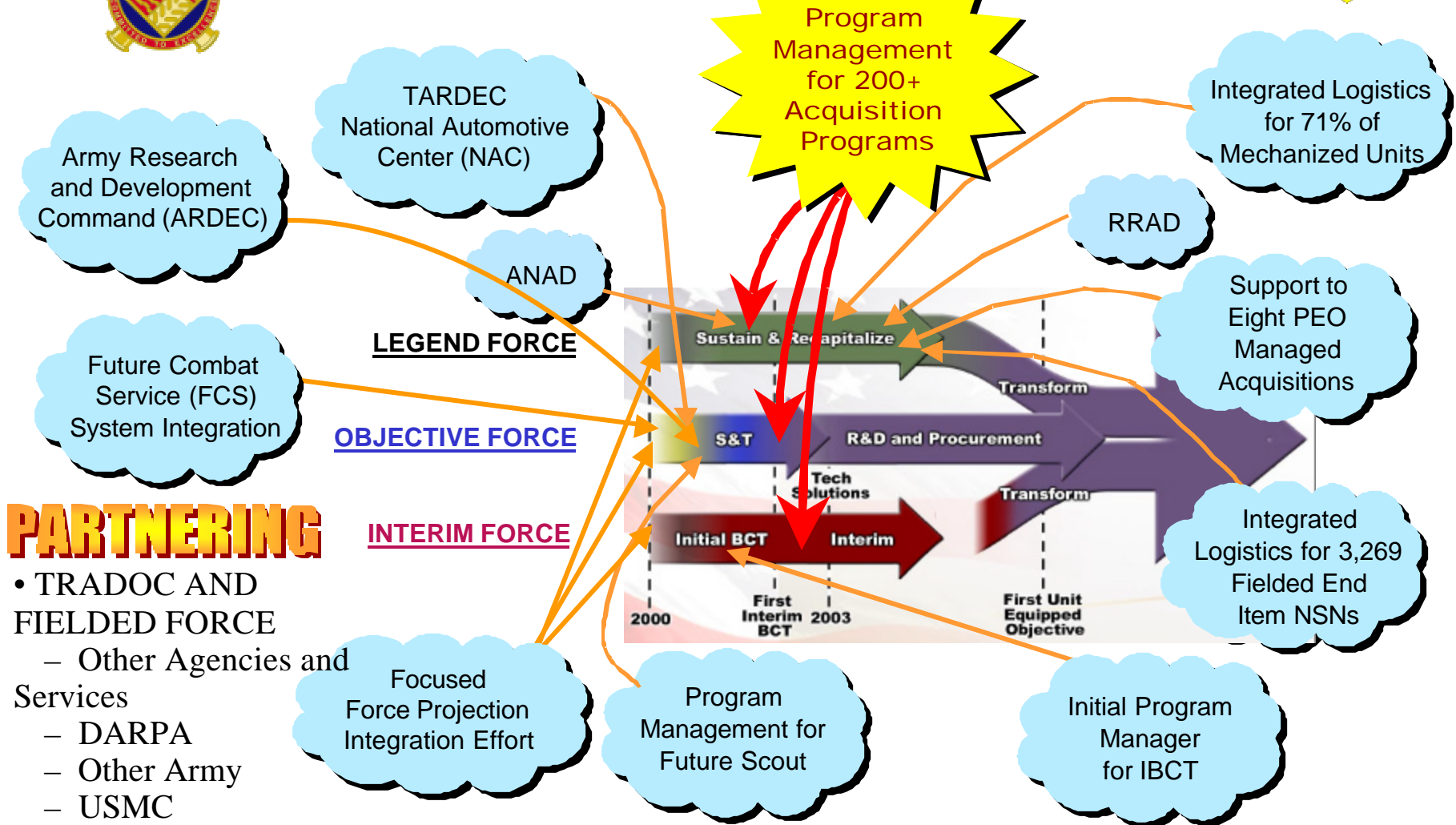

PARTNERING

- TRADOC AND FIELDLED FORCE
 - Other Agencies and Services
 - DARPA
 - Other Army
 - USMC
 - Many Others
- Industry
- Allies

The Future - We Can Quickly Adapt to Changing Military Requirements

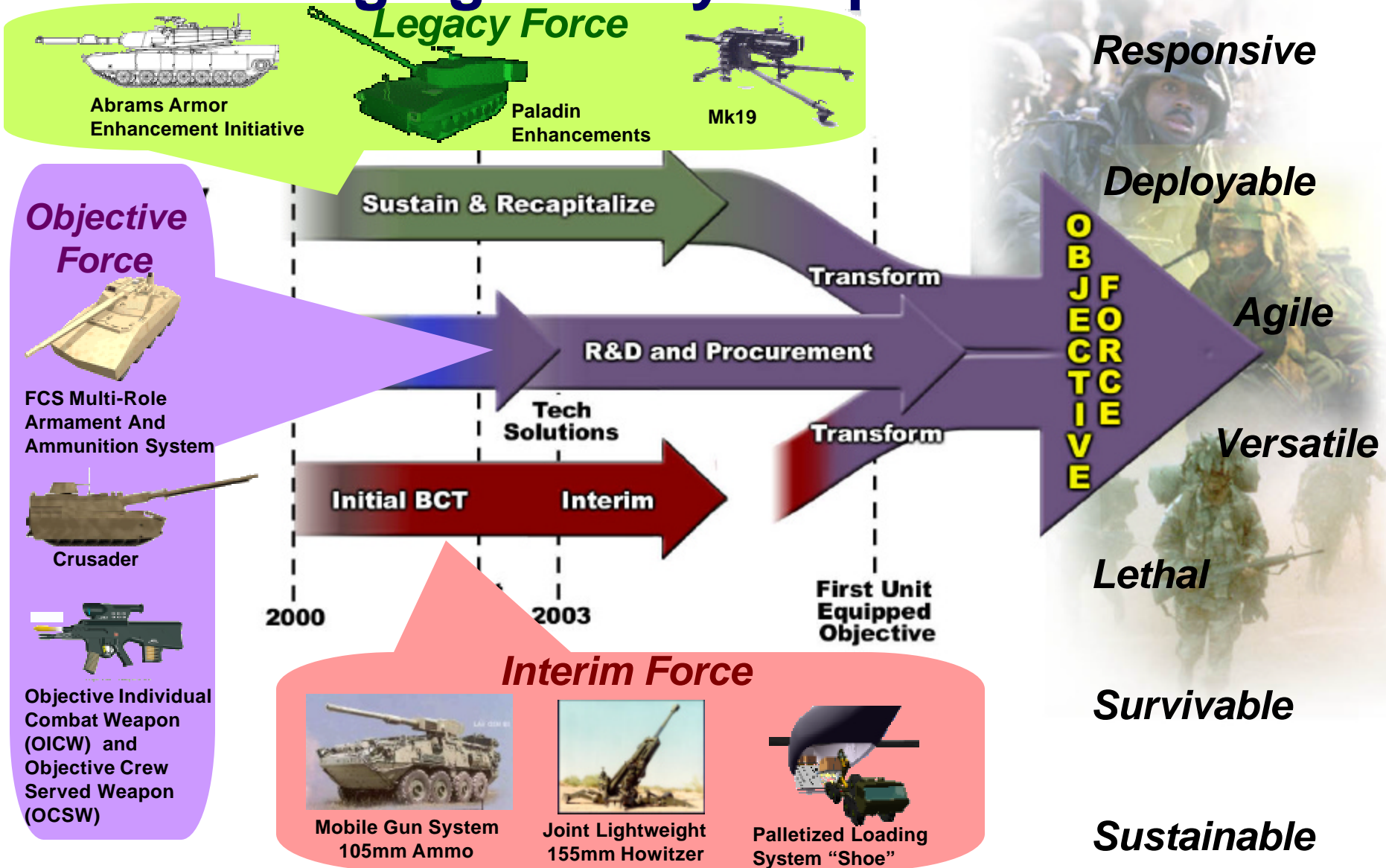

Small Arms Transformation Plan

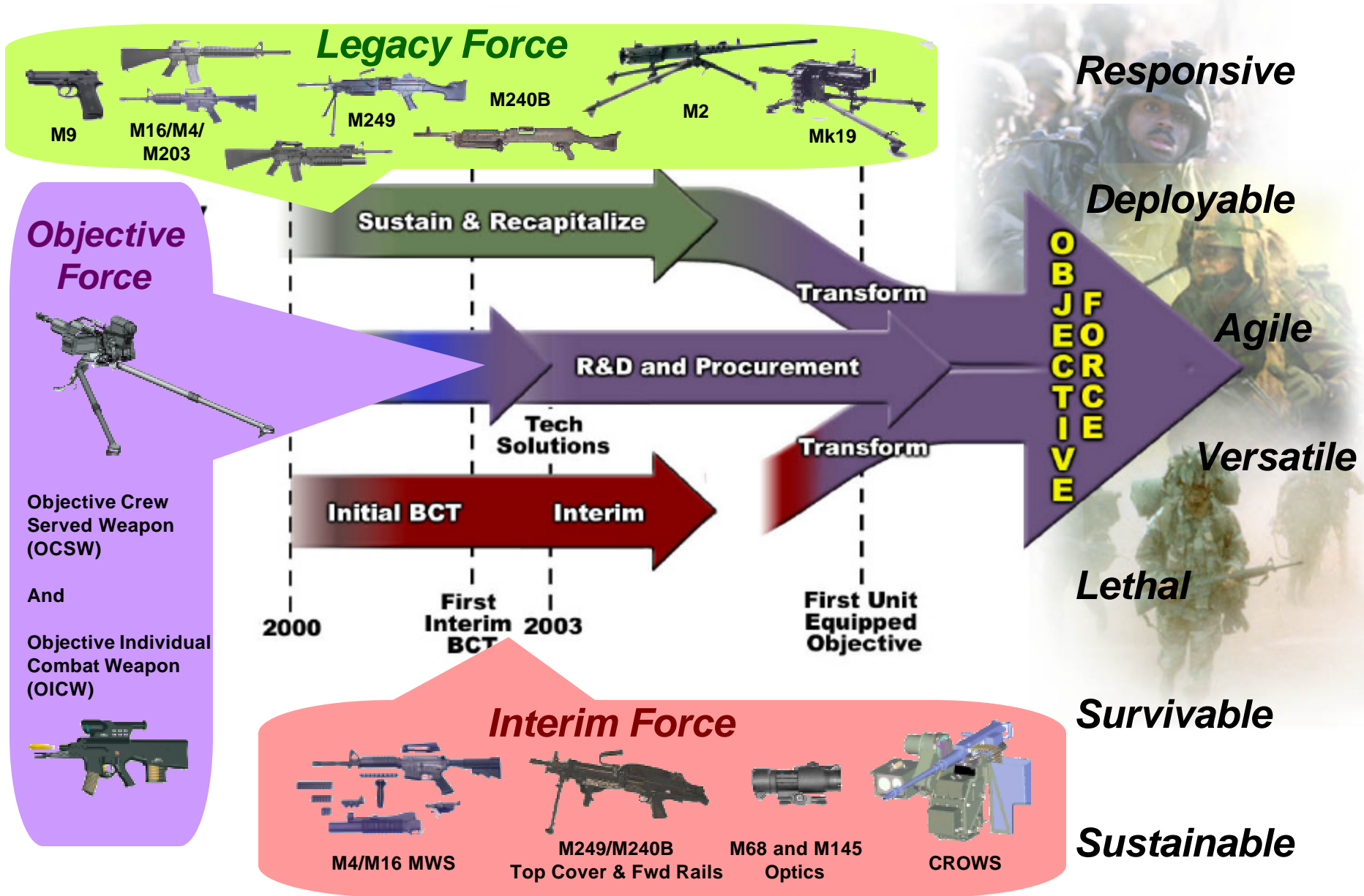

We integrate the guns, ammo and fire control for these major combat systems...



	Paladin	Abrams	Bradley	Battalion Mortar System	Soldier System	Apache Longbow
Guns	<p>M284 Cannon</p> <p>.50 Cal M2 Machine Gun</p> <p>Mk-19 MOD3 40mm Grenade Machine Gun</p>	<p>120mm M256 Smooth Bore Cannon</p> <p>M2 .50 Caliber Machine Gun</p> <p>7.62mm M240 Machine Gun</p>	<p>M242 25mm "Bushmaster" Chain Gun</p> <p>7.62 mm coaxially mounted machine gun</p> <p>TOW (AMCOM)</p> <p>JAVELIN (AMCOM)</p>	<p>M298 Cannon Assembly</p> <p>.50 Cal M2 Machine Gun</p>	<p>Mk-19 MOD3 40mm Grenade Machine Gun</p> <p>M2 .50 Caliber Machine Gun</p> <p>M16A2 5.56mm</p> <p>M4/M4A1 5.56mm Carbine</p> <p>M9 9 mm Beretta Pistol</p> <p>M249 Light Machine Gun</p> <p>M240G Med Machine Gun</p> <p>12-gauge Shotgun</p>	<p>HYDRA 70 (70mm) Rocket System (OSC)</p> <p>30mm, M230 Area Weapon System</p> <p>HELLFIRE (AMCOM)</p>
Ammo	<p>155mm M107 HE</p> <p>155mm M549A1 RAP</p> <p>155mm M795 HE</p> <p>155mm M483A1 w/ADAM,</p> <p>155mm RAAM</p> <p>155mm M864DPICM</p> <p>155mm M712 Copperhead</p> <p>155mm Prop charges- M3A1, M4A2</p> <p>*MACS</p> <p>40mm cartridges</p> <p>Cal .50 cartridges</p>	<p>M829A1 APFSDS-T "Silver Bullet"</p> <p>M830A1 HEAT</p> <p>.50 Cal Cartridges</p> <p>7.62mm Cartridges</p> <p>Armor Tiles</p>	<p>25mm M791 APDS-T</p> <p>25mm M792 HEI-T</p> <p>25mm M794</p> <p>25mm M919 APDS-T</p> <p>7.62mm Cartridges</p> <p>TOW (AMCOM)</p> <p>JAVELIN (AMCOM)</p> <p>Armor Tiles</p>	<p>M933/M934, 120mm HE Cartridge</p> <p>XM929/XM929E1 120mm Mortar Smoke (White Phosphorus)</p> <p>.50 Cal Cartridges</p>	<p>40mm Cartridges</p> <p>5.56-mm Cartridges</p> <p>7.62mm Cartridges</p> <p>9mm Cartridges</p> <p>12-Gauge Cartridges</p> <p>Hand Grenades</p>	<p>M151 HE Warhead</p> <p>M229 HE Warhead</p> <p>M255A1 Flechette</p> <p>M255E1 Flechette</p> <p>M261 HE MPMSM</p> <p>30mm ammunition</p> <p>HELLFIRE (AMCOM)</p>
Fire Control	<p>Paladin Automatic Fire Control System:</p> <ul style="list-style-type: none"> •Position/Navigation w/integrated inertial-GPS system •Digital ammo within FATDS nets •On-Board Ballistic Comp & weapon drives •Integrated Diagnostics 	<p>Thermal Imaging System</p> <p>Eyesafe Laser Range Finder</p> <p>Gunner's Primary Sight</p> <p>Army Embedded GPS Recvr</p> <p>Fire Control Electronics Unit</p> <p>Periscopes</p> <p>Muzzle Reference Sensor</p> <p>Electronic Muzzle Ref Sensor</p> <p>Impv'd Cdr's Weapon Sta Sight</p> <p>Gunner's Auxiliary Sight</p>	<p>TOW Fire Control (AMCOM)</p>	<p>M30 mortar ballistic computer</p> <p>*XM95 Mortar Fire Control System</p>	<p>M68 Close Combat Optic</p> <p>M145 Machine Gun Optic</p> <p>*CROWS (for crew served weapons)</p> <p>*M203RS/BM (for M203 Grenade Launcher for M16)</p> <p>*Small Arms Fire Control System (For Mk19)</p>	<p>Computer Resources</p> <p>Mgt spt;</p> <p>Display Processor</p> <p>Systems Processor</p> <p>Weapons Processor</p> <p>Flight Mgt Computer</p> <p>Radar Freq Interferometer</p> <p>Target Acquisition</p> <p>Designation System/Pilot</p> <p>Night Vision Sensor</p>

Providing the technology and integration for over 80% of these armament systems

Snapshot of an Army Heavy Division



54 M109 Paladins



251 M1A1 Tanks



249 M3 Bradleys



24 AH-64 Apache



14,999 Soldiers



42 120mm Mortars



3318 STONs Training Ammo/per year



3086 STONs Basic Load Ammo



13,035 M16 Rifles & M4 Carbines



2571 249/ M240/ MK19/ M2 Weapons

Count On Us For Your Lethality



OPMSA Support to Transformation



2000

2004

2012

INTERIM

- M4/M16A4 and Mod Wpn Sys
 - Light and shorter weapon
 - Adapter Rail System for devices
- M68 Close Combat Optic
 - Red Dot Sight providing enhanced situational awareness
- M240B Weight Reduction
 - Reduce M240B weight by 4 lbs
- MG Forward Rails
 - Mnt Sys for M249/M240B Devices
- Lt Wt Ground Mnt
 - M249/M240B Mnt Less Than 11 lbs
- M249 Short Barrel/ Buttstock
 - Reduced size/length
- Com Remotely Op Wpn Sys
 - Fire Under Armor w/o Turret
- IAV Program Spt
 - Primary Arm for ICV (M2/MK19)
 - Secondary Arm for MGS (M240/M2)

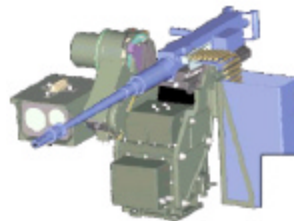

OBJECTIVE

- Obj Ind Combat Wpn (OICW)
 - Lt Wt Wpn System
 - Defeat targets in defilade
 - Increased lethality/survivability, bursting munitions
 - Integrated Fire Control System
- Obj C-S Wpn (25mm)
 - Lt Weight C/S Wpn System
 - Replace M2/MK19
 - Defeat targets in defilade, bursting munitions
 - Integrated Fire Control System

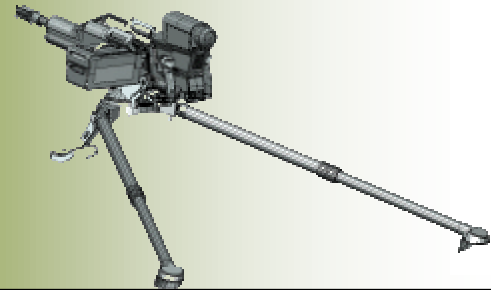

Army Procurement Objective (APO) Fill



% APO Fill

FY	98	99	00	01	02	03	04	05	06	07	08	09	10
M4 Carbine *	55	59	64	70									
M16A2/A4 Rifle	86	88	90	91	91	92	95	97	97				
M249 SAW	78	80	82	84	87	89							
M240B MMG	44	55	40	50	63	76	91	100					
Mk19-3 GMG	81	70	76	81	86	89							
M2 MG				154									



* Increase in requirements in late FY99



OPM Small Arms Programs

R&D Programs				Production Programs			
Weapons & Associated Hardware				Weapons & Associated Hardware			
✓	1.	XM107 Semi Automatic Long Range Sniper Rifle	B. Galeazzi	✓	24.	HMMWV Machinegun Mounts, M6 (M998) and M197	P. Sabia
	2.	Sniper Accessory Kit/ECP (for M24)	B. Galeazzi	✓	25.	7.62 Medium Machinegun, M240B	J. Glenn
✓	3.	CROWS Remote Mount	M. Downes	✓	26.	Modular Weapon System/M4RAS-M5RAS)	T. Miskovich
✓	4.	Joint Service Combat Shotgun/XM1014	T. Vass		27.	M203A1 MWO Kit	T. Miskovich
	5.	M240B Combat Ammo Pack (CAP) (M240B)	J. Glenn		28.	Feed Tray Cover Program/(for M249)	P. Sabia
✓	6.	Light Weight Ground Mount for MG	J. Glenn	✓	29.	Machinegun Optics Program/M145	S. Sudol
✓	7.	M249 Rails/Bipod Handguard	P. Sabia	✓	30.	Stabilized Binoculars/(M25)	A. Sapp
	8.	M249 Barrel Life Extension	P. Sabia	✓	31.	MK19 GMG	D. Ahmad
✓	9.	M240B Weight Reduction Program	J. Glenn	✓	32.	Close Combat Optics/M68	S. Sudol
✓	10.	M203 Grenade Launcher Rail System	T. Vass	✓	33.	M16A4 Rifle/M16A4	T. Miskovich
✓	11.	Enhanced M2 Cal .50 Machine Gun	D. Ahmad	✓	34.	M249 Automatic Rifle/Light Machinegun/M249	P. Sabia
✓	12.	M203 Grenade Launcher System Upgrade	T. Miskovich	✓	35.	M4 Carbine/M4	T. Miskovich
✓	13.	Collapsible buttstock for M249 Machine Gun	P. Sabia	✓	36.	Backup Iron Sights for Flat Top Receivers (for M-16/M-4)	T. Miskovich
✓	14.	M9, 9mm pistol rail system	T. Vass	✓	37.	Short Squad Automatic Weapon (ECP)	P. Sabia
✓	15.	SIGHT,COMPUTERIZED,SMALL ARMS FIRE CONTROL, XM116	S. Sudol				
		AMMO PROGRAMS		✓	38.	5.56mm Armor Piercing, M995	P. Errante
✓	16.	5.56mm Muzzle Launched Ordinance	P. Mistry	✓	39.	7.62mm Armor Piercing, M995	P. Errante
✓	17.	12 Gauge Breaching Round, XM1030	P. Errante	✓	40.	Stun Grenade/M84	James Chang
✓	18.	Long Range Tactical Sniper Cartridge/XM1022	P. Errante	✓	41.	Cal .50 SLAP/SLAPT, M903/M962	P. Errante
✓	19.	Rifle Launched Entry Munition (RLEM) (WRAP)	Alan Li	✓	42.	12 Gauge Non Lethal Point & Crowd Control	P. Errante
✓	20.	M249 Short Range Training Round	P. Errante	✓	43.	7.62 Short Range Training Ammo (FCT)/XM973/XM974)	P. Errante
✓	21.	Close Combat Mission Capability Kit	P. Errante	✓	44.	Non-Lethal 40mm Round, M1006	P. Mistry
✓	22.	M84 Reloadable Fuze	P. Errante	✓	45.	40mm Canister Round/XM1001	P. Errante
✓	23.	Hand Thrown Sting Ball Grenade	J. Chang	✓	46.	40MM, Crowd Dispersal Cartridge/(XM1029)	P. Mistry
						OBJECTIVE WEAPONS	
				✓ ✓	47.	OICW	B. Muldowney
				✓	48.	OCSW	P. Errante

✓ ACAT III Programs

✓ ✓ ACAT II Programs

OPM Small Arms

Key Initiatives for All Weapons

- **Reduce**
 - **Size**
 - **Weight**
- **Increase**
 - **Lethality**
 - **Survivability**

Objective Individual Combat Weapon

- **Advanced Technology Demonstration has Proven the Concept**
- **Clearly Identified Areas of Risk**
 - **Probability of Incapacitation $P(i)$**
 - **Weight**
 - **Fuze/Fire Control Interface**
- **ATD Provided Data on Design Shortcomings**
- **PD&RR Program Designed to Meet Challenges**
 - **SMART**
 - **Integral Training Strategy**
- **Dramatic Increases in Lethality and Survivability**
- **Strong User Support**
- **Contract Award - 4 Aug 00**
- **FUE FY09**



Conceptual Model — Lightweight and Lethal

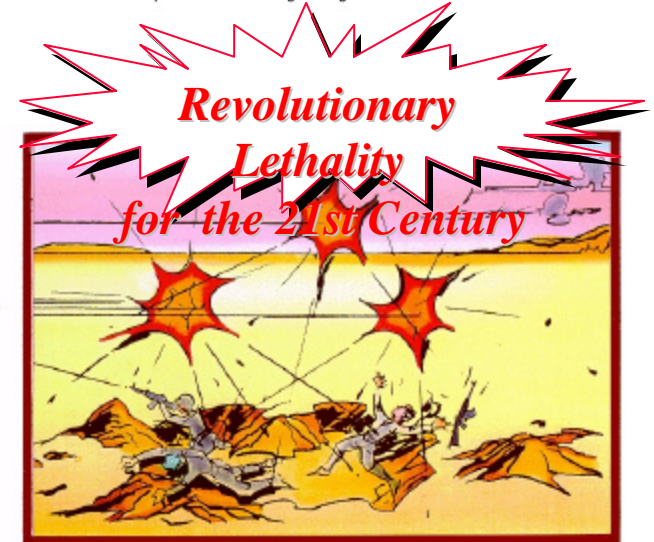

M16/M4/M203 INITIATIVES



CLOSE COMBAT MISSION
CAPABILITY KIT



IMPROVED BUTTSTOCK FOR M4



MODULAR WEAPON SYSTEM

M203 RAIL SYSTEM



M16A4

M4/M4A1

M4/M203A1



5.56 ARMOR PIERCING



CLOSE COMBAT OPTICS



BACK-UP IRON SIGHT



WEAPON FLASHLIGHT
MOUNT

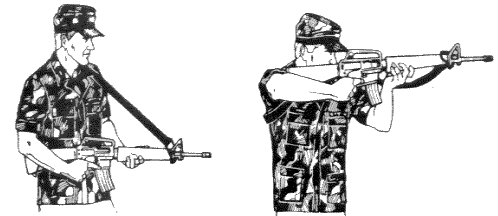

SLING, CLOSE QUARTERS BATTLE FOR M4

M9 Pistol Rail



o **CAPABILITIES OF ITEM:** Provides mounting interface to attach the Laser White Light Pointer to the M9 Pistol.

o **OBJECTIVE:** To increase the lethality and survivability of the Infantryman/MP by providing them a tactical advantage in CQB operations

o **BENEFIT:**

- Allows Infantryman/MPs to identify/designate targets prior to engaging
- Rapidly engage multiple targets
- Enhances situational awareness

M249 SAW INITIATIVES



SHORT BARREL



HMMWV MOUNT



Alternate Mounting Surfaces



COLLAPSIBLE BUTTSTOCK



MACHINEGUN OPTICS

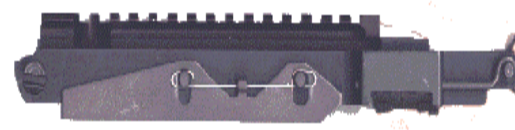

FEED TRAY COVER



CLOSE COMBAT MISSION CAPABILITY KIT



5.56 ARMOR PIERCING

**M249
Light Weight
Tripod**

M240B MACHINEGUN

INITIATIVES



Forward Accessory Mounting Surface



7.62 ARMOR PIERCING



M197 MOUNT



M240B Weight Reduction Program



Improved Buttstock



Improved Buffer



Improved BFA



M240B Improved Barrel Bag



Improved Bipod

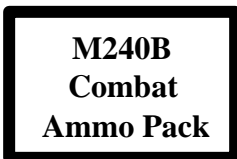

M240B Combat Ammo Pack



M240B Light Weight Tripod



MACHINEGUN OPTICS



HMMWV MOUNT XM6 Pedestal w M197 Mount

LIGHTWEIGHT M240B PROGRAM

OBJECTIVE:

- Reduce the weight of the M240B by a minimum of 4 pounds (objective 7 pounds)

STATUS:

- Contract awarded to FNMI for engineering analysis of alternatives AUG 00
- Analysis/report completed NOV 00
- Selected approach is to evaluate welded titanium receivers
- Contract awarded to FNMI to fabricate welded titanium March 01
- Hardware deliveries expected in August

LIGHT WEIGHT GROUND MOUNT XM192

OBJECTIVE:

- To provide a lightweight (<11 lbs), collapsible ground mount with integral T&E mechanism capable of mounting the M249 and M240B MG

STATUS:

- Competitive contract awarded to CAPCO in SEP 00 for development
- CAPCO/USG reps met with 29th Infantry to observe MG crew drills, identify key features req'd
- IPT includes user MG personnel
- Initial prototype concepts being evaluated

Common Remotely Operated Weapons Station(CROWS)

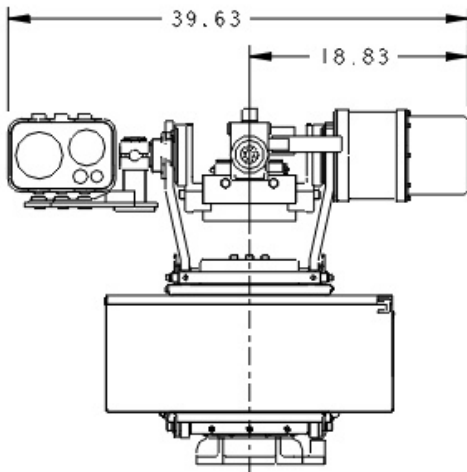

CROWS

Objective:

Provide a standard remote vehicle mounting system for machine guns (MK19 GMG, .50 Cal M2HB, M240, M249 and OCSW)

Benefits:

- **Permits under armor operation of crew served weapons for suppression of ground troops and engagement of light armor/enemy vehicles**
 - **Allows for protection against enemy fires and munition fragmentation**
 - **A standard operating system across applications**
- **System Development: Highly modular and open architecture based design for growth onto vehicle platforms**

CROWS

STATUS:

- **ORD Approved 26 Apr 99**
- **Commercial Prototype Hardware for Army and Air Force Users Demonstrated/Tested**
- **Program Restructured to Develop on the Armored Security Vehicle**
- **Joint (OPMSA/PMLTV) Acquisition Strategy Approved**
- **USAF MOA to Develop for M1116 In Process**
- **Contract Awarded 22 Dec 00**

XM 116 Sight, Computerized Small Arms Fire Control (SAFCS)



CAPABILITIES OF ITEM

- ***Provide Greater Hit Probability for the MK 19***

SAFCS

- OBJECTIVE:

- Provide MK19 Machine gunner an Enhanced Capability to Place Rounds on Target More Accurately and at Greater Effective Ranges

- BENEFIT

- Improves First Round P(h) Significantly
- Allows for Rapid, Accurate Engagements
- Requires Less Ammunition for Engagements
- Enhances Soldier Confidence and Effectiveness

- STATUS:

- IPT and TIWG Formed
- ROC Clarification Annex Approved 25 Aug 00
- Solicitation Released Nov 00
- Contract Award 4Q FY01

M84 RELOADABLE FUZE

- **Stun Grenade (170-180 dB; > 1 MIL Cdl flash) with reusable body for about 25 reuses**
- **Leverage design from the M84 Stun Grenade program**
- **Reloadable cartridge/fuze**
- **Training device for USAMPS**

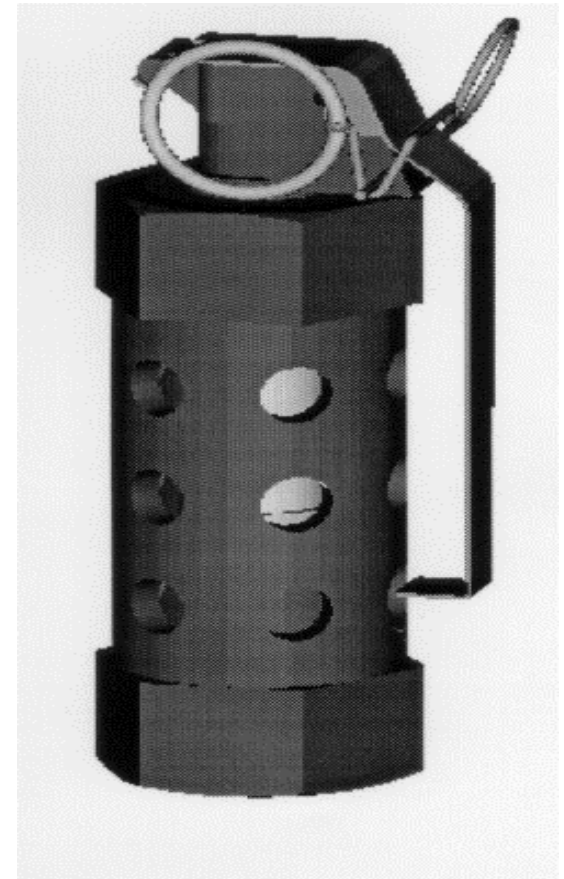

Electro Mechanical Fuze for M67 Grenade

- The Electro Mechanical (EM) fuze will achieve the following program goals
 - extend fuze storage life
 - improve reliability
 - greatly reduce the life cycle cost for maintaining the M67 fragmentation hand grenade inventory
- EM fuze will have a design that renders no impact to the existing operational procedures.
- EM Fuze will be activated via the removal of safety pins and release of the fuze lever.
- The grenade fuze will have a 4.5 ± 0.25 sec delay which is followed by a detonation of the high explosive main charge in the M67 grenade body
- This fuze technology is inherently more consistent than the pyrotechnic fuze technology currently utilized in the M67
- This fuze technology will maintain the reliability and consistency over time.

HAND THROWN STINGBALL GRENADE

- CAPABILITIES OF ITEM

Provides force protection and crowd control capability in scenarios where use of lethal force is not warranted, such as in Peacekeeping missions in SASO.

- **Hand-thrown, or 12 Gauge Shotgun-launched, using an adapter cup, with no degradation to system reliability**

OBJECTIVE: To Type Classify and field a Hand Thrown Stingball Grenade which will provide the Soldier an alternative force option to lethal force in civil unrest and crowd control situations.

STATUS:

- **FY02 SEP New Start**

- **USMC & COTS Items are not compliant with Army Fuze Safety**

Review Board requirements.

- **Human Effects- target audience data non-existent**

- **TC-Standard item is required for Army NL**

Capability Set

PROPONENT: US Army Infantry Center & US Army MANSCEN

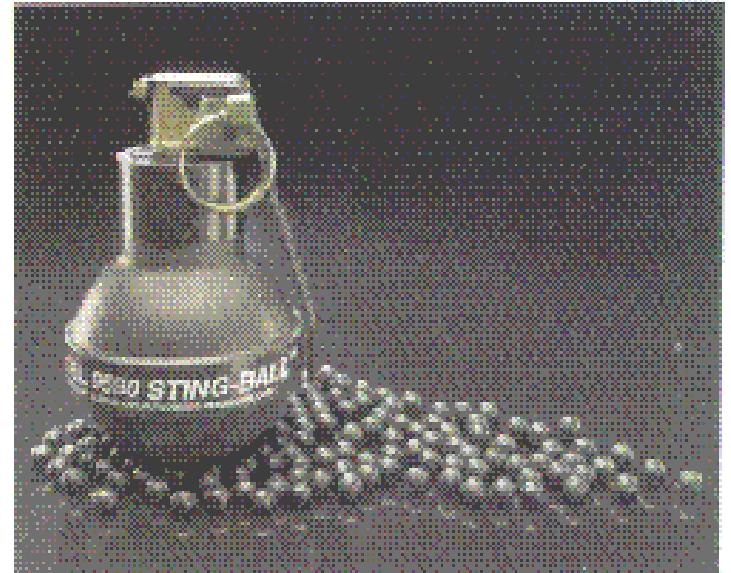

EQUIPMENT FIELDING OVERVIEW-FY00

SYSTEM	1 st QUARTER	2 nd QUARTER	3 rd QUARTER	4 th QUARTER
M4 CARBINE (11,438)				
M203A1 (1,674)				
MWS (5,375/25/754)				
M68 CCO (35,213)				
M249 (5,715)				
M249 FTC RAL (22,334)				
M6M197 MOUNT (441/1,940)				
M240B (1,296)				

EQUIPMENT FIELDING OVERVIEW-FY00

(Continued)

SYSTEM	1 st QUARTER	2 nd QUARTER	3 rd QUARTER	4 th QUARTER
M145 MG0 (3,311)				
MK93 MOUNT (1,879)				
M25 STAB BINO (294)				

"This year, FY 2000, PM Small Arms will manage fieldings to one hundred and thirty nine high priority Army Order of Precedence units, numerous separate unit fieldings; from company to division level, in every major command in the Army, Worldwide."



OPM Small Arms

Questions?

[http://w4.pica.army.mil/opmsa/
gbrown@pica.army.mil](http://w4.pica.army.mil/opmsa/gbrown@pica.army.mil)