

REPORT DOCUMENTATION PAGE

AFRL-SR-BL-TR-01-

0483

Public reporting burden for this collection of information is estimated to average 1 hour per response, including the time for reviewing instructions, gathering existing data needed, and completing and reviewing this collection of information. Send comments regarding this burden estimate or any other aspect of this collection of information, including suggestions for reducing this burden to Washington Headquarters Services, Directorate for Information Operations and Reports (0704-0188), 4302. Respondents should be aware that notwithstanding any other provision of law, no person shall be subject to any penalty for failing to comply with a collection of information if it does not display a currently valid OMB control number. PLEASE DO NOT RETURN YOUR FORM TO THE ABOVE ADDRESS.

1. REPORT DATE (DD-MM-YYYY) 03-07-2001		2. REPORT TYPE Final Technical Report		3. DATES COVERED (From - To) 15 Dec 2000 - 14 Jun 2001	
4. TITLE AND SUBTITLE TERAHERTZ DEVICES: TUNABLE AND MODE-LOCKED p-Ge THz LASER (AF00T017 STTR PHASE I)				5a. CONTRACT NUMBER F49620-01-C-0012	
				5b. GRANT NUMBER	
				5c. PROGRAM ELEMENT NUMBER	
6. AUTHOR(S) CHRIS FREDRICKSEN, PRINCIPAL INVESTIGATOR				5d. PROJECT NUMBER	
				5e. TASK NUMBER	
				5f. WORK UNIT NUMBER	
7. PERFORMING ORGANIZATION NAME(S) AND ADDRESS(ES) ZAUBERTEK, INC. 12565 RESEARCH PARKWAY SUITE 300 ORLANDO, FL 32826				8. PERFORMING ORGANIZATION REPORT NUMBER CLIN 0001AF	
9. SPONSORING / MONITORING AGENCY NAME(S) AND ADDRESS(ES) AFOSR/NE 801 N. RANDOLPH ST., ROOM 732 ARLINGTON, VA 22201-1977				10. SPONSOR/MONITOR'S ACRONYM(S)	
				11. SPONSOR/MONITOR'S REPORT NUMBER(S)	

12. DISTRIBUTION / AVAILABILITY STATEMENT
APPROVED FOR PUBLIC RELEASE; DISTRIBUTION UNLIMITED.

AIR FORCE OFFICE OF SCIENTIFIC RESEARCH (AFOSR)
NOTICE OF TRANSMITTAL DTIC. THIS TECHNICAL REPORT
HAS BEEN REVIEWED AND IS APPROVED FOR PUBLIC RELEASE
LAW AFR 100-12. DISTRIBUTION IS UNLIMITED.

13. SUPPLEMENTARY NOTES

20011003 068

14. ABSTRACT
Report developed under STTR contract for topic AF00T017 Terahertz Devices. Practical innovations for the far-infrared p-Ge laser were developed to enable commercial applications. New electrodynamic p-Ge laser designs were demonstrated, including an open semiconfocal cavity, dielectric SrTiO3 laser mirrors, and an electrically-controlled intra-cavity wavelength selector, which remarkably improve characteristics and reliability. These cavity designs also allow non-contact optical modulation of the laser gain by external near-infrared radiation, which may potentially replace high-power electrical modulation for generating picosecond far-infrared laser pulses. A new low-cost technique was developed to make uniform ohmic contacts for high-voltage excitation of the active crystal. Novel solid-state excitation electronics were tested as replacement for traditional vacuum-tube pulsers. A NdFeB permanent magnet assembly proved capable of providing the field necessary for laser oscillation. This test led to a next-generation SmCo magnet-assembly concept for replacing the traditional superconducting solenoid. A closed cycle refrigerator was shown to be an adequate replacement of liquid helium for cooling the laser crystal. Hence, a low-cost, all-solid-state, compact, turn-key, far-infrared laser featuring 1-4 THz tunability, watt peak powers, and pico-second pulse capability has been shown to be technically feasible. This laser will have applications in airborne and satellite communications, chemical sensing, and non-destructive testing.

15. SUBJECT TERMS
STTR REPORT, FAR-INFRA-RED, TERAHERTZ, LASER, SUB-MILLIMETER, COMMUNICATIONS, SENSING, p-Ge.

16. SECURITY CLASSIFICATION OF:			17. LIMITATION OF ABSTRACT UNLIMITED	18. NUMBER OF PAGES 12	19a. NAME OF RESPONSIBLE PERSON Chris Fredricksen	
a. REPORT UNCLASSIFIED	b. ABSTRACT UNCLASSIFIED	c. THIS PAGE UNCLASSIFIED			19b. TELEPHONE NUMBER (include area code) (407) 230-5704	

PROJECT OBJECTIVES

Phase I objectives were to test the feasibility of a far-infrared p-Ge laser which uses a closed cycle refrigerator, permanent magnets, a solid-state pulser, and a stable cavity with piezo controlled tuning element and cavity length. In general, the study would determine if an academic curiosity could be transformed into a practical commercial device. Impractical features at the beginning of the study included:

- Superconducting magnet (bulky, requires liquid helium and a current supply, expensive)
- Liquid helium cooling (high operating costs, bulky cryostats, deployment limitations)
- Copper mirrors (custom; easily damaged and tarnished, high-voltage breakdown risk)
- Fabry-Perot resonator fixed to crystal (excessive alignment and crystal tolerances, fixed length)
- Manually adjusted wavelength selector (imprecise, coarse control)
- Evaporated/implanted high-voltage contacts (complex and expensive)
- Thyatron pulser (custom, bulky)
- Mode-locking with electrical gain modulation (extra contacts on crystal and high power rf needed)

WORK CARRIED OUT

Phase I tested the following:

- | | |
|------------------------------------|---|
| ▪ Permanent magnet assembly | (as an alternative to superconducting magnets) |
| ▪ Closed cycle refrigerator | (as an alternative to liquid helium) |
| ▪ SrTiO ₃ mirrors | (as an alternative to copper mirrors) |
| ▪ External semi-confocal resonator | (as an alternative to fixed Fabry-Perot resonator) |
| ▪ Piezo-controlled selector | (as an alternative to manually adjusted selector) |
| ▪ GaIn-alloy solder contacts | (as an alternative to evaporated or implanted contacts) |
| ▪ MOSFET or IGBT pulser | (as an alternative to thyatron tubes) |
| ▪ Optical modulation of laser gain | (as an alternative to electrical modulation) |

RESULTS OBTAINED

Permanent Magnet Assembly

Figure 1 presents a photo, schematic, and test results for a p-Ge laser with NdFeB/Fe permanent magnet assembly. The main positive result over the 1996 UCF demonstration^[1] was the increase in the magnetic field from 0.35 T to 0.75 T. At low fields, the p-Ge laser emits narrow lines related to discrete shallow impurity transitions. At high fields, the p-Ge laser has a very broad gain spectrum that can be exploited for continuous tuning or short-pulse applications.

Laser operation using the magnet design shown in Figure 1 was successfully demonstrated in a liquid helium storage dewar, although these experiments revealed a set of disadvantages for that design. Crystal position was critical because of the narrow region of uniform field. The field-uniformity of NdFeB magnets was found to degrade with thermal cycling, so that iron poles were needed to ensure sufficient homogeneity. The poles lowered the magnetic field to around 0.5-0.6 T, near the border between low- and high-field laser generation zones, where laser operation is unstable. Both NdFeB and iron rust. We concluded that the Figure 1 design, conceived at the beginning of Phase I, must be modified.

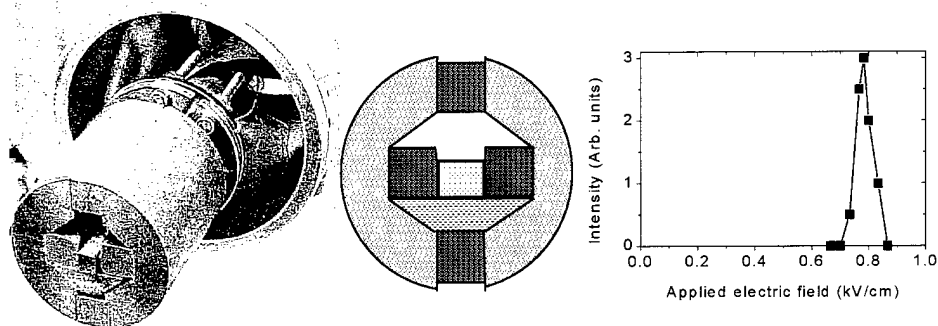

Figure 1. (Left) Photograph of permanent magnets, soft-iron yoke, copper cold finger and p-Ge crystal attached to a 10 K 0.5 W closed cycle refrigerator. (Middle) Schematic of permanent magnets (dark squares), laser crystal (light square), Fe yoke (parentheses) and Cu cold finger (trapezoid). The diameter of the magnet-yoke system is 1.5 inch. (Right) Demonstration of laser action, using permanent magnet assembly in liquid helium.

With help from Magnet Sales, Inc., a modification of the Figure 1 assembly was designed. Figure 2 compares the finite element analysis for new and old designs. Calculations were verified by measurement with a Hall probe for the old design, so we are confident in the predictions for the new one. The new design uses SmCo magnets and magnetic stainless steel yoke to reduce corrosion. SmCo is much more stable under thermal cycling than NdFeB. The new design gives 0.8 T without poles. The region of uniform field is much larger so that crystal placement is less critical.



Figure 2. (Left): Zaubertek permanent magnet assembly, using NdFeB magnets and iron. (Right) Proposed permanent assembly, using SmCo and stainless steel (proprietary, Magnet Sales, Inc.) The diameter of each magnet is 38 mm.

Closed Cycle Refrigerator

We developed a workable thermal interface between the cooler’s cold plate and the p-Ge laser crystal. In this design, the crystal is soldered with InGa alloy directly to the flat polished surface of a copper cold finger, which serves as both thermal and electrical contact. The design accommodates the permanent magnet assembly (Figure 1). Stable crystal temperatures below 15 K were demonstrated when pulses up to 800V x 50A x 1 μs x 5 Hz were applied to the laser crystal, which corresponds to 0.2 W average dissipated power.

The temperature is monitored by the crystal resistance, which changes rapidly with temperature below 15 K because of carrier freeze-out, a sufficient condition for reaching laser-emission temperatures. The

experiment shows that the cold finger and 0.5W 10K cooler act effectively to remove the dissipated heat. We also note that the magnet assembly works effectively as a radiation shield, allowing lower temperatures to be reached. We consider that the laser operation in closed cycle refrigerator is achievable with the new SmCo magnet assembly (Figure 2).

SrTiO₃ Mirrors

The traditional laser cavity design of p-Ge lasers used metal flat polished mirrors applied to the polished ends of the laser rod through electrically-insulating transparent spacers, such as teflon film or silicon. Such spacers are required to prevent the metal mirrors from shorting the high-voltage pulse, which might destroy both crystal and mirror. Spacers introduce numerous unwanted effects, including reflection, scattering and absorption losses, uncontrolled wavelength selection, and additional complexity.

We demonstrated two relevant p-Ge laser cavity design improvements. One was a semi-confocal external cavity (see below), where the cavity mirror has no direct contact with the laser rod. The other was replacement of metal mirrors by dielectric mirrors made from flat, polished, mono-crystalline, SrTiO₃ plates.

SrTiO₃ works as a laser mirror because of its high reflectivity reststrahlen band in the far-infrared. As an insulator, it may be applied directly to the active crystal rod without breakdown risk. Commercial off-the-shelf single-side polished SrTiO₃ substrate was used "as is". The laser generation zone in E,B space was very broad, and the achievable repetition rate was high (70 Hz). All these observations indicate that SrTiO₃ makes very low loss mirrors.

SrTiO₃ mirrors are a very important practical advance for p-Ge lasers. Traditional Cu mirrors are a great risk. The plane Cu mirrors used up to now are not commercially available, are easily damaged, rapidly tarnish, are difficult to polish, and require the insulating spacers already mentioned. In contrast, polished SrTiO₃ substrates are a common commercial item, are hard, do not oxidize, are easy to re-polish, and are electrical insulators.

Another feature of SrTiO₃ is its transparency above about 1500 cm⁻¹. This creates the possibility of modulating the laser gain at one end of the active crystal using near-IR radiation, as will be shown below.

In the future, we are planning to investigate the possibility of electrochemical deposition or sputtering of SrTiO₃ directly on the end faces of the active p-Ge crystal, considerably simplifying the laser cavity construction.

External Semi-Confocal Resonator

Traditionally, flat cavity mirrors were always applied directly to p-Ge active crystal ends, forming a Fabry-Perot resonator. The parallelness of the polished crystal surfaces provided the parallelness of the cavity mirrors, and was hence a critical parameter and a challenging manufacturing problem. In Phase I we demonstrated for the first time p-Ge laser operation in an external cavity, where one of plane mirrors was replaced by a spherical gold mirror placed about 3 cm away from the end of the active crystal. Such a design eliminates the need for isolating spacers or films and provides well-known stability of a semi-confocal cavity. This laser was operating even though the intracavity space of 3 cm was filled with boiling liquid helium.

Figure 3 shows the hardware constructed especially for the external semi-confocal cavity test. The assembled device is shown schematically in Figure 4. The system worked on the first try without mirror adjustment. The lasing zone is plotted in Figure 4 (together with a zone for a usual plane-mirror cavity using SrTiO₃ mirrors).

By showing that mirrors need not contact the crystal, this experiment shows that mirrors can be external to the cryostat, in principle. This would greatly simplify the implementation of adjustable and tunable cavities. It is clear that a variable cavity length with piezo-control is now possible, in principle. Such a variable cavity length is a necessary condition for eliminating mode hops, which is desirable for high-resolution tunable-laser spectroscopy.

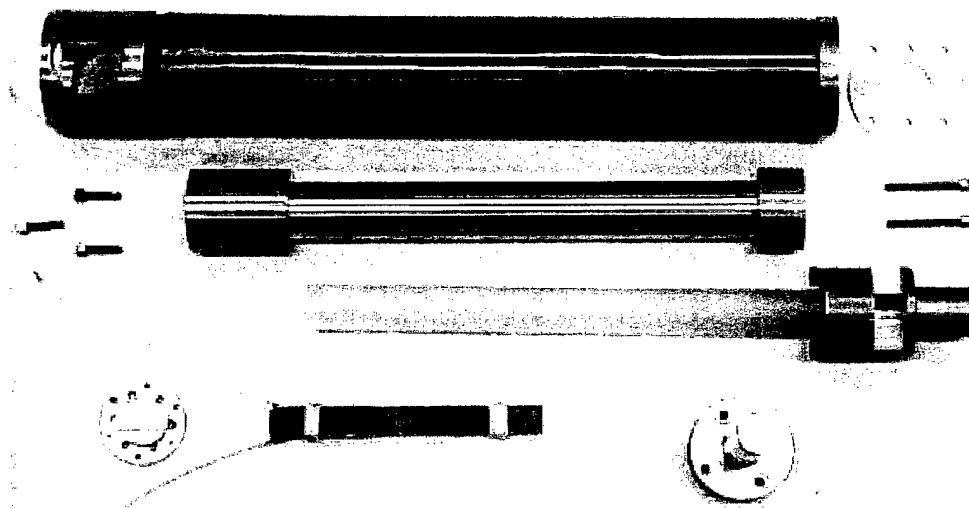

Figure 3. External cavity hardware. The p-Ge laser crystal is held against the mirror surface of the piezo-controlled Fabry-Perot wavelength selector (lower right). The crystal and selector are inserted into a plastic tube and secured with brass screws. The combination is inserted into a brass tube. A spherical gold-coated mirror sits on a piezo stack on a brass flange, which is attached to the left end of the brass tube. This combination finally is inserted into the superconducting magnet, which has 12 layers of Nb-Ti copper clad wire wound on a brass spool with 19 mm inner diameter. A current of 15-25 A is required to obtain the necessary magnetic fields.

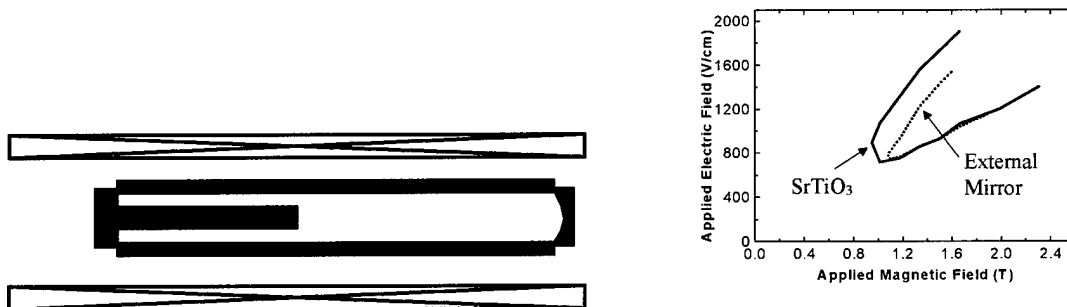

Figure 4 (Left). Schematic of external cavity p-Ge laser, without tuning elements. (Right) Laser generation regions for external cavity and also for traditional cavity with SrTiO₃ mirrors.

Piezo-Controlled Selector

Piezo-electric control of a tuning element (Figure 5) was demonstrated for the first time in p-Ge laser^[2,3]. The tuning system worked properly and tunable wavelength selection was obtained (Figure 5, right). The very fine tuning made possible by piezo control allowed us to observe unwanted features in the tuner design. First, the silicon spacer, which is part of the selector used (Figure 5, left), causes additional resonances, which are characterized by the suppression of certain modes and unexpectedly large mode hops^[3]. Also, the long piston, which ensures parallel translation of the mirror in the Fabry-Perot selector, has a tendency to stick at liquid helium temperatures. These results emphasize the importance of moving the selector outside the cryostat, where electrical isolation by an optical spacer is not required and thermo-mechanical problems are absent.

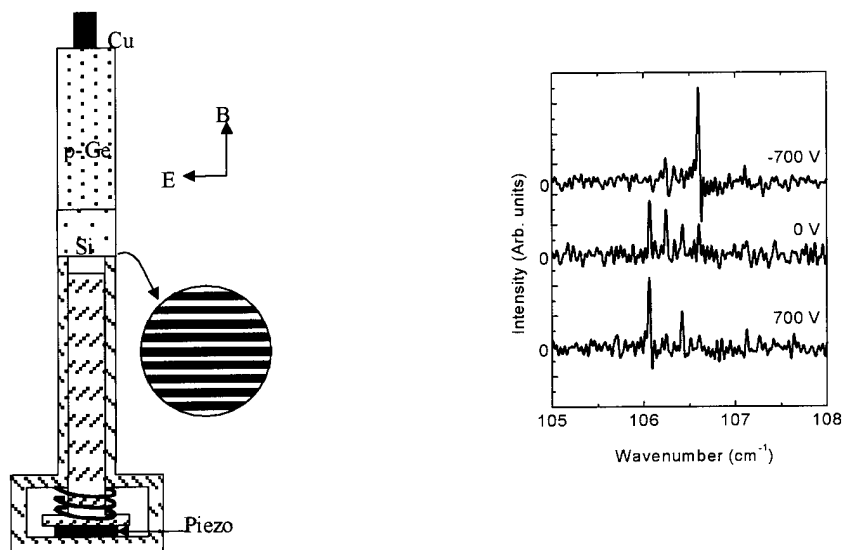

Figure 5. (left) Schematic of p-Ge laser with piezo-controlled tuning element. (Right) Emission spectra of p-Ge laser with different bias applied to piezo element.

Galn-Alloy Solder Contacts

Active p-Ge laser crystals require currents of about 100 A/cm², and the gain is very sensitive to uniformity of the current distribution over the crystal. This requires high power uniform ohmic contacts made over the entire lateral faces of the crystal (~1 cm²). Even small weak spots can cause electrical breakdown, which is evidenced by visible sparking, rapid degradation of the contacts, and consequently to non-uniform current distribution, which prevents laser operation.

These features put high requirements on the quality of the contacts and the method of their preparation. The best contacts are made by ion implantation, which makes a uniform p⁺ layer over the entire surface. Another proven method developed by Russian scientists in early 1980's is aluminum evaporation at crystal temperatures ~400 C. Both procedures need rather substantial capital equipment and expertise, and this has hindered the proliferation of p-Ge laser development and application efforts.

A new low-cost, low-tech, reliable contact procedure was developed during this Phase I. Gallium-indium alloy is applied to the slightly warm (~50 C) crystal surface, which has been freshly ground by 30 μm abrasive powder. The molten alloy wets the surface perfectly. Afterward, pure indium is applied with a

soldering iron to make a mechanically strong connection for the HV leads. These contacts are perfectly ohmic and survive prolonged HV excitation. The experimental tests suggest that the operation of lasers with these new contacts is better than lasers with evaporated aluminum contacts.

MOSFET and IGBT Pulsers

Two experimental solid-state pulsers were built and tested. The main difference between them was the fast high-power switch. A photograph of the MOSFET pulser is shown in Figure 6 with an oscilloscope trace for a 300V x 90A pulse into a carbon mass resistor. The 55 ns rise time is better than the 100 ns rise of the UCF thyatron switch and the 200 ns of the 1996 UCF IGBT switch¹¹. The 40 ns fall time is promising for potential Cavity Ring-down Spectroscopy. The ringing can be eliminated by standard clamps.

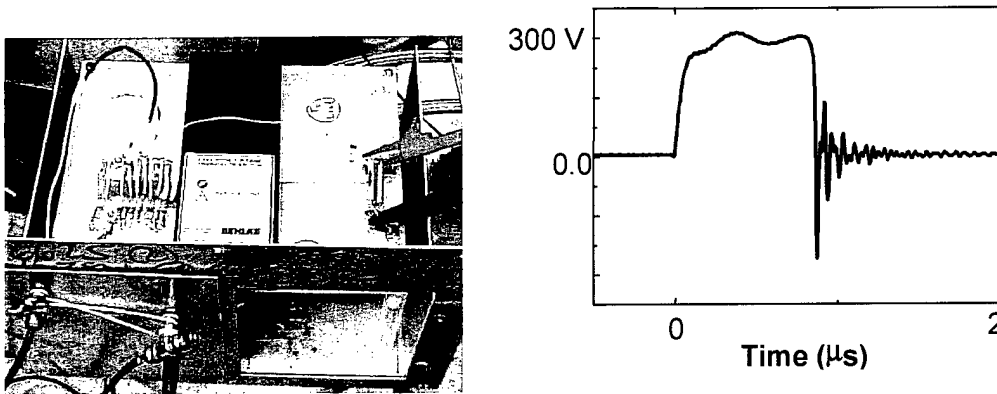

Figure 6. Photograph of the MOSFET pulser. Pulse shape for a resistive load.

A prototype IGBT (insulated gate bipolar transistor) pulser (Figure 7) was constructed and tested. Recorded driver waveforms and voltage pulse are presented in Figure 8. The 50 ns rise is the same as for the MOSFET. The decay of the pulse after the initial fast rise is a demonstration of the over-current protection capability of the drivers. This decay is premature and results from poor driver design.

Driver 2 is delayed relative to driver 1 by a few tenths of a microsecond, causing both IGBTs to be on during that time. The resulting short circuit triggers the over-current protection to shut off IGBT1. The delay proved to be caused by a fundamental difference in the EXB841 for switching high vs. switching low. The fix will consist of separate trigger pulses provided by a custom trigger module, which is proposed for Phase II. This will allow IGBT2 to be switched on only briefly at the end of the pulse to perform its sole function of discharging the transmission line.

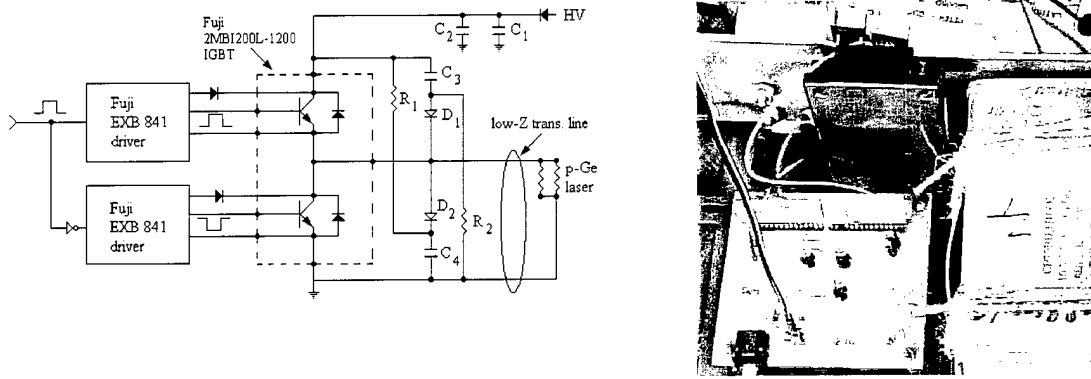

Figure 7. (Left): IGBT circuit. The upper driver/IGBT are “1” in the text. Diodes from driver to IGBT collector are for sensing over-current. (Right): Photograph of the IGBT pulser hardware. The driver board (left foreground) is powered via the modular connector. The trigger pulse (black-and-white pair) is buffered by two of the small-signal transistors. The third is a transistor inverter. The flat packages are EXB841 drivers. The blue wires leading to the dual IGBT (upper center) are for over-current sensing. One capacitor and diode of the snubber are visible, along with the fast discharge polypropylene capacitor C2, on the far side of the IGBT board. The traces on the board are low-inductance strip lines. The large storage capacitor C1 is on the right.

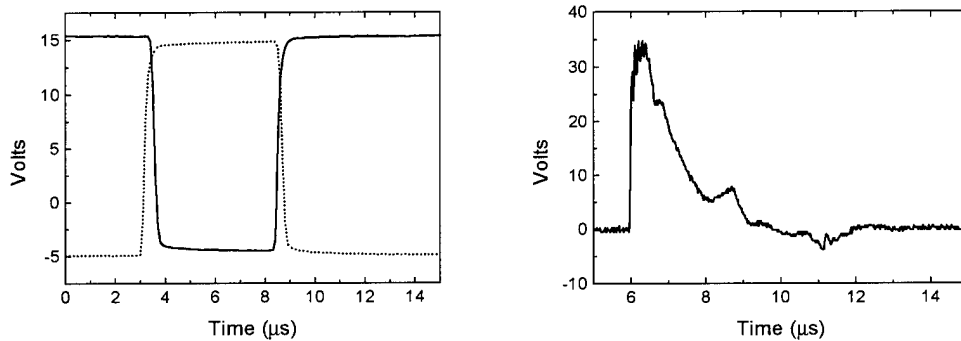

Figure 8. (left) IGBT Driver pulses. Driver 1(2) is normally low (high). (Right): Pulse shape from IGBT1 applied to a 10 ohm load. A 3 μs square pulse was expected. The few microseconds decay is characteristic of the over-current protection feature in the EXB-841 IGBT driver module.

Optical Modulation of Laser Gain

The Phase I work plan called for a test of the maximum modulation rate for pulse-position-modulated harmonically mode-locked laser using the UCF scheme of electrical gain modulation via additional ohmic contacts^[4,5]. Instead, due to our success with SrTiO₃ mirrors, we opted to explore a non-contact optical-modulation scheme for short pulse generation. This is made possible by transparency of SrTiO₃ mirrors for wavelengths shorter than 7 μm. Figure 9 shows the experimental set-up. A fiber bundle and glass tube conducted light from a variety of sources to the end face of the p-Ge active laser crystal.

A variety of sources were used, including Xe arc lamp with high and low pass filters, fundamental- or doubled-, Q-switched- or long-pulse-, Nd:YAG, and a laser diode, as in Figure 9 (right). Modulation of the laser gain was observed as a quenching of the laser emission. The effect was strongest for wavelengths nearer the band gap of germanium (Figs. 9,10).

The Q-switched YAG laser with 8 ns pulse duration allowed us to determine that the effect was strongest when the radiation was incident on the crystal at the beginning of the p-Ge laser electrical excitation, when the population inversion is building up. The timing of the YAG relative to the p-Ge laser excitation and emission pulses was monitored with a fast Si avalanche diode.

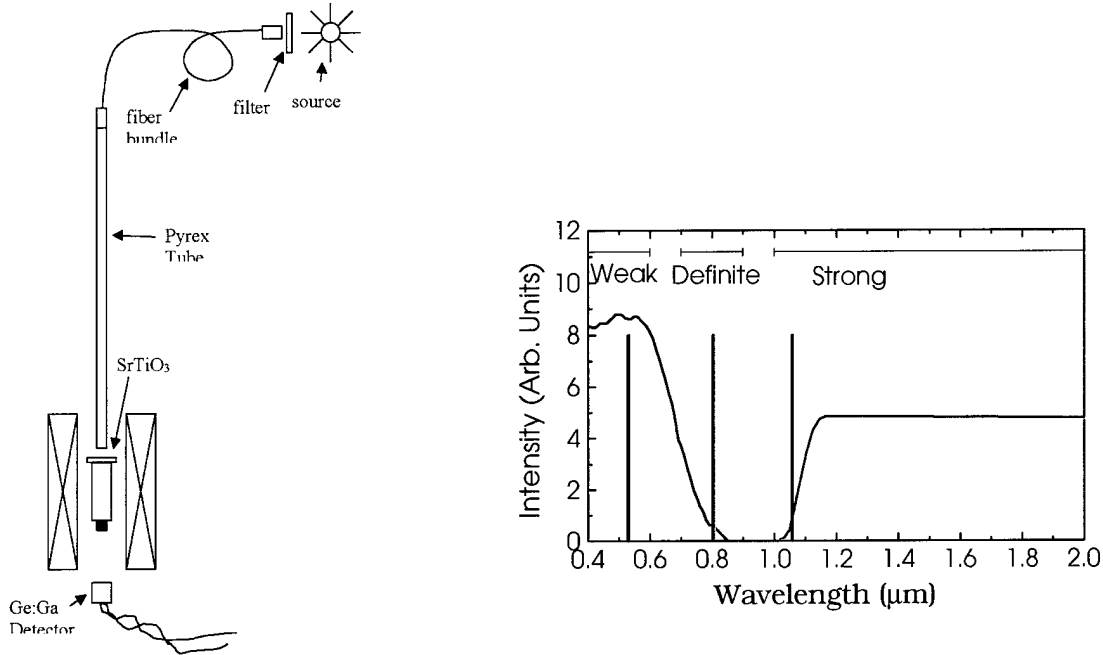

Figure 9 (Left) Schematic of experimental set-up for optical modulation of far-infrared laser gain. Light from a variety of laser or filtered-broadband sources is conducted to the SrTiO₃ laser mirror via a fiber bundle and glass tube. Laser signal is detected with a 4 K Ge:Ga photoconductor. (Right) Schematic of wavelength content of the near-IR and visible sources used. The two curves correspond to Xe-arc lamp emission transmitted either by an IR absorbing filter (Schott KG5) or by a silicon filter. The three vertical bars represent the laser wavelengths used (Nd:YAG at 532 or 1064 nm, or a laser diode at 806 nm.) The size of the laser-quenching effect for different optical wavelengths is qualitatively indicated. The vertical scale is meaningless since it was impossible to compare the relative power incident on the laser for each source in this first experiment.

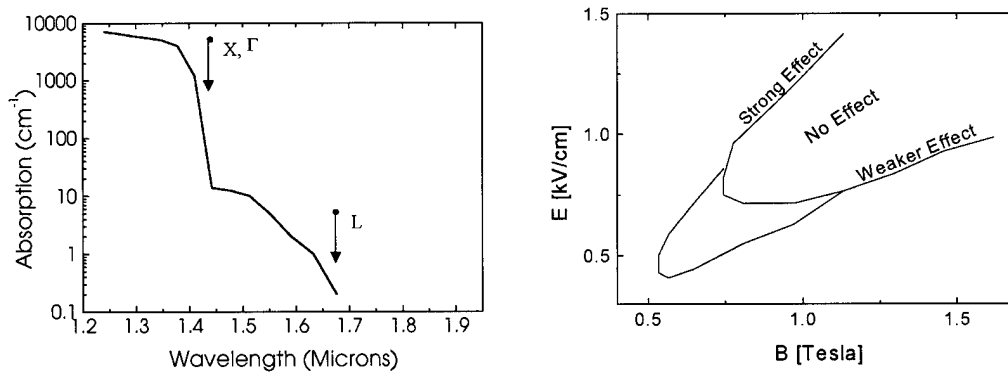

Figure 10. Absorption coefficient vs. wavelength for Ge at 4K showing position of band minima. (Right). Generation zone for p-Ge laser with qualitative indication of quenching by optical irradiation on one end face of the active crystal.

Quenching of far-infrared laser emission by optical perturbation also depended on where in the generation zone the p-Ge laser operated (Figure 10, right). The most remarkable effect was observed on the upper border where the threshold is sharpest. The effect is weaker on the lower border, where the lasing threshold is broader. In the center of the laser zone, where the p-Ge laser gain is highest, the laser emission was not quenched by the optical irradiation. These results are in agreement with the earlier electrical modulation results, where (especially in Faraday configuration of applied fields^[5]) mode-locking was easiest to obtain near the border of the generation zone.

Figure 11 shows a proposed mode-locking scheme where laser gain might be optically modulated at the cavity round-trip time. This would have several potential advantages over the previous UCF electrical method. There would be no need for additional ohmic contacts, whose placement is critical and which are difficult to change. The old electrical scheme required 100 W of applied rf, but optical modulation using laser diodes might be much more efficient and less of a heat load.

The high modulation speeds possible with telecom laser diodes might make it much more convenient to optimize the modulation of the far-IR laser gain. For the same reason, harmonic mode-locking with pulse-position modulation^[4] might be possible. Telecom hardware for fiber coupled optical modulation is already in a very advanced state of sophistication. Because the absorption depth for above-gap radiation in germanium is only about 1 micron (Figure 10), optical modulation might give much shorter far-IR pulse duration than electrical modulation, which perturbs the active crystal over mm length scales^[4,5].

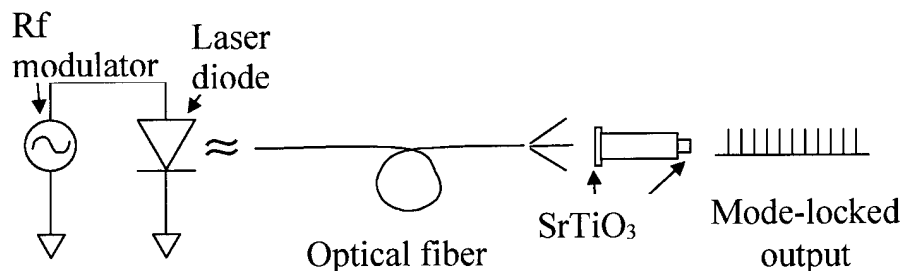

Figure 11. Proposal for far-IR short-pulse generation from p-Ge lasers by optical gain modulation at one end surface of the active laser crystal.

ESTIMATE OF TECHNICAL FEASIBILITY

Permanent Magnet Assembly

A permanent magnet assembly that allows the p-Ge laser to operate in the high-field laser generation zone is technically feasible. Commercial feasibility will require the Magnet Sales design (Figure 2), to be tested in Phase II.

Closed Cycle Refrigerator

During the Phase I, we learned how to make adequate thermal contact to cool p-Ge laser crystals below 15 K, even while dissipating 0.2 W of electrical power and with an attached 0.5 kg magnet assembly. We also showed that the cryostat can be connected to the HV pulser ground without adverse effect. The

redesigned magnet assembly will allow us to observe laser emission using a closed cycle cooler during Phase II.

SrTiO₃ Mirrors

SrTiO₃ far-infrared laser mirrors gave outstanding performance and will replace copper mirrors in all future experimental and commercial p-Ge laser systems.

External Semi-Confocal Resonator

Such a resonator was demonstrated here for the first time in a p-Ge laser, proving the technical feasibility of the concept. A commercially viable system will involve uncooled mirrors, probably external to the cryostat. This creates many new possibilities for p-Ge laser cavities and applications.

Piezo-Controlled Selector

A piezo-controlled wavelength selector (Figure 5) was shown to be technically feasible. A commercially feasible tuning element needs to operate at room temperature and without additional transparent etalons. The possibility of a room-temperature selector now exists because of our external cavity demonstration.

GaN-Alloy Solder Contacts

These contacts are technically feasible and have the advantage of being very low tech and easy to make or repair. They appear to provide better laser performance than evaporated aluminum contacts. Ion-implantation of the contacted Ge surfaces will improve the quality, but GaIn alone is adequate.

MOSFET and IGBT Pulsers

The MOSFET pulser is technically and commercially feasible with few modifications (snubber). The IGBT pulser requires a redesign of the triggering circuit, but is expected to result in an even lower cost and more robust switch.

Optical Modulation of Laser Gain

This discovery was made possible by use of SrTiO₃ mirrors. It gives new potential to generate mode-locked far-IR laser output. It should prove superior to previous electrical mode-locking schemes. For example, one might use a standard telecom laser as a modulator, which would require low power using sophisticated hardware with low unit cost. Such a modulator would enhance opportunity to optimize pulse characteristics and impress data onto the pulsed THz output.

References:

1. "Submillimeter p-Ge laser using a Voigt-configured permanent magnet," Kijun Park, R. E. Peale, H. Weidner, and J. J. Kim, IEEE J. Quantum Electronics 32, 1203 (1996).
2. "Piezo-controlled intracavity wavelength selector for the far-infrared p-Ge laser," E. W. Nelson, A. V. Muravjov, S. G. Pavlov, V. N. Shastin, R. E. Peale, Infrared Physics & Technology 42, 107 (2001).

3. "Effect of intracavity interfaces on p-Ge laser emission dynamics, spectrum, and gain," E.W. Nelson, S.H. Withers, A.V. Muravjov, R.C. Strijbos, and R.E. Peale, S.G. Pavlov and V.N. Shastin, C.J. Fredricksen, submitted IEEE J. Quantum Electronics, 4/24/01.
4. "Pulse separation control for mode-locked far-infrared p-Ge lasers," A. V. Muravjov, R. C. Strijbos, C. J. Fredricksen, S. H. Withers, W. Trimble, S. G. Pavlov, V. N. Shastin, and R. E. Peale, Appl. Phys. Lett. 74, 167-169 (1999).
5. "Actively mode-locked p-Ge laser in Faraday configuration," A. V. Muravjov, S. H. Withers, R. C. Strijbos, S. G. Pavlov, V. N. Shastin, and R. E. Peale, Appl. Phys. Lett. 75, 2882 (1999)

People Involved in Contract:

Zaubertek: Chris Fredricksen (PI), Dr. Robert E. Peale (Technical Consultant), Janis Key (General Manager).

UCF: Dr. Andrei Muravjov (Research Associate), Eric Nelson (Graduate Student).

Publications Stemming from Research Effort:

1. "Piezo-controlled intracavity wavelength selector for the far-infrared p-Ge laser," E. W. Nelson, A. V. Muravjov, S. G. Pavlov, V. N. Shastin, R. E. Peale, Infrared Physics & Technology 42, 107 (2001).
2. "Effect of intracavity interfaces on p-Ge laser emission dynamics, spectrum, and gain," E.W. Nelson, S.H. Withers, A.V. Muravjov, R.C. Strijbos, and R.E. Peale, S.G. Pavlov and V.N. Shastin, C.J. Fredricksen, submitted IEEE J. Quantum Electronics, 4/24/01.
3. "External semi-confocal resonator for the far-IR p-Ge laser," manuscript in progress.
4. "Optical gain modulation of far-infrared p-Ge laser gain," manuscript in progress.