

Public Reporting burden for this collection of information is estimated to average 1 hour per response, including the time for reviewing instructions, searching existing data sources, gathering and maintaining the data needed, and completing and reviewing the collection of information. Send comment regarding this burden estimate or any other aspect of this collection of information, including suggestions for reducing this burden, to Washington Headquarters Services, Directorate for Information Operations and Reports, 1215 Jefferson Davis Highway, Suite 1204, Arlington, VA 22202-4302, and to the Office of Management and Budget, Paperwork Reduction Project (0704-0188), Washington, DC 20503.

1. AGENCY USE ONLY (Leave Blank)

2. REPORT DATE

August 23, 2001

3. REPORT TYPE AND DATES

COVERED 01 May 99- 31 Oct 00
Final Progress Report (Stage two)

4. TITLE AND SUBTITLE

Improvement of Fast Binary Pressure-Sensitive Paint Technology for Helicopter Rotor Blade Investigations

5. FUNDING NUMBERS

Contract Number
DAAD19-99-1-0176

6. AUTHOR(S)

*V.P.Koulesh, V.E.Mosharov, V.N.Radchenko, N.N.Tarasov,
S.M.Bosnyakov, L.M.Moskalik*

20011023 042

7. PERFORMING ORGANIZATION NAME(S) AND ADDRESS(ES)

*CENTRAL AEROHYDRODYNAMIC INSTITUTE (TsAGI)
Zhukovsky St. 1, Zhukovsky-3, Moscow Region, 140160 RUSSIA*

9. SPONSORING / MONITORING AGENCY NAME(S) AND ADDRESSEES

U. S. Army Research Office
P.O. Box 12211
Research Triangle Park, NC 27709-221110. SPONSORING / MONITORING
AGENCY REPORT NUMBERProposal Number 39806-EG
✓
.1

11. SUPPLEMENTARY NOTES

The views, opinions and/or findings contained in this report are those of the author(s) and should not be construed as an official Department of the Army position, policy or decision, unless so designated by other documentation.

12. a. DISTRIBUTION / AVAILABILITY STATEMENT

Approved for public release; distribution unlimited.

12 b. DISTRIBUTION CODE

13. ABSTRACT (Maximum 200 words)

The laboratory investigations of the characteristics of fast PSP are continued. In the first stage it was already investigated the spectra of emission and excitation, the calibration characteristics and the time response. In addition the spatial homogeneity of the covering is investigated. The scheme of experiment in T-105 wind tunnel using the helicopter devices MVP-5 and MVP-8 is developed and the supporting optical system is designed. The developed units and blocks to optical system are manufactured. The algorithms and programs of processing of the PSP images was enhanced to binary-type images. All units and techniques have been tested in TsAGI's T-125 wind tunnel at investigations of airfoil model with chord 100 mm, approximately equal to chord of model of the helicopter blade model under test.

14. SUBJECT TERMS

15. NUMBER OF PAGES

24

16. PRICE CODE

17. SECURITY CLASSIFICATION
OR REPORT

UNCLASSIFIED

18. SECURITY CLASSIFICATION
ON THIS PAGE

UNCLASSIFIED

19. SECURITY CLASSIFICATION
OF ABSTRACT

UNCLASSIFIED

20. LIMITATION OF ABSTRACT

UL

NSN 7540-01-280-5500

Standard Form 298 (Rev.2-89)
Prescribed by ANSI Std.239-18

Enclosure I

27 2001

SEP 27 2001

Improvement of Fast Binary Pressure-Sensitive Paint Technology for Helicopter Rotor Blade Investigations

Stage two: Experimental arrangement investigation

31 October 1999 – 31 October 2000

Final Progress Report

By

V.P.Koulesh, V.E.Mosharov, V.N.Radchenko, N.N.Tarasov, S.M.Bosnyakov, L.M.Moskalik
- TsAGI, Zhukovsky, Russia

U.S. Army Research Office

United States

Proposal Number **39806-EG**

Contract Number **DAAD19-99-1-0176**

CENTRAL AEROHYDRODYNAMIC INSTITUTE (TsAGI)
Zhukovsky St. 1, Zhukovsky-3, Moscow Region, 140160 RUSSIA

Approved for Public Release; distribution unlimited

Improvement of Fast Binary Pressure-Sensitive Paint Technology for Helicopter Rotor Blade Investigations

Stage two: Experimental arrangement investigation

ARO Grant N DAAD19-99-1-0176

V.P.Koulesh, V.E.Mosharov, V.N.Radchenko, N.N.Tarasov,
S.M.Bosnyakov, L.M.Moskalik

TsAGI, Zhukovsky, Russia

Abstract

The laboratory investigations of the characteristics of fast PSP are continued. In the first stage it was already investigated the spectra of emission and excitation, the calibration characteristics and the time response. In addition the spatial homogeneity of the covering is investigated. The scheme of experiment in T-105 wind tunnel using the helicopter devices MVP-5 and MVP-8 is developed and the supporting optical system is designed. The developed units and blocks to optical system are manufactured. The algorithms and programs of processing of the PSP images was enhanced to binary-type images. All units and techniques have been tested in TsAGI's T-125 wind tunnel at investigations of airfoil model with chord 100 mm, approximately equal to chord of model of the helicopter blade model under test.

Contents

Introduction	3
Spatial homogeneity of PSP covering tests	4
Experiment equipments	6
Scheme of PSP measurement setup	9
Optics support mechanism	10
CCD-camera unit	10
Synchronization system	13
Flash lamp system	14
Evaluation of the Measurement System Components in T-125 Wind Tunnel	17
T-125 Wind Tunnel	17
The test Model of the Foil	18
The binary PSP images processing	19
The original images	20
The Frame operations are shown the following activities:	21
The Channels transforms consist of the following operations:	22
Compare and representation	23
Test results	23
Conclusions	24
Acknowledgement	24

Introduction

Pressure distribution on the surface of the helicopter blades determines the aerodynamic properties of the rotor system and bending and twisting deformation of the blades. Promising method to measure pressure distributions is the non-contact optical method using Pressure Sensitive Paint (PSP). PSP is a thin polymeric layer penetrable for oxygen molecules and containing luminophore molecules. This layer is applied on the model surface and luminescence is excited by appropriate light source. Luminescence output is inversely proportional to the oxygen concentration in the PSP layer, which is function of the local air pressure on the outer boundary of the PSP layer. Thus the digital recording and treatment of luminescent intensity distribution provides pressure distribution on the surface covered by PSP.

The first stage of the project on Improvement of Fast Binary Pressure-Sensitive Paint Technology for Helicopter Rotor Blade Investigations was carried out in the period since 31 October 1998 to 31 October 1999. The results of that work have been represented in "Improvement of Fast Binary Pressure-Sensitive Paint Technology for Helicopter Rotor Blade Investigations", Final Progress Report, Stage one: Experimental arrangement preparation, authors V.P.Koulesh, V.E.Mosharov, V.N.Radchenko, N.N.Tarasov, S.M.Bosnyakov, A.N.Morozov, L.M.Moskalik.

The present report represents the results of the second stage of the project on Improvement of Fast Binary Pressure-Sensitive Paint Technology for Helicopter Rotor Blade Investigations. These works were carried out in the period since 31 October 1999 to 31 October 2000. At this stage the following investigations were executed:

1. The laboratory investigations of the characteristics fast PSP covering are continued. In the first stage it was already investigated the properties:

- spectrum of emission;
- spectrum of excitation;
- calibration characteristics;
- time response,

In addition it is investigated

- spatial homogeneity of the PSP covering.

2. The scheme of experiment in T-105 wind tunnel using helicopter devices MVP-5 and MVP-8 is developed and the supporting system for optics is designed. The manufacturing of this mechanism needs significant expenses of time and materials, therefore was lingered over because of insufficient financing.

3. The developed units and blocks to optical system are manufactured, such as:

- CCD camera with a prism image splitter unit;
- illumination head and controller of the flash-lamp;
- laser-electronic block of synchronization;
- block of control and synchronization;
- some optical elements.

4. The algorithms and programs of processing of the PSP images was enhanced to binary-type images.

5. All developed units and techniques have been tested in TsAGI's T-125 wind tunnel at investigations of airfoil model with chord 100 mm, approximately equal to chord of model of the helicopter blade model under test.

Spatial homogeneity of PSP covering tests

Two types of spatial homogeneity of Pressure Sensitive Paint were investigated: spatial homogeneity of luminescence and spatial homogeneity of pressure sensitivity. For this purpose the sample of LPS was placed into the calibration cell and its luminescence was acquired by digital CCD-camera at different pressure levels. The acquisition of images was made from the short distance to provide spatial resolution of 11 pixels per millimeter that is much better than spatial resolution in the most of wind tunnel experiments. Long period variation of luminescence intensity of LPS sample (Fig.2,a) is caused by the distribution of excitation light intensity and was not corrected in these tests, while in the real wind tunnel experiments the effect of excitation light intensity distribution is corrected by the rationing of 'wind-off' to 'wind-on' images. Short-term disturbances of luminescence intensity are caused by non-uniformity of LPS layer (thickness variation, variation of the component concentration, impurities, etc.). They also should be corrected by the rationing of 'wind-off' to 'wind-on' images (Fig.2,b) but inaccuracy in image alignment during the rationing can cause essential noise in the ratio image. To understand the characteristic size of LPS non-uniformity the Fast Fourier Transformation of the images (their central part 256×256 pixels) was made. Nothing characteristic frequencies were detected on 2D spectra and, since these spectra were symmetric, they were transformed to unidimensional spectra by integration of 2D spectra in the rings of equal frequency $\omega = \sqrt{\omega_x^2 + \omega_y^2}$ (Fig.3). It can be seen that most irregularities of luminescence image have the size less than 0.5mm and practically nothing irregularities have the size more than 1 mm. Also it can be seen that the rationing of ideally aligned images exclude very well the spatial non-uniformity of LPS luminescence. Non-ideal image alignment will lead to appearance of the spatial noise of the image ratio. Since spatial resolution in the most of experiments have the order of 0.5÷1 mm the spatial non-uniformity of LPS luminescence images should not take significant effect on the noise of results. In any case the precise alignment of the images during the rationing shall decrease the noise of the ratio significantly.

Non-uniformity of LPS pressure sensitivity is caused by non-uniformity of polymer permeability at the microlevel. Since the same calibration characteristic is used for pressure calculation in all points of the model surface the spatial variation of LPS pressure sensitivity leads to an error of local pressure calculation. To determine spatial variation of sensitivity the LPS was assumed to have linear calibration characteristic:

$$\frac{I_{ref}}{I} = a + b \cdot p = 1 + b \cdot (p - p_{ref});$$

where I_{ref} is reference luminescence intensity at the reference pressure p_{ref} and b is pressure sensitivity of LPS.

Pressure sensitivity of LPS was calculated as:

$$b = \frac{I_{ref}/I - 1}{p - p_{ref}}.$$

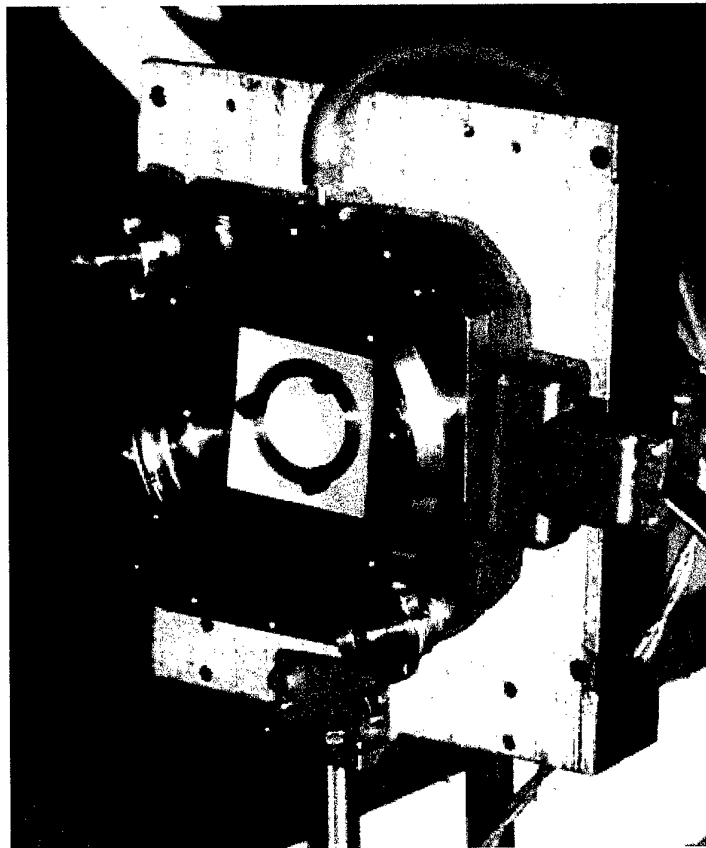

Fig.1. The view of the PSP covering sample in the cell of calibration system.

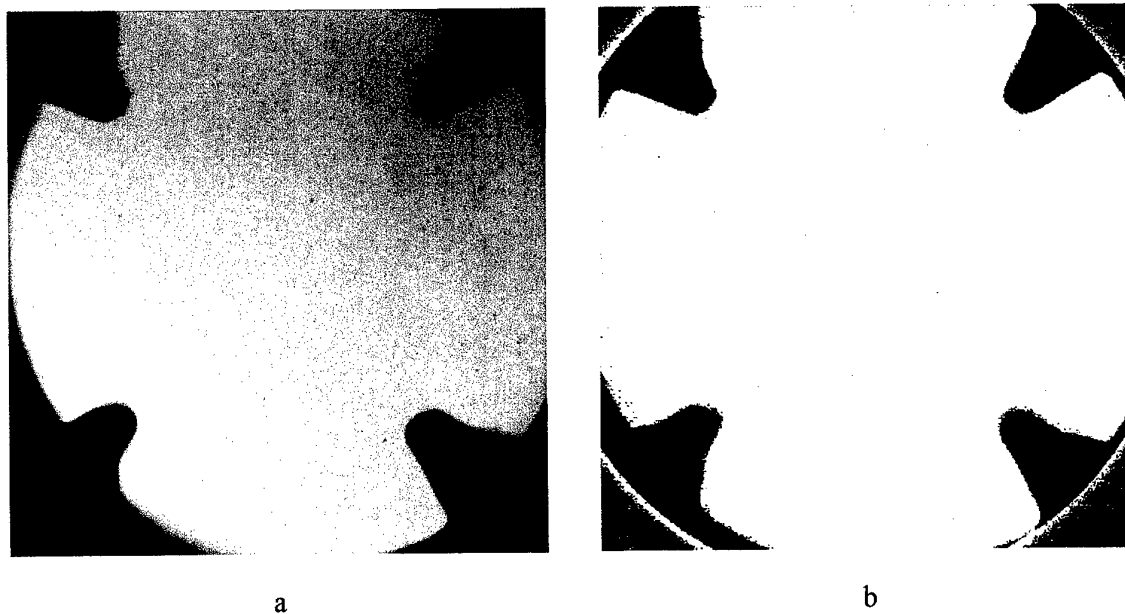

Fig.2. Image of LPS sample luminescence at the pressure $p=0.1\text{bar}$ (a) and its ratio to the image at the pressure $p=1\text{bar}$ (b).

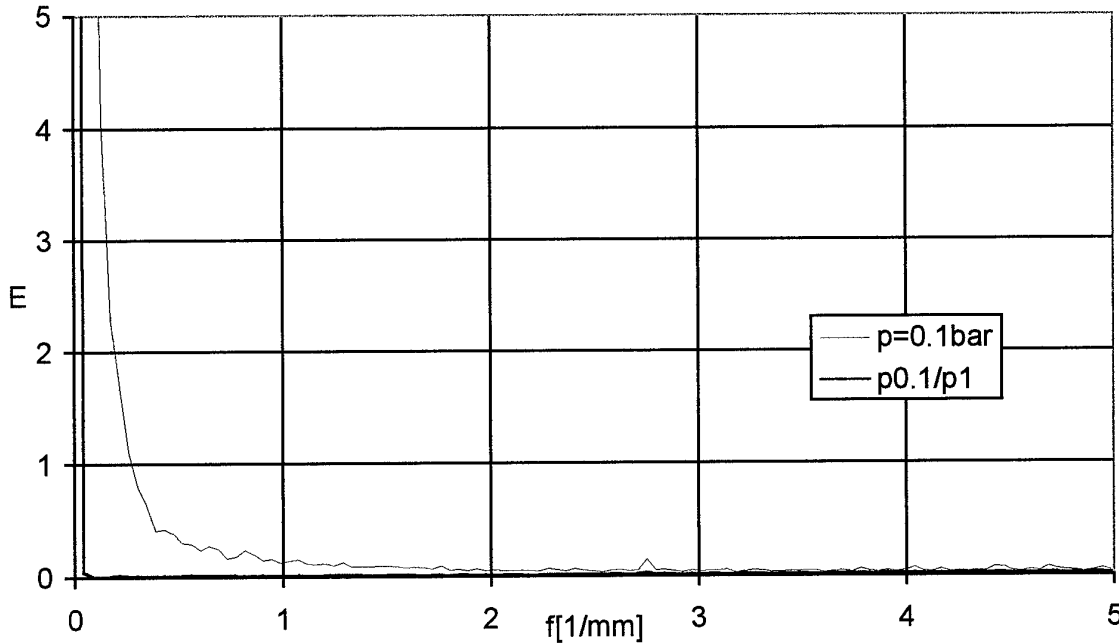

Fig.3. Spatial spectra of luminescence image at $p=0.1\text{ bar}$ and of its ratio to the image at $p=1\text{ bar}$.

To minimize an error of pressure sensitivity calculation the difference between reference and measurement pressure should be as much as possible. Pressure sensitivity was determined from the ratio of LPS sample images at the normal (1 bar) and low (0.1 bar) pressure. Pressure sensitivities of the central part of the sample (256×256 pixels) was plotted as histogram and approximated by the normal distribution law (Fig.4).

Histogram of pressure sensitivity is caused both by variation of pressure sensitivity and by the noise of CCD camera. Relative dispersion of histogram is 0.66% ($0.0038/0.572 \cdot 100\%$). Analysis of the noise of CCD-camera shows that its dispersion was of about the same value as the total dispersion. This fact does not allow to determine correctly the real value of pressure sensitivity dispersion and allows to estimate only upper limit of this dispersion as 0.5%. This estimation is quite crude and is caused by restricted accuracy of CCD-camera used in these tests.

Experiment equipment

The experimental investigations of the helicopter rotor blade model by means of Fast Binary Pressure-Sensitive Paint technology should be performed at the TsAGI's T-105 wind tunnel. These tests will be accomplished using the rotor devices MVP-5 and MVP-8. Description of the wind tunnel and of the experimental equipment used for rotor model tests is given below.

The vertical continuous-flow closed-type T-105 wind tunnel with an open test section has the direction of flow from below upward (Fig.5). The open test section of this wind tunnel has nozzle diameter 4.5 m and length 7.56 m . The airflow velocity in the test section can vary from 2 to 40 m/sec . The power of the fan drive is 450 kW .

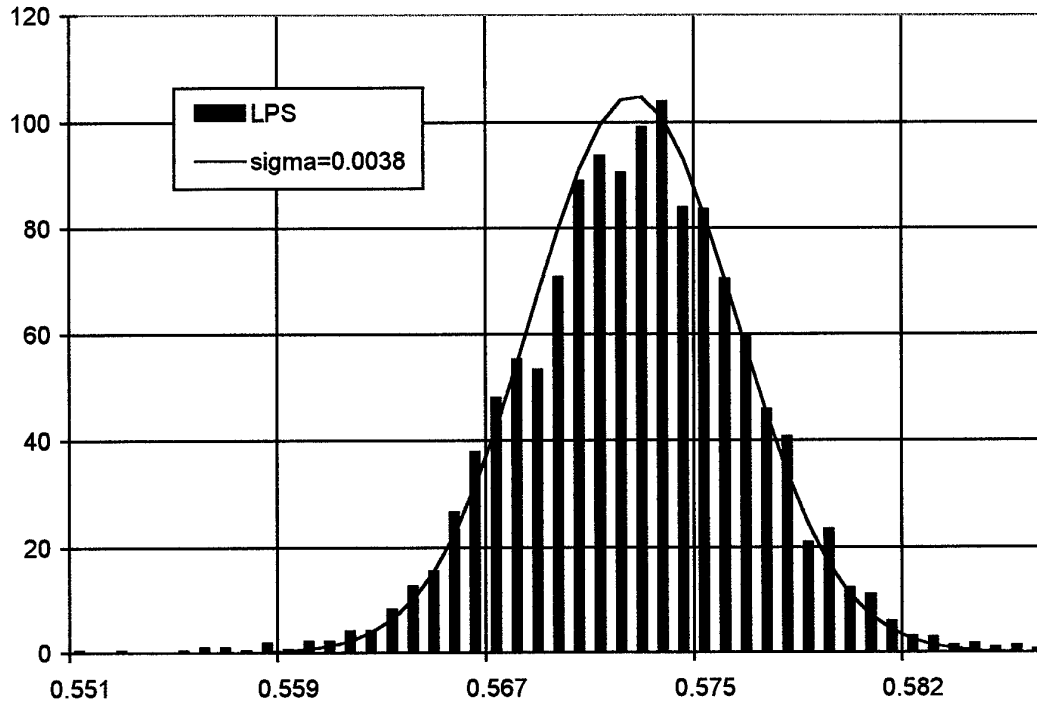

Fig.4. Histogram of pressure sensitivity of LPS.

The T-105 wind tunnel is equipped two helicopter devices MVP-5 and MVP-8 (Fig.6). The model helicopter MVP-8 device is designed to support and operate the rotor model. It consists of two support trusses and a horizontal bar both ends of which are fastened to the trusses. The trusses have wheels that make it possible to move the rig along the rail track in the wind tunnel test section. One of the trusses of the rig is equipped with a mechanism of a remote change of the rotor model angle of attack and its indication.

The rotor model angle of attack is changed by rotating the bar with respect to its longitudinal axis. The other truss is equipped with a high frequency electrical motor and a gear. This gear through a shaft passing inside the bar is connected to the central angular gear that is located in the middle part of the bar. Strain gauge balance or other modules are attached to the flange of the central angular gear. With such a structure of the rig it is possible to test one rotor or, using additional modules, two-, three-, four-rotor systems and control devices of the helicopters. The tail rotors are tested together with the tail part of the helicopter airframe.

The angles of the blade common and cyclic pitch are changed by a remote control system. A number of six-component strain gauge balances, designed for various loads, and the controlling information and calculation system provide measurement of forces and moments.

The MVP-5 device has destined to carry the test and measurement arrangement. It has a frame load carrying structure mounted on a movable tower. The tower can move on rails in the wind tunnel test section. The frame of the device in its turn may displace along the vertical guides on the tower. A high frequency electrical motor and a gear are attached to the frame. Models of rotors, fuselages or fuselages with rotors are fastened with screws on the frame cantilever part.

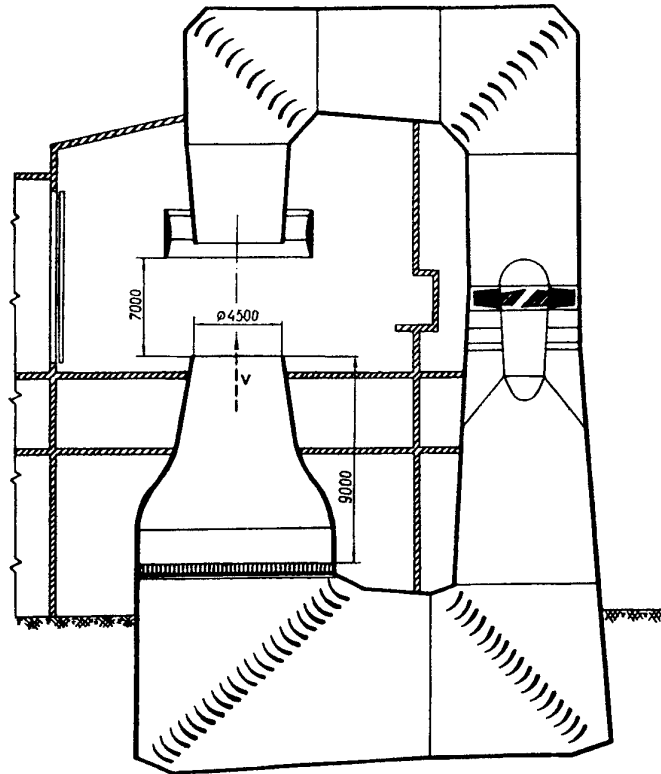

Fig.5. Scheme of the TsAGI's T-105 wind tunnel

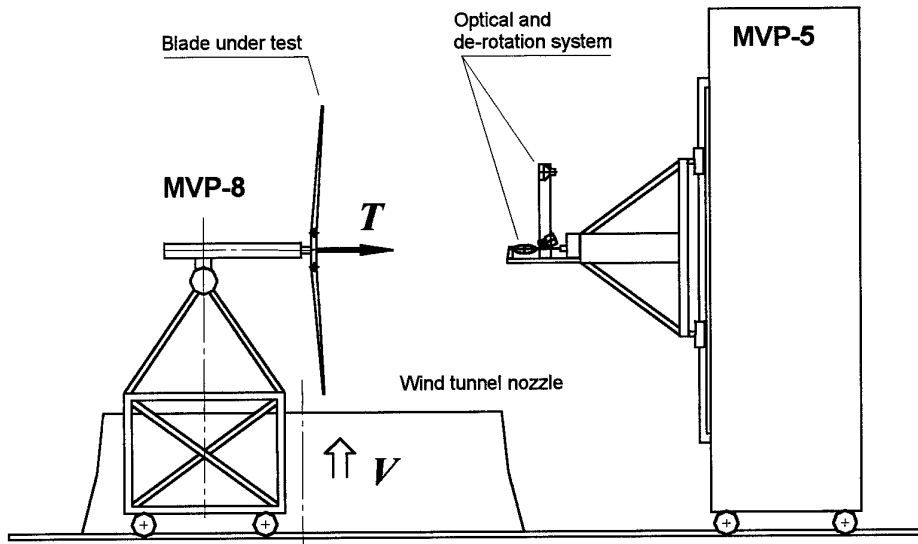

Fig.6. Scheme of the model helicopter devices MVP-5 and MVP-8

The cantilever may rotate relative to the horizontal axis providing variation of the slide angle during testing fuselages. A mechanism of changing the attack angle of models is mounted on the cantilever. The mechanisms of changing the angles of attack and slide are remotely controlled. The aerodynamic loads on the fuselage models are measured by an inner six-component strain-

gauge balance. During test of a fuselage model with rotor rotation from the electrical motor is transmitted by a shaft to the rotor through the gear of the mechanism changing the angle of attack. The aerodynamic loads on the rotor model in this case are measured or at the preliminary tests isolated rotor or by a three component strain gauge, located inside the fuselage model together with the fuselage balance if the dimensions and the construction of the model permission.

In PSP tests the helicopter devices MVP-5 should be used to support the optical and de-rotation system.

Scheme of PSP measurement setup

The general scheme of the experimental setup for pressure distribution measurements by PSP on the blade of the helicopter rotor model in T-105 wind tunnel is presented on Fig.7

The measurement system includes the following subsystems:

- The blade under test coated with the PSP layer;
- The optical de-rotation system;
- The optical receiving unit based on the digital CCD-camera with prism image splitter;
- The UV flash lamp system: flash-lamp header and controller;
- The laser sync system: receiving photodiode assemble (photosynchronizer) and synchronization unit;

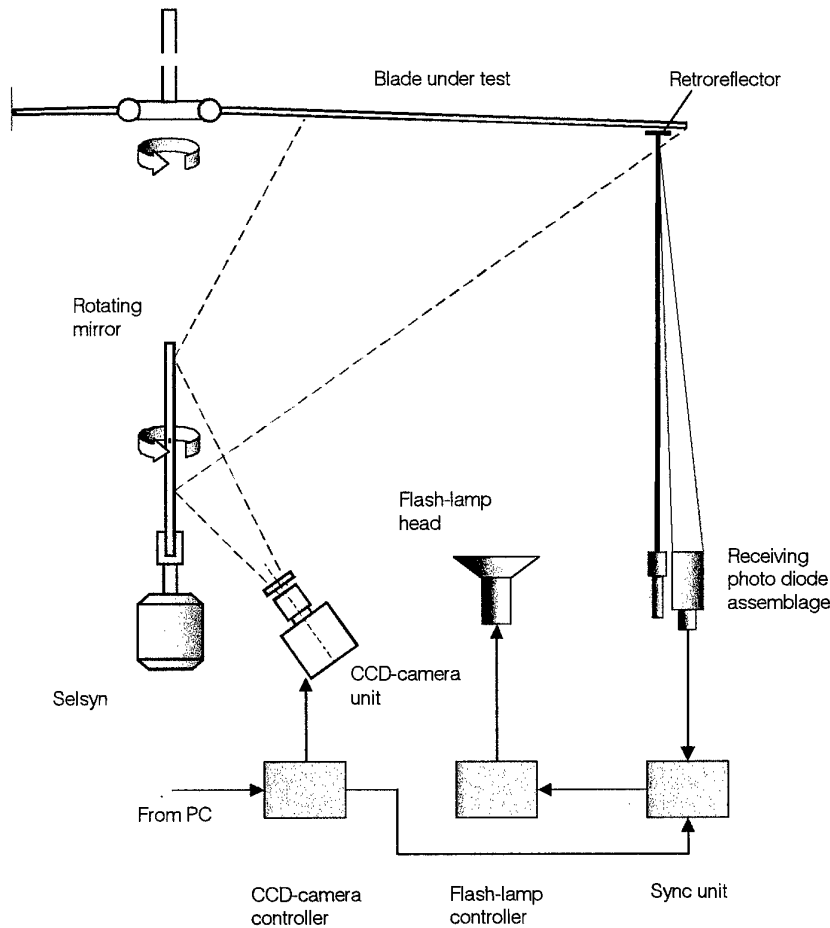

Fig.7. General block-diagram of PSP measurement setup

Optics support mechanism

The researches of the helicopter rotor model in a wind tunnel by a PSP technology has one more problem relative to registration of the image of the blade rotated with large speed. The duration of a pulse of illuminating UV-radiation can be small to prevent a smearing image. Decay time of active layer luminescence also is rather small - 100 *nsec*. However decay time of reference layer luminescence is about 0.5 *msec*. For this time the end of the blade of 1.25 *m* radius rotated with rate of 700 *rpm* passes a path about 0.08 *m* (that corresponds to turn approximately on 4 degrees). Therefore the reference image of the blade will appear smeared and completely not suitable for use.

To obtain the sharp reference image we offer to apply optical de-rotator system freezing the view of rotating blade. This system shall be carried out by means of vision of the blade by the camera through a mirror rotated around of axes conterminous with an axis of rotation of the helicopter rotor model in a conterminous direction but with a rate twice smaller than the rate of rotor model rotation. We assume that this approach will allow to stop the visible image of the blade at its turn on angle exceeding 12 degrees and to obtain the good images of both active and reference layers.

For this purpose optic-mechanical system with the synchronously rotating mirror should be produced. To PSP tests of a rotor blade model the original optical and de-rotation system has been developed. The structure scheme of this unit is shown on Fig.8. The optical and de-rotation system contains the CCD-camera unit, the rotating mirror with selsyn drive, the flash-lamp head and the laser sync-system unit.

CCD-camera unit

As the image detector in the receiving optical unit the digital 'Photometrics' CH250 CCD-camera is applied. Objective lens focus $F=80\text{ mm}$ is applied in this unit. The special prism image splitter was offered to registration both active and reference images on one CCD array.

The new steel case for the 'Photometrics' digital CCD-camera was developed and made. Such case is necessary for preventing an influence of electromagnetic field pulses from the powerful flash lamp on CCD-camera. An exterior of the receiving optical unit is shown on Fig.9.

Usually the distributions of luminescence of red and blue-green spectrum ranges are registered by two different cameras equipped with red and blue-green optical filters. Good correction of technological distributions needs good coincidence of the same points of a surface on two different images. However the cameras have various position relative to the surface under test. The images receive various perspective distortions. Thus the superposition of the same points of a surface on two different images cannot be carried out without appreciable errors, which result to too large errors in measurement of distribution of the pressure.

It is offered to try to register both images simultaneously by one camera. For this purpose a prism image splitter is suggested to separate two images of different spectral range on one CCD-array. In this case the directions of registration of two images will almost coincide and as a result their perspective distortions will be almost identical and the error of superposition of the same points of a surface on two different images shall be minimum.

For this purpose optical system is developed and prism light splitter is made. Moreover it is necessary to develop new algorithms of processing such double images and to modernize the software.

Scheme of the prism image splitter

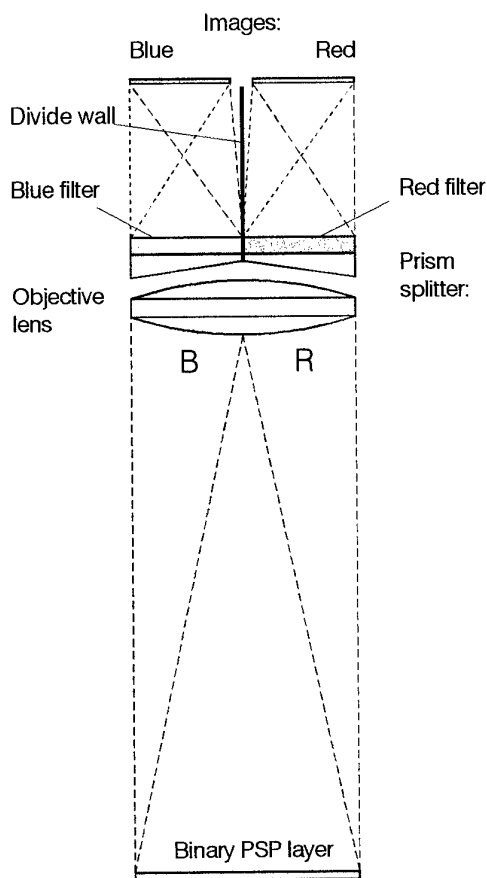

The optical elements of the prism splitter

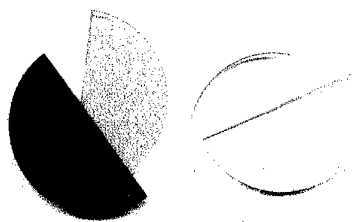

The exterior of the receiving CCD-camera unit

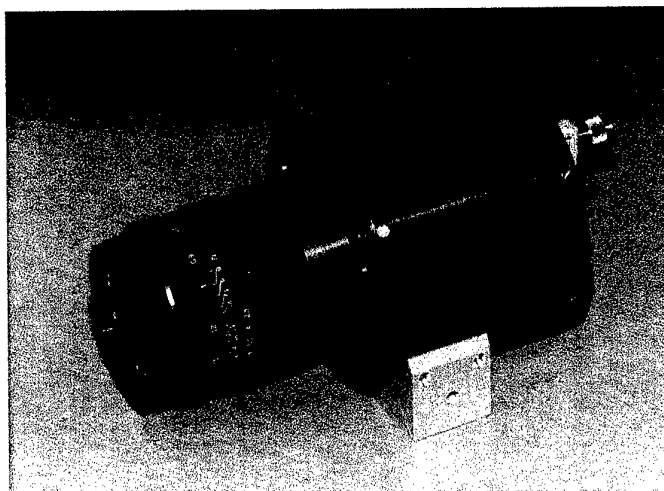

Fig.9. The optical receiving CCD-camera assemblage

A prism image splitter is needed for simultaneous registration of both the active (blue) and reference (red) images on one CCD-array. The scheme of the image splitter and complete set of optical elements to the prism splitter are shown on Fig.9.

The first variant of the splitter is intended for an arrangement before a receiving objective lens. As researches have shown such splitter of the images is more preferable for using with a receiving objective lens having a short focal length. This scheme is intended for an arrangement after a receiving objective lens having a long focal length. This variant allows applying a light-impenetrable wall to complete division red and blue images.

The prism splitter of the image was designed and made for concrete optical system and reception objective lens specially. Besides it is necessary to develop new algorithms of processing of such double images and to modernize the software.

The prism image splitter divides the aperture of a receiving objective lens into two parts, each of them participates separately in forming of its image. At change of an angle of a light beam direction inevitably changes a ratio of the areas of these two parts of an objective lens pupil. It is the reason of a non-standard vignetting resulting to unequal of image intensity distribution on two images.

The non-standard procedure of Flat Field Correction - numerical alignment of the attitude of sensitivity - should be applied for indemnification of this phenomenon by two halves of one

CCD-array. It assumes a development of a special technique and devices for calibration of CCD-camera and modernization of the software for its realization.

Synchronization system

The system of lamp ignition synchronization consists of two units: photosynchronizer and synchronization unit with flash lamp controller. Photosynchronizer consists of laser pointer, receiving optics, photo-diode and electric signal shaper (Fig. 10).

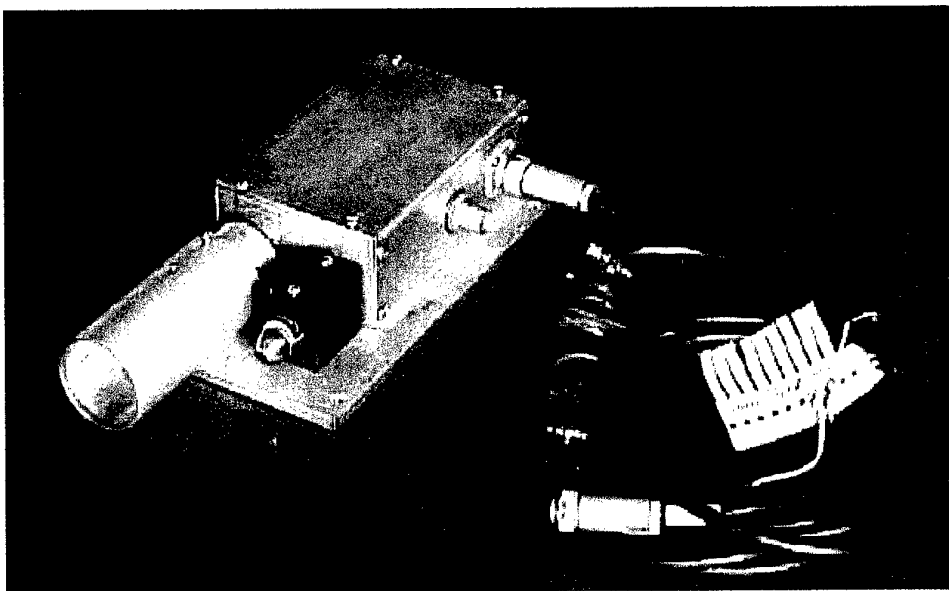

Fig. 10. Laser pointer and receiving photo-diode assemblage (photosynchronizer).

The electric signal shaper consists of photodetector current amplifier, comparator and output transistor with TTL-level shaper. It also contains stabilized power supply to laser pointer. This board is powered with 12VDC from flash lamp controller while it may be powered from two cells 4.5V each.

Synchronization unit is assembled with flash lamp controller (Fig.11). It generates single ignition pulse either directly from external pulse (PC, CCD-camera controller, etc.) or from photosynchronizer at the presence of gate signal from PC. Two connector groups JP1 and JP2 are installed on synchronization unit board. Jumper settings of these connectors determine operation mode of synchronization unit:

- JP1: 1-2 - ignition from photosynchronizer;
2-3 - ignition directly from PC.
- JP2; 1-2 - ignition or gate signal is valid immediately after its installation from PC;
2-3 - ignition or gate signal is valid after 20msec delay from PC signal;
(this delay is necessary to open mechanical shutter of CCD-camera).

Manual gate button K1 is also installed on the front panel of flash lamp controller.

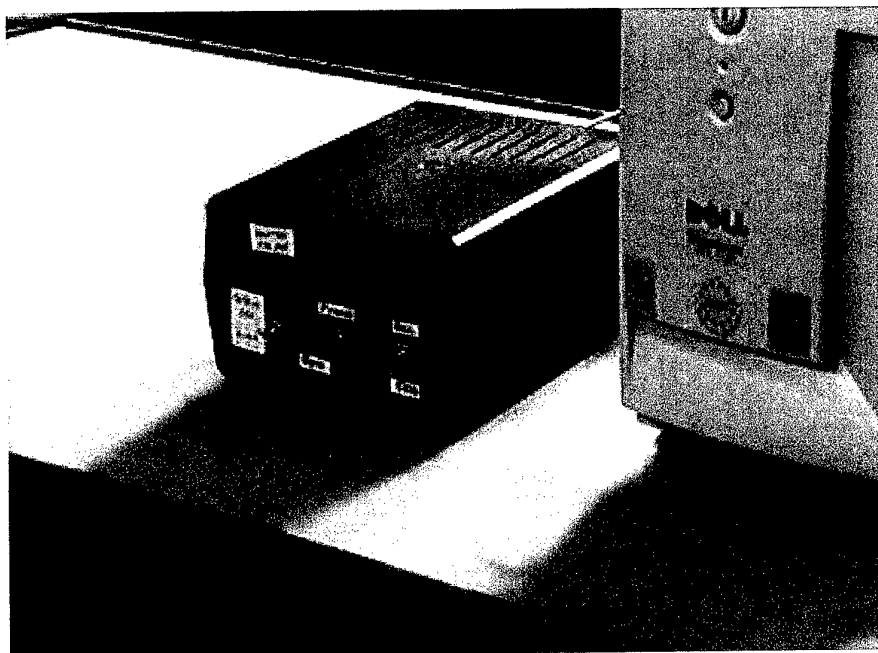

Fig.11. Electronic synchronization unit

Flash lamp system

A Xenon flash lamp will be used for PSP excitation for pressure distribution measurements on the blade of the helicopter rotor model in T-105 wind tunnel. The main problem of binary paint excitation is how to cut red and infrared spectral range of light source, in which reference luminophor emits light (610-640 nm) and CCD-cameras are very sensitive. There are no effective glass filters that permit UV light (<350 nm) to pass, cutting light of the other spectral range. The best such filter is possibly the UFS-2 filter of Soviet production. Our experience shows that for an effective cutting of the red light of the lamp the UFS-2 filter thickness should be more than 10mm, and in this case only one-third part of UV excitation light passes through the filter. To optimize UV output of the light source glass filter UFS-2 (thickness 3mm) is used in combination with interference filter (hot mirror). Optical scheme and exterior of flash-lamp head of excitation light source is shown in Fig.12.

The flash lamp controller provides high voltage to the lamp and controls initialization of lamp flash. The photo of flash lamp controller is presented in Fig.13.

Flash lamp controller is assembled in a case of 480×120×380 mm size. Flash lamp controller consists of controllable pulse generator, high-voltage converter, high-voltage capacitors, ignition unit, ignition control unit, comparator, reference voltage source and synchronization. The controller is powered with 36VAC.

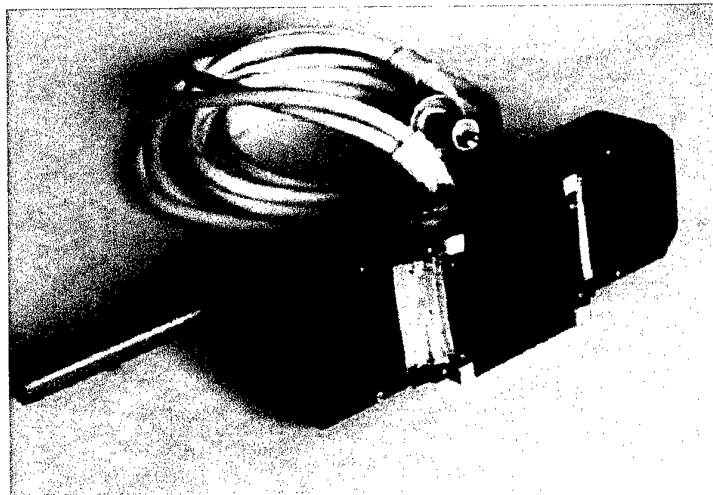
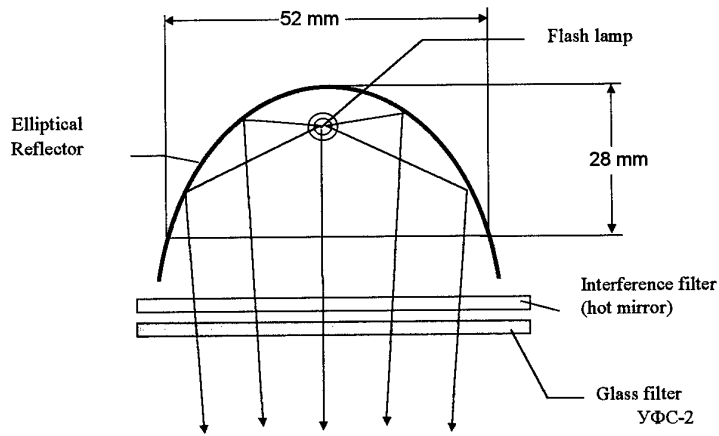

Fig. 12. Optical scheme and exterior of the flash-lamp head of excitation light source

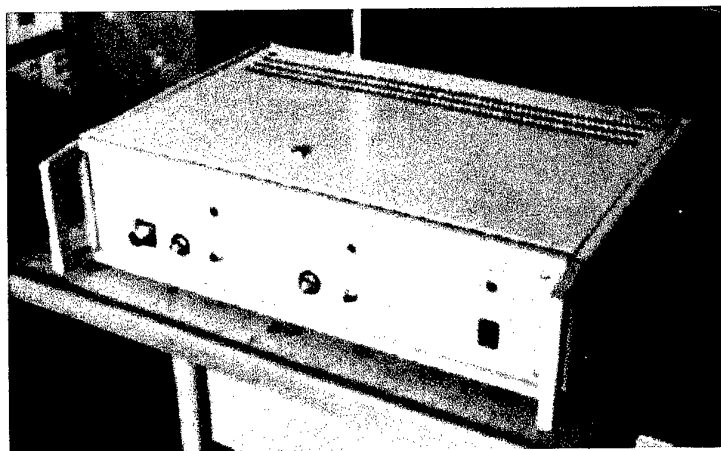

Fig. 13. Exterior of flash lamp controller.

Flash lamp controller provides the next technical features:

- Charge energy, J 80...200
- Charge voltage, V 900...1400
- Charge voltage instability (8 hours work), % 1
- Charging time, not more, sec 4
- Lamp ignition consequent
- Flash duration (0.5 level), μsec 170...180
- Power, W 30...42
- Power consumption, W 100

Spectral range of light source output is shown on Fig.14. Intensity is drawn in arbitrary units, 1 is lamp intensity without filters. This excitation spectrum is optimal for binary PSP produced by OPTROD Ltd.

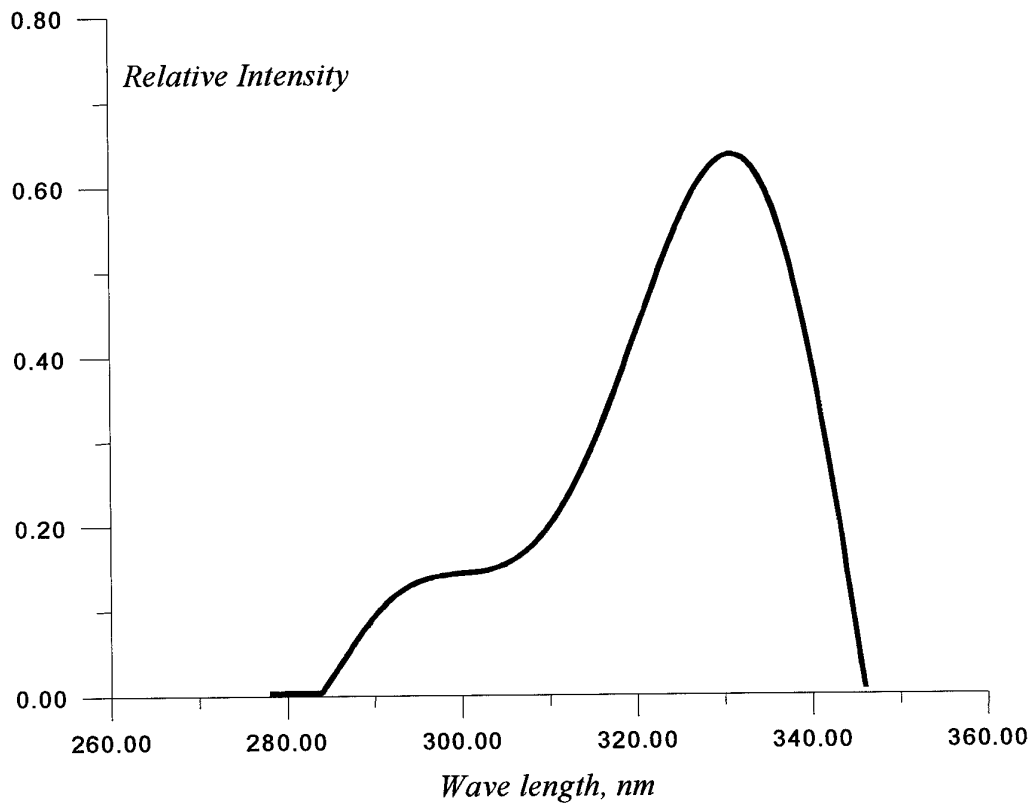

Fig.14. Spectral range of light source output

Evaluation of the Measurement System Components in T-125 Wind Tunnel

T-125 Wind Tunnel

Some new components of measurement system were tested in small transonic wind tunnel. They are receiving optical unit with prism image splitter and flash lamp light source. Tests were performed in the TsAGI's T-125 wind tunnel (see Fig.15). This wind tunnel has cross-section 190x210 mm. Because of specific wind tunnel design, the model was illuminated with excitation light through a side window of 140 mm diameter. Registration of luminescence was performed through the same window.

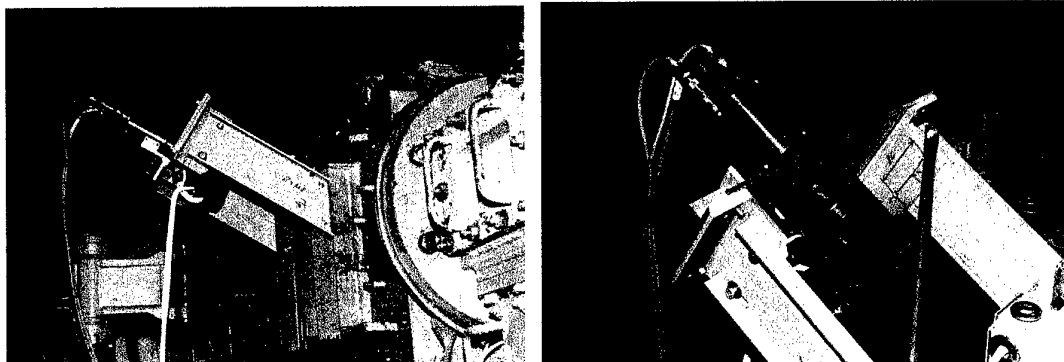
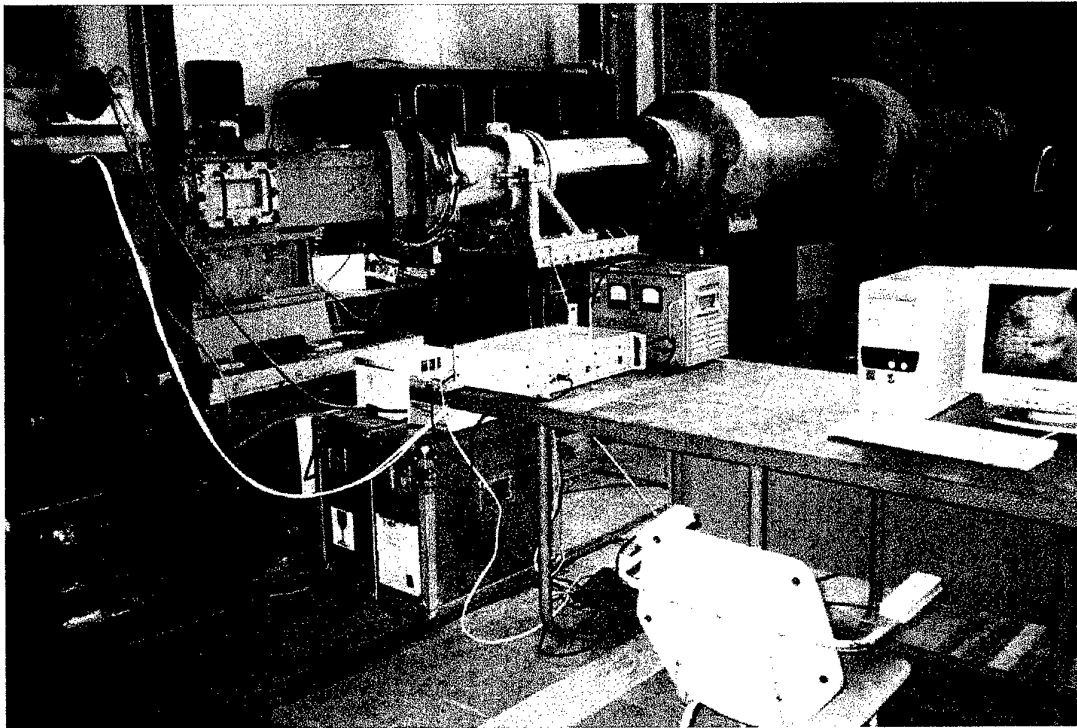

Fig.15. Wind Tunnel T-125 and PSP facility.

The test Model of the Foil

Pressure distribution was measured on airfoil (P-185) model. An upper surfer of the model that has 13 pressure taps and two thermo-sensors was painted by slow response binary luminescent pressure sensor 'LPS B1'. Pressure sensitive paint 'LPS B1' has the same optical properties as the Fast Binary Paint and it can be used to test measurement system. The photo of the model prepared for the tests is shown in Fig. 16. Blue area of the model surface is an area painted with Pressure Sensitive Paint. White strips are the regions of Screen Layer applied before the Sensitive Layer as a base coat. The pressure taps (small dark dots) and the markers (large dark dots) are visible on the model surface. The surface was marked with $5 \times 3 = 15$ markers 2 mm diameter to provide geometrical transformations and alignment of the four images (two wind-off and two wind-on) and the projection of the resulting image on the surface under study during result processing.

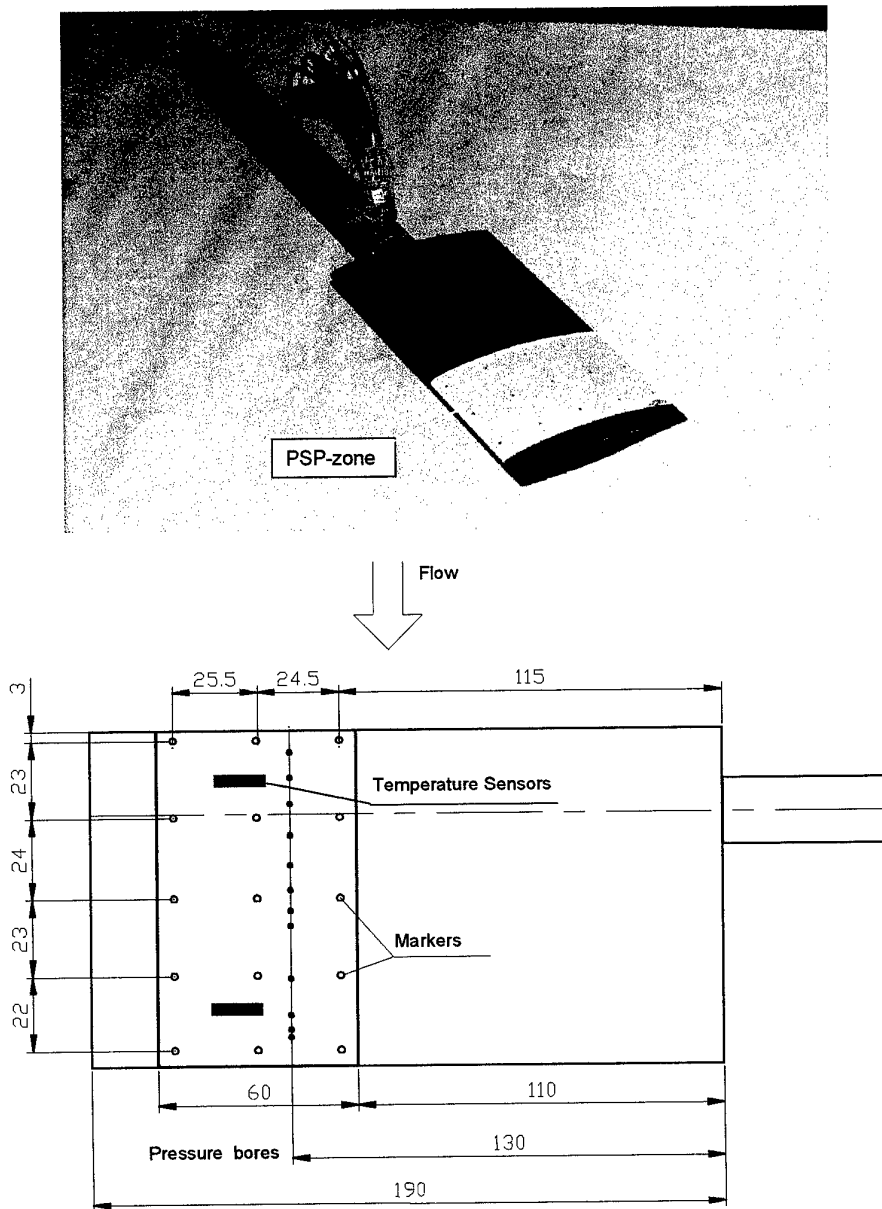

Fig.16. Airfoil model with applied LPS B1 paint.

The pressure distribution was measured for the incident flow with Mach numbers M ranging from 0.4 to 1.1 and at the angles of attack $\alpha = -1 \div 5^\circ$.

The binary PSP images processing

Previously the image to non-standard flat field correction was produced. At first two images created by means opal glass scattered light had separately to both channels been obtained. To establish each one 1000 frames were registered and averaged out. Then two fields of mean sensitivity were combined into one synthetic image. This image (I_3) is shown in item 3 of the frame operations table below.

The background images were periodically acquired during the measurements.

Blue (active) and red (reference) images acquired through prism image splitter are shown in Fig.17. Both images are acquired simultaneously by single camera to one CCD-array during one light flash.

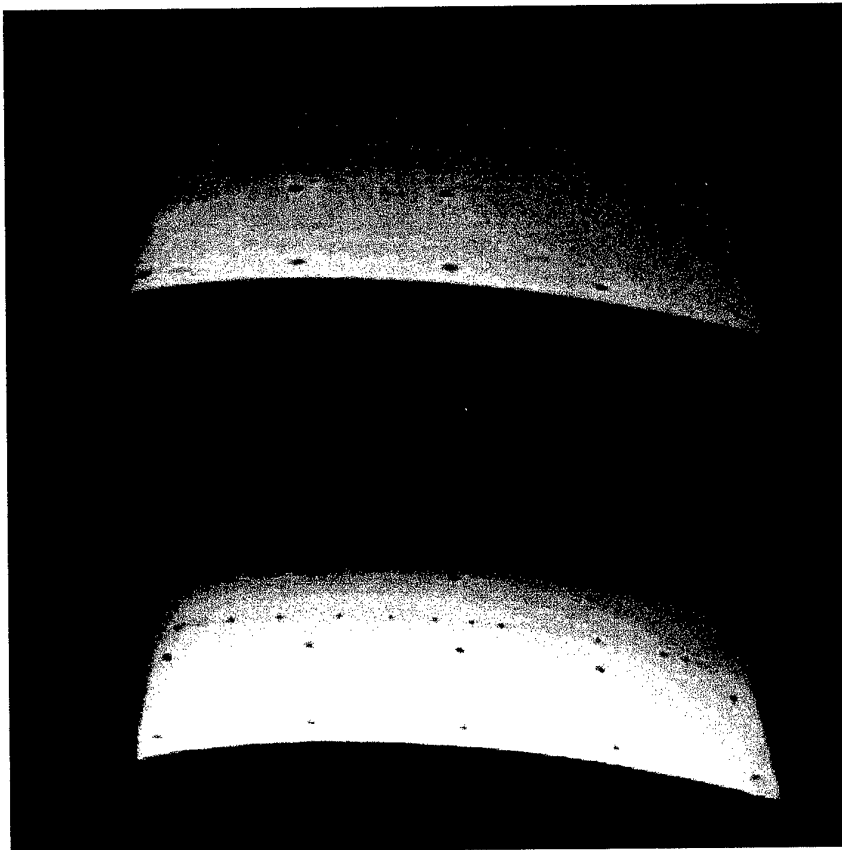
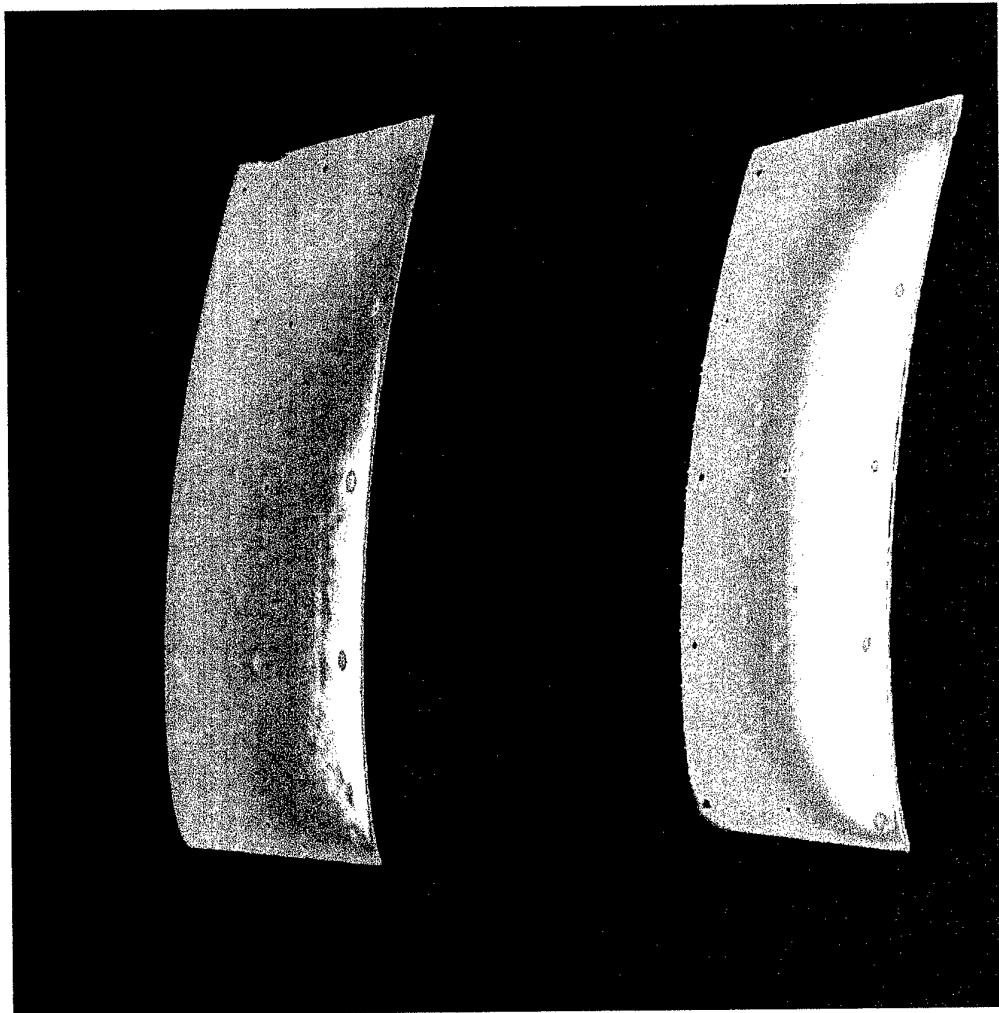

Fig.17. Blue and red images.

The original images

The original image of the model surface covered with binary PSP and registered by prism image splitter contains two equal areas with two similar images. The original image in pseudocolor is represented in Fig. 18. One area holds, the sensitive image (blue channel), another area has the reference image (red channel).





Red channel

Blue channel

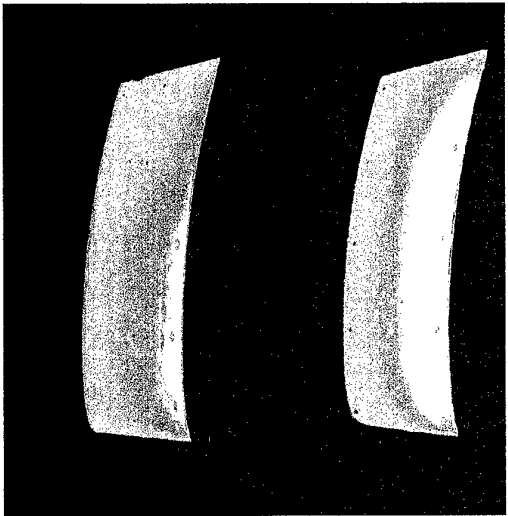
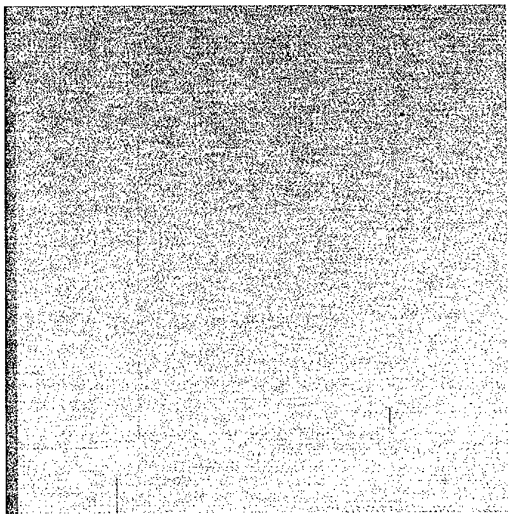
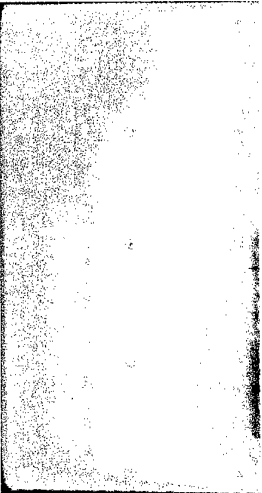
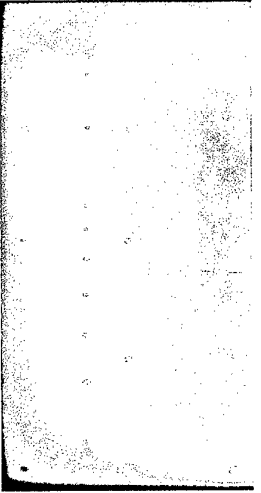
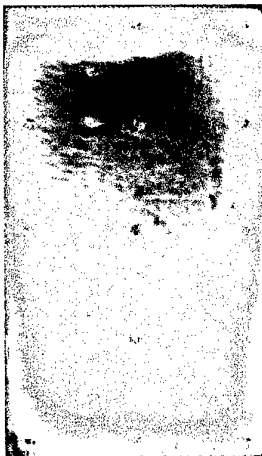

Fig. 18. The original binary PSP image in pseudocolor

The algorithms of PSP images processing have been improved to binary PSP images. The processing of these images consists of the operations with the frames and operations with the channels, i.e. the separated images transforms.

The Frame operations are shown the following activities:

<p>1. Original image digitizing (I_1)</p>	<p>I_1</p>	
<p>2. Dark image (I_2) subtraction</p>	<p>$I_1 - I_2$</p>	
<p>3. Non-standard Flat Field Correction (I_3)</p>	<p>$(I_1 - I_2) / I_3$</p>	

The Channels transforms consist of the following operations:

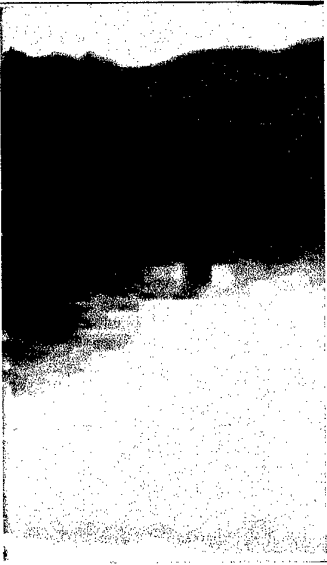
<p>4. Red & Blue images projection on the model and its superposition for Wind-on & Wind-off conditions separately</p>		
<p>5. Rationing of Wind-on to Wind-off images</p>		
<p>6. PSP-calibration including and marker's dints exception and filtration</p>		

Compare and representation

<p>7. Comparison with the taps and other measurements</p>	
<p>8. The presentation and animation</p>	

One of the obtained pressure distributions over the upper surface of the airfoil at $M=1.05$ and $\alpha=4^\circ$ from this evaluation test is shown above. The obtained data agree well with the results of pressure tap measurements.

Test results

This experiment showed that the developed prism image splitter could be effectively used for pressure distribution measurement using two-color pressure paint. The splitter is especially effective when flash lamps are used as excitation light sources.

The test showed the CCD array of 'Photometrics' CH250 camera has low sensitivity to the blue light in comparison with cameras used by us before. To achieve equal intensities for blue and red images special paint preparation is used: red luminophore component was decreased up to three times.

Conclusions

Within this stage of contract the following works are completed:

The Fast Binary Pressure Sensitive Paint (FBPSP) with fast time response is developed. This paint is intended for measurements of pressure distributions on a model of helicopter rotor blade in wind tunnel tests. The characteristics of the FBPSP are investigated. In addition the spatial homogeneity of PSP has been examined. It is shown that the precise alignment of the images during the rationing shall decrease the noise of the pressure distribution significantly.

The scheme of experiment in T-105 wind tunnel with using helicopter devices MVP-5 and MVP-8 is developed and the supporting system for optics is designed. The developed units and blocks to optical system are manufactured.

The offered receiving optical system based on prism image splitter was manufactured and investigated. The splitter is needed for simultaneous registration of both the active (blue) and the reference (red) images on one CCD-array. The second variant intending for an arrangement after a receiving objective lens had been preferred. This variant allows applying a light-impenetrable wall for complete division of red and blue images. This unit has objective lens with a focal length 80 mm. Distance to the tested blade should be about 3 m.

The synchronization unit has been produced. It contains the laser pointer and receiving photodiode (photosynchronizer) and the electronic synchronization unit.

The ultraviolet flash-lamp arrangement providing necessary spectral conditions was developed, manufactured and examined. This lamp has up to 200 J charge energy. The excitation spectrum has been optimized for fast binary PSP.

To process the PSP images it is necessary to superpose two images geometrically, i.e. to establish mathematical functional dependence of coordinates of each point of a surface of the object under test on one image (left) with coordinates of the same point on the other image (right). For this purpose it is necessary to carry out geometrical calibration of receiving optical unit. With this purpose the images of a special grid with a set of markers are registered.

The algorithms and programs of processing of the PSP images was enhanced to binary-type images too.

Receiving optical unit with prism image splitter, flash lamp light source and sync system were tested in T-125 wind tunnel.

The experiment showed:

- Flash lamp with developed filters could be used for binary two-color PSP excitation.
- Developed prism image splitter could be effectively used for pressure distribution measurement using two-color pressure paint.
- The splitter is especially effective when flash lamps are used as excitation light sources.
- CCD array of 'Photometrics' CH250 camera is low sensitive to blue light that require special paint preparation.

Acknowledgement

Significant contributions to the realization of this program are attributed by Dr. W.J.McCroskey (AFD NASA Ames Research Center).