



FINAL REPORT

**MAGNETIC BACKGROUND SURVEY
FOR
UXO AND MINE DETECTION**

Submitted to

**EL-ENVIRON SENSING BRANCH
USACE WATERWAYS**

for

Contract #DACA39-96-M1974

Submitted by

GEOMETRICS, INC.
395 Java Drive
Sunnyvale, CA 94089

30 November 1996

1. Background

Geometrics, with support from Blackhawk Geometrics and AETC, carried out detailed, high resolution magnetic surveys of two sites at Fort A.P. Hill, Virginia and two sites at Fort Carson, Colorado. In addition, time-domain electromagnetic surveys were conducted over portions of the two Fort Carson sites.

The objectives of the program were to:

- Characterize the magnetic background sufficiently over one hectare test areas (100 m x 100 m) to aid in the understanding of the effect of magnetic "clutter" on the detection of buried UXO and landmines;
- Survey over adjacent areas with UXO items and landmines;
- Use the highest possible survey data sampling within the constraints of time and cost.

2. System Description

Three G-858 MagMappers™ with dual Cesium sensors were used for the project. A typical single G-858 unit with dual Cesium sensors configured for UXO detection is shown in Figure 3. Specifications for the G-858 MagMapper are:

Operating Principle: Self-Oscillating Split-Beam Cesium Vapor

Operating Range: 17,000 to 100,000 nT (γ)

Resolution: 0.03 nT peak-to-peak @ 0.1 sec cycle rate

Heading Error: $\leq \pm 0.5$ nT

Gradient Tolerance: $> 20,000$ nT/meter

Data Storage: Nonvolatile RAM with capacity for 8 hrs of Magnetometer, time, event markers, field notes, locations or 3 hrs of dual sensor & GPS at maximum sample rate (10 times/sec)

Data Output: 3 wire RS232 standard serial port

Power Requirements: 12 VDC rechargeable gel cell, 6 hrs for single sensor or 3 hrs for two sensor operation

In addition, another G-858 was operating, with a single cesium sensor, as a magnetic base station. The magnetic base station data were recorded on the internal RAM and exported, via the RS232, for simultaneous recording on an external laptop computer. Batteries were generally changed four times/day and data were downloaded to a laptop computer twice a day - at lunch and at the end of the day. Field procedures and configuration of magnetometers varied slightly at Fort. A.P Hill, Virginia and at Fort Carson, Colorado.

3. Magnetometer Survey at Fort AP Hill, Virginia

3.1 Field Procedure and Sensor Configuration - During the week of October 7, 1996, Geometrics undertook a survey of two sites at Fort AP Hill, Virginia. The two sites were firing point 20 and firing point 22. The operational plan was to collect magnetometer data using the G-858 gradiometer in three modes:

- 1) A horizontal gradiometer with 0.5 meter sensor spacing, 0.5 meter height above the ground, with 1 meter line spacing.
- 2) A horizontal gradiometer with 1.0 meter sensor spacing, 1.0 meter height above the ground, with a two meter line spacing.
- 3) A vertical gradiometer with 0.5 meter sensor spacing, 0.5 meter height to the midpoint between sensors (0.25 meter to lower sensor and 0.75 meter to upper sensor), with a 0.5 meter line spacing.

The original plan was to use two wheeled carts with one gradiometer attached to each, allowing two surveys of each site (each a different configuration) to be done simultaneously. Each survey line was to be located using non-stretchable measuring tapes located at the ends of the lines and at the 50 meter position (middle). A set of three traffic cones were to be used to mark the current line end points and the middle. The three positions would be tagged to the magnetometer data by the operator using location mark keys just as the sensor crossed each cone. A cone mover would follow the two carts uprighing and moving the cones to mark the next survey line.

This plan had to be modified on site because only one cart could be tracked by the laser tracking system. The eventual modified plan consisted of ganging the two carts together and pulling them (instead of pushing). The lead cart had the 0.5 meter horizontal gradiometer while the rear cart had the vertical gradiometer. In addition, we took our spare magnetometer and mounted it on the rear cart to make the 1.0 meter high horizontal gradiometer (Figure 1). Because the line spacing was set at 1.0 meter, we shortened the high horizontal gradiometer spacing to 0.5 meters for maximum resolution. The laser tracking mirror was mounted to the lead cart and all sensor positions measured from that reference point.

Two operators were used to man the 6 sensor cart. The lead operator pulled the system and operated the lower horizontal G-858 gradiometer. Since the lead sensors were behind the lead operator the rear operator would verbally call out to the lead operator to mark each cone position. The rear operator carried two G-858 consoles and walked behind the cart assembly, marking his own positions as his sensors crossed the cones. The cone movers job was unchanged. Positioning accuracy was estimated to be about 50 cm using this method. The magnetometer data logger clock was synchronized with the WES clock at the beginning of each day prior to data collection.

Both sites were surveyed using this setup. 100 % of the assigned areas were surveyed with some time left to reconfigure the system and partially resurvey Firing Point 20. The system was reconfigured so that all six sensors could be mounted onto one cart. The new configuration consisted of three vertical gradiometers with the lower sensors at 0.5 meter height and the upper sensors at 1.0 meter. The three vertical gradiometers were arranged in a triangle looking from the top (see Figure 2) such that the coverage across the survey line had a spacing of 0.25 meters. A triangle configuration was chosen over having sensors mounted in a single vertical plane due to the possibility of interaction between sensors at a spacing of 0.25 meters. To get even side to side coverage the line spacing was reduced from 1.0 to 0.75 meters. We surveyed the first 41 meters of firing point 20 were surveyed with the reconfigured system.

3.2 Brief Outline of Daily Activities -

- Monday, 10/9/96:
- Setup the two wheeled carts, traveled to firing point 22 with carts, setup processing system in trailer and base station at firing point 20.
 - Reconfigure both carts into single vehicle and develop a new survey strategy. Add the spare magnetometer to make a 1.0 meter high horizontal gradiometer.
 - Grid firing point 22 for a 1.0 meter line spacing.
 - Survey the registration and stressing targets.
 - Survey the calibration lanes and part of the main area.
- Tuesday, 10/10/96:
- Continue survey of firing point 22. Survey called off mid morning due to tropical storm Josephine blowing down the laser tracking system's tent.
- Wed., 10/11/96:
- Finish survey of firing point 22 around 1:00 PM.
 - Move to firing point 20 and grid site.
 - Survey the registration and stressing targets.
 - Survey approximately the first 20 meters of firing point 20 in heavy rain.
- Thurs., 10/12/96:
- Finish survey of firing point 20 at 3:30 PM.
 - Reconfigure cart to the triple vertical gradiometer.
- Friday, 10/13/96:
- Survey firing point 20 out to 41.25 meters using a 0.75 meter line spacing.
 - Disassemble and pack system.

3.3 Survey Results - Data from the G-858 DataMappers™ were downloaded at the lunch break and again at the end of the survey day. AETC checked the magnetic data at the trailer on site. The data were checked for data quality and communicated to field operators for possible resurveying, if necessary. No resurveying was required except when the laser tracking device would lose lock on the cart. Sometimes this wasn't noticed until one or more lines had been surveyed. Data processing by AETC after the survey was completed included data clean-up and data formatting.

Data Clean-Up - A portion of time was spent cleaning up the data. This included:

- (a) Removing sensor drop-outs and glitches wherever they occurred; and
- (b) Correcting the time stamps in the base station data. This, unfortunately, had to be done because the console base station data files had large data gaps in them. When resorting to the simultaneously-generated PC base station data files, it was noted that the time stamps were erroneous. Since the base station data were being recorded on both the G-858 and a PC, it was possible to resolve the time stamps and no base station data were lost.

Data Formatting - Most of the time was spent converting the data into the Background Standard Format (BSF) as requested in the Test Plan. There are 38 data (.dat) files, with 38 corresponding header (.hdr) files. These are organized by site - FP20_*. files representing those associated with Firing Point 20; FP22_*. files represent those associated with Firing Point 22. All *_SB*. files surveys taken of the **Side Bars**. In addition, those files labeled *_CS*. represent surveys taken of the **Central Square**; those labeled *_S*. represent surveys taken of the entire **Site**; and those labeled *_HR*. represent **High Resolution** surveys.

Examples of .hdr and .dat files for three different survey modes are shown in Tables 1-3: Magnetometer with across-track resolution of 0.5 m (Table 1); Vertical Gradiometer with across-track resolution of 1.0 m (Table 2); and Vertical Gradiometer with across-track resolution of 0.25 m (Table 3).

The fields in the .hdr files are either defined in the Test Plan or are self-explanatory. Exceptions to this are:

XOFFSET - This provides the x distance (in local coordinates) from the WES prism to each sensor. However, since the WES prism was mounted in such a way that its local x position is given by the values in the column labeled X in the .dat files, this also provides the means to correctly map the sensor values. As an example, to map out the sensor values M1 and M2 in the Magnetometer .dat file, one would have to apply the following translations-

M1: X-XOFFSET (if COG=90), X+XOFFSET (if COG=-90)

M2: X+XOFFSET (if COG=90), X-XOFFSET (if COG=-90)

The columns in the Magnetometer .dat file are defined as follows:

T - Time in seconds since the Start Date indicated in the header file;

X - Local x position (Magnetic E/W) in meters;
Y - Local y position (Magnetic N/S) in meters;
M1 - Left sensor image value as determined by the Formula in the header file. In this case, for example, it is the left sensor reading minus the base station (reference) reading. This result is then subtracted by the median value of all the data (i.e. both sensors);
M2 - Right sensor image value as determined by the Formula in the header file;
COG - Course Over Ground in degrees from positive X axis (+90 points in the direction of increasing Y; -90 points in the direction of decreasing Y);
MRAW1 - Left sensor reading in nanoTesla;
MRAW2 - Right sensor reading in nanoTesla; and
MREF - Base Station reading (synchronized and interpolated to T) in nanoTesla.

The columns in the Vertical Gradiometer .dat files are defined as follows:

T,X,Y, COG and MREF - same as above;
M1 - Image value as determined by the Formula in the header file. In this case, the top sensor reading is subtracted from the bottom sensor reading. This result is then subtracted by the median value;
MRAW1 - Bottom sensor reading in nanoTesla; and
MRAW2 - Top sensor reading in nanoTesla.

Image Generation - Images for each data file were generated to not only serve as a visual guide of what was covered, but also as a data quality check. Each image contains the data file name from which it was generated, the survey mode, and small description of the survey. The Y-axis here is Geographical N/S (Note the chosen sites are aligned along Magnetic N/S). An image of the combined High Resolution Surveys (i.e. All *_HR*.dat files) is also included. Images of Firing Point 22, Data from FP22_CS4.dat through FP22_CS4.dat and FP22_SB5.dat are shown in Figure 6 for the Magnetic survey at a sensor height of 1.0 m. The same area with the sensor height of 0.5 m is shown in Figure 7. The gradient survey for the same area is shown in Figure 8. Figure 9 is the image for Firing Point 20 for the magnetic survey at 1.0 m height. Figure 10 shows the image for FP20 for 0.5 m height and Figure 11 the gradient for FP20.

4. Magnetometer Survey at Fort Carson, Colorado

4.1 Field Procedure and Sensor Configuration - Two sites at Fort Carson were surveyed during the week of November 4, 1996, a few weeks after the survey at Fort A.P. Hill, Virginia. A few changes were made in the survey setup and procedure based on our experience from Fort A.P. Hill (see Section 3.1), and based on available time:

- 1) We put all six magnetometer sensors on one cart instead of distributed across two ganged carts (see Figures 4 and 5).
- 2) We arranged the sensors such that we had two horizontal gradiometers (one directly above the other at 0.5 and 1.0 meter heights), and one vertical

gradiometer (also at 0.5 and 1.0 meter heights). The height of the vertical gradiometer sensors were raised from the 0.25/0.75 meter configuration used for the Fort A.P. Hill survey due to the magnetic geologic background noise experienced at Fort Carson.

- 3) A pickle switch was constructed to allow the rear operator to enter position marks to both G-858 consoles simultaneously with a single button.
- 4) A backpack was used to carry the two battery packs for the rear operator. At Fort A.P. Hill one of the two battery packs was worn like a bandolier (painful after a while).
- 5) The front operator marked his position by turning around and observing his sensors passing the cones rather than verbal cues from the rear operator.
- 6) Position marks were done at 25 meter intervals rather than 50 meters. This doubled the number of absolute position fixes and reduced the amount of deviation off line between marks.
- 7) Because the three gradiometers were forming a matrix three sensors wide and 0.25 meters between, we changed the survey line spacing from 1.0 meters to 0.75 meters to get an even 0.25 meter coverage over the entire survey area.
- 8) After completing the magnetometer surveys, additional surveys were done using a Geonics EM61.

No power was available at Fort Carson, therefore the processing center was setup in a hotel rooms (about 20 miles away). Data were picked up at the survey site at noon and delivered to the hotel at the end of the day. The base station data were logged into G-858 internal memory and to a laptop powered by a 12 volt deep cycle marine battery and 12 VDC to 115 VAC inverter.

Two operators were used to man the 6 sensor cart. The lead operator pulled the sensor cart and marked his position by turning around and observing his sensors passing the cones rather than verbal cues from the rear operator. The rear operator carried two G-858 consoles and walked behind the cart assembly, marking his own positions as his sensors crossed the cones. A set of five traffic cones were used to mark the current line end points and the three 25 meter marks between the end points. The five positions were tagged to the magnetometer data by the operator using location mark keys just as the sensor crossed each cone. A cone mover followed the two carts uprighting and moving the cones to mark the next survey line. Positioning accuracy was estimated to be about 20 cm with the 25 meter cone intervals. Both sites were surveyed using this setup. 100 % of the assigned areas were surveyed with some time left to set up a Geonics EM-61 and partially survey 30 meters of the Seabee and 70 meters of the Turkey Creek sites. The magnetometer data logger clock was synchronized with the WES clock at the beginning of each day prior to data collection and once per hour after that.

4.2 Brief Outline of Daily Activities -

- Monday, 11/4/96:
- Setup magnetometer cart with six sensors as per Figures 4 and 5.
 - Set up base station.
 - Grid the Seabee site.
 - Survey registration and stressing targets at the Seabee site.
 - Survey approximately the first 60 meters at 0.75 meter line spacing.
- Tuesday, 11/5/96:
- Finish survey of Seabee site (including redo of some calibration lanes).
 - Move to Turkey Creek and grid site.
 - Reconfigure cart to raise laser tracking mirror 12 inches (to avoid losing lock in ravine).
 - Setup Base Station.
 - Survey registration and stressing targets
- Wednesday, 11/6/96:
- Survey entire site (0-125 meters at 0.75 meter line spacing).
- Thursday, 11/7/96:
- Redo Calibration lanes (0-15, 120-125 meters).
 - Redo lines around area where barbed wire tangled in cart and was dragged for some distance.
 - Move to Seabee site and redo line at 101.5 meters (One magnetometer had dropped readings due to dead battery).
 - Survey extra calibration side bars (5-15 meters).
 - Set up EM61.
 - Survey EM61 until memory full (about 30 meters, at 0.75 meter line spacing).
- Friday, 11/8/96:
- Setup at Turkey Creek. Ran EM61 until both of two recorder units were full (0 to about 70 meters).
 - Pack up systems and ship.

4.3 Survey Results - Data from the G-858 DataMappers™ were downloaded at the lunch break and again at the end of the survey day. AETC checked the magnetic data at the hotel room about 20 miles away since there was no trailer on site where a computer could be setup. The data were checked for data quality and communicated to field operators for possible resurveying, if necessary. No resurveying was required. Data processing by AETC after the survey was completed included data clean-up and data formatting. As with the Fort A.P. Hill magnetometer data (Section 3.3), three steps were taken to produce the final Fort Carson deliverable. These were: Data Cleanup; Data Formatting; and Image Generation.

The details were described in Section 3.3. Notable exceptions are:

- (1) The base station data did not contain timing errors, thus no correcting had to be done here. The dates in all the data files, however, were still off by one day which was easily corrected.
- (2) There are now 30 data (.dat) files, with 30 corresponding header (.hdr) files. These are organized by site - SB_*. files represent those associated with the Seabee site; TC_*. files represent those associated with the Turkey Creek site. All *S*. files represent surveys taken of the Site; those labeled *SB*. represent survey taken of the Side Bars; and those labeled *S*A.* represent re-surveys of the site. The three sensor configurations are delineated as follows: *_LH*. for the Low Horizontal pair of sensors; and *_V*. for the Vertical pair of sensors, or gradiometer configuration.
- (3) All images of the data show clear signs of directional offsets (i.e. vertical streaks). The difference in offsets in going from north to south is on the order of a nT which is within the heading error specifications of the G-858 sensor. The Z's in the .dat files **have been corrected for this** by subtracting the corresponding directional offsets from each sensor as specified by the formulae in the .hdr files. (Note: The images provided (Figures 12-17) **do not** show these corrected data).

Image Generation - The Y-axis here is Geographical N/S. Images of Seabee are shown in Figure 12 for the Magnetic survey at a sensor height of 1.0 m. The same area with the sensor height of 0.5 m is shown in Figure 13. The gradient survey for the same area is shown in Figure 14. Figure 15 is the image for Turkey Creek for the magnetic survey at 1.0 m height. Figure 16 shows the image for FP20 for 0.5 m height and Figure 17 the gradient for Turkey Creek.

5. EM-61 Survey at Fort Carson

EM-61 data were collected at the Seabee and Turkey Creek site. This was beyond the original scope of the program, but because the magnetic data collection data was completed early, it was decided to collect EM61 data. Blackhawk Geometrics is a geophysical survey company and has EM61's in their equipment pool. Since Blackhawk Geometrics offices are in Golden, Colorado, less than 2 hours drive north of Fort Carson, it was relatively easy to have an EM61 brought to Fort Carson.

5.1 Field Procedure and Sensor Configuration - The time-domain electromagnetic data were collected with the Geonics EM61 Time Domain High Resolution Metal Detection System utilizing a 1 meter transmitter coil and two 1 meter receiver coils. Data were collected along survey lines paced 0.75 meters apart with sample location every 0.19 meters along the survey lines. Approximately 28% of the Seabee site and 56% of the Turkey Creek site were surveyed. Figures 18 and 19 show the survey lines for the two sites.

At both the Seabee and Turkey Creek sites data were collected over areas whose boundaries were set by DARPA and marked every 5 meters along the site perimeter. Blackhawk Geometrics marked survey lines on the ground with paint at 0.75 meter intervals. Data were collected utilizing an odometer system with the EM61. The X,Y, position of each data point, time the data sample was taken, and the reading in millivolts from induction coil 1 and induction coil 2 were recorded in a data logger. The EM61 data logger clock was synchronized with the WES clock prior to data collection. Time synchronization was checked periodically during the survey.

The physical setup of the EM61 one meter coil system is shown in Figure 20. The lower coil (channel 2 coil) is located 43 cm above the ground. Both the transmitter coil and a receiver coil are contained within this portion of the system. The upper coil (Channel 1 coil) is located 43 cm above the lower coil. The output from both systems is in EM61 millivolts. The upper coil has a factory set gain of 2.8 times greater relative to the lower coil. The gains of both coils cannot be changed by the operator. The technical specifications of the EM61 system are shown in Table 4.

The data from the EM61 were recorded in a data logger at 0.19 meter intervals between the readings. Data acquisition was controlled by an odometer with the wheel assembly. The prism center for the WES laser tracking system was located directly above the center of the two coils approximately 12.7 cm above the plane of the upper coil.

5.2 EM61 Results - The EM61 data is reported in millivolts. A D.C. bias is present in the data from both coils. This bias is related primarily to the system electronics. The only processing done to the data is to remove the system bias from Channel 1 and Channel 2 data. This results in a system background reading of approximately 0 for both coils in the absence of metal. Approximately 1 to 2 millivolts of background variation due to geology is present in the data. Figures 21 through 24 show color contour maps of the debiased EM61 data for Channels 1 and 2 at the Seabee and Turkey Creek sites respectively. Background readings (<2 millivolts) show as dark blue, while areas underlain by metal objects appear as light blue to pink depending on the magnitude of the anomaly.

The EM61 data from the Seabee site is contained in T, X, Z1, Z2 files SB1EM61.DAT and SB2EM61.DAT. The portion of the survey areas contained in each file is shown in Figure 18. The data from the Turkey Creek site is contained in the files TC1EM61.DAT through TC4EM61.DAT in the same file format. Figure 19 outlines the portion of the survey area within each data file.

Table 1

Contractor Name: Geometrics
 Sensor: Magnetometer
 Start Date: 09:OCT:1996:1400:39:02.6
 End Date: 09:OCT:1996:1600:16:50.7
 Site Name: Firing Point 20 ;Entire Survey (Part 1)
 IXRES: 50 ;cm sensor separation
 IYRES: 12 ;cm along track
 Site Survey File:
 System Reference: "G858 Magmapper" p/n 25309-OM rev B.
 XOFFSET: 0.25 ;m to both sensors (+ or - depending on Course Over Ground (COG))
 YOFFSET: 0.0 ;m to both sensors
 SyncTime: 0.0 ;sec
 Survey Mode: Mapped survey, continous acquire, bidirectional lines along Y axis (Magnet
 Line Spacing: 1.0 ;m
 Mark spacing (Y =): 0,50,100 ;m
 Map Settings (X,Y): 0,0 to 125,100 ;m
 Cycle Time: 0.1 ;sec
 Sensor Height: 0.5 ;m above ground for both sensors
 NumZ: 2
 ZDESC: Z1:M1:left sensor relative to COG
 Formula: M1 = (MRAW1 - MREF) - MEDIAN ;units of nT
 ZDESC: Z2:M2:right sensor relative to COG
 Formula: M2 = (MRAW2 - MREF) - MEDIAN ;units of nT
 END

T	X	Y	M1	M2	COG	MRAW1	MRAW2	MREF
0.0	0.000	0.000	1020.158	1252.177	90	54492.268	54724.287	53474.451
0.1	0.000	0.112	1035.831	1267.189	90	54507.941	54739.299	53474.451
0.2	0.000	0.225	1064.700	1291.769	90	54536.810	54763.879	53474.451
0.3	0.000	0.337	1111.474	1330.715	90	54583.585	54802.826	53474.451
0.4	0.000	0.449	1180.398	1388.009	90	54652.509	54860.120	53474.451
0.5	0.000	0.562	1270.068	1464.241	90	54742.179	54936.352	53474.451
0.6	0.000	0.674	1377.440	1548.705	90	54849.551	55020.816	53474.452
0.7	0.000	0.787	1507.064	1632.293	90	54979.175	55104.404	53474.452
0.8	0.000	0.899	1660.946	1713.833	90	55133.057	55185.944	53474.452
0.9	0.000	1.011	1824.331	1796.061	90	55296.442	55268.172	53474.452
1.0	0.000	1.124	1990.270	1862.455	90	55462.381	55334.566	53474.452
1.1	0.000	1.236	2143.982	1912.427	90	55616.093	55384.538	53474.452
1.2	0.000	1.348	2274.409	1933.991	90	55746.520	55406.102	53474.452
1.3	0.000	1.461	2375.723	1928.813	90	55847.834	55400.924	53474.452
1.4	0.000	1.573	2438.455	1893.043	90	55910.566	55365.154	53474.452
1.5	0.000	1.685	2393.885	1790.739	90	55865.996	55262.850	53474.452
1.6	0.000	1.798	2227.903	1626.016	90	55700.014	55098.127	53474.452
1.7	0.000	1.910	1909.547	1390.494	90	55381.658	54862.605	53474.452
1.8	0.000	2.022	1512.520	1105.246	90	54984.631	54577.357	53474.452
1.9	0.000	2.135	1065.417	782.166	90	54537.528	54254.277	53474.452
2.0	0.000	2.247	641.910	450.323	90	54114.021	53922.434	53474.452
2.1	0.000	2.360	286.261	145.264	90	53758.372	53617.375	53474.452
2.2	0.000	2.472	10.544	-102.882	90	53482.655	53369.229	53474.452
2.3	0.000	2.584	-171.265	-274.134	90	53300.847	53197.978	53474.452
2.4	0.000	2.697	-286.332	-391.367	90	53185.780	53080.745	53474.452
2.5	0.000	2.809	-346.552	-464.497	90	53125.560	53007.615	53474.452
2.6	0.000	2.921	-359.877	-496.542	90	53112.235	52975.570	53474.453
2.7	0.000	3.034	-345.759	-495.787	90	53126.353	52976.325	53474.453
2.8	0.000	3.146	-305.978	-472.515	90	53166.134	52999.597	53474.453
2.9	0.000	3.258	-254.884	-438.621	90	53217.228	53033.491	53474.453
3.0	0.000	3.371	-208.987	-395.998	90	53263.125	53076.114	53474.453

Table 2

Contractor Name: Geometrics
 Sensor: Magnetometer ;Vertical Gradiometer Configuration (0.5m separation)
 Start Date: 09:OCT:1996:1400:39:04.6
 End Date: 09:OCT:1996:1600:01:29.5
 Site Name: Firing Point 20 ;Entire Site (Part 1)
 IXRES: 100 ;cm sensor separation
 IYRES: 12 ;cm along track
 Site Survey File:
 System Reference: "G858 Magmapper" p/n 25309-OM rev B.
 XOFFSET: 0.0 ;m to both sensors
 YOFFSET: 2.09 ;m to both sensors (+ or - depending on Course Over Ground (COG))
 SyncTime: 0.0 ;sec
 Survey Mode: Mapped survey, continous acquire, bidirectional lines along Y axis (Magnet
 Line Spacing: 1.0 ;m
 Mark spacing (Y =): 0,50,100 ;m
 Map Settings (X,Y): 0,0 to 125,100 ;m
 Cycle Time: 0.1 ;sec
 Sensor Height: 0.25 ;m above ground for lower sensor
 NumZ: 1
 ZDESC: Z1:M1:bottom sensor minus top sensor
 Formula: M1 = (MRAW1 - MRAW2) - MEDIAN ;units of nT
 END

T	X	Y	M1	COG	MRAW1	MRAW2	MREF
0.0	0.000	0.000	604.335	90	54842.554	54241.062	53474.452
0.1	0.000	0.115	726.190	90	55082.141	54358.794	53474.452
0.2	0.000	0.229	838.576	90	55302.272	54466.539	53474.452
0.3	0.000	0.344	944.363	90	55495.261	54553.741	53474.452
0.4	0.000	0.459	1066.720	90	55711.673	54647.796	53474.452
0.5	0.000	0.573	1205.393	90	55945.364	54742.814	53474.452
0.6	0.000	0.688	1336.139	90	56151.910	54818.614	53474.453
0.7	0.000	0.803	1448.679	90	56315.661	54869.825	53474.453
0.8	0.000	0.917	1549.813	90	56446.750	54899.780	53474.453
0.9	0.000	1.032	1600.293	90	56495.627	54898.177	53474.453
1.0	0.000	1.147	1547.963	90	56393.524	54848.404	53474.453
1.1	0.000	1.261	1364.161	90	56125.434	54764.116	53474.453
1.2	0.000	1.376	1059.351	90	55682.874	54626.366	53474.453
1.3	0.000	1.491	608.345	90	55075.685	54470.183	53474.453
1.4	0.000	1.606	167.537	90	54444.279	54279.585	53474.453
1.5	0.000	1.720	-235.708	90	53848.595	54087.146	53474.453
1.6	0.000	1.835	-565.546	90	53325.708	53894.097	53474.453
1.7	0.000	1.950	-776.677	90	52940.785	53720.305	53474.453
1.8	0.000	2.064	-865.523	90	52705.904	53574.270	53474.453
1.9	0.000	2.179	-888.350	90	52562.051	53453.244	53474.453
2.0	0.000	2.294	-856.775	90	52502.540	53362.158	53474.453
2.1	0.000	2.408	-795.180	90	52494.251	53292.274	53474.453
2.2	0.000	2.523	-715.933	90	52526.196	53244.972	53474.453
2.3	0.000	2.638	-626.765	90	52590.331	53219.939	53474.453
2.4	0.000	2.752	-530.636	90	52683.038	53216.517	53474.453
2.5	0.000	2.867	-445.873	90	52767.733	53216.449	53474.453
2.6	0.000	2.982	-367.901	90	52855.813	53226.557	53474.454
2.7	0.000	3.096	-301.871	90	52942.164	53246.878	53474.454
2.8	0.000	3.211	-240.633	90	53028.341	53271.817	53474.454
2.9	0.000	3.326	-187.774	90	53101.658	53292.275	53474.454
3.0	0.000	3.440	-144.235	90	53165.776	53312.854	53474.454

Table 3

Contractor Name: Geometrics
 Sensor: Magnetometer ;Left Rear Vertical Gradiometer Configuration (0.5m separation)
 Start Date: 11:OCT:1996:0900:22:41.8
 End Date: 11:OCT:1996:1100:09:42.0
 Site Name: Firing Point 20 ;Part of Site (High Resolution Survey)
 IXRES: 25 ;cm sensor separation (result by combining all FP20_HR* data files!)
 IYRES: 12 ;cm along track
 Site Survey File:
 System Reference: "G858 Magmapper" p/n 25309-OM rev B.
 XOFFSET: 0.25 ;m to both sensors (+ or - depending on Course Over Ground (COG))
 YOFFSET: 0.47 ;m to both sensors (+ or - depending on Course Over Ground (COG))
 SyncTime: 0.0 ;sec
 Survey Mode: Mapped survey, continous acquire, bidirectional lines along Y axis (Magnet
 Line Spacing: 0.75 ;m
 Mark spacing (Y =): 0,50,100 ;m
 Map Settings (X,Y): 0,0 to 125,100 ;m
 Cycle Time: 0.1 ;sec
 Sensor Height: 0.5 ;m above ground for lower sensor
 NumZ: 1
 ZDESC: Z1:M1:bottom sensor minus top sensor
 Formula: M1 = (MRAW1 - MRAW2) - MEDIAN ;units of nT
 END

T	X	Y	M1	COG	MRAW1	MRAW2	MREF
0.0	0.000	0.000	558.562	90	54611.558	54053.093	53466.060
0.1	0.000	0.149	672.849	90	54801.281	54128.529	53466.060
0.2	0.000	0.299	801.777	90	55000.682	54199.002	53466.060
0.3	0.000	0.448	961.910	90	55229.154	54267.341	53466.060
0.4	0.000	0.597	1128.800	90	55444.883	54316.180	53466.060
0.5	0.000	0.746	1286.436	90	55636.435	54350.096	53466.060
0.6	0.000	0.896	1392.209	90	55747.033	54354.921	53466.060
0.7	0.000	1.045	1406.210	90	55724.847	54318.734	53466.060
0.8	0.000	1.194	1272.283	90	55508.642	54236.456	53466.060
0.9	0.000	1.343	958.073	90	55075.639	54117.663	53466.060
1.0	0.000	1.493	549.480	90	54534.793	53985.410	53466.060
1.1	0.000	1.642	161.051	90	54000.826	53839.872	53466.060
1.2	0.000	1.791	-108.331	90	53587.733	53696.161	53466.060
1.3	0.000	1.940	-243.632	90	53328.475	53572.204	53466.060
1.4	0.000	2.090	-279.914	90	53204.525	53484.536	53466.060
1.5	0.000	2.239	-262.956	90	53166.086	53429.139	53466.060
1.6	0.000	2.388	-217.106	90	53180.650	53397.853	53466.060
1.7	0.000	2.537	-147.511	90	53240.173	53387.781	53466.060
1.8	0.000	2.687	-86.448	90	53302.482	53389.027	53466.060
1.9	0.000	2.836	-43.433	90	53347.834	53391.364	53466.060
2.0	0.000	2.985	-6.122	90	53395.387	53401.606	53466.060
2.1	0.000	3.134	28.336	90	53446.498	53418.259	53466.060
2.2	0.000	3.284	47.914	90	53480.363	53432.546	53466.060
2.3	0.000	3.433	56.810	90	53496.724	53440.011	53466.060
2.4	0.000	3.582	60.237	90	53504.565	53444.425	53466.060
2.5	0.000	3.731	64.843	90	53511.997	53447.251	53466.060
2.6	0.000	3.881	70.528	90	53516.721	53446.290	53466.060
2.7	0.000	4.030	76.677	90	53519.577	53442.997	53466.060
2.8	0.000	4.179	76.935	90	53514.273	53437.435	53466.060
2.9	0.000	4.328	62.291	90	53492.619	53430.425	53466.060
3.0	0.000	4.478	33.175	90	53456.749	53423.671	53466.060

Table 4

4. Technical Specifications

Measured Quantity	:	Two channels of secondary response in mV
EM Source	:	Air-cored coil, 1 x 1 m size
Current Waveform	:	Bipolar rectangular current with 50% duty cycle
Repetition Rate	:	75 Hz
EM Sensors	:	a) Main: Air-cored coil, 1 x 1 m in size, coincident with EM source
	:	b) Focussing: Air-cored coil, 1 x 1 m in size 40 cm above main coil
Time Gate	:	0.4 ms wide, starting 0.45 ms after pulse
Dynamic Range	:	18 bits
Display	:	4-line LCD with 16 characters per line
Data Storage	:	Solid-state memory for up to 10000 records
Power Supply	:	12 V rechargeable battery for 5 h continuous operation
Operating Weight & Dimensions	:	Backpack: 10 kg; Coil Assembly: 13 kg Backpack: 60 x 30 x 10 cm Coil: a) Main: 100 x 100 x 5 cm b) Focussing: 100 x 100 x 2 cm
Shipping Weight & Dimensions	:	61 kg (86 kg with trailer) 104 x 104 x 22 cm (Box 1) 54 x 54 x 52 cm (Box 2) with trailer option only

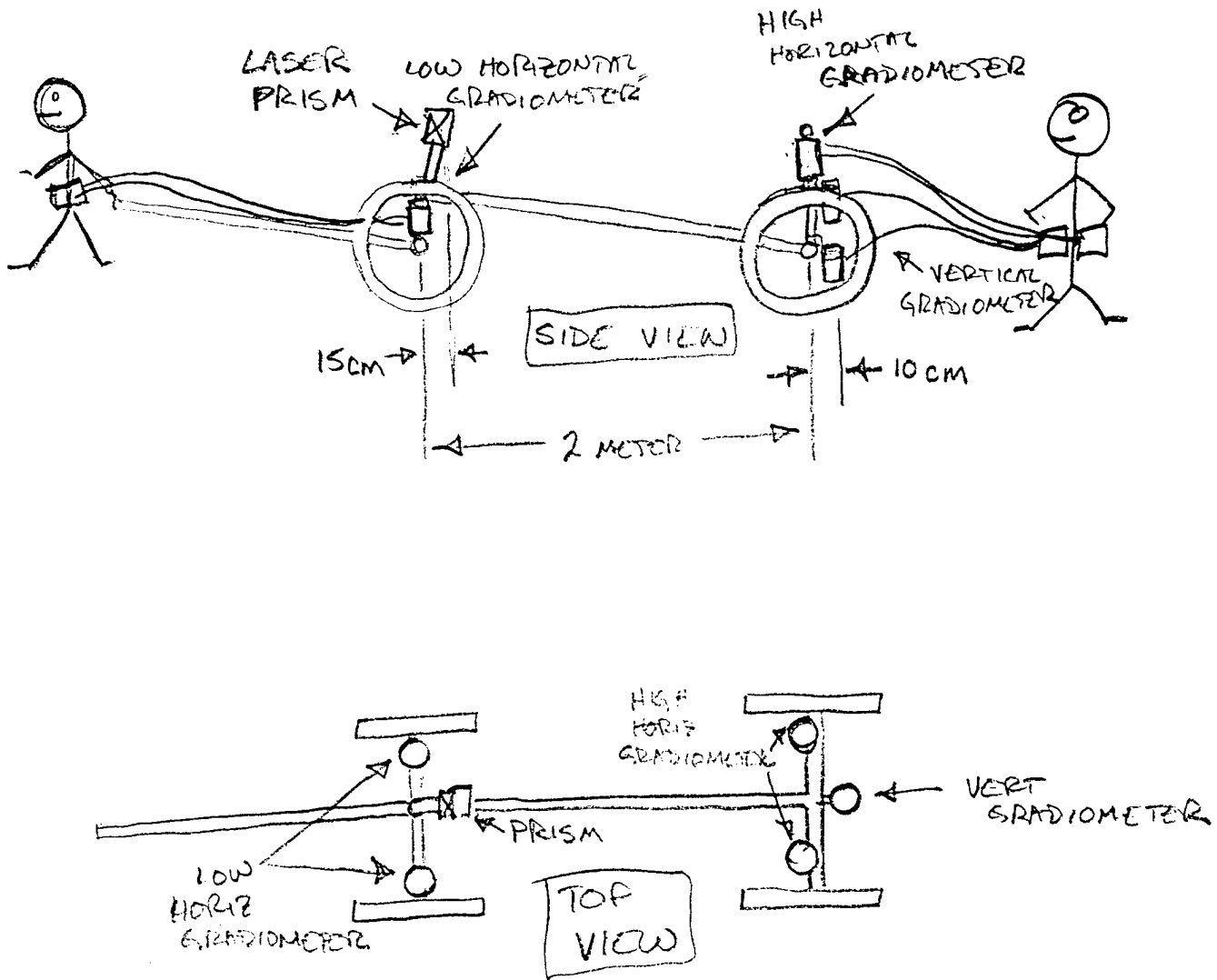

Figure 1

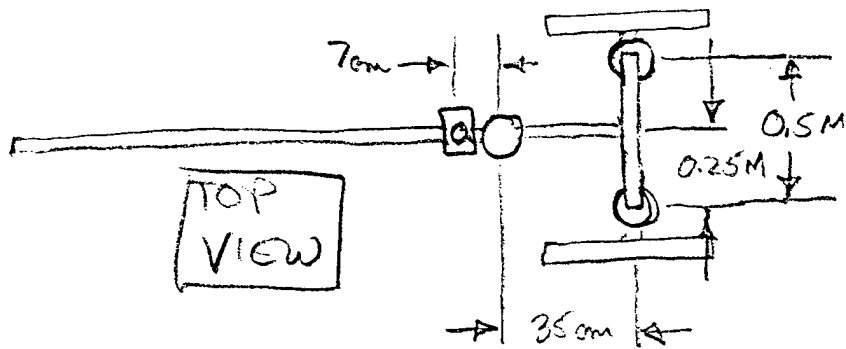
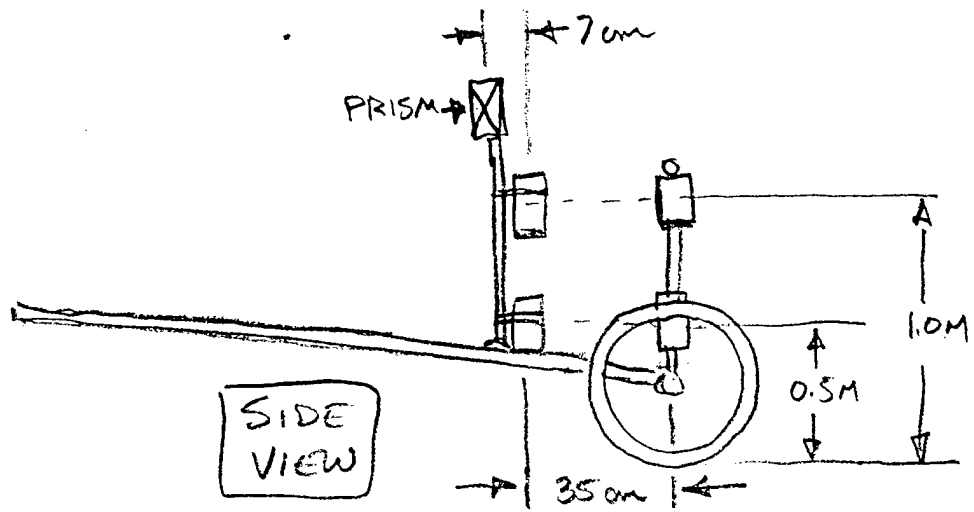

Figure 2

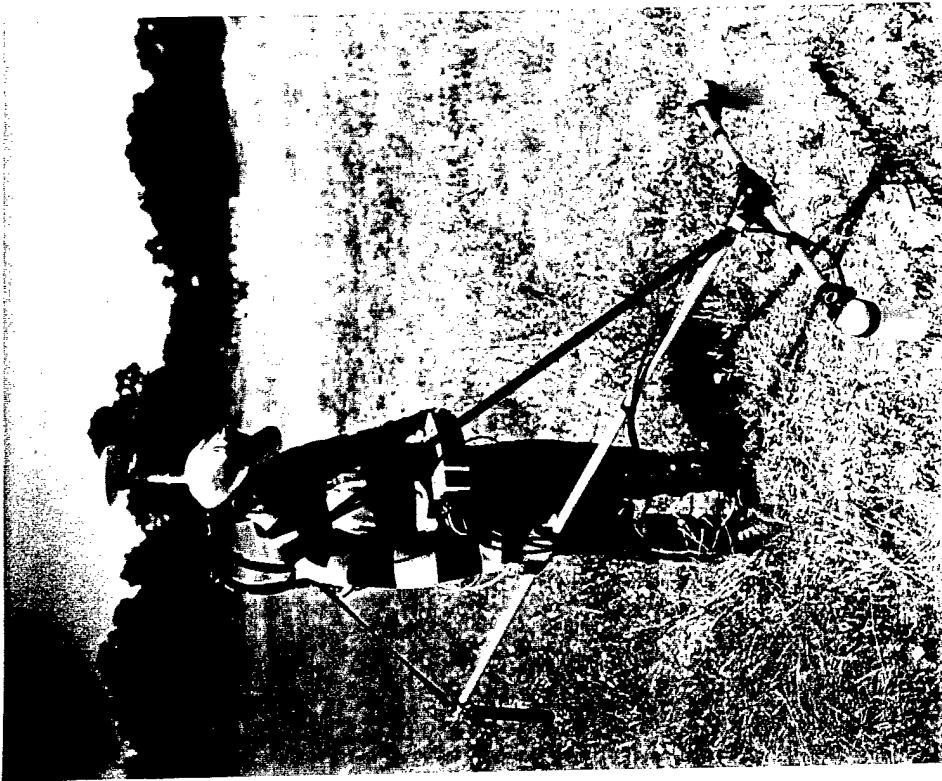
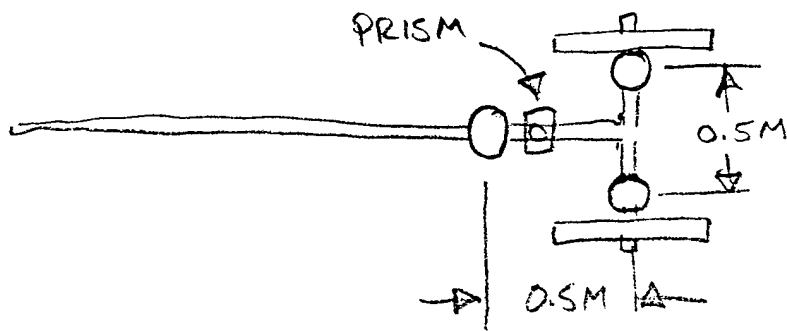
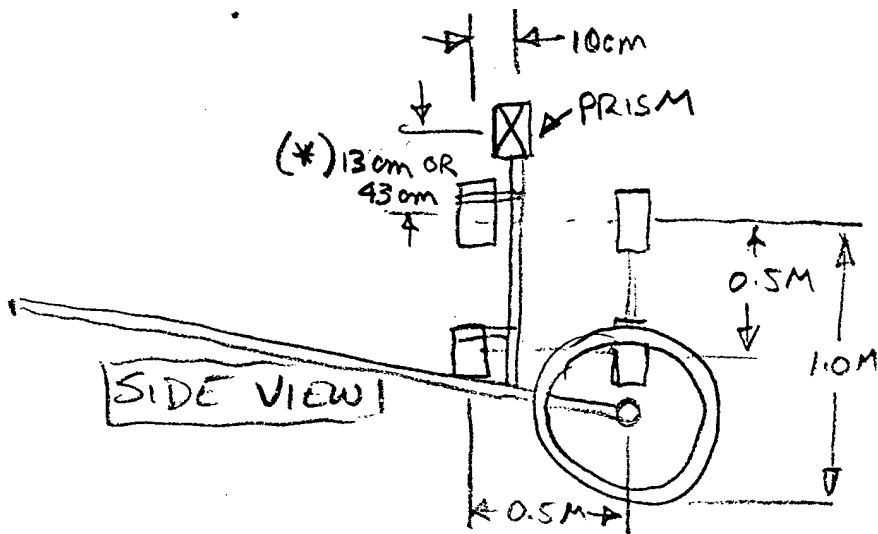

Figure 3: MagMapper™ Field Deployment with GPS.



Figure 4: Four Sensor MagMapper™ Field Deployment with Cart



(*) PRISM HEIGHT RAISED FOR TURKEY CREEK & 2' CWD PASS OVER SEA BEE

Figure 5

FT. APHILL - FIRING POINT 22

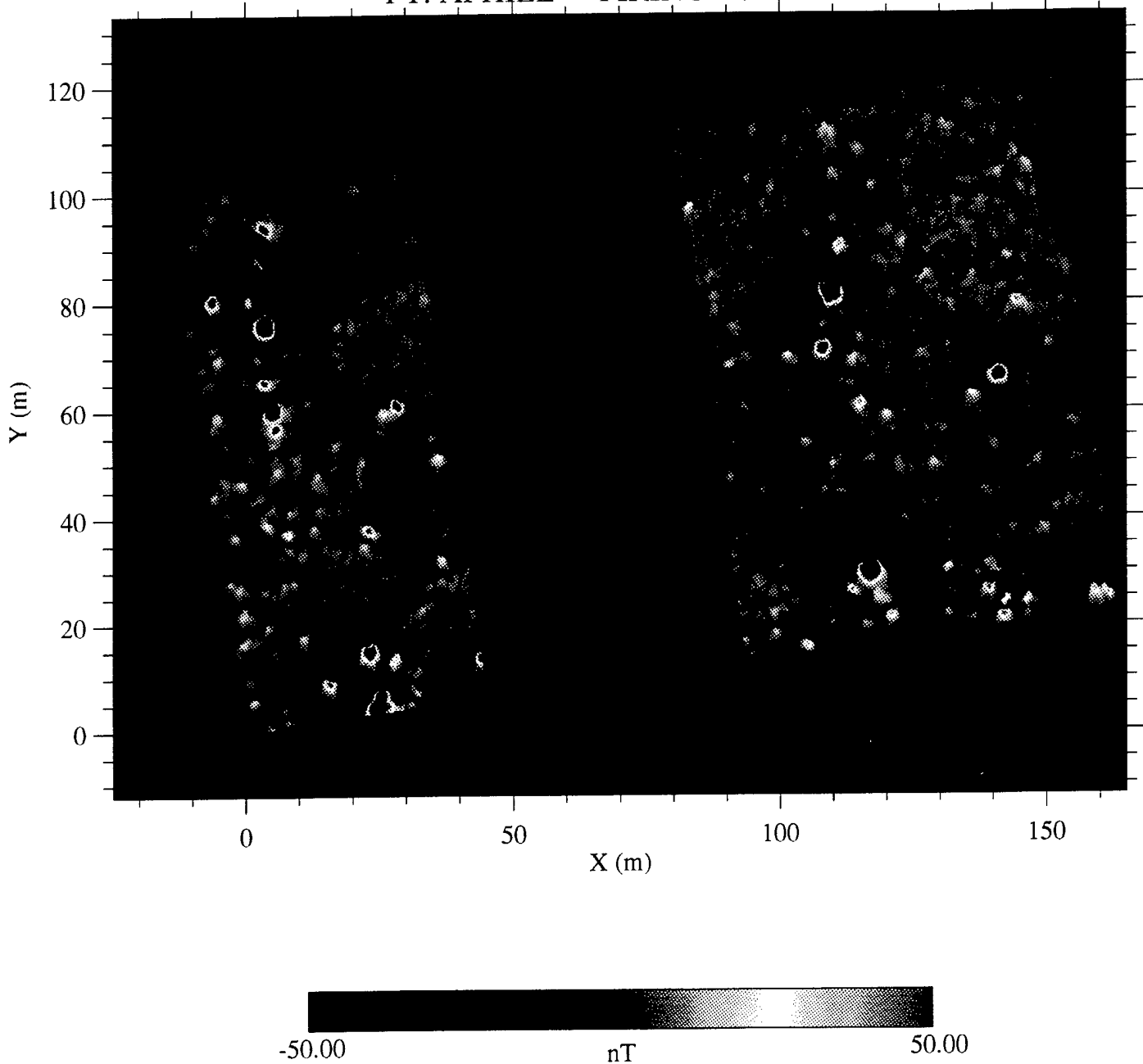

Mag survey at a sensor height of 1.0m (Data from FP22_CS4.dat - FP22_CS6.dat & FP22_SB5.dat)

Figure 6

FT. APHILL - FIRING POINT 22

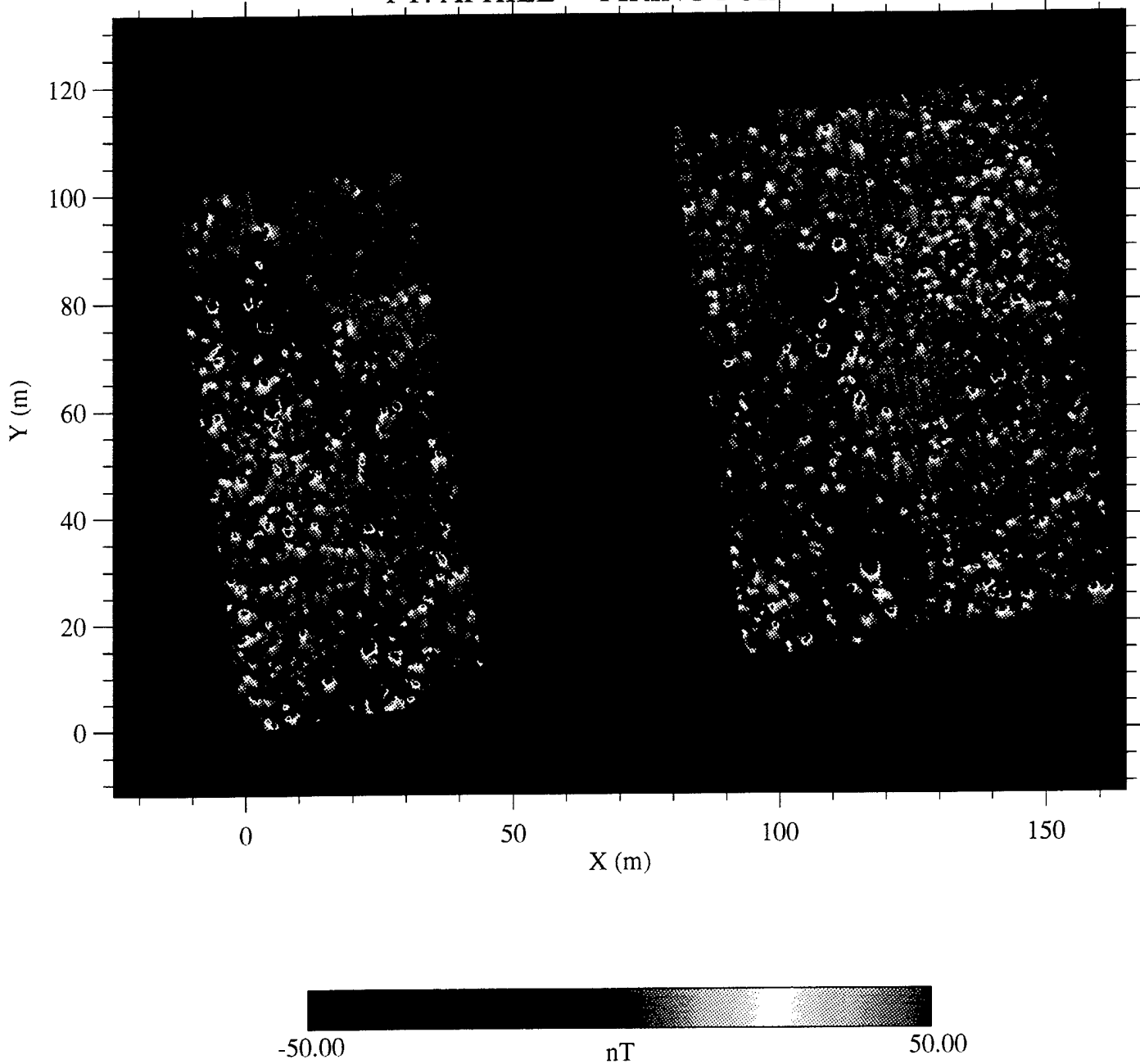

Mag survey at a sensor height of 0.5m (Data from FP22_CS1.dat - FP22_CS3.dat & FP22_SB3.dat)

Figure 7

FT. APHILL - FIRING POINT 22

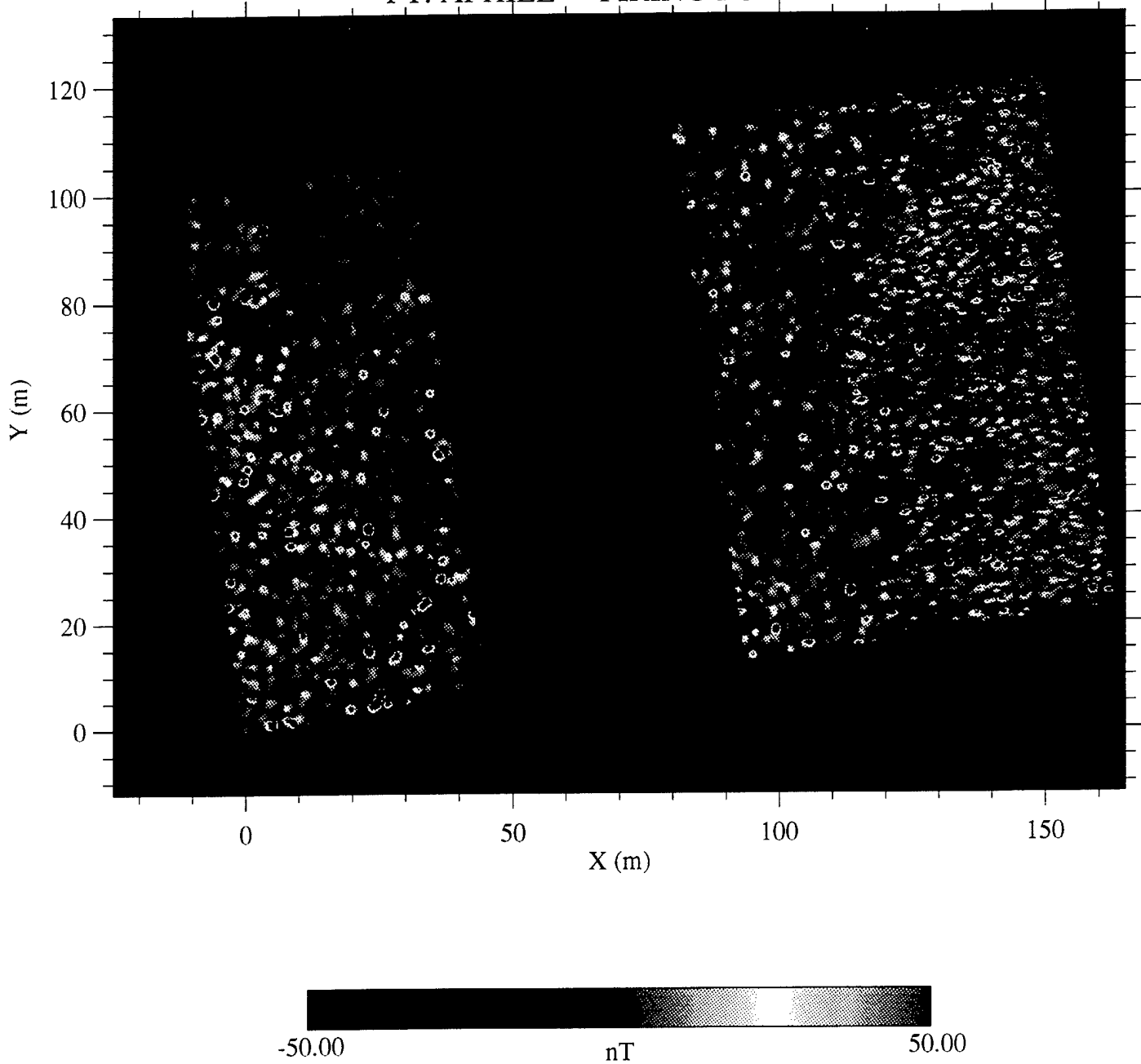

Grad survey with lower sensor at a height of 0.25m (Data from FP22_CS7.dat - FP22_CS9.dat & FP22_SB8.dat)

Figure 8

FT. APHILL - FIRING POINT 20

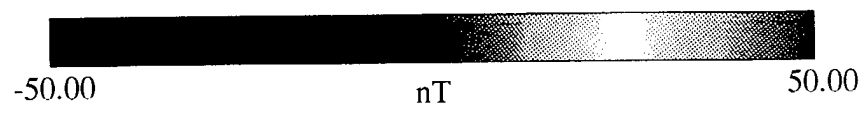
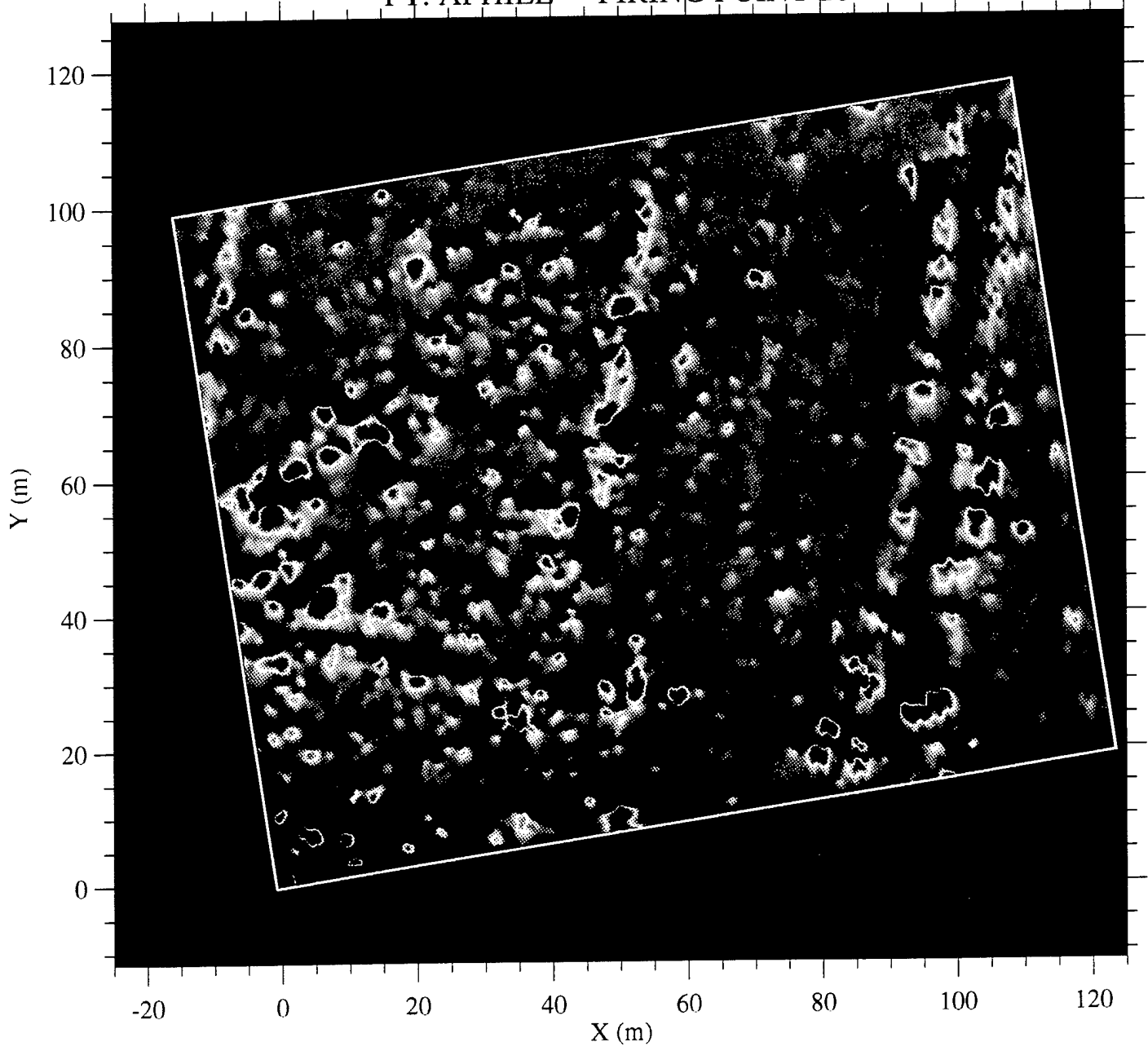

Mag survey at a sensor height of 1.0m (Data from FP20_S5.dat - FP20_S8.dat)

Figure 9

FT. APHILL - FIRING POINT 20

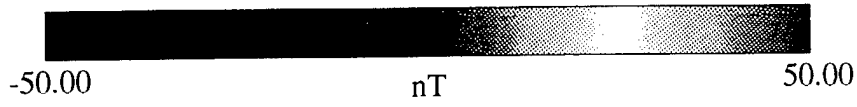
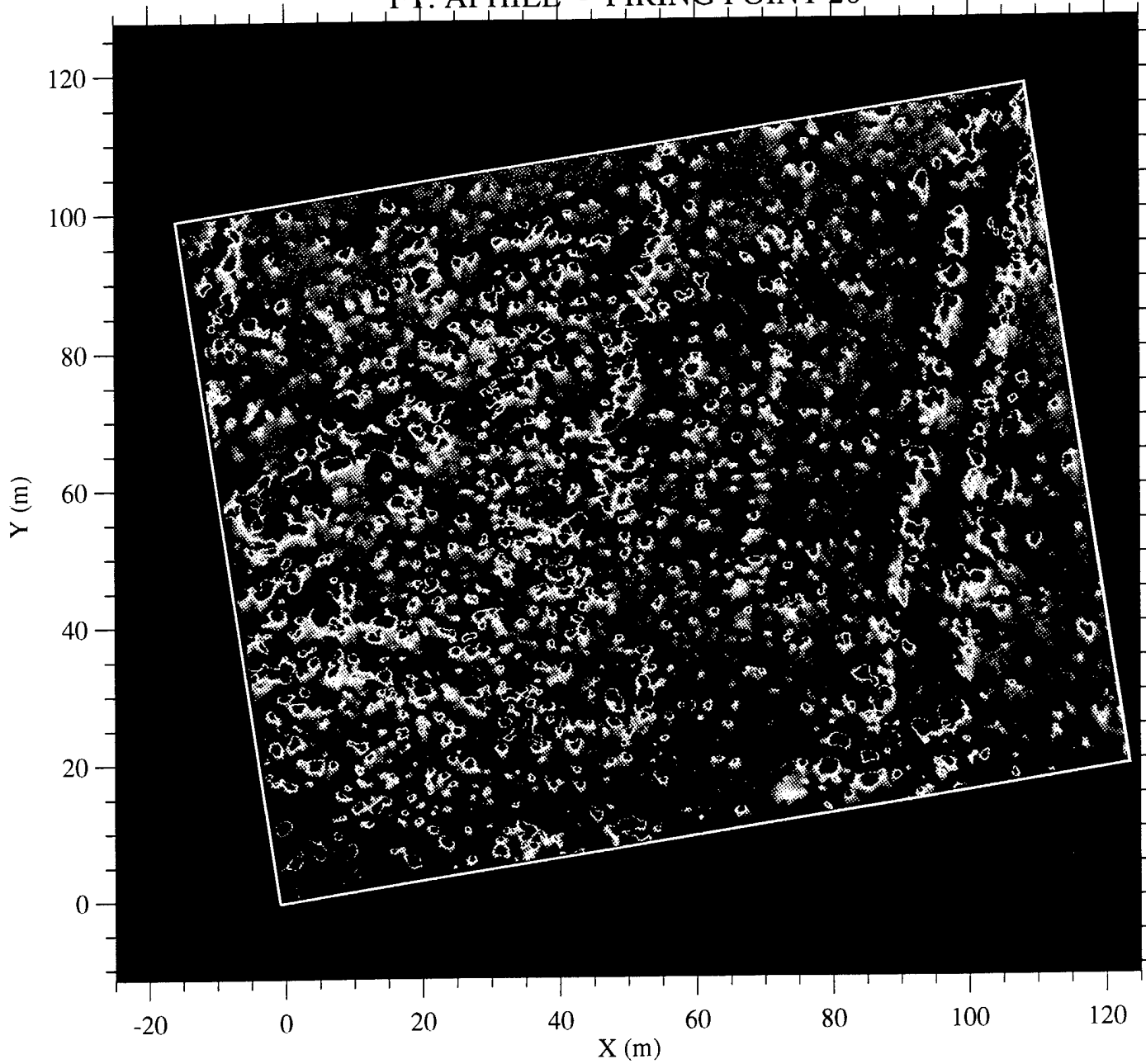

Mag survey at a sensor height of 0.5m (Data from FP20_S1.dat - FP20_S4.dat)

Figure 10

FT. APHILL - FIRING POINT 20

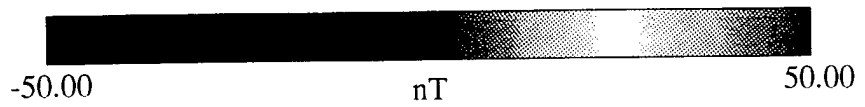
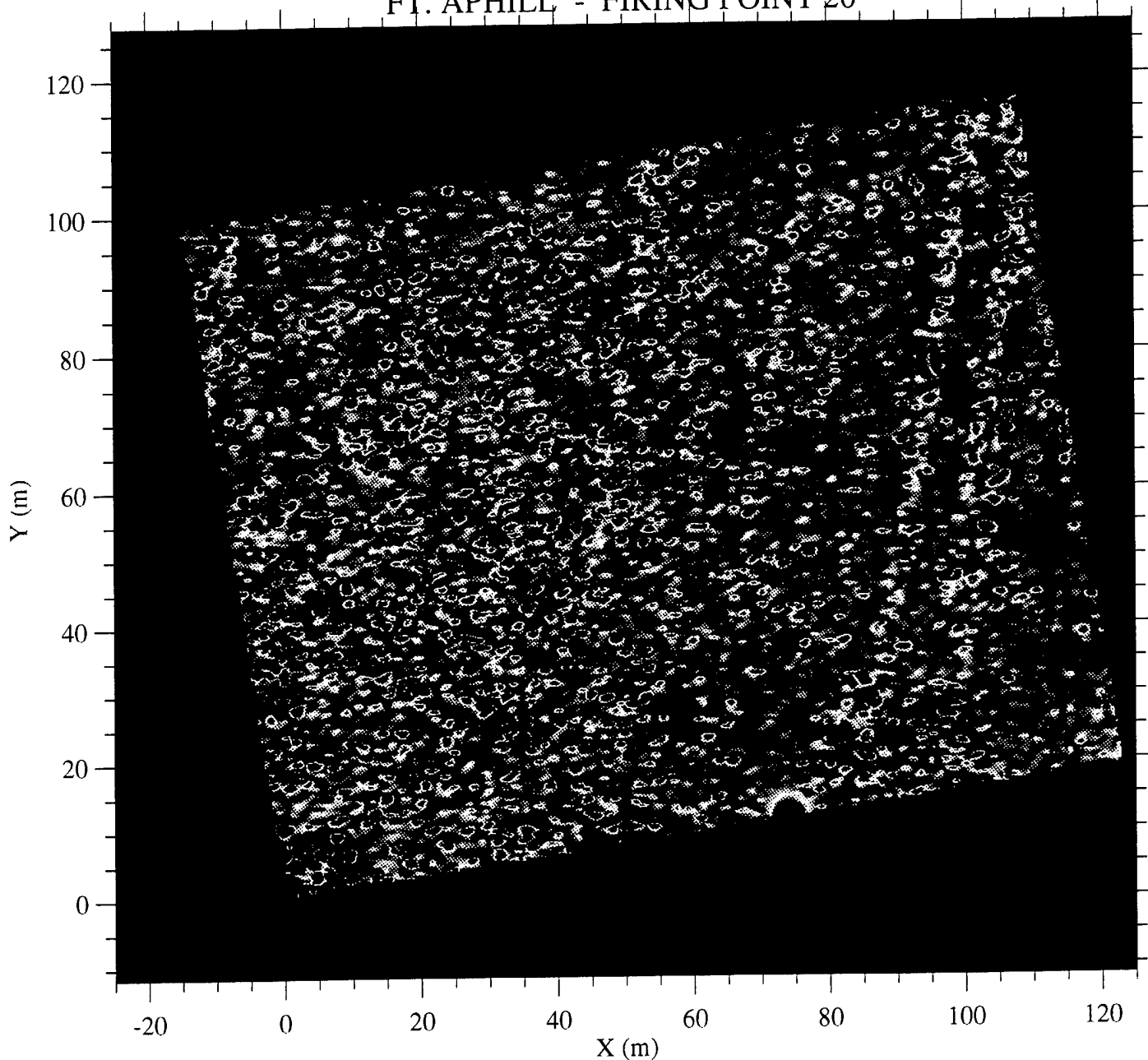

Grad survey with low sensor at a height of 0.25m (Data from FP20_S9.dat - FP20_S12.dat)

Figure 11

FT. CARSON - SEABEE

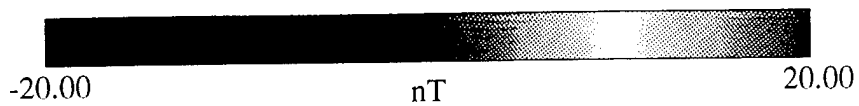
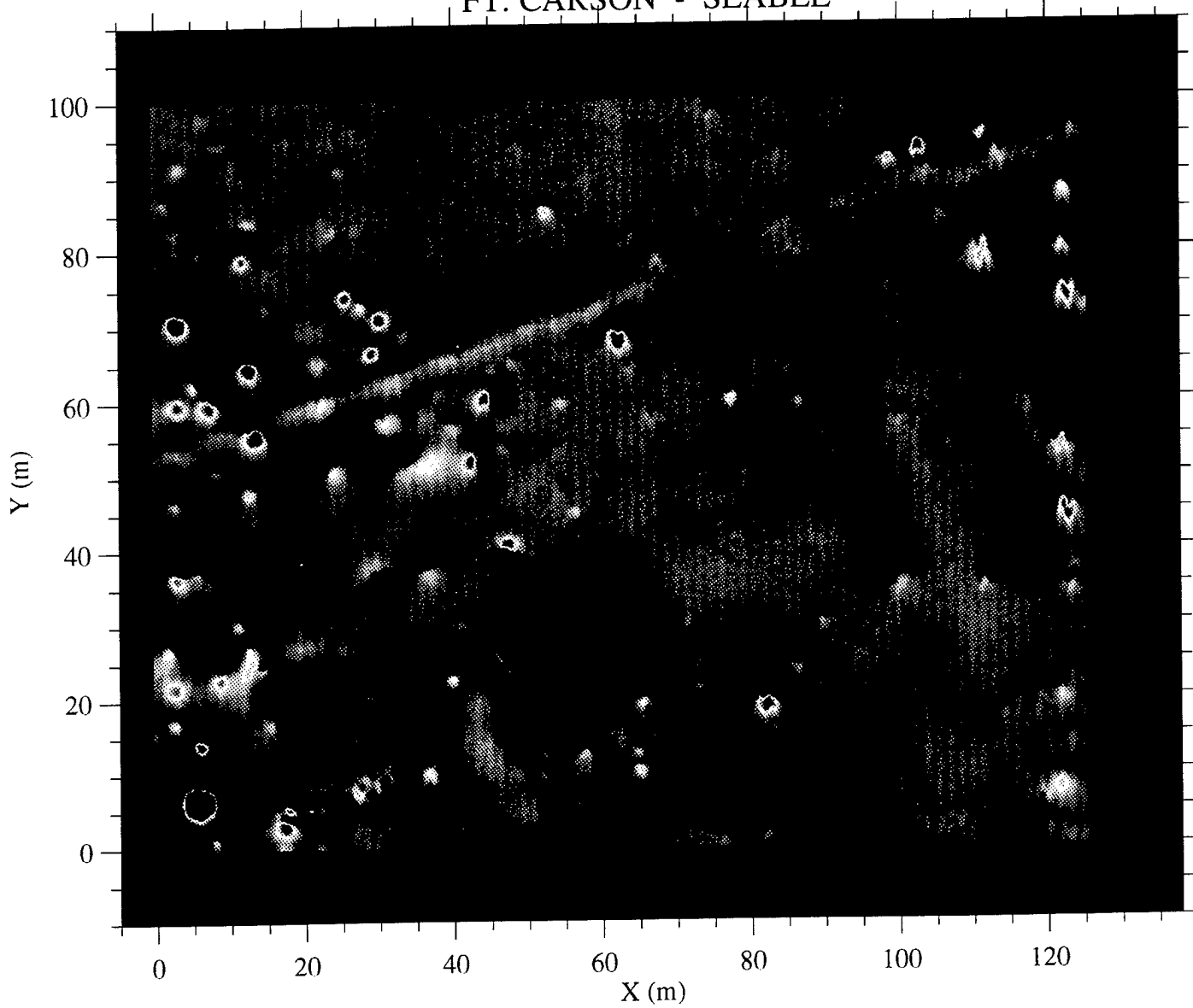

Mag survey at a sensor height of 1.0m

Figure 12

FT. CARSON - SEABEE

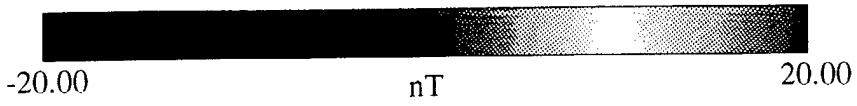
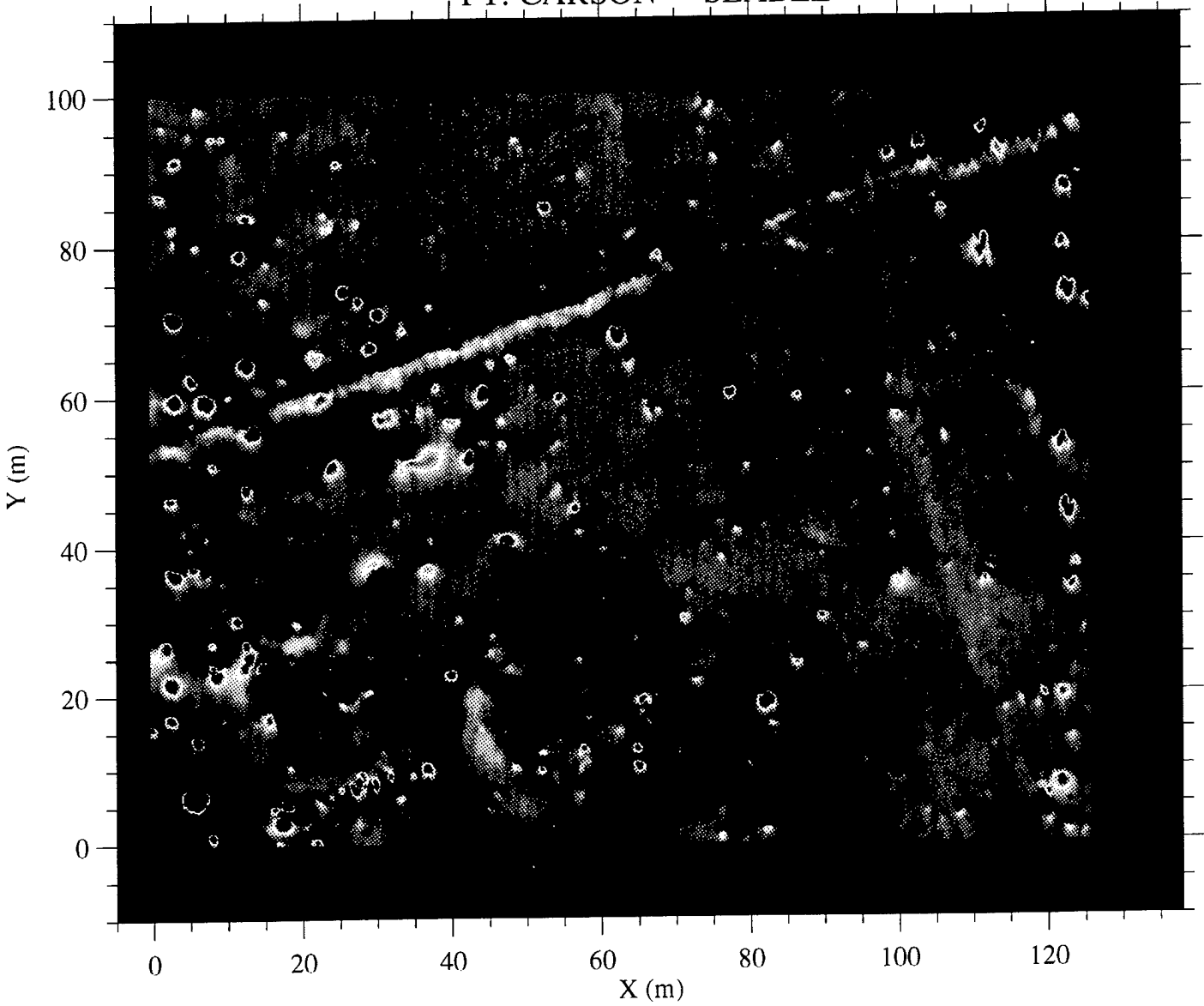

Mag survey at a sensor height of 0.5m

Figure 13

FT. CARSON - SEABEE

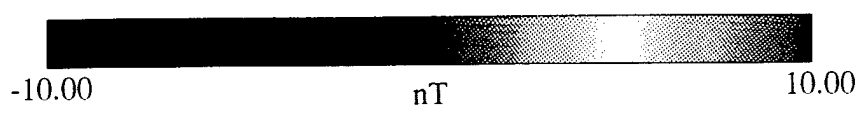
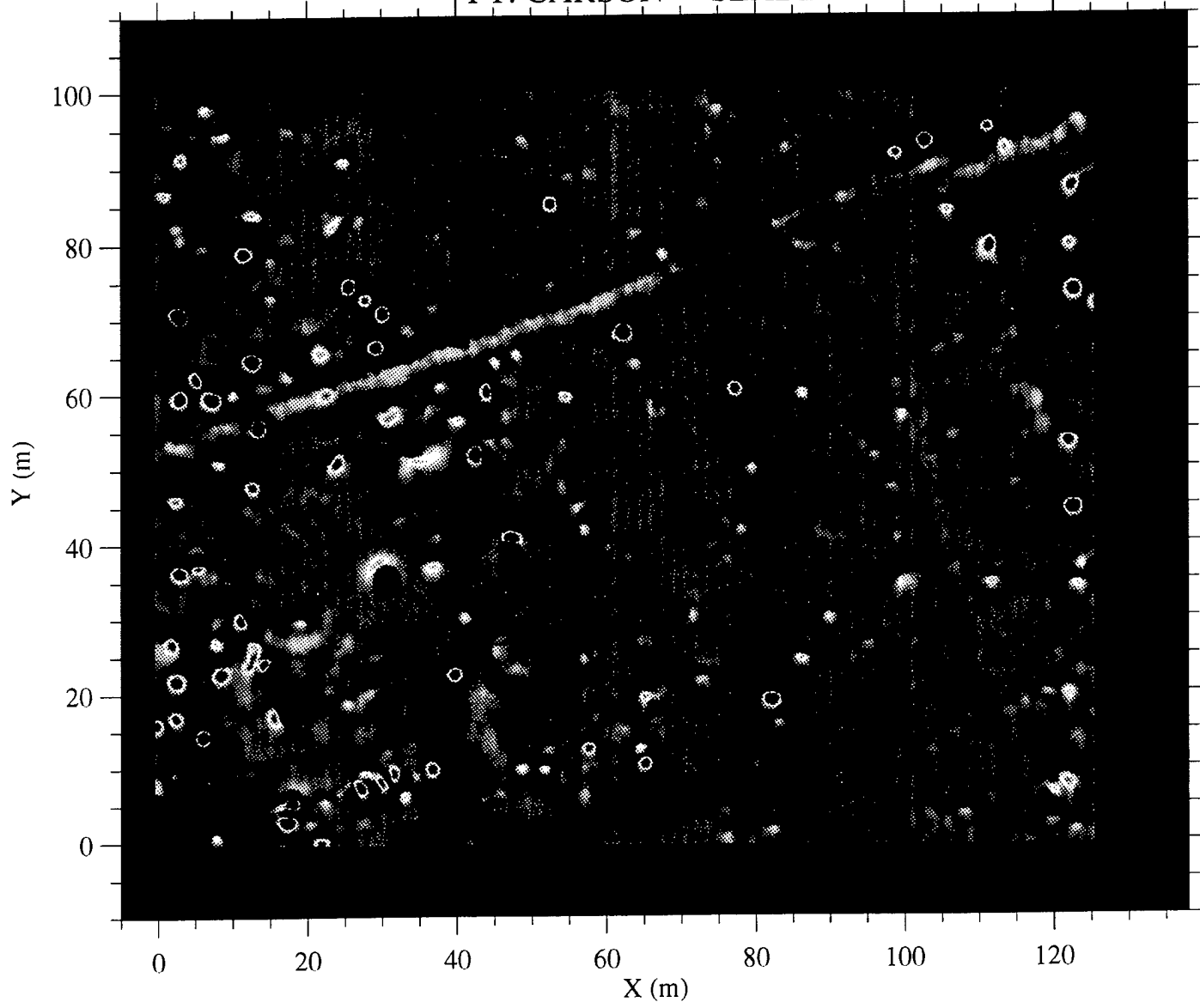

Grad survey with lower sensor at a height of 0.5m

Figure 14

FT. CARSON - TURKEY CREEK

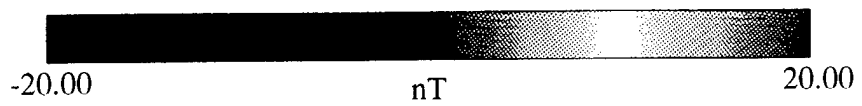
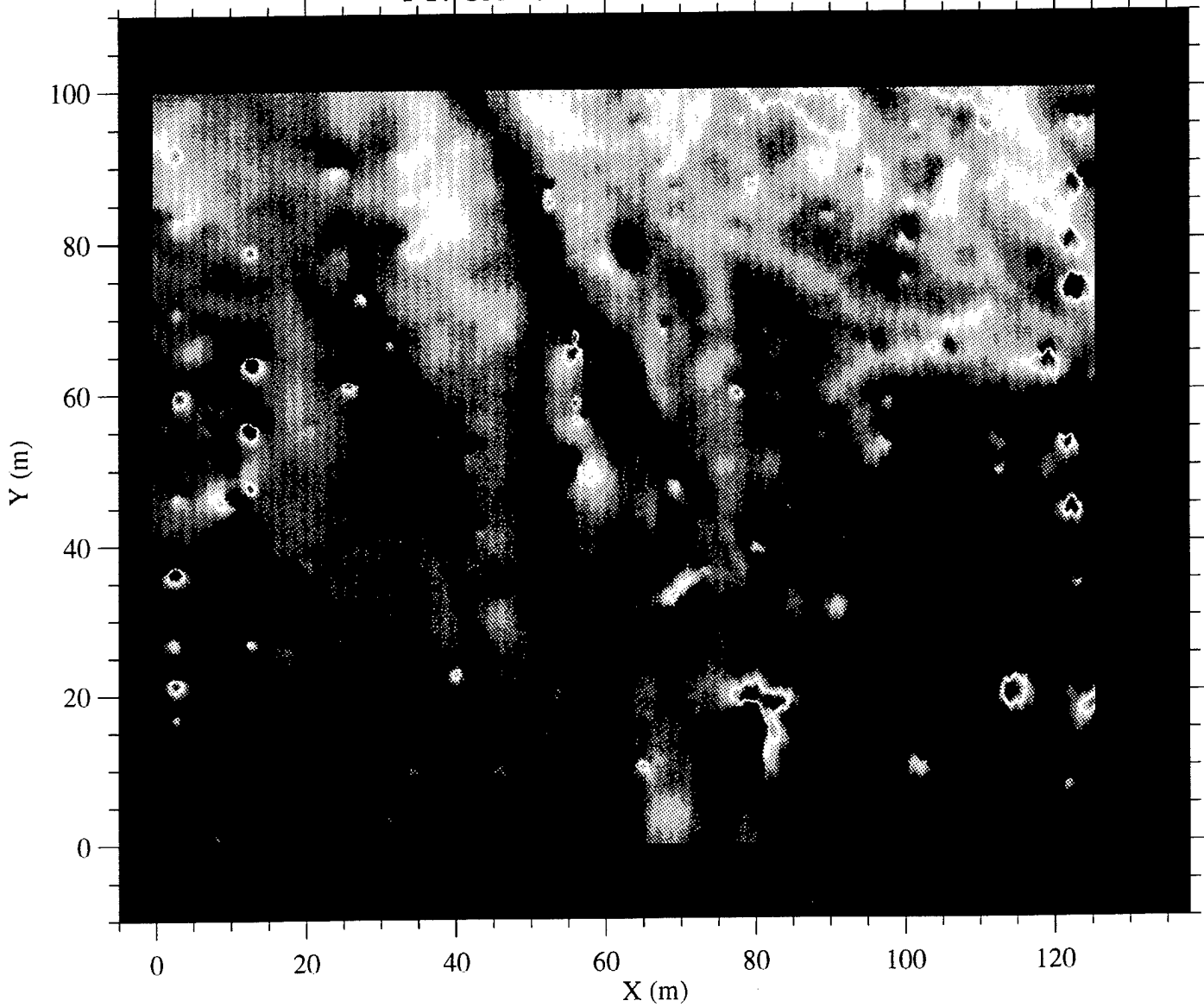

Mag survey at a sensor height of 1.0m

Figure 15

FT. CARSON - TURKEY CREEK

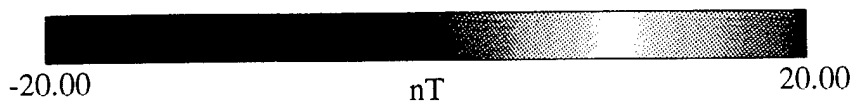
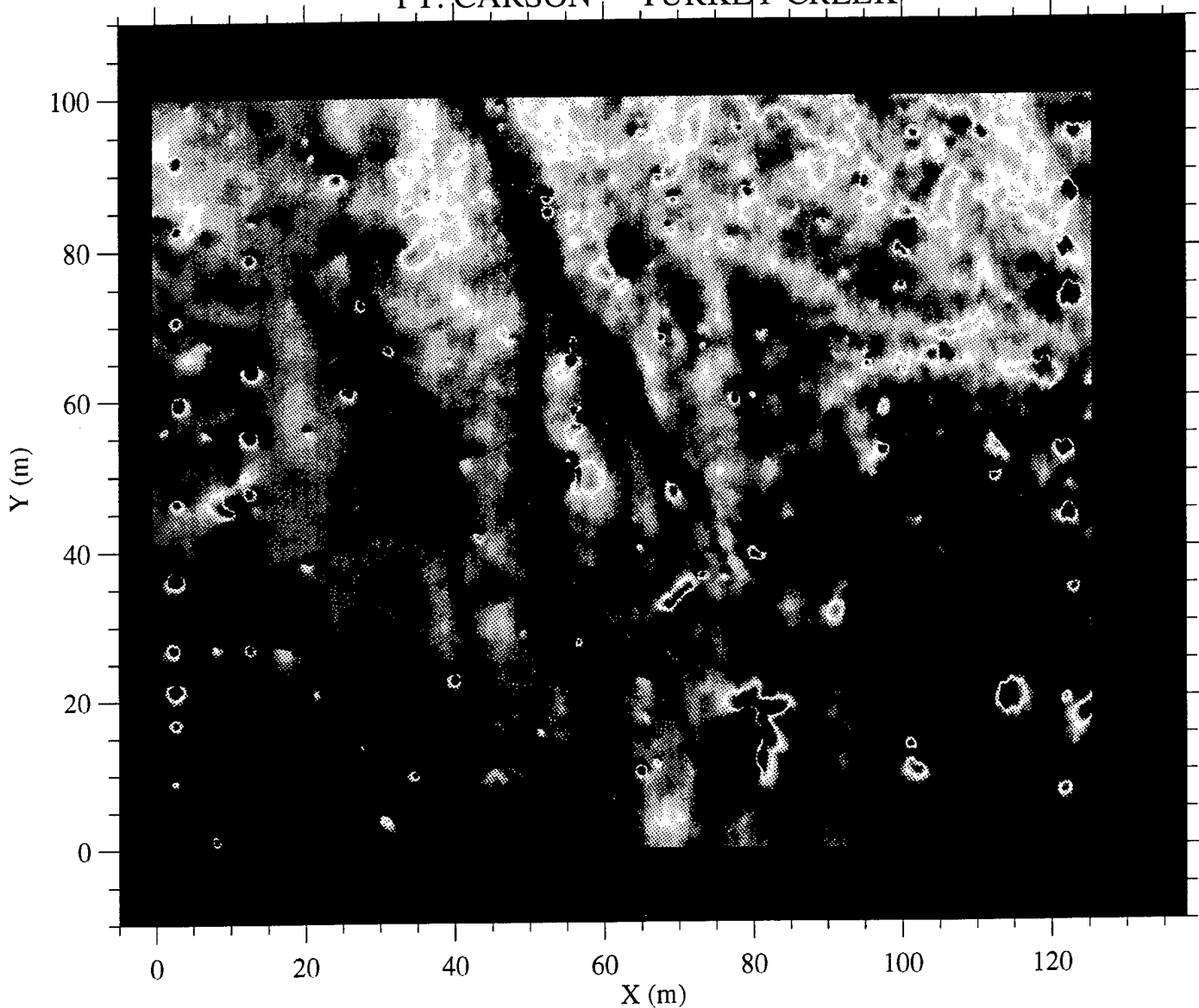

Mag survey at a sensor height of 0.5m

Figure 16

FT. CARSON - TURKEY CREEK

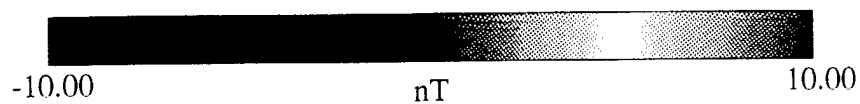
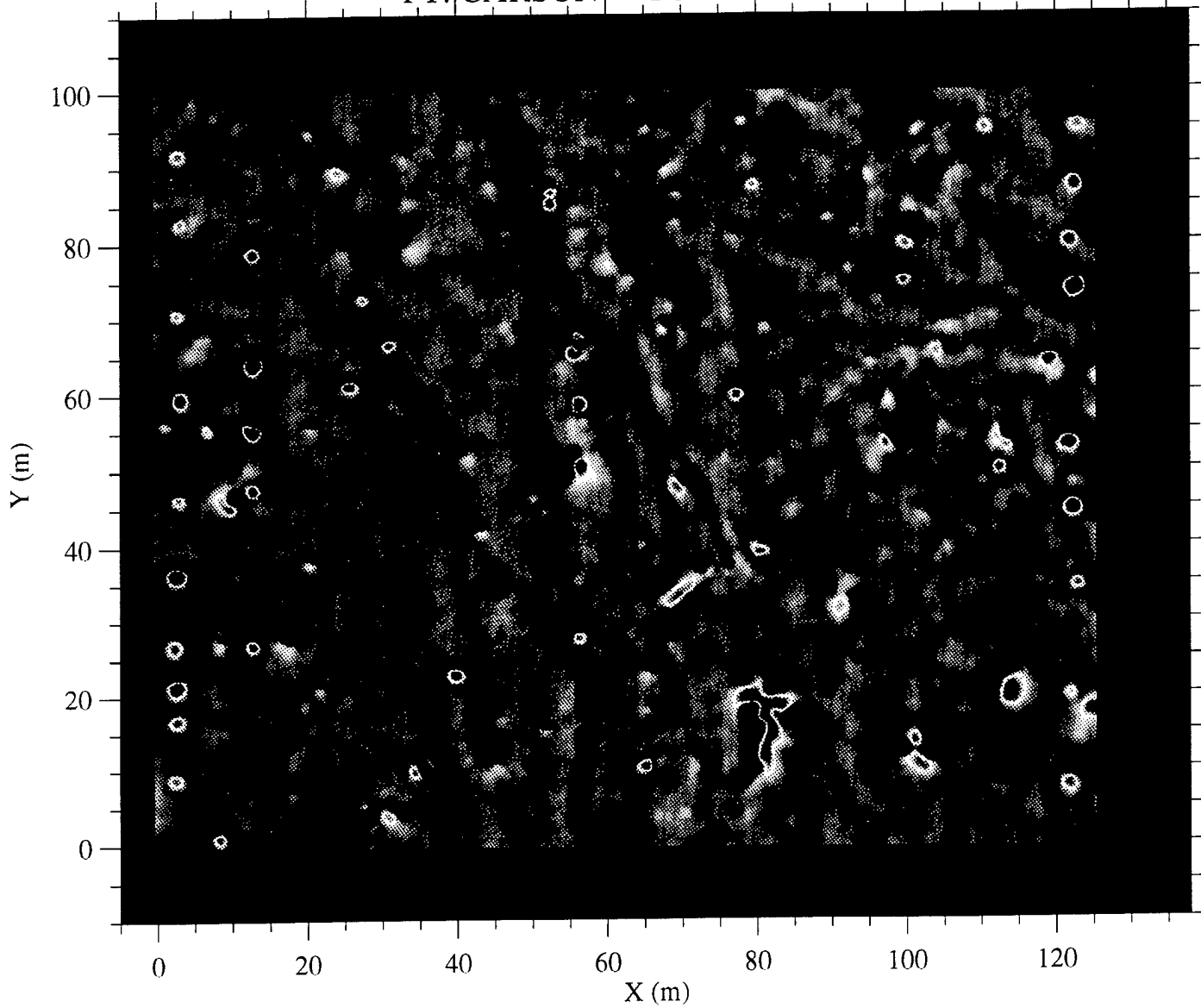

Grad survey with lower sensor at a height of 0.5m

Figure 17

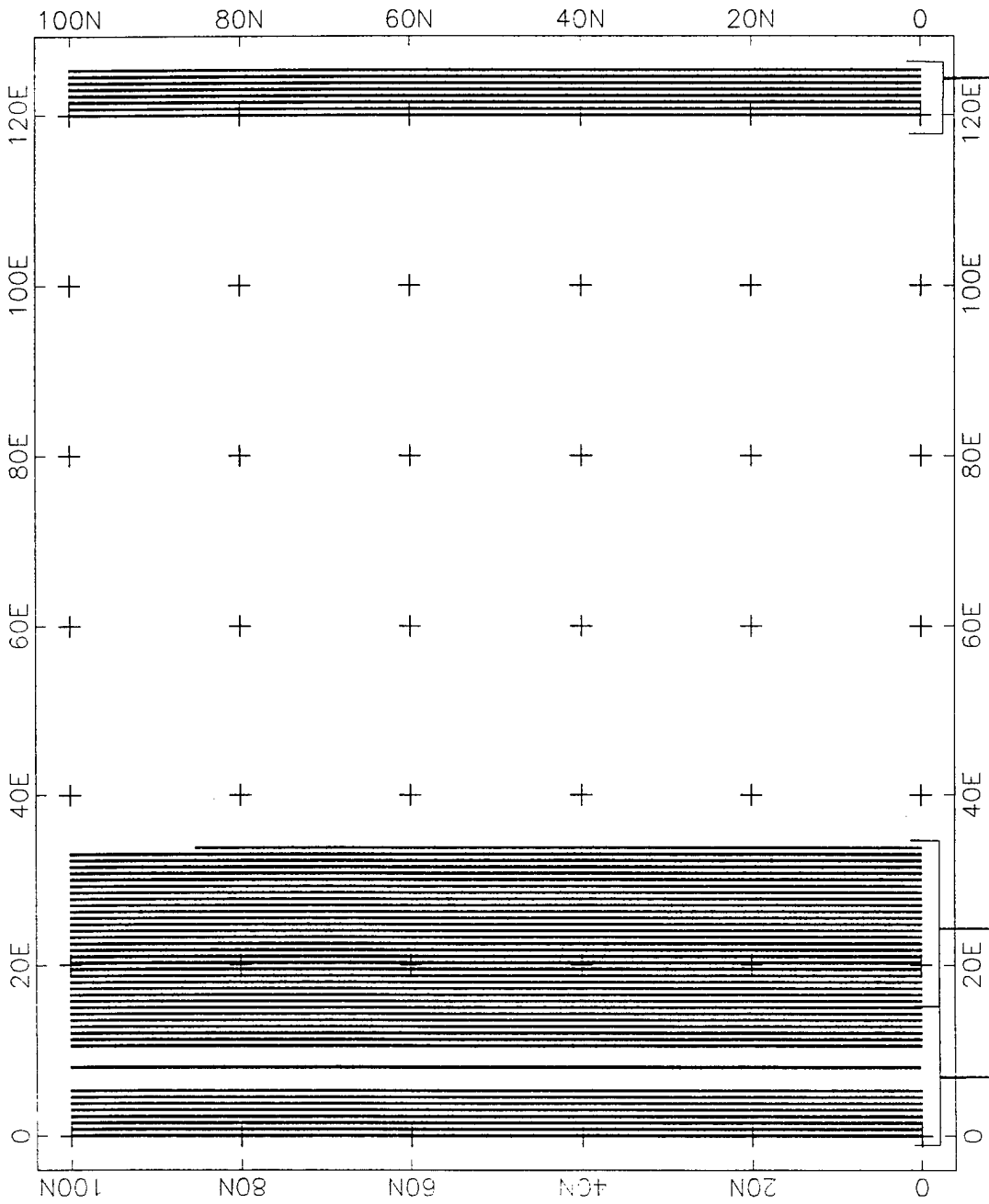

SB1EM61.DAT

SB1EM61.DAT SB2EM61.DAT

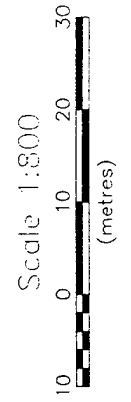

FORT CARSON

SEABEE SITE
EM61
LOCATION MAP

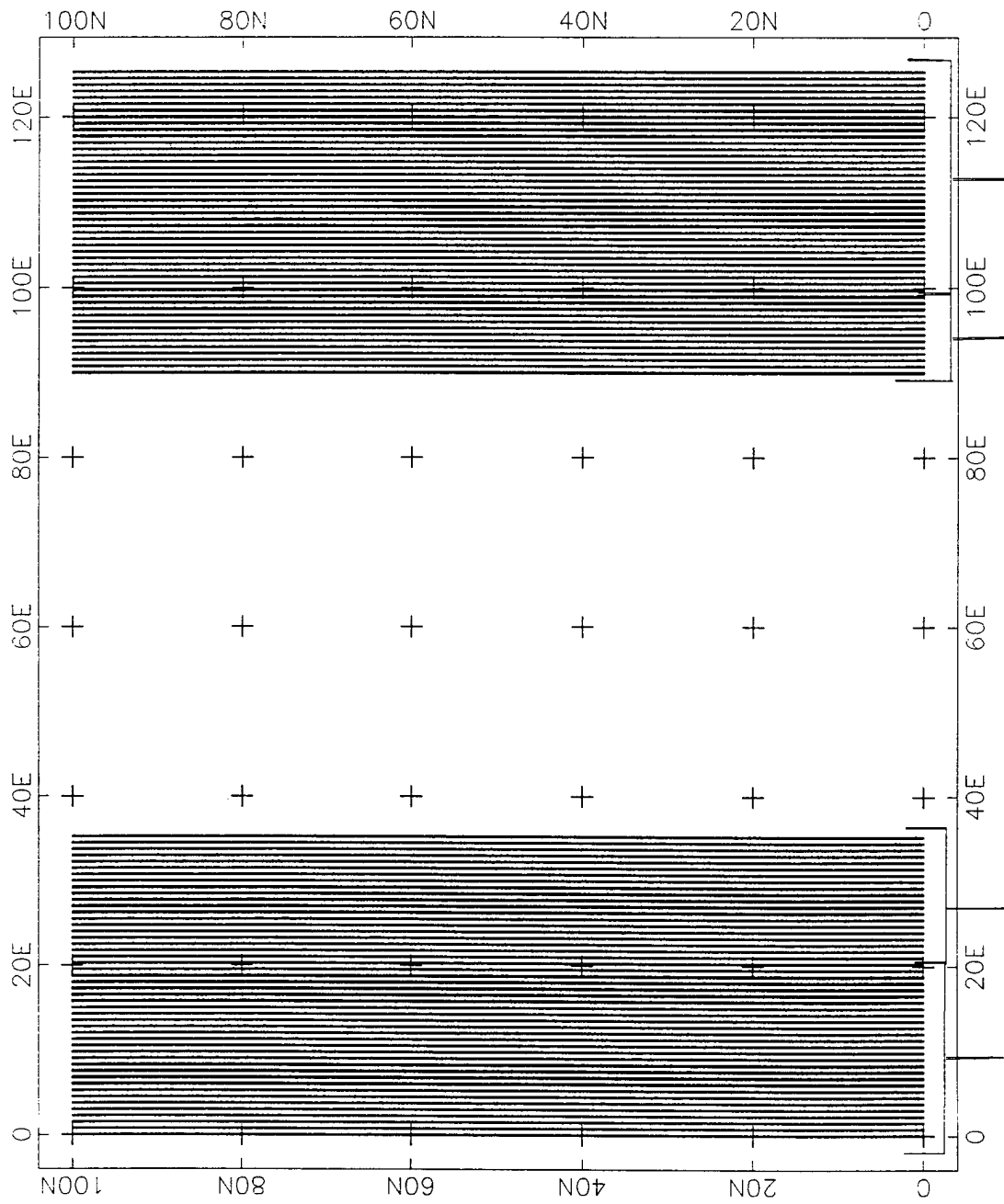

TC1EM61.DAT TC2EM61.DAT

TC4EM61.DAT TC3EM61.DAT



Scale 1:800

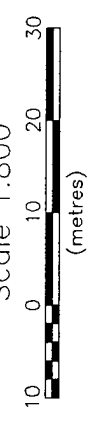

FORT CARSON
 TURKEY CREEK SITE
 EM61 LOCATION MAP

BLACKHAWK GEOMETRICS Figure 19

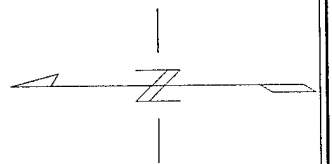
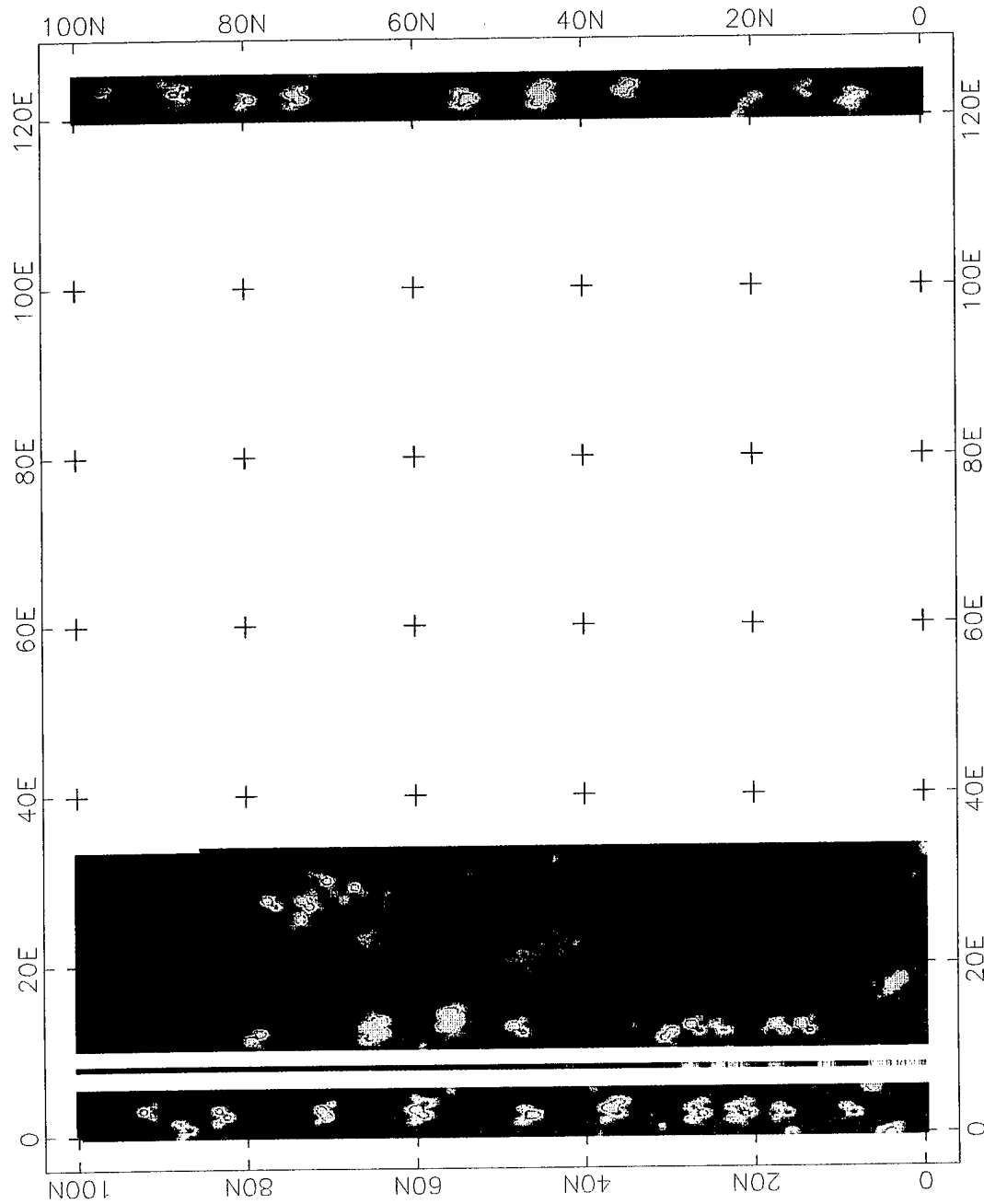

Scale 1:800

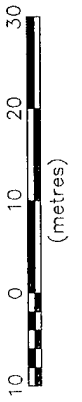

FORT CARSON

SEABEE SITE
EM61 CHANNEL 1

BLACKHAWK GEOMETRICS Figure 21

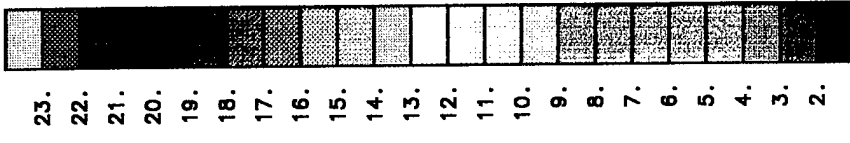
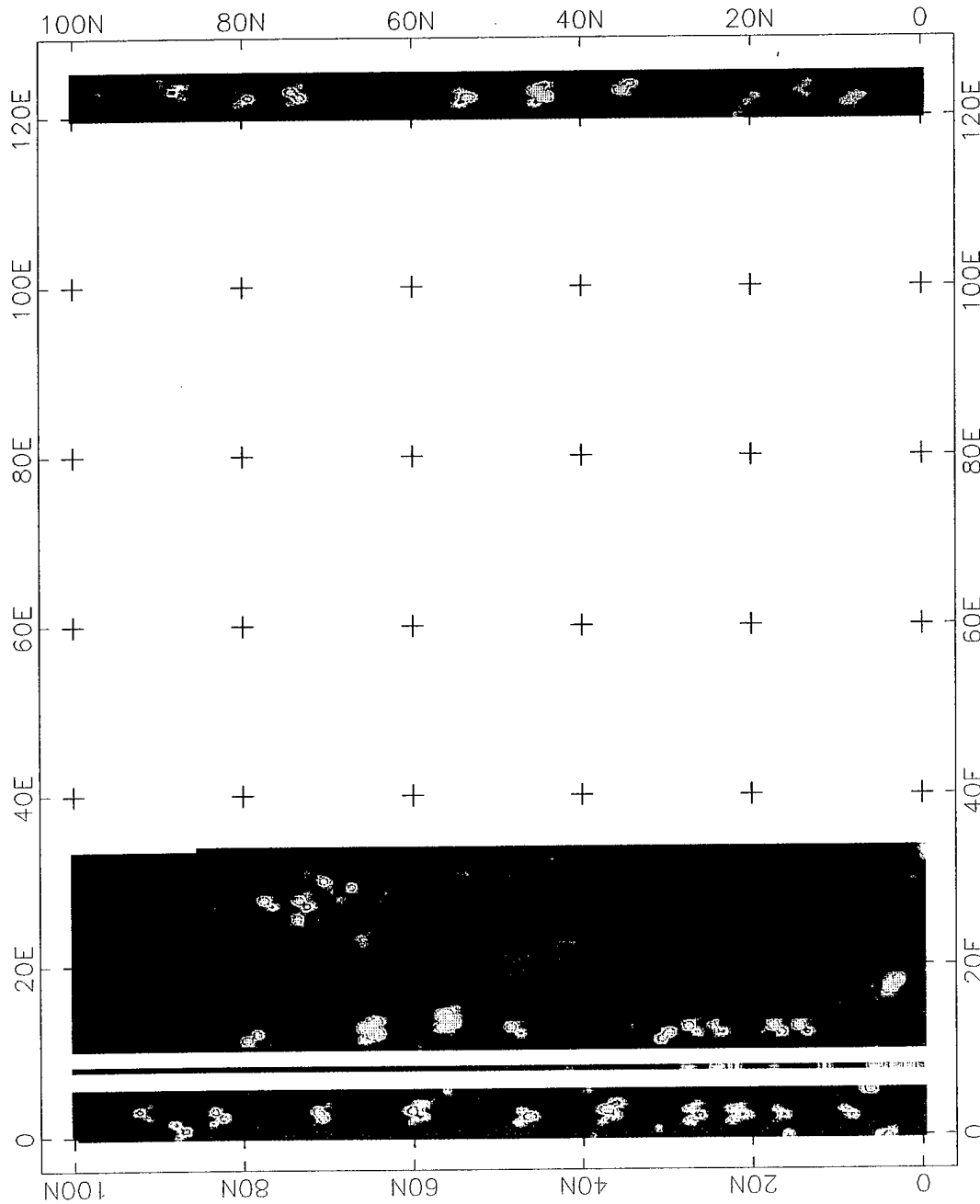

CHANNEL 2
MILLIVOLTS

FORT CARSON
SEABEE SITE
EM61 CHANNEL 2

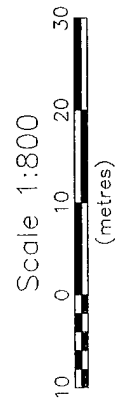

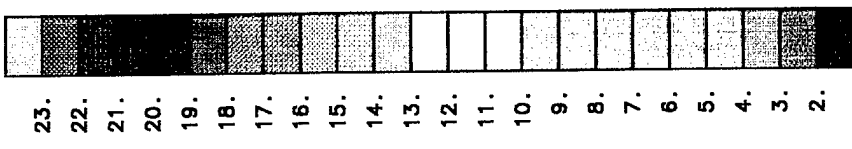
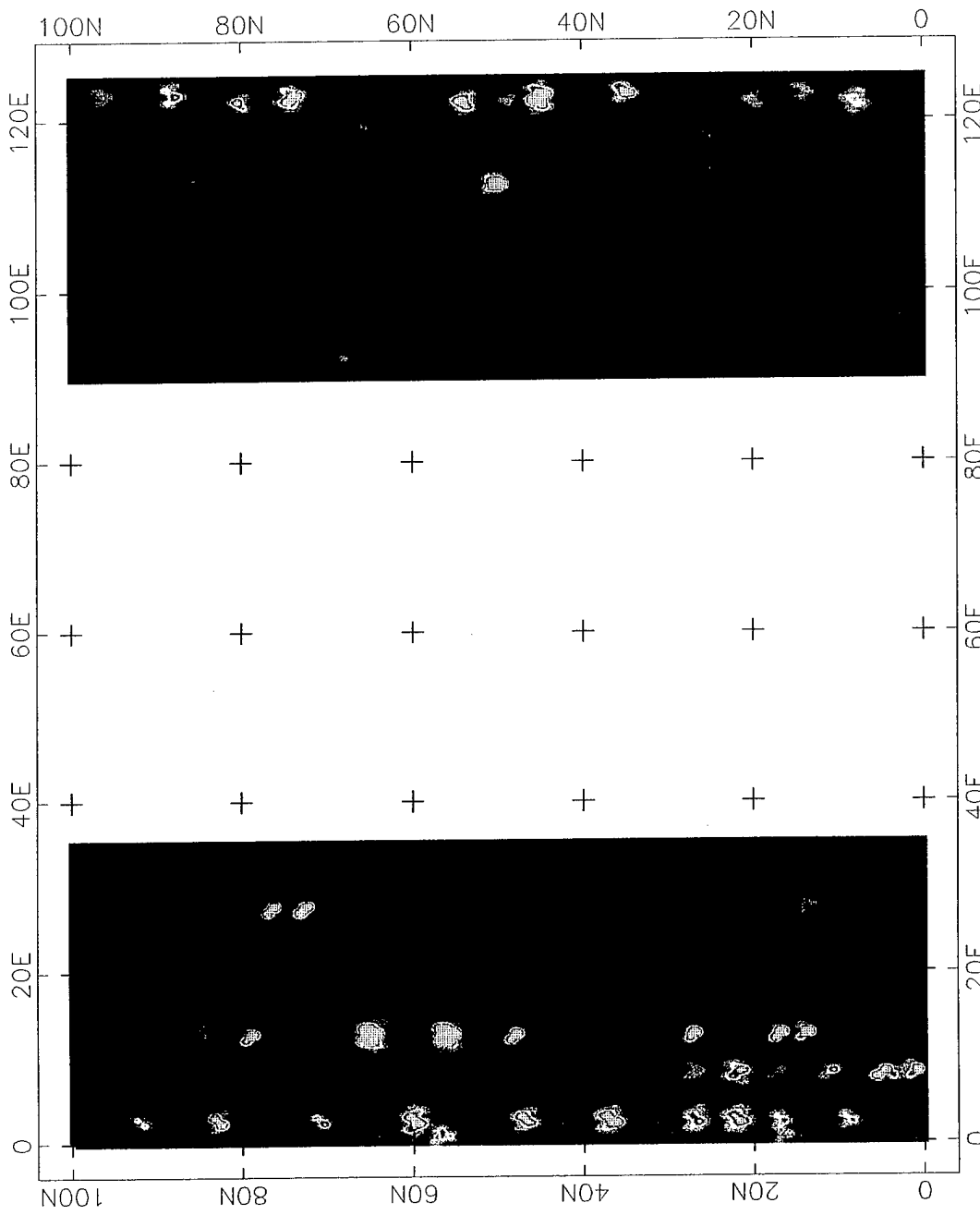

23.
22.
21.
20.
19.
18.
17.
16.
15.
14.
13.
12.
11.
10.
9.
8.
7.
6.
5.
4.
3.
2.

CHANNEL 1
MILLIVOLTS

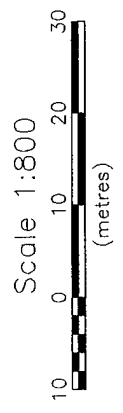
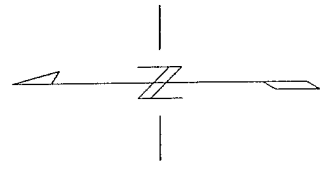

FORT CARSON
TURKEY CREEK SITE
EM61 CHANNEL 1

BLACKHAWK GEOMETRICS **Figure 23**

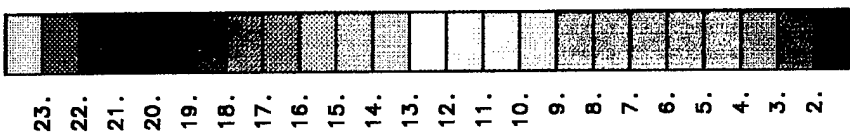
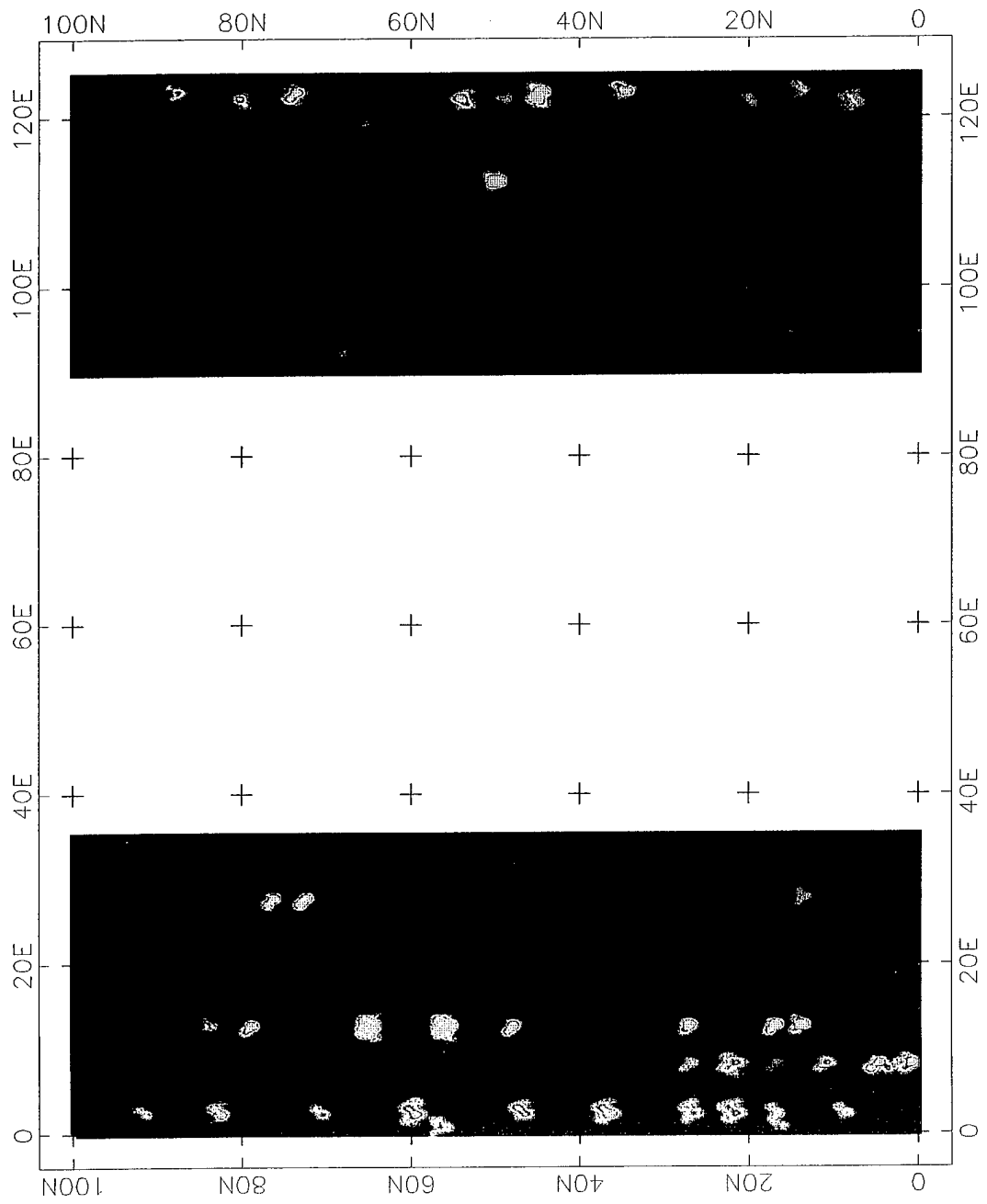

CHANNEL 2
MILLIVOLTS

FORT CARSON
TURKEY CREEK SITE
EM61 CHANNEL 2

BLACKHAWK GEOMETRICS Figure 24

