

NAVAL POSTGRADUATE SCHOOL Monterey, California



THESIS

**REORGANIZATION OF THE MARINE AIR COMMAND
AND CONTROL SYSTEM TO MEET 21ST CENTURY
DOCTRINE AND TECHNOLOGY**

by

John C. Madsen

September 2001

Thesis Advisor:
Associate Advisor:

Frank J. Barrett
Erik Jansen

Approved for public release; distribution is unlimited.

Report Documentation Page

Report Date 30 Sep 2001	Report Type N/A	Dates Covered (from... to) -
Title and Subtitle A Model For Future Surface Warfare Officer Detailing	Contract Number	
	Grant Number	
	Program Element Number	
Author(s) Lopez, Abdel I.	Project Number	
	Task Number	
	Work Unit Number	
Performing Organization Name(s) and Address(es) Research Office Naval Postgraduate School Monterey, Ca 93943-5138	Performing Organization Report Number	
Sponsoring/Monitoring Agency Name(s) and Address(es)	Sponsor/Monitor's Acronym(s)	
	Sponsor/Monitor's Report Number(s)	
Distribution/Availability Statement Approved for public release, distribution unlimited		
Supplementary Notes		
Abstract		
Subject Terms		
Report Classification unclassified	Classification of this page unclassified	
Classification of Abstract unclassified	Limitation of Abstract UU	
Number of Pages 111		

REPORT DOCUMENTATION PAGE			Form Approved OMB No. 0704-0188	
Public reporting burden for this collection of information is estimated to average 1 hour per response, including the time for reviewing instruction, searching existing data sources, gathering and maintaining the data needed, and completing and reviewing the collection of information. Send comments regarding this burden estimate or any other aspect of this collection of information, including suggestions for reducing this burden, to Washington headquarters Services, Directorate for Information Operations and Reports, 1215 Jefferson Davis Highway, Suite 1204, Arlington, VA 22202-4302, and to the Office of Management and Budget, Paperwork Reduction Project (0704-0188) Washington DC 20503.				
1. AGENCY USE ONLY (Leave blank)		2. REPORT DATE September 2001	3. REPORT TYPE AND DATES COVERED Master's Thesis	
4. TITLE AND SUBTITLE: Reorganization of the Marine Air Command and Control System to Meet 21st Century Doctrine and Technology			5. FUNDING NUMBERS	
6. AUTHOR(S) John C. Madsen				
7. PERFORMING ORGANIZATION NAME(S) AND ADDRESS(ES) Naval Postgraduate School Monterey, CA 93943-5000			8. PERFORMING ORGANIZATION REPORT NUMBER	
9. SPONSORING / MONITORING AGENCY NAME(S) AND ADDRESS(ES) N/A			10. SPONSORING / MONITORING AGENCY REPORT NUMBER	
11. SUPPLEMENTARY NOTES The views expressed in this thesis are those of the author and do not reflect the official policy or position of the Department of Defense or the U.S. Government.				
12a. DISTRIBUTION / AVAILABILITY STATEMENT Approved for public release; distribution is unlimited			12b. DISTRIBUTION CODE	
13. ABSTRACT (maximum 200 words) The Marine Air Command and Control System (MACCS) is at a crossroad for organizational change. New and emerging war fighting doctrine, which places an emphasis on joint and small contingency operations, as well as new technology, requires that the MACCS review how it is organizationally structured. Within the next few years, the Marine Corps will field the Common Aviation Command and Control System (CAC2S). CAC2S is designed to be a singular tactical system for all functional agencies within the Marine Air Control Group (MACG). Unique systems, which were in the past tailored for the specific missions, will be eliminated with the fielding of CAC2S. CAC2S will allow the MACCS to operate in a manner that could not be achieved when the MACCS was first formed during the 1960's. Many sources in the Fleet Marine Force and the support establishment recognize that the MACCS must reorganize in order to operate and function effectively within the confines of this emerging 21 st century technology and doctrine. Parallels exist between how industry and business reorganize when introduced to new technologies and business doctrine, and the military. Organizational restructuring is something that must be carefully considered and planned, for it is most often resisted by the members and stakeholders of an organization. Overcoming the barriers and resistance to change requires formal models of change be implemented. Technology alone cannot increase or improve an organization's productivity. Only through formal restructuring can an organization such as the MACCS hope to remain essential to the mission of the Marine Corps.				
14. SUBJECT TERMS Command and Control, Marine Air Command and Control System, MACCS, Organizational Change, Marine Aviation			15. NUMBER OF PAGES 51	
			16. PRICE CODE	
17. SECURITY CLASSIFICATION OF REPORT Unclassified	18. SECURITY CLASSIFICATION OF THIS PAGE Unclassified	19. SECURITY CLASSIFICATION OF ABSTRACT Unclassified	20. LIMITATION OF ABSTRACT UL	

THIS PAGE INTENTIONALLY LEFT BLANK

Approved for public release; distribution is unlimited

**REORGANIZATION OF THE MARINE AIR COMMAND AND CONTROL
SYSTEM TO MEET 21ST CENTURY DOCTRINE AND TECHNOLOGY**

John C. Madsen
Major, United States Marine Corps
B.S., Central Michigan University, 1989

Submitted in partial fulfillment of the
requirement for the degree of

MASTER OF SCIENCE IN INFORMATION TECHNOLOGY MANAGEMENT

from the

**NAVAL POSTGRADUATE SCHOOL
September 2001**

Author:

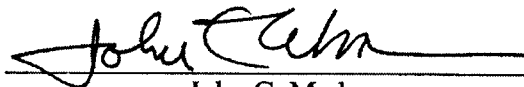

John C. Madsen

Approved by:

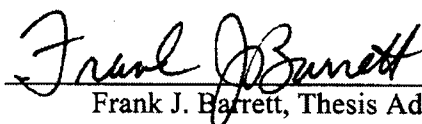

Frank J. Barrett, Thesis Advisor

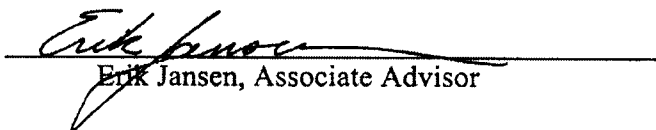

Erik Jansen, Associate Advisor

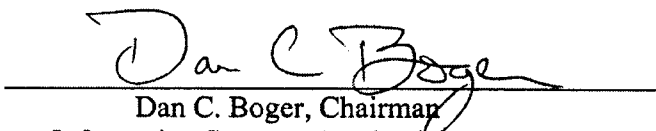

Dan C. Boger, Chairman
Information Systems Academic Group

THIS PAGE INTENTIONALLY LEFT BLANK

ABSTRACT

The Marine Air Command and Control System (MACCS) is at a crossroad for organizational change. New and emerging war fighting doctrine, which places an emphasis on joint and small contingency operations, as well as new technology, requires that the MACCS review how it is organizationally structured. Within the next few years, the Marine Corps will field the Common Aviation Command and Control System (CAC2S). CAC2S is designed to be a singular tactical system for all functional agencies within the Marine Air Control Group (MACG). Unique systems, which were in the past tailored for the specific missions, will be eliminated with the fielding of CAC2S. CAC2S will allow the MACCS to operate in a manner that could not be achieved when the MACCS was first formed during the 1960's. Many sources in the Fleet Marine Force and the support establishment recognize that the MACCS must reorganize in order to operate and function effectively within the confines of this emerging 21st century technology and doctrine. Parallels exist between how industry and business reorganize when introduced to new technologies and business doctrine, and the military. Organizational restructuring is something that must be carefully considered and planned, for it is most often resisted by the members and stakeholders of an organization. Overcoming the barriers and resistance to change requires formal models of change be implemented. Technology alone cannot increase or improve an organization's productivity. Only through formal restructuring can an organization such as the MACCS hope to remain essential to the mission of the Marine Corps.

THIS PAGE INTENTIONALLY LEFT BLANK

TABLE OF CONTENTS

I.	INTRODUCTION.....	1
II.	CURRENT STRUCTURE OF THE MARINE AIR COMMAND AND CONTROL SYSTEM.....	7
A.	ORGANIZATIONAL STRUCTURE.....	10
1.	Current MACG/MACCS.....	10
2.	Historical Overview of MACCS Structure.....	12
B.	CURRENT AND EMERGING TECHNOLOGY.....	13
1.	Stovepipe Systems of the MACCS.....	13
2.	Common Aviation Command and Control System (CAC2S).....	14
3.	Joint Systems.....	15
C.	CURRENT AND EMERGING DOCTRINE.....	15
1.	JV2020.....	16
2.	OMFTS.....	17
3.	Marine Corps Strategy 21.....	17
4.	MCDP 6 – Command and Control.....	18
III.	DRIVERS OF CHANGE FOR THE MACCS.....	19
A.	DESERT STORM TO PRESENT.....	20
B.	TECHNOLOGICAL ADVANCES.....	20
C.	PROFESSIONAL PAPERS/INTERVIEWS.....	22
D.	CONSEQUENCES.....	26
E.	STREAMLINING THE MACG.....	26
IV.	PROCESS OF ORGANIZATIONAL CHANGE.....	31
A.	ROLE OF TECHNOLOGY.....	31
1.	Productivity Paradox.....	32
2.	Disintermediation.....	33
3.	The Squandered Computer.....	34
B.	PROPONENTS OF CHANGE.....	36
1.	Senge and Systems Thinking.....	37
2.	Flat vs. Hierarchical Structure.....	38
3.	Change Technology.....	40
C.	BARRIERS TO CHANGE.....	41
1.	Resistance.....	41
2.	Overcoming.....	43
3.	Change Methods.....	44
4.	Involvement.....	46
D.	APPLYING CHANGE TO THE MACCS.....	47
1.	Factors to Identify.....	47
2.	Transforming the MACCS Organizational Structure.....	47
3.	Change Model for the MACCS.....	49
E.	SUMMARY.....	50

V. CONCLUSION	51
BIBLIOGRAPHY	53
INITIAL DISTRIBUTION LIST	57

LIST OF FIGURES

Figure 1.	The Marine Aircraft Wing.....	1
Figure 2.	C2 Triangle. [From: Jansen, 2000].....	2
Figure 3.	Six Functions of Marine Aviation.....	9
Figure 4.	Marine Air Control Group Organizational Structure. [From: <u>The Marine Air Command and Control System and Expeditionary Maneuver Warfare Part Three: Organization</u>].....	10
Figure 5.	Current MACG Organization. [From: <u>The Marine Air Command and Control System and Expeditionary Maneuver Warfare Part Three: Organization</u>].....	28
Figure 6.	Phase 1 Reorganization. [From: <u>The Marine Air Command and Control System and Expeditionary Maneuver Warfare Part Three: Organization</u>].....	28
Figure 7.	MACD Bn Organization under Phase 1. [From: <u>The Marine Air Command and Control System and Expeditionary Maneuver Warfare Part Three: Organization</u>].....	28
Figure 8.	Phase 2 Reorganization. [From: <u>The Marine Air Command and Control System and Expeditionary Maneuver Warfare Part Three: Organization</u>].....	29
Figure 9.	Senge Loop. [From: Senge, 1990].....	37
Figure 10.	Shift in Organizational Configuration for Modal DoD Organizations as they Move through the RMA. [From: Jansen, 2000].....	40
Figure 11.	Gleicher’s Change Formula. [From: Rouda, 1995].....	40
Figure 12.	Lewin’s Change Theory Model. [From: Schein, 1993].....	45
Figure 13.	Avn C2 Organizational Model. [From: Trabun, 2000].....	49

THIS PAGE INTENTIONALLY LEFT BLANK

ACKNOWLEDGMENTS

I would like to acknowledge the fact that this thesis would not have been possible without help and assistance from several individuals. First, Dr. Frank Barrett for his help in the field of organizational change theory, and from which his class on managing complex organizational change helped develop the ideas from which this thesis was formulated. Additionally, I want to acknowledge Dr. Erik Jansen for his guidance in the area of command and control and organizational theories. Both individuals provided the necessary direction to help accomplish the writing. Finally, Ms. Nancy Sharrock for formatting this thing to make sure it made sense.

I would also like to acknowledge my fellow Marine Corps Majors, peers, and good friends Jim Wedge, Alan Stocks, and David DiEugenio, as well as their wives and families. Their friendship and commiseration over the past two years helped make my time at the Naval Postgraduate School not only a significant learning experience, but also a life experience that helped me grow as a person and officer.

And, I'm still unsure if there was a book.

THIS PAGE INTENTIONALLY LEFT BLANK

I. INTRODUCTION

The Marine Corps is a unique warfighting entity in that it is capable of self-contained/self sustained military operations. The Marine Air Ground Task Force (MAGTF) can provide all the required elements necessary to carry out wartime, NEO, peacekeeping, or other military operations. Integral to the “Air” (or Aviation) portion of the MAGTF is the Marine Aircraft Wing (MAW). Each of the four MAW’s (three active, and one reserve) consists of groups and squadrons of fixed wing, rotary wing, transport aircraft, and a command and control (C2) element. Figure 1 is a graphical representation of the MAW.

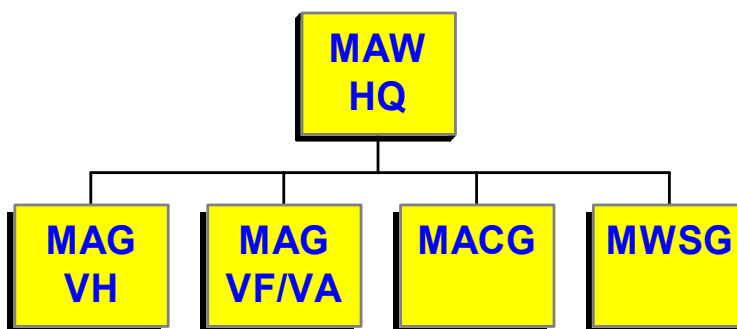

Figure 1. The Marine Aircraft Wing.

It is this C2 element, provided by the Marine Air Control Group (MACG), and its subordinate squadrons, that will be central to this thesis. Command and control are considered vital to any military operation, and computer enhanced/controlled C2 has been a part of Marine aviation since the Vietnam era. The MACG is tasked with fielding the Marine Air Command and Control System (MACCS). The MACCS is both a functional and technical system, and has been structured since its inception to be task organized, with the basic theme being “centralized command, decentralized control”. This means that each subordinate squadron of the MACG is formed to provide a tactical piece of the MACCS. No one single squadron, or tactical component, can work autonomously to complete C2 operations. Only when working together can the squadrons of the MACCS field all necessary elements to carry out air command and control operations.

Command and Control (C2) operations, in any arena, can be depicted by Admiral Cebrowski's triangle of Doctrine, Technology, and Organization, as shown in Figure 2.

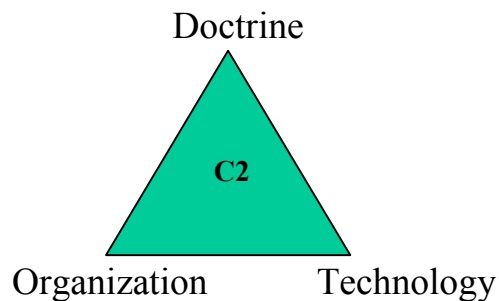

Figure 2. C2 Triangle. [From: Jansen, 2000]

This triangle is a socio-technical system that shows how the three entities, working within the environment of warfare, combine to give the C2 its effectiveness. Since the end of the Vietnam War, when the need for C2 in aviation operations for the MAGTF was identified, much about warfare has changed. While the doctrine of the Marine Corps is still based primarily upon amphibious operations, the way that operations are carried out (as well as the antagonists) has changed dramatically. General C.C. Krulak's 'Three Block War' scenario, Operational Maneuver from the Sea (OMFTS), Joint Vision (JV) 2020, humanitarian operations, and the fall of the Soviet Union, as well as the subsequent rise of rogue terrorist nations, have forced the Marine Corps to view how to fight in a different light. The two major theater war scenario is a fading reality, recently acknowledged by Secretary of Defense Robert Rumsfeld.

At the same time, technology has dramatically changed how operational forces can carry out military operations. Information Warfare and Network Centric Warfare are seen as force multipliers in today's Department of Defense (DoD). The speed and flow of information from top to bottom has been revolutionized with satellite and digital communications. In Kosovo, for the first time in the history of modern warfare, "victory" was claimed by U.S. forces without ever putting troops on the ground in combat. The ability to fight smaller, faster, lighter and from greater striking distance is feasible due to technological advances. The cumbersome hierarchal organization that was needed to receive, process, and decipher information is no longer required in the current form.

The MACCS fights within these confines. However, since the 1960's, its structure has remained unchanged in organizational structure. There is still a “stovepipe” feel to the organizations, where Squadrons in the MACG are organized along task lines. For instance, the Marine Air Control Squadron (MACS) is dedicated to the control of aircraft in an air-to-air tactical situation, where the Marine Air Support Squadron (MASS) is dedicated to operations involving aircraft used air support functions. The MACCS remains very hierarchical, with detachments reporting to the squadrons (known as centers in a tactical situation) up to the Tactical Air Command Center (TACC), fielded by the Marine Tactical Air Command Squadron (MTACS).

The MACCS is at a crossroad for organizational change, with the imminent fielding of the Common Aviation Command and Control System (CAC2S), and formation of new doctrines for the 21st century. CAC2S was conceptualized in the early 1990's as the single system solution for elements of the MACCS. No longer will each squadron use specifically designed systems, which in the past were tailored for specific missions. As all information required in C2 operations for the MAW is processed by a single system, as joint operations are at a premium, it is time to restructure the MACCS to meet the mission requirements of the 21st Century. The organization must change along with the doctrine and technology in the C2 triangle.

Focus must shift from technological solutions to organizational solutions. In a meeting held on March 17th, 2001, at the Stanford Business School, 18 Marine Corps Generals participated in a meeting with Silicon Valley IT executives. In that meeting, the executives noted that IT was not about hardware or software. Instead, IT was an *organizational ethos*, emphasizing speed in converting data to information to decisions (Jones, 1999). No organization can continue to operate in the same manner as the other two entities, technology and doctrine, change. New C2 computer systems continued to be developed, and then forced into the same organizational structures. It is expected, then, that organizations would seek marked improvements in productivity. However, an organization cannot change and improve with technology alone. Organizations need restructuring in processes and ways of doing business. This is the obstacle that stands in front of truly changing for the future – the organizational change.

The restructuring of any organization, be it military, commercial, or educational is an extremely arduous task. People naturally resist any change to the way they function. More times than not, when change is needed, it is technology or doctrine that is changed; yet the organization remains stagnant and unmoved. However, no organization can adapt to the ever-changing environment without looking at how it functions and identify where shortcomings exist. And no organization can change itself from the inside; the change must come from external sources. Whether that be having the members step away from the organization and looking back into it, or having an outside entity change it, it must occur from the outside. Barriers to change must be broken down in such a way as to offer as little resistance from the members as possible.

This thesis is intended to look at the Marine Air Command and Control System (MACCS) and take a view from the outside to offer change to the members populating it. This view of reorganization will be based upon research, interviews with members of the MACCS support community, professional publications, and individual experiences with the MACCS. The basis of experience comes from internally being involved with both the Marine Air Control Squadron (MACS) and the Marine Tactical Air Command Squadron (MTACS); as well as lengthy experience as a project officer at the Marine Corps Tactical Systems Support Activity, serving as the TACC project officer and with close ties to the MACG and MTACS. Collectively, those experiences, as well as studies at the Naval Postgraduate School, form a core that brings a unique perspective to organizational change, conviction that for some time the MACCS needed, if it were to survive in any form, a restructuring effort.

In the fall of 1996, at a briefing of the Operational Advisory Group (OAG), composed of officers within the fleet and support community of the Marine Air Control Group, changes were proposed to equipment that was going to be procured to replace obsolete computer systems within the MTACS. This was the largest gathering of MACG officers that had collectively come together in one place, at one time, for the sole purpose of interjection into the requirements and system procurement process. For one of the first times, operational forces were given the chance, along with acquisition, doctrine and training personnel, to express desires needed in new equipment. All four MTACS squadrons within the MACG had an equal voice. There were several dissenting opinions

to the final outcome, but the consensus in a viable, off the shelf, open architecture solution was decided upon. In late 1996, a meeting was held by the Marine Corps Combat Development Command (MCCDC) to discuss several options for reorganization. At this meeting, consensus was not nearly as easy to come to. It was agreed that there was a need for better, newer, smaller equipment based on open standards but few could envision massively changing the organizational structure. Thirteen different proposals were presented by an independent contractor to a collection of officers from the original OAG meeting. The conclusion was that there was a need for some sort of restructuring, but no single best solution could be determined. There was a threat to certain stakeholders in each proposal. Many refused to consider a radical restructuring of the MACCS, since the structure had ‘worked’ for so long. Absent from most of these meetings, it is noteworthy, were members from the fixed and rotary wing communities. After this meeting, several other OAGs were held. Most expanded on previous meetings. However, more and more, tasks and action items assigned from previous meetings were not being accomplished. Few seemed interested in wide spread change. It was too foreign a concept.

This thesis will lay out the organization of the MACCS, doctrines and technologies. Further, a foundation of factors that are driving change will be laid out. Finally, the method to organizational change will be discussed in the final chapter. A single, “best” solution on how to restructure will not be proposed in this thesis. Rather, insight will be offered into how obstacles and resistance to change can be circumvented, as well as why barriers exist, with the goal toward a longer-term view on becoming a more effective and relevant piece of the MAGTF in the 21st century. Consequences to NOT reorganizing, using abstracts from business and applying them to the military, will be discussed as well. Further research should be conducted, with specific models of change proposed for the MACCS.

THIS PAGE INTENTIONALLY LEFT BLANK

II. CURRENT STRUCTURE OF THE MARINE AIR COMMAND AND CONTROL SYSTEM

Several Marine Corps doctrinal publications exist that deal with Marine aviation and the Marine Air Command and Control System (MACCS) specifically. These documents lay out structure and organization, as well as detail equipment. Marine Aviation is detailed in the Marine Corps Warfighting Publication (MCWP) 3-2. The introduction by General J.E. Rhodes, published in December 2000, follows:

Aviation is an integral part of the naval expeditionary air-ground team—it extends the MAGTF's operational reach and flexibility and expands its warfighting power. Marine Corps Warfighting Publication (MCWP) 3-2, *Aviation Operations*, applies the warfighting philosophy in Marine Corps Doctrinal Publication (MCDP) 1, *Warfighting*, to Marine aviation operations. It is the link between higher order doctrines and the tactics, techniques, and procedures contained in other Marine aviation doctrinal publications. This publication establishes the doctrinal basis for the planning and execution of aviation operations and provides the philosophy for employment of Marine aviation in the prosecution of war and other operations in support of the Marine Corps' mission as the nation's expeditionary force in readiness. This publication is intended primarily for commanders and staff officers who are responsible for the planning and execution of aviation operations. Nonetheless, it should be read by all Marines who are supported by or involved in the execution of aviation operations. It is also intended for other doctrine centers, joint and multinational staffs, professional military educational activities, and any other activity that requires an understanding of Marine aviation. It explains U.S. Marine Corps aviation capabilities and how the Marine air-ground task force (MAGTF) exploits these capabilities, both operationally and tactically. It does not discuss the specifics of unit-level tactics and procedures; e.g., air-to-air combat tactics, how to conduct a helicopterborne operation, or how to attack any particular target. Rather, this publication applies maneuver warfare concepts to Marine aviation operations, especially in aviation's role as an integrated combat arm of the MAGTF.

The MACCS is more specifically detailed in both the Marine Corps Warfighting Publication (MCWP) 3-25, *Control of Aircraft and Missiles*, and MCWP 3-25-3, *The Marine Air Command and Control System Handbook*. MCWP 3-25, published in February 1998, superseded the Fleet Marine Force Manual (FMFM) 5-60, *Control of Aircraft and Missiles*. Designed for Marine air-ground task force, naval expeditionary

force, and joint force commanders, their staffs, and any other Marine Corps personnel involved in the planning and execution of aviation command and control operations, the MCWP 3-25 discusses how the control of aircraft and missiles is the function which integrates the six functions of Marine aviation into a cohesive effort. It further presents principles of aviation control; the Marine Corps' philosophy of centralized command and decentralized control, the integration of Marine control of aircraft and missiles in Marine air-ground task forces, naval expeditionary forces, and joint force operations, the responsibilities of the Marine Corps forces component commander when designated as the airspace control authority, and how all this is effected in the Marine air command and control system.

The MCWP 3-25-3, *The Marine Air Command and Control System Handbook*, was published in December 1997 as a follow on to MCWP 3-25. The Marine air command and control system (MACCS) provides the Marine aviation combat element commander with the means to exercise command and control of organic and nonorganic aviation assets necessary to support Marine air-ground task force (MAGTF) operations. The Fleet Marine Force Manual (FMFM) 5-60, *Control of Aircraft and Missiles*, addresses basic planning considerations for MACCS operations, employment, and interoperability among MACCS and joint Service agencies. The Marine Corps Warfighting Publication (MCWP) 3-25.3, *Marine Air Command and Control System Handbook*, complements and expands on the information in FMFM 5-60 by focusing on the employment of the MACCS as a whole. This publication emphasizes system interoperability, air command and control agency interface, and overarching planning considerations. Designated for MAGTF commanders, naval expeditionary force commanders, joint force commanders, and their staffs, the MCWP 3-25.3 examines MACCS functions, composition, organization, planning considerations, and employment options. By investigating these areas, the MCWP 3-25.3 provides the requisite information needed by commanders and their staffs to understand and evaluate the operational principles and capabilities of various MACCS employment options.

These documents lay out the foundation of command and control. It is a vital, necessary tool for the controlling of amphibious forces, and not tied to Marine aviation alone. Successful deployment of any Marine operational unit falls solely on how well

those forces can be coordinated to achieve a single purpose. Although command and control are vital to all MAGTF missions and units, due to the inherent technical level of aviation assets, it is probably more vital to the Aviation Command Element (ACE) than any other element in the MAGTF. As noted in the MCWP 3-25,

The management of the air portion of the Marine air-ground task force's battlespace is the first element Marine aviation performs to establish a foundation for the control of aircraft and missiles. The Marine air command and control system performs both the battlespace management and control requirements necessary for effective employment of MAGTF aviation

Marine Corps aviation is developed around six principles, or functions. These functions are the core elements to successful deployment of the ACE in support of the Marine Air Ground Task Force (MAGTF). The six functions of Marine aviation are: Assault Support; Offensive Air Support; AntiAir Warfare; Air Reconnaissance; Electronic Warfare; and Control of Aircraft and Missiles (Figure 3 is a graphical representation). It is the function of Control of Aircraft and Missiles that will be central to this document.

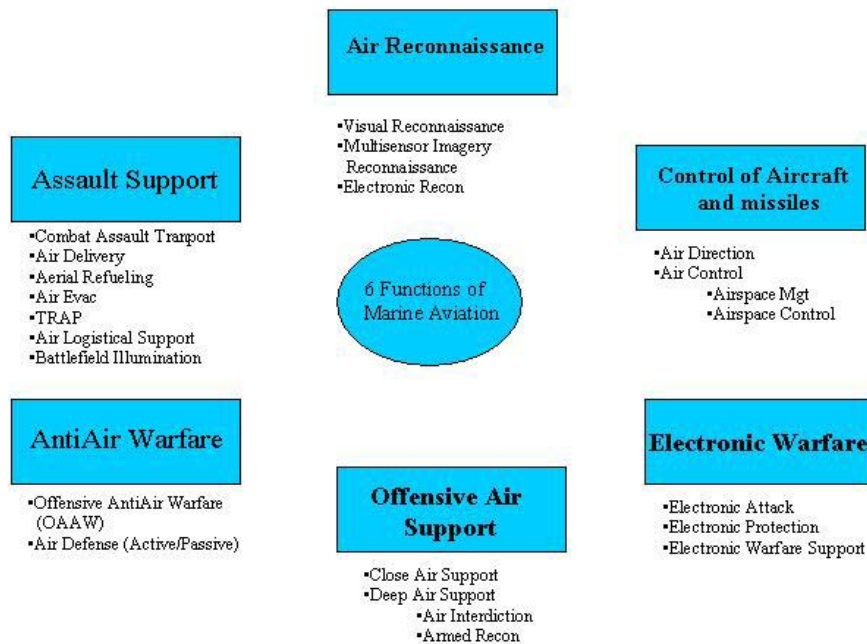

Figure 3. Six Functions of Marine Aviation.

A. ORGANIZATIONAL STRUCTURE

As previously noted, the control of aircraft and missiles is primarily performed by the Marine Air Command and System (MACCS). The control of Marine aviation forces can be accomplished by other services, and might very well be in joint situations, but for the sake of this thesis, the MACCS will be considered the primary source. The MACCS is not a technical system; rather, it is an organizational system, or a tactical system comprised of units deploying communication and computer systems in support of Marine aviation.

1. Current MACG/MACCS

The MACCS is a tactical system. When functioning properly, units of the Marine Air Control Group (MACG) are working together for the common purpose of accomplishing the function of control of aircraft and missiles of the MAGTF ACE. Control of aircraft and missiles encompasses the coordinated employment of facilities, equipment, communications, procedures, and personnel in order to enable the ACE commander to plan, direct, and control the efforts of the ACE to support the MAGTF.

Although it can be task organized, for the most part, the MACCS is the C2 arm of the ACE of the MAGTF, and is a MEF level asset. By this, it is meant that currently, the MACCS must function as a complete and whole system, with all tactical units that belong to the MACG working together, to be effective. Only when all subordinate units in the MACG are present can the six functions of Marine aviation be supported. Figure 4 depicts the breakdown of the MACG.

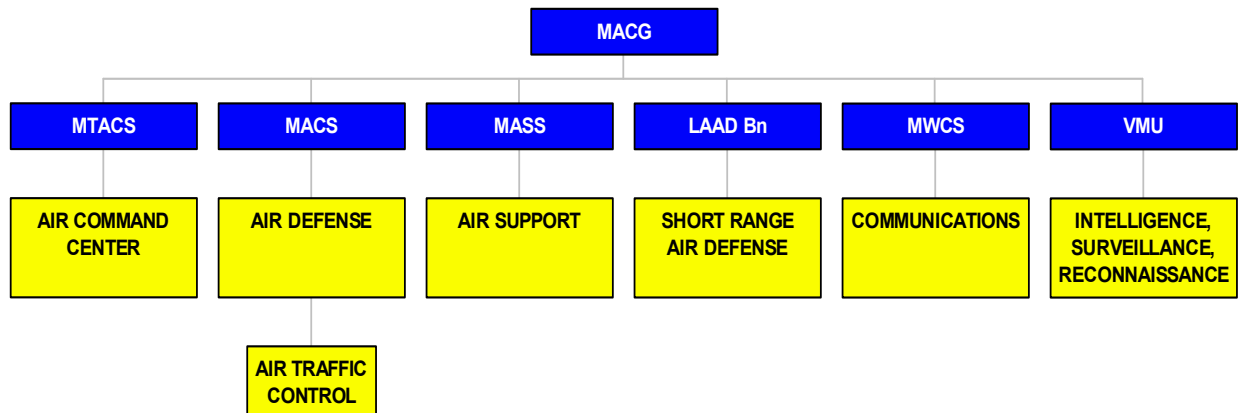

Figure 4. Marine Air Control Group Organizational Structure. [From: The Marine Air Command and Control System and Expeditionary Maneuver Warfare

Part Three: Organization]

The MACG currently consists of six squadrons or battalions. The six are:

- **Marine Tactical Air Command Squadron (MTACS)** – responsible for fielding the Tactical Air Command Center (TACC), which functions as the headquarters for the entire MACCS. The role of the TACC is to function as the senior MAGTF air command and control agency and to serve as the operational command post of the ACE commander or his designated representative; the Senior Watch Officer (SWO). The SWO can direct, supervise, control, and coordinate all MAGTF tactical air operations. The TACC's main function is to process and disseminate the Air Tasking Order (ATO) to upper and lower echelon aviation units, as well as managing the ATO mission process. The ATO is the document that is published and disseminated to all units, that depicts all air targets (on call and pre planned), as well as air assets available to support the MAGTF mission each day. This would include helicopter, fixed wing, and transport aircraft.
- **Marine Air Control Squadron (MACS)** – responsible for the fielding of the Tactical Air Operations Center (TAOC). The TAOC's main function is the tactical direction of combat aircraft, primarily in the air-to-air combat role, as well as to provide surveillance, weapons control, and traffic management of the ACE's aviation assets. Additionally, the MACS is the parent squadron to Air Traffic Control (ATC) detachments. ATC is responsible for procedural control of all aircraft within the MACCS allotted airspace. The MACS supports the Air Defense, as well as control of aircraft and missiles, for the ACE.
- **Marine Air Support Squadron (MASS)** – responsible for fielding the Direct Air Support Center (DASC). The DASC is the principle air control agency responsible for the conduct of tactical air and assault support operations directly supporting the ground forces. The DASC is additionally responsible for executing the ATO by adjusting preplanned schedules or diverting airborne assets at the request of the GCE. Further, the DASC is the agency responsible to locate and assign assets for immediate air support requests. The MASS supports OAS and Assault Support functions.
- **Marine Wing Communications Squadron (MWCS)** – The MWCS is the primary communication organization within the Marine Aircraft Wing (MAW), and is a subordinate squadron within the Marine Air Control Group (MACG). The Marine Wing Communications Squadron is tasked to install, operate, and maintain expeditionary communications for the ACE of a MEF. The MWCS is currently not responsible for the fielding of sensors or radar systems organic to the MACCS.

- **Low Altitude Air Defense Battalion** – responsible for the fielding of shoulder fired Stinger missiles and the vehicle mounted (Avenger) missile system. Provides a low altitude air defense system for the Marine area of responsibility.
- VMU – responsible for fielding and operation of remotely piloted vehicles to be used in reconnaissance roles.

2. Historical Overview of MACCS Structure

The MACCS was developed during the Vietnam War era in response to the growing need for a better command and control function to support Marine aviation efforts. The original structure was designed in its current form due to the type of control required during the Vietnam years. Highly structured command and control was required because of technically advanced avionics in Marine aircraft, the need for such aircraft to perform specific missions, and the fact that technology at the time dictated a highly vertical system of checks and balances.

As an example, Marine ground forces required air support for mission accomplishment. Close air support is a true force multiplier for Marine ground forces, allowing for indirect fire support out of range of ground artillery. Due to the fact that attack aircraft at that time, namely the A-4, were not as technologically advanced as today's aircraft, precise control to put bombs on target was a requirement. The Direct Air Support Center (DASC) was created, staffed, and equipped to provide that mission of directing attack aircraft from their holding, or 'stack' point, to a target with precision.

Likewise, air-to-air combat was an integral part of the Vietnam air campaign. Fighter aircraft (F-4 Phantoms) did not contain the onboard avionics that are prevalent in today's more sophisticated fighter aircraft. A need to get fighter aircraft from an airbase or carrier to intercept hostile fighter jets was identified. The Marine Air Control Squadron (MACS) was given that mission of controlling combat fighter jets and launching anti aircraft missiles to defend Marine assets.

The Tactical Air Command Squadron (TACC) was designed as a facility from which information from the MACS and DASC, that is air to air intercepts and air to ground attacks, as well as helicopter sorties and cargo transports, could be passed up to be collected and evaluated during the day to day operations. Additionally, the TACC was the facility from which air campaigns were planned and executed. The tenet of

“centralized command, decentralized control” was followed – the TACC commanded, the MACS and DASC controlled.

B. CURRENT AND EMERGING TECHNOLOGY

The MACCS equipment was developed and fielding in a ‘stove pipe’ fashion. Newer systems are being developed in an open architecture fashion. This section will discuss the current systems employed by units of the MACCS and address new, emerging systems that are being planned for fielding in the next decade.

1. Stovepipe Systems of the MACCS

Since its inception, the MACCS has fielded, and currently uses, legacy systems that can be considered “stovepipe”. These systems were designed with a singleness of purpose. Due to the structure of the MACCS, there was a limited ability to share data and information amongst units within the MACCS. The only way of sharing information was to verbally pass it from lower echelon (TAOC, DASC) units to higher echelon (TACC) units, or to pass rudimentary orders via Tactical Digital Information Links (TADIL).

Due to this fact, systems were designed with no regard for reuse of technology. Although many of the functions of the TAOC are replicated at the TACC (in fact, the TAOC, in event of a catastrophic failure at the TACC, will serve as the Alternate TACC), two separate systems were developed. The only data automatically shared between the TAOC and TACC were aircraft tracks passed in the form symbols via TADIL. ATO or other reports were disseminated manually (in paper or verbal form), and updated by hand. No database sharing of information was available.

These stovepipe systems were in use up to the Desert Shield/Desert Storm era. During the post DS/DS era, all units have either replaced their older stovepipe systems with newer ones, or made upgrades to these systems. Most systems have become hybrids. Although they still are designed with a single purpose in mind, some parts are being modified for the common sharing of information between units. Since 1991, the following upgrades or replacements have taken place:

- **TAOC** – replaced the AN/TYQ-2 and AN/TYQ-3A Tactical Air Operations Central (TAOC) with the AN/TYQ-23 Tactical Air Operations

Module (TAOM). Improvements upon the TAOC with the TAOM allowed for ‘modularization’ of the system. Each TAOM can function as an independent system, linking to sensors, as well as containing its own single channel radio assets and cryptographic equipment.

- **TACC** – replaced the AN/TYQ-1, Tactical Air Command Central with, first, the AN/TYQ-51 Advanced Tactical Air Command Central, and then a conglomerate of Commercial Off the Shelf (COTS) equipment and jointly used systems, housed in portable cases and shelters. Equipment allows for ATO development and processing of airspace tracks via datalink, all displayed and processed on commercial Sun desktop computers.
- **DASC** – replaced older DASC equipment with, first, the Improved DASC (IDASC), and then the current High Mobility Downsized (HMD) DASC. This allows the DASC to function within the MACCS out of High Mobility Multi Wheeled Vehicles (HMMWV), outfitted with radios and computers.

2. Common Aviation Command and Control System (CAC2S)

In response to growing budget concerns and the ever-increasing need for interoperability among units of the MACCS, as well as a drive toward open source systems, other Marine C2 units, and joint C2 agencies, the desire for a common C2 platform for all Marine Air Control Group units was proposed in the early 1990’s. Termed the Common Aviation Command and Control System (CAC2S), the objective of this system will be to leverage off of current, commercial off the shelf (COTS) technology to provide an open architecture system that allows for scalability, modularity, and interoperability. The Defense Information Infrastructure Common Operating Environment (DII COE) is the basic operation system that is used to ensure interoperability with other C2 systems. The CAC2S Mission Needs Statement (MNS) was signed in April 1995, with an Operational Requirements Document (ORD) approved in November 1997.

Specifically, Marine Corps Combat Development Command (MCCDC) defines CAC2S as follows:

CAC2S provides a common hardware platform with a suite of common software that can be scaled and tailored to support mission planning and execution for any or all aviation command element operations. CAC2S will be interoperable with joint, allied, and coalition forces and can operate in a variety of mobile (air, ground, ship) operational nodes tailored to meet aviation mission and planning functionalities.

CAC2S is designed to eliminate the stovepipe systems of the past. Similar to the way computers in commercial industry look and feel the same (where an individual can sit down and perform any task he or she requires), the goal for CAC2S is to have a single computer for any individual. Regardless of what mission you must perform, or what squadron you belong to, CAC2S will be a single system, with a common workstation and operating system.

3. Joint Systems

Other services have adopted the open architecture C2 system approach as well. It is imperative that our systems are able to seamlessly interoperate with other services to accomplish any mission. A system such as the Air Force's Theater Battle Management Core Systems (TBMCS), which in essence is the Air Force version of CAC2S, is a good example. TBMCS integrates a suite of C2 applications, and a full range of air mission functions, sensor data and intelligence gathering, and automates many elements that comprise the planning and execution phases for theater air operations. TBMCS can generate detailed air tasking orders (ATO), almost three times the present level of information, providing more detail about targets and the mission, requiring one-third fewer planners and in half the time. TBMCS is designed to replace all old, legacy Air Force C2 systems. Although primarily built for the Air Force, it does have several joint segments that will be common to all DoD services. Specifically, it was required to be used for the processing of the ATO by all services. As such, our systems must interoperate with TBMCS on some level.

The Air Force, Army, Navy, and Marine Corps all have diverse missions and tasks such as how to build and tailor systems to meet the mission of an individual service, yet have the flexibility to interoperate, not just interact, with the systems of other services. The seamless transfer of data, database information, and common air tracks – all present a problem for designers, users, and program managers alike. Technology of the 21st century will rely on satellite communications, wireless computing, and smaller unit decision making more than ever.

C. CURRENT AND EMERGING DOCTRINE

The mission and objective of the Marine Corps – locate, close with, and destroy the enemy by fire and close combat – has remained relatively unchanged for 225 years.

However, in the decade since Desert Shield/Desert Storm, new missions and doctrines for the Marine Corps and other services have emerged. These doctrines have developed in response to the ever-changing global landscape. The major regional conflict scenario is being diminished and replaced by threats of terrorism, low scale nuclear conflicts, and humanitarian efforts. As such, the Marine Corps and the DoD in general have adopted new doctrines on how to fight in the 21st century.

1. JV2020

As described in the document, Joint Vision 2020

JV2020 builds upon and extends the conceptual template established by Joint Vision 2010 to guide the continuing transformation of America's Armed Forces. The overall goal of the transformation described in JV2020 is the creation of a force that is dominant across the full spectrum of military operations – persuasive in peace, decisive in war, preeminent in any form of conflict. The joint force, because of its flexibility and responsiveness, will remain the key to operational success in the future. The integration of core competencies provided by the individual Services is essential to the joint team, and the employment of the capabilities of the Total Force (active, reserve, guard, and civilian members) increases the options for the commander and complicates the choices of our opponents. To build the most effective force for 2020, we must be fully joint: intellectually, operationally, organizationally, doctrinally, and technically. The overarching focus of this vision is full spectrum dominance – achieved through the interdependent application of dominant maneuver, precision engagement, focused logistics, and full dimensional protection. Attaining that goal requires the steady infusion of new technology and modernization and replacement of equipment. However, material superiority alone is not sufficient. Of greater importance is the development of doctrine, organizations, training and education, leaders, and people that effectively take advantage of the technology. (JV2020, 2000)

What is of significance here is the “material superiority alone is not sufficient...of greater importance is the development of doctrine, organizations..., and people that effectively take advantage of the technology”. This lends itself to the point that will be made later – technology solutions are not always solutions.

The joint force is the preeminent force of readiness in the 21st century. Although the Marine Corps will be called on to perform missions as a self contained force in readiness, on most occasions it will be required to fight with sister services. This

doctrine should be central to our organizational and technological makeup. We must be able, and willing, to seamlessly fight with other services.

2. OMFTS

In the late 1990's, the Commandant of the Marine Corps, General C.C. Krulak, signed Operational Maneuver from the Sea (OMFTS). In his foreword, he writes:

In the White Papers ... and Forward ...from the Sea, the Navy and Marine Corps presented a common vision for a future in which skillfully handled naval forces would enable the United States to exert its influence in the littoral regions on the world. Building upon the foundation laid by those papers, deals explicitly with the full spectrum of challenges that we will have to face, the dangers and opportunities created by new technologies, and the very exciting prospect of adapting the tradition of maneuver warfare, not merely to amphibious operations, but to all aspects of warfare in and around, coastal waters. (OMFTS)

The purpose of OMFTS is to present a document for the 21st century of Marine and Naval warfighting. OMFTS uses maneuvers of naval forces at the operational level (three levels include: Strategic, Theater, Operational) to strike at the heart of the enemy's center of gravity. For this to work, a C2 system, integrated to combine all forces (air, land, sea) must be capable of rapid decision making. As OMFTS points out, fundamental changes in the area of education and doctrine is the key to success, more so than in the area of hardware. It also stresses that aviation (and, by default, aviation C2) must be employed as an integral part of the naval expeditionary force. With the current MACG design structure, true expeditionary deployment is not possible. The MACCS cannot function in the Marine Expeditionary Unit (MEU) arena. To be relevant to the MEU mission, the MACCS must be more flexible and lighter than the current encumbering state it is in.

3. Marine Corps Strategy 21

Marine Corps Strategy 21 is currently Commandant James Jones' vision for how the Marine Corps will not only fight and win our nation's battles, but develop Marines to be citizens of the country as well. The vision of Strategy 21 capitalizes on innovation, experimentation, and technology. At the same time, it puts a premium on jointness, naval force projection, and the ability to react to any situation, a total force in readiness. It

supports JV2020, and notes that every MAGTF must be a scalable force. This suggests that Air, Ground, C2 forces must be broken down into the smallest piece, that is, a MEU. As pointed out, the MACCS is not MEU capable.

4. MCDP 6 – Command and Control

Marine Corps Doctrinal Pub 6, Command and Control, lays out the Marine vision for all C2 for Marine operations. As MCDP 6 points out “no single activity in war is more important than command and control”. Chapter 3 of the publication speaks about Command and Control theories. Specifically, organizational theory is laid out in the document. Narrowing the span of control – deepening the layers of command and lessening the number of immediate subordinates – will result in slowing down the information moving up or down the chain of command. MCDP 6 points this out in Chapter 6, but also notes that a flat organization can exist when the widened span of control can be controlled. This is important to note. As will be discussed in Chapter III of this document, organizational structures, at least in industry, are increasingly becoming ‘flat’. The notion of information moving slowly up the chain of command from lower ‘units’ to upper tier decision makers is obsolete due to the proliferation of communication speed. How the Marine Corps will react to such a change in thinking remains to be seen. Flat organizations empower decision making at the lowest level. Yet, there is an inherent desire to maintain control at the top. A fluid battlefield requires quick decision making at the center of gravity. Deep organizational structures (like that of the MACCS) will be replaced by flatter organizations to maintain the speed required of fast tempo operations.

III. DRIVERS OF CHANGE FOR THE MACCS

Carter McNamara, PhD, writes in Basic Context for Organizational Change (McNamara, 1999),

The concept of organizational change is in regard to organization-wide change, as opposed to smaller changes such as adding a new person, modifying a program, etc. Examples of organization-wide change might include a change in mission, restructuring operations, new technologies...Some experts refer to organizational transformation. Often this term designates a fundamental and radical reorientation in the way the organization operates.

The Marine Corps, and the MACCS, is prime for reorganization. As documented, new technologies, which allow for automatic transfer of information in a timely manner (as opposed to voice) and new doctrines which are being formulated to place emphasis on speed and timely decision making on smaller unit levels, are driving the way the MACCS is organizationally structured. Dr. McNamara says that organization wide change might include changes in mission and technologies. As the C2 triangle in Figure 2 shows, technology, doctrine and organization are intricately tied together. Two cannot change without the third changing as well. This is the main driver of change. The MACCS structure cannot remain stagnant while the others continue to evolve.

Additionally, Dr. McNamara writes,

Change should not be done for the sake of change -- it is a strategy to accomplish some overall goal...usually organizational change is provoked by some major outside driving force...typically, organizations must undertake organization-wide change to evolve to a different level in their life cycle

If the MACCS is to change, it must be done to achieve the goal of functioning more effectively and efficiently. The consequence of not operating in a manner more fitting to the current missions of the MAGTF is obsolescence or irrelevance. However improbable, budget constraints and personnel cutbacks could lead to looking to joint C2 units to provide the mission currently supported by MACCS.

A. DESERT STORM TO PRESENT

The MACCS was last used, operationally and as a whole, during Desert Shield/Desert Storm. During the operation (which lasted from August 1990 to April 1991), the MACCS functioned in a MEF level operation. The MACCS contribution to the warfighting effort can be seen as both a success, and as an after action report from the Commanding Officer, VMFA-235, points out, a failure as well.

The MACCS was successfully deployed to Saudi Arabia during the Gulf War buildup. The TACC worked with joint and coalition forces to conduct the air war, while the MACG subordinate units functioned within the MACCS structure. This is the only example of the MACCS being deployed, outside of exercise scenarios, since the end of the Vietnam War. It was not deployed during Bosnia, Kosovo, or any other recent crisis in which the Marines or U.S. military has been involved. Although it was deployed and had involvement in the operation, it was not necessarily looked upon as being a ‘fluid’ system that was necessary to the success of the campaign.

A Marine Corps Lesson Learned System (MCLLS) submission from the Commanding Officer of VMFA-235, submitted after the campaign notes, “The Marine Aviation Command and Control System (MACCS) stymied the effective and efficient use of aircraft due to the inherent and well known shortcomings...”. By this statement, the assumption would be that the MACCS leaders take action to correct the deficiencies. First, it is written by a Marine aviation commanding officer involved in the war; second, it is precisely this arm of the MAGTF that the MACCS is designed to serve. If the MACCS, in its current form, could not serve the MAGTF during the largest buildup of U.S. forces in the past 25 years, to expect that it can function and serve the MAGTF now with the missions and threats facing the military in the 21st century would be shortsighted. As noted by the same officer a decade ago “Now is the time to reevaluate our MACCS structure” (MCLLS, 1991).

B. TECHNOLOGICAL ADVANCES

Due to the rapid pace that technology matures (according to Gordon Moore, co founder of Intel, chip speed will double its capacity every 18 months), systems become obsolete much faster than in the past. Although technology and computers have been central to the MACCS since inception, long lead times in the development of systems

cannot be accepted. In an interview with a program officer at Marine Corps Systems Command, initial operating capability (IOC) for CAC2S will occur sometime in FY 06. This is far too long of a development cycle to expect that requirements developed presently would still be relevant at IOC. With the proliferation of smaller enemy states that have capabilities to infiltrate military C2 networks, more care must be put into securing systems. A system based on today's technology will be four generations of computer power behind industry by fielding. Marine Corps Systems Command has not yet factored in satellite communications, digital communication, ever-increasing bandwidth, and network centric systems with interoperability joint forces in the plan for either CAC2S or the MACCS reorganization. Rapid development of a "70%" solution to fix technological shortfalls should replace long lead times to develop and field specifically tailored systems; that is, a 70% solution fielded now is better than developing what is considered a 100% solution, and deploying that system when it is obsolete.

The Naval Research Advisory Committee (NRAC) was tasked by the Marine Corps to evaluate its command and control systems interoperability late in the 1980's. In the report on the interoperability issues (NRAC, 2001), the panel noted:

Major organizational changes in the Marine Corps are currently being implemented which have the potential for improving the management of intra/interoperability issues. Other encouraging indications include the good progress being made in Marine aviation-specific systems, and the excellent cooperation between the Navy and Marine Corps in addressing and resolving interoperability problems between the two Services.

The panel noted that the goal of integrating systems (such as CAC2S) was a correct course of action for the Marine Corps. The panel noted:

The goal of an integrated tactical C2 system correctly anticipated needs of Marine Corps commanders for automated decision aids based on enhanced battlefield information pressing, display, and communication. This need has become acute in recent times because of two trends, both of which are expected to continue in the foreseeable future. First, advances in sensor systems are contributing to enormous increases in the volume of tactically significant information. Second, increasing mobility of tactical forces is confronting commanders with shrinking decision times.

Additionally, NRAC pointed out that:

Command and Control data communication requirements for all phases of MAGTF operations, including over-the-horizon assaults, should be re-evaluated. Interface and data-traffic load requirements should be analyzed. All critical system design constraints (such as data security/integrity and system robustness) must be defined. Architecture should be adopted which satisfies near term needs and can also support future growth.

All of this points to the open architecture, evolutionary approach to systems design that allows for growth and expansion, vice revolutionary development, with long lead times in testing and fielding. Building ‘open architecture’ systems, based upon COTS and emerging technology, appears to be the flagship course of action. Careful adherence to the Deputy Under Secretary of Defense for Science and Technology (DUSD, S&T) Software Intensive Systems Directorate must be followed. In the directorate, the Software Program Managers Network (SPMN) 16 Critical Software PracticesTM are spelled out (SPNM, 2001). Ignoring documentation that derives from trends in technology leads to the creation of more stovepipe systems that could be obsolete before fielding.

C. PROFESSIONAL PAPERS/INTERVIEWS

In the August 2000 edition of the Marine Corps Gazette, Captain Matthew Sieber, in an essay titled *Marine Air Control Group – Be Gone* writes about dramatically altering the MACCS as it is known. This article took 2nd place in the 1999 Chase Prize Essay Contest. In the article (Sieber, 2000), Captain Sieber, an air command and control officer, suggests

The rapid growth of technology will certainly drive us toward a Marine air-ground task force (MAGTF) network centric command and control (C2) system and away from specialized Marine air command and control system (MACCS)

Additionally, he notes that

The fundamental shift in paradigms from specialized and centralized C2 to a flatter, general, and decentralized C2 system allows us to observe, orient, decide, and act operationally at a faster tempo than ever before

This is precisely what is driving the need to reorganize. However, the article tends to lead to the reshuffling of the nodes of the MACCS, vice truly reengineering organization and functionality. Not unlike other articles on organizational change, there

is a recommendation to shift things around, vice eliminate or function, differently. The article talks about the “absorption of functions of the MACG”, and eliminating it. This does not solve the bigger issue – fundamentally working differently. In this scenario, the MACG dissolves and the functions of air support or air control go to other locations.

In the May 2000 Marine Corps Gazette, Colonel James Thigpen, Commanding Officer of MACG-28, writes the summation article (Thigpen, 2000) to a series written about the MACCS and mentions

Historically, it has been difficult to synchronize advances in equipment, organization, and doctrine simultaneously...but, a word of caution...we can go too far in “fixin’ what isn’t broke.

While on the one hand, Colonel Thigpen writes of wanting to challenge the current structure to see if it still works, he counters with a view that the MACCS is flexible, scalable, and has more technically sophisticated Marines, and can function efficiently as is.

This seems to be the widely held view amongst the officers (midrange Captains and Majors) interviewed. While upper level commanders hold a belief that the MACCS is better today than in the past, the younger generation of officers see a strong need to change or eventually they can see the MACCS as being irrelevant to the MAGTF.

During research in Washington D.C. in May of 2001, interviews with representatives at the Marine Corps Systems Command, Marine Corps Aviation Requirements Division, Headquarters Marine Corps, and contractors were conducted. Opinions were expressed on the MACCS based upon experiences and current roles. Opinions were varied.

Currently, Headquarters, Marine Corps, Aviation Department (APC) is in the process of publishing a three part series of booklets on the MACCS. The Marine Air Command and Control System and Operational Maneuver from the Sea (Part One: The Roadmap), and The Marine Air Command and Control System and Expeditionary Maneuver Warfare (Part Two: MACCS Employment Options) have already been published and released. The assistant to the director of aviation command and control is drafting Part Three, Organization, which will deal with MACCS reorganization. APC

takes note in Part Three that the MACCS has not changed, and attempts to lay out a framework for change. Specifically, Part Three notes:

Over the past four decades the Marine Air Control Group has not experienced major organizational changes. Although some of the names, numbers and types of subordinate units have periodically changed, its basic structure has not. Today's MACG and MACCS reflect a dated organizational structure that it is now time to review and reconsider in light of the challenges it must face as it moves into the 21st century. The MACCS must evolve from its current form to a new, significantly altered one that can better support the MAGTF within an ever changing and dynamic environment, especially on the non-linear, decentralized battlefields of the future.

The document talks to a two-phased approach for change. Phase I is near term and is referred to as a "Functional Model". Phase II is called a "Cross-Functional Model". The goal is for Phase one to be completed between 2006 and 2010. Phase II is set to be implemented between 2012 and 2015. Although organizational change cannot occur rapidly, a timeframe of that length would suggest that changes implemented now may be irrelevant in 15 years, even obsolete by that point. As an example, APC views current radar systems still being in use in 2015, retaining the need to be a self contained C2 system (autonomous from fighting jointly), but have not accounted for satellite or digital communication technology that will be highly evolved by 2015. Changing must take into account expanding technologies and make concessions for them.

The flaw with this approach is that the plan for reorganization is set too far out, and that no accounting is made for massive improvement in technologies in the next decade. APC sees that reorganization is vital, but the development of a plan to achieve it cannot be attained from within the organization. APC is trying to reorganize itself, internally, which makes true reorganizing nearly impossible.

A second interview was conducted with the Aviation C2 Requirements Coordinator at the Marine Corps Combat Development Command (MCCDC) (White, 2001). The discussion revolved around a new mindset of 'task organization' for the MACG, and for the dissolution of the TAOC and DASC functional breakdown. The view of MCCDC appears to be that the emerging technology of CAC2S will push the MACCS away from command and *control* to command and *coordination*. The word

control refers much more closely to observing and directing units, people, and aircraft. In the past, control was needed due to the limitations in electronics, communications, and avionics. Today, though, there is a move to coordination. Coordinating is much more arbitrary, as it seeks to set in motion events and allow subordinates to work independently.

As there is a move toward command and coordination, the need for traditional MACCS structure dissolves. The Major noted, “making everyone get rid of their ricebowls will be near to impossible”. The view of the Commanding Officer from VMFA-235 was also supported by questioning the relevance of the MACCS during the conflict, yet with concerning how, there seemed to be a strong opposition to acknowledging the shortcomings.

A final interview was conducted with a contractor who had formerly worked for the Marine Corps Systems Command (MARCORSYSCOM) (Hingle, 2001). The company contracted was to create a model, using the Universal Modeling Language (UML), and to determine if CAC2S could facilitate the elimination or restructuring of billets within the MACCS. Data networks replacing analog networks would allow for timely passing of information via automated channels, as opposed to the traditional means of voice or manual transmission.

Funding for the contract was cut, and the contract disbanded at the beginning of FY2000. There was a belief that some of the data derived from the modeling showed that the Table of Organization (T/O) could be restructured, or even downsized, with CAC2S driving the new way the MACCS could function. Commanders are very reluctant to ever give up personnel billets, even if they are not necessarily vital to the mission, simply because it becomes nearly impossible to retrieve those billets at a later date. Perhaps a point of note would be that the Assistant Program Manager (APM) who hired the contractor was a CH-48 pilot, “outside” the organization and thereby less of a stakeholder in the MACCS. Perspective on a need for restructuring would be different than that of other individuals in the organization.

D. CONSEQUENCES

There would seem to be consequences to not restructuring the MACCS. Among them is the possibility of obsolescence, forced downsizing, dissolution, mission failure, and even a loss of trust within the Marine Corps aviation community. Organizations that do not change over time can find themselves to be irrelevant to the mission accomplishment they are designed to accomplish. If the MACCS were to either continue to function in the manner up to, and after, Desert Shield/Desert Storm, or to push reorganization off to the next decade, there is a risk of losing a 'mission' altogether to other forms of C2 (Navy E-2C, Air Force AWACS, or MAGTF C2 systems). The MACCS has a definite place in aviation and MAGTF, but only when it supports the current mission of Marine Aviation.

E. STREAMLINING THE MACG

Reorganization of the MACCS is being addressed by the Aviation branch of Headquarters Marine Corps (code APC). It was first noted in the pamphlet The Marine Air Command and Control System and Operational Maneuver from the Sea: Part One, The Roadmap. Organization is talked about toward the end of the booklet. The authors point out

Technological trends will drive force structure toward flattened, more effective, and more flexible command organization, resulting in better overall coordination and reaction times. These enhanced organizations will complement greater joint interoperability, reduced embarkation footprints, and open architecture systems based on common hardware and software. Specialized air control unit organizations may evolve into cross-functional commands capable of multifunctional command and coordination operations.

The admission to the fact that technology will force a flattened organization is a key point to the quote. Also, the authors use the term 'command and *coordination*'. Nothing is mentioned on *how* to achieve this organizational change, however. To say it has to be done is easy; to make it happen is very difficult.

In an article for the Marine Corps Gazette of May 2000, Colonel James E. Thigpen, Commanding Officer, MACG-28, writes

We must at least be willing to ask ourselves if we can organize differently to employ these weapon systems more effectively – to challenge the

current paradigm to see if it remains valid. It may well be that we find that these new technologies and processes are limited by our unwillingness to consider a new order of things.

He also writes

...it doesn't make much sense to employ new processes and technologies in the old order of things – if the processes and technologies are specifically designed to help us do things differently...historically, it has been difficult to synchronize advances in equipment, organization, and doctrine simultaneously.

Those statements support the notion of having to change the MACCS organization to meet the changes in doctrine and technology. Colonel Thigpen backs off a bit with noting ... “a word of caution. We can go too far in ‘fixin’ what isn’t broke”.

There is now, and will continue to be, a cautious attitude toward reorganization. This is inherent in any organization that wishes to restructure itself. People naturally resist change, especially in the military, where change can result in budget and personnel cuts.

It is apparent from these quotes that organizational change is seen as a necessity. In The Marine Air Command and Control System and Expeditionary Maneuver Warfare: Part Three, Organization (which at present time is still in draft form), reorganization is addressed. In the overview, the authors of the document state

Over the past four decades the Marine Air Control Group has not experienced major organizational change. Although some of the names, numbers and types of subordinate units have periodically changed, its basic structure has not. Today's MACG and MACCS reflect a dated organizational structure that it is now time to review and reconsider in light of the challenges it must face as it moves into the 21st century. The MACCS must evolve from its current form to a new, significantly altered one that can better support the MAGTF within an ever changing and dynamic environment, especially on the non-linear, decentralized battlefields of the future.

The plan for reorganization is spelled out over a 15-year cycle, and makes no concessions for the rapid improvements in technology, such as satellites, the proliferation of networks and World Wide Web technology, or how wireless, digital communications will affect command and control. The current plan, under APC, calls for a phased

approach to reorganization. The models for this approach are shown in Figures 5 through 8. :

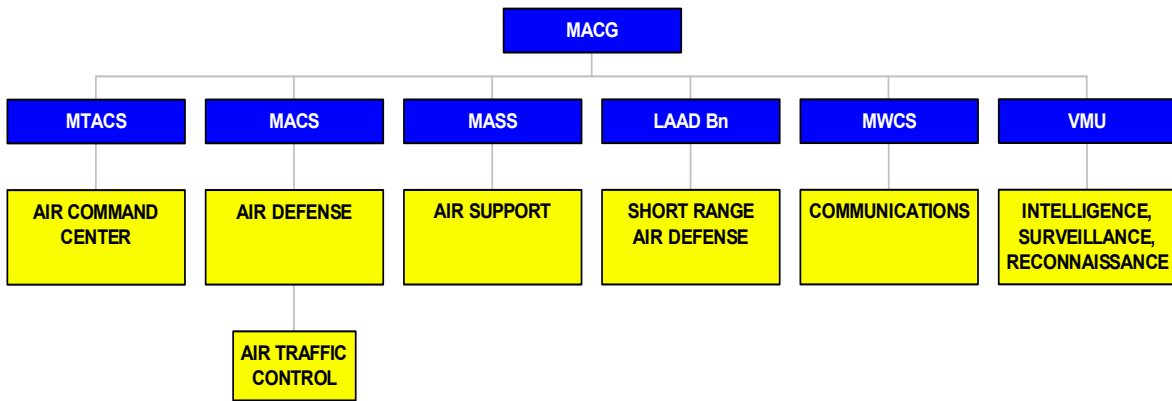

Figure 5. Current MACG Organization. [From: The Marine Air Command and Control System and Expeditionary Maneuver Warfare Part Three: Organization]

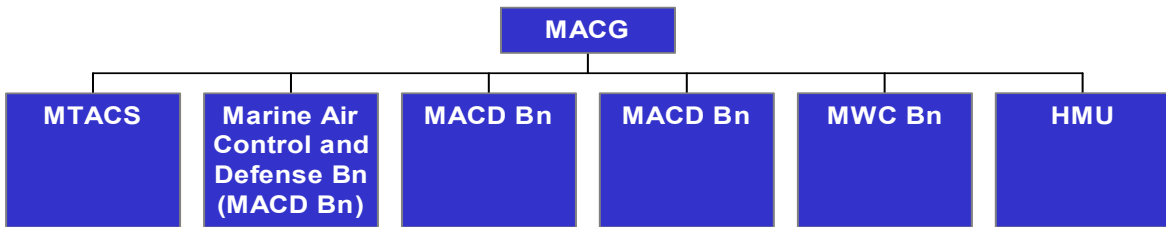

Figure 6. Phase 1 Reorganization. [From: The Marine Air Command and Control System and Expeditionary Maneuver Warfare Part Three: Organization]

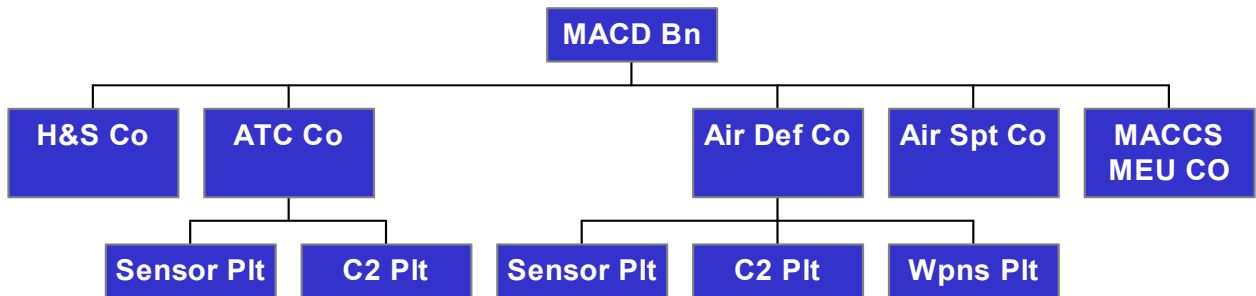

Figure 7. MACD Bn Organization under Phase 1. [From: The Marine Air Command and Control System and Expeditionary Maneuver Warfare Part Three: Organization]

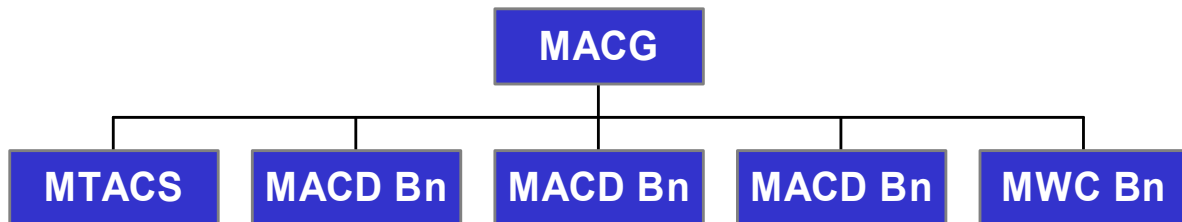

Figure 8. Phase 2 Reorganization. [From: The Marine Air Command and Control System and Expeditionary Maneuver Warfare Part Three: Organization]

Several other statements in the publication stand out, as well. Amongst them are:

- ‘These unique organizations (the current structure) do not optimize the use of information technology’ – organizations should function efficiently outside of the realm of technology.
- ‘Organizational theory provides for a number of design options that may increase the efficiency of the MACCS’ – there is no explanation of what that organizational theory is exactly. APC will need to study the effects of organizational change, theories on changing, drivers of change, and models. This is not a small task.
- ‘In the next few years, 2004-2008, “MACCS Convergence” will occur...this will utilize improved information technologies and will allow the MACCS to transform its organization’ – the convergence is in two phases (as shown in the figures above), and reaches out to 2015. If the MACCS is organizing based on today’s technology, then to assume that the reorganization will be relevant with 2015 technology is to ignore the fast pace of technology’s evolution.
- Organic sensors, such as ground-based radars, are the only source of sensor data mentioned, with no consideration given to satellite based sensor capability that is expanding in scope amongst the other services.

When the organizational models are studied, some models can lead to the reshuffling of the same pieces. Although Battalions are formed, with Air Defense and Air Support, as well as Air Traffic Control (ATC), under them, these Battalions are essentially the same as the squadron formations that exist today. Air Tasking Order (ATO) development and management are still the primary functions of the MACCS in

low intensity conflict missions. In this, helicopter and transport aircraft, as well as a small amount of close air support aircraft, are the primary functions of Marine aviation. Yet, in the new organizational model, there still remains a single MTACS, or TACC, for each MACG. Air defense, support, and traffic control will exist in each battalion, leaving one command element, the TACC, for all of them. A structure that allows each battalion to function autonomously, from command down to control and coordination, is a more far-reaching goal, it would seem.

The main point that must be brought out from reviewing APC's document about changing the MACCS is that the model for change is being drafted within the organization. True organizational change can only occur from outside the organization. Members of an organization cannot change themselves. They must physically or mentally remove themselves from the organization in order to process this change. In that manner, they no longer become stakeholders, and are no longer resistant to the pressures to keep the status quo.

IV. PROCESS OF ORGANIZATIONAL CHANGE

Victory will go to the highly imaginative and those least fettered by conventional notions of what an organization has to be. - Tom Peters

Based upon new, emerging technology that is going to be designed to provide for more network centric command and control (or coordination), as well as doctrine of warfighting based upon highly flexible, task-oriented maneuver, the MACCS is primed for reorganization of structure. Within the MACCS field, it has been identified by support commands and individual fleet and staff officers that we must reorganize to remain viable to the aviation C2 mission. This begs the question of *how* to reorganize. This chapter will explain that organizational change is a highly complex task that requires thought and acceptance. No organization can reorganize itself in a vacuum. Stakeholders in any organization naturally resist even the basic tenets of reorganization. Members of any organization will draw upon how things “have always been done”, and either resist the change altogether, not accept the change, or simply look to do things the same way within the new organization. Expert writings in the field of organizational change and behavior will show how the MACCS must approach the change.

A. ROLE OF TECHNOLOGY

The open systems theory for setting forth organizational change by application of information technology is one that must be considered if the change is to be considered effective. Dr. Yogesh Malhotra, PhD, drawing upon numerous sources, proposes several theories as to how IT can be used to drive the change of organizations. As environments become more turbulent, organizations must adapt at the same rate to maintain its advantage. Among his theories are that the turbulent environments (in this case, business, but can translate to the turbulent military conflict environment) drive organizations to use IT for empowering workers at all levels, increasing span of control, and increasing lateral communications. (Malhorta, 1993)

A growing number of managers and professionals believe that information technologies can drive organizational change (Kling, 1998). Computers and communication technologies are seen as a way to streamline operations, and facilitating

distributed decision-making authority. However, understanding the organizational implications of adopting new technologies can be difficult for organizational planners.

1. Productivity Paradox

The ‘productivity paradox’ sheds light on the role of technology in defining how the MACCS can improve on the practices of command and control. Studies have continually shown that technology is not a deciding factor in how productive either an organization, business, or people can be. Technology, therefore, must solely be looked at as a tool that assists an individual in performing tasks, or a substitute for a task.

A business example can highlight this issue. In 1971, Citicorp faced a problem with changing the ways that they processed business transactions (Seeger, 1974). The bank’s Operating Group was one of six organizationally functioning groups within the company. As Citicorp grew in size, so did the Operating Group. The volume of paperwork was ever increasing. Functions included transferring money between domestic and foreign accounts, processing checks, print and mail statements, and handle incoming and outgoing calls and telegrams. When new management took over, in the effort to streamline and improve these processes, a study was conducted and realignment was suggested. One of the most important issues for the Operating Group to face was to what extent the problems faced could be fixed with technology. And, although the computer facilities had grown, the basic process performed had remained the same. They were basically doing the same work with new technology, vice making the technology work for them. And, in the end, it was decided that a new computer system would be brought online and implemented, almost overnight, to fix the problem.

However, productivity did not improve. There was a resistance to the new technology. The change was accompanied by fear. Fear that if the workers did not accept the new technology, that high level management would fire the employees. Within a year, the computer system failed, and it directly affected customers. There were indicators that it would fail during this time, but high-level management perceived that all was well, while those who used the system saw many flaws in the system.

In the end, what it took to improve the Operating Group was a shift in HOW they did business and not what they did it with. Additionally, the Operating Group

management did not predict user backlash. As the Marine Corps continues to develop CAC2S, it must take into account how the technology will be viewed and accepted by end users, and whether that technology will truly improve productivity.

2. Disintermediation

Up until this point, Marine aviation C2 has been a vertical, highly structured system. This “verticalness” has always been facilitated by the need to pass information either manually or via analog voice channels from lower to upper echelon decision makers. A lack of readily available real time information has made it so that decision making is structured with command at the top, and control at the bottom, of the decision making chain. This has promoted the requirement for many ‘middlemen’, namely enlisted recorders and radio operators, as well as mid grade commissioned, and staff non-commissioned, officers. These individuals are all part of the checks and balance system to ensure accurate data, information, and intelligence was passed from the lowest to the highest-level decision makers.

A 1998 article in The Financial Times newspaper notes “the much wider availability of low-cost real time, or near-real time, information in particular has spurred the process of *disintermediation* - cutting out the middle man from a transaction. In theory, at least, easy access to information shifts the balance of power towards the end user - if all information is only a mouse click away, people will gravitate towards low cost or best value, particularly for commodity items.” The same holds true for Marine C2. If the information that is available at the lowest echelon is identical to that at the highest echelon, in real time, then there becomes less of a need, or desire, to pass information up several chains to enable decision-making. Commanders will want to either make decisions, or enable decision making, at the lowest level possible. This facilitates flexibility, the lack of a need for the vertical decision making pyramid (replaced by a horizontal structure), and a quicker response based on timely information.

Once the C2 structure is disintermediated, *reintermediation*, or the introduction of new players to the C2 chain, must be approached carefully. There is a tendency in the military to avoid change altogether, and to resist the influx of new technology. If we disintermediate via new technology, allowing for faster, timelier information availability, and thereby eliminating the need for human interaction in the C2 chain, we risk a huge

backlash to the disintermediation process. The adage of “if it ain’t broke, don’t fix it” applies to the military as much today as it always has. Additionally, the mantra of “we’ve always done it this way” seems to permeate from top down. More and more, military leaders accept technology because they have to, and then insert it into the same organizational structure used in the past, thereby negating its positive effects. If the goal is to reintermediate, organizations possibly subject themselves to doing nothing more than inserting the same billets back into the decision chain, rather than looking to reintermediate new ways of doing ‘business’.

Disintermediation is something that can become part of the MACCS cycle. Network centric warfare is a way to disintermediate, and network centric warfare is a high profile effort at present time. Use of networks, wireless LANS, database technology, satellite communications have all led to (or will lead to) small unit/low echelon decision-making, and flattening the organization hierarchy. This can be an enabler for the C2 field in the 21st century.

3. The Squandered Computer

Paul Strassmann was appointed in 1991 to the newly created position of Director of Defense Information, Principle Deputy Assistant Secretary of Defense for Command, Control, Communications and Intelligence. In a book written by him, The Squandered Computer (Strassman, 1997), he postulates that in the business world, computer expenditures are often not matched to the objectives of an organization. He writes, in the introduction, that there is a “sobering up of organizations inebriated with unjustified helpings of IT”. Additionally, Strassmann’s writings parallel the idea of the “productivity paradox”. The paradox states that IT alone does not solve an organization’s problems, nor does it make an organization more productive. While there has been a huge influx of IT in the past 30 years into all sectors of society (industry, education, military), there has been no tangible evidence to show that any of these sectors is more proficient than they were without IT. And, even though the productivity paradox is defined in the commercial arena, it can apply to any organization. Strassmann offers some of the following examples of the computer paradox and spending on IT in the business world:

For 55% of U.S. firms the computer budget exceeds their economic value-added.	The "computer paradox" has not been repealed, contrary to claims. There is no demonstrable relationship between computer spending and corporate profits.	Despite a 67% growth in computer spending, overhead costs of U.S. firms grew faster than their growth in revenues or profits.
The "right" level of spending for computers reflects the bureaucratic characteristics of a firm, not revenue or profits.	The insistence of computer magazines and academics to relate computer spending to corporate revenues or government agency budgets is misleading and encourages overspending.	Claims that computers increased worker productivity are deceptive. The rise in revenue per employee is a reflection of increased outsourcing, not gains attributable to computerization.
There are no "best practices" prescriptions how to spend money on computerization. 31% of computer projects are canceled; 53% will over-run budget and schedules.	The government's policy to shift regulatory compliance paperwork to corporations creates a computer workload that has no payoff.	The most popular methods for justifying spending on computers propose unverifiable commitments.
Computer magazines have the tendency to popularize examples of excellence in computer usage that disregard financial results.	Outsourcing of computer services is most often another form of drastic downsizing.	The practice of outsourcing of computer services will increase as the costs of modernization of information technologies become prohibitive.
The inherent conflict of interest among parties to outsourcing contracts will give rise to independent technology assessment firms.	The cyclical investment pattern for computers is as much a reflection of shifts in organizational power as the result of technological innovation.	Each technology introduction cycle is characterized by increased spending and destruction of information assets.
The era of exuberant business spending for computers is coming to an end. Economics will prevail over electronics.		

Strassmann's research shows that increasing investment in more Information Technology is seen by business as a way to solve the ills and shortfalls of productivity in the work place. This holds true for the government and military sector. Investment in, and deployment of, newer, faster, and 'better' technology does not, and will not, ensure more efficient operational practices.

Strassmann, in his acknowledgements of other authors in his book, refers to Erik Brynjolfsson. Brynjolfsson, writing for the Center for Coordination Science, MIT Sloan School of Management, writes that

The overall negative correlation between economy-wide productivity and the advent of computers is behind many of the arguments that IT has not helped US productivity or even that IT investments have been counter-productive. (Brynjolfsson, 1994)

The human processes and organizational relationships define the efficiency of an organization. Thus, the Marine Corps cannot expect to simply change IT hardware or software (i.e. the development and fielding of CAC2S), and expect improved warfighting ability. The Marine Corps must place equal or greater emphasis on the “upgrading” of its organizational structure to ensure that new IT can be, and will be, accepted and used to its full potential.

The foremost experts in the technology field agree to this one principle – increased investment on newer technology does not correlate to increased productivity (this is the ‘productivity paradox’). It would seem, then, that the way to increase productivity must lie in the practices of an organization. Therefore, to increase productivity, how business is conducted, not what it is conducted with, is the important step. In the end, developing CAC2S and fielding it will not necessarily increase productivity by itself.

B. PROPONENTS OF CHANGE

If need for change is required, how is it attained? There are processes and models, as well as theories, on how to do this. An actual model for change will not be laid out in this chapter. Figures 5-8 in the previous chapter show some models for change developed at APC. What needs to be discussed and examined is how organizations successfully shift the paradigm of how they do business through thoughtful reconsideration of their organizational structures. Organizational change is externally induced, and adaptability is a function of the ability of the organization to learn and perform according to the changing environmental contingencies.

1. Senge and Systems Thinking

Peter Senge (1990) is the author of The Fifth Discipline and a foremost expert in the field of organizational theory. His areas of special interest focus on decentralizing the role of leadership in organizations so as to enhance the capacity of all people to work productively toward common goals. Dr. Senge's work articulates a cornerstone position of human values in the workplace; namely, that vision, purpose, reflectiveness, and systems thinking are essential if organizations are to realize their potentials.

In The Fifth Discipline, he describes the title subject as “systems thinking”. That is, the integration of the disciplines of building shared vision, mental models, team learning, and personal mastery to realize the potential of individuals and organizations, fusing them into a coherent body of theory and practice. Most organizations that fail let evidence of trouble go unheeded, even when individual managers are aware of such trouble. Although his book talks about industry, it can apply to any organization.

Senge talks to what he terms as a ‘shift of mind’. In this sense, he means to see not in parts but in wholes. When systems thinking is applied, the organization and relationships are not seen lineally, but as a constant cause and effect, circular relationship. To describe this, he has created ‘loops’, that can show how as we try to change or implement an action, cause and effect can lead to the same problems. An example is the loop of fixes that fail (Figure 9). It looks like:

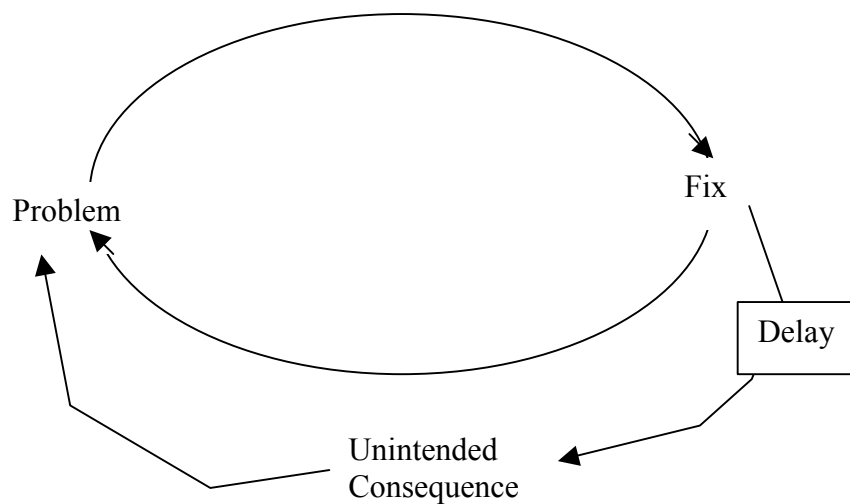

Figure 9. Senge Loop. [From: Senge, 1990]

In this archetype, there is a known problem. As a fix is implemented, instead of an instant change or solution, there is always a delay. A delay can lead to unintended consequences, and these consequences contribute to a problem again. Systems thinking attempts to overcome this, and other archetype mistakes, by allowing individuals not to view linear cause and effect, but to see the bigger picture.

2. Flat vs. Hierarchical Structure

Organizations are traditionally structured in two fashions: horizontal and vertical (hierarchical). In this fashion, information flow, communication, and interaction among individuals are dynamically different. Organizations that are horizontal (also termed flat, employee-empowered, shared services, flexible) have at their core a management philosophy that focuses on key organizational processes. Just as corporations view globalization and new technology as key factors to reorganize, the Marine Corps must view 'jointness' and network centric warfare as factors to streamline the command and control processes.

The hierarchy style worked very well up until the recent years when more flexible structures have been needed to adjust to the dynamics introduced by technology (Seelbach, 2000). Communication, in multiple forms, is key to maintaining competitiveness. Horizontal structures allow for communication to flow across, as well as, down. With flat structures, fewer 'managers' are needed below the top level to allow communication to flow. Mid level officers were needed in the communication and decision making process in the MACCS, where technology can make up for those individuals. Total decentralization is not a requirement, nor is it desired. The key is to provide lower level members of the organization the autonomy to make decisions, with upper level officers to focus on strategy and problem solving.

According to Jay Galbraith, leaders of modern organizations are becoming increasingly involved in organization design. Management is bringing more people into the decision-making processes of organizations, primarily through decentralization. This is because change requires that organizations make more decisions more frequently, and thus to expand the decision-making capacity. Speed requires that decisions be moved to points of direct contact with the work, to meet shorter lead times. This is the classic issue of decentralization of decision-making, and the more modern concept of movement of

power to departments. Information and decision processes cut across the organization's structure.

Management processes are both vertical and horizontal. Vertical Processes allocate the resources of funds and talent. They are usually planning and budgeting processes. The needs of different departments are centrally collected, and priorities are decided for the budgeting and allocation of the resources to capital, research and development, training, etc. Horizontal Processes (also known as Lateral Processes) are designed around the workflow (e.g., new product development or customer order fulfillment). These processes are becoming *the primary vehicle for managing in today's organizations*. Lateral processes can be carried out in a range of ways, from voluntary contacts between employees to complex and formally chartered teams (Galbraith, 1995).

Both structures have advantages. However, horizontal structure facilitates communication flow, and communication is increased as key organizational processes are emphasized. This is key to the decentralization of power. Conversely, as horizontal structures tend to be more flexible and allow for decentralization, organization members often find it difficult to know to whom to report. Dr. Michael Ryan hypothesizes that “a governmental organization with a flat organizational structure is an effective learner” (Ryan, 2000).

Minzberg, in his model of shifting organizational configurations from centralized to decentralized, makes the point that the military has been moving to increased complexity for decades, and that it is continuing. The military is now, and always has been in the case of war, moving toward the upper right (see Figure 10). High complexity, high change requires more mutual adjustment (Galbraith's lateral communications). Networks can enable that. It thus increases the decision making and information processing capacity of the organization and prevents overload of commanders in the “hierarchy” that relies on “simple structure” in this diagram (Jansen, 2000).

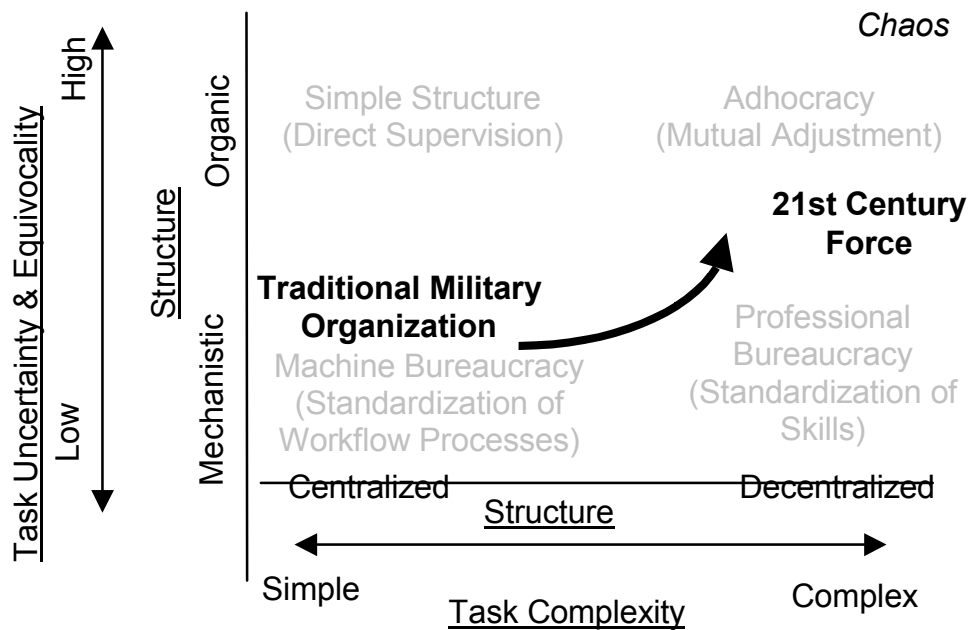

Figure 10. Shift in Organizational Configuration for Modal DoD Organizations as they Move through the RMA. [From: Jansen, 2000]

If the MACCS becomes more flat, care must be put into the development of processes that empower lower level members and define reporting responsibilities, as well as place focus on mission accomplishment at the lowest tiers.

3. Change Technology

David Gleicher has been attributed with the development of the formula depicted in Figure 11 (Rouda, 1995).

$$\blacktriangle = \text{Dissatisfaction} \times \text{Vision} \times \text{Process} > \text{Resistance}$$

Figure 11. Gleicher's Change Formula. [From: Rouda, 1995]

For change to occur, the product of dissatisfaction (analysis or feedback about the present state of an organization), vision (the future of the organization), and process (transition to the new organization) must be greater than the resistance (feeling of loss) to the change by members. The formula is a product due to the fact that if any of the three

factors (dissatisfaction, vision, or process) is zero, thereby non-existent, then the formula fails. Change can only happen if there is dissatisfaction about the current state of the organization, if there is vision to change, and there is a solid process to this change. All of this must overcome the resistance to this reorganization. Should members be unwilling to change in such manner that far exceeds the other factors, the change will be ignored, rejected, or fought against. The goal is to bring approaches to the organization that will enable these three components to surface so that the process of change can begin (Rouda, 1995).

C. BARRIERS TO CHANGE

The realities of any organizational change dictate:

- Periodic strategic change often necessary for survival
- Change is a continuous process
- Profound change takes times
- Often produces massive resistance

Because of this, changing tends to be resisted by humans on all levels, from personal to professional. Few organizational change efforts tend to be complete failures, but few tend to be entirely successful, either. (Kotter, 1995) Here, resistance and overcoming will be discussed, with additional focus placed on models and involvement.

1. Resistance

Don Bryant (1979), in The Psychology of Resistance to Change, writes about factors that influence attitudes to change. Changing, and overcoming the boundaries, is a psychological process as well as a physical process. There is a resistance to any change due to the natural threats that humans face when confronting new ways of doing business. Several factors that determine how individuals feel about impending change include:

- The basic predisposition to changing, based upon learned experiences from as early as birth, where learned norms affect how we do things
- Personal security, where maintaining the status quo can provide a feeling of comfort
- Current cultural beliefs that exist
- Trust and loyalty that exist from past and present relationships
- Apprehensiveness or expectations about particular change, and how it will affect the organization or job security

Reducing change can be addressed by considering who brings the change, what the change will be, and how to best effect the change. Individuals in the organization need to have some sort of involvement in the change process. Any change must be introduced with clearly stated goals that have support from the top. The view of change must provide stakeholders the realization that it will reduce, vice increase, current workloads. If the change involves participants who are allowed to participate from the beginning, allowing for feedback, with acceptance of both sides for the need to change by both lower and upper echelon personnel, with the option to revise and review at a later date, then resistance will be reduced (Bryant, 1979).

Kotter and Schlesinger (1979) also offer their four basic reasons for the resistance to change. All efforts to change an organization tend to encounter some form of human resistance, from passive to aggressive. Their four most basic reasons people resist are:

- Parochial self interest – resist when they think they will lose something of value as a result
- Misunderstanding and lack of trust – the individuals do not understand the implications and perception is that the cost is greater than the gain of change
- Different assessments – assess the situation differently from those initiating the change
- Low tolerance for change – fear of inability to develop new skills or behavior required of them

The authors offer these four reasons as a foundation to how to overcome the change, which will be discussed in the next section.

Another important aspect of change is that change cannot be affected internally. Engineers of change must either be physically or emotionally removed from the change process. Non-stakeholders do not feel loss brought by change. Consultants or professionals who can implement and institute change must be brought into the mix of the change is to be successful.

Paul Lawrence notes ‘what employees resist is usually not technical change but social change – the change in their human relationships that generally accompanies technical change’. (Lawrence, 1954) This would apply to the idea that as the MACCS

brings CAC2S online, the system will not be resisted; the greater resistance would be to restructuring to use the system.

Sources of resistance to change also include:

- Inertia
- Habit
- Resource limitations
- Threats to power and influence
- Fear of the unknown
- Social influence and social information processing

There are, then, numerous reasons why people will resist change. What can be determined is that if organizational change is to be implemented, it will not necessarily be an easy process. Thought and understanding must be put into the process if the barriers are to be overcome and the change successful.

2. Overcoming

The idea of overcoming the barriers and leading the way to organizational change, especially with an IT organization (which the MACCS can be considered), has been proposed by numerous experts in the field. IT-enabled organizational change is the explicit arrangement of information technology for the purpose of enabling changes in practices, processes, or structures of an organization. It targets an organization's processes, structures, management, culture, and competitive balance (Kling, 1998). Hammer and Champy, in 1993, focused on IT as an essential enabler for the reengineering of organizations. Their five precepts are:

- Radical Transformation – quantum leaps of change, vice incremental
- Obliterate vice automate – change comes from clean slate concepts
- Focus is process based – work processes decomposed into component tasks and activities, and then reengineered into work arrangements
- Top down directed – sweeping authority change, downward through the organization
- IT is a critical enabler – access to seamless information powers the efficiencies and coordinates interactions in the new organization

Counter to the notion of participation, Larwrence leaves absent from the list participation by those involved. Although it has become popular to think that

participation dealing with change resistance is a way to overcome resistance, it is not necessarily a good way for management to deal with the issue. Care would have to be put into whether or not to involve members in the process, and those same members that resist. Thoughtful management efforts are more important than member participation.

Kotter and Schlesinger, who offered four reasons why people resist change, also offer six ways to overcome the resistance. Managers (or the implementers of change) often underestimate the negative backlash that the change can incite. In order to overcome the backlash, they offer these as ways to deal with it:

- Education and communication – can involve one on one, group presentations, or memo/reports
- Participation and involvement – involve the potential resisters to forestall
- Facilitation and support – most helpful when fear and anxiety are the root of the resistance. Support of individuals is key to this.
- Negotiation and agreement – incentives to the resisters to change, as well as negotiating a ‘middle’ ground
- Manipulation and co-option – selective use information and conscious structuring of events
- Explicit and implicit coercion – used when the change must happen fast, but risks backlash by members over the ‘forced’ change

3. Change Methods

There are numerous methods to managing large organizational change. Robert Rouda (1995) summarizes the most widely used methods in his paper “Background Theory for Large Scale Organizational Change Methods”. Amongst them are:

- the theory-base uses less action research and discrepancy theory, and focuses on application of systems theory (see Senge)
- the data base source is no longer internal to the organization, but now involves both the organization and its environment (an open-systems approach)
- the data base, which formerly had limited availability, is now widely shared throughout the organization
- time: what was formerly a slow "waterfall" process is now a fast, quick response which results in immediate action taking place
- learning moves from the individual or unit to the whole organization
- the responsibility and accountability moves from senior management to a mixture of senior management plus the whole system

- the consultant role, formerly reserved for data collection and feedback, now also includes structures and facilities for data analysis and action planning
- the change process moves from incremental change to fundamental, organization-wide change

A widely accepted method, or model, of the change process in human systems is Kurt Lewin's change theory of unfreezing, changing, and refreezing (Figure 12). Lewin's theory states that 'human change, whether at the individual or group level, was a profound psychological dynamic process that involved painful unlearning without loss of ego identity and difficult relearning as one cognitively attempted to restructure one's thoughts, perceptions, feelings, and attitudes' (Schein, 1993).



Figure 12. Lewin's Change Theory Model. [From: Schein, 1993]

Unfreezing states that for change to occur, driving and restraining forces have to be altered under complex psychological factors. Just adding a driving force toward change often produces an immediate counterforce to maintain the equilibrium. This observation led to the important insight that equilibrium could more easily be moved if one could remove restraining forces since there were usually already driving forces in the system.

To unfreeze the beliefs that individuals hold in the organization, individuals must have disconfirmation of the belief system of the organization. Dissatisfaction or frustrations generate a way to disconfirm an individual's expectations or hopes. The disconfirmation must incite "survival anxiety", or the feeling that change does not occur, and there will be a failure to meet needs, goals or ideals that have been set ("survival guilt"). However, what typically causes the defensive reaction in individuals is a second kind of anxiety called "learning anxiety". Learning anxiety is the fundamental restraining force that can go in direct proportion to the amount of disconfirmation, leading to the maintenance of equilibrium by defensive avoidance of the disconfirming information. Dealing with learning anxiety, then, is the key to producing change.

To begin the changing process in the model, it is important to create for the learner some degree of “psychological safety”, or the ability to balance the amount of threat produced by disconfirming data with enough psychological safety to allow the change target to accept the information, feel the survival anxiety, and become motivated to change. Motivation is not enough, and a theory or model of change must also explain the actual learning and change mechanisms. A process of “cognitive restructuring”, occurs, taking in new information that has one or more of the following impacts:

- Semantic redefinition - learning that words can mean something different from what had been assumed
- Cognitive broadening – learning that a given concept can be much more broadly interpreted than what had been assumed
- New standards of judgment or evaluation - learning that the anchors used for judgment and comparison are not absolute, and with different anchors, the scale of judgment shifts

When refreezing, the new behavior must be to some degree consistent with the rest of the behavior and personality of the learner. If not, the new behavior will simply set off new rounds of disconfirmation that often lead to unlearning the very thing one has learned. For relational refreezing to occur, it is best to train the entire group that holds the norms that support the old behavior.

Summarily, Lewin's basic model of change leads to a whole range of insights and new concepts that enrich change theory and make change dynamics more understandable and manageable. If Lewin was correct that one couldn't understand an organization without trying to change it, it is not possible to make an adequate diagnosis without intervening. Consultants can ease this transition. The best information about the dynamics of the organization will be how the organization deals with the consultant, because his or her very presence is de facto an intervention. (Shein, 1993)

4. Involvement

There are two basic different views in the involvement process. That is, to involve or not involve the members who must, in the end, accept the change. Bryant notes that if participants from all sections of the organization are involved, then resistance will be reduced. Kotter and Schlesinger also feel that involving potential resisters can forestall problems. A facilitator of change, namely an expert consultant in change theory,

can also lend to the involvement process. In the end, all members must feel the desire and goal of changing the organization.

D. APPLYING CHANGE TO THE MACCS

Applying the change model to the MACCS is not necessarily an easy task. For the change to be successful, there are factors that must be considered.

1. Factors to Identify

First, the facilitator of change must come from external sources. Leadership must realize that members of the organization cannot possibly hope to change the structure of the MACCS from inside the organization. Individuals who are trained in change theories and have expertise in organizational change would be needed. These experts could mediate the change, and help the leadership avoid pitfalls that would lead to failed change. The person must have no stake in the organization, look for no gain from the change, or have a no fear of loss from the change.

Secondly, resisters must be identified. Individuals most likely to pose the greatest resistance to the change would be those who have a longer time in the organizations (upper level officers and staff non commissioned officers), and who would harbor the feelings of losing more from the change. Lower level officers and enlisted Marines, with less time invested in the organization, would be more receptive to change. Therefore, those with ingrained views on how the organization works will need to be dealt with differently, with greater effort to convince them that change is necessary and will benefit the entire organization in the long run.

Lastly, the change must be well designed, articulated, and implemented. Members of the MACCS must have a clear understanding as to why the structure is being changed, what the new structure is going to look like, and how the structure will put into place at each of their units.

2. Transforming the MACCS Organizational Structure

For the MACCS, eight steps to transforming the organizational structure could be used (Kotter, 1995). The steps have been applied to the MACCS as follows:

- Establish a sense of urgency – Senior level staff and operational officers and Staff non commissioned officers must be made aware of the need and consequences of failing to change the organizational structure of the

MACCS. These consequences must be real, and must be accepted by members.

- Forming a powerful guiding coalition – Senior leadership must not be the only involved parties in the coalition to drive the change process, nor should it be only members of the support community (i.e. Marine Corps Systems Command, Marine Aviation Requirements, Headquarters Marine Corps). Members from all areas of the MACCS (junior enlisted and officers, Fleet Marine Force and support Marines, technicians and operations personnel) must have a voice in the change process. This will ultimately lead to general acceptance of the change.
- Create a vision – as noted, change cannot happen for change alone. There must be a clear vision of why the MACCS is changing its organizational structure. Establishing new organizational designs of the MACCS, testing them, modeling them in simulated situations could all help to show where the MACCS is going. Developing a picture of the future will clarify the direction, and without it, the MACCS reorganization could dissolve into confusion and incompatible projects. Drafting models of the MACCS, and having them tested by experts in reorganization, would provide tangible data that would allow members of the MACCS to see how it would operate in future conflicts.
- Communicate the vision – the MACCS Operational Advisory Group (OAG) must accept whatever change the guiding coalition would produce. The coalition must articulate clearly how the new MACCS organization was formed, why it was formed that way, and be shown some proof that the organizational model will work. The vision must be simple to understand, thorough in its dissemination to all MACCS members, and communicated as so that the vast majority of the MACCS (all members will never be sold on the “one best solution”) want to accept it.
- Removal of obstacles – large obstacles that will prevent acceptance of the change need to be removed. For instance, certain members might feel as if, by changing, promotion opportunities and command billets will be eliminated. In this case, a large obstacle may be a Staff NCO, Major, or Lieutenant Colonel who has worked in the MACCS for a great deal of time, only to find that the positions of power are being pared down by the reorganization. These individuals possess the ability to undermine the group, and block the change process. These individuals must be dealt with carefully and individually.
- Planning for and creating short term wins – the MACCS cannot be radically transformed in a short period of time. In this sense, APC’s vision of a two phased approach to change is a good thought. Marines in the MACCS must see tangible gains from the change. Setting goals is necessary. Quarterly or biannual meetings to show progress would be recommended. When the goal is set too high, failure is more likely, and resisters to the change are more than likely to declare the change a failure.

Establishing a small-scale test model, one part of the new organization, and allowing it to function in an exercise, could possibly lead to goal achievement. The model unit could develop pros and cons, and these could then be factored into the new MACCS model. Radical change, without knowing consequences of failure or success, would be ill advised.

- Consolidating improvements and producing further change - declaring victory too soon is something that should be avoided. If the test model organization performs well, the coalition and OAG cannot look to this as proof that reorganization will work. Credibility established by the success of the test model can be leveraged upon to develop the larger MACCS model.
- Institutionalizing new approaches – there must be a conscious effort to demonstrate to the MACCS that the change can be successful, and will work once it becomes the normal way of doing things. There is a long time before all will generally accept the change. A generation of officers and enlisted Marines must pass, in most cases.

3. Change Model for the MACCS

Several models for change have been proposed for the MACCS. APC versions are laid out in Figures 6-8 of this thesis. A similar model is proposed in Figure 13 below (Trabun, 2000):

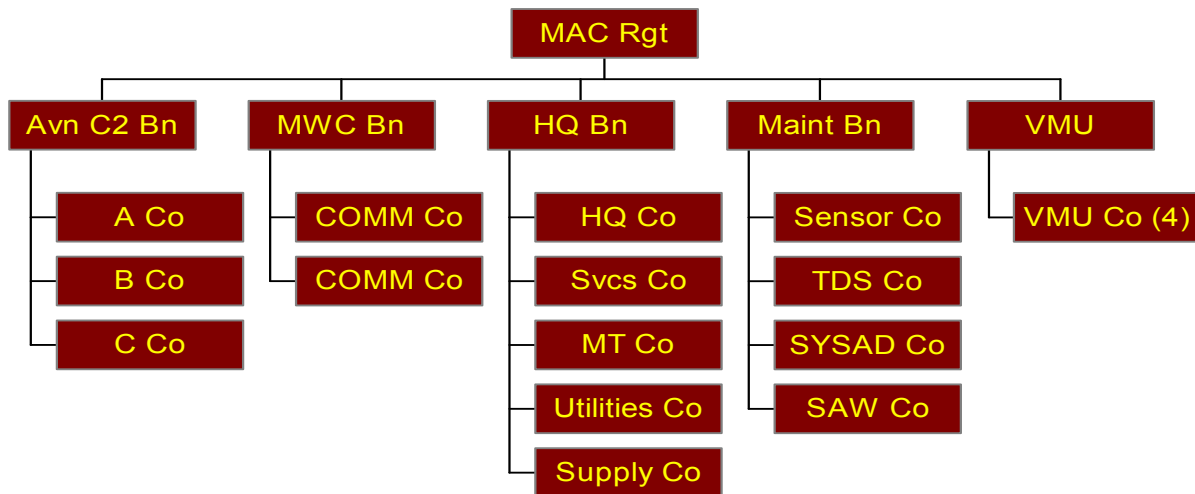

Figure 13. Avn C2 Organizational Model. [From: Trabun, 2000]

This model was the result of a Marine Air Control Group Operational Advisory Group (MACG OAG) working committee effort in January 2000. This seems to be a good starting point for a MACCS reorganization model. It is the result of a working “committee” of members from the MACCS. This points to the fact that the idea of

reorganizing the MACCS was the effort of numerous members of the MACCS. This is important to help overcome obstacles to resistance. The members focused the reorganization to supporting core warfighting functions of the MACCS. Also, the models (Figure 13 is the end state model) are phased. This assists in identifying where possible failures in the restructure might occur.

The committee left open that the models should be further analyzed to determine options, requirements, and actions in the future.

The OAG working committee model and effort could be the starting point to reorganizing the MACCS. It should be cautioned that it is only the ‘starting’ point, and that the models and hypotheses laid out in the previous parts of this thesis must also be followed to avoid a failure of the change.

E. SUMMARY

To change large organizations such as the MACCS is a complex task. The implementers of change will face resistance and obstacles along the way. Overcoming such resistance or obstacles can be an arduous task. Leaders of organizations must have careful and deliberate plans when attempting to set into motion any model of change. Success can be improved if the leaders conduct a solid organizational analysis, with factors relevant to producing needed change, and select a strategy that is then closely monitored (Kotter and Schlesinger).

V. CONCLUSION

The MACCS has for its existence remained relatively stable and unchanged in its organizational structure. Technology and doctrine are rapidly evolving and changing, and in this context, organizations cannot remain stagnant. Although the consensus exists among various individuals and units that the MACCS must change, the notion of how to change, as well as why to change, is less understood. Organizations cannot change simply for the sake of doing something different. Organizations have attempted to restructure themselves in the industrial and postindustrial age, especially in light of improved technology, and many have met with failure. Unless careful thought is put into the process, failure can be an expected outcome. Support commands such as Headquarters, Marine Corps; Marine Corps Systems Command, and Requirements Division, Marine Corps Combat Development Command, must all find a common vision as to what they want and expect the MACCS to accomplish. To reshuffle the same pieces into a different form misses the point. To do anything less than a near revolutionary change is to risk no longer remaining relevant to the mission of the MAGTF. Technology affords members of an organization to complete tasks differently, more effectively, and more efficiently. The organization must be capable of facilitating this new way of doing business. However, to try and change without a radical shift in the mindset is to set the change up for failure. Careful thought in the change process, with models and a solid plan, must be put into place if the organization that is changing is expected to be successful.

THIS PAGE INTENTIONALLY LEFT BLANK

BIBLIOGRAPHY

Bryant, Don, "The Psychology of Resistance to Change", Management Services, March, pp. 9-10, 1979.

Brynjolfsson, Erik, "The Productivity Paradox of Information Technology: Review and Assessment", (1994) [Online] <http://ccs.mit.edu/papers/CCSWP130/ccswp130.html>, 1994.

Galbraith, Jay R. Designing Organizations: An Executive Briefing on Strategy, Structure, and _____ Process, Jossey-Bass Publishers, 1995 [Online] <http://www.millpondgroup.com/artorgdesign2.html> - review, 1995.

Hingle, Alden, Interview with Major John C. Madsen, USMC, May 2001.

Jansen, Erik, "The Officers of the Future: Thinking through the Revolution", Working Paper, 2000.

Joint Vision 2020, Approval Authority, General Henry H. Shelton, Chairman of the Joint Chiefs of Staff, Director for Strategic Plans and Policy, J5; Strategy Division; US Government Printing Office, Washington DC, June 2000.

Jones, Gen J.L., "Marine Corps Strategy 21", HQMC, 3 November 2000.

Jones, Marion D., email to Maj William R Payne, Jr., dated 23 March 99.

Kling, Rob and Tillquist, John, "Conceiving IT-Enabled Organizational Change", Center for Social Informatics, Indiana University, 1998 [Online] <http://www.slis.indiana.edu/kling/orgsci98h.html>

Kotter, John P. and Schlesinger, Leonard A., "Choosing Strategies for Change", Article "Strategies for Change", pp. 67-75, 1979.

Kotter, John P., "Leading Change: Why Transformation Efforts Fail", Harvard Business Review, pp. 59-67, March-April 1995.

Lawrence, Paul R., "How to deal with resistance to change", Harvard Business Review, May-June 1954.

McNamara, Carter, "Basic Context for Organizational Change", 1999, [Online] <http://www.mapnp.org/library/mgmnt/orgchng.htm>

Malhotra, Yogesh, "Role of Information Technology in Managing Organizational Change and Organizational Interdependence", BRINT Institute, 1993, [Online] <http://www.brint.com/papers/change>

“Marine Corps Command and Control Systems Intra/Interoperability”, Executive Summary, [Online] http://nrac.onr.navy.mil/webpace/exec_sum/88mccc2.html

Marine Corps Doctrinal Publication (MCDP) 6: Command and Control, HQMC, Oct 1996.

Marine Corps Lessons Learned System (MCLS) Report submitted Feb 1991.

Marine Corps Doctrinal Publication 6: Command and Control, Headquarters, Marine Corps, October 1996.

Marine Corps Warfighting Publication 3-2: Aviation, Headquarters, Marine Corps, May 2000.

Marine Corps Warfighting Publication 3-25: Control of Aircraft and Missiles, Headquarters, Marine Corps, February 1998.

Marine Corps Warfighting Publication 3-25-3: Marine Air Command and Control System Handbook, Headquarters, Marine Corps, December 1997.

Mintzberg, H., Structure in Fives: Designing Effective Organizations. Englewood Cliffs, N.J., Prentice-Hall, 1993.

Operational Maneuver from the Sea (OMFTS), Marine Corps Concept Paper, Jan 1999.

Pratt, LtCol Alan, USMC, Interview with Major John C. Madsen, USMC, May 2001.

Rouda, Robert H., “Background and Theory for Large Scale Organizational Change Methods”, University of St Thomas, 1995, [Online] <http://www.alumni.caltech.edu/~rouda/background.html>

Ryan, Michael P., “Organizational Learning and Change at the World Intellectual Property Organization”, [Online] <http://www.worldbank.org/html/fpd/technet/sem-sums/RYAN.HTM>

Schein, Edgar H. “Planned Change Theory”, Organizational Psychology, pp. 243-247, 1980.

Schein, Edgar H., “Kurt Lewin's Change Theory in the Field and in the Classroom: Notes Toward a Model of Managed Learning”, MIT Sloan School of Management, 1993, [Online] <http://www.solonline.org/res/wp/10006.html>

Seeger, John A. et al, “First National City Bank Operating Group”, Harvard Business School case, 1974.

Seelbach, Greg, “How Management Structures Affect Communication: An Organizational Challenge”, 2000, [Online] <http://www.geocities.com/gdseel/sample.htm>

Sieber, Captain Matthew M., “Marine Air Control Group – Be Gone”, Marine Corps Gazette, August 2000.

Senge, Peter M., The Fifth Discipline, , Doubleday Printing, August 1990.

Software Program Managers Network (SPMN), 2001, [Online] <http://www.spmn.com/>

Strassmann, Paul A., The Squandered Computer: Evaluating the Business Alignment of Information Technologies, April 1997.

The Marine Air Command and Control System and Operational Maneuver From the Sea, Part One: The Roadmap, Headquarters, Marine Corps, 15 December 1999.

The Marine Air Command and Control System and Expeditionary Maneuver Warfare, Part Two: MACCS Employment Options, Headquarters, Marine Corps, 27 March 2001.

The Marine Air Command and Control System and Expeditionary Maneuver Warfare, Part Three: Organization (draft), Headquarters Marine Corps.

Thigpen, Colonel James E., “The MACCS: Where We Are – Where We Are Going”, Marine Corps Gazette, May 2000.

Thigpen, Colonel James E., “Summation”, Marine Corps Gazette, p. 57, May 2000.

Trabun, Major M.A., “MACG OAG 72XX Working Committee Results”, January 2000.

White, Major Kenneth, USMC, Interview with Major John C. Madsen, USMC, May 2001.

THIS PAGE INTENTIONALLY LEFT BLANK

INITIAL DISTRIBUTION LIST

1. Defense Technical Information Center
Fort Belvoir, Virginia
2. Dudley Knox Library
Naval Postgraduate School
Monterey, California
3. Marine Corps Representative
Naval Postgraduate School
Monterey, California

4. Director, Training and Education, MCCDC, Code C46
Quantico, Virginia

5. Director, Marine Corps Research Center, MCCDC, Code C40RC
Quantico, Virginia

6. Marine Corps Tactical Systems Support Activity (Attn: Operations Officer)
Camp Pendleton, California

7. Dr. Carl R. Jones, PhD.
Naval Postgraduate School

8. Dr. Frank J. Barrett, PhD.
Naval Postgraduate School

9. Dr. Erik Jansen, PhD.
Naval Postgraduate School

10. Major John C. Madsen
Marine Corps Systems Command
Quantico, VA
