

**NAVAL POSTGRADUATE SCHOOL
Monterey, California**



THESIS

**AN IMPROVED MAGNETIC, ANGLE RATE, GRAVITY
(MARG) BODY TRACKING SYSTEM**

by

Pierre G. Hollis

June 2001

Chairman of Committee and Supervisor: Xiaoping Yun
Committee Member: Sherif Michael
Committee Member: Eric R. Bachmann

Approved for public release; distribution is unlimited.

20020102 087

REPORT DOCUMENTATION PAGE			Form Approved OMB No. 0704-0188	
Public reporting burden for this collection of information is estimated to average 1 hour per response, including the time for reviewing instruction, searching existing data sources, gathering and maintaining the data needed, and completing and reviewing the collection of information. Send comments regarding this burden estimate or any other aspect of this collection of information, including suggestions for reducing this burden, to Washington headquarters Services, Directorate for Information Operations and Reports, 1215 Jefferson Davis Highway, Suite 1204, Arlington, VA 22202-4302, and to the Office of Management and Budget, Paperwork Reduction Project (0704-0188) Washington DC 20503.				
1. AGENCY USE ONLY (Leave blank)	2. REPORT DATE June 2001	3. REPORT TYPE AND DATES COVERED Engineer's Thesis		
4. TITLE AND SUBTITLE: An Improved Magnetic, Angle Rate, Gravity (MARG) Body Tracking System			5. FUNDING NUMBERS	
6. AUTHOR(S) Pierre G. Hollis			8. PERFORMING ORGANIZATION REPORT NUMBER	
7. PERFORMING ORGANIZATION NAME(S) AND ADDRESS(ES) Naval Postgraduate School Monterey, CA 93943-5000			10. SPONSORING / MONITORING AGENCY REPORT NUMBER	
9. SPONSORING / MONITORING AGENCY NAME(S) AND ADDRESS(ES) N/A			11. SUPPLEMENTARY NOTES The views expressed in this thesis are those of the author and do not reflect the official policy or position of the Department of Defense or the U.S. Government.	
12a. DISTRIBUTION / AVAILABILITY STATEMENT Approved for public release; distribution is unlimited.			12b. DISTRIBUTION CODE	
13. ABSTRACT (maximum 200 words) This thesis proposes the design of an improved Magnetic, Angular Rate, Gravity (MARG) Body Tracking System. The current MARG Body Tracking System is limited to tracking three limb-segments. The MARG sensors are physically connected to a desktop computer by cables. In this thesis, a multiplexing circuit was implemented to allow tracking of 15 limb-segments. Processing was moved from a desktop computer to a wearable computer and wireless communication was implemented using an IEEE 802.11b spread spectrum wireless LAN. The resultant system is able to track the entire human body and is untethered. The range of the system is the same as that of the wireless LAN which can be extended with the use of repeaters. This thesis work will ultimately allow human insertion into virtual environments for training and other applications.				
14. SUBJECT TERMS Computing and Software, Human System Interface, Sensors			15. NUMBER OF PAGES 74	
			16. PRICE CODE	
17. SECURITY CLASSIFICATION OF REPORT Unclassified	18. SECURITY CLASSIFICATION OF THIS PAGE Unclassified	19. SECURITY CLASSIFICATION OF ABSTRACT Unclassified	20. LIMITATION OF ABSTRACT UL	

THIS PAGE INTENTIONALLY LEFT BLANK

Approved for public release; distribution is unlimited.

**AN IMPROVED MAGNETIC, ANGLE RATE, GRAVITY (MARG) BODY
TRACKING SYSTEM**

Pierre G. Hollis
Captain, United States Marine Corps
B.S., Rensselaer Polytechnic Institute, 1993

Submitted in partial fulfillment of the
requirements for the degrees of

ELECTRICAL ENGINEER
and
MASTER OF SCIENCE IN ELECTRICAL ENGINEERING

from the

NAVAL POSTGRADUATE SCHOOL
June 2001

Author:

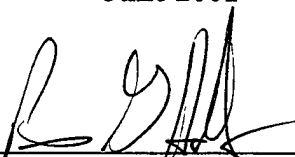

Pierre G. Hollis

Approved by:

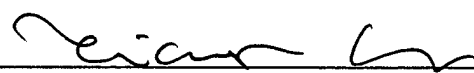

Xiaoping Yun, Chairman of Committee and Supervisor

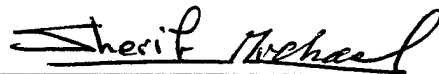

Sherif Michael, Committee Member



Eric R. Bachmann, Committee Member



Jeffrey R. Knorr, Chairman

Department of Electrical and Computer Engineering

THIS PAGE INTENTIONALLY LEFT BLANK

ABSTRACT

This thesis proposes the design of an improved Magnetic, Angular Rate, Gravity (MARG) Body Tracking System. The current MARG Body Tracking System is limited to tracking three limb-segments. The MARG sensors are physically connected to a desktop computer by cables.

In this thesis, a multiplexing circuit was implemented to allow tracking of 15 limb-segments. Processing was moved from a desktop computer to a wearable computer and wireless communication was implemented using an IEEE 802.11b spread spectrum wireless LAN. The resultant system is able to track the entire human body and is untethered. The range of the system is the same as that of the wireless LAN which can be extended with the use of repeaters. This thesis work will ultimately allow human insertion into virtual environments for training and other applications.

THIS PAGE INTENTIONALLY LEFT BLANK

TABLE OF CONTENTS

I.	INTRODUCTION.....	1
	A. MOTIVATION	1
	B. RESEARCH OBJECTIVES.....	2
	C. ORGANIZATION OF THESIS	2
II.	BACKGROUND	3
	A. INTRODUCTION.....	3
	B. HUMAN MODELING	3
	C. DETECTING POSITION AND ORIENTATION	4
	1. Mechanical.....	5
	2. Optical.....	5
	3. Magnetic.....	6
	4. Acoustic.....	6
	5. Radio Frequency	7
	6. Inertial.....	7
	D. DESCRIBING ORIENTATION AND ROTATING FRAMES.....	7
	1. Angles of Rotation.....	8
	2. Quaternions	8
	E. FILTERS	9
	1. Weiner.....	9
	2. Kalman.....	9
	3. Complementary.....	9
III.	CURRENT MARG BODY TRACKING SYSTEM.....	11
	A. INTRODUCTION.....	11
	B. HARDWARE	11
	1. MARG Sensors.....	12
	2. Analog to Digital Converter.....	15
	3. Computer	16
	C. SOFTWARE.....	16
	1. Complementary Filter	16
	2. Calibration Routine	17
	<i>a. Accelerometer.....</i>	<i>17</i>
	<i>b. Angular Rate Sensor.....</i>	<i>17</i>
	<i>c. Magnetometer.....</i>	<i>17</i>
	D. SUMMARY	18
IV.	WIRELESS MARG BODY TRACKING SYSTEM.....	19
	A. INTRODUCTION.....	19
	B. PHASE I.....	19
	1. Wearable Computer	20
	2. Analog to Digital Conversion.....	22
	<i>a. Multiplexing Hardware</i>	<i>27</i>

	<i>b.</i>	<i>Analog to Digital Converter Software</i>	31
	3.	Wireless Link.....	32
	4.	Testing.....	35
C.		PHASE II.....	36
D.		SUMMARY	37
V.		MARG SENSOR WITH EIGHT ANALOG SIGNALS	39
	A.	INTRODUCTION.....	39
	B.	REDUNDANT SIGNALS	39
	1.	Static Tests.....	40
	2.	Dynamic Tests	45
	3.	Raw Data.....	47
	D.	SUMMARY	49
VI.		CONCLUSIONS	51
	A.	SUMMARY	51
	B.	SUGGESTIONS FOR FUTURE WORK.....	51
		LIST OF REFERENCES.....	53
		INITIAL DISTRIBUTION LIST	55

LIST OF FIGURES

Figure 1.	Human Body Model After Ref. [4.].....	4
Figure 2.	MARG Body Tracking System Hardware After Ref. [1.].....	11
Figure 3.	MARG Sensor From Ref. [15.].....	12
Figure 4.	Complementary Filter From Ref. [21.].....	16
Figure 5.	ViA Wearable PC	21
Figure 6.	Xybernaut Mobile Assistant PC.....	22
Figure 7.	Multiplexing by Signal Type	28
Figure 8.	Multiplexing by Sensor Output.....	29
Figure 9.	Original Class Diagram After Ref. [1.].....	31
Figure 10.	Class Diagram with PCMCIA Data Acquisition	32
Figure 11.	Class Diagram with Network Capability	33
Figure 12.	Flow of Network Communication	34
Figure 13.	Static Test Angular Rate Sensor Output	41
Figure 14.	Static Magnetometer Test X-Axis	42
Figure 15.	Static Magnetometer Test Y-Axis	42
Figure 16.	Static Magnetometer Test Z-Axis.....	43
Figure 17.	Static Accelerometer Test X-Axis	43
Figure 18.	Static Accelerometer Test Y-Axis	44
Figure 19.	Static Accelerometer Test Z-Axis.....	44
Figure 20.	Dynamic Magnetometer Test X-Axis.....	45
Figure 21.	Dynamic Magnetometer Test Y-Axis.....	45
Figure 22.	Dynamic Magnetometer Test Z-Axis	46
Figure 23.	Dynamic Accelerometer Test X-Axis.....	46
Figure 24.	Dynamic Accelerometer Test Y-Axis.....	46
Figure 25.	Dynamic Accelerometer Test Z-Axis	47
Figure 26.	Magnitude of Accelerometer Vector	48
Figure 27.	Magnitude of Magnetic Vector.....	48

THIS PAGE INTENTIONALLY LEFT BLANK

LIST OF TABLES

Table 1.	Token CG-16D Angular Rate sensors Specifications After Ref. [16.]	13
Table 2.	Crossbow CXL04M3 Accelerometer Specifications After Ref. [17.]	13
Table 3.	Honeywell HMC2003 Specifications After Ref. [18.]	14
Table 4.	MARG Sensor Pinout	15
Table 5.	Wearable Computer Specifications After Ref. [22.][23.]	21
Table 6.	Quatech DAQ-12P Specifications After Ref. [24.]	24
Table 7.	Quatech DAQ-12P Pinout After Ref. [24.]	25
Table 8.	Analog Devices ADG-526A Specifications After Ref. [25.]	26
Table 9.	Analog Devices ADG-526A Pinout After Ref. [25.]	27

THIS PAGE INTENTIONALLY LEFT BLANK

EXECUTIVE SUMMARY

This thesis proposes the design of an improved Magnetic, Angular Rate, Gravity (MARG) Body Tracking System. MARG sensors contain three sensors triads for a total of nine sensors: three magnetometers, three angular rate sensors and three linear accelerometers. In the current MARG Body Tracking System, each MARG sensor is wired to its own dedicated analog to digital (A/D) converter. The A/D converters are mounted in a desktop computer which performs the orientation calculations. The current system can only track three limb segments and its working radius is approximately five feet. This thesis improves upon the current design by allowing the wireless tracking of 15 limb-segments.

The migration to wireless body tracking was planned in two phases. The first phase replaces the desktop computer with a computer small enough to be worn or carried. The sensors will still be connected to the wearable computer by cables, but communications between the wearable computer and the "rest of the world" will be over a wireless link. This expands the working volume to the range of the wireless link. The second phase replaces the cables between the wearable computer and the sensors with a Bluetooth wireless link. This makes the system less cumbersome and easier to wear. The second phase has not yet been completed.

The first task of Phase I was to develop a multiplexing circuit which allows a single PCMCIA analog to digital converter to sample 15 MARG sensors. In the old system the A/D converters ran at their maximum sampling rate. The multiplexing circuit

of the new system requires the CPU to control each sample. This resulted in a significant increase in CPU workload.

The second task of Phase I was to establish a wireless link between the wearable computer and remote computers. This was implemented using an IEEE 802.11b spread spectrum wireless LAN. The wireless connection did not adversely affect the performance of the system. The range of the system is the same as that of the wireless LAN and can be extended with the use of repeaters.

The goal of Phase II was to replace the cabling between the MARG sensors and the wearable computer with a second wireless link. This link is to be implemented using Bluetooth transceiver modules. Use of the Bluetooth modules requires the MARG sensors to have an embedded controller and an A/D converter.

As previously stated, each MARG sensor has nine analog channels. A/D converters are normally limited to eight analog input signals. If the MARG sensor could be redesigned with eight analog channels, the goal of Phase II would be easily realizable. The approach taken was to measure eight channels and calculate the ninth channel. A series of static and dynamic tests were performed. The system worked using only eight analog signals but there was a degradation in performance. Because the needed Bluetooth modules were not able to be acquired at the time, work on Phase II was halted.

This thesis demonstrated the feasibility of a wireless MARG body tracking system capable of sampling five MARG sensors at 100 Hz and 15 MARG sensors at 37 Hz. The working radius of the system was increased from five feet to the range of the wireless LAN.

I. INTRODUCTION

A. MOTIVATION

Virtual environments (VE) are playing an ever increasing role in today's world. From movies and commercials to education and training, people are using VE to allow visualizations which would be too hazardous or expensive to create using other methods [Ref. 1.]. Inserting humans in VE's has been a long stated desire of VE developers [Ref. 2.].

Immersion into a VE would presumably require data input to all five senses as well as speech recognition and body position detection. Current technology allows very realistic visual and aural immersion. Speech recognition technology has also reached a passing level of acceptability. Taste and smell are far behind but are not viewed as essential. The two remaining areas; body position and haptic feedback are critical to human immersion and are not sufficiently advanced.

While there are several body tracking systems available, they all suffer from one or more of the following problems: limited range, limited resolution, high latency and high cost. Many of the systems are cumbersome and awkward for the user.

A Human Body Tracking System based on the use of a Magnetic, Angular Rate and Gravity (MARG) sensor and quaternion attitude filter was developed to overcome the problems associated with other body tracking systems [Ref. 3.]. While the proof of concept demonstrator performed well in tracking three human limb segments, it required the user to wear sensors which were physically attached to a desktop computer by means of three 15 conductor cables. The cables are short and bulky and confine the users

movements to a very small area. Each of the three sensors required an ISA slot on the computer's motherboard for the analog to digital converter. This limited the number of sensors to the number of available ISA slots on the motherboard and preclude full body tracking.

The purpose of this thesis is to redesign the system to allow wireless tracking using 15 MARG sensors. This will allow untethered, full body tracking over a large area.

B. RESEARCH OBJECTIVES

The objectives of this thesis are the following:

- design an expanded channel, wireless version of the existing MARG Body Tracking System,
- examine the performance of the system using a MARG sensor with a reduced number of analog output signals.

C. ORGANIZATION OF THESIS

Chapter II of this thesis provides background information on human modeling, detecting position/orientation, reference frames and filters. Chapter III presents an overview of the current MARG Body Tracking System. Chapter IV details the design and implementation of the wireless version of the system. Chapter V examines the performance of a MARG sensor with a reduced number of analog output signals. Chapter VII presents a summary, analysis of results, conclusions and suggestions for future work.

II. BACKGROUND

A. INTRODUCTION

Before building a body tracking system, the "body" must be defined. Having defined the body, how is its position and orientation determined? What types of sensors lend themselves to this application? Once a sensor is selected, how will raw data be processed into position and orientation information? How will this information be represented? This chapter shows how these issues were addressed during the design of the MARG body tracking system. It gives a brief introduction to human modeling, position/orientation sensing, and data processing.

B. HUMAN MODELING

The simplest model of the human body is a single point in space. At the other end of the spectrum, the human body could be modeled as skeleton composed of 500 separate bones which are surrounded by over 1000 muscles encased inside an outer skin. The first extreme is not particularly useful. While the other extreme is desirable for realism, it is too computationally intensive for real-time interaction with VE's. The choice of a model is therefore a trade off between realism and computational speed. [Ref. 4.]

Rather than focusing on bones and muscles, the body could be modeled as an articulated structure comprised of rigid segments [Ref. 5.]. Still, with over 200 joints in the human skeleton, one must decide on the minimum set required to give a useful representation capable of being represented in real time. If the fingers and facial features

are excluded, a 15 segment model can be formed as follows: head, torso, pelvis, upper arms, forearms, hands, upper legs, lower legs, and feet. [Ref. 4.]

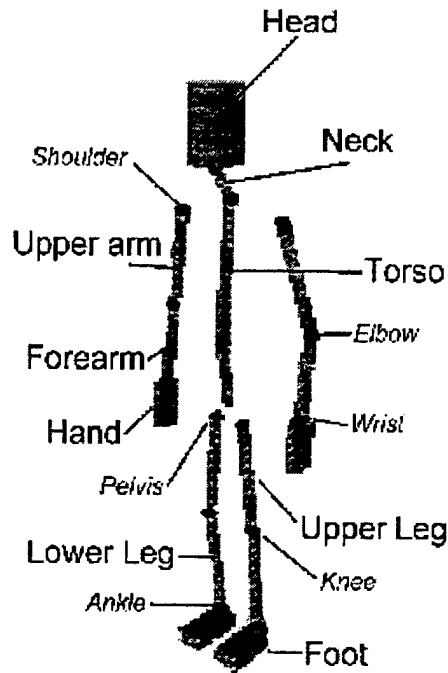

Figure 1. Human Body Model After Ref. [4.]

C. DETECTING POSITION AND ORIENTATION

Having decided on a model, how can it be positioned and oriented? There are several tracking systems on the market based on various sensor technologies. They are broadly categorized as mechanical, inertial, optical, magnetic, acoustic, radio frequency and hybrid. Each type was evaluated on its resolution, ease of use, working volume and cost.

1. Mechanical

There are two basic types of mechanical trackers: exoskeletal body suit and ground-based system [Ref. 2.]. The exoskeletal body suit measures joint angles directly while the ground based system measures body position with respect to a fixed point on the ground [Ref. 6.]. Some exoskeletal systems have the added advantage of providing limited haptic feedback [Ref. 7.].

Mechanical trackers have excellent performance and are without equal in detecting finger position. Their major drawback is that they are cumbersome and awkward to use [Ref. 6., 8.]. The ground based system has the added disadvantage of limited working volume [Ref. 9.].

2. Optical

There are two types of optical systems currently on the market: pattern recognition and image recognition. These systems are further classified as inside-out (mobile detectors, fixed sources) or outside-in (fixed detectors, mobile sources) [Ref. 1.].

The pattern based systems typically use a set of infrared LED's and detectors. The detectors (in an inside-out system) are mounted to the object to be tracked and the emitters are arranged in a fixed pattern. The system determines the location of the object based on the pattern of emitters sensed by each detector. These systems are very accurate but are unable to track in certain orientations. [Ref. 10.]

Image recognition systems are far more complex. These systems use cameras as detectors and attempt to track movement by examining the difference between captured video frames. These systems are very expensive and prone to errors. [Ref. 11.]

Both of the optical tracking systems require a controlled environment of limited size, further reducing the utility of the systems.

3. Magnetic

Magnetic trackers are the most widely used technology today. The system uses sensors containing three perpendicular coils and an emitter system containing three larger perpendicular coils. Magnetic fields are generated by applying current to the emitter coils in sequence. As the sensors are moved in the presence of the generated field, their position and orientation can be calculated. These systems are not as accurate as the previously described systems and they are severely limited in range and tolerance to noise.

4. Acoustic

Acoustic trackers use one of two methods to detect position; time-of-flight/triangulation or phase-coherence [Ref. 12.][Ref. 1.].

In the time-of-flight/triangulation system, sensors at fixed locations measure the time it takes for sound to travel from the target. Once the distance has been calculated, the position is determined by triangulation. Three transmitters and three receivers are required to obtain the position of a single target. [Ref. 13.] Phase-coherence is a more sophisticated system. In this system, distance is determined by measuring the phase shift between the reference and the received signals. The benefits of this system over the time-of-flight/triangulation system is an increase in refresh rates and a somewhat larger working volume [Ref. 8.].

The principle drawbacks to the acoustic systems are the susceptibility to noise and the requirement for a fixed working volume.

5. Radio Frequency

RF positioning systems, like the acoustic systems, are either based on time-of-flight or phase comparison. Unlike the acoustic systems, they enjoy an almost unlimited working volume. While RF positioning systems have long been used for ships and aircraft, they are not being used for human limb segment tracking. Most of the systems available were not designed to track such small targets at short distances. Differential GPS has the accuracy needed, but will not work indoors.

6. Inertial

Inertial trackers integrate data from angular rate sensors to track orientation. Because the angular rate sensors drift, the orientation must be corrected periodically. By using linear accelerometers to sense gravity and magnetometers to sense the earth's magnetic field, the drift can be corrected.

Advances in microelectromechanical systems (MEMS) have made these sensors small and inexpensive. These systems have an unlimited working volume but are susceptible to magnetic interference and only detect orientation.

D. DESCRIBING ORIENTATION AND ROTATING FRAMES

Having detected position and orientation, one must find an appropriate way to describe them. Given the choices of coordinate systems, frames of reference, rotations and kinematic models, there are several of ways to express this information. Since the purpose of the system is real time tracking of human limb segments, the choice must be made with emphasis on computational efficiency.

The Cartesian coordinate system is most commonly used to describe position and orientation. It is composed of three orthonormal vectors (x, y, z) and constitutes one frame. In this system, the position of any point can be described by a 3×1 vector. Another rotated frame is attached to the point in order to describe its orientation. There are two main ways of describing the relationship between these frames. The first uses angles of rotation and the second uses quaternions. There are advantages and disadvantages to each.

1. Angles of Rotation

According to Euler, any frame can be made coincident to another frame by three rotations. In the Fixed-Angle method, the moving frame's orientation is described relative to the fixed frame. Euler Angles describe orientation with respect to the moving frame. Rotation about each of the three axis and the order of rotation is important. This means there are 12 ways of expressing Euler Angles and 12 ways for Fixed-Angles. [Ref. 5.]

While the fixed-angle and Euler angle rotations are easy to visualize, they have a singularity problem when the pitch is ± 90 degrees. They are also computationally expensive because of their use of trigonometric functions.

2. Quaternions

Quaternions are four dimensional representations of orientation. As such, they are difficult to visualize and were largely ignored for the last hundred years. Unlike angle based rotations, quaternion rotations do not have any singularity problems and require fewer arithmetic operations to perform. [Ref. 1.]

E. FILTERS

In an ideal environment, the sensors would detect position and orientation directly without noise or error. Since this is not the case, the raw sensor data must be filtered. This filter can be analog, digital or both. Analog filtering is mainly used for signal conditioning while the digital filters are used to convert sensor readings into position information. The three digital filters currently used are Wiener, complementary and Kalman. Each is optimized for a specific situation.

1. Wiener

The Wiener filter uses a weighting function approach to minimize the mean-squared error between multiple measurements of a time invariant wide-sense stationary signal [Ref. 14]. The weighting function can be found if the auto-correlation and cross-correlation functions of the input signals are known. The principle drawback of this filter is that all previous data must be considered every time new data is acquired. After a short period of time, the calculations are no longer able to be processed in real time.

2. Kalman

The Kalman filter uses a state space method to minimize the mean-squared error. It is a recursive algorithm which depends only on the last state and current measurement. This feature makes the Kalman filter particularly well suited for real time tracking applications. Kalman filters evaluate the quality of their estimates and adjust their gain accordingly. This allows them to discard inputs deemed unreasonable. Like the Wiener filter, the autocorrelation and crosscorrelation functions must be known. [Ref. 14]

3. Complementary

Unlike the previous filters, the complementary filter makes no assumptions about the spectral properties of the input signals. It does however assume that the measurements

of input signals experience noise which is complementary in nature, i.e. one measurement has high frequency noise while the other has low frequency noise. The complementary filter low-pass filters one signal and high pass filters the other. The cut-off frequencies of the filter coincide with each other and the result is a distortionless filter. [Ref. 1.]

III. CURRENT MARG BODY TRACKING SYSTEM

A. INTRODUCTION

The work of several researchers has led to the development of a MARG system [Ref. 1.][Ref. 4.][Ref. 7.][Ref. 9.]. Their goal was to demonstrate the feasibility of full body tracking using multiple MARG sensors. The implemented system is capable of tracking three limb segments in real time while tethered to a desktop computer. It consists of hardware and software and is described in the following paragraphs.

B. HARDWARE

The hardware is comprised of three sub systems: MARG sensor, analog to digital converter and computer as illustrated in figure 2. The MARG sensors are used to sense the physical environment. The analog signals output by the sensors are converted to digital values and processed by a desktop computer.

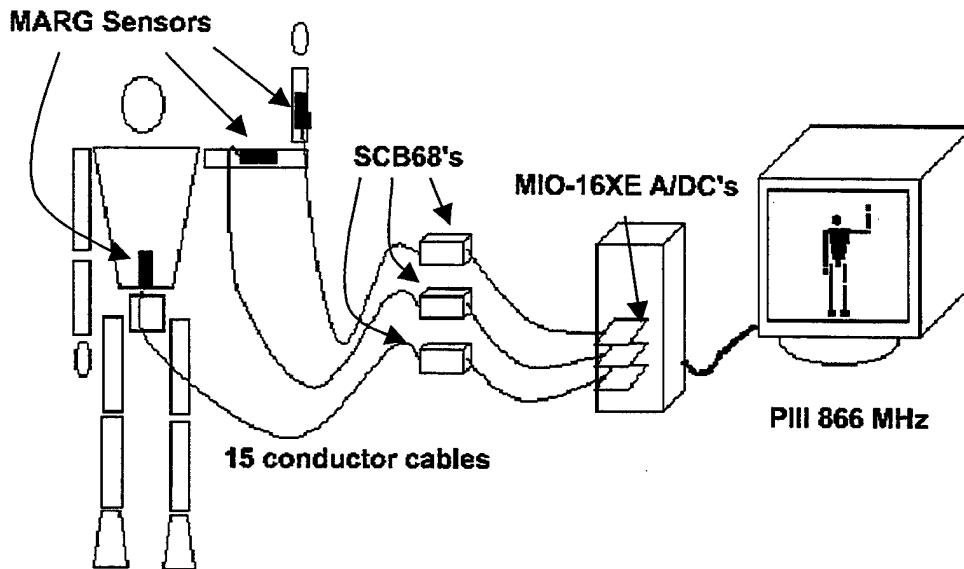

Figure 2. MARG Body Tracking System Hardware After Ref. [1.]

1. MARG Sensors

Each MARG sensor contains three sensors triads: magnetometers, angular rate sensors and linear accelerometers. Each sensor triad has three orthogonally mounted sensors. The axis of the magnetometer are coincident with those of the angular rate sensors and the linear accelerometers. These nine sensors, along with their circuitry, are mounted in a small wooden box measuring approximately 3" x 2" x 1" .

As noted in the previous chapter, the angular rate sensors are used to provide instantaneous orientation information during motion. The angular rate sensors sometimes have non-zero reading while stationary (drift). This drift is corrected by the magnetometers and accelerometers which measure the earth's magnetic field and gravity (and thereby determine orientation).

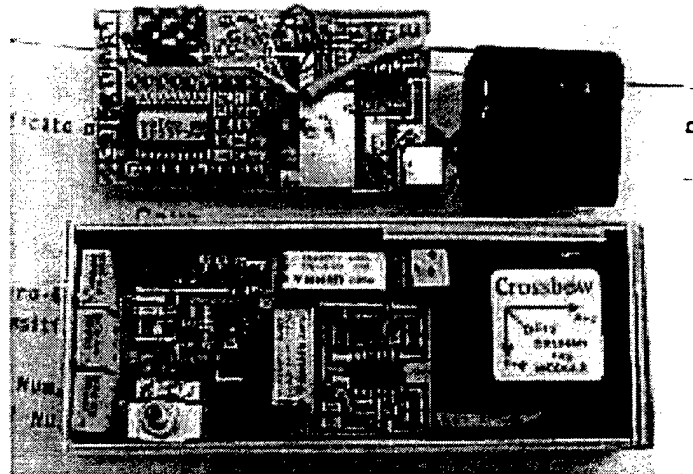

Figure 3. MARG Sensor From Ref. [15.]

The system uses CG-16D angular rate sensors manufactured by Tokin.

Specifications are given in table 1.

Characteristic	Specification
Reference Voltage	2.4 V
Output voltage	0-5 V
Sensitivity	1.1 mV/degree/sec (+/- 20%)
Maximum detectable angular rate	+/- 90 deg/sec
Output voltage at zero angular rate	+/- 500 mV
Bandwidth	100 Hz
Operating temperature range	-5 to 75 C
Supply Voltage	5 V
Current consumption	7 mA

Table 1. Tokin CG-16D Angular Rate sensors Specifications After Ref .[16.]

The accelerometer is a Crossbow CXL04M3. It consists of three orthogonally mounted, 0-5g ADXL05 accelerometers manufactured by Advanced Micro Devices. The CXL04M3 has the following specifications:

Characteristic	Specification
Output voltage	0-5 V
Sensitivity	500 mV/g (+/- 5%)
Output voltage at zero g	2.4-2.6 V
Bandwidth	DC-100 Hz
Operating temperature range	-5 to 75 C
Supply Voltage	5 V
Current consumption	24 mA

Table 2. Crossbow CXL04M3 Accelerometer Specifications After Ref. [17.]

The magnetometer is a Honeywell HMC2003. the specifications are given in table 3.

Characteristic	Specification
Reference Voltage	2.4 V
Output voltage	0.5 – 4.5 V
Sensitivity	1V/gauss
Field Range	-2 to 2 gauss
Resolution	40 μ gauss
Bandwidth	1 kHz
Operating temperature range	-40 to 85 C
Supply Voltage	6-15 V
Current consumption	20 mA

Table 3. Honeywell HMC2003 Specifications After Ref. [18.]

When the magnetometers are exposed high magnetic fields (in excess of 30 gauss), they become saturated and no longer give accurate readings. [Ref. 18.] The magnetometers include a manual reset circuit to correct this problem.

The connections to the MARG sensors are by way of a 15 conductor cable with a high density DB-15 connector. The size of the cable confines the movement of the

sensors to a radius of approximately five feet. The pin-outs of the connector are given in table 4.

Pin number	Signal Description
1	5 V
2	5 V
3	Angular Rate X
4	Angular Rate Y
5	Angular Rate Z
6	Accelerometer X
7	Accelerometer Y
8	Accelerometer Z
9	No connection
10	Magnetometer X
11	Magnetometer Y
12	Magnetometer Z
13	Ground
14	12V
15	Ground

Table 4. MARG Sensor Pinout

2. Analog to Digital Converter

Each MARG sensor is connected to its own National Instruments MIO-16XE-50 analog to digital (A/D) converter by means of a National Instruments SCB68 I/O connection board. The MIO-16XE is a 16-bit successive approximation analog to digital converter capable of 20k samples per second [Ref. 19.]. The SCB68 is a shielded connector block [Ref. 20.].

3. Computer

The MIO-16XE-50's are mounted in a Desktop PC system with an 866 MHz Intel Pentium III processor running the Microsoft Windows 2000 operating system. The computer controls the operation of the A/D converter and runs the software associated with the MARG system. This software is described in the following paragraphs.

C. SOFTWARE

The software was written in Microsoft Visual C++ object oriented language. The software consists of a GUI, complementary filter, calibration and animation routines.

1. Complementary Filter

The complementary filter high pass filters the angular rate sensor input and low pass filters the accelerometers and magnetometers. The filter block diagram is given in figure 4.

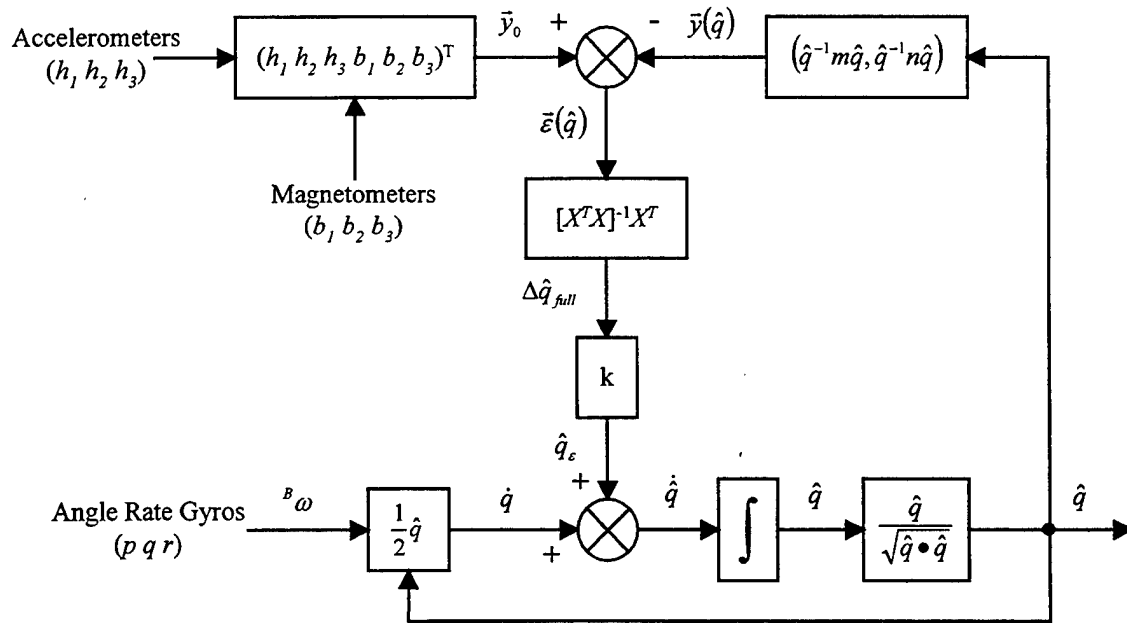

Figure 4. Complementary Filter From Ref. [21.]

2. Calibration Routine

The calibration routine consists of rotating the MARG sensors through a number of orientations in order to detect the maximum, minimum and null readings. These are used to set the scale factors for the magnetometers, accelerometers and angular rate sensors. The calibration routine performs a number of steps in parallel to minimize the number of orientations and rotations.

a. Accelerometer

The accelerometer maximum and minimum are found by measuring the force of gravity while the sensor is held stationary in one of six positions; x-axis up, x-axis down, y-axis up, y-axis down, z-axis up and z-axis down. The nulls are half way between the maximum and minimum.

b. Angular Rate Sensor

The angular rate sensors are calibrated by integrating the sensor's output while rotating it through a known angle. The calibration routine averages the results of two rotations; positive 90 degrees and negative 180 degrees. The null values are determined by measuring the sensor output while the sensor is at rest.

c. Magnetometer

The x-axis magnetometer is calibrated by pointing the x-axis North, rotating the sensor 360 degrees about the y-axis and recording the maximum and minimum values. The y and z axis are calibrated by pointing the y-axis North and rotating 360 degrees about the x-axis. This procedure allows the maximum and minimum to be detected regardless of the dip angle of the Earth's magnetic field. The null is defined as halfway between the maximum and minimum.

D. SUMMARY

The system described in this chapter demonstrated the feasibility of body tracking using MARG sensors. While it performed well in terms of cost, accuracy and computational efficiency, it is limited to tracking three limb segments. The five foot working radius severely limits its use. Fortunately, the design was well documented and modular and relatively easy to modify.

IV. WIRELESS MARG BODY TRACKING SYSTEM

A. INTRODUCTION

An ideal body tracking system would be so small that the user would not even notice it and have an unlimited working volume. While the sensors in the existing MARG systems are somewhat bulky, the principle drawback is the requirement for the user to be tethered to a desktop computer.

The migration to wireless body tracking was planned in two phases. The first phase replaces the desktop computer with a computer small enough to be worn or carried. The sensors will still be connected by cables, but communications between the wearable computer and the "rest of the world" will be over a wireless link. This expands the working volume to the range of the wireless link.

The second phase replaces the cables between the wearable computer and the sensors with another wireless link. This makes the system less cumbersome and easier to wear. This phase has not yet been completed.

B. PHASE I

Moving from a desktop computer to a wearable computer involved three main issues; selecting a wearable computer, handling the analog to digital conversion and communicating over a wireless link. The following paragraphs show how these issues were addressed.

1. Wearable Computer

While laptop computers are significantly smaller than their desktop counterparts, they are still too big to be carried comfortably. However, there are many classes of systems smaller than laptops: notebooks, subnotebooks, handhelds and palmtops. Size was not the only consideration; computing power, software compatibility, data acquisition and wireless support are also important factors.

The original software was written in C++ and compiled for Intel x86 compatible processors. The software uses Microsoft Foundation Classes (MFC) which requires that the code to be run in a Windows environment. Since funding was limited, the decision was made to use the software in its existing form. The compatibility requirements eliminated the palmtop and handheld class systems.

Wireless support was available in all classes of computer systems under consideration. Several of these systems supported multiple wireless modes including infrared, spread-spectrum radio modems and cell phones. No systems were eliminated because of this requirement.

The final requirement was that of data acquisition. Support for high bandwidth data acquisition existed only in the computers with PCMCIA slots.

Of systems considered, two met all the requirements: ViA's Wearable PC and Xybernaut's Mobile Assistant. The latter system was chosen because of its processor speed. The specifications for both systems are given in table 5.

	ViA Wearable PC	Xybernaut Mobile Assistant
Size (L x W x H)	9.75 x 3x 1.25	4.6 x 7.5 x 2.5
Weight	22 oz	28 oz
Processor	166MHz Cyrix	233MHz Pentium MMX
Operating System	Microsoft Windows 98	Microsoft Windows 98
Memory	64MB	32MB
Hard drive	6.2GB	12GB
PCMCIA slots	Two Type II or one Type III	Two Type II or one Type III
I/O	Full duplex audio, RS-232, USB	Full duplex audio, RS-232, USB
Detachable display	yes	yes

Table 5. Wearable Computer Specifications After Ref. [22.][23.]

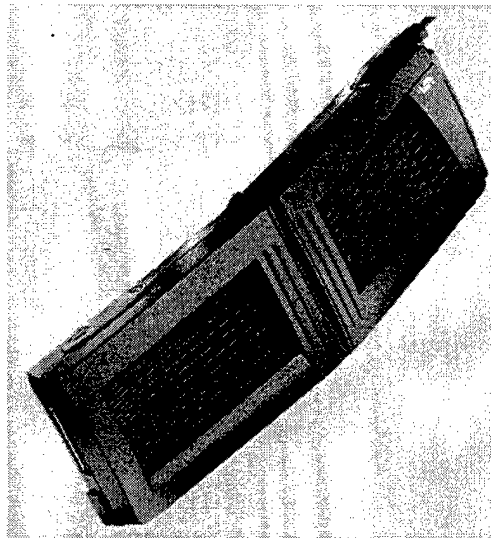

Figure 5. ViA Wearable PC

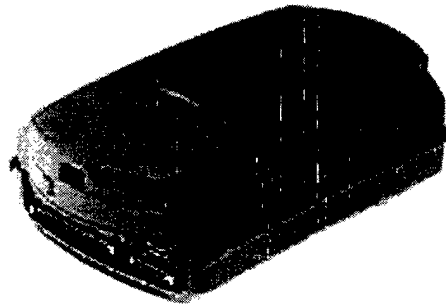

Figure 6. Xybernaut Mobile Assistant PC

2. Analog to Digital Conversion

In choosing an analog to digital converter, three factors were considered: speed, resolution and number of input channels. The original system used a single channel, 16 bit, 20k Samples/second analog digital converter for each MARG sensor.

While 16 bit PCMCIA A/D converters are available, they are significantly more expensive than the 12 bit cards. To determine the number of bits needed, sensor specifications and desired resolution of the overall system were considered.

The MARG sensors use magnetometers to sense the earth's magnetic field. This field is on the order +/- 0.6 gauss depending on orientation. The HMC2003 magnetometers have a resolution of 40 μ gauss. 15 bits are required to capture the entire useful range of the HMC2003 magnetometers.

The MARG sensors use linear accelerometers to sense static acceleration due to the earth's gravity. The ADXL05 accelerometers have a resolution of 5 mg. Gravity is +/-

1 g depending on orientation. Nine bits are required to capture the useful range of the ADXL05 accelerometers.

From a system perspective, 16 bits of resolution would theoretically allow orientation tracking accuracy on the order of a few thousandths of a degree. This level of tracking might be appropriate for tracking eye or finger movement but it is well beyond the goal of this research. 12 bits of data will theoretically allow orientation tracking accuracy within a tenth of a degree. Based on the system requirements and the resolution of the ADXL05, a 12 bit A/D converter was deemed sufficient.

The MIO-16XE-50 used in the original system had a maximum sampling rate of 20k samples/second. This rate, divided by the number of channels, yields the sampling rate per channel. Since the MARG sensors use nine channels, the maximum sampling rate per channel is 2.22k samples/second. The wireless system will only have one A/D converter and will support 15 MARG sensors. To maintain the current per channel sampling rate, the A/D converter will need 300k samples/second.

The MARG sensors have a maximum bandwidth of 100Hz. Nyquist's Theorem puts the minimum sampling rate at 200 Hz. This value was set as the minimum sampling rate per channel.

The previous system used a 16 channel A/D converter for each MARG sensor. There is only one PCMCIA slot available so the wireless system is limited to one A/D converter. With nine channels per MARG sensor and 15 MARG sensors in the system, the A/D converter needs to support 135 channels. PCMCIA A/D converters are limited to 16 channels. These channels require external multiplexing to support the required 135

channels. To support an external multiplexing circuit, the A/D converter needs to have digital input/output capability.

With 135 channels and a 200 Hz per channel sampling rate, an A/D converter with a minimum sampling rate at 27k samples/second is required. PCMCIA A/D cards have maximum sampling rates between 100k samples/second and 625k samples/second so this requirement was not difficult to meet.

Quatech's DAQP-12 met all of the above requirements and was selected for use in the wireless system. Its specifications are listed in table 6 and its pin-outs are in table 7.

Characteristic	Specification
Sampling Rate	100KSamples/second
Analog Input Resolution	12 Bits
Analog Inputs	8 differential 16 single-ended
Acquisition + Conversion Time	2 ms + 8ms
Programmable Gain	1, 2, 4, 8
Digital Input/Output channels	4/4

Table 6. Quatech DAQ-12P Specifications After Ref. [24.]

Hirose-32	D-37	Function	
32	37	Channel 0 (+)	Channel 0
31	18	Channel 0 (-)	Channel 8
30	36	Channel 1 (+)	Channel 1
29	17	Channel 1 (-)	Channel 9
28	35	Channel 2 (+)	Channel 2
27	16	Channel 2 (-)	Channel 10
26	34	Channel 3 (+)	Channel 3
25	15	Channel 3 (-)	Channel 11
24	33	Channel 4 (+)	Channel 4
23	14	Channel 4 (-)	Channel 12
22	32	Channel 5 (+)	Channel 5
21	13	Channel 5 (-)	Channel 13
20	31	Channel 6 (+)	Channel 6
19	12	Channel 6 (-)	Channel 14
18	30	Channel 7 (+)	Channel 7
17	11	Channel 7 (-)	Channel 15
16	28	Ground	
15	10	Full power	
14	26	Synchronous Sample Hold	
13	25	Digital in bit 0	
12	6	Digital in bit 1	
11	24	Digital in bit 2	
10	5	Digital in bit 3	
9	23	Digital out bit 0 (latched)	
8	4	Digital out bit 1 (latched)	
7	22	Digital out bit 2 (latched)	
6	3	Digital out bit 3 (latched)	
5	28	Ground	
4	28	Ground	
3	19	Ground	
2	19	Ground	
1	27	Reserved	

Table 7. Quatech DAQ-12P Pinout After Ref. [24.]

After selecting the A/D converter, an analog multiplexer (mux) had to be selected. With 16 channels on the A/D converter and a requirement for 135, an 8.4375:1 multiplexer was needed. Multiplexers are available in 2, 4, 8 and 16 channels. The 16:1 mux was chosen. There are only a few companies which manufacture 16:1 mux's and only one type was available at the time. This was the ADG-526A manufactured by Analog Devices. Based on availability, the ADG-526A was selected for use. Its specifications are listed in table 8 and its pinouts are in table 9.

Parameter	Value
R_{ON}	450 Ω max
$t_{TRANSITION}$	400 ns max
t_{OPEN}	400 ns max
t_{ON} (EN, WR*)	400 ns max
t_{OFF} (EN, RS*)	400 ns max
t_W Write Pulse Width	120 ns min
t_S Address, Enable Setup Time	100 ns min
t_H Address, Enable Hold Time	10 ns min
t_{RS} Reset Pulse Width	100 ns min

Table 8. Analog Devices ADG-526A Specifications After Ref. [25.]

Pin	Function	Pin	Function
1	VDD	15	D
2	NC	16	VSS
3	S16	17	S8
4	S16	18	S7
5	S15	19	S6
6	S14	20	S5
7	S13	21	S4
8	S12	22	S3
9	S11	23	S2
10	S10	24	S1
11	S9	25	EN
12	GND	26	A0
13	WR*	27	A1
14	A3	28	A2

Table 9. Analog Devices ADG-526A Pinout After Ref. [25.]

a. Multiplexing Hardware

The multiplexing circuit could be implemented in two ways. The first was to mux like signals from the different MARGs and feed each signal type to a separate A/D channel as shown in figure 7. The second was to mux all the signals at each MARG and give each MARG a separate channel as shown in figure 8.

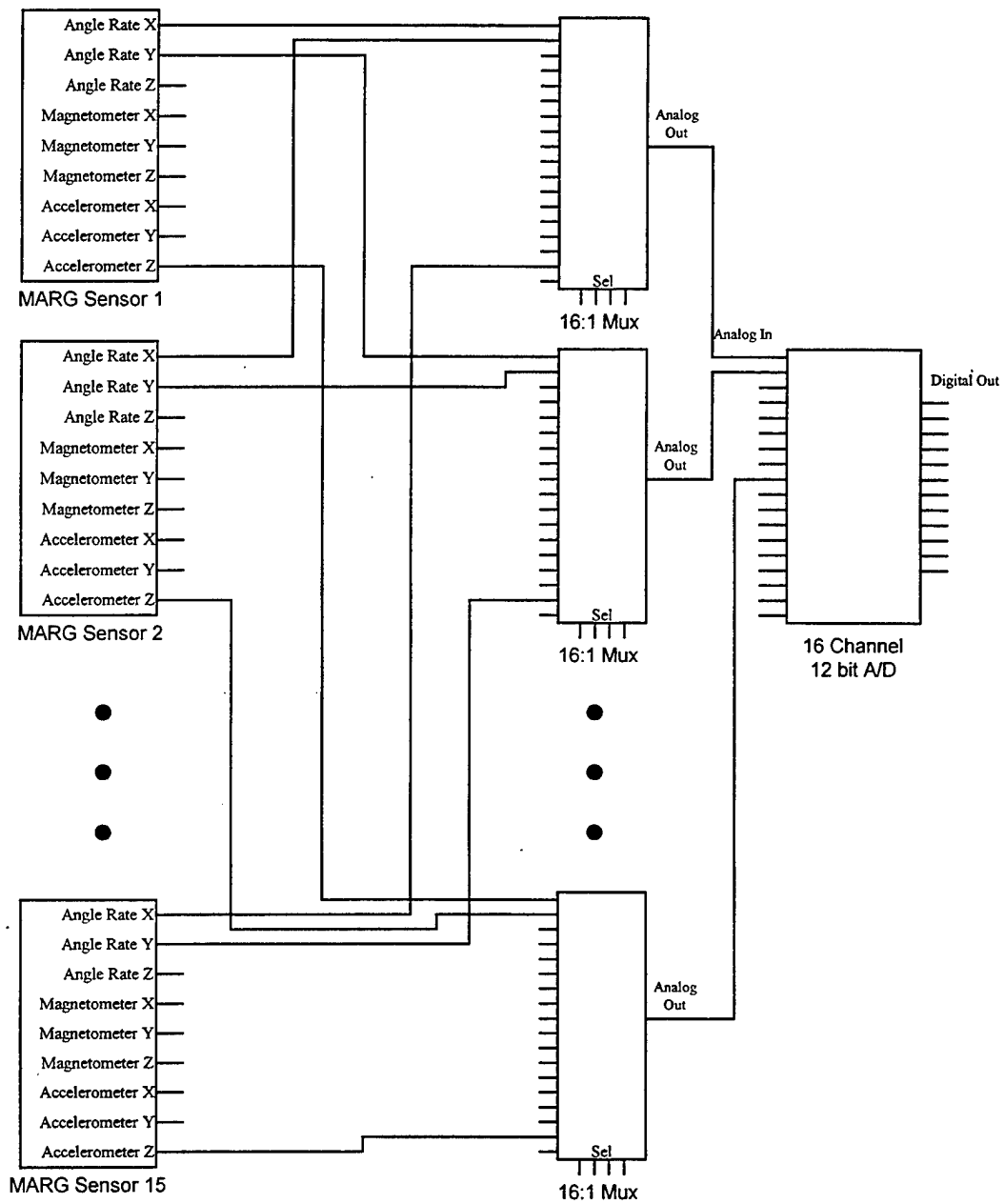

Figure 7. Multiplexing by Signal Type

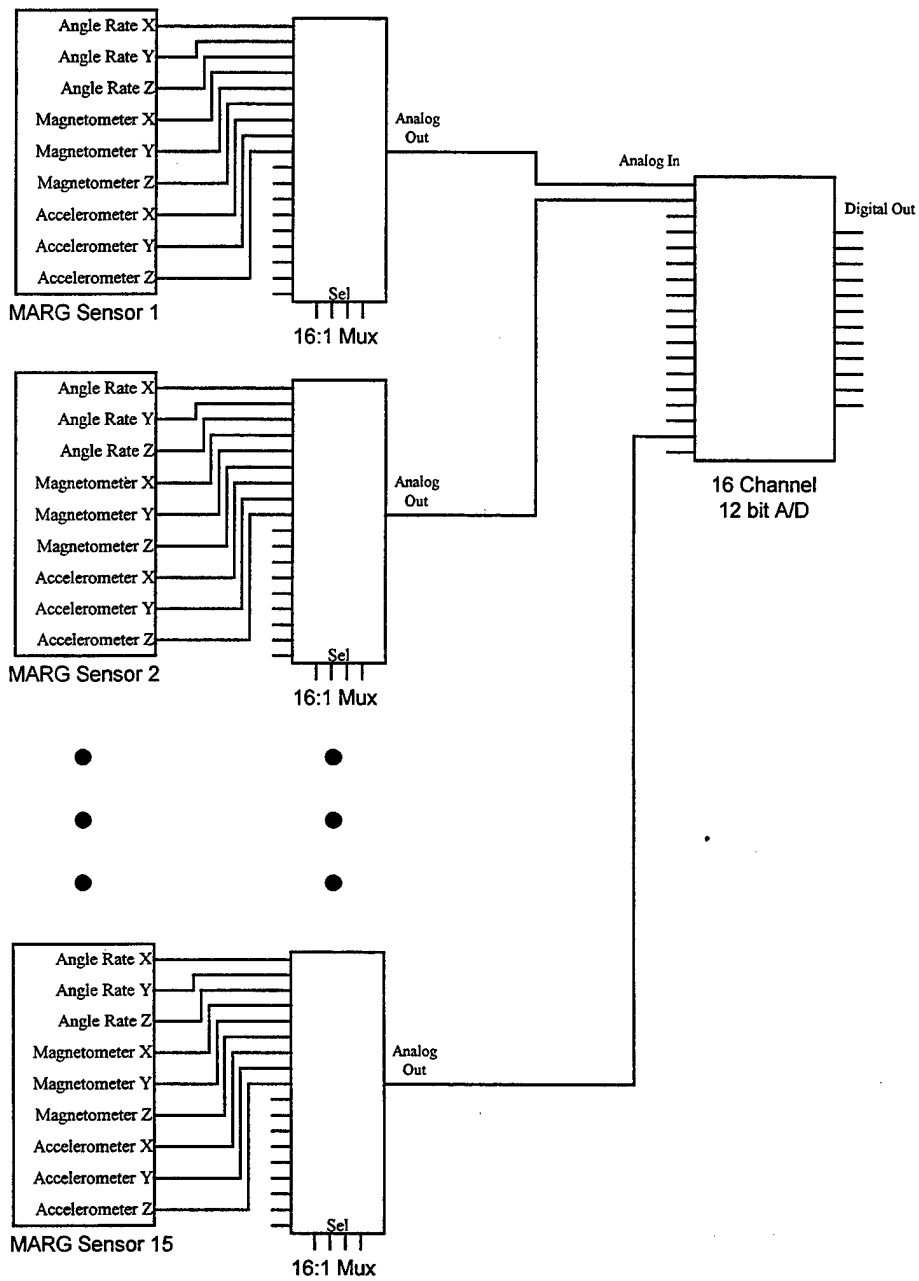

Figure 8. Multiplexing by Sensor Output

The benefit of multiplexing like signals from different MARG sensors is that only nine multiplexers are required. Multiplexing all signals at each MARG sensor requires 15 multiplexers but has two advantages: it reduces the cabling requirements from

14 to 7 (one signal, four control, one power and one ground) and it reduces the number of times a digital control signal needs to be sent in each cycle (9 vs. 15). The decision was made to multiplex all signals at each MARG sensor.

The multiplexer's address select lines were connected to four of the DAQ-12P digital input/output lines and the analog out lines were run to the appropriate DAQ-12P channel. The ADG526A can latch the address select lines, but this feature was not needed since the DAQ-12P latches its digital output lines. Therefore WR* was tied low, while RS* and EN were tied high. After the circuit was wire-wrapped, and a short test program was written.

As stated earlier, the required sampling rate was 27k samples/second. The DAQ-12 was rated at 100k samples/second which translates to 10 μ s per sample. The ADG526A's maximum switching time ($t_{\text{transition}}$) was specified as 400ns. Sampling at twice 200 Hz requires 1800 transitions. The ADG526A needs 720 μ s for this. This leaves the DAQ-12P 999.28ms out of every second to acquire the data. Using 10 μ s per sample, the DAQ-12P should be able to acquire 999.28k samples. This is well above the stated requirement.

Additional overhead for using the DAQ-12P's digital input output was anticipated, but the exact amount was not known. A short test program showed the delay was an order of magnitude higher than expected. The DAQ-12 achieves its 100k samples/second only during uninterrupted A/D conversions. By forcing digital I/O in between A/D conversions, the rate drops to 10k samples/second. For 15 MARG sensors, the sampling rate is 74 Hz, well below the 200 Hz minimum. The system could support five MARG sensors at 200 Hz. The specifications for the several other PCMCIA A/D

cards were reviewed and none of them make any mention of the effects of digital I/O on sampling rate.

To make the multiplexing circuit work at a constant 200 Hz for all 15 MARG sensors, the address would need to be generated by a sequencing circuit. The sequencing circuit would need to be synchronized to the A/D converter.

At the time, there were only three MARG sensors available and the decision was made to continue the project as is.

b. Analog to Digital Converter Software

The existing code has a class called *CAtoDConverter*. This class called various device driver routines for the National Instruments PCI-MIO-16XE-50 and supplied raw digital data to the classes *CSampler* and *CSensorCalibrator*. Figure 9 shows the flow of data.

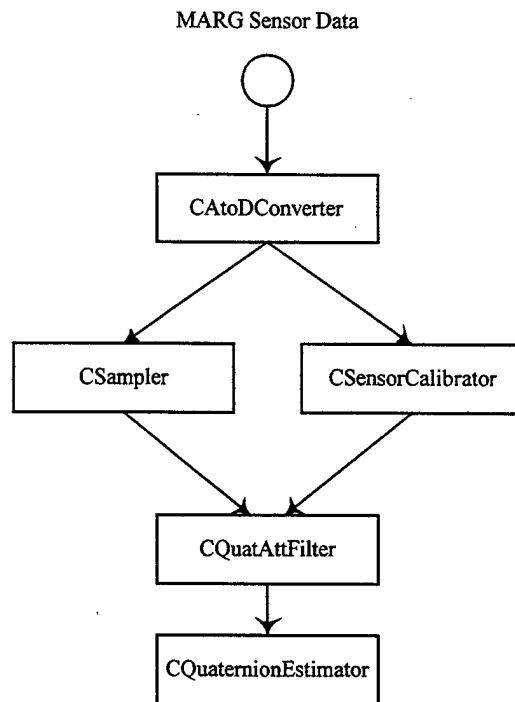

Figure 9. Original Class Diagram After Ref. [1.]

CtoDConverter was divided into two new classes; *CNiADC* and *CSensorData*. *CNiADC* contained the code for driving the PCI-MIO-16XE-50 and *CSensorData* passed data to *CSampler* and *CsensorCalibrator*. Another class, *CQADC*, was created containing the device driver calls for the DAQ-12P. This is illustrated in figure 10. The GUI was then modified to let the user select the appropriate data acquisition device.

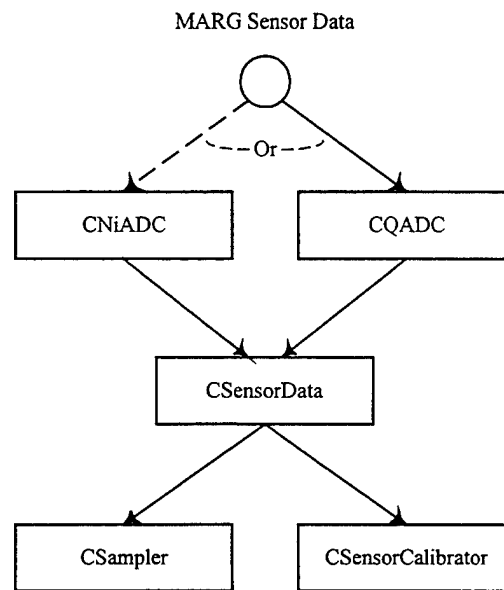

Figure 10. Class Diagram with PCMCIA Data Acquisition

The system performed as expected and the migration to the PCMCIA data acquisition card was complete. The last remaining task in Phase I was the implementation of the wireless link.

3. Wireless Link

There are many ways of implementing a wireless link; infrared, cellular phone, radio modem. The desire to have a large working volume precluded the use of IR links.

The requirement to track 15 human limbs segments, necessitated a data rate of 165kbps. This ruled out cellular phones and spread spectrum radio modems.

Many spread spectrum radios are able to act like a hardwired Ethernet connection and are transparent to the user. The range of these systems vary but are generally in the neighborhood of 50 to 200 feet [Ref. 26.]. Most support data rates of 1Mbps [Ref. 26.]. These systems are available as PCMCIA cards and were compatible with the wearable computers. The decision was made to implement the wireless link with these devices using the Internet Protocol (IP).

The IP communication was implemented in a new class, *CNetwork*. Since the *CSensorData* could already accept data from two different A/D converters, it was relatively straight forward adding a third source, *CNetwork*. *CSensorData* was then modified to send data from the A/D cards to *CNetwork* as shown in figure 11.

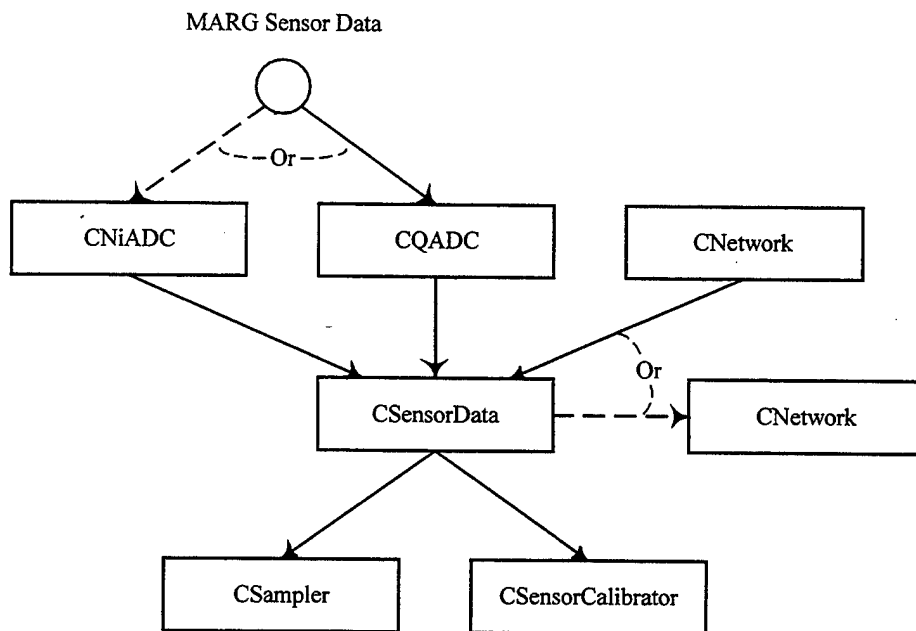

Figure 11. Class Diagram with Network Capability

In addition to sending and receiving sensor data, *CNetwork* class was responsible for coordinating the transfer of the data. Figure 12 shows how this communication was handled.

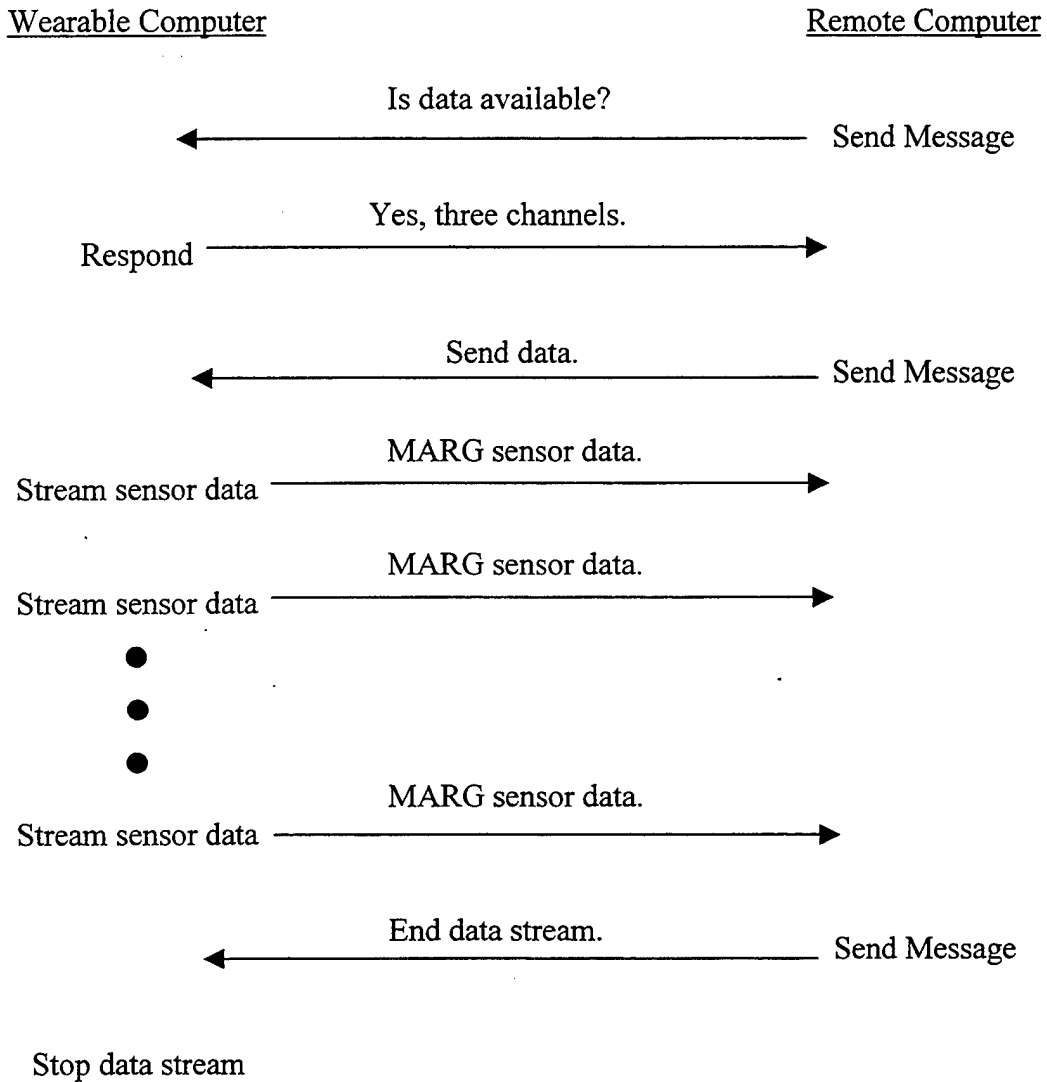

Figure 12. Flow of Network Communication

The two types of communication, command messages and streaming data, are different in nature and have different requirements. The command messages required

reliable were not time critical. The command messages are also short and occur only a few times during the execution of the program.

The MARG sensor data is longer than the command messages and occurs a hundred times every second. It has a very short lifespan. Rather than waiting for a delayed or lost set of MARG sensor data to be resent the system simply ignores it and processes the next available data.

There are two ways of using IP, Transmission Control Protocol (TCP) and User Datagram Protocol (UDP). TCP is a connection based protocol that provides reliable network communication. It ensures that packets are received in the order they are sent. If a packet becomes lost, it makes sure the packet is resent. UDP is a protocol that sends independent packets of data without regard for reliability. The advantage of UDP is that it is faster than TCP. For the sensor data, speed and not reliability was needed. UDP was well suited for this. The command messages need reliability, so they were sent using TCP.

4. Testing

The system was tested in a number of configurations during Phase I. The first step involved using a Pentium II class laptop computer hardwired to the local area network (LAN) and later connected to the LAN via the wireless link. Then the tests were repeated on the Xybernaut system.

While running the filter and animation algorithms, the laptop computer was not able to acquire the sensor readings at the requisite sampling rate. In the original MARG system, once the A/D cards were initialized they performed the sampling and conversion without supervision from the computer. In the wireless system, the computer had to

control the external multiplexing circuit for every sample. This greatly increased the workload of the computer. With the filter disabled, the system performed as required in both the hardwired and wireless LAN configurations. The tests were then repeated on the wearable computers with similar results.

C. PHASE II

The second phase of the project was to replace the remaining MARG sensor cabling with another wireless link. The driving factor for the Phase I wireless link was long range. Phase II's link only needed a range of a few feet and a transceiver had to be packaged with each sensor. Since multiple transceiver were operating in the same area, emphasis was placed on the links protocol.

IR systems met all the requirements but were limited to line of sight communication. Since this could not be guaranteed, IR systems were ruled out.

This left only the radio systems. There are a number of proprietary radio systems but an open-system was For compatibility reasons, open-systems were given preference over proprietary systems.

The much heralded Bluetooth technology seemed like a perfect match. It's range is on the order of ten meters and boasts a bandwidth of 1Mbps. Bluetooth PCMCIA cards have been developed as have embedded Bluetooth modules.

The wearable computers have two PCMCIA slots; one used for the Phase I wireless link and the other for A/D conversion. Since the wearable computer didn't have built in support for Bluetooth, one of the cards had to be removed. The DAQ-12P did not

perform as expected, so it was removed. This required the A/D conversion to take place inside the MARG sensor. There are several A/D converter chips currently on the market but they are generally limited to eight channels. The multiplexing circuit previously described would still be necessary.

The Bluetooth module embedded in the MARG sensor will need a controller to coordinate the transfer of data. While it would still be desirable to eliminate the cabling, this should not be accomplished at the expense of increasing the size of the MARG sensor. Several embedded controllers have built in A/D converters so the footprint of the system would not increase. Like the A/D converter chips, embedded controllers are typically limited to eight analog channels.

Unfortunately, Bluetooth has not made it to the market as fast as anticipated and the rest of Phase II was put on hold. Attention was now directed to the issue of limited analog channels.

D. SUMMARY

Phase I demonstrated the feasibility of a wireless MARG body tracking system. While the goal of tracking 15 limb segments at 100 Hz was not reached, the capability was raised from three MARG sensors to five.

The Phase II design moved the A/D conversion to the MARG sensor and eliminated the PCMCIA A/D conversion bottleneck.

Both phases faced a major challenge in the number of A/D channels. It was decided that the need for nine analog output channels should be examined.

THIS PAGE INTENTIONALLY BLANK

V. MARG SENSOR WITH EIGHT ANALOG SIGNALS

A. INTRODUCTION

Multiplexers are switches which are controlled by bi-level logic. The size and complexity of the multiplexers grow by powers of two. Ideally, a multiplexing circuit will have 2^n channels. These boundaries are 2, 4, 8, 16, etc. The MARG sensor with its nine analog channels requires a system with twice the complexity as a sensor having only eight analog channels. Since most A/D chips and embedded processors only have eight channels, and external multiplexer is required for anything having more than eight channels.

If the MARG sensor could be redesigned with eight analog channels, the goal of a wireless MARG sensor system would be easily realizable. This chapter examines ways of redesigning the MARG sensor to use only eight analog channels.

B. REDUNDANT SIGNALS

The best chance of eliminating an analog signal without reducing performance was to find a signal that was not needed. The angular rate sensors were considered essential because they provided instantaneous response. The accelerometers and magnetometers were only used to correct for drift. Both the magnetometers and the accelerometers determine orientation by measuring a vector's projection on three orthonormal axis. The magnitude of the vector is known. Gravity is 1g and the Earth's magnetic field is ~ 0.6 gauss. Using two known components of the vector, the magnitude of the third can be calculated. The sign of the third component cannot be calculated. To

determine the sign, the output of the third sensors would go to a single bit analog comparator. The output of the comparator represents the sign in digital format.

The MARG body tracking program has the ability to save sensor data and filter results to a text file. This feature enabled experiments to be performed on a known set of data and allowed direct comparison of the results. To perform the experiments, the C++ complementary filter code was ported to MATLAB. The MATLAB filter was run on a known set of data to verify its functionality.

The procedure began with system calibration. Data was captured using all nine sensors. The data had both a static and a dynamic period. Then the data was processed two more times, once with a computed magnetometer channel and then with a computed accelerometer channel. The filter gain was set at 5 during all of the tests with equal weighting given to the magnetometers and the accelerometers.

1. Static Tests

Angular rate sensors sometimes have a non-zero output even when held in a fixed position. This can be caused by calibration problems or drift. Figure 13 shows the non-zero output of the angular rate sensors during a static test. Using data from the three magnetometers and three accelerometers, the complementary filter corrects these errors to produce an output that is constant for each axis.

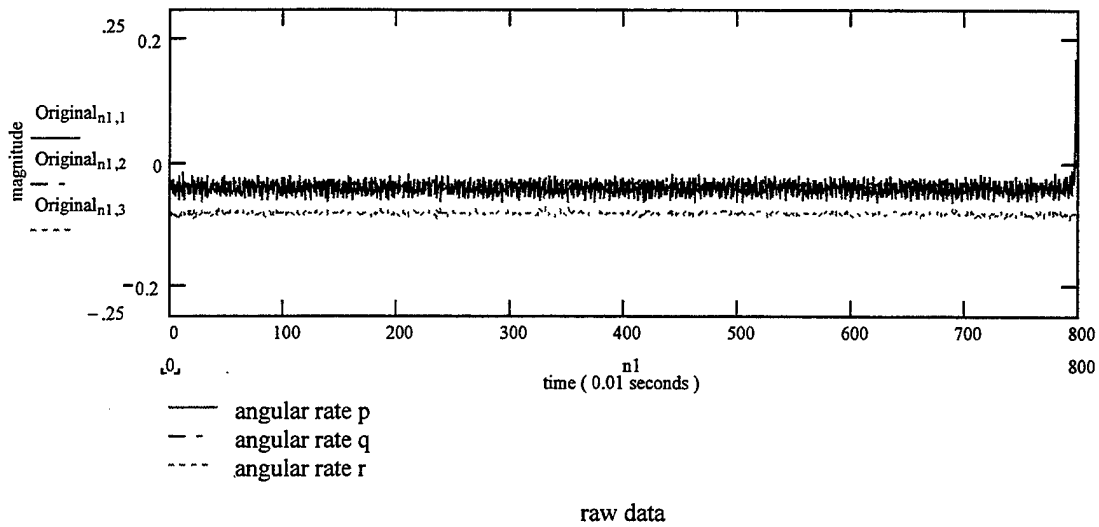
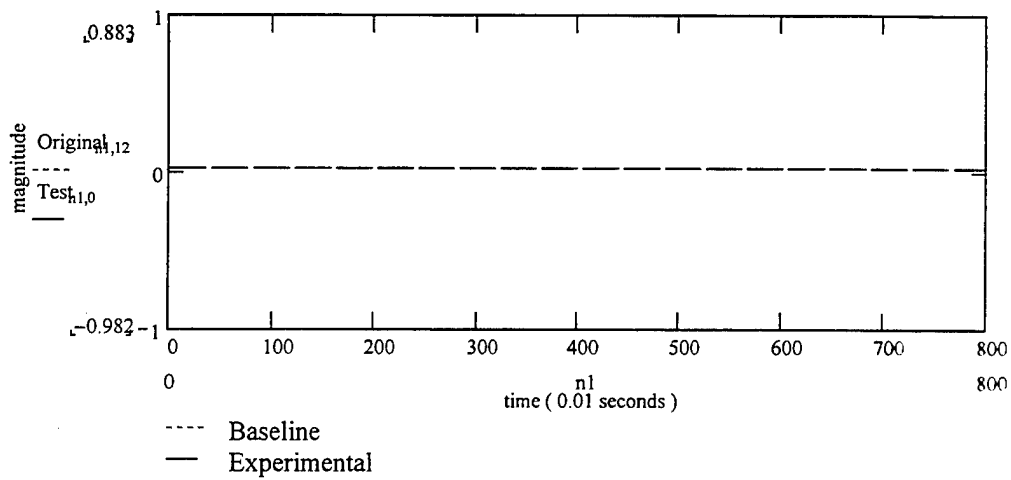
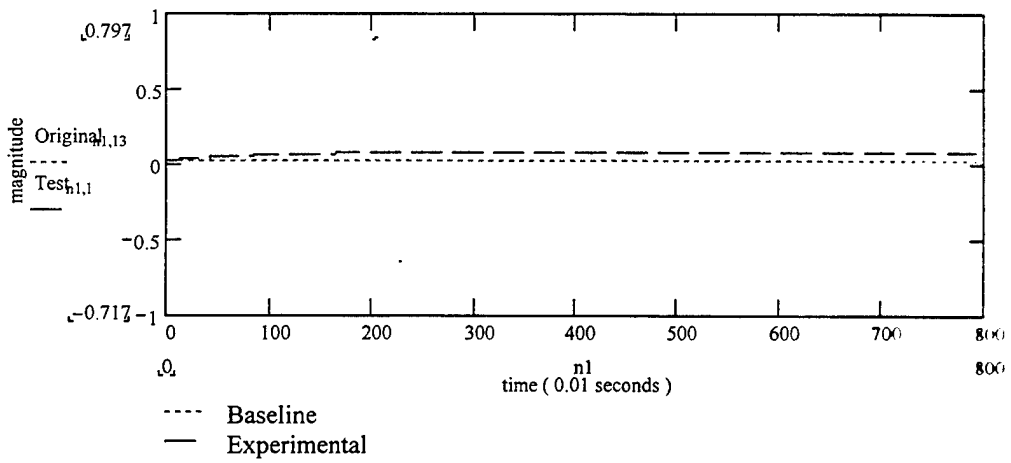

Figure 13. Static Test Angular Rate Sensor Output

In this series of tests, the filter was run three times: first with all nine sensors and the two more times with eight. In the first test with eight sensors, one of the magnetometer sensors was replaced with a calculated value. The second test with eight sensors had an accelerometer output which was replaced with a calculated value. Figure 14 shows the x-axis output of the filter. In this figure, the filter with nine sensors is labeled baseline. The filter with eight sensors and a calculated magnetometer is labeled experimental. Figures 15 is the y axis output and figure 16 is the z-axis output during the same test.



p
 Figure 14. Static Magnetometer Test X-Axis



q
 Figure 15. Static Magnetometer Test Y-Axis

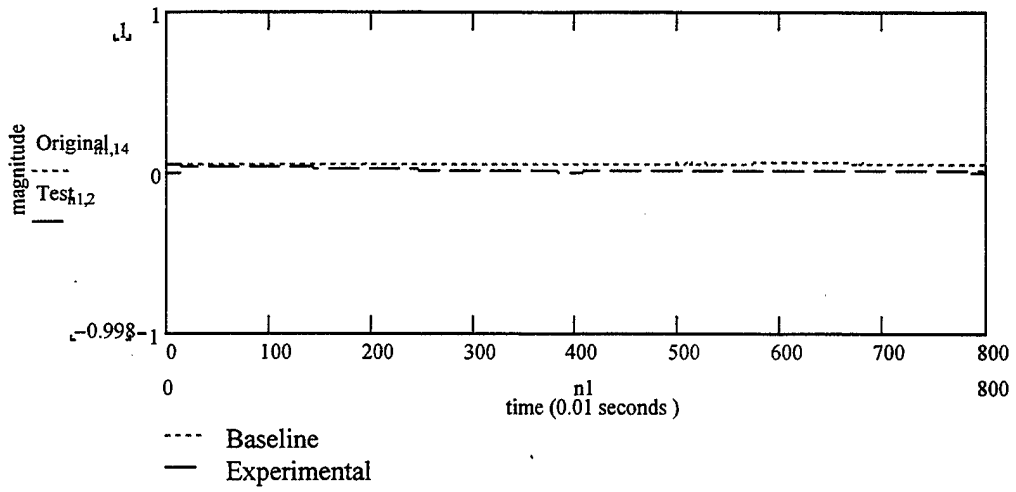

Figure 16. Static Magnetometer Test Z-Axis

Figures 17 through 19 show the data from the calculated accelerometer static tests.

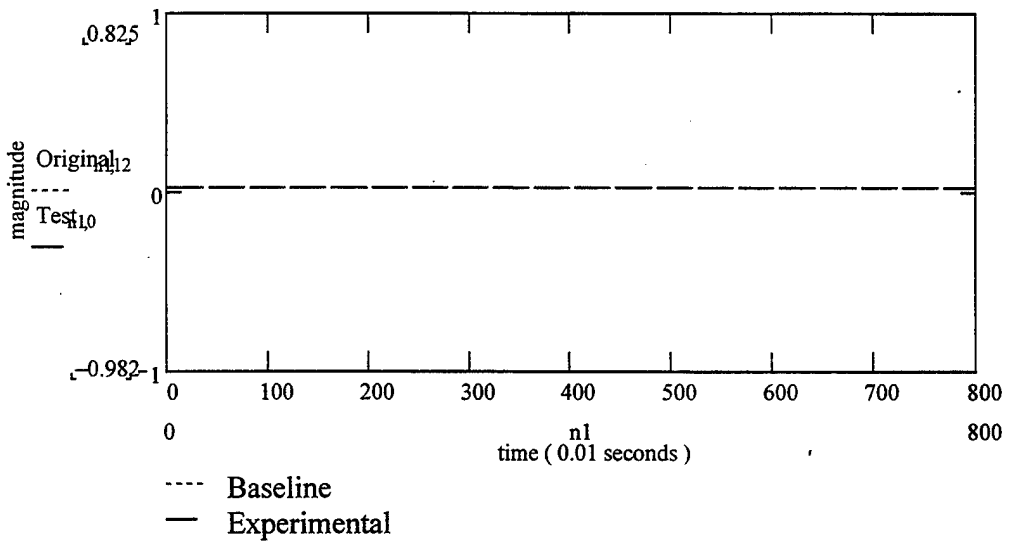

Figure 17. Static Accelerometer Test X-Axis

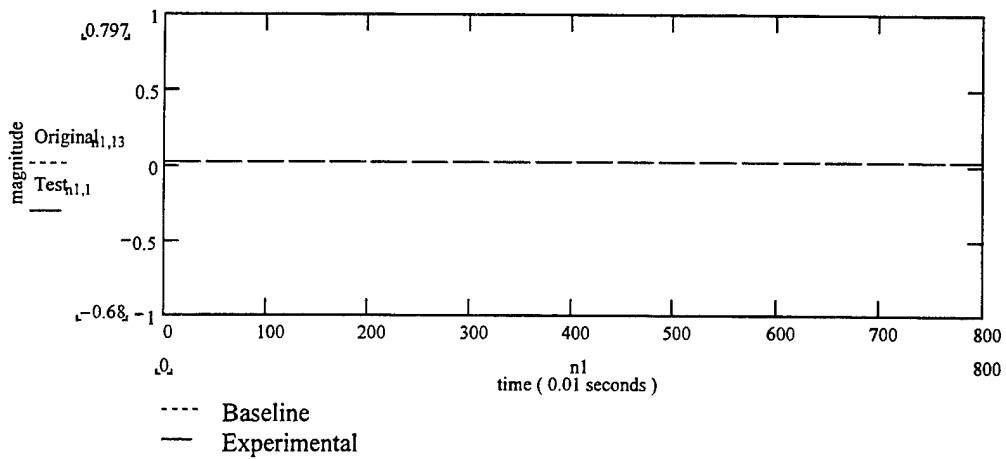

Figure 18. Static Accelerometer Test Y-Axis

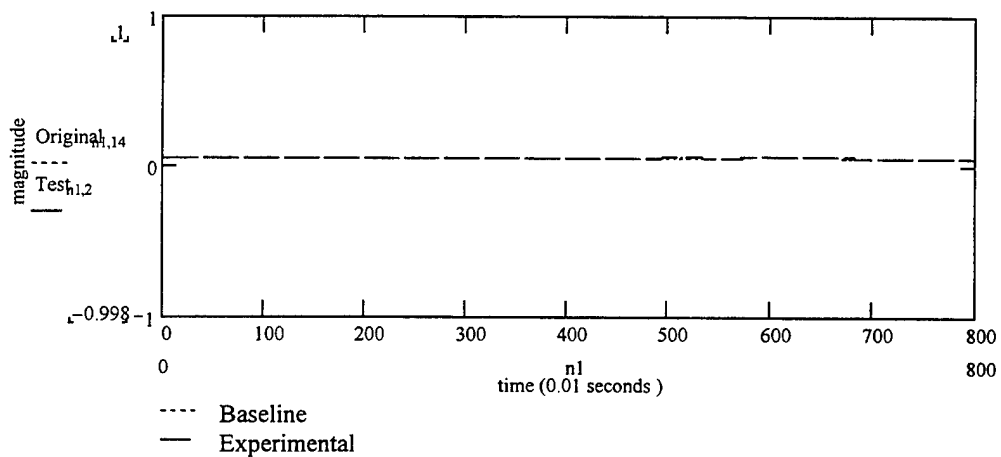

Figure 19. Static Accelerometer Test Z-Axis

All angular rate sensors had a none zero value during the static test. During the test with a calculated magnetometer, the output converged in all three axis. In the x-axis, the output converged to the correct value. In the y and z axis, the output differed by 7% from the correct value. The accelerometers appeared to have performed flawlessly.

2. Dynamic Tests

These tests were performed in the same manner as the static tests except the MARG sensor was rotated six times; two rotations about each axis of 90 degrees and 180 degrees. Figures 20 through 22 are from the magnetometer tests. Figures 23 through 25 are from the accelerometer tests.

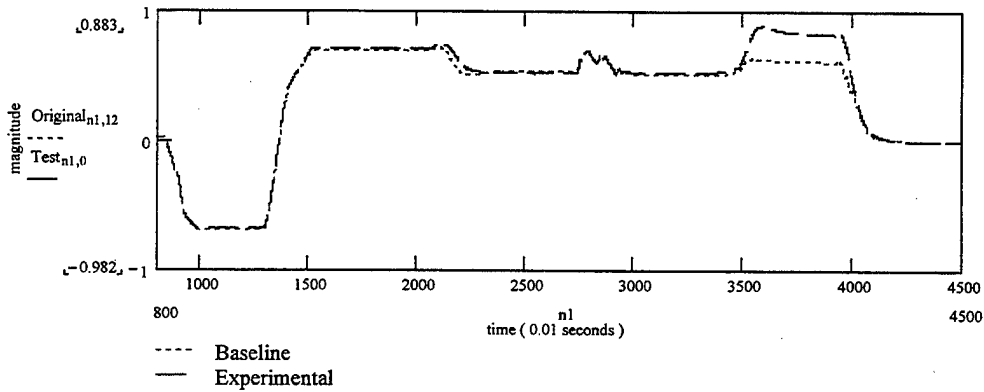

Figure 20. Dynamic Magnetometer Test X-Axis

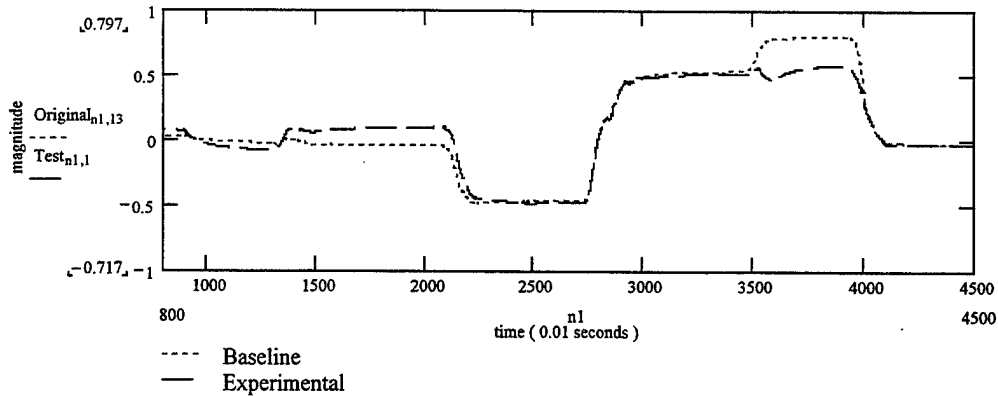

Figure 21. Dynamic Magnetometer Test Y-Axis

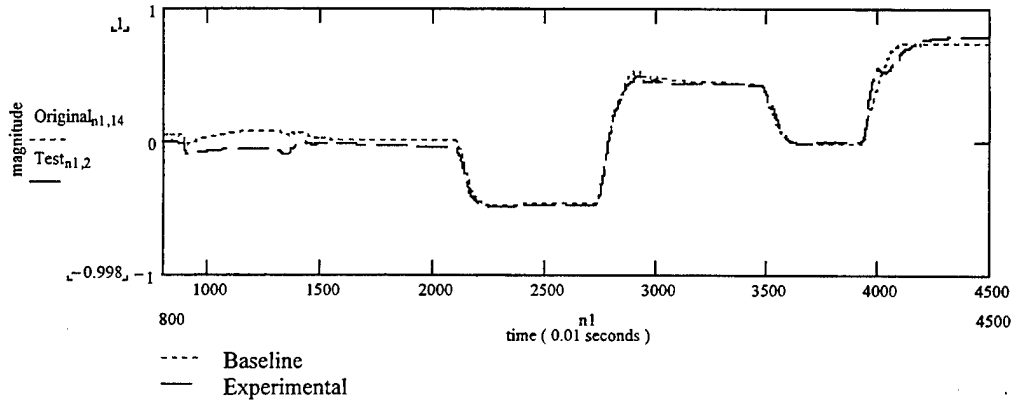

Figure 22. Dynamic Magnetometer Test Z-Axis

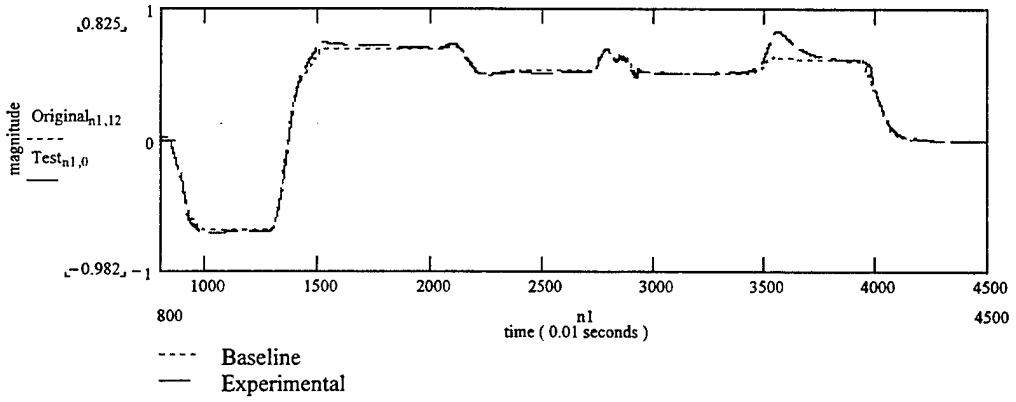

Figure 23. Dynamic Accelerometer Test X-Axis

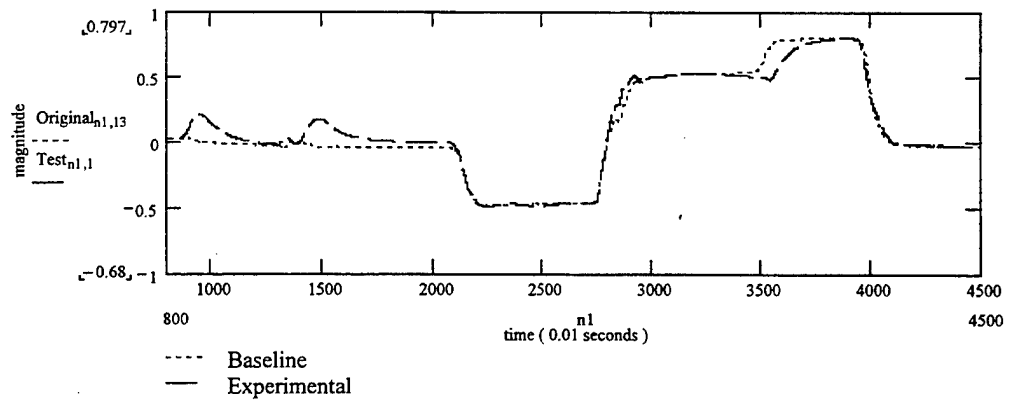

Figure 24. Dynamic Accelerometer Test Y-Axis

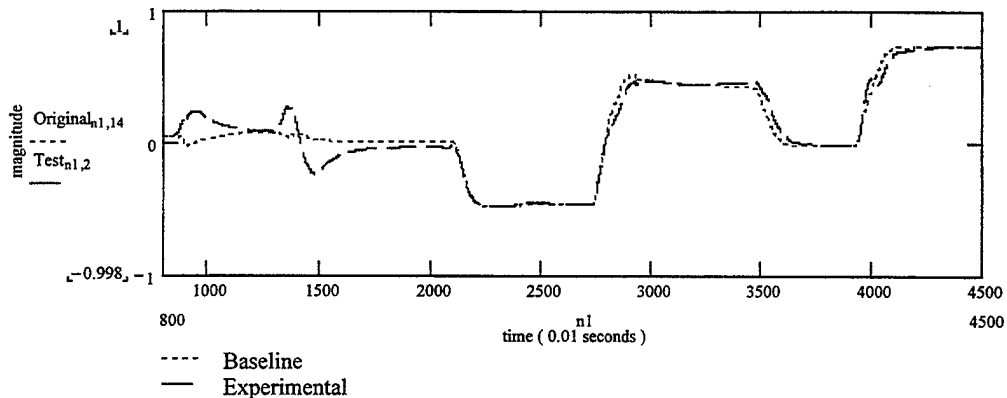

Figure 25. Dynamic Accelerometer Test Z-Axis

As with the static tests, the magnetometers converged to an incorrect value. This time, the error was much more pronounced. The accelerometers did have large errors immediately following a rotation, but they quickly converged to the correct value. The initial error was expected because the accelerometers experience dynamic and static acceleration during the rotations.

On the surface, a MARG with eight analog signals (three angular rate, three magnetometer and two accelerometer) seems feasible. Additional experimentation is required to verify this. The experiment, as run, had too many variable to establish cause and effect. By testing a five sensor MARGs (three angular rate sensors, two magnetometers or accelerometers) against six sensor MARGs (three angular rate sensors, three magnetometers or accelerometers) a more accurate assessment can be made.

3. Raw Data

The magnetometers converged to incorrect values during some the tests but the accelerometers always converged to the correct value. To determine the difference, the

raw was plotted and analyzed. Since the calculated values were based on the assumption of a constant vector magnitude, these plots were examined as well. Figure 26 shows the magnitude of the acceleration vector and figure 27 shows the magnetic field vector.

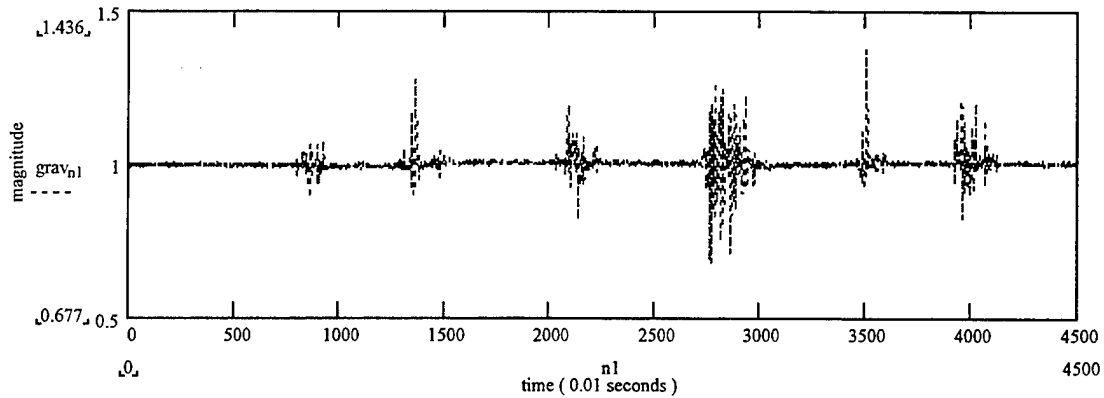

Figure 26. Magnitude of Accelerometer Vector

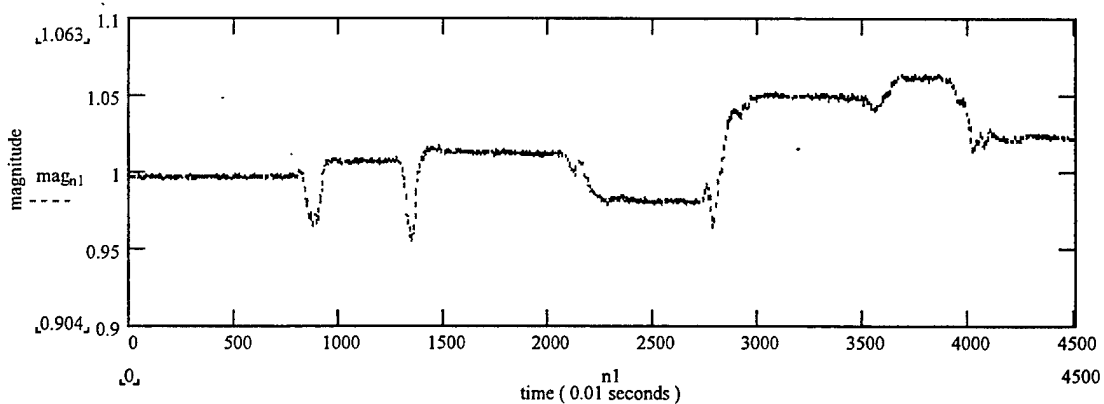

Figure 27. Magnitude of Magnetic Vector

The accelerometer vector was very close to one except during periods of linear acceleration. This was expected. What was not expected was the pronounced variations in the magnetometers. While ferrous metals and magnetic sources can cause variation similar to that observed, the manner in which the experiments were conducted makes it

unlikely that this was the cause. The variation in the magnitude of the magnetic vector seemed to indicate a problem with the calibration routine.

D. SUMMARY

The experiments involving redundant signals looked promising. The accelerometer test show that angular rate sensor errors can be corrected using a reduced number of sensors. Additional experiments may show the same for the magnetometers.

Examination of the raw data indicated possible problems with the sensor hardware and calibration routines. If these errors are found and corrected, system performance could be enhanced.

The MARG sensors were constructed over a year ago and many advances have been made since then. Tokin has come out with a smaller version of their angular rate sensor and Analog Devices released an accelerometer with twice the resolution of the ADXL05. Analog Devices also released an accelerometer with digital (pulse width) outputs.

While we were unable to find a suitable microcontroller with nine A/D channels, there were several with eight A/D channels and multiple timers. These timers can measure the pulse width of a digital signal and would allow the use of all nine sensors; six with analog outputs and three with digital outputs.

THIS PAGE INTENTIONALLY BLANK

VI. CONCLUSIONS

A. SUMMARY

While the previous design demonstrated the feasibility of body tracking using MARG sensors, it required the user to be tethered to a desktop. The system was limited to three MARG sensors.

This thesis demonstrated the feasibility of a wireless MARG body tracking system capable of sampling five MARG sensors at 100 Hz and 15 MARG sensors at 37 Hz. The working radius of the system was increased from five feet to the range of the wireless LAN.

A new system was proposed which solved the A/D conversion bottleneck and replaced the remaining cables with a second wireless link. To facilitate the implementation of the proposed system, a MARG sensor was tested using only eight of its nine analog channels. The MARG testing indicated a possible problem with the MARG sensors or the calibration routine.

B. SUGGESTIONS FOR FUTURE WORK

Work on the wireless link between MARG sensors and the computer need to be continued. If the MARG sensors are equipped with an embedded processor, it would be possible to perform the orientation computations inside the MARG sensor. Instead of having the MARG sensors transmit nine channels of data they could simply transmit three channels of orientation information. This would reduce the bandwidth requirement by a factor of three and reduce the amount of computation performed by the computer.

THIS PAGE INTENTIONALLY LEFT BLANK

LIST OF REFERENCES

1. Bachmann, E., *Inertial and Magnetic Tracking of Limb Segment Orientation for Inserting Humans into Synthetic Environments*, Ph.D. Dissertation, Naval Postgraduate School, Monterey, CA, December 2000.
2. Durlach, N. I., Mavor A. S., National Research Council, "Virtual Reality: Scientific and Technological Challenges," National Academy Press, Washington, D.C., March 1995.
3. Bachmann, E., Duman I., Usta, U., McGhee, R., Yun, X., and Zyda, M., "Orientation Tracking for Humans and Robots Using Inertial Sensors." *Proceedings of International Symposium on Computational Intelligence in Robotics & Automation (CIRCA 99)*, Monterey, CA, November 1999, pp.187-194.
4. Usta, U., *Comparison of Quaternion and Euler Angle Methods for Joint Angle Animation of Human Figure Models*, Master's Thesis, Naval Postgraduate School, Monterey, CA, March 1999.
5. Craig, J., *Introduction to Robotics, Mechanics and Control, Second Edition*. Addison-Wesley Publishing Company, Menlo Park, CA, February 1989
6. Skopowski, P. F., *Immersive Articulation of the Human Upper Body in a Virtual Environment*, Master's Thesis, Naval Postgraduate School, Monterey, CA, December 1996.
7. Duman, I., *Design, Implementation, and Testing of a Real-Time Software System for a Quaternion-Based Attitude Estimation Filter*, Master's Thesis, Naval Postgraduate School, Monterey, CA, March 1999
8. Meyer, K., Applewhite, H., and Biocca, F., "A Survey of Position Trackers." *Presence: Teleoperators and Virtual Environments*, Spring, 1993, Volume 1, Number 2, pp. 173-200.
9. Henault, G. A., *A Computer Simulation Study and Component Evaluation for a Quaternion Filter for Sourceless Tracking of Human Limb Segment Motion*. Master's Thesis, Naval Postgraduate School, Monterey, CA, September 1996.
10. Welch, G., Bishop, G., Vicci, L., Brumback, S., Keller, L., Colucci, D., "The HiBall Tracker: High Performance Wide-Area Tracking for Virtual Reality and Augmented Environments," *Proceedings of the ACM Symposium on Virtual Reality Software and Technology 1999 (VRST 99)*, University College London, July 1999.
11. Morris, T., Donath, M., "Using a Maximum Error Statistic to Evaluate Measurement Errors in 3D Position and Orientation Tracking Systems," *Presence: Teleoperators and Virtual Environments*, Volume 2, Number 4, MIT Press, Cambridge, MA, Fall 1993, pp. 314-343.,

12. Baratoff, G., Blanksteen, S., *Tracking Devices*, University of Maryland, Washington, DC., June 1993.
13. Hand, C., "A Survey of 3-D Input Devices," Technical Report CS TR94/2, De Montfort University, Leicester, UK, May 1993.
14. Brown, R., Hwang, P. *Introduction to Random Signals and Applied Kalman Filtering, Second Edition*, John Wiley and Sons, Inc., New York, NY, December 1992.
15. McKinney Technology, Doug McKinney, 9 Glen Avenue, Prunedale, CA 93907.
16. Tokin America Inc., *Tokin CG16D Data Sheet*, <http://www.tokin.com>, February 2000.
17. Crossbow Inc., *CXL04M3 Data Sheet*, <http://www.xbow.com/>, May 1998.
18. Honeywell Inc., *HMC2003 Data Sheet*, <http://www.sec.honeywell.com>, September 1997.
19. National Instruments Corporation, *DAQ Hardware Overview*, Austin, TX, June 2000.
20. National Instruments Corporation, <http://www.natinst.com>, August 2000.
21. Bachmann, E., Research Notes: Quaternion Attitude Filter, Computer Science Department, Naval Postgraduate School, Monterey, CA, 1996.
22. ViA Inc., <http://www.via-pc.com/>, January 2001.
23. Xybernaut Corporation, <http://www.xybernaut.com/>, January 2001.
24. Quatech Inc., *DAQ-12 Users Manual*, Akron, OH, December 2000.
25. Analog Devices Inc., ADG-526A Data Sheet, <http://www.analog.com/pdf/>, September 2000.
26. Cisco Systems, Aironet 300 Users Guide, <http://www.cisco.com/>, December 2000.

INITIAL DISTRIBUTION LIST

1. Defense Technical Information Center2
8725 John J. Kingman Road, Suite 0944
Ft. Belvoir, VA 22060-6218

2. Dudley Knox Library2
Naval Postgraduate School
411 Dyer Road
Monterey, CA 93943-5101

3. Director, Training and Education1
MCCDC, Code C46
1019 Elliot Road
Quantico, VA 22134-5027

4. Director, Marine Corps Research Center2
MCCDC, Code C40RC
2040 Broadway Street
Quantico, VA 22134-5107

5. Marine Corps Representative1
Naval Postgraduate School
Code 037, Bldg. 330, Ingersoll Hall, Room 116
411 Dyer Road
Monterey, CA 93943

6. Marine Corps Tactical Systems Support Activity1
Technical Advisory Branch
Attn: Librarian
Box 555171
Camp Pendleton, CA 92055-5080

7. Chairman, Code EC1
Department of Electrical and Computer Engineering
Naval Postgraduate School
Monterey, CA 93943-5121

8. Professor Xiaoping Yun, Code EC/Yx1
Department of Electrical and Computer Engineering
Naval Postgraduate School
Monterey, CA 93943-5121

- 9. Professor Sherif Michael, Code EC/Mi1
Department of Electrical and Computer Engineering
Naval Postgraduate School
Monterey, CA 93943-5121

- 10. Professor Eric Bachmann, Code CS/Bc.....1
Department of Computer Science
Naval Postgraduate School
Monterey, CA 93943-5121

- 11. Pierre Hollis1
14 Secretariat Drive
Stafford, VA 22554