

REPORT DOCUMENTATION PAGE

3

Public reporting burden for this collection of information is estimated to average 1 hour per response, including the time for data needed, and completing and reviewing this collection of information. Send comments regarding this burden estimate, this burden to Department of Defense, Washington Headquarters Services, Directorate for Information Operations and Rep 4302. Respondents should be aware that notwithstanding any other provision of law, no person shall be subject to any penalty for not providing information if it does not have a valid OMB control number. PLEASE DO NOT RETURN YOUR FORM TO THE ABOVE ADDRESS.

AFRL-SR-BL-TR-01-

maintaining the
ons for reducing
VA 22202-
isplay a currently

0662

1. REPORT DATE (DD-MM-YYYY) 10-12-2001	2. REPORT TYPE Final Technical Report	01 Jan 1999 - 30 Nov 2001
---	--	---------------------------

4. TITLE AND SUBTITLE Research on Intense Pulsed Power for Electromagnetic Radiation	5a. CONTRACT NUMBER
	5b. GRANT NUMBER F49620-99-1-0082
	5c. PROGRAM ELEMENT NUMBER

6. AUTHOR(S) Carl B. Collins	5d. PROJECT NUMBER
	5e. TASK NUMBER
	5f. WORK UNIT NUMBER

7. PERFORMING ORGANIZATION NAME(S) AND ADDRESS(ES) The University of Texas at Dallas 2601 North Floyd Road P.O. Box 830688 Richardson, TX 75083-0688	8. PERFORMING ORGANIZATION REPORT NUMBER
--	--

9. SPONSORING / MONITORING AGENCY NAME(S) AND ADDRESS(ES) Air Force Office of Scientific Research AFOSR/ NE 801 North Randolph Street, Room 732 Arlington, VA 22203-1977	20020107 108
--	--------------

12. DISTRIBUTION / AVAILABILITY STATEMENT Approved for public release; distribution unlimited	AIR FORCE OFFICE OF SCIENTIFIC RESEARCH (AFOSR) NOTICE OF TRANSMITTAL DTIC. THIS TECHNICAL REPORT HAS BEEN REVIEWED AND IS APPROVED FOR PUBLIC RELEASE LAW AFR 190-12. DISTRIBUTION IS UNLIMITED
--	---

13. SUPPLEMENTARY NOTES

14. ABSTRACT
Nuclear spin isomers store electromagnetic energy at densities reaching 1.3 GJ/g for shelf lives approaching centuries. One example, Hf-178 has been shown to release such stored energy when triggered by x-ray flashes at modest power levels. In this work trigger pulses were derived from a familiar x-ray source typically used in dental medicine. Subsequent experiments using tunable x-rays from the synchrotron radiation source, Spring-8 showed that the triggering was initiated by photoionization of an electron from the L-shell surrounding the isomeric nucleus. A fraction of 0.2% of those photoionizing events led to triggering of the release of the energy stored by the Hf-178 nuclear spin isomer. The experimental data agrees with predictions of a process termed NEET through which properties of nuclear states are altered by quantum mechanical mixing of the electronic and nuclear wave functions caused by incident electromagnetic radiation.

15. SUBJECT TERMS
Nuclear spin isomers, High energy densities, Nuclear excitation by energy transfer (NEET).

16. SECURITY CLASSIFICATION OF: Unclassified			17. LIMITATION OF ABSTRACT SAR	18. NUMBER OF PAGES 24	19a. NAME OF RESPONSIBLE PERSON Carl B. Collins
a. REPORT Unclassified	b. ABSTRACT Unclassified	c. THIS PAGE Unclassified			19b. TELEPHONE NUMBER (include area code) (972) 883-2864

FINAL TECHNICAL REPORT

to the

US AIR FORCE OFFICE OF SCIENTIFIC RESEARCH (AFOSR)

describing accomplishments in the

Research on Intense Pulsed Power for Electromagnetic Radiation

during the period

January 1, 1999 to November 30, 2001

supported by

Grant No: F49620-99-1-0082

to the

**Center for Quantum Electronics
University of Texas at Dallas
PO Box 830688, Richardson, TX 75083-0688**

**submitted by the Principal Investigator
Carl B. Collins**

December 10, 2001

TABLE OF CONTENTS

EXECUTIVE SUMMARY	4
BACKGROUND	7
ACCOMPLISHMENTS AND NEW FINDINGS	7
Objective	7
Coincidence Detection	7
Coincidence Results	8
NEET - Nuclear Excitation by Energy Transfer	10
NEET Excitation of ^{178}Hf Isomers with Synchrotron Radiation	11
Excitation of the New Line by NEET	15
References	16
SIGNIFICANCE OF ACCOMPLISHMENTS	16
APPENDIX I	

EXECUTIVE SUMMARY

Technical achievements

Nuclear spin isomers store the highest densities of energy possible without nuclear reactions. For example, an isomer of ^{178}Hf stores 2.445 MeV per atom for a shelf life of 31 years. [1] In practical terms this means that a sample of the size of a golf ball would store the energy equal to a metric ton of chemical fuels or explosives. However, in nuclear spin isomers the energy is stored electromagnetically so that it would be released as x-rays and γ -rays, if it could be triggered. Prior to our work it had been thought to be impossible to trigger the release of these great energy densities trapped in the internal electromagnetic excitations of nuclear spin isomers. ***Building upon our unique level of experience with nuclear spin isomers, during the course of the 3 years of our research for AFOSR we demonstrated how to trigger the 31-year isomer of ^{178}Hf .*** [2,3] The x-rays from a small device familiar from dental examinations proved to be sufficient; in fact it is "easy" to trigger nuclear spin isomers. These extraordinary results have sustained peer review, have been published in the leading technical journals [2-5] and have been precisely confirmed by independent work at AFRL – Albuquerque.

A review of the technical background and that history of accomplishment was recently collected for an invited review paper [4]. It has been accepted for publication and describes in detail our research up to the current year 2001. As detailed there, our efforts in 1999 and 2000 were focused upon proof of the efficacy for triggering nuclear spin isomers; and upon the development of a powerful coincidence system of detection through which the phenomenology of the subsequent energy release could be described. Most recently, our successes in the use of synchrotron radiation (SR) to trigger nuclear spin isomers have revolutionized further the methodology for this type of research. Competing with a prestigious DOE Consortium comprising LLNL, LASL, and the Argonne synchrotron group, our Team succeeded at the Japanese facility SPring-8 to open completely new directions into isomer triggering. In contrast, the DOE Consortium produced a total failure, either because of flawed target design or because the Argonne synchrotron provided insufficient stability of the combination of intensity and x-ray energy needed for this completely new type of research. Critical "Comments" upon the DOE experiment have been submitted for publication and copies appear in Appendix I. In fact we have performed both the first and second successful experiments ever conducted on nuclear spin isomers with SR.

In May, 2001 at the AFOSR Telluride Isomer Workshop we reported that triggering occurs primarily through a mechanism [6,7] mixing properties of the nuclear and atomic states in order to deliver the angular momentum needed to accelerate the decay of the isomer. In our work the process has been confirmed as a truly major effect, being characterized by a cross section about equal to 0.2% of the total for the photoionization of the L-shell electrons in Hf. As such, it means that triggering is very "easy" to accomplish, while nevertheless releasing about 250x the energy expended by the triggering event. The bandwidth for absorption of trigger photons is very "forgiving," being as great as 4 keV wide; and the size of the cross section together with the profusion of photons released by each trigger event promises that a self-sustained "detonation" propagated by photons would be a

realistic objective. These results with SR triggering of ^{178}Hf isomers are reviewed in the following material.

Personnel Supported

Professional personnel participating and/ or supported in part by this grant have been:

- | | |
|---------------------|---|
| 1) Carl B. Collins | UTD Professor and Principal Investigator |
| 2) Farzin Davanloo | UTD Research Scientist |
| 3) M. C. Iosif | UTD Graduate Student |
| 4) T. Camase | UTD Graduate Student |
| 5) C. Rusu | UTD Graduate Student |
| 6) C. Zoita | UTD Graduate Student |
| 7) J. M. Hicks | UTD Undergraduate Student |
| 8) R. Dussart | Research Eng., GREMI, Univ. d' Orleans, France |
| 10) C. A. Ur | Research Scientist, HHNIP&NE Bucharest, Romania |
| 11) V. I. Kirischuk | Research Scientist, GKTCenter for Nuclear Materials Kiev, Ukraine |
| 12) P. M. Walker | Professor, Dept. of Phys., Univ. of Surrey, Surrey, UK |
| 13) J. M. Pouvesle | Research Director, GREMI, Univ. d' Orleans, France |
| 14) S. A. Karamian | Senior Scientist, JINR-Dubna, Russia |

Publications

1) "Study of the Gamma Emission from the 31-year Isomer of ^{178}Hf Induced by X-Ray Irradiation," by C.B. Collins, F. Davanloo, M.C. Iosif, J.M. Hicks, S.A. Karamian, C.A. Ur, I.I. Popescu, R. Dussart, J.M. Pouvesle, V.I. Kirischuk, H.E. Roberts, P. McDaniel, and C.E. Crist, submitted to Russian Phys. At. Nucl. **63**, 2067 (2000).

2) " γ emission from the 31-yr isomer of ^{178}Hf induced by x-ray irradiation" by C.B. Collins, F. Davanloo, A.C. Rusu, M.C. Iosif, N.C. Zoita, D.T. Camase, J.M. Hicks, S.A. Karamian, C.A. Ur, I.I. Popescu, R. Dussart, J.M. Pouvesle, V.I. Kirischuk, N.V. Strilchuk, P. McDaniel, and C.E. Crist, Phys. Rev. **C61**, 054305 (2000).

3) "Gamma-ray transitions induced in nuclear spin isomers by x-rays," by C.B. Collins, N.C. Zoita, A.C. Rusu, M.C. Iosif, D.T. Camase, F. Davanloo, J.M. Pouvesle, R. Dussart, V.I. Kirischuk, N.V. Strilchuk, C.A. Ur, I. I. Popescu, and F. J. Agee, J. Phys. IV France **11**, 437 (2001).

4) "Scaling of gamma-ray transitions induced in nuclear spin isomers by x-rays" by C.B. Collins, N.C. Zoita, A.C. Rusu, M.C. Iosif, D.T. Camase, F. Davanloo, J.M. Pouvesle, R. Dussart, V.I. Kirischuk, N.V. Strilchuk, C. A Ur, I. I. Popescu, and F.J. Agee, submitted to Laser Phys.

5) "Gamma-ray transitions induced in nuclear spin isomers by x-rays," by C. B. Collins, A.

C. Rusu, N. C. Zoita, M. C. Iosif, D. T. Camase, F. Davanloo, C. A Ur and I. I. Popescu, J. M. Pouvesle and R. Dussart, V. I. Kirischuk and N. V. Strilchuk, and F. J. Agee, *Hyperfine Interactions*, (accepted for publication, 2001).

6) "Comment on 'Search for X-Ray Induced Acceleration of the Decay of the 31-yr Isomer of ^{178}Hf Using Synchrotron Radiation'," by C.B. Collins, submitted to *Phys. Rev. Lett.* (2001).

7) "Tunable Synchrotron Radiation Used to Induce γ Emission from the 31 Year Isomer of ^{178}Hf " by C.B. Collins, N.C. Zoita, A.C. Rusu, M.C. Iosif, D.T. Camase, F. Davanloo, S. Emura, T. Uruga, R. Dussart, J.M. Pouvesle, C. A Ur, I. I. Popescu, V.I. Kirischuk, N.V. Strilchuk, and F.J. Agee, *Europhys. Lett.* (accepted for publication, 2001).

In collaboration of 13 scientists from 8 laboratories in 5 countries, we conducted the triggering of the 31-year ^{178}Hf isomer with x-rays for the purpose of triggering with remarkable ease, some of those results were published in two

- 1) *Int. J. Laser Physics*, **9**, 6 (1999). [LP]
- 2) *Phys. Rev. Lett.*, **82**, 695 (1999). [PRL]

Most noteworthy was that the integrated cross section derived from the number of fluorescent photons and the illuminating flux in the continuum was found to be very large to a degree unexpected by nuclear theorists. At such large values a sample of sufficient size might be “detonated” by a chain reaction propagated by the photons released by the initial triggering of just a few isomers. The significance of such a possibility is so great that an immediate focus and controversy developed around the confidence limits of our initial work. Those concerns have been largely answered and strong confidence limits have been established to support the triggering of ^{178}Hf isomers as originally reported.

ACCOMPLISHMENTS AND NEW FINDINGS

Objective

The primary objective for the research was to confirm the triggering of ^{178}Hf isomers by pulses of low energy x-rays to a very high degree of confidence and to use new technologies, such as tunable synchrotron radiation to investigate the details of the mechanism for triggering. That objective has been realized.

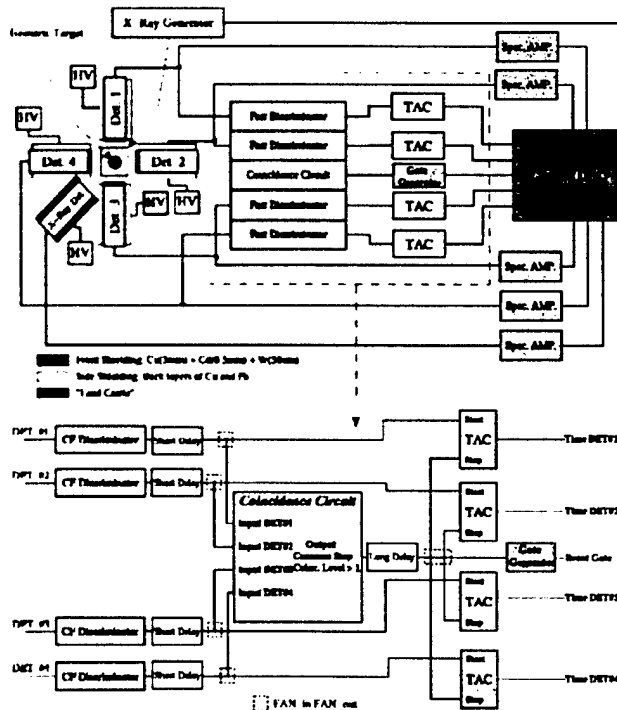

Coincidence Detection

Achievement by the Texas Group with its international affiliates accrued from a unique design [4] and implementation of the experimental system as shown in the adjacent figure. Four 10% Ge detectors were installed to support coincidence measurements of the γ photons from decay of the ^{178}Hf isomers triggered by the x-ray irradiation. Continuous A/D conversion of the signal from the spectroscopy amplifiers with virtual instrument technology eliminated “deadtime” of data acquisition. A 5th detector recorded the

spectrum of the x-ray irradiation by observing what was scattered from the isomeric target. Energies and times of detection of individual photons were recorded for each of the detectors. Operating currents and x-ray fluxes were continuously logged. The coincidence data acquisition system was proven for the collection of data "in-house," but is sufficiently versatile to be emplaced at a facility for synchrotron radiation, SR research.

Coincidence Results

The adjacent figure presents a simple overview of the challenges and strengths of the use of coincidence techniques to enhance data analysis. Pairs of photons detected by any 2 of the 4

detectors define a coincidence event. If they arrive within a selected period, usually set to be 10 ns, the energies of each photon of the pair are used as the (x, y) coordinates in a 2D histogram. In effect, a "count" is recorded in a 2-dimensional map such as shown on the figure. As counts build significant totals at some of the map coordinates, the greater totals are indicated by greater density. A sample map is shown for illustration. Low photon energies start in the lower left. In the horizontal direction the scale is such

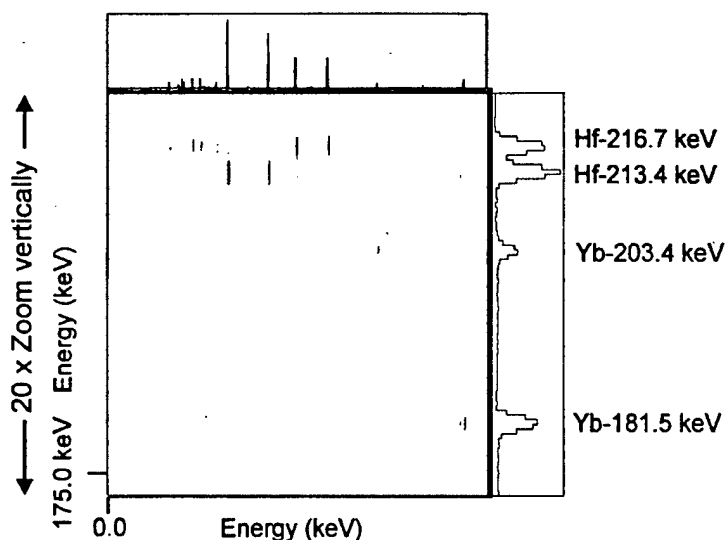

that the full range 0-1000 keV is covered. In the vertical direction the scale has been stretched so that only the approximately 40 keV around the important Hf-lines and impurity calibration lines are shown in detail. In the illustration some structures can be seen that are localized in particular rows and columns that tell the energies of each of the photons collected at the same time to within 10 ns. The merit of a good coincidence system such as seen here is that there should never be a "line" with row and column belonging to different nuclides. The principal difficulty is that such a coincidence spectrum has 4 million pixels to examine for "new" lines that might show in the data collected during irradiation that are not found in the spontaneous decay of the isomeric nuclei.

Once a region of interest is identified, the data can be analyzed by selecting a narrow "row" of interest in a display such as shown above. On the following page is shown such an example. In the upper right panel is shown the spectrum "sliced" out of the matrix along a row defined by the darkened line seen in the upper left panel. A "new" line at 129.5 keV which was found only during x-ray irradiation defines a coincident "row" in which is found only the 213.4 keV member of the ground state band (GSB) of the ^{178}Hf nuclide. For comparison, the lower two panels show the same comparisons for the "row" gated by the 88.8 keV (8-, 8+) band that feeds the entire GSB by subsequent cascading of transitions from the top, down, all occurring in less than 10 ns. The lower

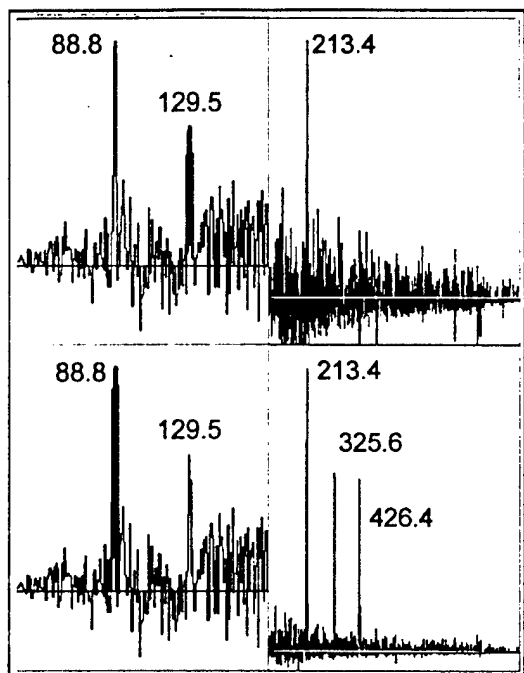

right panel enlarged from that "row" shows the entire GSB as expected. From this preliminary data, it is indicated that a new line in the decay spectrum of the ^{178}Hf isomer at 129.5 keV is excited only during the decay triggered by the x-ray irradiation and it cascades into the lower part of the GSB that subsequently cascades further only into the 213.4 keV transition. Confidence in this type of analysis is enhanced by the choice for comparison with the 129.5 keV line of a line such as 88.8 keV that is proximate in energy and comparable in detected counting rate.

These data were not corrected for detector efficiency as they were used only to locate component lines of "new" decay cascades induced by the x-ray irradiation. At these lower energies the absolute intensities were strongly affected by three factors: the front shielding that

had been designed to cut off energies below 90 keV, the slowed timing response of large Ge detectors to lower energy photons, and the settings of constant fraction thresholds. The combined effect was sharply lowered sensitivity with decreasing photon energy below 100 keV. The intensity of the 88.8 keV line was actually much greater than that of the 129.5 keV line, but the counting rates actually detected are similar as seen in the illustration..

The preliminary data available for presentation in this report represented the continuous collection of data for 30 calendar days of operation. While intended only to prove the principle, it also supported identification of a new line characteristic of the triggering of the decay of the ^{178}Hf isomer. Fortuitously, the emergence of such a strong new line provided the opportunity to perform additional tests to verify the unbiased statistics of the coincidences being detected. In the course of the direct digitization of the spectroscopy amplifiers, the arrival times of each photon at each detector is logged to a precision of 250 ps for the evaluation of possible coincidences. Thus it is possible to separate out the time and energy records for the 100 ± 20 pairs of photons contributing the apparent peak in the plots such as shown above. Shown in the adjacent figure is the distribution between the 6 possible pairs of the 4 Ge detectors of the coincident events in which a photon at 129.5 keV was detected at a time within 10 ns of that at which a 213.4 keV photon was

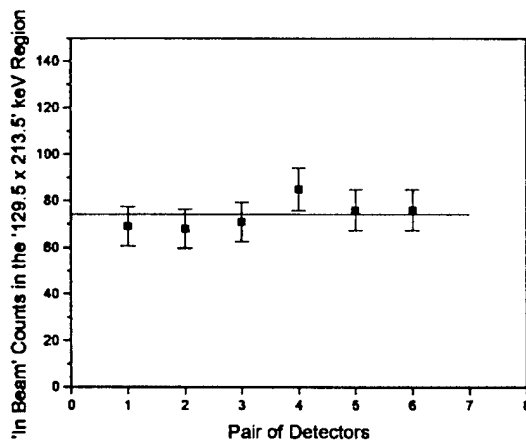

detected in another detector. The distribution is uniform to within statistical errors as must be the case if those coincidence events are not artifacts from a few of the detectors. Shown in the next figure is the histogram for the distribution of the coincident events involving both a 129.5 and a 213.4 keV photon among the possible "phase times" between the start of one pulse of irradiation and the start of the next one. Here the excess of counts collected during the period of irradiation is striking. Passing such tests based upon these histograms is a necessary condition to establish the 129.5 keV emission as a new transition induced by the irradiation.

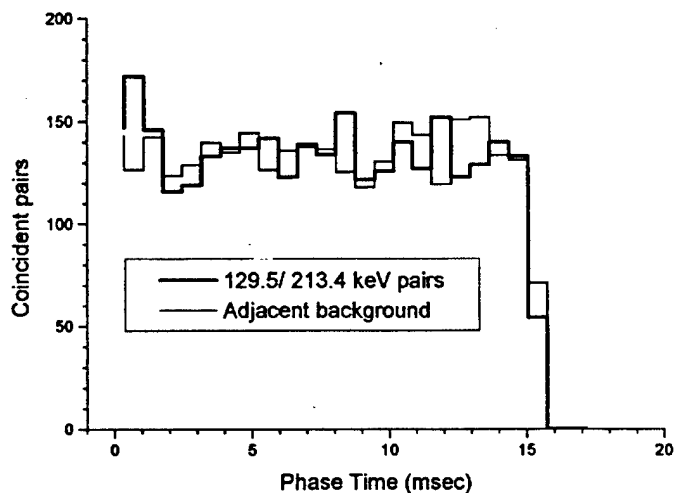

NEET - Nuclear Excitation by Energy Transfer

As often is the case in such interdisciplinary research, the explanation for an unexpected effect has rested unnoticed in the literature for almost a decade. In 1993, Ho *et al.* [6] published an adaptation from multiphoton laser spectroscopy to the non-resonant excitation of discrete excited states of nuclei. Presented with the elaborate sophistication of style peculiar to laser spectroscopy, it passed largely unnoticed in the nuclear community. Described was the transfer of excitation energy from the electrons into excitation of nuclear states. This process is interpreted schematically as follows:

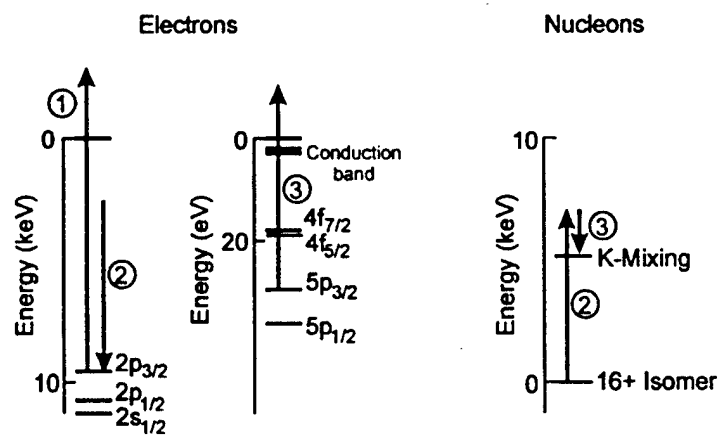

"K-Mixing."

In the left two columns are sequences of energy levels for the excited states of the electrons of Hf that surround the nuclei. Most of those states are filled with electrons. In the right most column are shown excited states of the ^{178}Hf nucleus which are important to the NEET excitation mechanism. The 31-yr isomeric state is denoted 16+ and the reference value for nuclear energy is set to zero for that state. The energy of a hypothetical excited state assumed to have a mixed value of quantum number, K is denoted

Conceptually, NEET begins with a photoionization event that creates a vacancy in one of the electron shells. In this example a vacancy in the L_3 ($2p_{3/2}$) shell is shown to result from the

photoionizing transition shown by the arrow marked "1." The vacancy is then filled by the downward transition of another electron shown schematically by the arrow marked "2." Instead of being radiated as an x-ray, the energy it releases is transferred to the excitation of a nucleon, raising the nucleus to an excited state as shown by the upward arrow marked "2." Since it is unlikely that the transition energies for electron and nucleus will precisely match, the nucleus will be "excited" to a non-stationary state for a lifetime limited by the uncertainty in time corresponding to the ΔE by which the transition fails to be resonant. If still another transition, such as indicated by the downward arrow marked "3," can occur before some other event destroys the quantum phase of the non-stationary state a final stationary (measurable) state can be reached. This can happen by coupling the "excess" energy ΔE released by the downward nuclear transition "3" to excitation of a second electron shown by the upward arrow marked "3." If the transition energy imparted to that electron is enough for it to reach a non-localized (conduction) or free state, then the probability for that channel is increased by the significantly larger degeneracy associated with free states. That is where the enhancement for the overall process arises. The larger degeneracy associated with final states being free is about the same magnitude as the internal conversion coefficient for a γ -transition which arises from the same cause.

In summary, the NEET transfer process adds transition strength because it increases the density of final states by an amount which can be as large as the internal conversion coefficient for a γ -transition of the same energy. For soft transitions this can be orders-of-magnitude and that is how conflict is avoided with "sum-rules" that might otherwise seem to limit just how large could be cross sections for triggering isomers to release their stored energies. *With transfer, the maximum value for cross section arises not from nuclear sizes, but rather from atomic sizes which are much greater. Ho [6] estimates upper limits for the NEET branch to range from 0.1% to 0.4% of the cross section for photoionization of an atomic electron.*

NEET Excitation of ^{178}Hf Isomers with Synchrotron Radiation

In 2000 Kishimoto *et al.* [7] reported unequivocal proof of the NEET process. In that work they excited the ground state of ^{197}Au with synchrotron radiation (SR). They observed the excitation and decay of the $1/2^+ \rightarrow 3/2^+$ (Mössbauer) transition of ^{197}Au at 77.351 keV by resonant absorption of SR at 80.989 keV. Although that absorption satellite for exciting the nuclear transition was not explored by tuning the SR energy to other "off-resonant" values, it was reasonably concluded that excitation through K-shell photoionization was responsible with a branching probability for NEET of $(5.0 \pm 0.6) \times 10^{-8}$.

As a vehicle for the further demonstration of NEET spectroscopy, the 16^+ state of $^{178}\text{Hf}^{m2}$ is particularly attractive. It is a 4-quasiparticle state having 2.446 MeV of excitation and a half-life of 31 years. If NEET were excited by SR there would be the possibility for exoergic emission of γ -photons with energies exceeding those of the irradiation. Then, the experimental arrangement could be facilitated by the use of layered absorbers to selectively remove x-rays scattered from the irradiation. Moreover, our previous reports of the use of x-rays with energies below 20 keV to accelerate the decay of the $^{178}\text{Hf}^{m2}$ spin isomers further encouraged planning for the use of this isomer

in a NEET experiment.

Being currently reported [5] are the first successful examples of the irradiation of $^{178}\text{Hf}^m$ isomeric nuclei with synchrotron radiation. Moreover, in this work the SR was tuned over the range of energies 9-13 keV; selected because it contains much of the transition strength for photoionization of the L-shell electrons of Hf. A branching ratio of 2×10^{-3} was found for the excitation of nuclear transitions from absorption of SR by the L-shell electrons. Those events led to the emission of exoergic γ -photons.

Two targets were used in these experiments. One was composed of two separately encapsulated samples of 5.8×10^{12} $^{178}\text{Hf}^m$ isomeric nuclei each. The other target contained three sealed samples of 1.3×10^{13} each. They were irradiated with the tunable output from a bending magnet in the BL01B1 beamline at the synchrotron radiation source SPring-8 in two separate experimental series separated by weeks. Passed through a monochromator the output beam reaching the target was 2 mm x 5 mm in size and provided $(3.0 \pm 0.6) \times 10^{10}$ photons $\text{cm}^{-2} \text{s}^{-1}$ with a nominal spectral bandwidth of 0.5 eV in the first experiment. It was tuned from 9.0 to 13.0 keV in steps of about 5 eV, remaining at each energy 10 sec. The basic scan was repeated four times. Of particular importance was that the first target was optically thin to SR between 9 and 13 keV when mounted at 45° . The target constructed for the second experimental series, was designed to give higher signal rates. It was mounted in grazing incidence inclined 12° with respect to the line of the SR beam which was adjusted to have cross sectional dimensions of 1 mm x 5 mm. Tuning range intervals found to be interesting in the first experiment were reexamined with 0.5 eV steps in SR energy. Data were collected for 50 s at each x-ray energy and each scan was repeated 3 or 4 times, depending upon limitations imposed by the periodic reinjection of the synchrotron current.

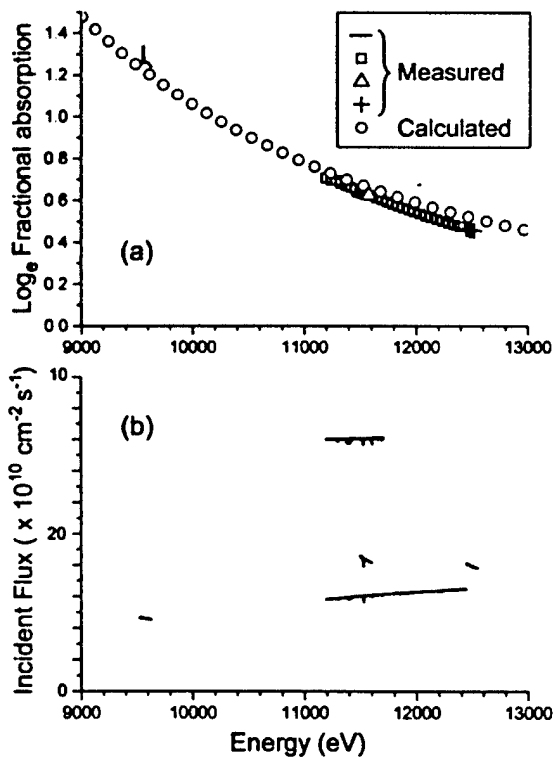

The performance of the target is of critical importance in such experiments. Spontaneous decay of the population of isomers produces energetic γ 's able to escape from millimeter thicknesses of target structure and mounting. However, if not optically thin to the SR at the x-ray energies used, the spontaneous emission from the entire target can readily "drown" any component of NEET contributed by the outer micron thickness of sample exposed to the SR. Several attempts at demonstrating NEET with isomeric targets have recently failed [8,9] for lack of optical transparency at the resonant energies for NEET and particular attention to the conditions of the target structure used in this work was warranted. In the second series of experiments the SR intensities were continuously measured in-line with ionization chambers placed before and after the isomeric target. The adjacent figure shows the SR flux (corrected for

... passage through the first ionization chamber) that was incident upon the target at several intervals of SR energy examined. Also shown is the resulting target obtained from both ionization chambers. Despite the considerable ... during the experiment, agreement can be seen between the absorption coefficients extracted for the target for the different conditions and with the attenuation calculated for the geometry and measured density of the plastic encapsulations of the samples stacked into the target.

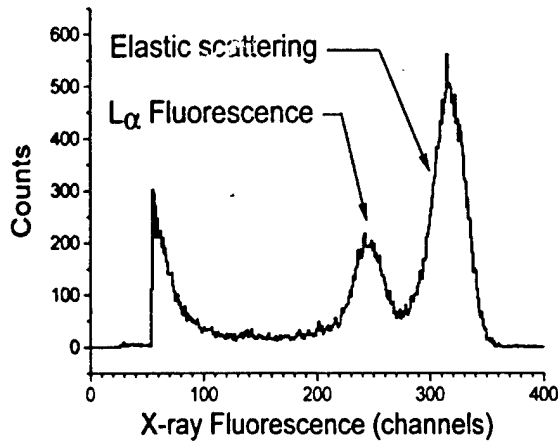

A Si drift detector (SDD) was used both to confirm the location of the target activity in the SR beam and to survey the level of scattered SR in the detector environment. As shown to the left, the level of elastic scattering was sufficiently low to facilitate gating upon photons selected to record the intensity of $L\alpha$ fluorescence from the Hf component of the target. On the right is shown the means used to locate the activity of the target in the

SR beam. The data were obtained by moving the target vertically with a stepping motor while the absorption coefficient was measured with the ionization chambers and the intensity of $L\alpha$ fluorescence from the Hf component was monitored by the SDD. The slit limiting the vertical dimension of the SR beam was narrowed to 0.1 mm during this adjustment. After the activity was located the slit was set as shown to the right. The process was repeated in the horizontal direction and showed the activity to extend 4.6 mm in that direction. The activity had the form of an elliptical annulus in each sample and the samples had been assembled into the target slightly out of register to prevent the Hf components from shadowing each other and that accounts for the morphology seen.

A Ge spectrometer 10 mm thick x 16 mm dia. was placed 25mm from the target at right angles to the beam and was shielded with layered foils of Cu, Cd, and W. It was connected to a

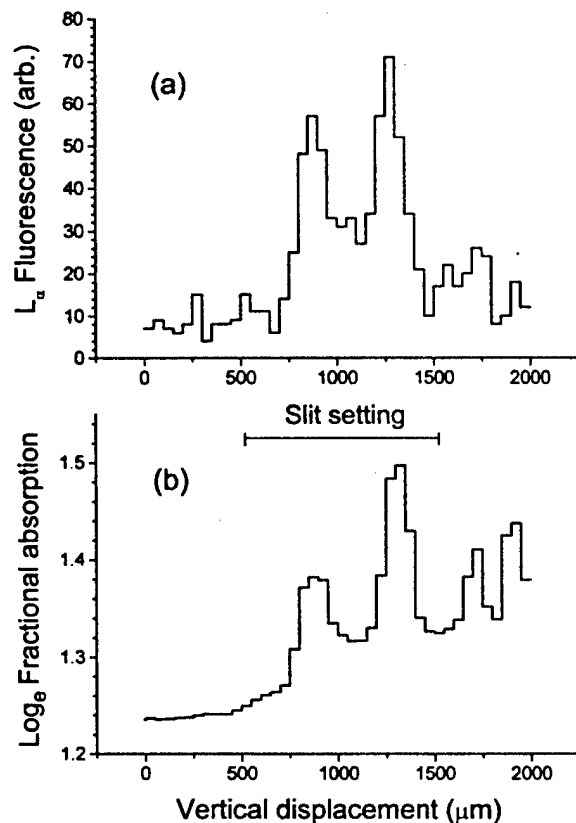

EG&G 673 spectroscopy amplifier from which the output was continuously digitized and recorded to permit subsequent reexamination of the electrical pulses describing the detected photons as described above. The spectrum of the target was composed of only the well-known decays of $^{178}\text{Hf}^{\text{m}2}$ and of the ^{172}Hf impurity and its daughters. Of the former, only the (4,2), (6,4), and (8,6) members of the ground state band, GSB at 213.4, 325.6, and 426.4 keV, respectively, and the lowest member of the 8- band at 216.7 keV were recorded at significant counting rates because of declining efficiency of the Ge-detector for higher energy γ 's. Of the lines from the impurities, only the two, 125.8 and 181.5 keV could be recorded with significance. Data were analyzed with a mesh of 8.8 γ channels per keV. When the monochromator changed energies, a digital signal was sent to a second channel of the data logging system to correlate the signals from γ -photons with the energies of the irradiation. Regions of interest (ROIs) associated with each of the spectral features were identified in the 4096 channel histograms of the numbers of γ -photons detected during each period of irradiation with SR. For simplicity, in most cases the sums for the ROIs for 213.4 and 216.7 keV were used to study the excitation functions of the $^{178}\text{Hf}^{\text{m}2}$ sample. The ROI for the 181.5 keV impurity line provided a convenient indication for the null effect.

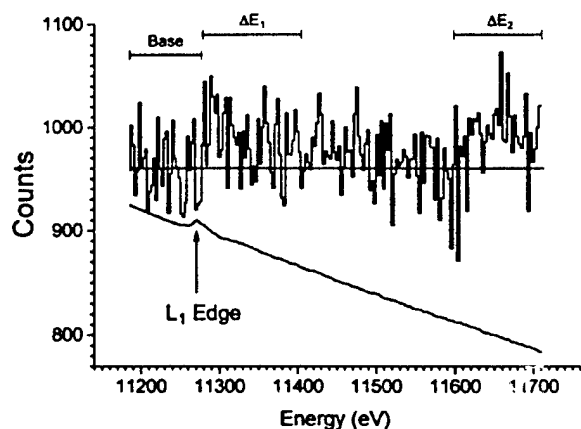

Numerical values of the counts are reported in Table I.

From the data of Table I the cross sections, σ for excitation can be readily expressed as $\sigma = fA/F$; where f is the fractional enhancement over spontaneous emission, A is the rate coefficient for spontaneous emission ($A = 7.09 \times 10^{-10} \text{ s}^{-1}$), and F is the irradiating photon flux. Values of flux were taken from the above figure and were corrected for the absorption from the encapsulation. For the 3-sample target at 12° inclination, the effective average fluxes over the activity for the SR energies shown in the adjacent figures, respectively, were

The most pronounced evidence for NEET is shown to the left. Raw data are shown in the form of counts collected in ROI(216.7) during 60 s periods of irradiation. The energy of the SR x-rays was incremented in 3 steps of 0.5 eV each during those periods. The intervals over which total counts were collected for entry into Table I are indicated. The corresponding feature at the L_3 edge for photoionization was examined in 0.5 eV steps with 50 s duration repeated 4 times. The results are shown to the right in terms of fractional increases over the average counting rates observed at the lower x-ray energies just below the L_3 edge.

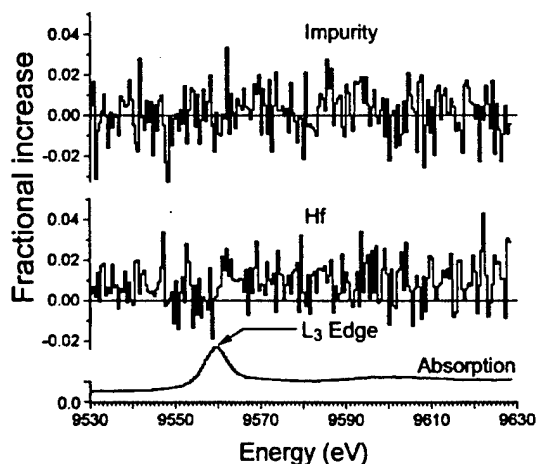

reduced from multiplication by 0.72 and 0.58. Resulting fluxes and cross sections are summarized in Table II. As seen, the confidence factors exceed 4σ for all 3 measurements reported in this work.

TABLE I. Comparison of the gamma emission from isomeric Hf nuclei and from impurities in the target. Data are presented as counts collected when irradiated with X-rays having energies in the structure studied in comparison with results when irradiated with "Baseline" energies proximate to those in the structure.

Feature	ROI	In structure Counts	Adjacent baseline		Excess (counts)
			Counts	Norm. ^a Counts	
L ₁ ΔE ₁	ROI(181)	66175 (257)	50681 (225)	66609 (296)	-434 (392)
	ROI(217)	45476 (213)	33597 (183)	44156 (241)	1320 (322) ^b
L ₁ ΔE ₂	ROI(181)	55737 (236)	50681 (225)	56473 (251)	-736 (341)
	ROI(217)	38662 (197)	33597 (183)	37437 (204)	1225 (284) ^c
L ₃	Area(126+181)	276333 (526)	112399 (374)	274753 (914)	1580 (1054)
	ROI(213+217)	433703 (659)	175385 (419)	428719 (1023)	4984 (1217) ^d

^aMultiplied by ratio of durations for counting.

^bEstimation of the effect: $3.0 \pm 0.73\%$

^cEstimation of the effect: $3.3 \pm 0.76\%$

^dEstimation of the effect: $1.2 \pm 0.28\%$

TABLE II. Integrated cross sections obtained for the three structures for excitation of the $^{178}\text{Hf}^{\text{m}2}$ isomeric population by NEET.

Feature	Eff. Photon flux ($\text{cm}^{-2}\text{s}^{-1}$)	Enhancement f	Cross section (cm^2)
L ₁ ΔE ₁	1.2×10^{11}	0.030 (0.0073)	$1.77(0.43) \times 10^{-22}$
L ₁ ΔE ₂	1.2×10^{11}	0.033 (0.076)	$1.95(0.45) \times 10^{-22}$
L ₃	2.7×10^{10}	0.012 (0.0028)	$3.15(0.74) \times 10^{-22}$

The photoionization cross section at the L₁ edge is $7.5 \times 10^{-20} \text{ cm}^2$, so these excitation bands represent about 2×10^{-3} of the photoionization probability. Though large, such a value still conforms to the upper limits for NEET of a few $\times 10^{-3}$ calculated [6] for neighboring nuclei. The work reported here appears to extend the first proof of the NEET process for nuclear excitation to the isomeric nucleus $^{178}\text{Hf}^{\text{m}2}$. Particularly notable is that in this case of isomer excitation, probabilities approach the theoretical maxima of a few $\times 10^{-3}$ for L-shell photoionization.

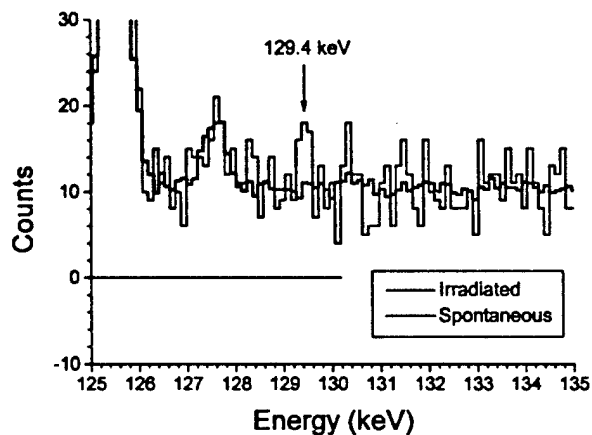

Excitation of the New Line by NEET

Further confirmation of the excitation of the new line originally found in coincidence measurements was obtained during the use of the synchrotron radiation source, SPring-8 to irradiate samples of ^{178}Hf isomers at considerably greater intensity. The adjacent figure shows the clear appearance of the "new" line in single-photon spectra [4]. The

enhancement is sufficient to determine the transition energy to be 129.4 keV in agreement with the results found in the coincidence work described above.

References

[Note: Those marked by * were published in the course of the first three years of this research for AFOSR.]

[1] E. Browne, NDS 72, 221 (1994).

[2] C. B. Collins, F. Davanloo, R. Dussart, M. C. Iosif, J. M. Hicks, S. A. Karamian, C. A. Ur, I. I. Popescu, V. I. Kirischuk, J. J. Carroll, H. E. Roberts, P. McDaniel, and C. E. Crist, Phys. Rev. Lett. 82, 695 (1999).*

[3] C. B. Collins, F. Davanloo, A. C. Rusu, M. C. Iosif, N. C. Zoita, D. T. Camase, J. M. Hicks, S. A. Karamian, C. A. Ur, I. I. Popescu, R. Dussart, J. M. Pouvesle, V. I. Kirischuk, N. V. Strilchuk, P. McDaniel, and C. E. Crist, Phys. Rev. C. 61, 054305 (2000).*

[4] C. B. Collins, A. C. Rusu, N. C. Zoita, M. C. Iosif, D. T. Camase, F. Davanloo, C. A. Ur and I. I. Popescu, J. M. Pouvesle and R. Dussart, V. I. Kirischuk and N. V. Strilchuk, and F. J. Agee, Hyperfine Interactions, (accepted for publication, 2001).*

[5] C. B. Collins, N. C. Zoita, A. C. Rusu, M. C. Iosif, D. T. Camase, and F. Davanloo, S. Emura, T. Uruga, R. Dussart, J. M. Pouvesle, C. A. Ur, and I. I. Popescu, V. I. Kirischuk, and N. V. Strilchuk, and F. J. Agee, Europhys. Lett. (accepted for publication, 2001).*

[6] Y. Ho, Z. Yuan, B. Zhang, and Z. Pan, Phys. Rev. C. 48, 2277 (1993).

[7] S. Kishimoto, Y. Yoda, M. Seto, Y. Kobayashi, S. Kitao, R. Haruki, T. Kawauchi, K. Fukutani, and T. Okano, Phys. Rev. Lett. 85, 1831 (2000).

[8] I. Ahmad, J. C. Banar, J. A. Becker, D. S. Gemmell, A. Kraemer, A. Mashayekhi, D. P. McNabb, G. G. Miller, E. F. Moore, L. N. Pangault, R. S. Rundberg, J. P. Schiffer, S. D. Shastri, T. F. Wang, and J. B. Wilhelmy, Phys. Rev. Lett. 87, 072503 (2001).

[9] C. B. Collins, Phys. Rev. Lett. (submitted, 2001); C. A. Rusu, N. C. Zoita, and F. Davanloo, Phys. Rev. Lett. (submitted, 2001).*

SIGNIFICANCE OF ACCOMPLISHMENTS

The greatest significance of the accomplishments realized with support from this Grant was

that the excitation function for triggering the $^{178}\text{Hf}^{\text{m}2}$ nuclear spin isomer was examined for the first time. Prior to this year triggering had been done only with broad-band x-ray sources which emitted a continuum of x-ray energies. This year we succeeded in triggering samples of $^{178}\text{Hf}^{\text{m}2}$ nuclear spin isomers with narrow-band, tunable x-rays obtained from the most powerful synchrotron radiation source in existence, Spring-8 in Japan. Two measurement series were made possible by the grant from the Japan Synchrotron Radiation Research Institute (JASRI) of beamtime having substantial commercial value. In the first series we tuned through the range of x-ray energies from 9000 to 13,000 eV in 5 eV steps to locate the particular energies for which triggering occurred. In the second we tuned with much higher resolution of 0.5 eV through the regions of greatest interest.

The most significant result was that we found that more than 90% of the triggering of the $^{178}\text{Hf}^{\text{m}2}$ nuclear spin isomer occurred for x-ray energies corresponding to the L-shell edges for photoionization of the electrons surrounding the nuclei. This indicated the mechanism for triggering was the NEET process predicted in 1993 by Ho, but subsequently forgotten. He predicted that a branch of the order of a few x 0.1% of the probability for photoionization was available for transferring electron excitation into nuclear excitation, but he could not predict whether it would be realized in some actual case. In 2000 with the same synchrotron, Kishimoto showed for the ground state of ^{197}Au that 0.000005% of the photoionization events branch into nuclear excitation, a very small fraction of theoretical upper limits. For nuclear spin isomers the coupling is far better and we found 0.2% probability for the branching of photoionization of Hf electrons into nuclear excitation. In this case the potential of the process was fully realized. This result with tunable synchrotron radiation confirms all previous results we obtained in earlier work.

Simply, ionizing L-shell electrons of $^{172}\text{Hf}^{\text{m}2}$ nuclear spin isomers has a 0.2% chance for triggering the release of the stored energy of the nucleus. Since there are many straightforward ways to ionize atoms, this result strongly encourages most application strategies.

Appendix 1

Reprint of the Manuscripts

**“Comment on ‘Search for X-Ray Induced Acceleration of the Decay of the 31-yr Isomer of ^{178}Hf Using Synchrotron Radiation’,”
by C.B. Collins**

Submitted to Phys. Rev. Lett.

**“Comment on ‘Search for X-Ray Induced Acceleration of the Decay of the 31-yr Isomer of ^{178}Hf Using Synchrotron Radiation’,”
by A. C. Rusu, N. C. Zoita, and F. Davanloo,**

Submitted to Phys. Rev. Lett.

"Search for X-Ray Induced Acceleration of the 31-yr Isomer of ^{178}Hf Using Synchrotron Radiation"

C. B. Collins

Center for Quantum Electronics, Univ. of Texas at Dallas, P.O. Box 830688, Richardson, TX,
75083-0688

(August 15, 2001)

In a recent Letter [1] Ahmad *et al.* reported an attempt to accelerate the decay of the 31-yr isomer of ^{178}Hf by exposing a sample to the "white" beam of x-rays from a tapered undulator insertion device at the SRI-CAT 1-1D beamline of the Advanced Photon Source (APS) at Argonne National Laboratory. Such an acceleration of the decay of that isomer as the result of exposure to Bremsstrahlung continuum had been previously detailed [2].

Utilizing 60 h of beam time, a target containing approximately one order-of-magnitude more ^{178}Hf isomeric population, and about 4 orders-of-magnitude greater spectral flux density of x-rays than used in any preceding work; the experiment of Ahmad *et al.* [1] failed to produce any acceleration of the spontaneous rate of decay. They concluded that all previous work had been in error by 5 orders-of-magnitude.

The analysis of Ahmad *et al.* [1] was based entirely upon computations of the complex irradiation environment and upon estimations of the target parameters. No fiducial measurements of flux were made in even the most critical energy range below 20 keV [2] where the spectral flux density was computed to vary with a gradient of an order-of-magnitude per keV.

The activity in the target had been chemically extracted from a beamstop with an original concentration of about 10^{-9} , but no assay of the resulting yield was presented nor were any measurements made of potential contaminations of the final activity by heavy metals. The collateral burden of ground state Hf had to be about 10^4 times the activity and that alone must have caused attenuation within the 1.6 mm thick target of over 9 orders-of-magnitude,

although this was not anticipated even in the computation. The purpose of the Comment is to present evidence for a conclusion alternative to that published by Ahmad *et al.* [1].

Recently, another sample ^{178}Hf isomeric nuclei was exposed for a total of 120 h to the tunable beam of x-rays from a bending magnet inserted in the BL01B1 beamline of the SPring-8 synchrotron radiation, SR source [3]. X-ray energies were tuned through the range 9 to 13 keV with 0.5 eV resolution and interesting regions were reexamined in a confirming experiment conducted weeks later. All fluxes and target parameters, such as absorption coefficient, were continuously measured with ionization chambers placed along the beam line, before and after the target. Nothing was calculated and all measured values were traceable to standards. Typical performance is shown in Fig. 1.

Excitation of the isomeric nuclei by transfer of energy from the surrounding electrons, NEET, [4] was observed to lead to the exoergic emission of characteristic γ -rays of ^{178}Hf . Integrated cross sections were extracted from the data with the expressions of Ahmad *et al.* [1], in this case using only measured values. Results for cross sections integrated over only two intervals of 50 and 400 eV, respectively are shown in Fig. 2, together with "upper limits" proffered by Ahmad *et al.* [1]. The "upper limits" appear at least five orders-of-magnitude too low and vitiate arguments based upon those limits that all previous measurements were in error.

REFERENCES

- [1] I. Ahmad *et al.*, Phys. Rev. Lett. **87**, 072503 (2001).
- [2] C. B. Collins *et al.*, Phys. Rev. C. **61**, 054305 (2000).
- [3] C. B. Collins, N. C. Zoita, A. C. Rusu, M. C. Iosif, D. T. Camase, F. Davanloo, S. Emura, T. Uruga, R. Dussart, J. M. Pouvesle, C. A. Ur, I. I. Popescu, V. I. Kirischuk, N. V. Strilchuk, F.J. Agee, (Manuscript, 2001).
- [4] S. Kishimoto, Y. Yoda, M. Seto, Y. Kobayashi, S. Kitao, R. Haruki, T. Kawauchi, K. Fukutani, and T. Okano, Phys. Rev. Lett. **85**, 1831 (2000).

FIGURE CAPTIONS

Fig. 1- Irradiation environment. (a) Absorption coefficient of the SPring-8 target measured in-line as a function of SR energy during different irradiations. (b) Measured values of SR flux.

Fig. 2- Upper limits on integrated cross sections for 2 undulator settings reported in Ref. 1, together with SPring-8 results identified by the nominal spectral feature over which cross sections were integrated.

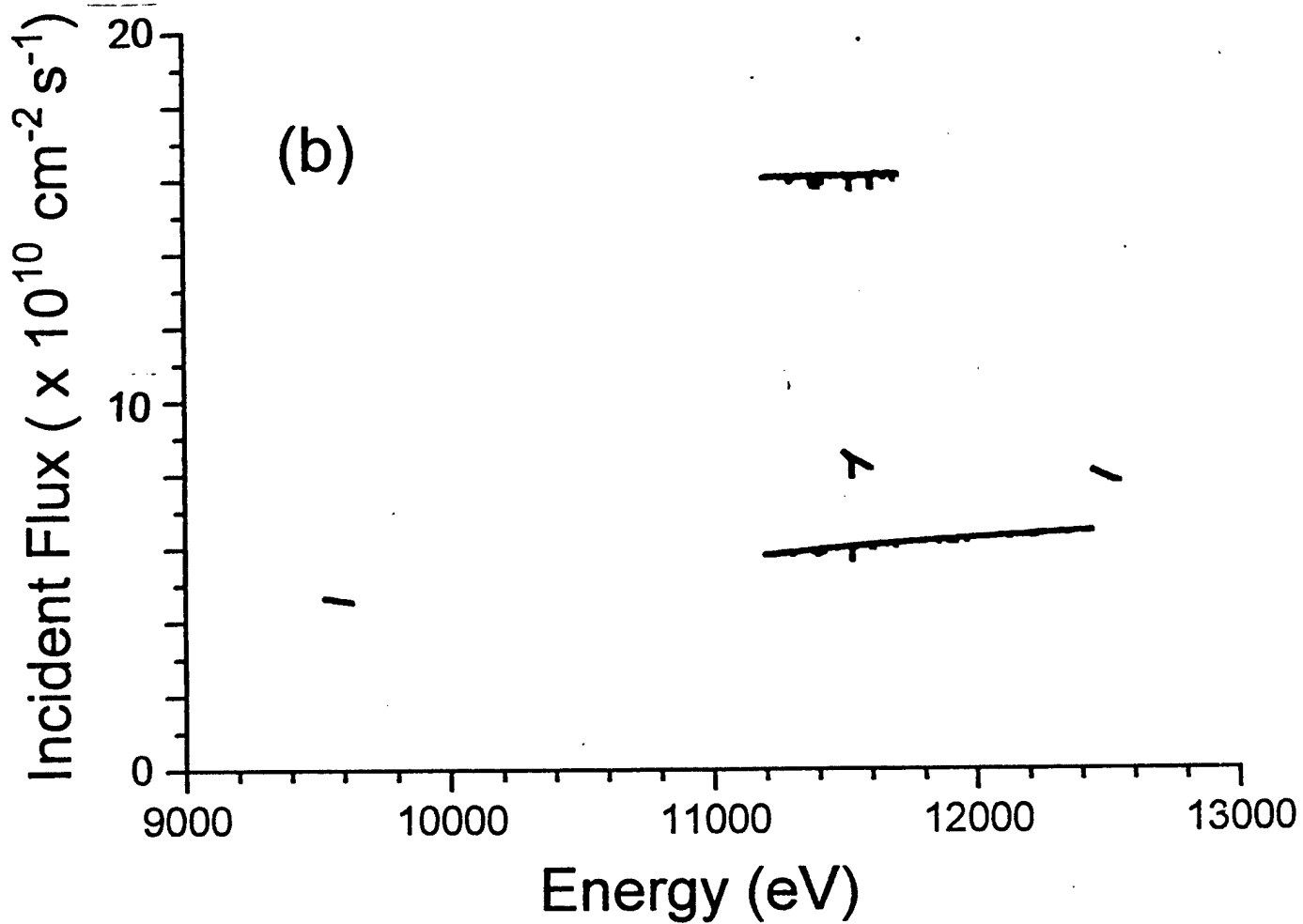
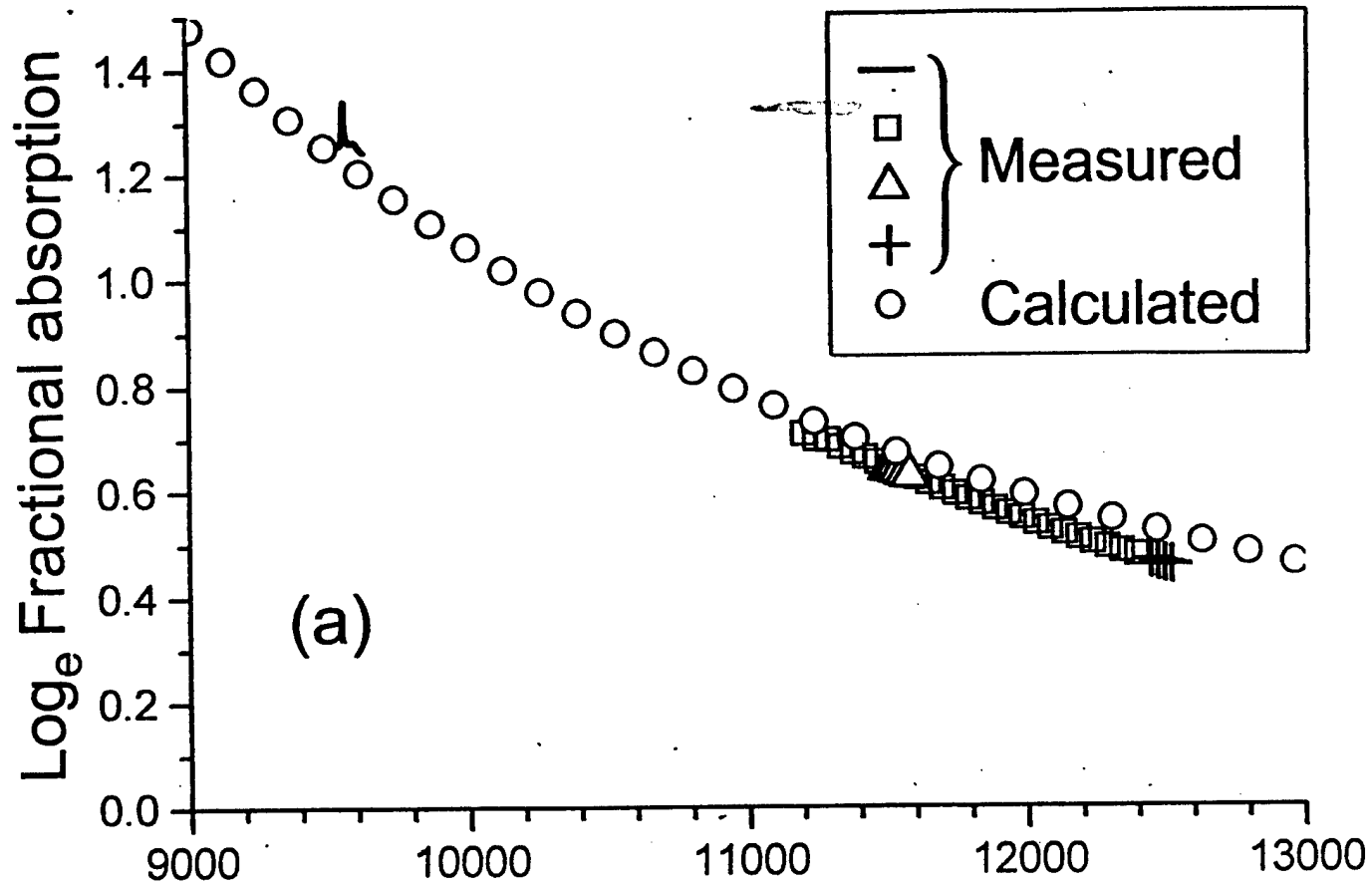

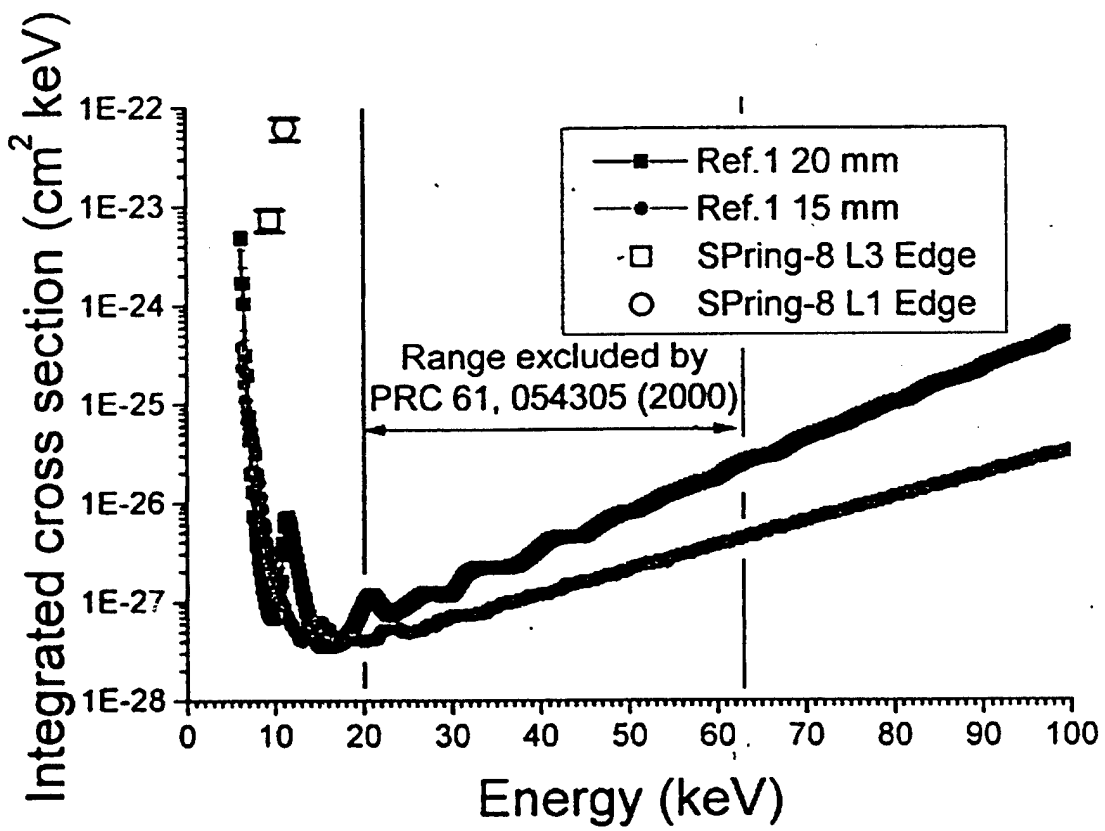

Comment on "Search for X-Ray Induced Acceleration of the Decay of the 31-yr Isomer of ^{178}Hf Using Synchrotron Radiation"

Recently, Ahmad *et al.* [1] described their unsuccessful attempt to stimulate the decay of the 31-yr isomer of ^{178}Hf . They were trying to reproduce what previously was reported [2] in this field. Thick targets (1.6 mm thickness), containing 10^{15} isomeric nuclei, were exposed to a "white" X-ray beam at the SRI-CAT 1-ID beam line of the Advanced Photon Source (APS) at Argonne National Laboratory. No evidence for an X-ray induced acceleration of the decay was observed; and so the energy-integrated cross section for the process was supposed to be more than 5-orders of magnitude below values previously reported [2]. The authors presented no estimates

of error or uncertainty in their work. The purpose of this Comment is to estimate the errors of Ahmad *et al.* [1]. Our calculations are based on the SHADOW code [3] used also at APS [4]. The input data were the parameters reported by [1] and specified by APS technical notes [4]. The integrated flux spectrum without tapering is presented in Fig. 1a, for the case of a 20 mm gap ($K = 0.965$) and a 2.3×10^{-9} sr pinhole aperture corresponding to the target surface located at 37 m from the undulator. The flux broadened by tapering (Fig. 1b) had to be corrected for about 7 m air absorption, according to description of the 1-ID beam line.

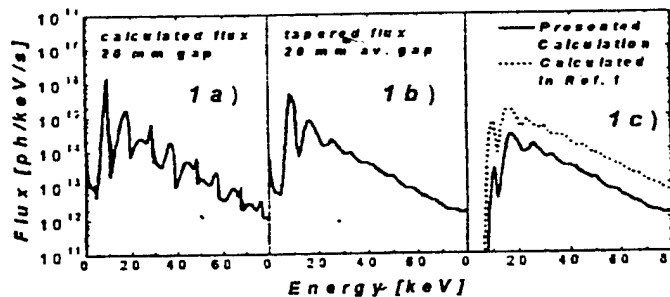

One can immediately see in Fig. 1c that the resulting shape of the flux incident upon the target is similar with that calculated in [1], but is one order of magnitude smaller. Moreover, in [1] there was no discussion of the real sample composition even though self-absorption in the target could be very strongly dominated by residual heavy metals carrying the chemically separated activity. Without this critical data, we could use only the photon absorption of the Al additive. The expression (2) from [1] was corrected for low energy photon absorption ($\sigma = d \rho \mu_e A / \tau / \phi$) and the resulting sensitivity at 8 keV is 2×10^{-23} cm²keV instead of 5×10^{-26} cm²keV (the latter value having been presented in [1] as the sensitivity of measurement for the same energy). There is a three order of magnitude difference in that case.

In summary, probable errors in the work of Ahmad *et al.* [1] of at least three orders of magnitude arise from values of the incident flux and absorption in the target from just the Al binder. Additional orders can be reasonably expected from absorption caused by residual heavy metals associated with the activity. Such elemental composition and homogeneity of targets are critical especially for low energy photon interactions since a strong absorption on "thick" targets completely compromises such an experiment. Moreover, the fact that the use of well-established modelling techniques produces results so

different from those of Ahmad *et al.* [1] raises some real questions about the exclusive use of modelling tools for quantitative analyses without also using experimental techniques for renormalizing, or at least for checking the final results for systematic errors and/or some over-simplicity of the models. To be significant, the experiment [1] needs to be repeated with careful absolute measurements of the photon flux and use of a target optimized for transparency below 20 keV.

C. A. Rusu, N. C. Zoita, and F. Davanloo
Center for Quantum Electronics, Univ. of Texas
at Dallas,
P.O. Box 830688, Richardson, TX, 75083-0688

-
- [1] I. Ahmad *et al.*, Phys. Rev. Lett. **87**, 072503 (2001).
 - [2] C. B. Collins *et al.*, Phys. Rev. Lett. **82**, 695 (1999);
C. B. Collins *et al.*, Phys. Rev. C. **61**, 054305 (2000).
 - [3] B. Lai *et al.*, Nucl. Instr. and Meth. A246, 337 (1986);
B. Lai *et al.*, Nucl. Instr. and Meth. A266, 544 (1988).
 - [4] S. L. Xu *et al.*, Argonne National Laboratory Report ANL/APS/TB-1; B. Lai *et al.*, ANL/APS/TB-3; B. Lai *et al.*, ANL/APS/TB-17;