



NAVAL FACILITIES ENGINEERING SERVICE CENTER
Port Hueneme, California 93043-4370

TECHNICAL REPORT
TR-2189-ENV

NATURAL PRESSURE PASSIVE BIOVENTING
FINAL REPORT

by

Naval Facilities Engineering Service Center

Sherrie Larson
Jed Costanza
Ron Hoeppe

And

Parson's Engineering Science, Inc

April 2001

20020415 026

Approved for public release; distribution is unlimited.

REPORT DOCUMENTATION PAGE			Form Approved OMB No. 0704-0188
Public reporting burden for this collection of information is estimated to average 1 hour per response, including the time for reviewing instructions, searching existing data sources, gathering and maintaining the data needed, and completing and reviewing the collection of information. Send comments regarding this burden estimate or any other aspect of this collection of information, including suggestions for reducing this burden to: Washington Headquarters Services, Directorate for Information Operations and Reports, 1215 Jefferson Davis Highway, Suite 1204, Arlington, VA 22202-4302, and to the Office of Management and Budget, Paperwork Reduction Project (0704-0188), Washington, DC 20503.			
1. AGENCY USE ONLY (Leave blank)	2. REPORT DATE April 2001	3. REPORT TYPE AND DATES COVERED Final Report	
4. TITLE AND SUBTITLE NATURAL PRESSURE DRIVEN PASSIVE BIOVENTING		5. FUNDING NUMBERS	
6. AUTHOR(S) Sherrie Larson, Jed Costanza, Ron Hoepfel, and Michael Phelps			
7. PERFORMING ORGANIZATION NAME(S) AND ADDRESS(ES) Commanding Officer Naval Facilities Engineering Service Center 1100 23 rd Ave Port Huene, CA 93043-4370		8. PERFORMING ORGANIZATION REPORT NUMBER TR-2189-ENV	
9. SPONSORING/MONITORING AGENCY NAME(S) AND ADDRESS(ES) Environmental Security Technology Certification Program Office 901 North Stuart Street, Suite 303 Arlington, VA 22203		10. SPONSORING/MONITORING AGENCY	
11. SUPPLEMENTARY NOTES			
12a. DISTRIBUTION/AVAILABILITY STATEMENT Approved for public release; distribution is unlimited.			12b. DISTRIBUTION CODE
13. ABSTRACT (Maximum 200 words) This Natural Pressure Driven Passive Bioventing Final Report describes the technical approach to evaluating the performance of passive bioventing at Castle Airport (formally Castle Air Force Base) in Merced, California. The Environmental Technology Certification Program (ESTCP) sponsors the project. The purpose of the project was to demonstrate that passive bioventing can be employed to remediate soil contamination without the use of electric blowers. Passive bioventing is an effective, low-cost remedial technology for soils containing contaminants amenable to aerobic biodegradation (e.g. petroleum hydrocarbons). It provides the means to deliver oxygen to the subsurface and facilitates aerobic degradation of the contaminant. This report describes the objectives, regulatory issues, previous testing of the technology, system design, cost and performance and lessons learned while performing the demonstration/validation.			
14. SUBJECT TERMS Passive bioventing, remediation, ESTCP, aerobic biodegradation			15. NUMBER OF PAGES 96
			16. PRICE CODE
17. SECURITY CLASSIFICATION OF REPORT U	18. SECURITY CLASSIFICATION OF THIS PAGE U	19. SECURITY CLASSIFICATION OF ABSTRACT U	20. LIMITATION OF ABSTRACT U
NSN 7540-01-280-5500		Standard Form 298 (Rev. 2-89) Prescribed by ANSI Std Z39-18 298-102	

EXECUTIVE SUMMARY

This Natural Pressure Driven Passive Bioventing Final Report describes the technical approach to evaluating the performance of passive bioventing at Castle Airport (formally Castle Air Force Base) in Merced, California. The Environmental Technology Certification Program (ESTCP) sponsors the project. The purpose of the project was to demonstrate that passive bioventing can be employed to remediate soil contamination without the use of electric blowers. Passive bioventing is an effective, low-cost remedial technology for soils containing contaminants amenable to aerobic biodegradation (e.g., petroleum hydrocarbons). It provides the means to deliver oxygen to the subsurface and facilitates aerobic degradation of the contaminant. This report describes the objectives, regulatory issues, previous testing of the technology, system design, cost and performance and lessons learned while performing the demonstration/validation.

TABLE OF CONTENTS

	<u>Page</u>
1. INTRODUCTION	
1.1 Background Information	1
1.2 Official DoD Requirement Statement(s).....	1
1.2.1 How Requirement(s) Were Addressed.....	2
1.3 Objectives of the Demonstration.....	2
1.4 Regulatory Issues	3
1.5 Previous Testing of the Technology.....	3
2. TECHNOLOGY DESCRIPTION	
2.1 Description	6
2.1.1 Introduction	6
2.1.2 Passive Approaches to Bioventing.....	7
2.1.3 Passive Bioventing Design.....	7
2.1.4 Key Design Criteria.....	10
2.1.5 Performance Objectives	10
2.2 Strengths, Advantages, Weaknesses	10
2.2.1 Strengths, Advantages, and Weaknesses of Conventional Bioventing Over Other Technologies	10
2.2.2 Advantages of Passive Bioventing Over conventional Bioventing	12
2.2.3 Weaknesses of Passive Bioventing Compared to Conventional Bioventing	12
2.3 Factors Influencing Cost and Performance	13
3. SITE/FACILITY DESCRIPTION	
3.1 Background	15
3.2 Site/Facility Characteristics.....	16
3.2.1 Climate	16
3.2.2 Geology and Hydrogeology	17
3.2.3 Nature and Extent of Contamination.....	17
3.2.4 Soil Grain-Size Analysis	23
3.2.5 Soil Moisture and pH	23
3.2.6 Air Permeability Testing	24
3.2.7 <i>In Situ</i> Respiration Testing.....	24
3.2.8 Barometric Pressure, Air Flow, and Differential Pressure.....	24

TABLE OF CONTENTS (continued)

	<u>Page</u>
4. DEMONSTRATION APPROACH	
4.1 Performance Objectives	25
4.2 Physical Setup and Operation	25
4.2.1 Vent Well Construction.....	25
4.2.2 Buried Oxygen Sensors/Vapor Monitoring Points.....	26
4.2.3 Borehole Vertically Survey	26
4.2.4 Pressure Transducers, Air Flow Transducers, and Temperature	29
4.2.5 One-Way, Passive Valve Construction	29
4.2.6 Data Acquisition System.....	29
4.2.7 Testing and Operation	30
4.3 Sampling Procedures.....	30
4.4 Analytical Procedures	31
5. PERFORMANCE ASSESSMENT	
5.1 Performance Data.....	32
5.1.1 Soil and Soil Vapor Contaminant Concentrations	32
5.1.2 Soil Moisture and pH	32
5.1.3 Soil Nutrients	32
5.1.4 Alkalinity.....	32
5.1.5 Oxidation Reduction Potential and Microbially Reducible Iron.....	32
5.1.6 Barometric Pressure, Air Flow, Subsurface Differential Pressure Subsurface Oxygen Concentrations, Ambient Air Temperature, and Groundwater Elevation	33
5.2 Data Assessment	33
5.2.1 Test 1	33
5.2.2 Test 2	35
5.2.3 Test 3	38
5.2.4 Test 4	38
5.2.5 Test 5 and 6	43
5.2.6 Performance Objectives and Technology	46
5.3 Technology Comparison	48
6. COST ASSESSMENT	
6.1 Cost Performance	50
6.2 Cost Performance to Conventional and Other Technologies.....	51

TABLE OF CONTENTS (continued)

	<u>Page</u>
7. REGULATORY ISSUES	
7.1 Approach to Regulatory Compliance and Acceptance	55
8. TECHNOLOGY IMPLEMENTATION	
8.1 DoD Need.....	56
8.2 Transition	56
9. LESSONS LEARNED.....	58
10. REFERENCES.....	59
APPENDIX A	Points of Contact
APPENDIX B	Data Archiving and Demonstration Plans
APPENDIX C	Boring Logs, Well Construction Details, Cone Penetrometer Logs, and Borehole Vertically Survey
APPENDIX D	Electronic Data Summary
APPENDIX E	Photo Documentation
APPENDIX F	Equipment Details and Specifications
APPENDIX G	Cost Estimates
APPENDIX H	Sample Calculation for Radius of Influence Estimate

LIST OF FIGURES

<u>No.</u>	<u>Title</u>	<u>Page</u>
1	Facility Map	4
2	Site Location Map	5
3	Passive Bioventing Process	8
4	One-Way Passive Valve	9
5	Plan View of Bioventing Well Placement (Typical)	11
6	Site Plan	18
7	Geologic Cross-Section	19
8	Vent Well Construction and Air Flow Transducer Placement	27
9	Buried Oxygen Sensor Detail (Typical)	28
10	Subsurface Pressure Response During Test 1	34
11	Air Flow vs. Barometric Pressure During Test 2	36
12	Oxygen Response at 30 Feet bgs During Test 2	37
13	Oxygen Response at 30 Feet bgs During Test 3	39
14	Air Flow vs. Barometric Pressure During Test 4	40
15	Daily Air Flow Rates During Test 4	41
16	Oxygen Response at 30 Feet bgs During Test 4	42
17	Air Flow vs. Barometric Pressure During Test 6	44
18	Oxygen Response at 30 Feet bgs During Test 6	45
19	Air Flow vs. Subsurface Differential Pressure During Test 4	49

LIST OF TABLES

<u>No.</u>	<u>Title</u>	<u>Page</u>
1	Selection Criteria.....	16
2	Soil Sampling Results – Organics & Moisture Content.....	20
3	Soil Sampling Results – Inorganics & Physical Properties.....	21
4	Soil Vapor Sampling Results	22
5	Test Configurations and Dates	30
6	Comparison of Measured vs. Predicted Radius of Influence	47
7	Cost Comparison, Passive Bioventing vs. Conventional Bioventing	52

ABBREVIATIONS AND ACRONYMS

AFB	Air Force Base
AFBCA	Air Force Base Conversion Agency
AFCEE	Air Force Center for Environmental Excellence
ARTT	Alternative Restoration Technology Team
AST	aboveground storage tank
bgs	below ground surface
BOS	buried oxygen sensor
BVCE	Bioventing Cost Estimator
cf	cubic feet
cf/d	cubic feet per day
cfm	cubic feet per minute
CPT	cone-penetrometer test
DoD	Department of Defense
DOE	Department of Energy
DTSC	State of California Department of Toxic Substances Control
ESOH	Environmental Safety and Occupational Health
°F	Fahrenheit
ft	feet
ft ²	square feet
"H ₂ O	inches of water
HSA	hollow-stem augering
ID	inside diameter
IDW	Investigation Derived Waste
IRP	Installation Restoration Program
ISR	<i>in situ</i> respiration
mg/kg	milligrams per kilogram
MCGACC	Marine Corps Air Ground Combat Center
MW	monitoring well
NAPL	Nonaqueous phase liquid
NFESC	Naval Facilities Engineering Service Center
O&M	Operations and Maintenance
O ₂	oxygen
ORD	Office of Research and Development
ORP	Oxidation Reduction Potential
PFFA	Petroleum, Oils, and Lubricants (POL) Fuel Farm Area
POL	Petroleum, Oils, and Lubricants
ppmv	parts per million by volume
PVC	polyvinyl chloride
RAB	residential advisory board
R _i	radius of influence
RPM	Remedial Project Manager

ABBREVIATIONS AND ACRONYMS (continued)

RWQCB	State of California Regional Water Quality Control Board
SAP	Sampling and Analysis Plan
SIC	standard industrial classification
TDP	Technology Demonstration Plan
TKN	total Kjeldahl nitrogen
TPH-g	total petroleum hydrocarbons as gasoline
TPH-Jet A	TPH as jet propulsion fuel A
TPH-JP4	TPH as jet propulsion fuel #4
TVH	total volatile hydrocarbons
USEPA	United States Environmental Protection Agency
UST	underground storage tank
VMP	vapor monitoring point
VW	vent well
WBS	work breakdown structure



Natural Pressure-Driven Passive Bioventing

Naval Facilities Engineering Service Center

September 2000

1. Introduction

1.1 Background Information

The environmental problem being addressed by this technology demonstration of passive bioventing is contaminated vadose-zone soils. This technology addresses contaminants that are aerobically biodegradable, such as petroleum-hydrocarbons and many lesser-chlorinated hydrocarbons. Natural pressure-driven passive bioventing is not a new technology for addressing this environmental problem, but rather a new approach to conventional bioventing. Conventional bioventing is a proven, cost-effective remedial technology which has been applied at numerous Department of Defense (DoD) installations in the United States and worldwide.

Conventional bioventing requires at least one blower to either inject or extract air. However, it has been observed at several sites that natural movement of gases into and out of the vadose zone due to barometric pressure fluctuations can also provide soil aeration for aerobic biodegradation. To date, field demonstrations of passive bioventing techniques have been very limited in number and scope and thus this approach is not yet considered validated or definitively demonstrated.

The benefits of a passive approach are that the system would have a significantly simpler design and could be used at remote sites where power is either unavailable or cost-prohibitive to install. Alternatively, passive approaches could be used as a long-term remedial measure after more intensive, short-term remedial measures. Compared to conventional bioventing systems, passive bioventing systems would have lower power consumption, reduced operations and maintenance (O&M) requirements, less facility disruption, and increased reliability.

1.2 Official DoD Requirement Statements

This technology demonstration addressed the following DoD requirements:

- Navy requirement number 1.I.1.m - Improved Remediation of Soils Contaminated with Non-Chlorinated Hydrocarbons
- Air Force requirement ESOH (Environmental Safety and Occupational Health) Need #243 - Site Remediation, Hazardous Waste Treatment Technologies for Installation Restoration Program (IRP) Site Remediation of Hydrocarbon Compounds in Soil

1.2.1 How Requirements Were Addressed. These requirements were addressed through the field demonstration of passive bioventing as a potential cost-effective improvement to conventional bioventing. The demonstration was conducted at a site with petroleum-hydrocarbon contamination in soils, where conventional bioventing tests also were being conducted. Technical effectiveness was evaluated through real-time monitoring and a series of controlled tests. Oxygen increases in soil vapor was used as an indicator of treatment effectiveness for bioremediation of the site contaminants. Cost information was gathered during the field demonstration to compare passive bioventing cost performance against conventional bioventing costs and other competing technologies.

1.3 Objectives of the Demonstration

The primary objective of this demonstration was to determine the applicability of passive bioventing techniques to a wider variety of site conditions than previously studied.

The specific objectives of this demonstration were:

- 1) Evaluate a passive approach to bioventing using air flow driven by changes in barometric pressure (no electricity or blower needed) under different site conditions than studied to date;
- 2) Measure achievable air flow rates, radii of influence, and treatment areas under different system configurations;
- 3) Compare the remedial effectiveness and cost-effectiveness of passive bioventing to conventional bioventing; and,
- 4) Gather data in support of a design document to support technology implementation at future sites.

The scope of this demonstration needed to satisfy the above objectives was:

- 1) Conduct a field demonstration of passive bioventing at a site with characteristics conducive to passive bioventing, but which had not been studied to date (*i.e.*, lithologically stratified with shallow groundwater);
- 2) Collect data to aid in the evaluation of how site variables (*e.g.*, barometric pressure, soil moisture, stratigraphy, and well configuration and depth) affect air flow rates, oxygen concentrations in the subsurface, radius of influence, and treatment area;

- 3) Develop a technical report which contains the results from sampling and testing activities and comparative technical performance and cost performance analyses between conventional bioventing and passive bioventing; and,
- 4) Develop a user data package that incorporates all of the above analyses and reports in order to transfer the technology.

This technical report and the previously-submitted user data package satisfy the objectives and the scope items listed above.

The location for the field demonstration detailed in this report was a site at Castle Airport (formerly Castle Air Force Base [AFB]), located in Merced County, California, approximately 5 miles northwest of the city of Merced (Figure 1). The specific site location within Castle Airport where the demonstration was conducted is the Petroleum, Oils, and Lubricants (POL) Fuel Farm Area (PFFA). The PFFA is located in the southern portion of the Main Base Sector and was the bulk fuel storage and distribution facility (Figure 2).

1.4 Regulatory Issues

The regulations which apply to the cleanup of contaminated, vadose-zone soils are generally driven by either promulgated concentration standards, which typically vary from state to state and even locally within states, or are driven by human health risk-based remediation goals for soil or groundwater. In addition, other types of laws, such as state non-degradation policies for groundwater, may drive development of remediation goals.

Regardless of the methods used in the determination of remedial goals, bioventing has been successfully used to meet these remedial goals and achieve site closure as defined by regulatory agencies. As of October 1994, regulatory acceptance of bioventing had been obtained in all 10 USEPA regions and in 30 states (USEPA, 1999). Passive approaches to bioventing have the potential to be equally accepted.

The effectiveness of the technology can be demonstrated to the regulatory agencies through periodic monitoring. This monitoring would include periodic respiration testing; periodic soil vapor sampling to determine oxygen, carbon dioxide, and contaminant concentrations; and, when monitoring data indicates it is appropriate, confirmatory soil sampling to achieve site closure. The use of the passive valve (Section 2.1.3) to minimize exhalation of contaminated soil vapor would help address potential atmospheric emissions and minimize the need for air emissions permits.

Other regulatory issues such as local regulatory agency concurrence with work plans, digging permits, well installation permits, and disposal of investigation-derived waste (IDW) also typically apply to this remedial technology.

1.5 Previous Testing of the Technology

Passive bioventing using barometric changes has been engineered at two DoD sites and one Department of Energy (DOE) site in the United States. At the Twentynine Palms Marine Corps

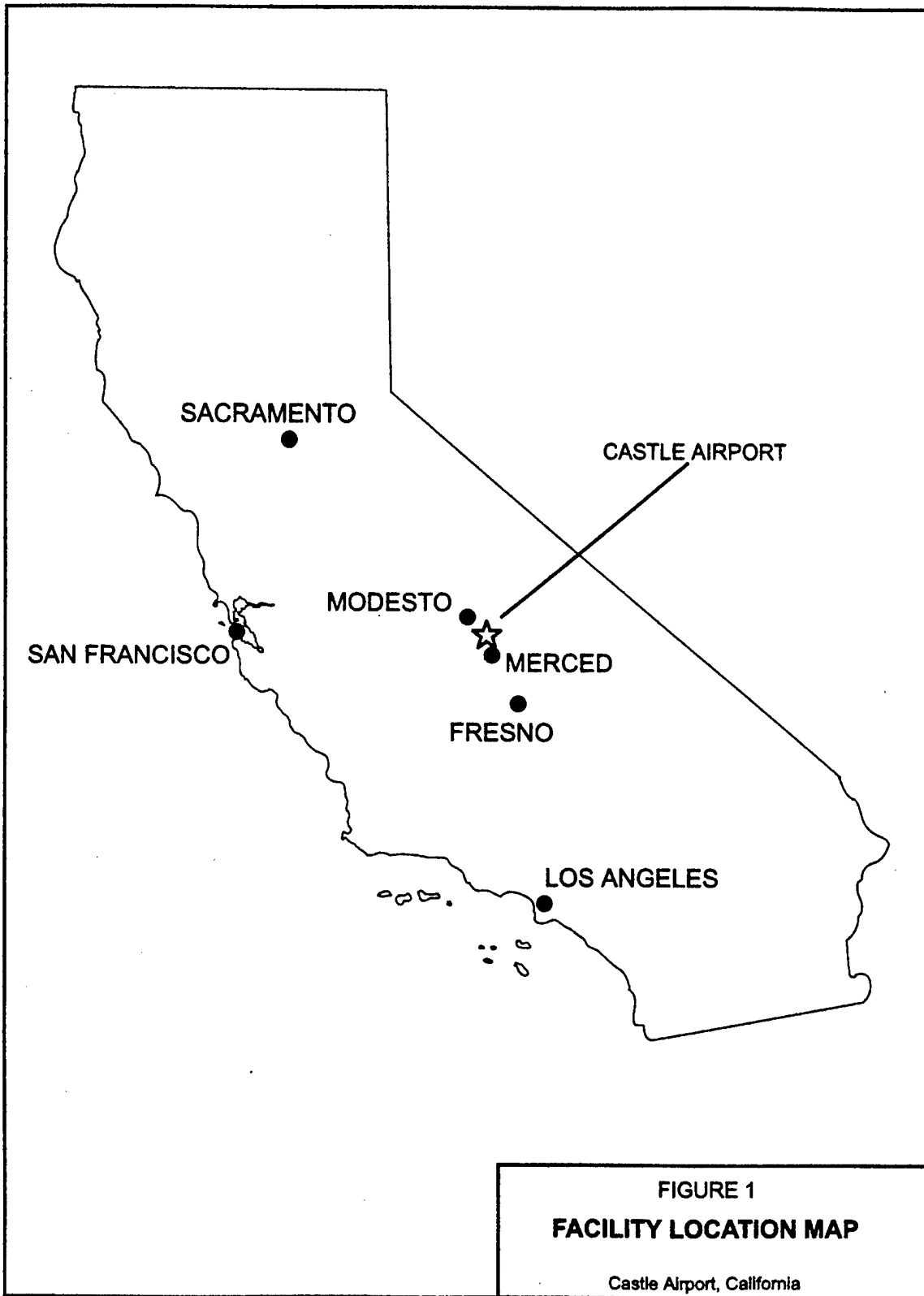

V731272\REPORT\FINAL\GRAPHICS\FIGS_P8.CDR 9/29/00

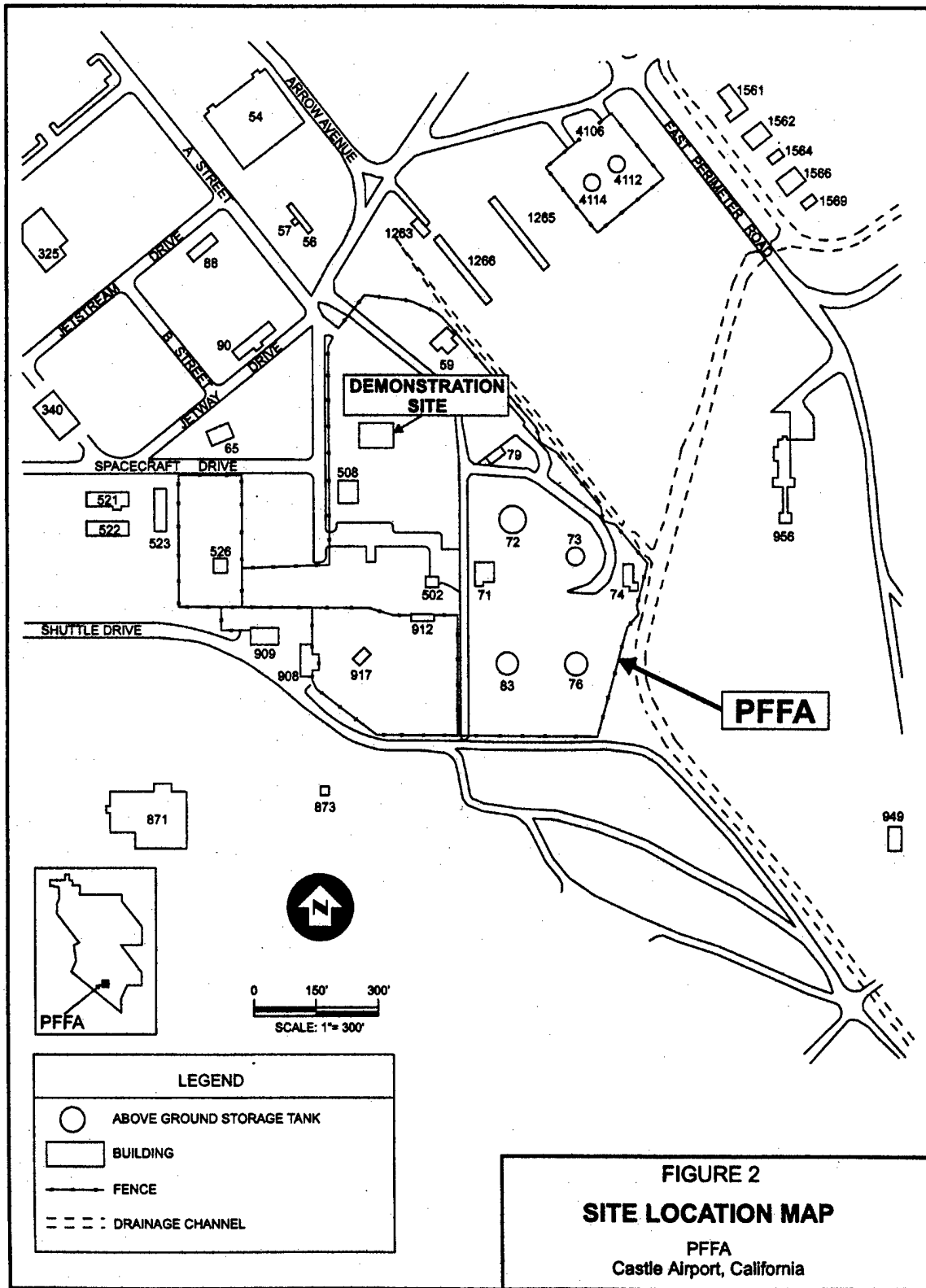

V731272\REPORT\FINAL\GRAPHICS\FIGS_P8.CDR 9/29/00

Air Ground Combat Center (MCAGCC) in southern California, natural daily barometric pressure changes could induce air flows of up to 15 cubic feet per minute (cfm) into vadose zone wells for short periods of time (Foor *et al.*, 1995; Zimmerman *et al.*, 1997). The depth to groundwater at Twentynine Palms is approximately 200 feet below ground surface (bgs) and the lithology is primarily medium- to coarse-grained sands. Through the use of a one-way check valve (also called a passive valve), oxygen concentrations were increased in the vadose zone 9 feet from the injection well. The radius of influence was not directly measured, but was inferred from pressure measurements to be 20 feet.

At Hill AFB in Utah, during a one week test air flow rates of up to 5 cfm were obtained. The depth to water at the Hill site is approximately 100 feet bgs (Battelle, 1995). At the Savannah River Site in South Carolina, air flow rates from an extraction well were as high as 6 cfm at a site with a depth to groundwater of approximately 120 feet bgs (Rossabi *et al.*, 1993; Rossabi *et al.*, 1998).

Although theoretically passive bioventing should work under certain conditions with shallow groundwater and stratified soils, it had never been demonstrated prior to the demonstration at Castle Airport described in this report. The DoD most likely has more sites fitting this description than deep groundwater sites.

2. Technology Description

2.1 Description

2.1.1 Introduction. Bioventing is an effective, proven, cost-effective, *in situ* biological treatment technology for unsaturated soils containing contaminants amenable to aerobic biodegradation. Bioventing technology is used to remove contaminants from vadose-zone soils by providing oxygen to natural, aerobic microorganisms which break down these contaminants.

Bioventing has a widespread potential application because soil microorganisms are capable of degrading most petroleum products (including gasoline, jet-propulsion fuel, diesel fuel, and heating oils) under aerobic conditions. Bioventing technology has a particular advantage for soils contaminated with less volatile fuels since technologies that depend on volatilization, such as vapor extraction, are not very effective with these compounds.

Conventional bioventing requires at least one blower to either inject or extract air. Oxygen in ambient air is supplied to naturally occurring microorganisms which aerobically degrade the contaminants. A small, regenerative electric blower is usually used to inject air into vent wells (VWs) installed above the water table in contaminated soil. Relatively low air flow rates (on the order of 15 to 30 cfm per well [20,000 to 40,000 cubic feet per day (cfd) per well]) and low injection pressures (on the order of 10 to 30 inches of water) are used to minimize volatile loss

while maximizing biodegradation. Conventional bioventing has been successfully demonstrated at DoD installations and other facilities (Miller *et al.*, 1993; Leeson and Hincee, 1997). Conventional bioventing is included in the list of treatment technology profiles in the *Remediation Technologies Screening Matrix and Technology Guide* (USEPA, 1999).

2.1.2 Passive Approaches to Bioventing. Passive bioventing differs from conventional bioventing in the way oxygen is delivered to the subsurface. Instead of electric blowers, passive bioventing relies on natural air exchange.

Previous field tests have shown that daily changes in barometric pressure cause open vadose wells to inhale and exhale air (sometimes termed “barometric pumping” or “breathing”) (Pirkle *et al.*, 1992; Rossabi *et al.*, 1993, Foor *et al.*, 1995; Zimmerman *et al.*, 1997). This phenomenon is illustrated on Figure 3. During times of increasing barometric pressure, a negative pressure gradient is potentially developed between the atmosphere and the subsurface, which is measurable as a vacuum at subsurface monitoring points. Air flow can occur into the subsurface if vent wells (VWs) or monitoring wells are installed and appropriately screened at depths where significant gradients are developed. The reverse effect occurs during times of decreasing barometric pressure (*i.e.*, positive pressure gradients are developed and air flows out of the well).

The magnitude of the pressure gradient (and also the magnitude of the air flow rate) is primarily a function of the rate of barometric pressure change, depth, soil air permeability, and soil porosity (Zimmerman *et al.*, 1997). The relationship between the pressure gradient and these variables manifests itself as a lag time between the changes in barometric pressure and the subsurface pressure, as well as a dampening of the magnitude of the barometric pressure change in the subsurface.

Barometric pressure varies daily with air temperature fluctuations, with pressures usually lowest in the afternoon and highest in the early morning. Weather front (long-term) barometric pressure changes can also be significant. Typically barometric pressure varies diurnally on the order of approximately 0.2 inches Hg from day to night. The passage of periodic weather fronts can cause an even greater change in barometric pressure. However, a significant change in barometric pressure alone is not a sufficient guarantee that pressure gradients will actually be developed or can be engineered in the subsurface to create the air flow required. As indicated above and further presented in Section 5, site lithology and soil characteristics are just as important.

2.1.3 Passive Bioventing Design. Design of a passive bioventing system is almost identical to the design of a conventional bioventing system, except that an electric blower is not required and one-way passive air flow valves are installed at the VWs (Figure 4). Natural pressure gradients are used to replace the blower and the passive valves are used to enhance the treatment radius. In engineering or designing a passive bioventing system with vertical wells, the driving force for producing the required subsurface air exchange (or airflow) is provided by the pressure gradient between the atmosphere and the subsurface (Figure 3). Using the passive valve, air can enter the VW only when inside well pressure is lower than atmospheric (due to

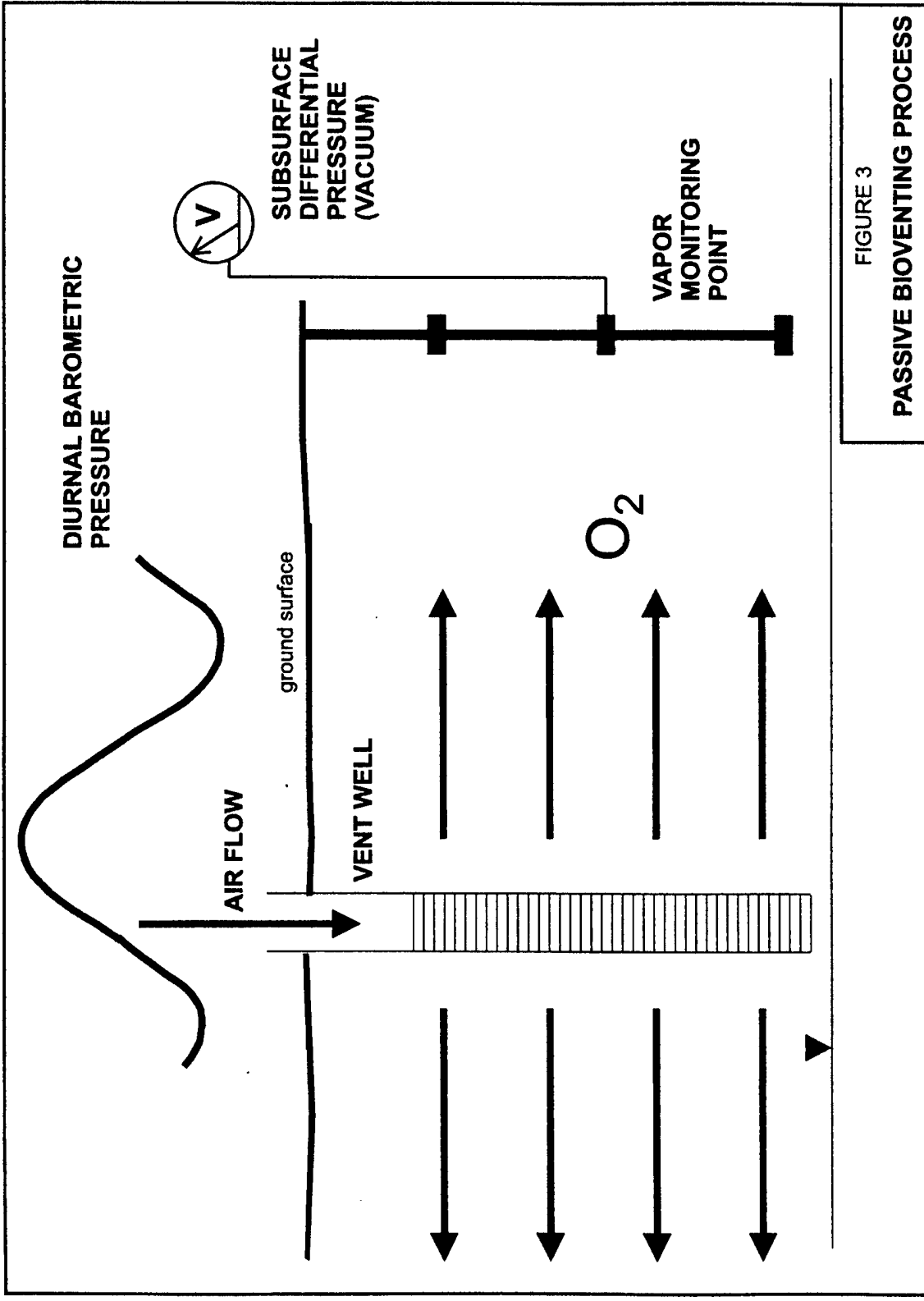

FIGURE 3
PASSIVE BIOVENTING PROCESS

V3127AREPORT\FINAL\GRAPHICS\FIGS_L8A.CDR 9/29/00

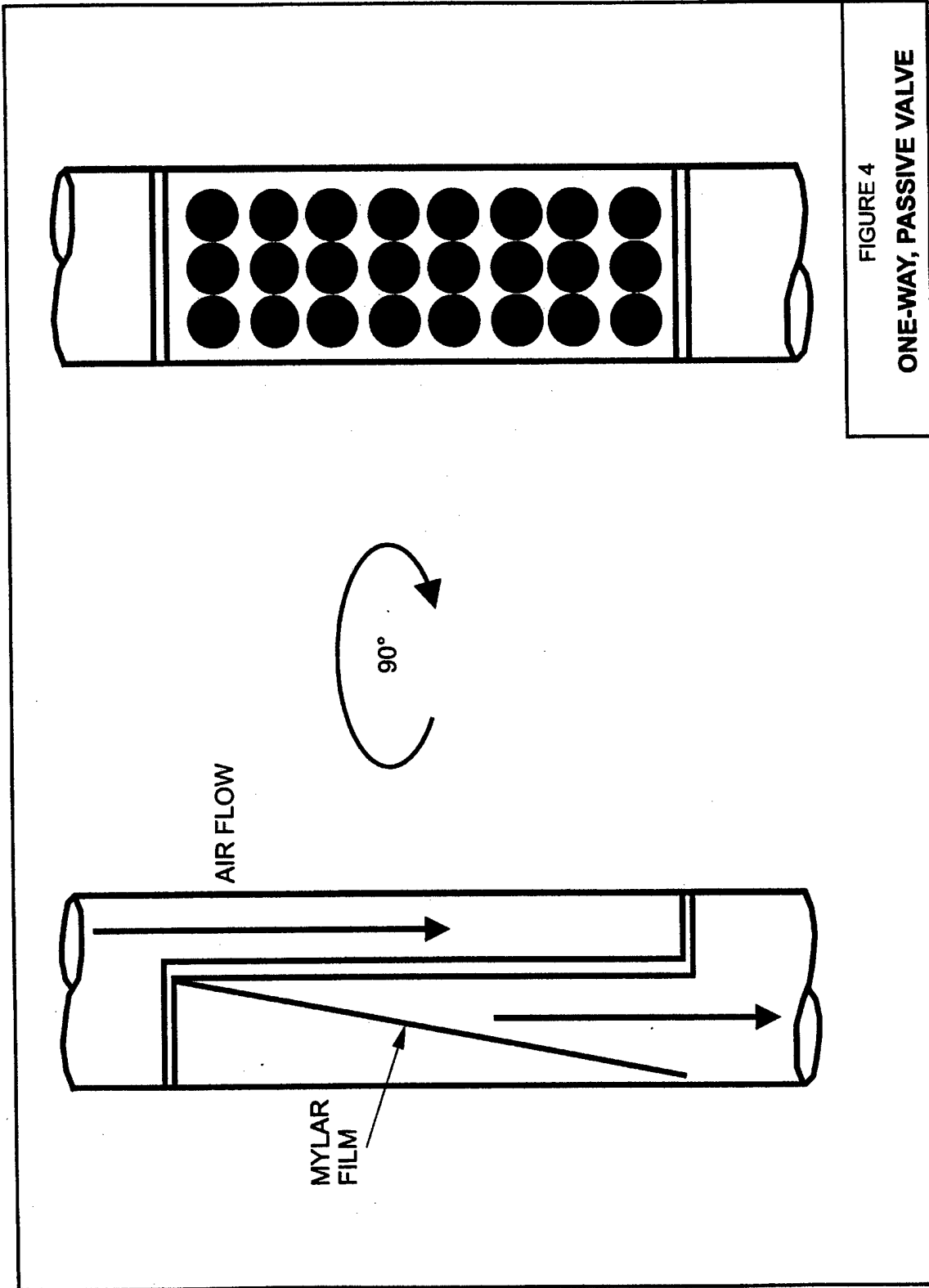

FIGURE 4
ONE-WAY, PASSIVE VALVE

V731272REPORT\FINAL\GRAPHICS\FIGS_L8A.CDR 9/29/00

barometric changes). When the reverse gradient occurs, the valve closes to prevent the exhalation of previously injected air. Because horizontal permeability is typically much greater than vertical permeability, through successive air injection events the treatment area expands as previously injected air moves outward from the VW.

In addition to the VWs used for air injection or extraction, soil vapor monitoring points (VMPs) are used to monitor system performance and are an important part of bioventing system design. The VMPs are spaced radially around the VWs at distances expected to be under the influence of the VWs (Figure 5). Oxygen, carbon dioxide, and contaminant concentration measurements are taken from vapor samples collected from the VMPs in order to determine the radius of influence and treatment area.

Potential enhancement to system designs include using a tandem series of multiple VWs and one-way valves in different configurations, where some VWs are used for air injection and others are used for air extraction. In such a tandem arrangement, air flow could be directed to specific areas or underneath buildings.

2.1.4 Key Design Criteria. The key design criteria for passive bioventing systems is the required spacing for the VWs, based on the expected radius of influence and the air flow rate into the VW. As the expected radius of influence and air flow rate decrease, a larger number of closely-spaced VWs is required to treat an area of contaminated soil. Eventually, the cost savings realized from not installing and operating a blower would be offset by the substantial increases in drilling and VW installation costs if the radius of influence is small. Additional details on the site characteristics which affect these key design criteria are provided in Section 2.3.

2.1.5 Performance Objectives. The performance objectives are designed to establish under what circumstances passive bioventing can be practical and cost effective. The two primary performance objectives for this demonstration project were:

1. Achieve an adequate radius of influence to be economically viable; and,
2. Achieve air flow rates sufficient to meet the biological demand.

Because the radius of influence and oxygen demand of microorganisms will be site-specific, the success of the technology will necessarily be based on the ability to achieve an economical radius of influence from VWs and induce air flow needed to meet site-specific oxygen demands rather than on presumptive numerical values. The treatment area and air flow requirements must be met economically, without an excessive number of VWs required compared to a conventional bioventing approach. Additional details on the performance objectives are provided in Section 4.1.

2.2 Strengths, Advantages, and Weaknesses

2.2.1 Strengths, Advantages, and Weaknesses of Conventional Bioventing Over Other Technologies. The major advantage of conventional bioventing over other remediation

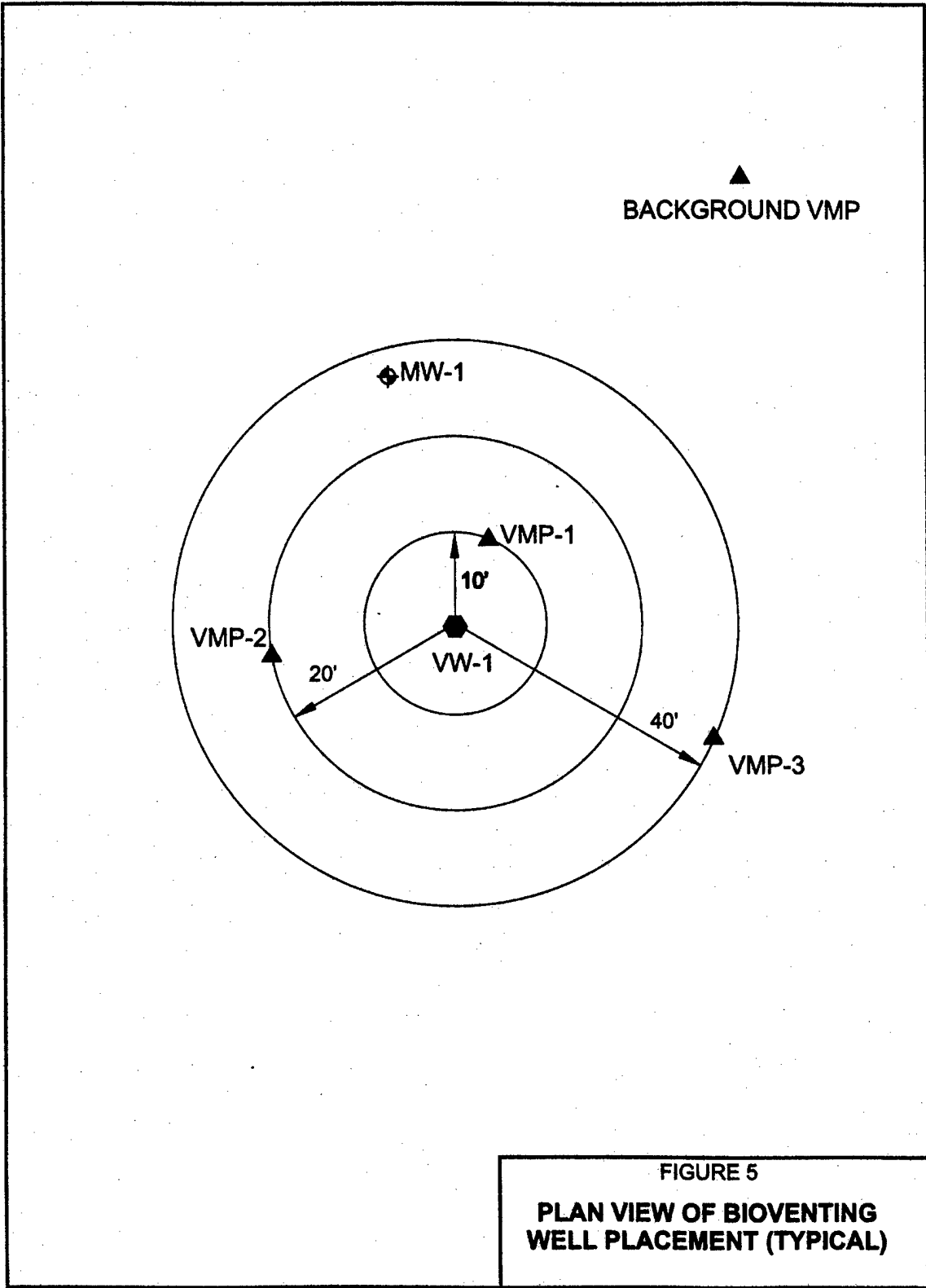

FIGURE 5
PLAN VIEW OF BIOVENTING
WELL PLACEMENT (TYPICAL)

technologies is that it is a proven, cost-effective technology that promotes *in situ* biodegradation of petroleum hydrocarbons in soil under a wide range of site conditions.

The major weaknesses include that it can only be applied to vadose zone contamination amenable to aerobic biodegradation (*e.g.*, petroleum hydrocarbons and chlorobenzenes), its effectiveness is limited at sites with soils with low air permeability, and very low soil moisture can limit biodegradation (USEPA, 1999). The presence of preferential pathways, caused by stratification or other primary or second features in the subsurface can also cause limitations/performance problems. These problems include:

- Vertical preferential pathways, such as abrupt changes in lithology, deep root zones, or anthropomorphic features, could cause air flow to short circuit to the ground surface.
- Horizontal preferential pathways, such as higher permeability horizons, bedding planes, and anthropomorphic features, may inhibit remediation if they act to direct air flow away from or restrict air flow to contaminated zones.

The same weaknesses listed above for conventional bioventing also apply to passive bioventing.

2.2.2 Advantages of Passive Bioventing Over Conventional Bioventing. The primary advantage of passive bioventing over conventional bioventing or other remediation systems is elimination of the need for a blower and electrical power. At many facilities power is either unavailable or would be very expensive to obtain. Even at facilities where access to power is available, often contaminated sites are far away from power access points and operations and maintenance (O&M) costs for the system are largely due to blower and power requirements.

If appropriately constructed (*i.e.*, an adequate screened interval intersects the contaminated vadose zone soils), many existing monitoring wells (MWs) could be converted to passive bioventing wells by simply converting their existing well caps with downhole passive valves. Although this application of the technology may not work on all wells and not every contaminated site has a network of wells, given the very low cost, even a success rate of 1 in 5 or 10 sites would result in very low cost remediation.

2.2.3 Weaknesses of Passive Bioventing Compared to Conventional Bioventing. The primary weakness of the passive technology is that adequate subsurface pressure differentials must take place in order for the required air flow rates and radii of influence to be achieved. Sites where these conditions would not be expected to exist include sites without significant barometric pressure changes, sites which have soils with very low air permeability (*i.e.*, soils composed almost entirely of silt and clay), and sites with shallow groundwater and very limited lithologic stratification. At these sites, conventional bioventing or other remedial technologies would need to be applied.

The primary reason that passive bioventing is probably not applicable to sites with homogeneously tight soils is that the barometric changes produce a lower pressure head

compared to the blowers used in conventional bioventing. The lower pressure head would be unlikely to result in significant air flow with distance at these sites. However, at heterogeneous sites where there is a combination of both very permeable and less permeable zones (e.g., interbedded sands and clays), both passive and conventional bioventing systems would produce air flow primarily in the more permeable zones. Both approaches would rely on diffusional mechanisms for oxygen transport from more permeable to less permeable zones, rather than on advection or head differences. The lower pressure head itself would not inherently lead to lower contaminant destruction rates since diffusional mechanisms are the primary oxygen transport mechanism into less permeable zones with both systems.

Because the radius of influence and air flow rates for a passive system are likely to be lower than those for a conventional bioventing system, more VWs will likely be required at most sites compared to a conventional bioventing system to achieve similar remediation times. However, if the system is designed to deliver an air flow rate that is able to meet microorganism oxygen demand, remediation times would not significantly increase with a passive bioventing system compared to a conventional bioventing system.

As discussed in Section 2.3, it also may not be necessary to meet the maximum microbial oxygen demand. As areas near the VW are remediated and the oxygen demand is satisfied, the radius of influence should expand. While this expansion of the radius of influence may come at the cost of longer remediation times, the time/cost tradeoff may be acceptable at some sites.

2.3 Factors Influencing Cost and Performance

As discussed in Section 2.1.4, the key design criteria for passive bioventing systems is the required spacing for the VWs, based on the expected radius of influence and the air flow rate from the VW. As the expected radius of influence and air flow rate decrease, a larger number of closely-spaced VWs is required to treat an area of contaminated soil. Eventually, the cost savings realized from not installing and operating a blower would be offset by the substantial increases in drilling and VW installation costs if the radius of influence is small.

The expected radius of influence and air flow rate are primarily a function of the following site characteristics:

- magnitude of barometric pressure change;
- frequency of barometric pressure change;
- air permeability of the soil (a function of soil type, soil porosity, soil moisture); and,
- oxygen-utilization rate of microorganisms (*in situ* respiration rate).

The presence of nonaqueous phase liquids may create vapor migration hazards and decrease the air permeability of the soil. Other, less significant, factors which can affect biological respiration rates and, therefore, performance include:

- soil temperature;
- natural organic carbon content;
- soil pH; and,
- nutrient levels.

The parameters listed above are identical to those listed for conventional bioventing in the *Guide to Documenting Cost and Performance for Remediation Projects* (USEPA, 1995).

The required air flow at a site should be compared to the demand of the microorganisms to determine feasibility. A method for estimating the required air flow rate to meet the maximum demand of the microorganisms is given below (USEPA ORD, 1995):

$$Q = \frac{k_o \cdot V \cdot \theta_a}{(C_{\max} - C_{\min})} \quad (1)$$

where:

- Q = volumetric air flow rate [cubic feet per day (cf)]
- k_o = oxygen-utilization rate (*in situ* respiration rate) [%/day]
- V = volume of contaminated soil [cubic feet]
- θ_a = air-filled porosity [volume air/volume soil]
- C_{\max} = oxygen concentration of background/injected air [%] (typically 20.9%)
- C_{\min} = minimum oxygen concentration for aerobic conditions [%] (typically 5.0%)

For example, assuming a typical oxygen-utilization rate of 0.2% per hour (typical of most petroleum-contaminated soils), a contaminated vadose zone thickness of 50 feet, an air-filled porosity of 0.25 (θ_a ranges from 0.1 to 0.4 at most sites), and a radius of influence from the VW of 10 feet (the minimum radius measured at the Twentynine Palms site), Equation (1) gives an air flow requirement of approximately 1,200 cubic feet per day (cf). Equation (1) is particularly sensitive to the radius of influence (with a slightly larger radius of influence of 15 feet, the air flow demand would be 2,700 cfd). Air flow rates at both the Hill AFB and Twentynine Palms sites were on the order of 3,000 to 5,000 cfd, indicating the feasibility of using passive bioventing to meet microorganism demand.

It may not be necessary to meet the maximum microbial oxygen demand at a site. It is expected that the radius of influence from a passive bioventing system would approach that of a conventional bioventing system over a relatively long time period. Although initially the radius of oxygen influence will be limited by the microbial demand near the VW, as areas near the VW are remediated and the oxygen demand is satisfied, the radius of influence should expand. While this expansion of the radius of influence may come at the cost of longer remediation times, the time/cost tradeoff may be acceptable at some sites.

The technique used to determine the radius of influence in conventional bioventing design protocols (see Section 4.3) is a pressure differential threshold of 0.10 "H₂O because it is conservative and, with a conventional bioventing pilot test, is easy to measure. The protocols also emphasize the use of air flow rates and biodegradation rates for a design radius of influence and indicate that sufficient air flow may occur with distance in higher permeability soils at

pressure differentials that cannot be measured. Because the passive bioventing technology is most applicable at sites with higher permeability soils, achieving sufficient air flow and measurable oxygen increases with distance is likely to be a better approach than using pressure differential thresholds.

Air-filled porosity can be highly variable and difficult to measure accurately. It is usually estimated from both measured soil moisture content and an estimate of the soil's total porosity from observed lithology; therefore, it is very sensitive to both of these parameters (USEPA ORD, 1995). Air-filled porosity can significantly affect the biodegradation rate and the predicted radius of influence because it is used to determine the volume of air available for replacement in the subsurface. Lower air-filled porosities lead to lower biodegradation rates (because less oxygen is delivered to a unit soil volume). Somewhat counter-intuitively, lower air-filled porosity leads to a larger radius of influence because for a unit volume of air flow, more soil volume is filled. Of course, it would be expected that with very high moisture contents air flow itself might be reduced; therefore, the radius of influence might actually remain the same or even decrease. There is nothing inherently different about a passive system that makes it any more or less sensitive to air-filled porosity than a conventional bioventing system.

3. Site/Facility Description

3.1 Background

Castle Airport (formerly Castle AFB) is located in Merced County, California, approximately 5 miles northwest of the city of Merced (Figure 1). It occupies approximately 3,000 acres of land and is comprised of runway and airfield operations, industrial areas, and several non-contiguous parcels of land located near the former base. Castle AFB was selected for closure under the Defense Base Closure and Realignment Act of 1990 and was officially closed in September of 1995. Environmental investigations, underground storage tank (UST) removals, and soil and groundwater cleanup operations are ongoing. Some parts of the former base have been leased to public and private entities.

The Petroleum, Oils, and Lubricants (POL) Fuel Farm Area (PFFA), built in the 1940's, is located in the southern portion of the Main Base Sector and was the bulk fuel storage and distribution facility (Figure 2). Approximately 18 USTs were formerly located and four above-ground storage tanks (ASTs) (3 million gallon total capacity) are currently located at the site. Extensive remedial investigations identified soil and groundwater contamination, primarily petroleum hydrocarbons, as a result of surface spills, leaking underground storage tanks, and fuel distribution lines. Most of the site is paved with asphalt or concrete or covered with gravel.

Based on the information available, the standard industrial classification (SIC) code most applicable to the site is 4581 (Transportation by Air — Airports, Flying Fields, and Airport Terminal Services) and the waste management practice that contributed to the site contamination is Petroleum, Oil, and Lubricant lines and underground storage tanks.

General selection criteria for passive bioventing sites were detailed in Section 3.1 of the Technology Demonstration Plan (TDP) (NFESC, 1997). A comparison of the criteria and the characteristics of the PFFA site at Castle Airport is summarized in Table 1. Detailed data are provided in the Technology Demonstration Plan, Site-Specific Addendum (NFESC, 1998).

Table 1
Selection Criteria

Criteria	PFFA Site Characteristic
Biodegradable contaminants	Contaminant concentrations in soil as high as 28,000 mg/kg TPH and 279 mg/kg BTEX
Soils are oxygen-deficient	Soil vapor oxygen concentrations were less than 1% in contaminated areas
Average diurnal barometric pressure changes greater than approx. 0.1 in. Hg	Diurnal barometric pressure changes measured at approx. 0.1 in Hg during short-term testing
Conventional bioventing is planned for the site (to provide leveraged data and facilitate cost comparison)	Conventional bioventing was selected for the PFFA in the feasibility study and was planned as a remedial action
For shallow groundwater sites, stratified soils with a relatively high horizontal air permeability relative to vertical air permeability	Groundwater is at approximately 60 feet bgs and soils at the site are highly stratified (see Section 3.2.2)

3.2 Site/Facility Characteristics

3.2.1 Climate. The climate of the Merced area in central California, where Castle Airport is located, is semiarid, Mediterranean type and characterized by wet winters and long, dry summers with maximum temperatures often exceeding 100 degrees Fahrenheit (°F). Winters are very cool with high humidity. The mean annual temperature at Castle Airport is 62 °F; the mean monthly temperatures range from 45°F in February to 79°F in July. During the summer, the clear, dry air allows rapid radiation, leading to large differences between day and night temperatures (frequently 40°F or more).

The mean annual precipitation is 12 inches. Approximately 85 percent of the precipitation falls between November and April. The average monthly relative humidity ranges from a high of approximately 75 percent during January to a low of approximately 30 percent in July.

Winds from the northwest prevail throughout most the year. Although the strongest winds occur between January and March, daily peak wind speeds are typically between 10 and 20 knots throughout most of the year. Winter precipitation events are usually preceded by winds from the southeast.

3.2.2 Geology and Hydrogeology. The shallow subsurface stratigraphy at Castle Airport is characterized by Holocene to Pleistocene alluvial deposits consisting of interbedded sequences of sands, silts, and gravels. These deposits include the Riverbank and Modesto formations. Generally, the upper 20 feet of these deposits consist of eolian and Holocene flood plain sediments, while the deeper deposits consist of sequences of silts, sands, and gravels that increase in coarseness with depth. Hardpan composed of iron- and silica-cemented sands and silts is often encountered between approximately 2.5 and 15 feet below ground surface (bgs). Currently, shallow groundwater is generally encountered at approximately 50 to 70 feet bgs, although historically groundwater was as shallow as approximately 10 feet bgs in some areas. Groundwater pumping is extensive in the areas surrounding the former base.

A plan view of the demonstration area is shown on Figure 6 and a generalized cross-section through the demonstration area is shown on Figure 7. The subsurface in the upper 20 feet is comprised predominantly of silty sand, overlying a laterally continuous silt layer between approximately 20 and 25 feet bgs. Between 30 and 35 feet bgs, sand with little to no fines predominates. This sand is underlain by another continuous clay/silt layer approximately 5 to 10 feet in thickness. Below this second clay/silt layer, sand extends to the groundwater table. Well construction details and boring logs for VWs and VMPs in the demonstration area are provided in Appendix C.

3.2.3 Nature and Extent of Contamination. Extensive previous remedial investigations have identified soil and groundwater contamination at the PFFA (NFESC, 1998; Jacobs, 1995). Nonaqueous phase liquids (NAPLs) have not been found at the site. Soil and soil vapor contamination in the area where the passive bioventing technology demonstration was conducted are discussed below.

In preparation for full-scale design of a conventional bioventing system at the PFFA, a bioventing pilot test was conducted in the demonstration area prior to demonstration activities in November/December 1997. This pilot test consisted of installing one shallow vent well, PFFAVW01, and three vapor monitoring points, PFFAVMP14, PFFAVMP15, and PFFAVMP16 (Figure 6). Well construction details and boring logs are provided in Appendix C. Figure 6 also shows sampling locations for the demonstration, which are more fully discussed in Section 4.

Soil and soil vapor samples were collected for analysis in conjunction with the installation of the bioventing pilot test wells (PFFAVW01, PFFAVMP14, PFFAVMP15, and PFFAVMP16), the passive bioventing demonstration VW (PFFAVW02), and the buried oxygen sensors (PFFABOS01 through PFFABOS08). The results of these analyses, taken prior to any demonstration activities, are summarized in Tables 2, 3, and 4.

The maximum detected concentrations of soil contaminants were: 28,000 mg/kg total petroleum hydrocarbons as gasoline (TPH-g); 4,400 mg/kg TPH as jet propulsion fuel #4 (TPH-JP4); 2,880 mg/kg TPH as jet propulsion fuel A (TPH-Jet A); 12 mg/kg benzene, 80 mg/kg toluene, 40 mg/kg ethylbenzene, and 180 mg/kg total xylenes. The maximum detected concentrations of soil vapor contaminants were: 54,000 parts per million by volume (ppmv)

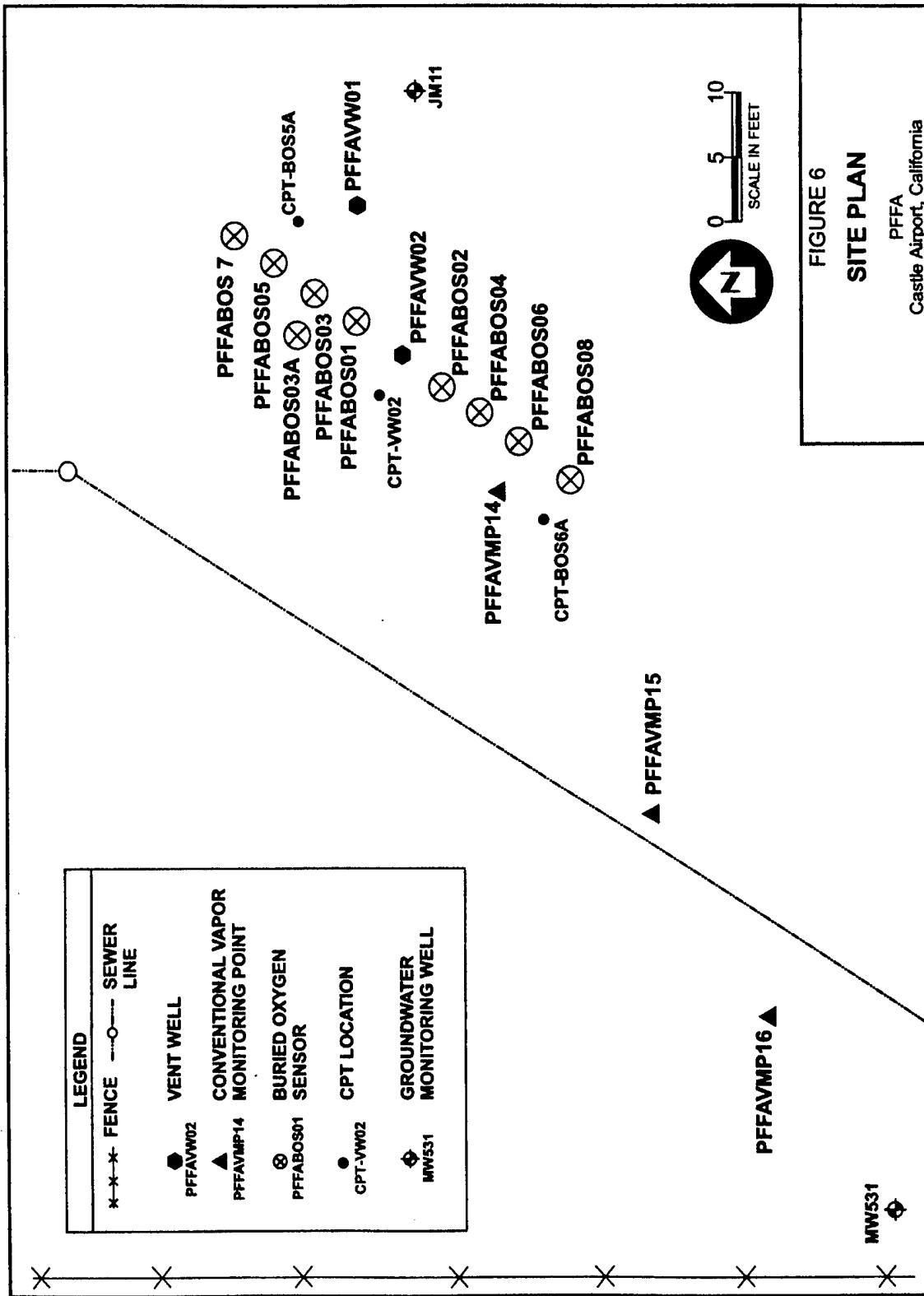

73127AREPORTFINAL\GRAPHICS\FIGS_L8A.CDR 9/29/00

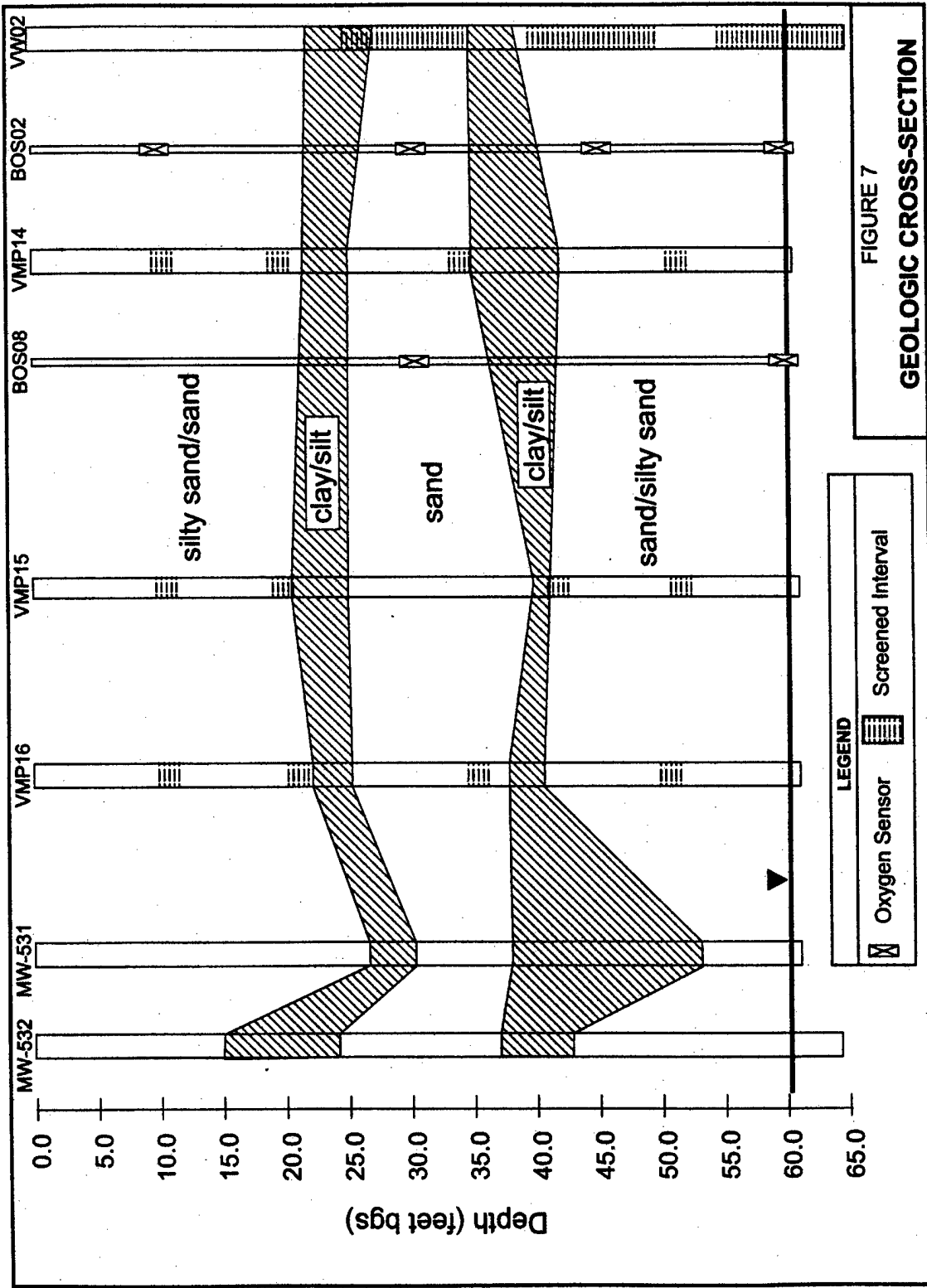

173127/REPORT/FINAL/GRAPHICS/FIGS_LBA.CDR 9/29/00

TABLE 2
Pre-Demo
Soil Sampling Results – Organics & Moisture Content
PFFA – Castle Airport, California

Location	Depth (ft bgs)	Total Petroleum Hydrocarbons				Volatile Organic Compounds				Moisture
		8015M/8015B				8020A/8260				ASTM D2216
		Analyte:	TPH-g	TPH- JP4	TPH- Jet A	TPH-d ¹	Benzene	Toluene	Ethyl- benzene	Total Xylenes
mg/kg										% by wt
PFFAVW01	20	1.4 J	n.a.	n.a.	2.9 J	0.044	<0.007	0.005	0.008	25.5
	33	1,700. J	n.a.	n.a.	200. J	<0.062	<0.062	3.2	11.2	3.2
PFFAVW02	30	<1.	<1.	<10.	<10.	<0.005	<0.005	<0.005	<0.005	4.6
	45	<500.	0.73	613.	<10.	<2.5	0.6	4.3	19.	3.8
PFFAVMP14	60	<1.	<1.	<10.	<10.	<0.005	<0.005	<0.005	<0.005	4.6
	15	0.84 J	n.a.	n.a.	2.6 J	<0.006	<0.006	<0.002	<0.006	8.7
	22	n.a.	n.a.	n.a.	n.a.	n.a.	n.a.	n.a.	n.a.	1.9
	40.5	2,200.	n.a.	n.a.	1,000. J	8.1	53.	40.	178.	18.0
PFFAVMP15	41	28,000.	n.a.	n.a.	490. J	12.	80.	37.	164.	20.4
	51	2.9 J	n.a.	n.a.	130. J	0.021	0.034	0.014	0.054	2.5
	43	0.71 J	n.a.	n.a.	n.a.	<0.005	<0.005	<0.002	<0.005	2.4
PFFAVMP16	52	0.71 J	n.a.	n.a.	1.9 J	0.001 J	<0.005	<0.002	<0.005	3.4
	15	n.a.	n.a.	n.a.	n.a.	n.a.	n.a.	n.a.	n.a.	0.9
PFFABOS01	55	0.49 J	n.a.	n.a.	3.1 J	0.002 J	<0.005	<0.002	<0.005	4.6
	30	<1.	<1.	<10.	<10.	<0.005	<0.005	<0.005	<0.005	3.0
	45	<500.	3,000.	<10.	<10.	<2.5	14.	27.	120.	8.7
PFFABOS02	59	<500.	1,200.	323.	<10.	<2.5	0.5 J	3.9	30.	4.5
	30	<1.	<1.	<10.	<10.	<0.005	<0.005	<0.005	<0.005	5.3
	45	<50.	160.	256.	<10.	<0.25	<0.25	0.22 J	1.1	4.4
	45.5	<500.	360.	290.	<10.	<2.5	<2.5	0.60 J	2.8	3.2
PFFABOS03	59	<1.	<1.	<10.	<10.	<0.005	<0.005	<0.005	<0.005	4.5
	30	<500.	720.	445.	<10.	<2.5	0.49 J	1.2	3.0	3.6
	45	<500.	2,200.	<10.	<10.	4.0	37.	25.	99.	3.1
PFFABOS04	45.5	<500.	3,400.	<10.	<10.	8.0	58.	34.	140.	3.1
	59	<500.	2,500.	<10.	<10.	0.9 J	19.	16.	100.	6.0
	30	<1.	<1.	<10.	<10.	<0.005	<0.005	<0.005	<0.005	5.9
PFFABOS05	45	<500.	800.	324.	<10.	<2.5	2.9	6.4	29.	7.3
	45.5	<500.	1,200.	<10.	<10.	0.53 J	6.9	10.	45.	4.8
	59	<1.	<1.	<10.	<10.	<0.005	<0.005	<0.005	<0.005	4.4
	30	<500.	2,000.	1,250.	<10.	<2.5	0.5	12.	28.	3.6
PFFABOS06	59	<500.	4,400.	2,880.	<10.	4.4	44.	24.	180.	6.2
	30	<1.	<1.	<10.	<10.	<0.005	<0.005	<0.005	<0.005	3.4
PFFABOS07	59	<1.	<1.	<10.	<10.	<0.005	<0.005	<0.005	<0.005	3.5
	30	<500.	2,700.	1,800.	<10.	0.5	2.	23.	61.	3.4
	59	<500.	1,200.	775.	<10.	0.4	7.5	5.6	42.	7.2
PFFABOS08	30	<1.	<1.	<10.	<10.	<0.005	<0.005	<0.005	<0.005	4.1
	59	<1.	<1.	<10.	<10.	<0.005	<0.005	<0.005	<0.005	5.6

Notes:

¹ Chromatographic profile for all diesel results was inconsistent with the diesel reference fuel standard.

1.4 J : "J" denotes estimated concentration

n.a. : not analyzed

<10. : Result was less than the indicated reporting limit

TPH-g : Total Petroleum Hydrocarbons in the gasoline range

TPH-JP4 : Total Petroleum Hydrocarbons in the jet propulsion fuel #4 range

TPH-Jet A : Total Petroleum Hydrocarbons in the jet propulsion fuel A range

TPH-d : Total Petroleum Hydrocarbons in the diesel range

TABLE 3
Pre-Demo
Soil Sampling Results – Inorganics & Physical Properties
PFFA – Castle Airport, California

Location	Analyte:	Inorganics										Grain-Size Analysis				
		TKN	Total Phosphorous	Alkalinity	Total Iron	Microbially Reducible Iron	Soluble Iron	ORP	pH	Coarse sand	Med sand	Fine sand	Silt	Clay		
Method:	Method:	E351.4M	E365.3M	E310.1M	E6010A	Lowley & Phillips, 1987	DUWET/ E6010A	ASTM D1498-76	E9045C	ASTM D422						
Depth (ft bgs)		mg/kg										% by weight				
PFFAVW02	30	32.	221.	59.	7,700.	<2.0	3,040.	174.	7.71	0.1	58.1	25.8	14.7	1.3		
	45	50.	227.	<200.	7,010.	8.0	819.	190.	7.80	0.2	51.0	30.5	16.8	1.5		
	60	42.	172.	15.	7,380.	<2.0	1,080.	203.	8.04	0.6	16.2	64.7	17.5	1.0		
PFFAVMP14	22	n.a.	n.a.	n.a.	n.a.	n.a.	n.a.	n.a.	n.a.	0.0	2.3	5.0	59.3	33.4		
	40.5	<50.	n.a.	n.a.	n.a.	n.a.	n.a.	n.a.	n.a.	n.a.	n.a.	n.a.	n.a.	n.a.		
	41	<50.	n.a.	n.a.	n.a.	n.a.	n.a.	n.a.	n.a.	n.a.	n.a.	n.a.	n.a.	n.a.		
PFFAVMP15	43	n.a.	n.a.	n.a.	n.a.	n.a.	n.a.	n.a.	n.a.	0.0	17.9	73.3	8.8	0.0		
	52	<50.	n.a.	n.a.	n.a.	n.a.	n.a.	n.a.	n.a.	n.a.	n.a.	n.a.	n.a.	n.a.		
PFFAVMP16	15	59.	n.a.	n.a.	n.a.	n.a.	n.a.	n.a.	n.a.	0.6	24.8	44.3	19.9	10.4		
PFFABOS02	45	41.	238.	48.	7,570.	44.	1,040.	164.	7.32	n.a.	n.a.	n.a.	n.a.	n.a.		
	45.5	48.	148.	25.	5,960.	31.	694.	189.	7.30	n.a.	n.a.	n.a.	n.a.	n.a.		
PFFABOS07	30	29.	229.	<200.	5,690.	<2.0	2,150.	205.	7.84	0.0	39.6	42.3	16.6	1.5		
	59	69.	193.	30.	10,000.	<2.0	948.	206.	8.13	0.0	6.3	75.0	17.2	1.5		

Notes:

2.1.1 : "J" denotes estimated concentration

n.a. : not analyzed

<50 : Result was less than the indicated reporting limit

TKN : Total Kjeldahl Nitrogen

ORP : Oxidation Reduction Potential

TABLE 4
Pre Demo
Soil Vapor Sampling Results
PFFS – Castle Airport, California

Location	Method: Analyte: Depth/Screen Interval (ft bgs)	EPA TO-3					Field Instruments			
		TPH-g	Benzene	Toluene	Ethyl- benzene	Total Xylenes	TVH	Oxygen	Carbon Dioxide	
		units in ppmv					units in %			
PFFAVW01	6-21	4,600.	20.	30.	29.	110.	J	>10,000.	1.5	12.5
PFFAVW02	25-35;40-50;55-65	20,000.	220.	220.	41.	200.		>10,000.	0.0	8.8
PFFAVMP14	10	n.a.	n.a.	n.a.	n.a.	n.a.		200.	1.5	12.5
	20	n.a.	n.a.	n.a.	n.a.	n.a.		1,500.	0.3	8.0
	35	13,000. (12,000.)	250. (250.)	160. (160.)	50. (42.)	150. (110.)		>10,000.	0.0	12.7
	51	54,000. J	1,200. J	820. J	140. J	440. J		>10,000.	1.0	12.3
PFFAVMP15	10	n.a.	n.a.	n.a.	n.a.	n.a.		260.	12.8	2.5
	20	1,700.	7.2	9.1	10.	44.	J	3,100.	0.0	8.0
	42	n.a.	n.a.	n.a.	n.a.	n.a.		>10,000.	0.4	13.2
	52	40,000.	540.	45.	130.	370.		>10,000.	0.0	13.0
PFFAVMP16	10	n.a.	n.a.	n.a.	n.a.	n.a.		1,100.	18.3	2.1
	20	440.	0.72	2.4	1.3	5.5	J	2,000.	4.7	4.5
	35	n.a.	n.a.	n.a.	n.a.	n.a.		7,400.	0.0	13.0
	51	22,000.	230.	47.	48.	110.		>10,000.	0.0	13.0
PFFABOS01	10	260.	0.68	2.0	0.73	2.8		510.	0.0	0.3
	30	8,000.	59.	14.	17.	55.	M	>10,000.	0.0	7.0
	45	48,000. (35,000.)	560. (500.)	270. (310.)	53. (21.)	200. (78.)	M	>10,000.	0.0	9.0
	59	18,000.	77.	28.	4.6	17.	M	>10,000.	0.0	9.5
PFFABOS02	10	250.	0.37	2.2	0.60	1.9	M	880.	0.6	0.7
	30	3,600.	20.	18.	12.	42.	M	7,100.	0.0	7.0
	45	19,000.	120.	28.	4.8	10.	M	>10,000.	0.0	8.8
	59	22,000.	96.	44.	10.	44.	M	>10,000.	0.0	9.0
PFFABOS03A	10	78.	0.32	0.50	0.35	1.2		1,000.	0.0	2.3
	30	6,200.	35.	28.	11.	37.		>10,000.	0.0	7.2
PFFABOS03	45	16,000.	96.	28.	4.5	15.		>10,000.	0.0	9.4
	59	22,000.	100.	37.	5.3	13.		>10,000.	0.0	9.8
PFFABOS04	10	180. (87.)	2.8 (1.4)	1.2 (0.83)	0.25 (0.16)	0.85 (0.60)		310.	0.0	1.8
	30	2,200.	8.6	14.	4.2	14.	M	6,800.	0.0	6.9
	45	51,000.	480.	300.	80.	350.		>10,000.	0.0	8.6
	59	17,000.	33.	8.3	4.4	15.	M	>10,000.	0.0	9.0
PFFABOS05	30	5,300.	26.	24.	5.7	17.	M	>10,000.	0.0	7.5
	59	19,000.	100.	32.	4.4	14.		>10,000.	0.0	10.0
PFFABOS06	30	1,500.	3.7	10.	6.3	16.		4,100.	0.0	6.8
	59	15,000.	82.	15.	5.0	16.	M	>10,000.	0.0	9.0
PFFABOS07	30	32,000. (34,000.)	320. (340.)	81. (84.)	190. (210.)	670. (700.)		>10,000.	0.0	7.5
	59	21,000.	100.	30.	6.6	19.		>10,000.	0.0	10.0
PFFABOS08	30	1,200.	1.7	8.6	4.6	10.		3,200.	0.4	6.5
	59	14,000.	48.	12.	6.6	22.	M	>10,000.	0.0	8.5
PFFAVMP01	15	n.a.	n.a.	n.a.	n.a.	n.a.		66.	19.4	1.5
	30	n.a.	n.a.	n.a.	n.a.	n.a.		36.	19.0	1.8
MW270	48-89	n.a.	n.a.	n.a.	n.a.	n.a.		6.	19.5	0.8

(34,000.) : duplicate results shown in parentheses

2.1 J : "J" denotes estimated concentration

17 M : "M" denotes result may be biased due to matrix interferences

TVH : Total volatile hydrocarbons

>10,000 : Reading greater than indicated maximum

limit of the instrument

TPH-g; 1,200 ppmv benzene, 820 ppmv toluene, 210 ppmv ethylbenzene, and 700 ppmv total xylenes.

In addition to laboratory analyses, soil vapor throughout the area was analyzed in the field for oxygen, carbon dioxide, and total volatile hydrocarbons (TVH) using field meters. These results are also provided in Table 4 and indicate that the soil vapor is oxygen-depleted throughout the area, with the exception of some of the soil vapor in the shallower soils above 20 feet bgs. TVH readings were also lower in the shallower soils.

The soil vapor results generally correlated with the soil results. Soil, soil vapor, and headspace screening results indicate contamination is highest in the deeper soils below 35 to 30 feet bgs and extends to groundwater.

Soil vapor was also analyzed with the field meters at two uncontaminated background locations (PFFAVMP01 and MW270) located approximately 1,300 feet southeast (upgradient) of the site. Results are provided in Table 4. Oxygen concentrations at these locations are above 19.0%, indicating that there is very little natural oxygen demand in the soil and the measured oxygen-depletion in the VW and VMPs is an indication of microbial activity associated with the petroleum-contaminated soils.

3.2.4 Soil Grain-Size Analysis. Selected soil samples collected from both previous investigations and the demonstration activities were submitted for grain-size analysis to compare against lithologic interpretations made in the field. Samples were collected from the upper silty sand between ground surface and approximately 20 feet bgs, the clay/silt layer between approximately 20 and 25 feet bgs, and the sand layers between approximately 25 and 35 feet bgs and below approximately 40 feet bgs. Results are provided in Table 3. The results generally confirmed the lithologic interpretations made in the field, with significant silt and clay fractions measured in the clay/silt layer (greater than 90% clay/silt) and higher silt and clay fractions measured in the upper silty sand interval above 20 feet bgs (greater than 30% clay/silt) compared to the lower sand intervals (average of 16% clay/silt).

3.2.5 Soil Moisture and pH. Soil moisture and pH were measured for selected soil samples collected during the previous remedial investigations at the PFFA and during the installation of the wells for the demonstration. For vadose zone soil samples, soil moisture content ranged from 0.9 to 25.5 percent by weight (% by wt.), with an average soil moisture content calculated at 5.8%. The moisture content for most samples was between 2% and 10%, a range considered optimal for bioventing since sufficient moisture is available for microorganisms but moisture content is not high enough to limit air permeability or air-filled porosity (USEPA ORD, 1995).

The soil moisture contents are relatively consistent when compared against the lithologic zone from which they were collected. For example, the relatively higher moisture contents of 18.0%, 20.4%, 25.5% shown in the table were all collected from the less permeable, clay/silt layers at 20 feet bgs (PFFAVW01) or 41 feet bgs (PFFAVMP14) (see Figure 7). All other moisture contents from the more permeable soils were relatively

consistent, showing a standard deviation of only 1.8% across a range of moisture contents between 0.9% and 8.7%.

Soil pH values were measured between 7.30 and 8.13, within the range considered optimal for microbial activity.

3.2.6 Air Permeability Testing. Air permeability testing was also conducted in the demonstration area during conventional bioventing pilot test activities in December 1997, prior to demonstration activities (Parsons ES, 1998). Two tests were conducted. The first test consisted of injecting air at PFFAVW01 in the shallow, finer-grained materials above 20 feet bgs. The second test consisted of injecting air in MW531 into the deeper, coarser-grained materials below 25 feet bgs. Results from the air permeability tests showed a smaller radius of influence (70 feet) and lower air permeability (3.9 darcies) could be expected in the shallow soils compared to the deeper soils (110 feet and 38 to 200 darcies). These results are consistent with the stratified geology of the site, as discussed in Section 3.2.2 and shown on Figure 7. The air permeabilities in both lithologic zones are within the range considered suitable for bioventing (USEPA ORD, 1995).

3.2.7 In Situ Respiration Testing. Short-term, initial *in situ* respiration (ISR) tests were also conducted in the demonstration area during conventional bioventing pilot test activities in February 1998, prior to demonstration activities (Parsons ES, 1998). The ISR tests were conducted at PFFAVMP14, PFFAVMP15, and PFFAVMP16. Testing was conducted at two discrete depth screens at PFFAVMP14 (35 feet and 51 feet bgs), one discrete depth screen at PFFAVMP15 (42 feet bgs), and one discrete depth screen at PFFAVMP16 (35 feet bgs). The purpose of using multi-depth monitoring points was to verify that soil bacteria and oxygen demand were present within the entire vadose zone. Subsequent ISR testing was also conducted during the demonstration; ISR test results from the demonstration are discussed in Section 5.2.3.

Results from the initial ISR tests indicate there were active microorganism populations within the oxygen-depleted zones that were tested. Initial oxygen-utilization rates measured at the demonstration area were low to moderate, ranging from 0.087% oxygen per hour (% O₂/hr) (2.1 %O₂/day) at PFFAVMP15 at 42 feet bgs to 0.29% O₂/hr (7.0% O₂/day) at PFFAVMP14 at 35 feet bgs, with a mean rate at all tested locations of 0.18% O₂/hr (4.2% O₂/day).

3.2.8 Barometric Pressure, Air Flow, and Differential Pressure. During the installation of the VW and VMPs for the conventional bioventing pilot test, it was noted by the field geologist that the VMPs and MWs at the site were exhaling and inhaling air at various times during the day. In addition, during the air permeability testing, the field scientist noted that changes in barometric pressure were clearly affecting the pressure measurements used to infer radius of influence and calculate air permeability. The barometric pressure interference was so significant (resulting in subsurface differential pressure fluctuations in the VMPs on the order of 0.3 to 0.6 inches of water) that subsurface differential pressure in a background well needed to be measured periodically to correct for the interference.

Based on these observations, a short test was conducted to evaluate the effect of barometric pressure on subsurface differential pressure and air flow at the site. Details are provided in the Technology Demonstration Plan, Site-Specific Addendum (NFESC, 1998). Air flow as high as 11 cfm and differential pressures as high as 0.9 inches H₂O were observed. Barometric pressure had a clear effect on both air flow and differential pressure, with air flowing into the well during periods of increasing air pressure and air flowing out of the well during periods of decreasing air pressure. Both long-term weather front changes and short-term diurnal changes affected both air flow and subsurface differential pressure.

Based on these results, more extensive testing to determine the radius of oxygen influence due to barometrically-induced air flow was of interest and the PFFA was selected as the passive bioventing demonstration site.

4. Demonstration Approach

4.1 Performance Objectives

As discussed in Section 2.1.5, the two primary performance objectives for this demonstration project were:

1. Achieve an adequate radius of influence to be economically viable; and,
2. Achieve air flow rates sufficient to meet the biological demand.

Because the radius of influence and oxygen demand of microorganisms will be site-specific, the success of the technology will necessarily be based on the ability to achieve an economical radius of influence from VWs and induce air flow needed to meet site-specific oxygen demands rather than on presumptive numerical values. The treatment area and air flow requirements must be met economically, without an excessive number of VWs required compared to a conventional bioventing approach.

Based on calculations and previous passive bioventing studies detailed in the TDP (NFESC, 1997), peak air flow rates on the order of 1 cubic foot per minute (cfm) per well or more, total air flow rates on the order of 1,200 cfd per well or more, and a radius of influence on the order of 10 feet per well or more are the expected results that will indicate the technical and economic success of the passive bioventing technology.

4.2 Physical Setup and Operation

4.2.1 Vent Well Construction. The initial phase of the demonstration conducted in March 1998 consisted of installing one vent well (PFFAVW02) (Figure 6). The VW was installed using hollow-stem augering (HSA) techniques and was constructed of 4-inch inside diameter (ID) Schedule 40 polyvinyl chloride (PVC) casing and 0.04-inch slotted screens. The VW was screened between 25 and 65 feet bgs, below the near surface silty sand and clay/silt layers

(Figure 7). Three individual, isolated 10-foot screened intervals were used in the VW in order to evaluate air flow rates into the different lithologic environments at the site. Each of the screens is isolated using solid PVC casing and corresponding bentonite seals between the screened sections and sand filter packs. These screens and their relationship to the lithologic zones at the site are shown on Figure 7. Construction details for the VW are provided on Figure 8 and a boring log/well construction detail is provided in Appendix C.

4.2.2 Buried Oxygen Sensors/Vapor Monitoring Points. Following installation of the VW, eight VMPs consisting of two radial arms each with four VMPs, were installed adjacent to the VW (Figure 6; Appendix E). Initially, it was planned to install the VMPs using cone-penetrometer test (CPT) techniques to save on costs and expedite the installation schedule. However, refusal of the CPT occurred during installation of the initial VMPs and some of the boreholes also collapsed during installation, which prevented accurate borehole verticality measurements (discussed in Section 4.2.3). Therefore, the CPT boreholes were grouted in place and HSA techniques were used in the final construction of all VMPs.

The four VMPs along each arm are located at distances of approximately 4, 8, 12, and 16 feet from PFFAVW02. Each of the VMPs is constructed using directly-buried oxygen sensors with an integrated sampling and pressure measurement port (Datawrite Research Corp. model XTM253SP) strapped to 2-inch ID solid PVC casing running the length of the borehole (Figure 9). Sensors at the four innermost VMPs (*i.e.*, those located at 4 and 8 feet from the PFFAVW02) are installed at approximately 10, 30, 45, and 60 feet bgs. Sensors at the remaining four VMPs (*i.e.*, those located at 12 and 16 feet from the PFFAVW02) are installed at approximately 30 and 60 feet bgs. Each of the sensors is isolated at depth using bentonite seals between the sensors and sand filter packs. The sensor depths and their relationship to the lithologic zones at the site and the screened intervals of PFFAVW02 are shown on Figure 7. Typical construction details for the VMPs are provided on Figure 9.

During sensor installation at PFFABOS03, the tubing connected to the two shallowest buried oxygen sensors (*i.e.*, those at 10 and 30 feet bgs) were accidentally destroyed while removing the hollow-stem augers. Therefore, these two damaged sensors were abandoned in place and replaced by two sensors installed in another borehole (subsequently named PFFABOS03A) adjacent to and at the same distance from PFFAVW02 as PFFABOS03. For simplicity, in the remainder of this report no distinction is made when discussing in the text whether the sensors located at the 8-foot distance along the northeastern arm are located in borehole PFFABOS03 or borehole PFFABOS03A.

CPT traces from successful CPT boreholes installed at the site are provided in Appendix C; CPT locations are shown on Figure 6. Results from the limited CPT installation were consistent with the geologic conceptual model (Section 3.2.2) determined from installation of the VW and conventional VMPs (PFFAVMP14, PFFAVMP15, and PFFAVMP16).

4.2.3 Borehole Verticality Survey. After installation of the VW and VMPs, a borehole verticality survey was conducted by Norcal Geophysical (Petaluma, California) using a Robertson Geologging, Ltd. verticality probe. As discussed in the Technology Demonstration

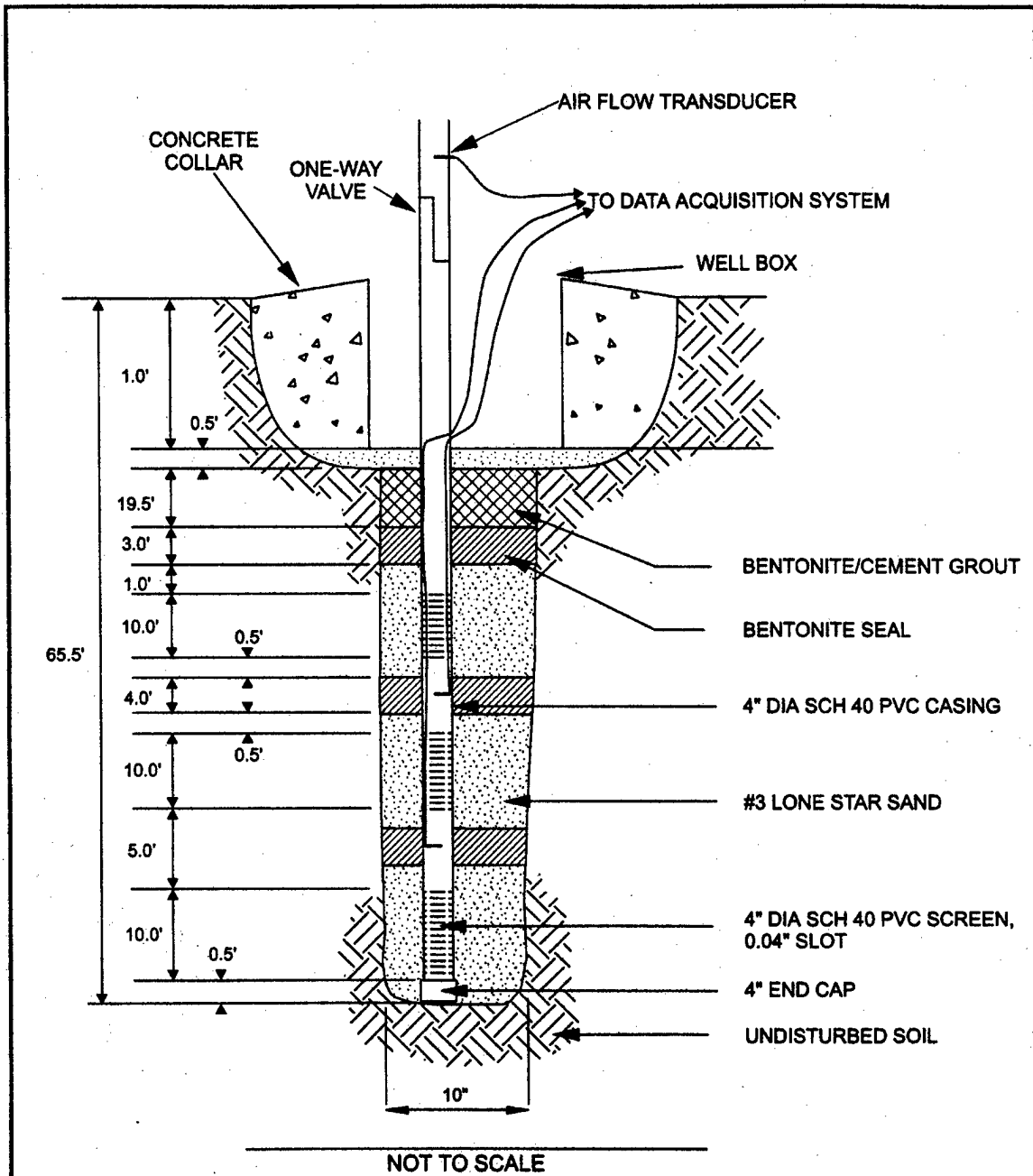

FIGURE 8
VENT WELL CONSTRUCTION AND
AIR FLOW TRANSDUCER
PLACEMENT

PFFA
 Castle Airport, California

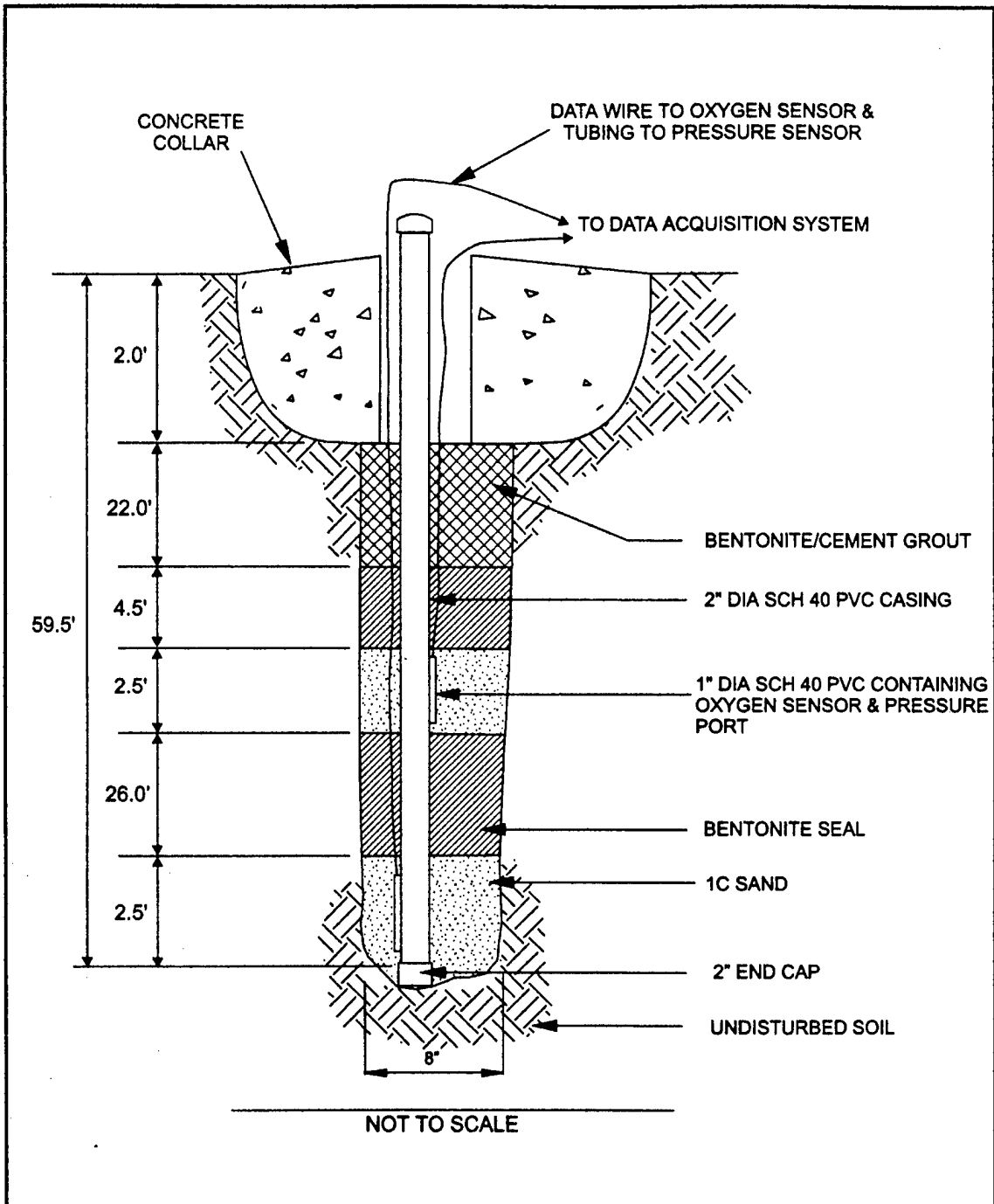

FIGURE 9
BURIED OXYGEN SENSOR
DETAIL (TYPICAL)

PFFA
 Castle Airport, California

Plan, Site-Specific Addendum (NFESC, 1998), the primary purpose of the verticality survey was to ensure the vertical orientation of the borings and correct for any significant deflection or intrusion into the sand filter pack of nearby VW/VMPs. The verticality survey was considered important since the distance between the VMPs and between the innermost VMPs and the VW was only 4 feet.

The results of the verticality survey are provided in Appendix C. Deviations from vertical ranged between approximately 0.10 and 1.1 feet. The deviations generally increased with depth. The largest deviations (1.1 feet) occurred at PFFABOS02 and PFFABOS08, located at 4 and 16 feet from the VW, respectively, at 59 feet bgs. While the maximum deviations at these locations were relatively significant compared to the horizontal distance to the nearest VMP or VW (4 feet), the direction of the deviation was generally away from the nearest VMP or the VW and the distance was not large enough to suspect that borehole interference or overlap occurred, especially at the shallower depths. Therefore, the vertical deviation of each of the boreholes is not expected to have adversely impacted test results or conclusions.

4.2.4 Pressure Transducers, Air Flow Transducers, and Temperature. Bidirectional pressure transmitters (Dwyer model 607) were used to measure subsurface differential pressure at each of the 24 integrated pressure measurements ports connected to the buried oxygen sensors. Three air flow transducers (TSI model 8475) were installed to measure air flow into and out of the VW at different depth intervals. One of the transducers was installed at the surface to measure total air flow; the remaining two were installed between the screened intervals in the VW to allow calculation of air flow into each of the screened sections. The placement of the air flow transducers is shown on Figure 8. Equipment details are provided in Appendix F.

A K-type thermocouple (Cole-Parmer Digi-Sense Model 8528-40) was used to measure ambient temperature at the surface. A downhole pressure transducer (Instrumentation Northwest Model PS9000) was installed in monitoring well JM11 (Figure 6) in order to measure changes in groundwater elevation.

4.2.5 One-Way, Passive Valve Construction. A one-way, passive valve (Section 2.1.3 and Figure 4) was constructed and used during testing to enhance the potential treatment radius. The valve was constructed of 4-inch ID, clear PVC by Nisei Plastics (Oakland, California). During the first two weeks of testing with the passive valve, single-celled foam rubber was used as the material for the internal flow control seal in the valve. However, test results indicated that some leaking was occurring with this material. A passive valve using a mylar sheet was subsequently substituted and used for the remainder of the demonstration tests.

4.2.6 Data Acquisition System. A data acquisition system was installed consisting of multiple data loggers (In-Situ, Inc. Hermit models 2000/3000) to provide enough channels for each of the transducers. The data acquisition system also included an integrated barometric pressure sensor. All measurements were collected and stored in real time. The following data was collected every 10 minutes:

- barometric pressure;
- air flow rates (total and between the three screened intervals in the VW);
- subsurface differential pressure at each VMP screen;
- subsurface oxygen concentration at each VMP screen (directly-buried sensors);
- ambient air temperature; and,
- groundwater elevation.

Installation of the VW, VMPs, and the data acquisition system was completed in April 1998.

4.2.7 Testing and Operation. Following installation of the VW, VMPs/directly-buried sensors, and the data acquisition system, the demonstration was conducted over a six-month period (starting in late April 1998 and continuing through late October 1998). A total of six tests were conducted:

Table 5
Test Configurations and Dates

Test Name	Test Configuration	Dates
TEST 1	PFFAVW02 closed (control)	30 Apr - 13 Jun
TEST 2	PFFAVW02 open without passive valve installed	14 Jun - 02 Jul
TEST 3	PFFAVW02 closed (respiration testing and equilibrium resting period)	02 Jul - 15 Jul
TEST 4	PFFAVW02 open with passive valve installed	16 Jul - 06 Sep
TEST 5	PFFAVW02 closed (equilibrium resting period in preparation for TEST 6)	06 Sep - 03 Oct
TEST 6	PFFAVW02 open without passive valve installed; repeat of TEST 2	03 Oct - 30 Oct

Test 1 was designed to evaluate the effects of barometric pressure fluctuations on subsurface oxygen and pressure conditions without any system enhancement and was used as a control condition for all subsequent tests and for testing system operation. Test 2 was designed to establish a radius of influence from air movement both into and out of the VW, without the use of the passive valve. Test 3 was designed to collect additional respiration data and allow subsurface oxygen concentrations to reach equilibrium concentration prior to the initiation of Test 4. Test 4 was the primary test for the passive bioventing demonstration and evaluated the effect of the passive valve on the radius of influence.

At the end of Test 4, an analysis of the data from Test 2 (discussed in Section 5.2.2) indicated that a repeat of the configuration used in Test 2 was needed due to weather-related barometric pressure changes. Therefore, Tests 5 and 6 were conducted.

4.3 Sampling Procedures

As detailed in the TDP (NFESC, 1997), the passive bioventing demonstration conformed to the maximum extent practical the field protocols and applicable requirements of the most current

version available of the following guidance documents (hereinafter referred to as “protocol documents”):

- *Principles and Practices of Bioventing*, USEPA Office of Research and Development (ORD), EPA/540/R-95/534, September 1995.
- *Test Plan and Technical Protocol for a Field Treatability Test for Bioventing*, U.S. Air Force Center for Environmental Excellence (AFCEE), May 1992.
- *Addendum One to Test Plan and Technical Protocol for a Field Treatability Test for Bioventing - Using Soil-Gas Surveys to Determine Bioventing Feasibility and Natural Attenuation Potential*, AFCEE, February 1994.
- *A General Evaluation of Bioventing for Removal Actions at Air Force/Department of Defense Installations Nationwide*, Air Force Center for Environmental Excellence (AFCEE), June 1996.

Soil and soil vapor contaminant concentrations were measured following the sample collection and analysis techniques specified in the TDP and the Sampling and Analysis Plan (SAP) included in the TDP Site-Specific Addendum (NFESC, 1998). Details on the field meters, sensors, and calibration procedures also are provided in the TDP Site-Specific Addendum. The field procedures and calculations used for measuring air permeability of the soil, measuring *in situ* respiration rates, and calculating biodegradation rates are well-documented in the protocol documents referenced above.

Changes in soil vapor oxygen concentration with time and distance from the VW were used to determine the radius of influence of the system. To facilitate this evaluation, oxygen concentrations were measured at VMPs located in two directions and several distances from the VW. These measurements were collected in both the VMPs containing directly-buried oxygen sensors (PFFABOS01 through PFFABOS08), as well as the conventional bioventing VMPs (PFFAVMP14, PFFAVMP15, and PFFAVMP16) previously installed at the demonstration site.

4.4 Analytical Procedures

The selection of analytical methods was detailed TDP Site-Specific Addendum. There were no significant deviations from these methods. All methods which were used for soil and soil vapor sampling were USEPA or ASTM standard methods, except for bioavailable (reducible) iron. The method of Lovley and Phillips (1994) was used for this measurement. The analytical methods used for each measurement are summarized in Tables 2, 3, and 4.

5. Performance Assessment

5.1 Performance Data

5.1.1 Soil and Soil Vapor Contaminant Concentrations. Soil and soil vapor contaminant concentrations were presented and discussed in detail in Section 3.2.3 and Tables 2, 3, and 4. These results indicate that sufficient contaminant concentrations and anaerobic conditions existed at the site to facilitate the demonstration and measure a radius of influence based on increases in soil vapor oxygen concentrations.

5.1.2 Soil Moisture and pH. Soil moisture and pH were presented and discussed in detail in Section 3.2.4 and Tables 2 and 3. These results indicate that moisture content and pH were within the ranges considered optimal for bioventing.

5.1.3 Soil Nutrients. Nutrients required for microbial activity and which might be expected to limit microbial activity in subsurface environments include nitrogen, phosphorus, and iron. Selected soil samples collected during the installation of the VW and VMPs at the demonstration site were analyzed for total Kjeldahl nitrogen (TKN), total phosphorus, and total and soluble iron. These results are presented in Table 3.

Nutrient concentrations ranged from 32 mg/kg to 69 mg/kg TKN, 148 mg/kg to 238 mg/kg total phosphorus, 5,690 mg/kg to 10,000 mg/kg total iron, and 694 ug/L to 3,040 ug/L soluble iron. The concentrations of these nutrients are within the ranges considered sufficient for microbial activity (USEPA ORD, 1995) and indicate that available nutrients should not be limiting to microbial activity. Background concentrations of oxygen (discussed in Section 3.2.3 and presented in Table 4) indicated that any natural iron in the soils at the PFFA does not create significant background oxygen demand.

5.1.4 Alkalinity. Soil alkalinity, along with soil pH, is a standard measurement conducted at bioventing sites because alkalinity and pH can affect the evolution of carbon dioxide produced during microbial activity. Alkalinity and pH affect soil vapor carbon dioxide concentrations such that, in high alkalinity soils, carbon dioxide production appears to be low due to the formation of carbonates. Conversely in low alkalinity soils, carbon dioxide production correlates well with oxygen consumption.

Soil alkalinity was measured primarily for comparison of alkalinity at the PFFA to data from other bioventing test sites. Soil alkalinity at the demonstration site in all cases was less than 200 mg/kg (the laboratory reporting limit), although for some samples estimates were provided of between 15 mg/kg and 59 mg/kg (Table 3). These results are consistent with the relatively high carbon dioxide concentrations measured in soil vapor at the site (Table 4) and are at the low end of concentrations measured at other bioventing test sites (USEPA ORD, 1995).

5.1.5 Oxidation Reduction Potential and Microbially Reducible Iron. Oxidation Reduction Potential (ORP) and microbially reducible iron were also measured for selected soil samples.

These measurements are not part of standard bioventing protocols; however, highly reduced soils and significant concentrations of reduced iron could potentially result in significant oxygen demand and increase the oxygen delivery requirements for a passive system. ORP ranged from 164 mV to 206 mV and reducible iron ranged from less than 2.0 mg/kg (the laboratory detection limit) to 44 mg/kg (Table 3).

Reducible iron concentrations were higher in the samples collected from 45 feet bgs, where soil contaminant concentrations were also highest, possibly indicating that some oxygen demand at these locations would occur due to the potential for reduced iron. However, the reducible iron concentrations were significantly less than the contaminant concentrations at those locations and, based on stoichiometry, would result in an oxygen demand far less than that required for microbial breakdown of the contaminants. Based on the ORP and reducible iron concentration data, the soils do not appear to be highly reducing nor are they expected to produce oxygen demands in excess of those predicted from respiration test data.

5.1.6 Barometric Pressure, Air Flow, Subsurface Differential Pressure, Subsurface Oxygen Concentrations, Ambient Air Temperature, and Groundwater Elevation. As discussed in Section 4.3, the following data was collected in real time at 10-minute intervals and stored in the data acquisition system:

- barometric pressure;
- air flow rates (total and between the three screened intervals in the VW);
- subsurface differential pressure at each VMP screen;
- subsurface oxygen concentration at each VMP screen (directly-buried sensors);
- ambient air temperature; and,
- groundwater elevation (at JM11).

All test data from the data acquisition system was downloaded and summarized using computerized spreadsheets (Microsoft Excel). This data is provided in Appendix D and discussed in Section 5.2.

5.2 Data Assessment

5.2.1 Test 1. Test 1 was designed to evaluate the effects of barometric pressure fluctuations on subsurface oxygen and pressure conditions without any system enhancement and was used as a control condition for all subsequent tests and for testing system operation. A plot of subsurface pressure response due to changes in barometric pressure during Test 1 is shown on Figure 10. The plot shows both diurnal barometric pressure changes as well as a minor weather front-related barometric pressure increase (between 28 May and 31 May).

Subsurface differential pressure response is shown for 2 depths, 10 feet bgs and 30 feet bgs. Although the data presented on Figure 10 is from 10 feet bgs and 30 feet bgs at one sampling location (PFFABOS02), it is representative of what is occurring at these depths throughout the site. Data from the same depths at other distances or locations, if plotted, would be indistinguishable from the data presented on Figure 10.

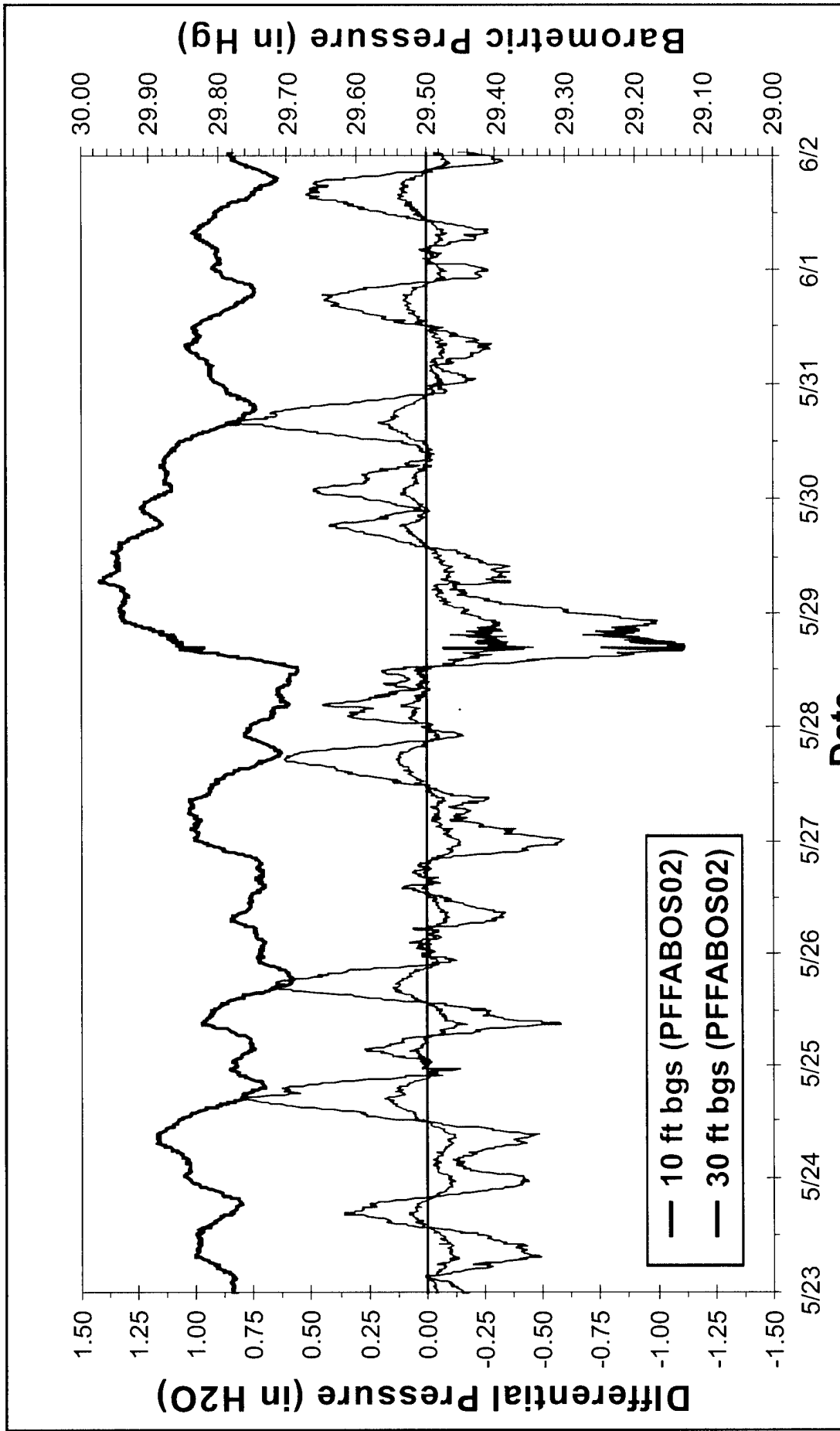

FIGURE 10

**SUBSURFACE PRESSURE
RESPONSE DURING TEST 1**

PFFA
Castle Airport, California

As expected, the differential pressure is negative at both depths during periods of increasing barometric pressure (compare to Figure 3) and positive during periods of decreasing barometric pressure. The magnitude of the subsurface differential pressure is significantly greater at 30 feet bgs compared to 10 feet bgs. However, the magnitude of the response at 30 feet bgs was essentially identical to that at 45 feet and 60 feet bgs in all VMPs (a plot of the data from 45 and 60 feet bgs would be indistinguishable on Figure 10 from the data at 30 feet bgs). Therefore, the significant influence on subsurface differential pressure factor at this site is not depth, but rather the geological stratification, more specifically, the overlying lower permeability silty sand between 0 and approximately 20 feet bgs and clay/silt layer between approximately 20 and 25 feet bgs (Figure 7).

5.2.2 Test 2. Test 2 was designed to establish natural rates of air flow into and out of the VW and a radius of influence from this cyclical air movement without the use of the passive valve. A plot of total air flow from PFFAVW02 due to changes in barometric pressure is shown on Figure 11. The plot shows a relatively significant weather front-related barometric pressure change during the first three days of the test, followed by primarily diurnal barometric pressure changes. Both the weather-front and diurnal barometric pressure changes resulted in significant air flow rates both into and out of the VW. Air flow rates as high as 20 cfm occurred during the weather front changes and as high as 12 cfm occurred during diurnal changes. These air flow rates are comparable to typical air flow rates used during conventional bioventing (USEPA ORD, 1995) and demonstrate the feasibility of using a passive bioventing approach at this site.

Air flow was approximately equal between the upper screened interval and the middle screened interval (see Figure 8). Air flow into the lower screened interval was generally much lower compared to flow into the two upper intervals (generally less than 5% of the total flow and never exceeding 18% of the total flow). This is likely a result of the shorter length of exposed screen (only 5 feet was exposed above groundwater; see Figure 7) and because the screen was probably within the capillary fringe.

A plot of oxygen concentrations along the southwestern VMP arm during Test 2 at 30 feet bgs is shown on Figure 12. Oxygen concentrations increased rapidly from near zero and were sustained at greater than 12% at the VMPs located within 8 feet of the VW and greater than 6% at the VMPs located within 16 feet of the VW. Oxygen concentrations did not increase appreciably in the VMP screens which were installed at 10 feet bgs and located within the upper silty sand, indicating that the clay/silt layer at 20 to 25 feet was acting, as expected, as a confining layer to vertical air flow (the VW was not screened within the upper silty sand).

While there was some variability in the oxygen concentrations along the two VMP arms, the differences were not significant. For simplicity, only the data from the southwestern arm is displayed on the figures subsequently presented in this section.

While these results were a positive indication that air flow rates could significantly increase oxygen concentrations at significant distances from the VW, an adequate measure of the radius

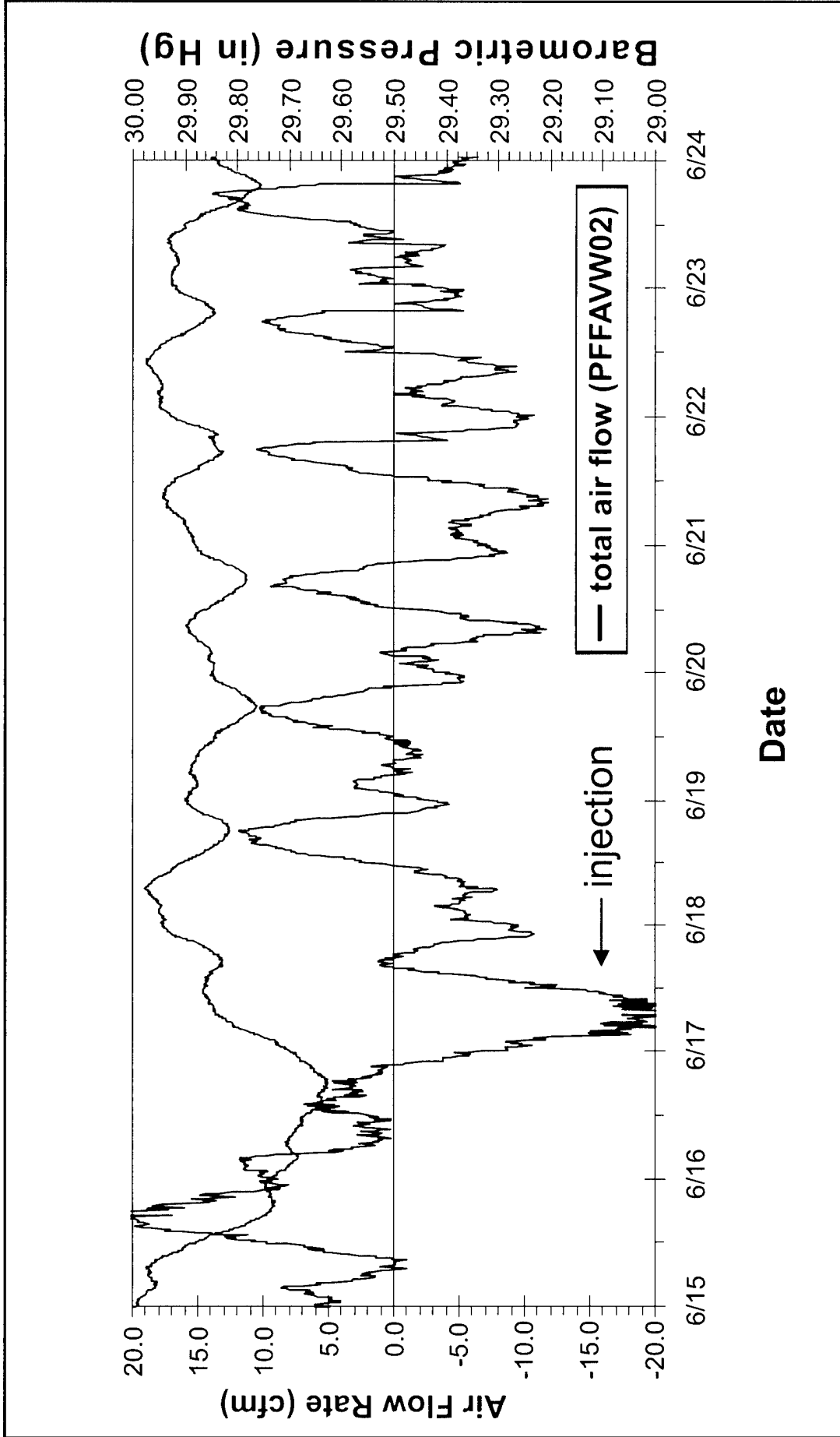

FIGURE 11
**AIR FLOW vs. BAROMETRIC
 PRESSURE DURING TEST 2**
 PFFA
 Castle Airport, California

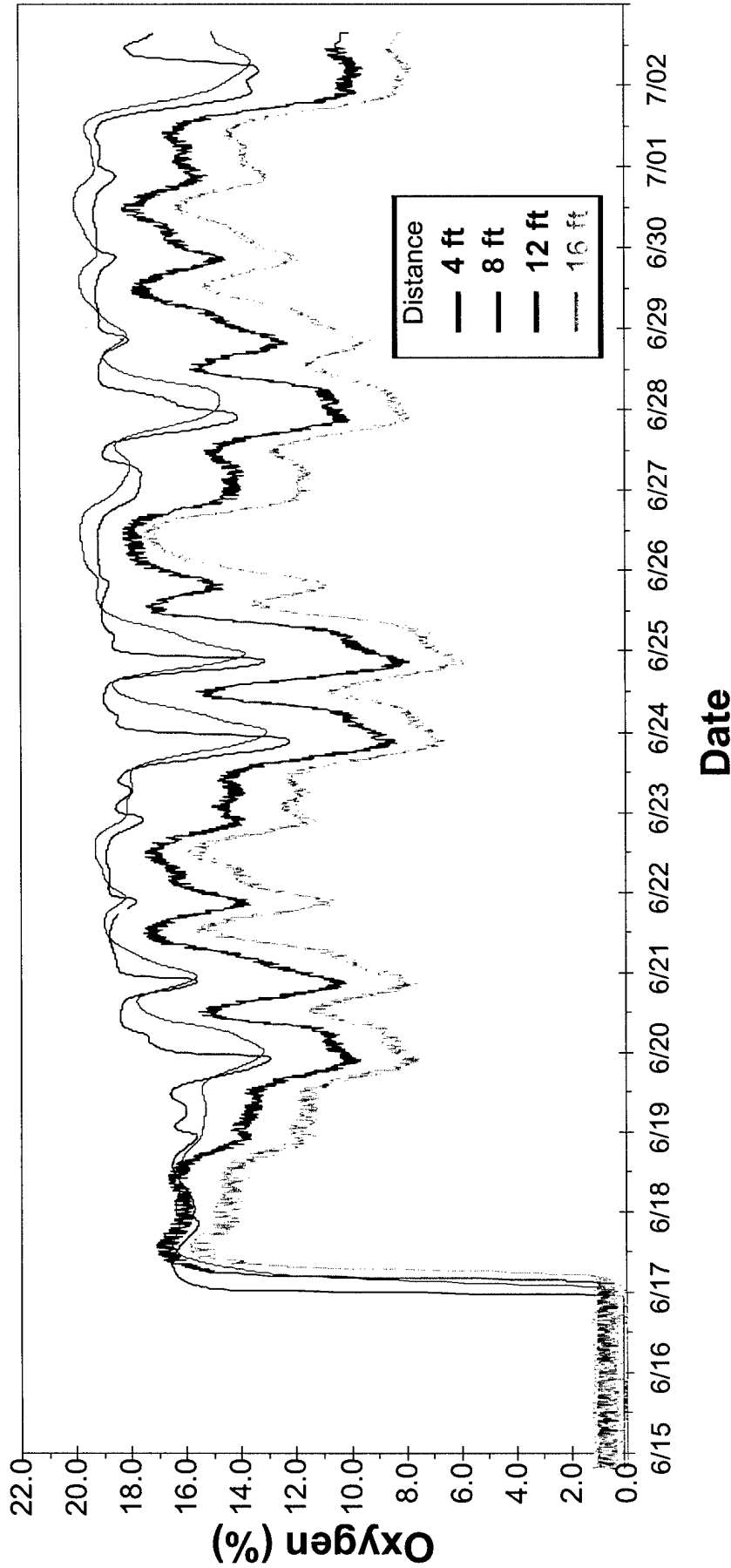

FIGURE 12

OXYGEN RESPONSE AT 30 FEET BGS DURING TEST 2

PFFA
Castle Airport, California

of influence was not possible since 5% is typically the oxygen concentration used to indicate that microbial activity is not oxygen limited (*i.e.*, the radius of influence could only be determined to be greater than 16 feet). In addition, the significant air flow which occurred during the weather-front related barometric pressure changes appeared to have been responsible for the significant initial increases in oxygen concentration which prevented an evaluation of oxygen response solely due to diurnal barometric pressure response.

5.2.3 Test 3. Test 3 was designed to collect additional respiration data and allow subsurface oxygen concentrations to reach equilibrium concentration prior to the initiation of Test 4. A plot of oxygen concentrations during Test 3 is shown on Figure 13. Oxygen concentrations decreased to near zero within two weeks at most locations and depths. Field measurements were also conducted to confirm readings from the buried oxygen sensors prior to the start of Test 4.

The rate of decline in oxygen concentrations resulted in calculated oxygen utilization rates between 0.48% O₂/day and 1.5% O₂/day (average rate of 1.0% O₂/day), somewhat lower than the rates measured during the previous short-term ISR tests (Section 3.2.7). However, it is common for such “area” respiration tests as conducted during Test 2, where a significant volume of soil is aerated, to show lower respiration rates than “point” respiration tests, as conducted during the initial ISR testing.

5.2.4 Test 4. Test 4 was the primary test for the passive bioventing demonstration and evaluated the effect of the passive valve on the radius of influence. A plot of air flow response due to changes in barometric pressure during Test 4 is shown on Figure 14. The effect of the passive valve in promoting air flow into the subsurface (a negative sign convention is used to indicate flow into the subsurface) but minimizing air flow out of the subsurface is indicated on this figure. There was some leakage through the valve during the first two weeks of testing (between 16 July and 01 August). Subsequent modifications to the valve (described in Section 4.2.5) reduced the leakage problem for the remainder of the test.

During Test 4 daily air flow rates ranged from a minimum of 27 cfd to a maximum of 9,300 cfd, with an average daily air flow rate of 3,400 cfd (Figure 15). It should be noted, however, that the minimum daily air flow rate of 27 cfd was the only daily air flow rate less than 300 cfd throughout the entire seven week test period. Peak daily air flow rates ranged from 5.1 cfm to 15 cfm, although air flow rates near the daily peak air flow rate were rarely sustained for more than 30 minutes to an hour.

A plot of subsurface oxygen response at 30 feet bgs along one of the VMP arms (PFFABOS02 through PFFABOS08) during Test 4 is shown on Figure 16. As expected, there is a progressive increase in the time for the oxygen response to occur related to the distance from the injection point. However, within a relatively short period of time oxygen concentrations increased from less than 1% to greater than 15% at each VMP. Concentrations greater than 15% were sustained for the entire duration of the test at 30 bgs and concentrations greater than 10% were sustained at 45 feet bgs.

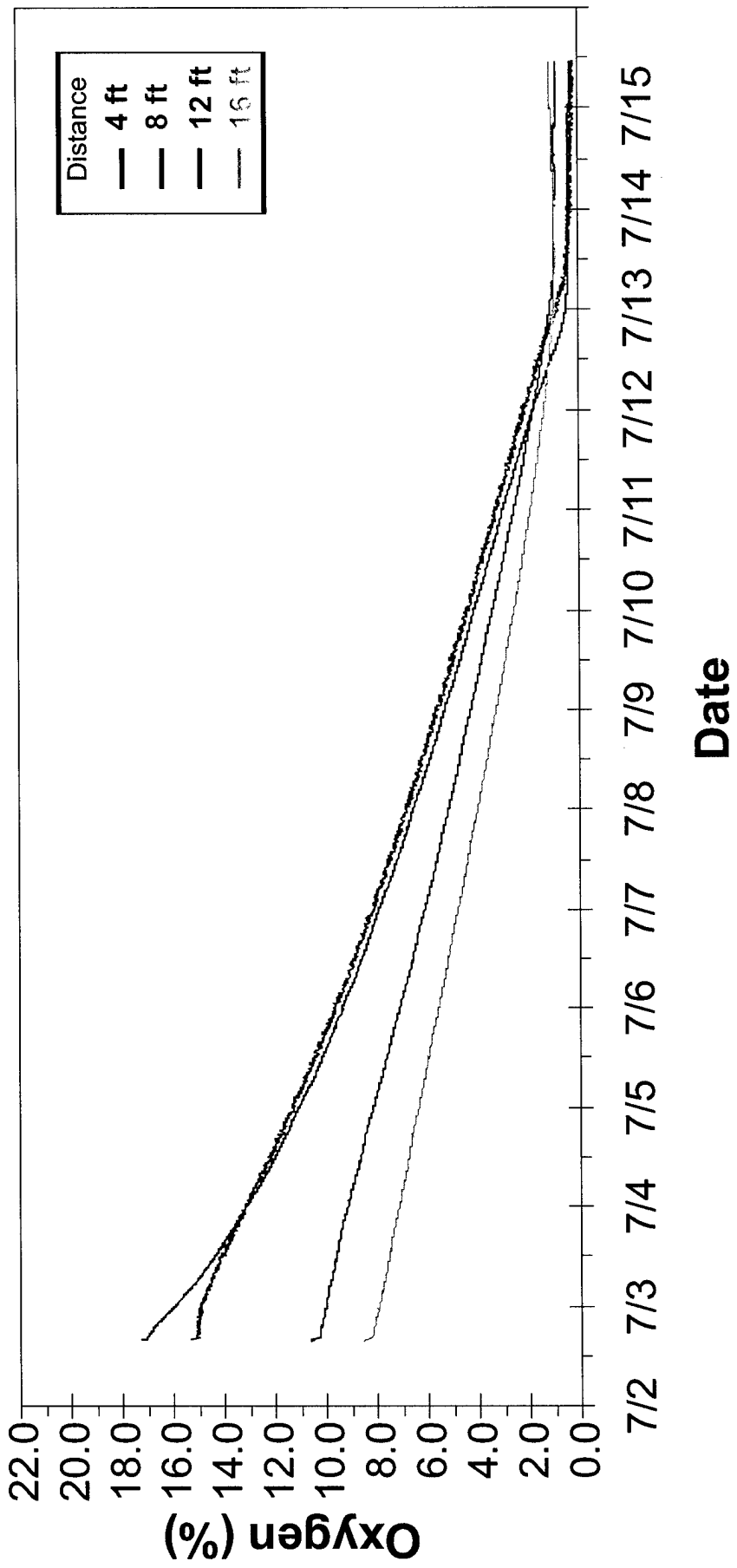

FIGURE 13

OXYGEN RESPONSE AT 30 FEET BGS DURING TEST 3

PFFA
Castle Airport, California

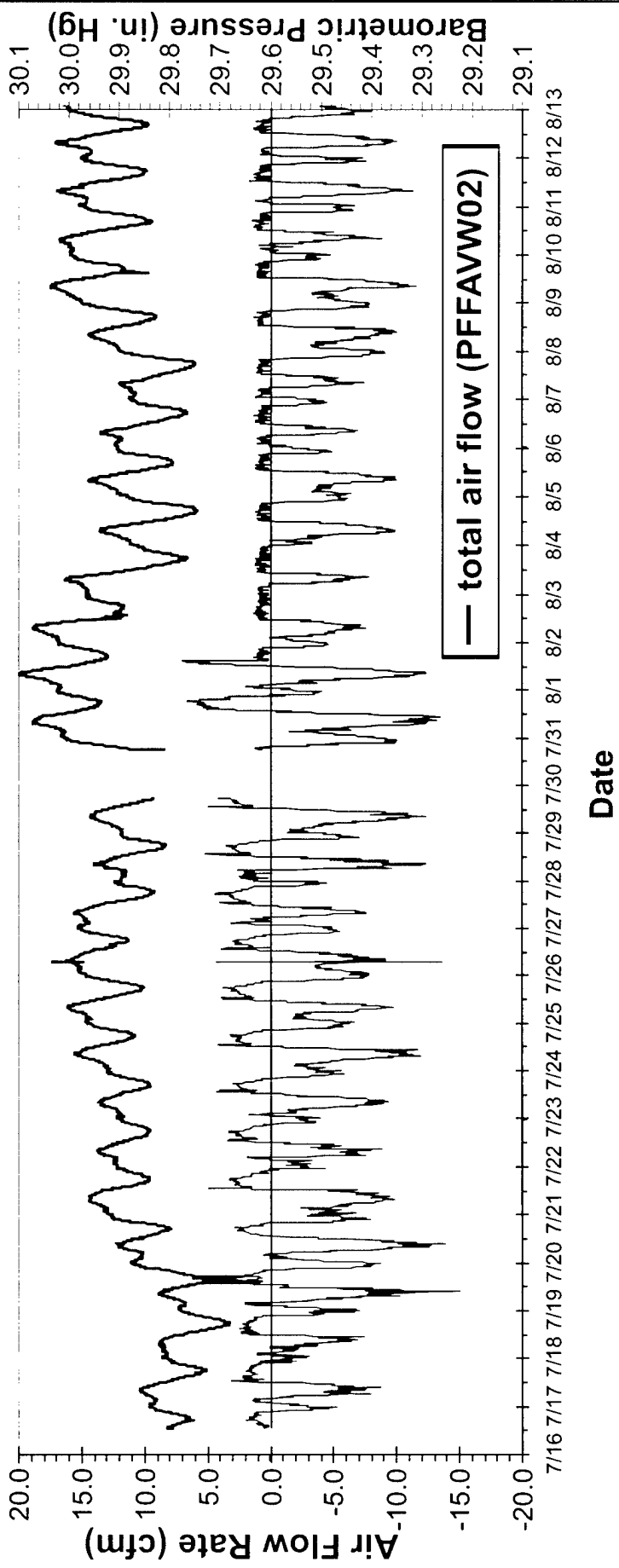

FIGURE 14

AIR FLOW vs. BAROMETRIC PRESSURE DURING TEST 4

PFFA
 Castle Airport, California

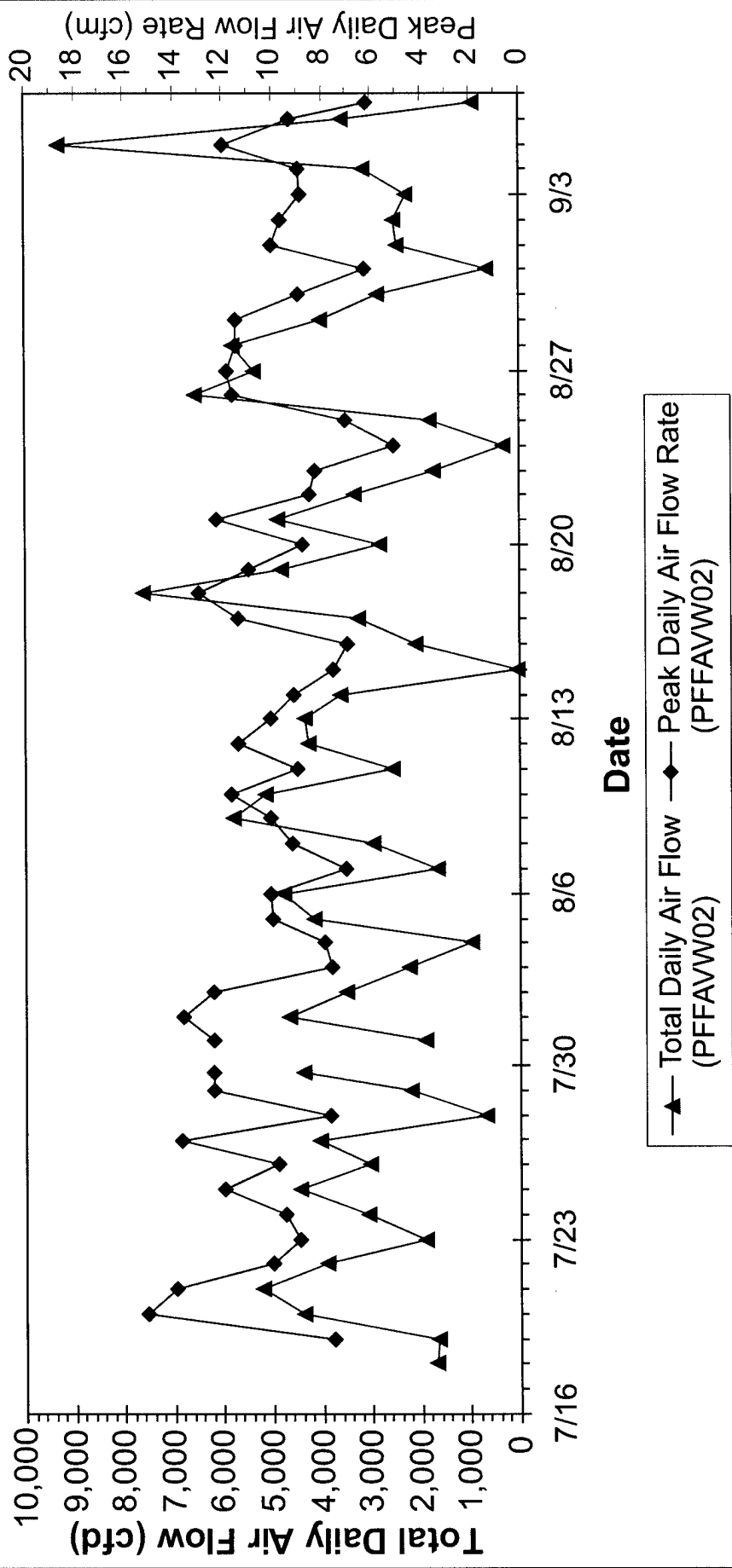

FIGURE 15
**DAILY AIR FLOW RATES
 DURING TEST 4**
 PFFA
 Castle Airport, California

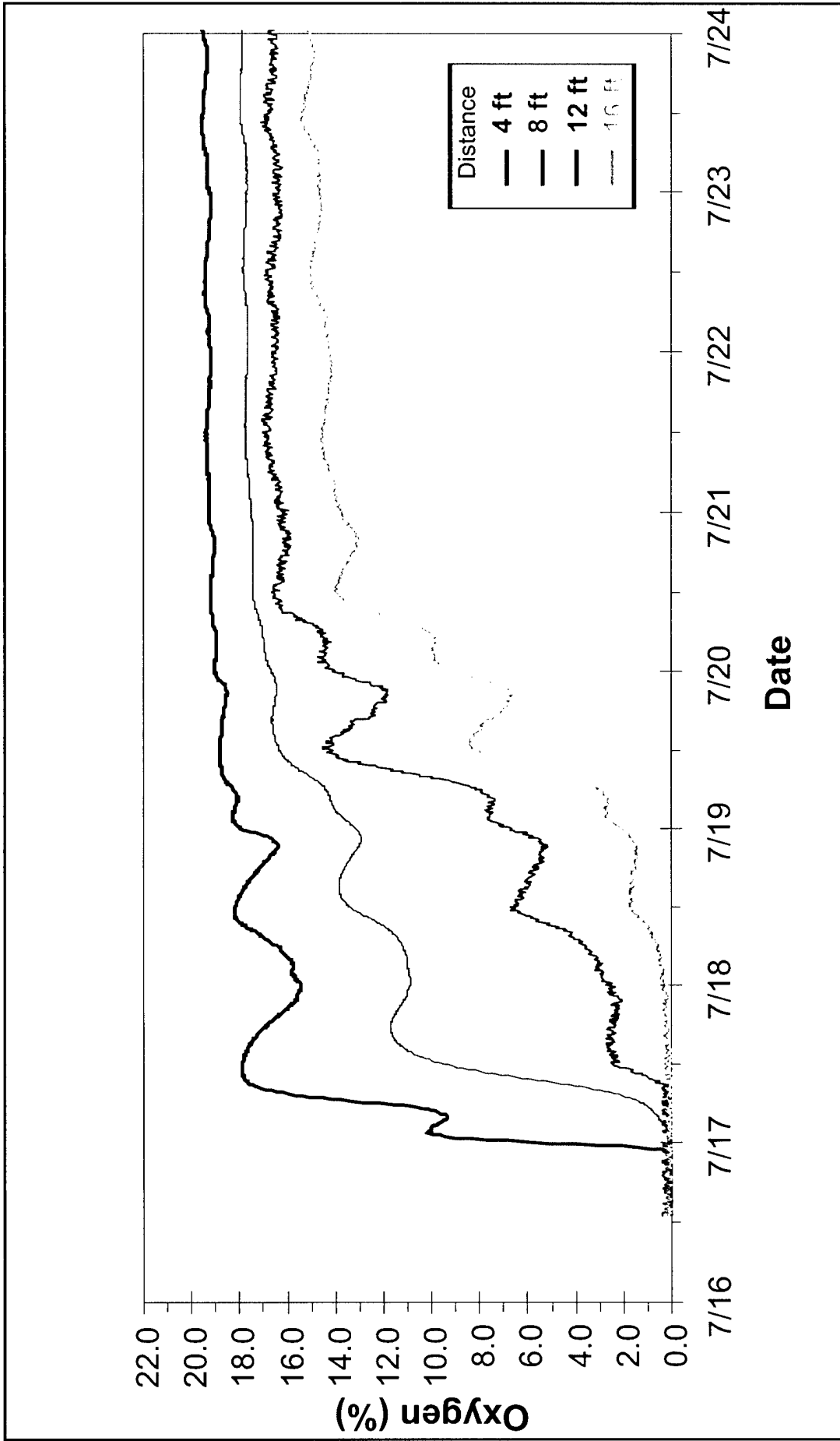

FIGURE 16

OXYGEN RESPONSE AT 30 FEET BGS DURING TEST 4

PFFA
Castle Airport, California

Oxygen concentrations were also sustained at greater than 15% at 60 feet bgs along one of the VMP arms (PFFABOS02 through PFFABOS08), but remained near 0% at a distance greater than 8 feet from the VW along the other arm (PFFABOS01 through PFFABOS07). The most likely explanation for this result is that the 60-foot deep VMP screens were within the capillary fringe and air movement at this depth was restricted by lower air-filled porosities. This explanation is supported by the sometimes erratic differential pressure measurements (fluctuations between the maximum and minimum transducer range) which occurred at these same depths.

Similar to the results from Test 2, the Test 4 results were a positive indication that air flow rates could significantly increase and sustain oxygen concentrations at significant distances from the VW. In order to better estimate the long-term radius of influence from use of the passive valve, Test 4 was continued for seven weeks. Oxygen measurements were then taken at PFFAVMP15, located at 41.5 feet from the VW (Figure 6), following seven weeks of air injection using the passive valve. Oxygen concentrations in PFFAVMP15 at 42 feet bgs increased from 0% at the start of Test 4 to 5.5% at the end of Test 4. Since 5% is typically the oxygen concentration used to indicate that microbial activity is not oxygen limited, this result provides some evidence that a short-term passive bioventing radius of influence is approximately 42 feet at the site.

5.2.5 Tests 5 and 6. At the end of Test 4, an analysis of the data from Test 2 (Section 5.2.2) indicated that a repeat of the configuration used in Test 2 was needed due to weather-related barometric pressure changes. Therefore, Tests 5 and 6 were conducted, which were essentially a repeat of the same conditions of Test 1/Test 3 (VW remained closed) and Test 2 (VW open without the passive valve installed). As during Test 3, oxygen concentrations during Test 5 decreased to 0% within a few weeks. Respiration rates ranged from 0.38% O₂/day to 0.88% O₂/day during Test 5. These respiration rates were somewhat lower, but more consistent from location to location, during this second respiration test compared to Test 2, probably indicating that some reductions in the most biodegradable contaminants occurred during the extended period of air injection during Test 4 and that biomass increases were more consistent from location to location.

A plot of air flow due to changes in barometric pressure during Test 6 is shown on Figure 17. Barometric pressure change was mostly due to diurnal effects rather than weather-front related (compare to Figure 11). Therefore, oxygen response for Test 6 is reflective of that due to regular diurnal changes rather than weather-front related events.

A plot of oxygen concentrations during Test 6 at 30 feet bgs is shown on Figure 18. Although oxygen concentrations increase at all locations at some point during the test period, oxygen concentrations are only sustained above 5% within 8 feet of the VW. Significant fluctuations in oxygen concentration also occur at all locations as the net influx of air is substantially lower without the passive valve. The fluctuations are caused by respiration as well as the reversal of air flow which occurs during decreasing barometric pressure. The air flow reversal causes previously injected air to move back toward the VW and brings in oxygen-depleted air from outside the treatment area. When compared to the oxygen response with the passive valve

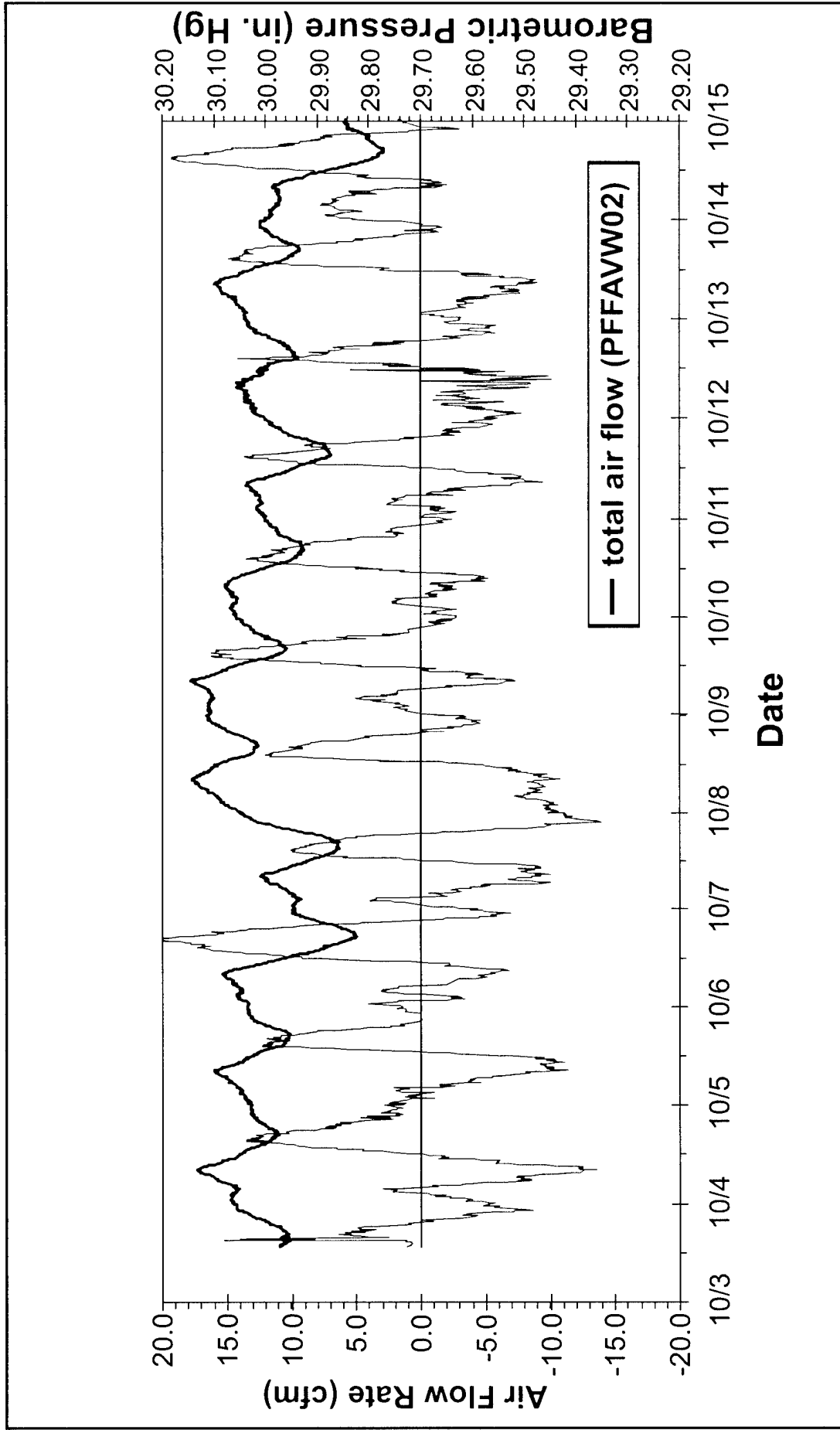

FIGURE 17

AIR FLOW vs. BAROMETRIC PRESSURE DURING TEST 6

PFFA
Castle Airport, California

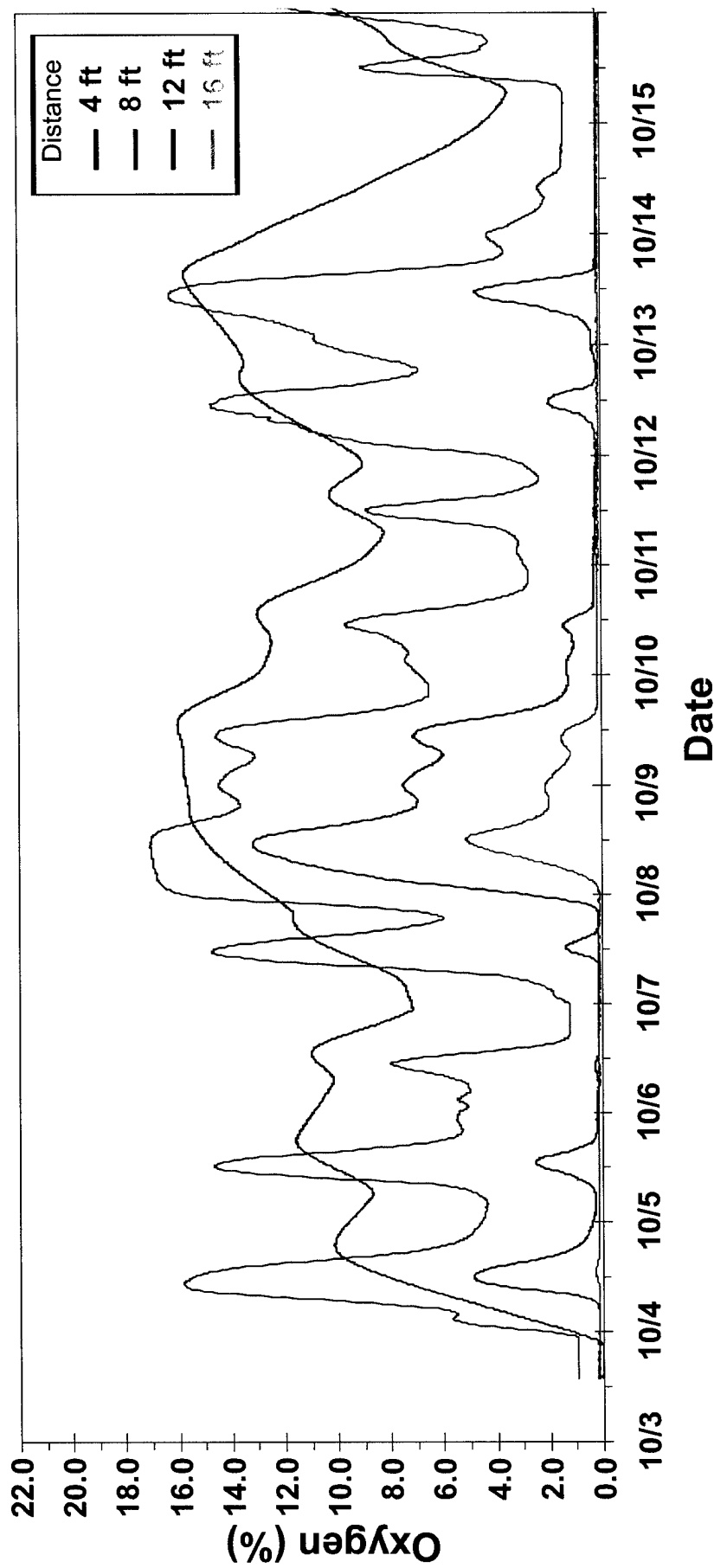

FIGURE 18

OXYGEN RESPONSE AT 30 FEET BGS DURING TEST 6

PFFA
Castle Airport, California

installed during Test 4 (Figure 16), this result clearly indicates the benefit of the passive valve in increasing the radius of influence.

5.2.6 Performance Objectives and Technology Validation. The two performance objectives for the demonstration were: 1) achieving an economical radius of influence, and 2) achieving sufficient air flow rates to meet biological demand (Sections 2.1.5 and 4.1). A discussion of how the demonstration results met the first performance objective, achieving an economical radius of influence, is included in Section 6 (Cost Assessment). A discussion of how the demonstration results met the second objective, achieving air flow rates to meet biological oxygen demand, is partially demonstrated by the increase in oxygen concentrations observed during Test 4 and discussed in Section 5.2.4.

However, both predictions and the associated means of validation also are important to the success of the demonstration. They reflect a transition from previous studies and site characterization data into a successful field demonstration and determine the applicability of the technology at future sites. As discussed in Section 1.3, one of the demonstration objectives is to gather data to support technology implementation and cost assessment at future sites. Comparison of results from this demonstration against predictions comprise the validation plan for this demonstration. If successful, the same prediction methodology could be used at future sites to determine feasibility without time consuming and expensive testing.

The validation plan for this demonstration was to evaluate whether Equation (1) presented in Section 2.3 used for estimating the required air flow rate necessary to meet the maximum oxygen demand can also be used to predict the radius of influence from easily measurable site data. Instead of solving for the required air flow rate (Q) necessary to achieve a pre-determined radius of influence (R_i), Equation (1) can be rearranged and used with measured air flow rates to solve for the radius of influence, R_i , that can be achieved at those measured air flow rates (see Appendix H):

$$R_i = \sqrt{\frac{Q \cdot (C_{\max} - C_{\min})}{\pi \cdot h \cdot k_o \cdot \theta_a}} \quad (2)$$

where:

- R_i = radius of influence [feet]
- k_o = oxygen-utilization rate (*in situ* respiration rate) [%/day]
- Q = volumetric air flow rate [cubic feet per day (cf)]
- θ_a = air-filled porosity [volume air/volume soil]
- h = soil thickness through which air flows [feet]
- C_{\max} = oxygen concentration of background/injected air [%] (typically 20.9%)
- C_{\min} = minimum oxygen concentration for aerobic conditions [%] (typically 5.0%)

Since it is simpler and less expensive to conduct short-term air flow testing at one VW or MW than to measure an unknown, long-term radius of influence using multiple VMPs, validation and prediction using Equation (2) would result in a powerful and cost-effective screening tool for future sites.

The data from Tests 2 and 4 and the associated measured and predicted radius of influence based on Equation (2) for Tests 2 and 4 are provided in Table 6. The air flow used in the equation was the net total air flow into the VW during the tests (*i.e.*, the total air flow into the VW minus the total air flow out of the VW). For the ISR rate, the average ISR rate measured during Test 2 was used. For the thickness of the aerated vadose zone, the length of vadose zone between the bottom of the upper confining layer at 25 feet bgs and the depth to groundwater (60 feet) was used. Air-filled porosity was calculated from the average soil moisture (Table 2) and an estimated total soil porosity of 0.35 (based on site lithologic data) using the calculations provided in the bioventing protocol documents. The methodology could not be used for the data collected during Test 6 because the net air flow during Test 6 was out of the well except during the initial few days of the test.

Table 6
Comparison of Measured vs. Predicted Radius of Influence

Test Number	h, Vadose Zone Thickness (ft)	k_o , Average Oxygen-utilization Rate (%/day)	Length of Test (days)	θ_a Calculated Air-filled Porosity (-)	Q Net Total Air Flow Into VW (cf)	Predicted R_i (ft)	Measured R_i (ft)
Test 2	35	1.0	16	0.27	24,900	29	>16
Test 4	35	1.0	52	0.27	175,000	42	42

The results indicate that Equation (2) was successful in predicting the measured radius of influence. Therefore, use of this equation in combination with ISR data, site lithologic information, soil moisture data, and air flow rates can be used as a screening tool at future sites. Site lithologic information and soil moisture data are readily available at most sites. ISR tests are usually performed at any site undergoing an evaluation of either conventional bioventing or passive bioventing and are inexpensive to conduct. The parameter which is typically not available at potential passive bioventing sites is air flow. However, air flow measurements from an existing or newly constructed VW are also relatively inexpensive to collect, requiring only off-the-shelf components as used during this demonstration (Appendix F). Such testing could be conducted over a period of only a few weeks to determine feasibility and to estimate a radius of influence. If the estimate of a radius of influence is sufficient to make passive bioventing an economic alternative, then additional longer-term or more thorough testing could be conducted.

To evaluate the sensitivity of the predicted radius of influence to soil moisture, the range of moisture contents from the more permeable zones through which air is flowing (see Section 2.3 and Table 2) was used to calculate a range of air-filled porosities using the procedure in Section 1.4 of Volume II from USEPA ORD, 1995. The calculation resulted in a range of air-filled porosity of between 0.20 to 0.33. Air flow data collected during Test 4 was then used

in Equation (2) to calculate a range of predicted radii of influence of between 38 and 49 feet, compared to the 42 feet presented in Table 6. For this site, because soil moisture content is relatively consistent over space for the same lithologic zone, the predicted radius of influence is not particularly sensitive to assumptions used for air-filled porosity. At sites with more variable moisture contents, soil type, or advective air flow regimes, it is recommended that more intensive air flow measurements with depth, more extensive sensitivity analyses, and/or more complex modeling be used to achieve adequate estimates of the predicted radius of influence.

For the Castle site, the more permeable strata were relatively homogeneous as shown on the boring logs included in Appendix C. At other sites, soils may not be relatively homogeneous. Under more heterogeneous conditions, the radius of influence may be larger horizontally but oxygen would not be evenly distributed with depth. In these cases, the predictive model with an appropriate strata thickness should be used to approximate or bound the expected radius of influence. A prudent approach under these conditions would be to start at wider VW spacing based on the bounded radius of influence from the predictive modeling. Vapor monitoring points should also be screened at enough depths and distances to evaluate the oxygen distribution.

A strong correlation between subsurface differential pressure and air flow also was observed during this demonstration (Figure 19). While a correlation was expected based on Bernoulli's equation, additional short-term testing at other sites would be required to determine whether the same correlation exists at other sites and to determine how site characteristics (*i.e.*, permeability, soil moisture) could be used to predict the correlation factor. If the correlation factor could be predicted with some confidence, then only differential pressure measurements would be required to predict air flow rates and the expected radius of influence from a passive approach. Since it is much simpler to measure differential pressure than to measure air flow, this would allow for very inexpensive feasibility testing.

5.3 Technology Comparison

As discussed in Section 2.2 and 2.3, the most valid technology comparison for passive bioventing is to conventional bioventing. Given the similarities between the two technologies and the cost-effectiveness of conventional bioventing, passive bioventing would likely only be considered as an alternative to conventional bioventing rather than compared against other technologies.

The radius of influence from passive bioventing and conventional bioventing is the parameter for evaluating the success of each technology and comparing the two technologies. As discussed in Section 3.2.6, air permeability testing and oxygen influence testing during conventional bioventing pilots tests conducted at the demonstration site indicated that a radius of influence of 110 feet could be expected in the deeper vadose zone soils (those below 25 feet bgs). As discussed in Section 5.2.4, the measured radius of influence from the passive bioventing demonstration was approximately 42 feet.

Air Flow Rate (cfm)

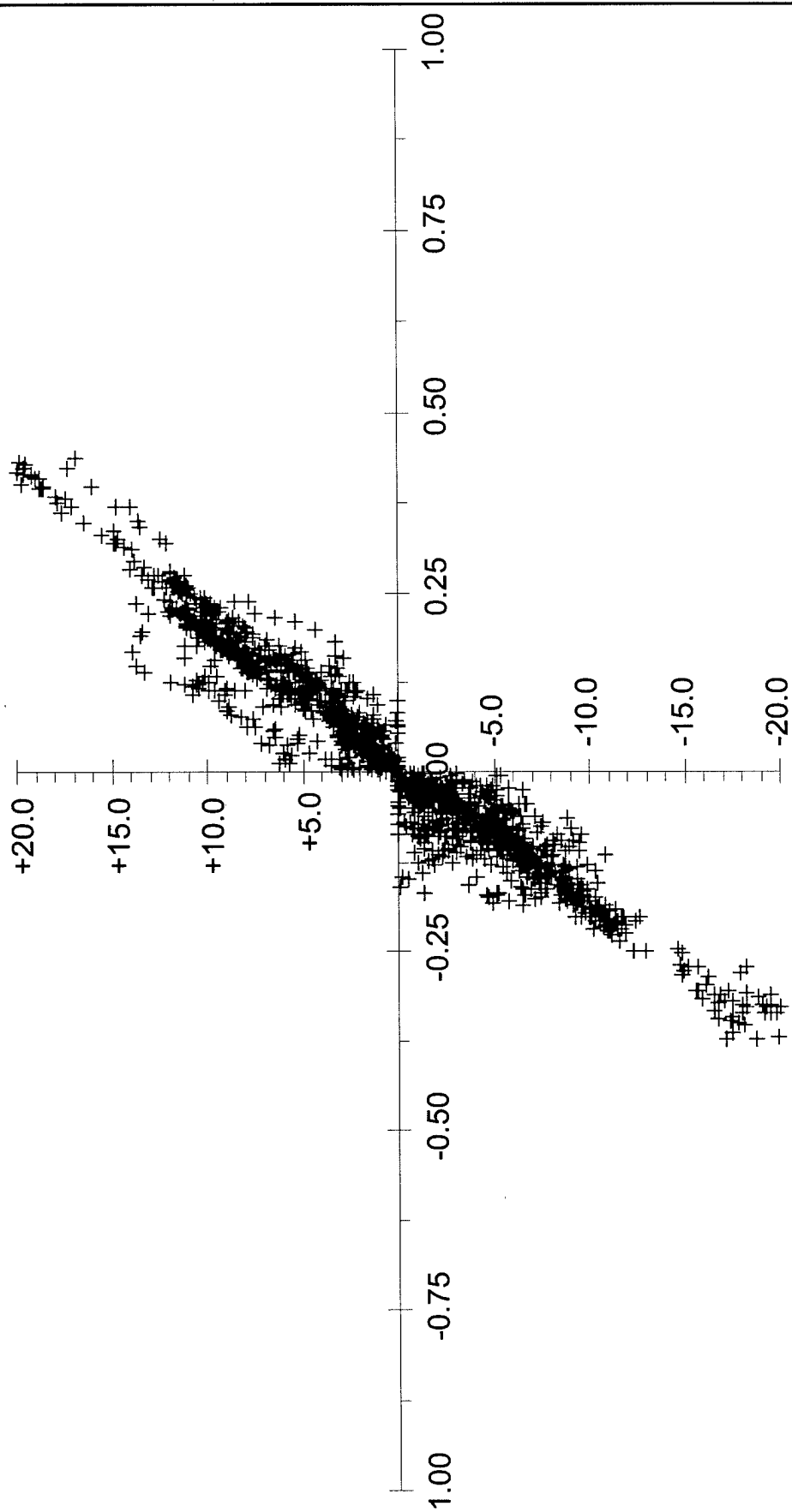

Differential Pressure (in H2O)

FIGURE 19

**AIR FLOW vs. SUBSURFACE
PRESSURE DURING TEST 4**

PFFA
Castle Airport, California

As expected, the passive bioventing radius of influence is significantly smaller than the conventional bioventing radius of influence. However, as discussed in Section 2.3 it is expected that the radius of influence from a passive bioventing system would approach that of a conventional bioventing system over a relatively long time period (on the order of several months, much longer than the period of testing during this demonstration). Although initially the radius of influence will be limited by the microbial demand near the VW, as areas near the VW are remediated and the oxygen demand is satisfied, the radius of influence would expand (*i.e.*, the oxygen-utilization rate would decrease from that shown in Table 6).

For example, if the oxygen-utilization rate dropped from 1.0% O₂/day to 0.25% O₂/day at the PFFA site, the predicted radius of influence would be 85 feet (rather than 42 feet) compared to the conventional bioventing radius of influence of 110 feet (which is primarily limited by induced pressure differences from the blower and vertical air flow components rather than oxygen-utilization rate). A passive bioventing VW design which relied upon this long term radius of influence based on decreasing oxygen-utilization rates would not require a significantly greater number of wells than a conventional bioventing system (approximately 1.5 times as many VWs for the same areal coverage). Results from the AFCEE Bioventing Pilot Test Initiative indicate that decreases in oxygen-utilization rates of this order of magnitude could be expected within 6 months to a year of bioventing. While the expansion of the radius of influence may come at the cost of longer remediation times, the time/cost tradeoff may be acceptable at some sites. More detailed cost comparisons between passive and conventional bioventing are provided in Section 6.

While the estimated radius of influence under declining biodegradation rates can be easily estimated using Equation (2), there are currently no available models, equations, or calculations which can predict the long-term radius of influence based only on soil permeability and the quickly changing and relatively low pressure differentials which occur in passive bioventing. Measuring air flow and oxygen increases with distance and then using Equation (2) to perform sensitivity analysis on the predicted radius of influence under declining biodegradation rates, as described in this section, is likely to be a better approach. The predicted radius of influence using actual air flow rates, biodegradation rates, and soil moisture at a site can then be used to appropriately space the VW and VMP network.

6. Cost Assessment

6.1 Cost Performance

The information included in this section provides an assessment of the expected operational costs for passive bioventing when implemented, not the demonstration costs. For comparison purposes, the expected costs are given for a single site of approximately the same size as the PFFA demonstration area, approximately 115,000 square feet (ft²) or 2.6 acres.

Using the second level work breakdown structure (WBS) coding system detailed in the *Guide to Documenting Cost and Performance for Remediation Projects* (USEPA, 1995), costs for a typical passive and conventional bioventing system for a site of similar size to the demonstration area were estimated. These costs are shown in Table 7 and detailed in Appendix G.

Costs were estimated using the *Bioventing Cost Estimator (BVCE) and User's Guide* (NFESC, 1996), experience from the Bioventing Pilot Test Initiative (Downey *et al.*, 1994), and actual costs incurred during both conventional bioventing pilot testing and demonstration test activities at the PFFA at Castle Airport. The costs include the following activities:

- Data review
- Site visits/planning
- Work plan and report preparation
- Regulatory approval
- Equipment costs
- Initial soil vapor survey
- Pilot testing
- Analytical sampling costs
- Well installation
- Full-scale system installation
- Yearly O&M
- System abandonment

6.2 Cost Performance to Conventional and Other Technologies

For comparison, costs are included in Table 7 for both a conventional bioventing system and a passive bioventing system for the same site. The conventional bioventing system design for the area required 3 VWs, 5 VMPs (3 for the pilot test and 2 additional ones for the full-scale system), and one blower system. An upgrade to the existing electrical system (*e.g.*, new distribution panels and meters) was required for the blower system; however, electrical power itself was already at the site (*i.e.*, the PFFA was not a "remote" site). Trenching and asphalt surface repair for the header pipes to the VWs was also required for the conventional system design.

While the passive bioventing system did not require the blower, electrical system upgrade, or trenching and surface repair, the passive system required 6 VWs instead of the 3 VW-design for the conventional system. The passive design was based on the long-term radius of influence estimate of 85 feet (detailed in Section 5.3) as compared to the 110-foot radius of influence for the conventional system. It was assumed that the number of VMPs would remain the same for both systems since the area treated was the same size. Passive valves were needed for the passive system but not the conventional system; however, the valves are not major cost items.

For O&M purposes, the time period from initial installation to closure sampling was estimated at 3 years for the conventional system based on experience gained during the AFCEE Bioventing Initiative. The time period for remediation for the passive system was estimated at 4 years due to the lower air flow rates. Included in the O&M costs were yearly ISR tests. It was assumed that all other costs (*e.g.*, work plans, administration, regulatory oversight) remained the same for both systems.

As shown on Table 7, a passive bioventing system for this site is very cost-competitive with the conventional bioventing system design. The total cost (approximately \$283,000) and unit cost (approximately \$1.90 per cubic yard) are somewhat lower for the passive system even though it

TABLE 7
Cost Comparison
Passive Bioventing vs. Conventional Bioventing

WBS	Description	Unit Cost		Passive Bioventing		Conventional Bioventing		Cost Basis
		(\$)	Units	Units	Cost (\$)	Units	Cost (\$)	
BEFORE TREATMENT COST ELEMENTS								
33-01	Mobilization and Preparatory Work							
	Design costs	28,400	each	1	28,400	1	28,400	NFESC, 1996
	Health and Safety Plan	10,000	each	1	10,000	1	10,000	NFESC, 1996
	Pilot-Scale Work Plan	10,000	each	1	10,000	1	10,000	NFESC, 1996
	Full-Scale Remedial Action Work Plan	25,000	each	1	25,000	1	25,000	NFESC, 1996
	Quality Assurance Plan	10,000	each	1	10,000	1	10,000	NFESC, 1996
	SUBTOTAL				\$ 83,400		\$ 83,400	
33-02	Monitoring, Sampling, Testing, and Analysis							
	Fixed sampling and testing equipment	7,870	each	1	7,870	1	7,870	NFESC, 1996
	Soil gas survey	8,635	each	1	8,635	1	8,635	Gregg Drilling
	Pilot testing (incl. drilling but not analytical costs)	25,949	each	1	25,949	1	25,949	NFESC, 1996
	Soil analysis (during pilot & full-scale install)	104	sample	35	3,649	35	3,649	NFESC, 1996
	Soil vapor analysis (during pilot & full-scale install)	130	sample	14	1,820	14	1,820	NFESC, 1996
	SUBTOTAL				\$ 47,923		\$ 47,923	
33-03	Site Work							
	Trenching	16	foot	0	-	850	13,600	Marcor
	Electrical Utilities	3,000	total	0	-	1	3,000	Atwater Electric
	SUBTOTAL				\$ -		\$ 16,600	

TABLE 7 (continued)

Cost Comparison

Passive Bioventing vs. Conventional Bioventing

WBS	Description	Unit Cost (\$)		Passive Bioventing		Conventional Bioventing		Cost Basis
		(\$)	Units	Units	Cost (\$)	Units	Cost (\$)	
TREATMENT COST ELEMENTS								
33-11	Biological Treatment							
	Operations & maintenance (passive)	1,998	yr	4	7,992	0	-	NFESC, 1996
	Operations & maintenance (conventional)	11,113	yr	0	-	3	33,339	NFESC, 1996
	Follow-up respiration testing	4,569	yr	2	9,138	2	9,138	NFESC, 1996
	Passive valves	149	each	6	894	0	-	Nisei/Ryan Herco
	Field instrument rental	1,760	total	1	1,760	1	1,760	Hazco
	Blower system	4,162	each	0	-	1	4,162	NFESC, 1996
	VW installation (full-scale, but not pilot test)	5,946	each	5	29,730	2	11,892	NFESC, 1996
	VMP installation (full-scale, but not pilot test)	5,720	each	2	11,440	2	11,440	NFESC, 1996
	SUBTOTAL				\$ 60,954		\$ 71,731	
AFTER TREATMENT COST ELEMENTS								
33-21	Demobilization							
	Well abandonment	17	foot	715	12,155	520	8,840	Gregg Drilling
	Closure soil sampling	75	sample	18	1,350	18	1,350	NFESC, 1996
	Closure soil vapor sampling	130	sample	9	1,170	9	1,170	NFESC, 1996
	Final Report	50,000	each	1	50,000	1	50,000	NFESC, 1996
	SUBTOTAL				\$ 64,675		\$ 61,360	
33-9X	Other Costs							
	Contingency	26,200	each	1	26,200	1	26,200	NFESC, 1996
	SUBTOTAL				\$ 26,200		\$ 26,200	
TOTAL COST					\$ 283,152		\$ 307,214	
COST PER CUBIC YARD TREATED					\$ 1.93		\$ 2.09	

required twice as many VWs to cover the same area. This estimate shows that with an adequate radius of influence, the cost to install more VWs with a passive system can be more than offset by the costs to install a blower, electrical power, and trenching and piping and to operate and maintain a conventional bioventing blower system. The yearly power costs alone for the blower are approximately \$5,000, while the cost to install the trenching and piping at such a large, asphalted site with many subsurface utilities was approximately \$14,000. These savings along with other yearly O&M savings more than make up for the costs to install additional VWs and operate the system for a longer period of time.

While the costs are lower, the time period for remediation with the passive system is longer (4 years compared to 3 years) which may not be acceptable at some sites. This time period extension was primarily needed due to the use of a design radius of influence based on declining respiration rates, as discussed in Section 5.3. For comparison, if the time period for remediation is kept identical with both systems and a design radius of influence of 42 feet is used for the passive system (the demonstrated radius of influence after only seven weeks), the cost of installing the passive bioventing system would increase by approximately \$21,000 due to the need for 9 VWs instead of 6. O&M costs would decrease somewhat (approximately \$2,000) due to the need for fewer yearly ISR tests. Using these assumptions, the cost of the passive system would then be only \$5,000 lower than for the conventional system.

The reduction in cost if conventional bioventing takes only 2 years instead of 3 years is \$11,113 (Table 7, Operations & Maintenance costs for conventional system). This amount is still less than the total cost differential between the 2 options (\$24,062 as shown in Table 7) using the 85-foot radius of influence estimate. However, it is greater than the total cost differential if the conservative 42-foot radius of influence is used (\$5,000). Therefore, if the conventional system is operated for only 2 years and a conservative 42-foot radius of influence is used, then a conventional approach is more cost effective than a passive approach. However, a passive system designed using the conservative 42-foot radius of influence estimate might also need to be operational for a reduced period of time, offsetting some of this cost differential.

Clearly, the time for operating the conventional system and the estimate for a long-term radius of influence are the most cost-sensitive parameters for the Castle site. A similar cost comparison should be done for any site which evaluates the magnitude of the total cost differential against other fixed or recurring costs of a similar magnitude (*e.g.*, yearly O&M costs). In addition, sensitivity analysis should be performed on those parameters which significantly affect the total cost (*e.g.*, radius of influence estimate). It is important to emphasize that sites other than Castle may have significantly different sensitivities to cost, although the radius of influence estimate is likely to be the most sensitive for almost all sites because it affects well spacing and capital costs for well installation.

In general, the point at which the cost to install any additional VWs under a passive bioventing approach offsets the blower capital and O&M costs under a conventional bioventing approach will be site-specific and dependent upon:

- differences in the radius of influence between conventional and passive bioventing;
- cost to install electric power;
- local utility costs;
- drilling costs (affected primarily by contamination depth, soil type, and location); and,
- the time frame needed to achieve remedial goals.

The most difficult factor listed above to currently predict is the difference in radius of influence between conventional bioventing and passive bioventing. An empirical relationship was developed as part of the U.S. Air Force Bioventing Initiative to relate pressure response from a short one-day air permeability test to radius of influence for conventional bioventing design purposes (see Section 1.5 of Volume II from USEPA ORD, 1995). Site cleanup times are also difficult to predict, even with conventional bioventing, but are primarily a function of the microbial respiration rate, achievable air flow, contaminant concentrations, and soil porosity (see Section 1.4 and Section 3 of Volume II from USEPA ORD, 1995). Therefore, simple inexpensive tests (air permeability and *in situ* respiration tests) are already available to predict the conventional radius of influence and monitor site cleanup progress.

The only factor remaining is the radius of influence for the passive system. As discussed in Section 5.2.6, the demonstration data supports the use of short-term natural air flow measurements and a recasting of Equation (1) as presented in Section 2.2 of Volume II from USEPA ORD, 1995 (where it is used to size blower systems) to determine a radius of influence for a passive system. The demonstration study's validation of this equation to predict the radius of influence, and therefore estimated costs, for a passive bioventing system is a significant success. Therefore, using relatively inexpensive, short-term air flow measurements alone, a cost comparison between passive and conventional bioventing can now be conducted with some confidence.

At sites where nutrients are limiting biodegradation rates or can be shown to significantly decrease cleanup time, a passive approach might be less cost effective due to the inability to add nutrients under a passive approach. However, the USEPA ORD protocol concludes, based on previous studies, that nutrients are generally not limiting biodegradation at most sites. An equation is provided in the protocol for comparing microbial nutrient requirements with available nitrogen and phosphorus in site soils. Data from the Castle soils (on the order of 30 to 60 mg/kg nitrogen and 200 mg/kg phosphorus) were compared with the nutrient requirements from the protocol (10 mg/kg nitrogen and 1 mg/kg phosphorus) which confirmed that nutrients are unlikely to be rate limiting at Castle.

7. Regulatory Issues

7.1 Approach to Regulatory Compliance and Acceptance

For the passive bioventing demonstrations at the PFFA, the lead regulatory agency was the State of California Regional Water Quality Control Board (RWQCB), Central Valley Region. Other

regulatory agencies providing secondary oversight due to their responsibilities for the Castle Airport facility were the U.S. Environmental Protection Agency (USEPA) and the State of California Department of Toxic Substances Control (DTSC).

The regulators were kept informed of demonstration test activities through periodic presentations made at the monthly Remedial Project Managers (RPM) meetings conducted by the Air Force Base Conversion Agency (AFBCA) located at Castle Airport. The regulators were supportive of the demonstration activities as a complement to ongoing conventional bioventing testing and implementation. There were no significant regulatory obstacles or impacts on schedule due to regulatory review.

Although a residential advisory board (RAB) is in place at Castle Airport and holds regular monthly meetings coinciding with the regular RPM meetings, to date there has not been any public participation or involvement in the demonstration. This is primarily due to the limited time of members of the RAB and their priorities for other sites at the Castle Airport facility.

8. Technology Implementation

8.1 DoD Need

The most recent USEPA estimates of the number of DoD sites that may have POL contamination in soil requiring cleanup is approximately 2,000 sites (USEPA, 1997). This total number of sites is based on the number of site types that would be expected to have predominantly POL contamination (*i.e.*, USTs, fire/crash training areas, ASTs, POL distribution lines, oil/water separators, maintenance yards, and washracks). Assuming that at least half of these sites could benefit from a passive approach (either exclusively or as a longer-term, follow-up technology to either SVE or conventional bioventing), a total savings of approximately \$25 million could be realized based on an average per site savings of \$25,000. Not included in this estimate is the cost for remote sites, which while relatively fewer in number could require costs in excess of \$100,000 each just to bring in the required electrical power. If it is assumed that even 5% of the applicable sites require such a significant power expense, then an additional savings of \$10 million savings (\$35 million total) could be realized.

The estimate given above is also conservative because it does not include the number of sites with chlorinated solvent contamination in soil which might benefit from passive soil vapor extraction, a companion technology which is based on the same principles and for which much higher treatment costs, and hence cost savings, could be realized.

8.2 Transition

In order to continue the transition and implementation of passive bioventing, the following steps are recommended:

- 1) Longer-term radius of influence testing. Although results from this demonstration clearly indicated the validity of using existing equations for predicting a radius of influence for passive bioventing in the short-term (*i.e.*, on the order of weeks), more extensive testing is needed to determine whether the radius of influence from passive bioventing can approach a conventional bioventing radius of influence over the long term (*i.e.*, on the order of months or years).
- 2) Additional short-term demonstrations to verify technology application. Although results from this demonstration clearly indicated that the technology is applicable under shallow groundwater and stratified-soil conditions, all of the previous passive bioventing demonstrations have been conducted in the western U.S. It is recommended that additional short-term demonstrations be conducted in the eastern and midwestern U.S., where site characteristics are potentially quite different (*e.g.*, soil moisture and type, barometric pressure changes). Since air flow and subsurface differential pressure have been shown to be good predictors of radius of influence, these short-term tests could be conducted very inexpensively using existing VWs or MWs and portable remote monitoring equipment.
- 3) Technology Transfer. The success of the demonstration and techniques which can be used to predict a passive bioventing radius of influence need to continue to be transferred to DoD, DOE, and private industry. The previously-submitted user data package is expected to significantly assist with this technology transfer.

In addition to the user data package, as of the date of this report results from the demonstration have been presented at four conferences (Third Tri-Service Environmental Technology Workshop, August 1998; Partners in Environmental Technology, December 1998; Water Environment Federation's WEFTECH '99, October 1999; National Ground Water Association's Petroleum Hydrocarbons Conference, November, 1999). Papers were submitted for publication in the proceedings for these conferences, one of which is available on the internet (<http://aec-www.apgea.army.mil/prod/usaec/et/etw/07.htm>).

An article was also published in the Summer 1998 edition of NFESC's Remedial Project Manager's newsletter *RPM News*. The Naval Facilities Engineering Command has recently published a TechData Sheet (NAVFAC, 2000). Presentation and discussion of results are also planned in the future at additional meetings, conferences, and teleconferences of the Alternative Restoration Technology Team (ARTT), the Tri-Service Environmental Working Group, the Clean-up Review Tiger Team, and the Installation Restoration Program.

All of the above actions are planned for implementation in 2000/2001 by the points of contact provided in Appendix A.

9. Lessons Learned

The following lessons were learned during implementation of this demonstration:

- 1) Difficulty of site selection. Site selection for this demonstration was a time-consuming process. Reasons for this included:
 - a) Initially focusing on sites which appeared to have very limited application of the technology (*i.e.*, tidally-influenced sites).
 - b) Limited information was often available to adequately screen sites with a degree of confidence that the site would meet the demonstration objectives (*i.e.*, have adequate air flow). Therefore, additional time was spent visiting multiple candidate sites and collecting pre-demonstration data (*e.g.*, air flow).

Partnering can help to overcome site selection difficulties by providing access to personnel and resources which would otherwise be unavailable.

Another, but nevertheless important, factor which made site selection difficult was that petroleum sites are now often considered "low priority" sites or often have undergone some degree of remediation. Notably, in contrast to this deficiency as a demonstration site characteristic, these sites could be excellent candidates for sites where conventional systems could be turned off in favor of long-term operation in a passive mode.

2. Radius of influence estimate and long-term radius of influence. Equation (2) presented in Section 5.2.6 was successful in predicting a short-term radius of influence based on air flow measurements, ISR test data, and soil moisture and soil porosity data. However, depending on the time frame required to reach site cleanup, well spacing may be better based on the expected long-term radius of influence under declining biodegradation rates. Additional demonstrations should be run over a longer period of time to determine if the radius of influence for a passive system approaches that measured by a conventional bioventing pilot test.
3. Correlation of air flow to subsurface differential pressure. As shown on Figure 19, there was a strong correlation between air flow and subsurface differential pressure at the PFFA site. Additional short-term testing at other sites should be done to determine whether the same correlation exists at other sites and to determine how site characteristics (*i.e.*, permeability, soil moisture) could be used to predict the correlation factor. If the correlation factor could be predicted with some confidence, then only differential pressure measurements would be required to predict air flow rates and the expected radius of influence from a passive approach. Since it is much simpler to measure differential pressure than to measure air flow, this would allow for very inexpensive feasibility testing.

4. Passive valve construction. As discussed in Section 4.2.5, the passive valve originally was constructed using single-cell foam rubber for the internal seal and it did not perform as well as mylar. If the design shown on Figure 4 is used, mylar should be used for the seal. In addition, users should note that a passive valve called the "BaroBall", developed by Savannah River Site researchers, is now commercially available (Durham Geo-Enterprises, Stone Mountain, GA, 770-465-7557). The BaroBall valve was not evaluated or used during this demonstration.
5. Oxygen sensors. The directly-buried oxygen sensors provided good quality data and were relatively simple to install using standard hollow-stem auger techniques. It is strongly recommended that the sensors with the integrated pressure measurement and sampling port (as used during this demonstration) also be used for any future installations since it allows for soil vapor samples to be collected. These oxygen sensors may also be very cost-competitive at conventional bioventing sites because, with the use of a data logger, ISR tests can be performed unattended.
6. Verticality of boreholes. The verticality measurements indicated that deviations of as much as 1 to 2 feet could be expected at borehole depths of 50 to 60 feet bgs using hollow stem auger techniques. This information should be used to determine if verticality measurements are required at sites where precise radius of influence measurements are needed.
7. Relative humidity. Relative humidity measurements were not collected during this demonstration. It should be added to the list of measured parameters for future passive bioventing demonstrations so that the relationship between relative humidity, ambient temperature, and barometric pressure changes can be evaluated.
8. Reduced iron and ORP. Although the reduced iron and ORP measurements were of some use during the demonstration, since these are measurements not typically collected at bioventing sites, there is not a large data set against which to compare the results. The data collected during this demonstration indicated that despite very anaerobic conditions, the potential for significantly reduced iron or highly reduced soils to exert a significant oxygen demand was relatively low.

10. References

1. AFCEE, 1996. *A General Evaluation of Bioventing for Removal Actions at Air Force/Department of Defense Installations Nationwide*, June.
2. Air Force Center for Environmental Excellence (AFCEE), 1992. *Test Plan and Technical Protocol for a Field Treatability Test for Bioventing*, May.

3. Battelle, 1995. *Report on Passive Bioventing Driven by Natural Air Exchange at the Hill Air Force Base Site 280*, Prepared for Hill AFB, Utah by Dean Foor and Robert E. Hinchee. October 27, 1995. Contract No. DAAL03-91-C-0034, Task No. 92-445.
4. Downey, D.C., and Hall, J. F., 1994. *Addendum One to Test Plan and Technical Protocol for a Field Treatability Test for Bioventing - Using Soil Gas Surveys to Determine Bioventing Feasibility and Natural Attenuation Potential*. Prepared for AFCEE, Brooks AFB, San Antonio, Texas.
5. Downey, D.C., Hall, J.F., Miller, R.N., Leeson, A., Hinchee, R.E., 1994. *Bioventing Performance and Cost Summary*. Prepared for AFCEE, Brooks AFB, TX. February.
6. Foor, D.C., Zwick, T.C., Hinchee, R.E., Hoepfel, R.E., Kyburg, C., Bowling, L., 1995. *Passive Bioventing Driven by Natural Air Exchange*. In *Situ Aeration: Air Sparging, Bioventing and Related Remediation Processes*. Battelle Press.
7. Jacobs Engineering Group Inc. (Jacobs), 1995. *Castle Air Force Base Comprehensive Basewide Remedial Investigation/Feasibility Study - Part 1. Volume 1 of 3 Groundwater Remedial Investigation Report (Draft Final)*, Castle AFB, California. Prepared for AFCEE, Brooks AFB, TX. December.
8. Leeson, A., and Hinchee, R.E., 1997. *Soil Bioventing: Principles and Practices*. CRC Press.
9. Lovley, D.R. and Phillips, E.J., 1987. *Rapid Assay for Microbially Reducible Ferric Iron in Aquatic Sediments*, *Applied and Environmental Microbiology*, 53(7), 1536.
10. Massman, J. and Farrier, D.F., 1992. *Effects of Atmospheric Pressures on Gas Transport in the Vadose Zone*, *Water Resources Research*, Vol. 28, No. 3. March
11. Miller, R.N., 1990. *A Field Scale Investigation of Enhanced Petroleum Hydrocarbon Biodegradation in the Vadose Zone Combining Soil Venting as an Oxygen Source with Moisture and Nutrient Additions*. Ph.D. Dissertation, Utah State University, Logan, Utah.
12. Miller, R.N., Downey, D.C., Carmen, V.A., Hinchee, R.E., Leeson, A., 1993. *A Summary of Bioventing Performance at Multiple Air Force Sites*. In: *Proceedings NGWA/API Conference on Petroleum Hydrocarbons and Organic Chemicals in Ground Water: Prevention, Detection, and Restoration*. Houston, Texas.
13. Miller, R.N., Vogel, C.C., Hinchee, R.E., 1991. *A Field-Scale Investigation of Petroleum Hydrocarbon Biodegradation in the Vadose Zone Enhanced by Soil Venting at Tyndall AFB, Florida*. In: R.N. Hinchee and R.F. Olfenbuttel (eds.), *In Situ Bioreclamation*. Butterworth-Heinemann, Stoneham, Massachusetts, pp. 283-302.
14. National Ground Water Association, 1999. *Passive Bioventing in Stratified Soils and Shallow Groundwater Conditions*, *Proceedings of the Petroleum Hydrocarbons and Organic*

Chemicals in Ground Water, Prevention, Detection, and Remediation Conference, November 17-19, 1999, Houston, Texas. p. 291

15. Naval Facilities Engineering Command (NAVFAC), 2000. *Passive Bioventing in Stratified Soils and Shallow Groundwater Conditions*, TechData Sheet TDS-2083-ENV. August
16. Naval Facilities Engineering Service Center (NFESC), 1996. Technical Memorandum TM-2188-ENV, *Bioventing Cost Estimator (BVCE) and User's Guide*. June http://erb.nfesc.navy.mil/erb_a/restoration/technologies/remed/bio/BVCE.XLS
17. NFESC, 1997. *Final Technology Demonstration Plan (Revision 2), Natural Pressure-Driven Passive Bioventing*. Prepared for Environmental Security Technology Certification Program (ESTCP). October
18. NFESC, 1998. *Draft Technology Demonstration Plan, Site-Specific Addendum, Natural Pressure-Driven Passive Bioventing*. Prepared for ESTCP. January
19. Parsons ES, 1997a. Report To Lawrence Livermore National Laboratory On A Risk-Based Remediation of the Petroleum, Oils, and Lubricants Fuel Farm Area (PFFA), Castle Airport, California. Prepared for AFCEE, Technology Transfer Division, Brooks AFB, San Antonio, TX and Air Force Base Conversion Agency, Castle Airport, California. August
20. Parsons ES, 1997b. Bioventing Pilot Test Work Plan for the Petroleum, Oils, and Lubricants Fuel Farm Area (PFFA), Castle Airport, California. Prepared for AFCEE, Technology Transfer Division, Brooks AFB, San Antonio, TX and Air Force Base Conversion Agency, Castle Airport, California. December
21. Parsons ES, 1998. Risk-Based Remedial Action Plan for the Petroleum, Oils, and Lubricants Fuel Farm Area (PFFA), Castle Airport, California. Prepared for AFCEE, Technology Transfer Division, Brooks AFB, San Antonio, TX and Air Force Base Conversion Agency, Castle Airport, California. September
22. Pirkle, R.J., Wyatt, D.E., Price, V., and Looney, B.B., 1992. *Barometric Pumping: The Connection Between the Vadose Zone and the Atmosphere*. The Focus Conference on Eastern Regional Ground Water Issues.
23. Rossabi, J., Looney, B.B., Eddy Dilck, C.A., Riha, B., and Rohay, V.J., 1993. *Passive Remediation of Chlorinated Volatile Organic Compounds Using Barometric Pumping*. Westinghouse Savannah River Company (WSRC-MS-93-615), DOE Contract No. DE-AC09-89SR18035.
24. Rossabi, J., Riha, B.D., Vanpelt, R.S., Kmetz, T., Pemberton, B., 1998. *Passive Soil Vapor Extraction for Interim Remediation at the Savannah River Site*, Physical, Chemical, and Thermal Technologies, Remediation of Chlorinated and Recalcitrant Compounds. Battelle Press.

Appendix B

Data Archiving and Demonstration Plan(s)

Electronic data from the demonstration have been included in Appendix D, including data from the testing as well as an electronic version of this report.

A copy of the technology demonstration plans and all other supporting material can be obtained by contacting either the principal investigator or the external contractor point of contact listed in Appendix A. To prevent problems associated with personnel changes, a copy of all demonstration plans, this report, and all electronic data in Appendix D will also be archived in the NFESC Technical Library and in the internal file archive of the external contractor (Parsons). These file archives are specifically designed and administered to allow access to project materials in the event of personnel changes. The Parsons archive will also contain all other project supporting material (*e.g.*, field notebooks, correspondence, subcontractor data). The reference number (also called the job number) for the internal file archive at Parsons is 731272.

Appendix C
Boring Logs, Well Construction Details,
Cone Penetrometer Logs, and Borehole Verticality Survey

BORING NUMBER: PFFAVW02

PROJECT NUMBER: 731272	PROJECT NAME:
CLIENT: NFESC	Navy Passive Bioventing Demonstration
LOCATION: PFFA Castle Airport, CA	DRILLER: Gregg Drilling
LOGGED BY: Marcus Pierce	DRILLING METHOD: hollow-stem auger
COMPLETION DATE: 3/24/98	HOLE DIAMETER: 11"
	TOTAL DEPTH: 65.5'

DEPTH (feet)	GW ELEVATION	SAMPLE NUMBER	SAMPLE LOCATION Background/Breathing Zone (PID)	Headspace Screening Sample (PID/TVH)	BLOW COUNT	USCS SOIL CLASS	GEOLOGIC DESCRIPTION
0							Cobbly Sand Fill
0-5			NS		2/30	SM	SAND, silty, fine-grained, moist, Dark yellowish Brown, 10YR-3/4
5-10			NR		5/40	ML	Same as above, color change to 5Y-5/2, olive-gray, abundant mica flakes, no HC odors, very dense
10-15			NR		5/40	SM	As above 1-8', dense
15-18					4/40	ML	SILT, sandy, fine, moist to saturated, no HC odors, hard caliche at 16.0-16.1, 5Y-5/2
18-25			NS		4/40	SM	SAND, silty, fine, dry to slightly moist, dense 10YR-3/4
25-19					19	SP	SAND, medium, abundant mica flakes, slight HC odor, moist, 5Y-5/4 olive
19-26					26	ML	SILT, sandy, some clay (5-15%), moist, slight HC odor
26-19					19	ML	Clayey SILT, damp to moist, cemented, no HC odor, chart 2 for GLEY 6/1, Interbeds of clayey SILT and silty SAND, fine 3-6"
19-25					4/60	ML	Silty SAND Same as above 1-8'
25-30					11 15 21		
30		PFFAVW02-1 1300 (29-30')			6 10 12	SP	SAND, fine, damp, moderate HC odor, partially cemented, pale olive grey 5Y-6/2, mica flakes (see next page)

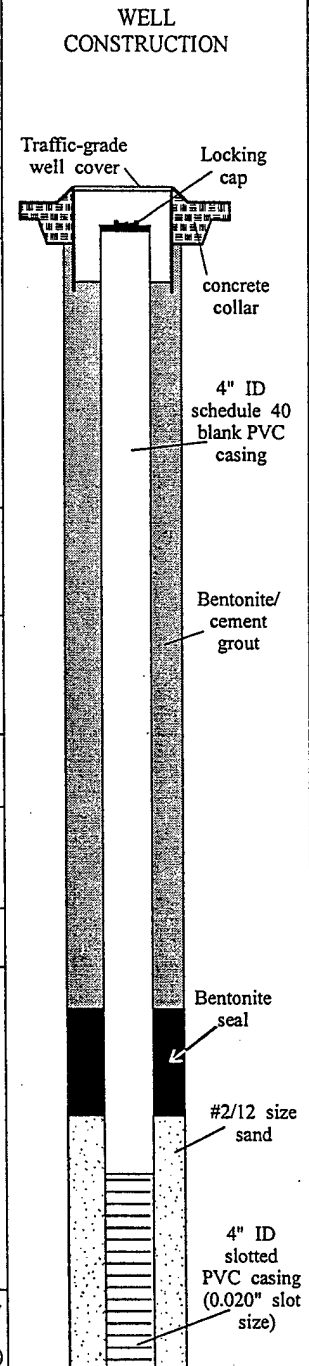

- ▽ - First encountered groundwater.
- - Contact location.
- - Shading indicates percent recovery in sampler.
- ▽ - Equilibrated groundwater level.
- - Approximate contact location.
- NR - Not Recorded
- - Drive sample.

Blow counts are of a 140 lb. Hammer on a 2.5" outside diameter split spoon sampler

BORING NUMBER: PFFAVW02

PROJECT NUMBER: 731272		PROJECT NAME:	
CLIENT: NFESC		Navy Passive Bioventing Demonstration	
LOCATION: PFFA Castle Airport, CA		DRILLER: Gregg Drilling	
LOGGED BY: Marcus Pierce		DRILLING METHOD: hollow-stem auger	
COMPLETION DATE: 3/24/98		HOLE DIAMETER: 11"	
		TOTAL DEPTH: 65.5'	

DEPTH (feet)	GW ELEVATION	SAMPLE NUMBER	SAMPLE LOCATION Background/Breathing Zone (PID)	Headspace screening Sample (PID/TVH)	BLOW COUNT	USCS SOIL CLASS	GEOLOGIC DESCRIPTION
30					8		
35				600/640	9 10	ML/CL	SILT, very clayey, damp, strong HC odor, pale olive 5Y-6/3
40				800/10,000	28 34 50-4"	SP	SAND, fine, some silt 5-15%, damp to dry, HC odor, light olive grey 5Y-6/2
45		PFFAVW02-2 1330 (44.5-45.5')	NS 0-6 Not sustained	850/5,100	9 15 22		Same as above, slightly coarse, exactly like 30' sample
50			NS 0-30 Reposition Rig	2000/4500	- -		Same as above, some portions are silty
55			NS 0-2	440/720	11 14 21		Same as above, no silty portions
60		PFFAVW02-3 1515 (59-60.5')	NS	- - -	9 18 20		Same as above

WELL CONSTRUCTION

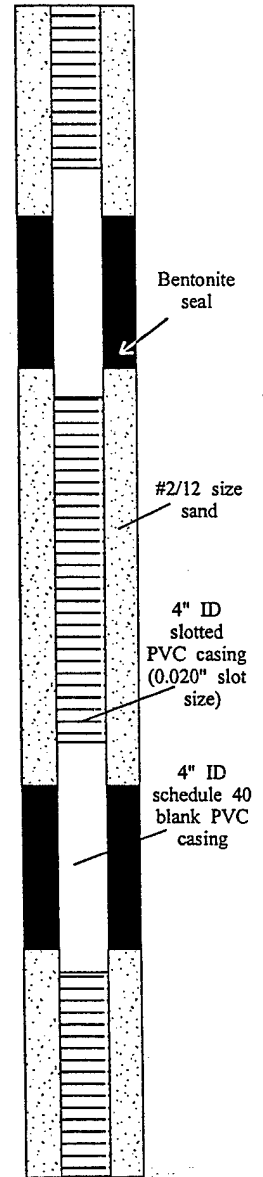

- ▽ - First encountered groundwater.
- - Contact location.
- - Shading indicates percent recovery in sampler.
- ▽ - Equilibrated groundwater level.
- - Approximate contact location.
- NR - Not Recorded
- - Drive sample.

Blow counts are of a 140 lb. Hammer on a 2.5" outside diameter split spoon sampler

BORING NUMBER: PFFAVW02

PROJECT NUMBER: 731272		PROJECT NAME:	
CLIENT: NFESC		Navy Passive Bioventing Demonstration	
LOCATION: PFFA		DRILLER: Gregg Drilling	
Castle Airport, CA		DRILLING METHOD: hollow-stem auger	
LOGGED BY: Marcus Pierce		HOLE DIAMETER: 11"	
COMPLETION DATE: 3/24/98		TOTAL DEPTH: 65.5'	

DEPTH (feet)	GW ELEVATION	SAMPLE NUMBER	SAMPLE LOCATION Background/ Breathing Zone (PID)	Headspace screening Sample (PID/TVH)	BLOW COUNT	USCS SOIL CLASS	GEOLOGIC DESCRIPTION
60	▽		NS			SP	
65			0-3	156/ 210	10 18 25	SW	SAND, medium to coarse, occasional silty layers 1-2" thick, saturated, dense, mica flakes, olive 5Y-5/3
							Bottom of boring 65.5 feet
70							
75							
80							
85							
90							

WELL CONSTRUCTION

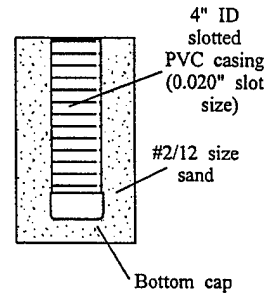

- ▽ - First encountered groundwater.
- ▽ - Equilibrated groundwater level.
- - Contact location.
- - Approximate contact location.
- - Shading indicates percent recovery in sampler.
- NR - Not Recorded
- - Drive sample.

Blow counts are of a 140 lb. Hammer on a 2.5" outside diameter split spoon sampler

BORING NUMBER: PFFAVW01

PROJECT NUMBER: 731297	PROJECT NAME: Castle AFB
CLIENT: AFCEE	Risk-Based Remediation
LOCATION: PFFA	DRILLER: West Hazmat
Castle Air Force Base, California	DRILLING METHOD: HSA
GEOLOGIST: JFH/MLP	HOLE DIAMETER: 10"
COMPLETION DATE: 12/16/97	TOTAL DEPTH: 34'

DEPTH (feet)	GW ELEVATION	SAMPLE NUMBER	SAMPLE LOCATION	Headspace Screening		BLOW COUNT	USCS SOIL CLASS	GEOLOGIC DESCRIPTION
				Background/Breathing Zone (PID)	Sample (PID)			
0						32		6" Asphalt, road base
				0/2	0/2	23		Sand, f-md, md brn, v. moist, tr. clay, silt no odor
						19		
5				0/0	0/0	35	SP	Sand, v.f.-md, md brn, moist, tr. silt, no odor
				0/0	0/0	50		SAA no odor, grey & brn
						60		SAA abundant micas
						18		
						30	ML	SILT, moist, clay (<10%), micas, f. sand (<10%), olive green to grey
						42		
10				0/10		18	SM	Silty SAND (SM), fine sand, moist, olive grey green to grey, abundant micas
						27		
						32		SAA, v. hard
				0/0	0/4	60		SAA, brn, more sand (v.f.) @ 13'
							SP	Sand, vf-coarse, md brn, moist, no odor
15						28		
						50	SM	Silty SAND, f sand, moist, sl. Hc odor, partially cemented grey-brown
						-		
						50		SAA, f-md., <10% coarse, fuel odor
						37		
						50-2"		SAA, 6" vf sand & silt @ 20, fuel odor
20						1027/		
						1100		
						1300/	ML	SILT, sm clay, tr coarse sand (cemented), olive-grey, Hc odor, v. moist
						1600		
						1450/		SAA, Fe stain, some drk grey stain, strong Hc odor, moist
						1700		SAA
25						2500/		
						4000	SP	SAND, f-md, grey, strg Hc odor, v. moist, mica, mostly f. grained
						2550/		
						4800		SAA, fine, grey stg Hc odor, moist, mica
						9		
						2930/		SAA, fine ~10% md., strg Hc odor, moist, lt. grey-tan
						4800		
30						2910/		SAA stg Hc odor
						6100		
						2990/		SAA stg Hc odor
						7400		

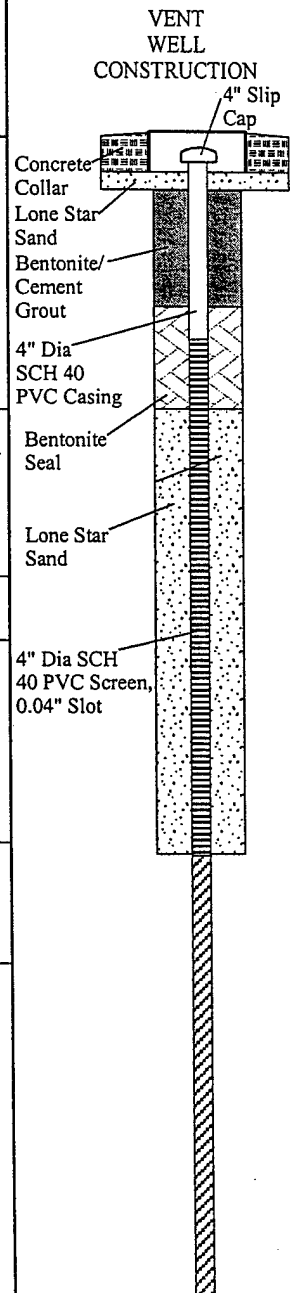

- ▽ - First encountered groundwater.
- - Contact location.
- - Shading indicates percent recovery in sampler.
- ▽ - Equilibrated groundwater level.
- - Approximate contact location.
- NR - Not Recorded
- - Drive sample.

*Sample submitted for laboratory analysis

BORING NUMBER: PFFAVMP14

PROJECT NUMBER: 731297		PROJECT NAME: Castle AFB	
CLIENT: AMC/AFCEE		Risk-Based Remediation	
LOCATION: PFFA		DRILLER: West Hazmat	
Castle Airport, California		DRILLING METHOD: hollow-stem auger	
GEOLOGIST: JFH		HOLE DIAMETER: 8"	
COMPLETION DATE: 12/16/97		TOTAL DEPTH: 61'	

DEPTH (feet)	GW ELEVATION	SAMPLE NUMBER	SAMPLE LOCATION		BLOW COUNT	USCS SOIL CLASS	GEOLOGIC DESCRIPTION
			Background/ Breathing Zone (PID)	Headspace Screening Sample (PID)			
0						SM	6" Asphalt / road base SAND, f-m, orange-brn, moist, no odor, tr silt
5				12.9/6		SAA	
10				11.7/10			SAND, f, tr silt & clay, md. brn, moist no odor
15				9.4/26			SAND, fine, tr silt, md. brn, v. moist - wet, no odor
20				14/12	35 50		SAND, vf.-f., silty, clayey, grey-brn, moist no odor
				12.2/22	34 38	ML	SILT, tr clay, olive-blue-grey, moist no odor
25				29.8/32	19 21	SP	SAA SAND fine, some med. grey, Fe stain, sl. Hc odor, sl. cemented
30			0.0/0.2	144/120	37		SAND, f-md, grey, moist, Hc odor, dk grey stain (see next page)

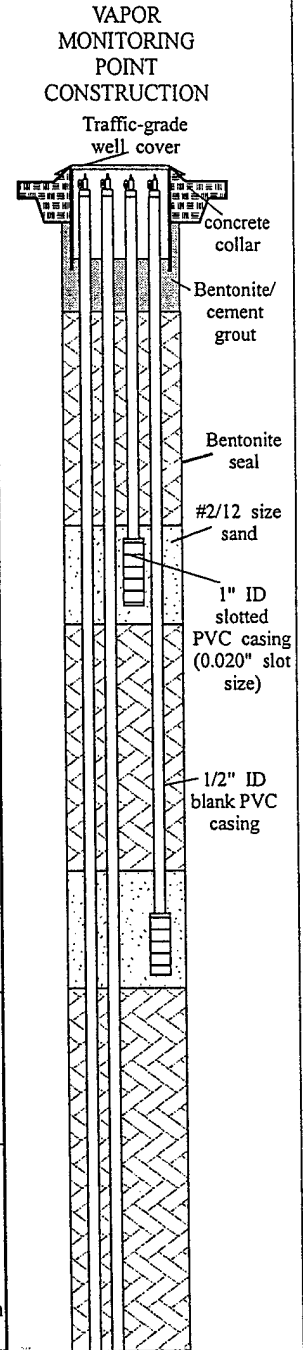

- ▽ - First encountered groundwater.
- ▽ - Equilibrated groundwater level.
- - Contact location.
- - Approximate contact location.
- - Shading indicates percent recovery in sampler.
- NR - Not Recorded
- - Drive sample.

BORING NUMBER: PFFAVMP14

PROJECT NUMBER: 731297	PROJECT NAME: Castle AFB
CLIENT: AMC/AFCEE	Risk-Based Remediation
LOCATION: PFFA	DRILLER: West Hazmat
Castle Airport, California	DRILLING METHOD: hollow-stem auger
GEOLOGIST: JFH	HOLE DIAMETER: 8 inches
COMPLETION DATE: 12/16/97	TOTAL DEPTH: 61'

DEPTH (feet)	GW ELEVATION	SAMPLE NUMBER	SAMPLE LOCATION	Headspace Screening		BLOW COUNT	USCS SOIL CLASS	GEOLOGIC DESCRIPTION
				Background/ Breathing Zone (PID)	Sample (PID)			
30				0.0/0.2	144/120			SAND, f-med, grey, moist, Hc odor, dk grey stain
35					1430/ 1600	28 50	ML CL	SAA SILT, olive grey, Fe stain, moist, Hc odor, ~30% vf sand
40					2100/ >10,000	37 50		SILT, & f-vf SAND, Fe stain, stg. HC odor, moist
45					2050/ >10,000		SP	SAND, f. some md, grey, stg Hc odor moist
50					2100/ >10,000			SAA, stg Hc odor
55					585/1100			SAA, stg odor @ 49, sl. odor @ 51.5, Fe stain
60					250/280			SAND, s-m, grey, moist, no odor
					565/980			SAA, SI odor

VAPOR MONITORING POINT CONSTRUCTION

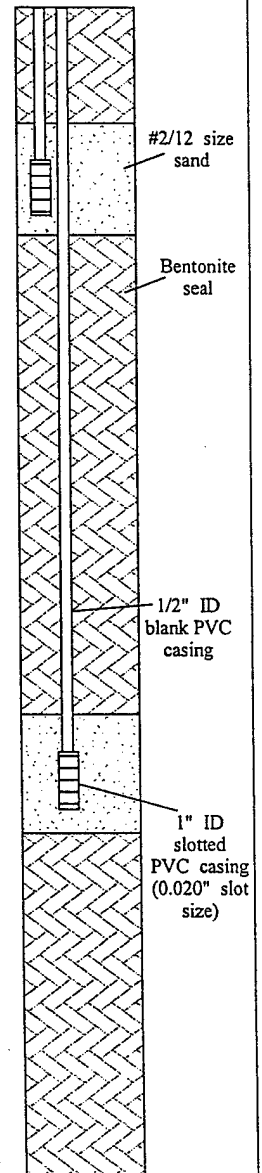

- ▽ - First encountered groundwater.
- ▽ - Equilibrated groundwater level.
- - Contact location.
- - Approximate contact location.
- - Shading indicates percent recovery in sampler.
- NR - Not Recorded
- - Drive sample.

BORING NUMBER: PFFAVMP15

PROJECT NUMBER: 731297	PROJECT NAME: Castle AFB
CLIENT: AMC/AFCEE	Risk-Based Remediation
LOCATION: PFFA	DRILLER: West Hazmat
Castle Airport, California	DRILLING METHOD: has CME75
GEOLOGIST: JFH	HOLE DIAMETER: 8"
COMPLETION DATE: 12/16/97	TOTAL DEPTH: 59'

DEPTH (feet)	GW ELEVATION	SAMPLE NUMBER	SAMPLE LOCATION	Headspace Screening		BLOW COUNT	USCS SOIL CLASS	GEOLOGIC DESCRIPTION
				Background/ Breathing Zone (PID)	Sample (PID)			
0							SM	6" Asphalt / road base SAND, f-m, md brn, moist (cuttings)
5				16/8		20 26 42		SAND, fine, md brn, moist, tr silt, moist, no odor
10				19.4/16		17 22 37		Silty SAND, fine, sm silt, lt-md brn, moist, no odor
15				19.4/12		18 22 50		SAND, fine, tr silt, v. moist, md red-brn, no odor
20				4.9/10				SAND, fine-md, silty, orange-brn, moist, no odor
25				0.0	5.4/22			SAA, grey silt (4") at 17.5
25					2.9/22			SAA, no silt
25					21/32		ML	SILT, grey, v. moist-wet, mica, Fe stain, no odor
30					113/78		SP	SAND, fine, tr md grained, grey, moist, stg Hc odor
30					111/110			SAA, Hc odor f-md grained
30				0.0/0.0	61.4/40			(see next page)

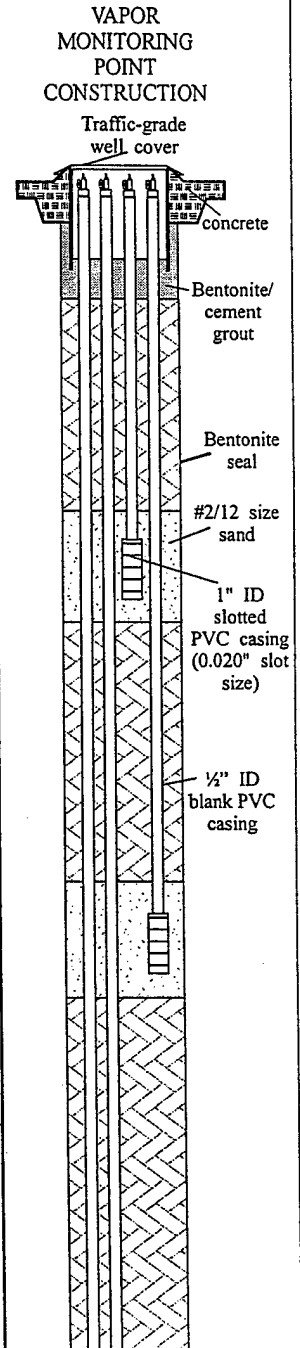

- ▽ - First encountered groundwater.
- ▽ - Equilibrated groundwater level.
- - Contact location.
- - Approximate contact location.
- - Shading indicates percent recovery in sampler.
- NR - Not Recorded
- - Drive sample.

BORING NUMBER: PFFAVMP16

PROJECT NUMBER: 731297	PROJECT NAME: Castle AFB
CLIENT: AMC/AFCEE	Risk-Based Remediation
LOCATION: PFFA	DRILLER: West Hazmat
Castle Airport, California	DRILLING METHOD: hollow-stem auger
GEOLOGIST: JFH	HOLE DIAMETER: 8"
COMPLETION DATE: 12/17/97	TOTAL DEPTH: 61'

DEPTH (feet)	GW ELEVATION	SAMPLE NUMBER	SAMPLE LOCATION	Headspace Screening		BLOW COUNT	USCS SOIL CLASS	GEOLOGIC DESCRIPTION
				Background/ Breathing Zone (PID)	Sample (PID)			
0							SM	6" Asphalt / road base
5					5.8/4			SAND, f, moist, tr. silt, 10YR4/4 no order
10					5.9/7			SAND, v.f., & SILT, tr. clay, moist, no odor 5Y6/2 SAND, m-c, silty, moist 10YR4/4
15				0.0/0.0	8.6/7			Interbedded SAND, f & sand f-c., moist, silty, sl. cemented 7.5YR5/6 no odor
20						50 50		SAND, f-m, tr. silt, moist, no odor 2.5Y5/3
				0.0/0.0	1.3/8	58	ML	SAND, v.f, silty, moist Fe stain, no odor, 5/5BG
					1.6/8	37 50		SILT, Fe stain on fractions, 5/10BG
25					18.3/30	21 32 48	SP	SAND, f, moist, sl Hc odor, 5Y7/1 silty 24.5-25
30				0.0/0.0	7.8/10	11 19 33		SAND, f-m, some coarse, moist, no odor, 5Y7/1 (see next page)

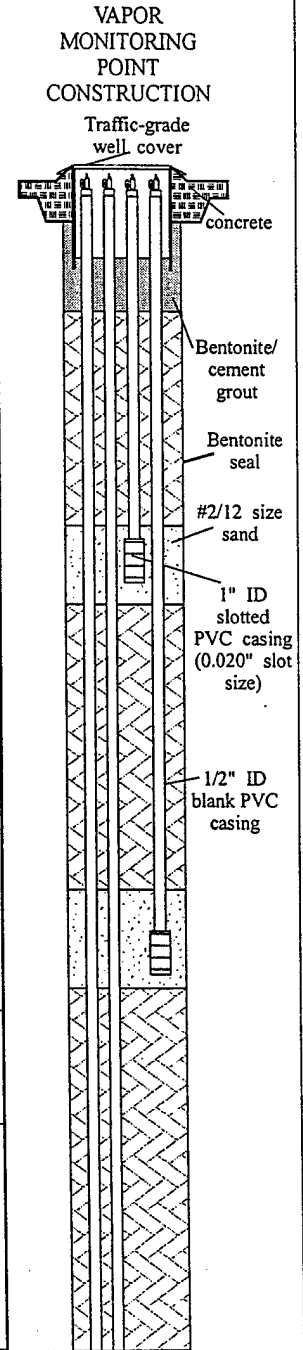

- ▽ - First encountered groundwater.
- - Contact location.
- - Shading indicates percent recovery in sampler.
- ▽ - Equilibrated groundwater level.
- - Approximate contact location.
- NR - Not Recorded
- - Drive sample.

BORING NUMBER: PFFAVMP16

PROJECT NUMBER: 731297	PROJECT NAME: Castle AFB
CLIENT: AMC/AFCEE	Risk-Based Remediation
LOCATION: PFFA	DRILLER: West Hazmat
Castle Airport, California	DRILLING METHOD: hollow-stem auger
GEOLOGIST: JFH	HOLE DIAMETER: 8 inches
COMPLETION DATE: 12/17/97	TOTAL DEPTH: 61'

DEPTH (feet)	GW ELEVATION	SAMPLE NUMBER	SAMPLE LOCATION	Headspace Screening		BLOW COUNT	USCS SOIL CLASS	GEOLOGIC DESCRIPTION
				Background/ Breathing Zone (PID)	Sample (PID)			
30				0.0/0.0	1.8/10	11 19 33		SAND, f-m, some coarse, moist, no odor 5Y7/1
35					210/140			SAND, f-m, moist, sl Hc odor, Fe stain 5Y7/1
40				0.0/0.0	1239/ 1400		ML/ CL	SILT, tr. v. f. sand, moist, sl Hc odor, 4/5G
45					277/410	12 14 32	SP	SAND, v. f. moist, sl Hc odor 2.5Y6/3
50					262/280			SAND, f-m, some coarse, moist, Fe stain, sl Hc odor 5Y7/3
55				0.0/0.0	93.1/100	15 25 46		SAA, v. sl. odor
60					438/4N			SAA, sl. Hc odor

VAPOR MONITORING POINT CONSTRUCTION

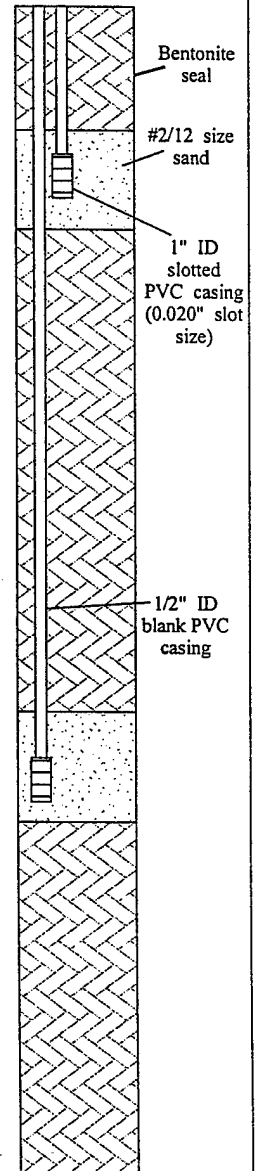

- ▽ - First encountered groundwater.
- ▽ - Equilibrated groundwater level.
- - Contact location.
- - Approximate contact location.
- - Shading indicates percent recovery in sampler.
- NR - Not Recorded
- - Drive sample.



PARSONS ENGINEERING

Site : PFFA
Location : BOSOSA

Geologist : M. PIERCE
Date : 03:24:98 17:37

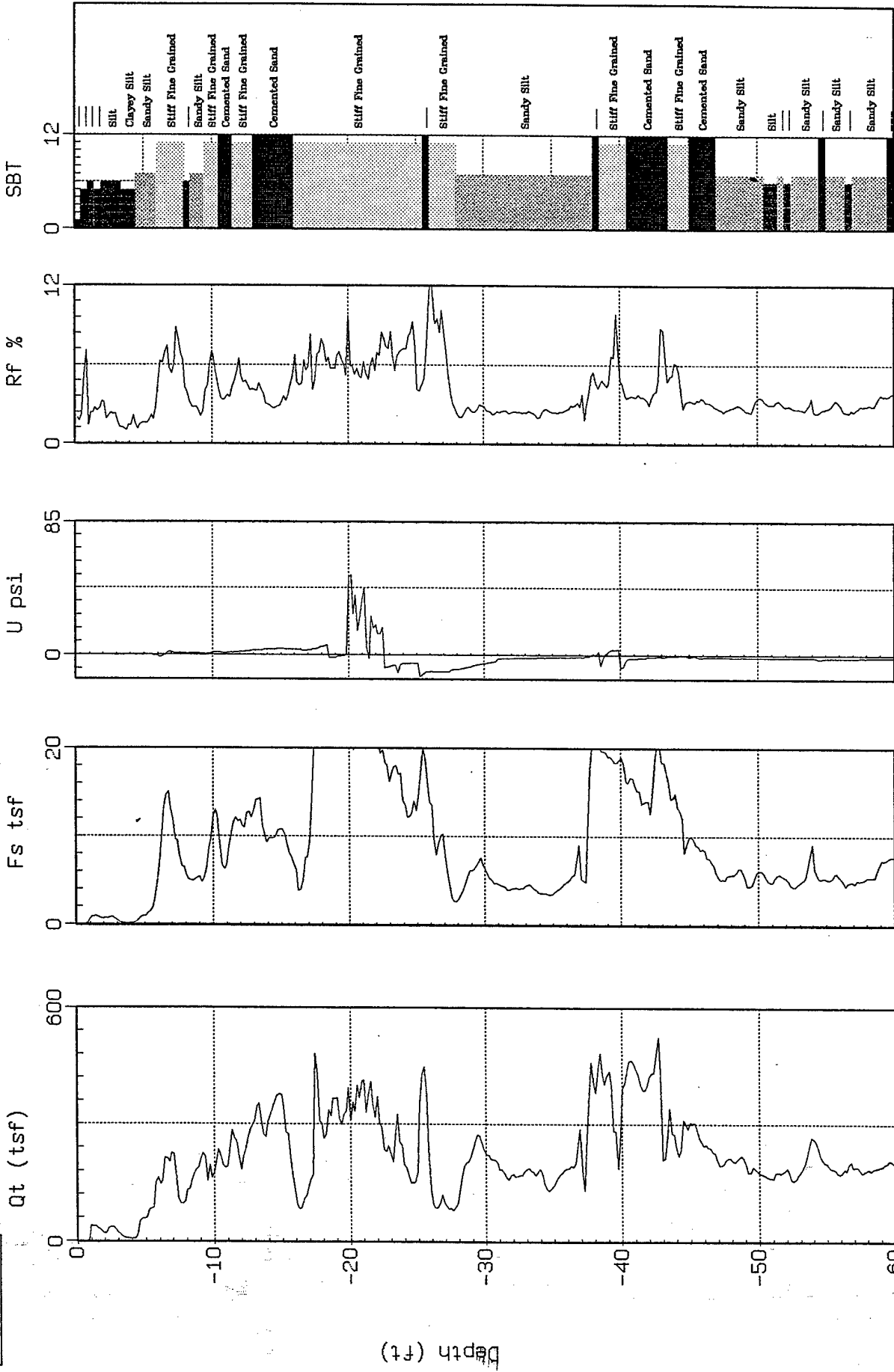

SBT: Soil Behavior Type (Robertson and Campanella 1988)

Max. Depth: 60.04 (ft)

Depth Inc.: 0.164 (ft)

DRAFT



PARSONS ENGINEERING

Site : PFFA
Location : BOS06A

Geologist : M. PIERCE
Date : 03:24:98 16:10

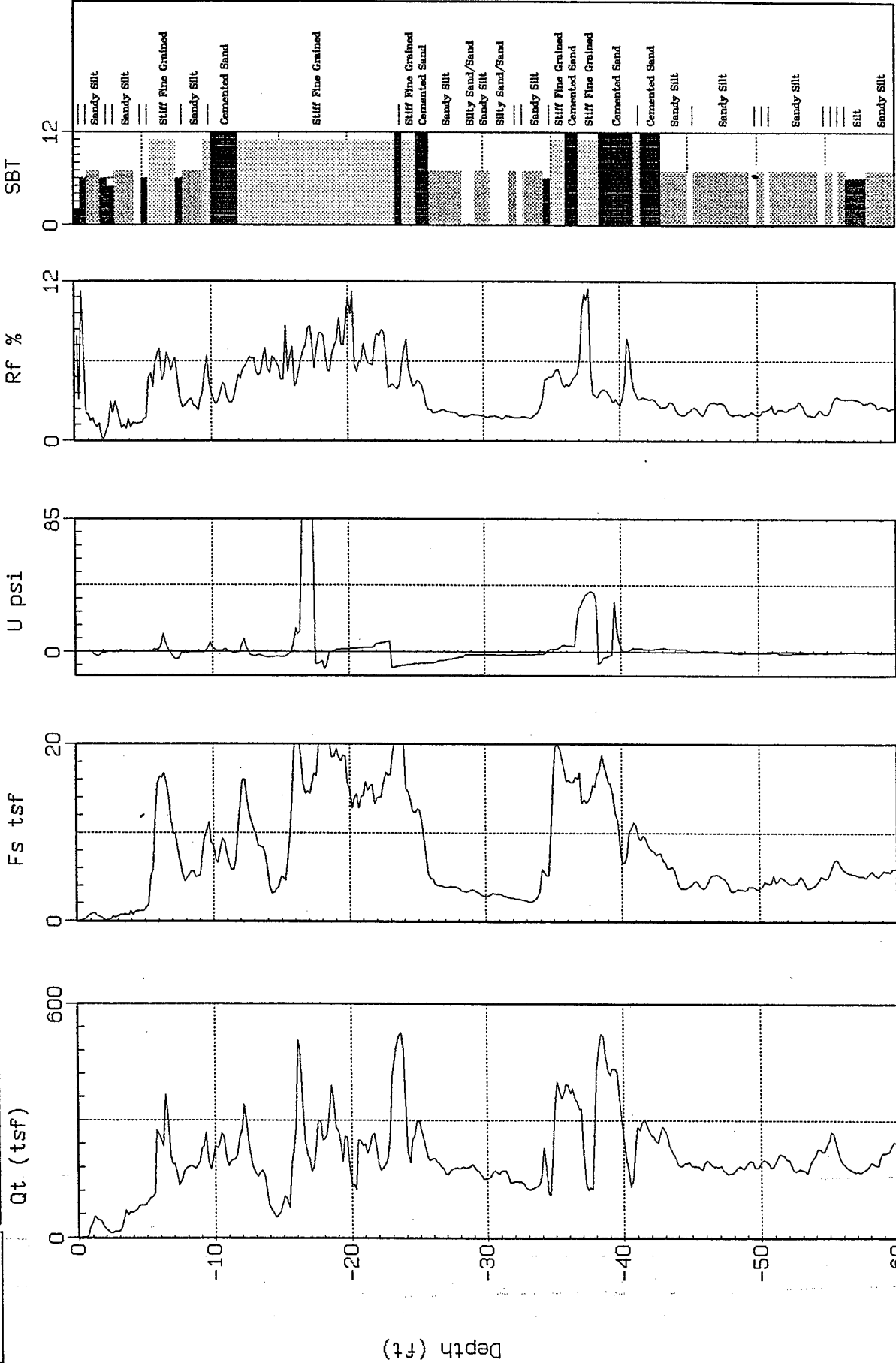

SBT: Soil Behavior Type (Robertson and Campanella 1988)

Max. Depth: 60.04 (ft)
Depth Inc.: 0.164 (ft)

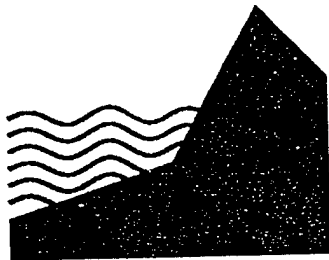

NORCAL

ROBERTSON GEOLOGGING TECHNOLOGY

PETALUMA, CA (707) 763-1312

DEVIATION

COMPANY PARSONS
 WELL
 COUNTY MERCED
 STATE CA
 CASTLE AFB

OTHER SERVICES

Perm. Datum GROUND Elev N.A.
 Log Datum GR
 Drill Datum GROU

KB F
 DF F
 GL F

DATE 04-08-98
 RUN 10
 TYPE LOG BVDS
 TOOL SERIAL# 1964
 DETECTOR LENGTH/DIA.
 DETECTOR FILTER 11
 LOG SPEED (FT/M) 8
 LOG DEEPEST/SHALLOW 64.5/5
 Rm (OHM-M) air
 DENSITY (LBS)
 FLUID LEVEL 60?
 MAX TEMP F
 DATA SAMPLING INT. 1/20 FT.
 RECORDED BY W HENRICH
 WITNESSED BY M. PIERCE

1/20 FT.

1/20 FT.

RUN#	BIT RECORD			SIZE	CASING RECORD		
	BIT	FROM	TO		WEIGHT	FROM	TO
1	8.00"	0	65	4	PVC	0	64.5

BORING NUMBER: PFFAVMP15

PROJECT NUMBER: 731297	PROJECT NAME: Castle AFB
CLIENT: AMC/AFCEE	Risk-Based Remediation
LOCATION: PFFA	DRILLER: West Hazmat
Castle Airport, California	DRILLING METHOD: hollow-stem auger
GEOLOGIST: JFH	HOLE DIAMETER: 8 inches
COMPLETION DATE: 12/16/97	TOTAL DEPTH: 59'

DEPTH (feet)	GW ELEVATION	SAMPLE NUMBER	SAMPLE LOCATION	Headspace Screening		BLOW COUNT	USCS SOIL CLASS	GEOLOGIC DESCRIPTION
				Background/Breathing Zone (PID)	Sample (PID)			
30				0.0/0.0	61.4/40			SAND, f-m, ~5% coarse, grey, moist Hc odor
35					3.3/280			SAA Silty Sand, fine, grey-brn, moist Hc odor
40					690/640		ML/CL	2" - SAA SILT, and fine-gr SAND, grey-olive grey, Fe stain, sl odor, moist
45					1801/4700		SP	SAA to 42.2 SAND f-md, lt grey, moist, stg Hc odor
50				0.0/0.1	41/58	10 20 16 26		SAA, tr. coarse gr. sl odor Fe stain
55					23/18	10 16 43 40		SAA, no odor
60				0.0/0.0	10.7/6			SAA, less med. grained, sl. Hc odor
					24/18			SAA

VAPOR MONITORING POINT CONSTRUCTION

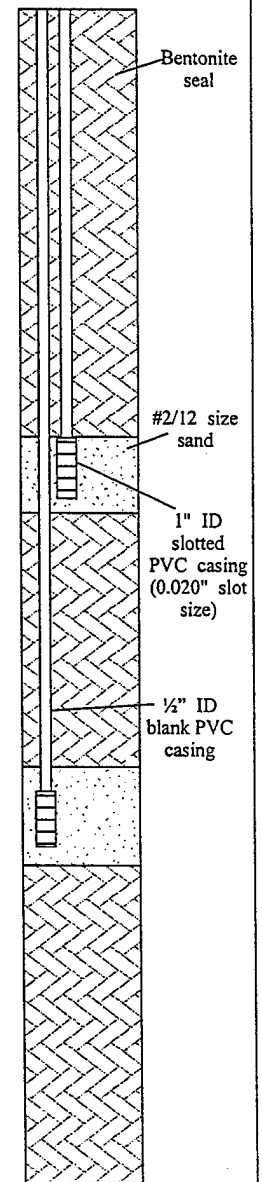

- ▽ - First encountered groundwater.
- ▽ - Equilibrated groundwater level.
- - Contact location.
- - Approximate contact location.
- - Shading indicates percent recovery in sampler.
- NR - Not Recorded
- - Drive sample.

MW-967 *Blude*
MERCED
04-08-98
Start Depth 8 feet
End Depth 64
Markers 10

True North

+

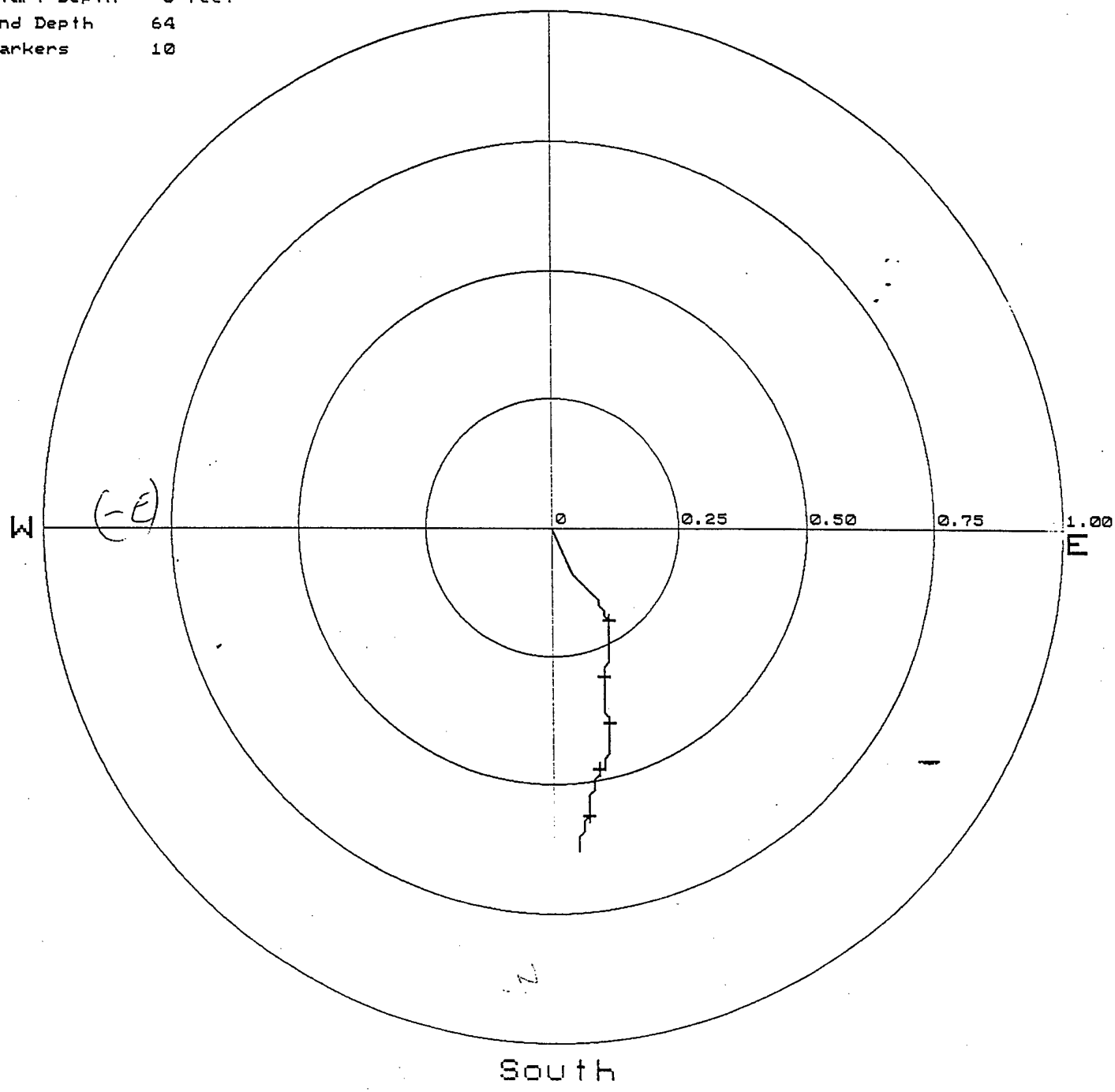

PFFABOS01

MERCED

04-08-98

Start Depth 5 feet

End Depth 59

Markers 10

True North

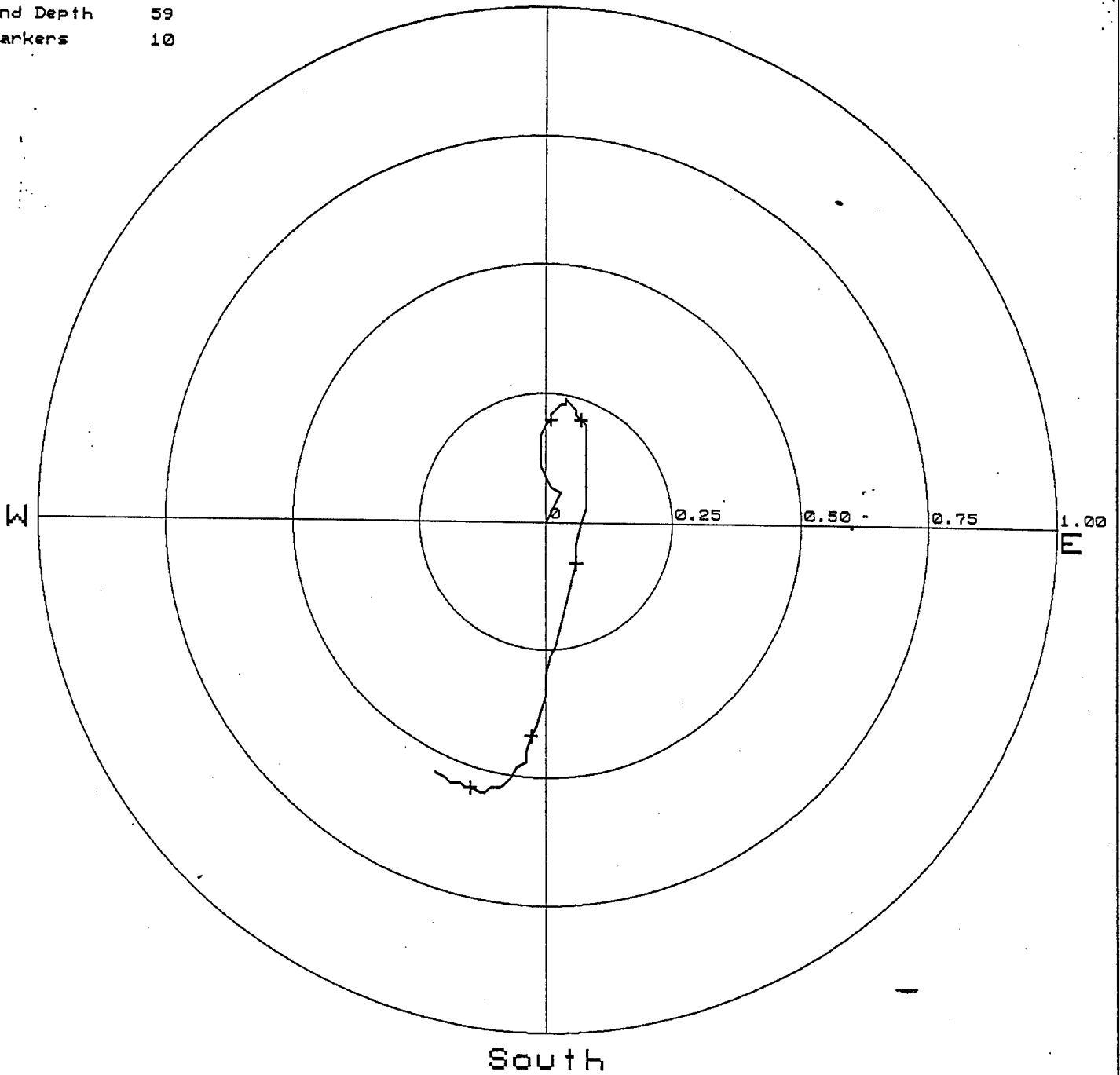

Robertson Geologging Ltd. - Verticality Analysis

Robertson Geologging Ltd. - Verticality Analysis

South

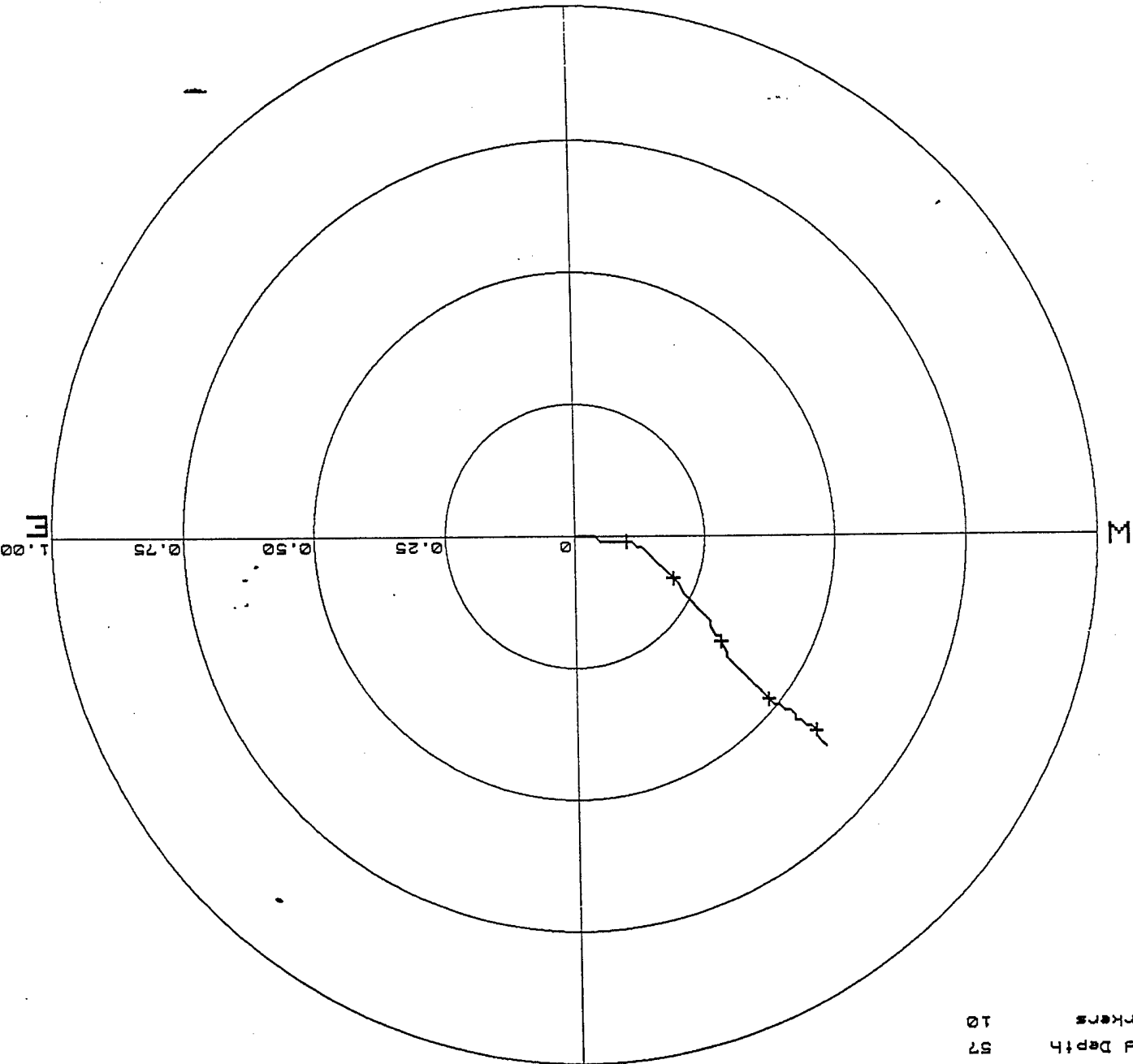

True North

PFFABOS 03
MERCED
04-08-98
Start Depth 5 feet
End Depth 57
Markers 10

PFFABOS03a

MERCED

04-08-98

Start Depth 5 feet

End Depth 30

Markers 10

True North

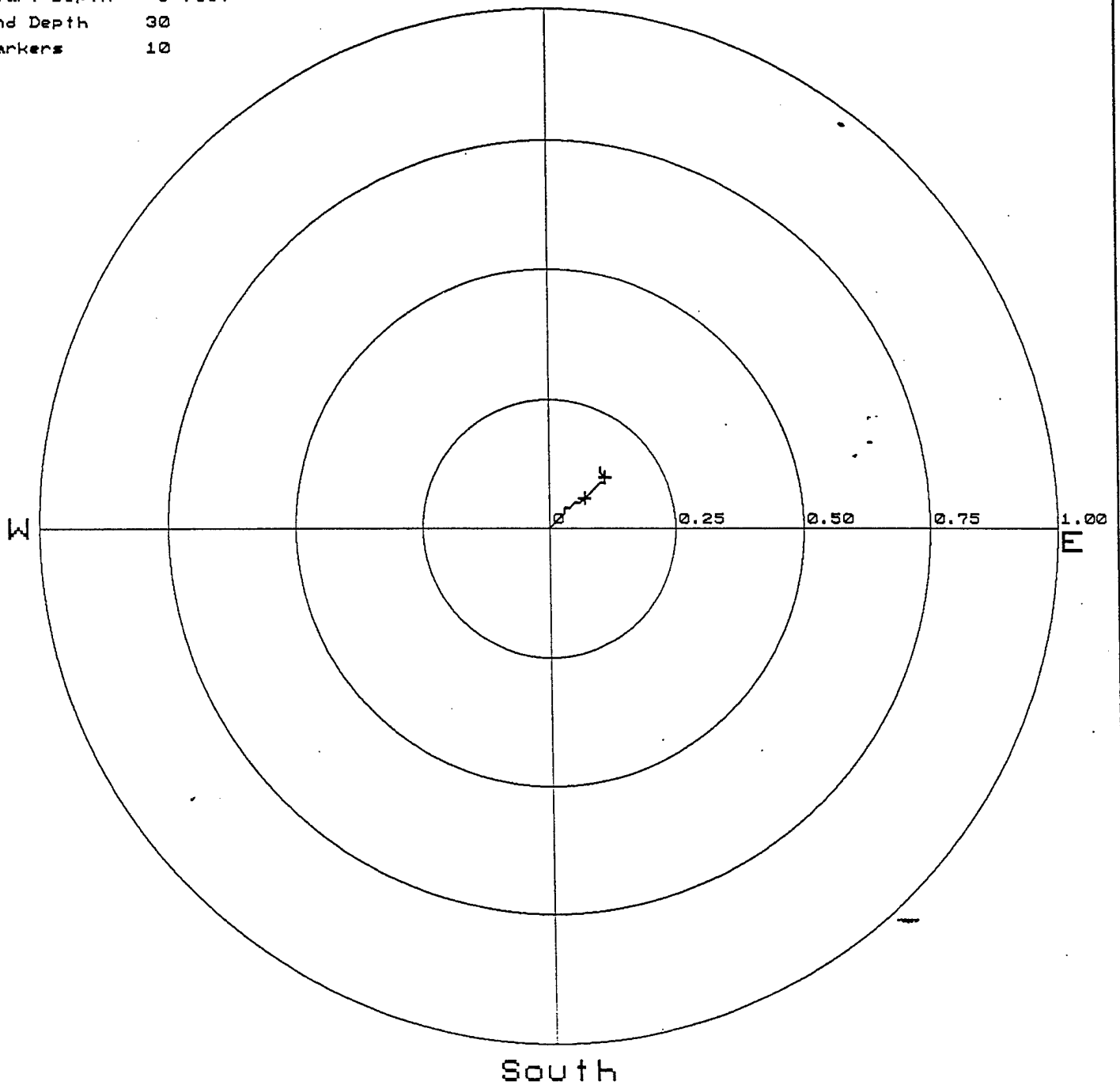

Robertson Geologging Ltd. - Verticality Analysis

PFFABOS04
MERCED
04-08-98
Start Depth 5 feet
End Depth 58
Markers 10

True North

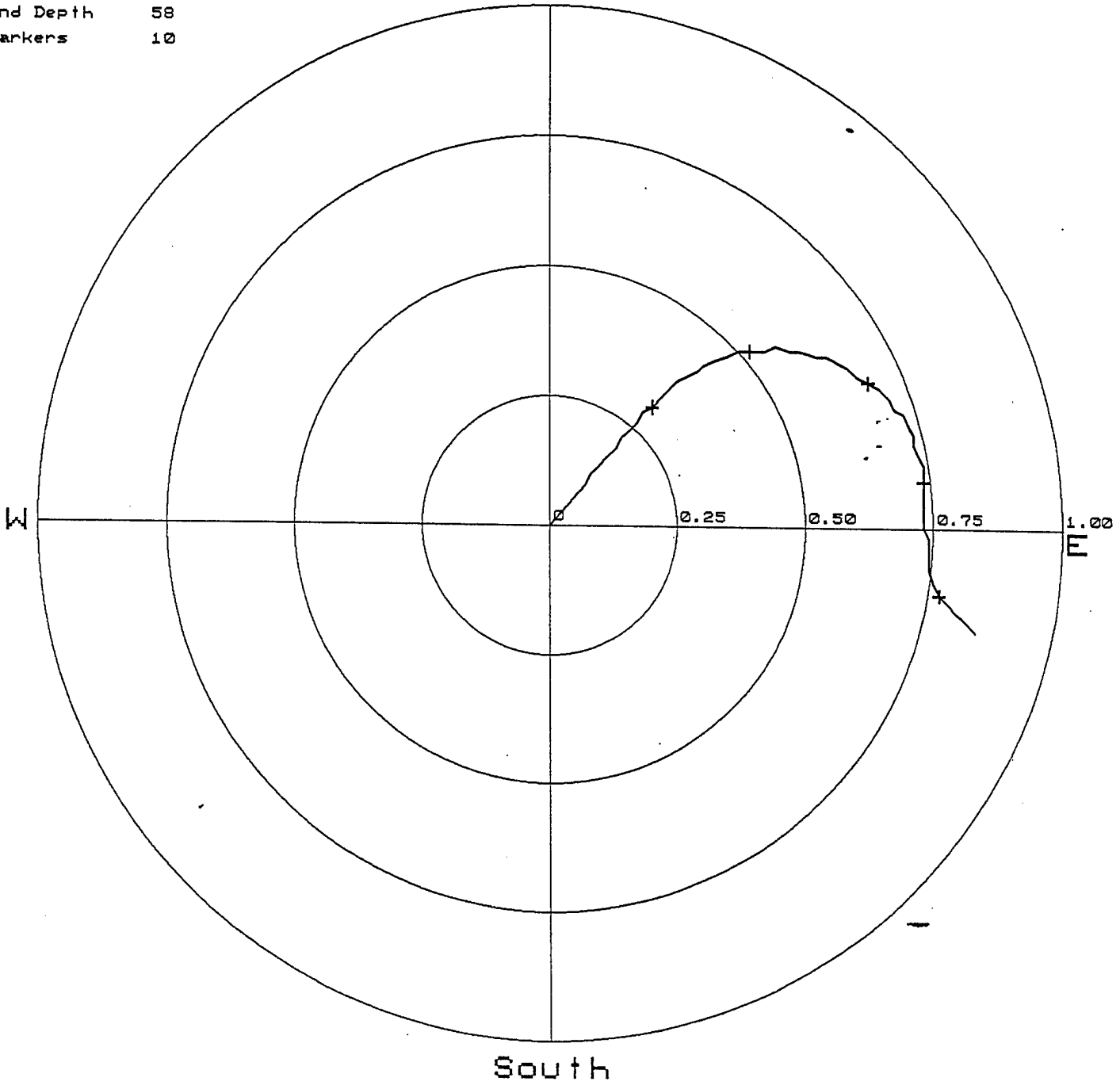

Robertson Geologging Ltd. - Verticality Analysis

PFFABOS05

MERCED

04-08-98

Start Depth 5 feet

End Depth 59

Markers 10

True North

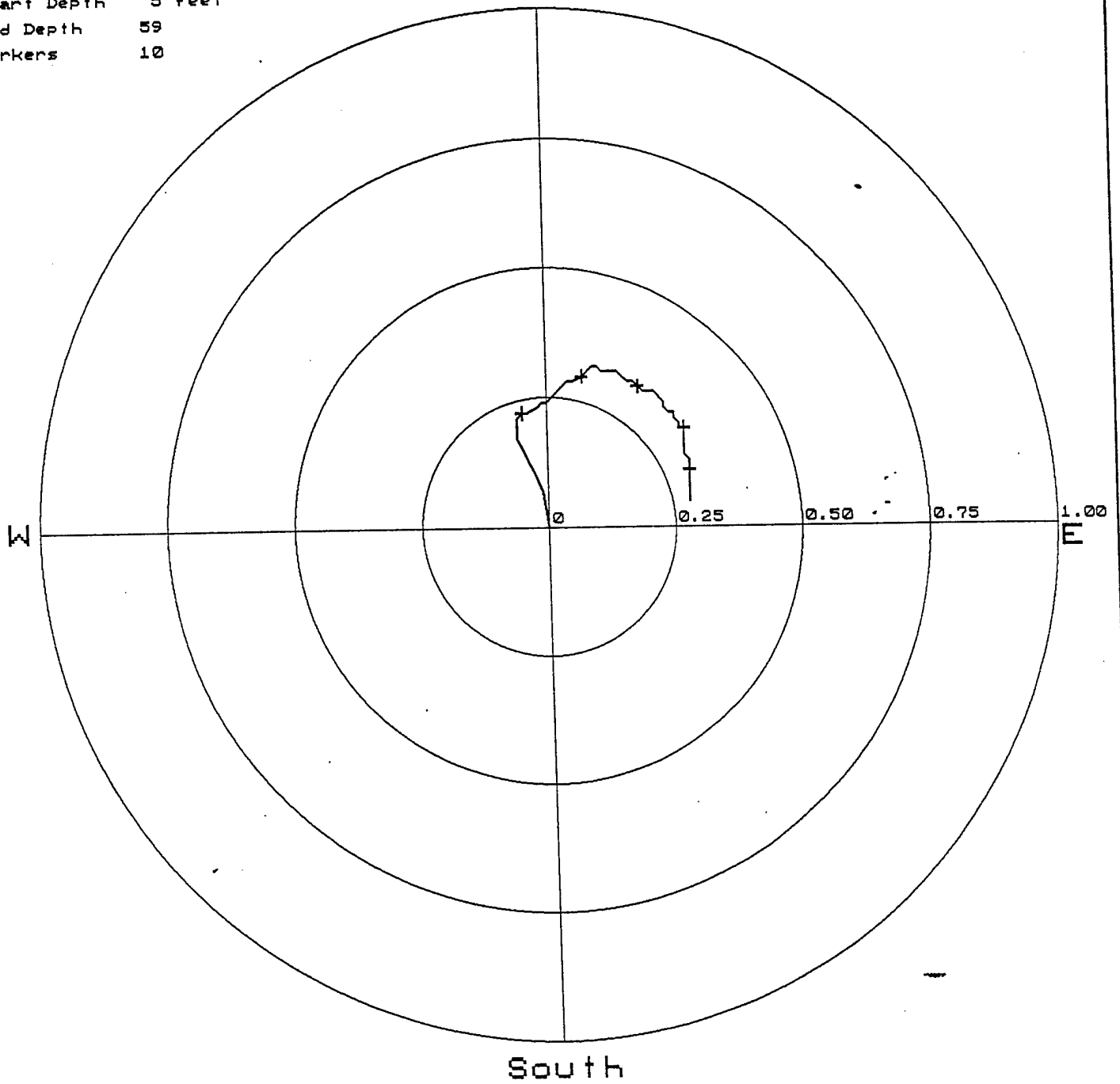

Robertson Geologging Ltd. - Verticality Analysis

PFFABOS06

MERCED

04-08-98

Start Depth 5 feet

End Depth 59

Markers 10

True North

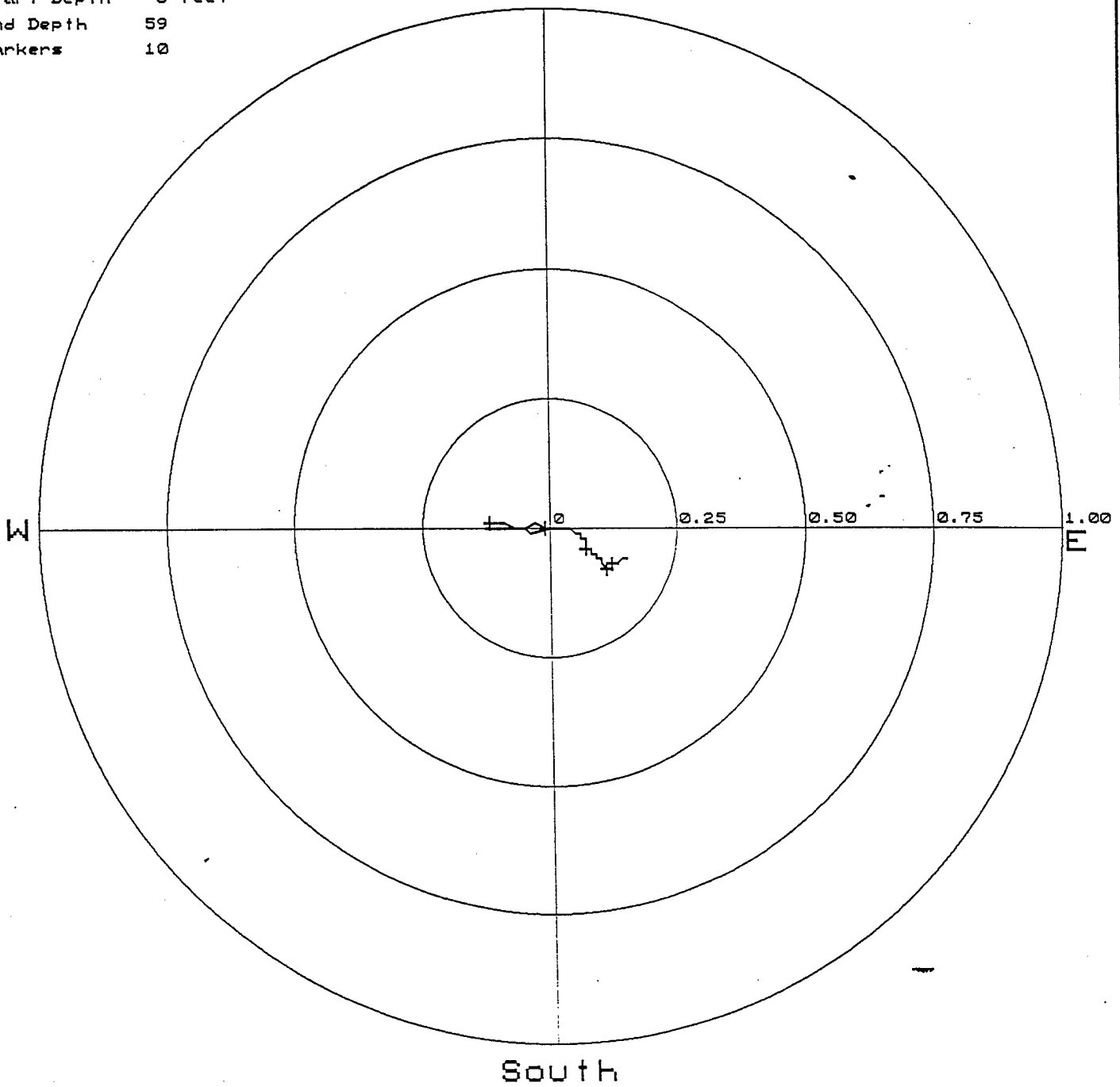

Robertson Geologging Ltd. - Verticality Analysis

PPFBOS07

MERCED

04-08-98

Start Depth 5 feet

End Depth 59

Markers 10

True North

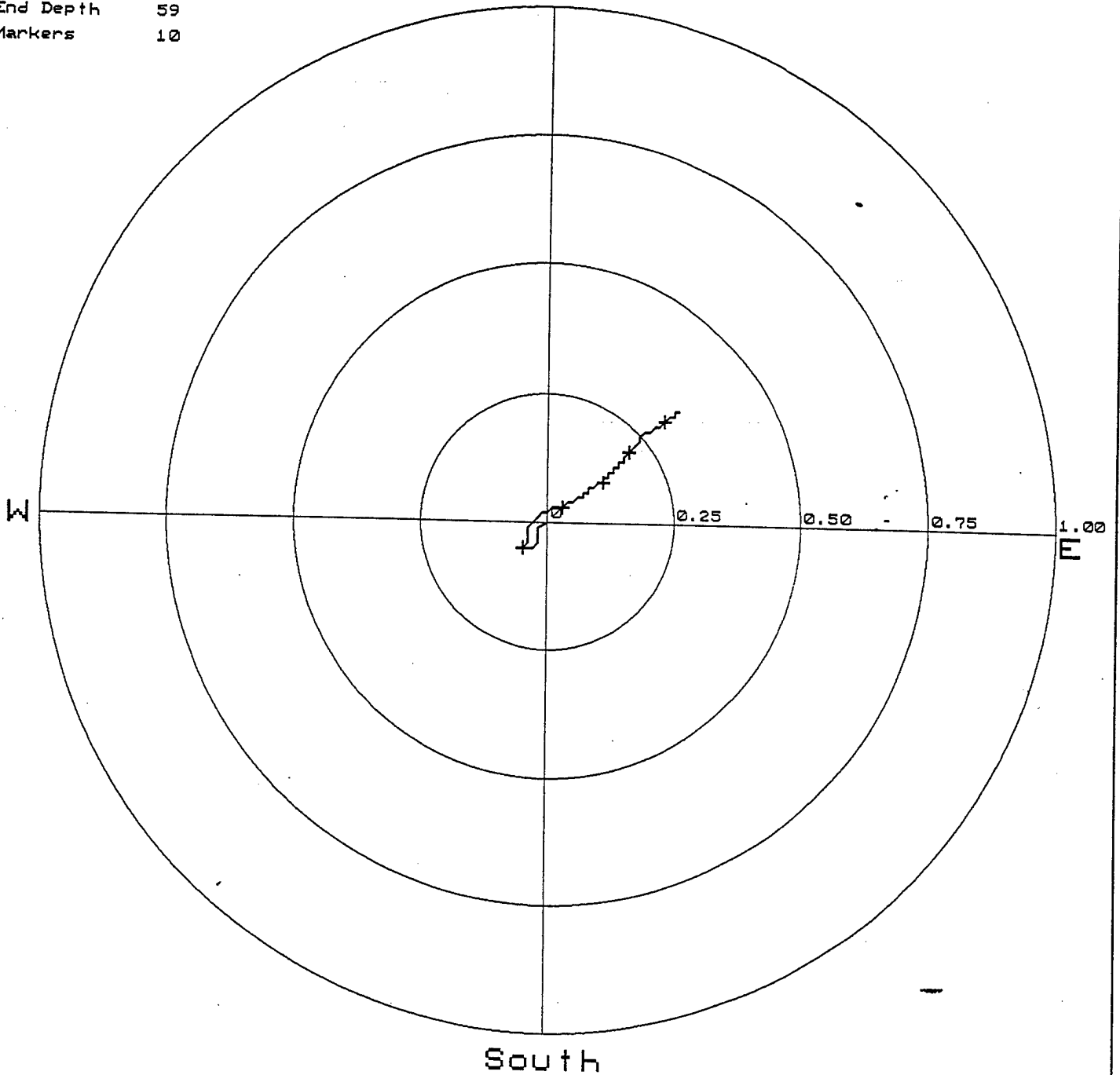

Robertson Geologging Ltd. - Verticality Analysis

PFFABOS08

MERCED

04-08-98

Start Depth 5 feet

End Depth 59

Markers 10

True North

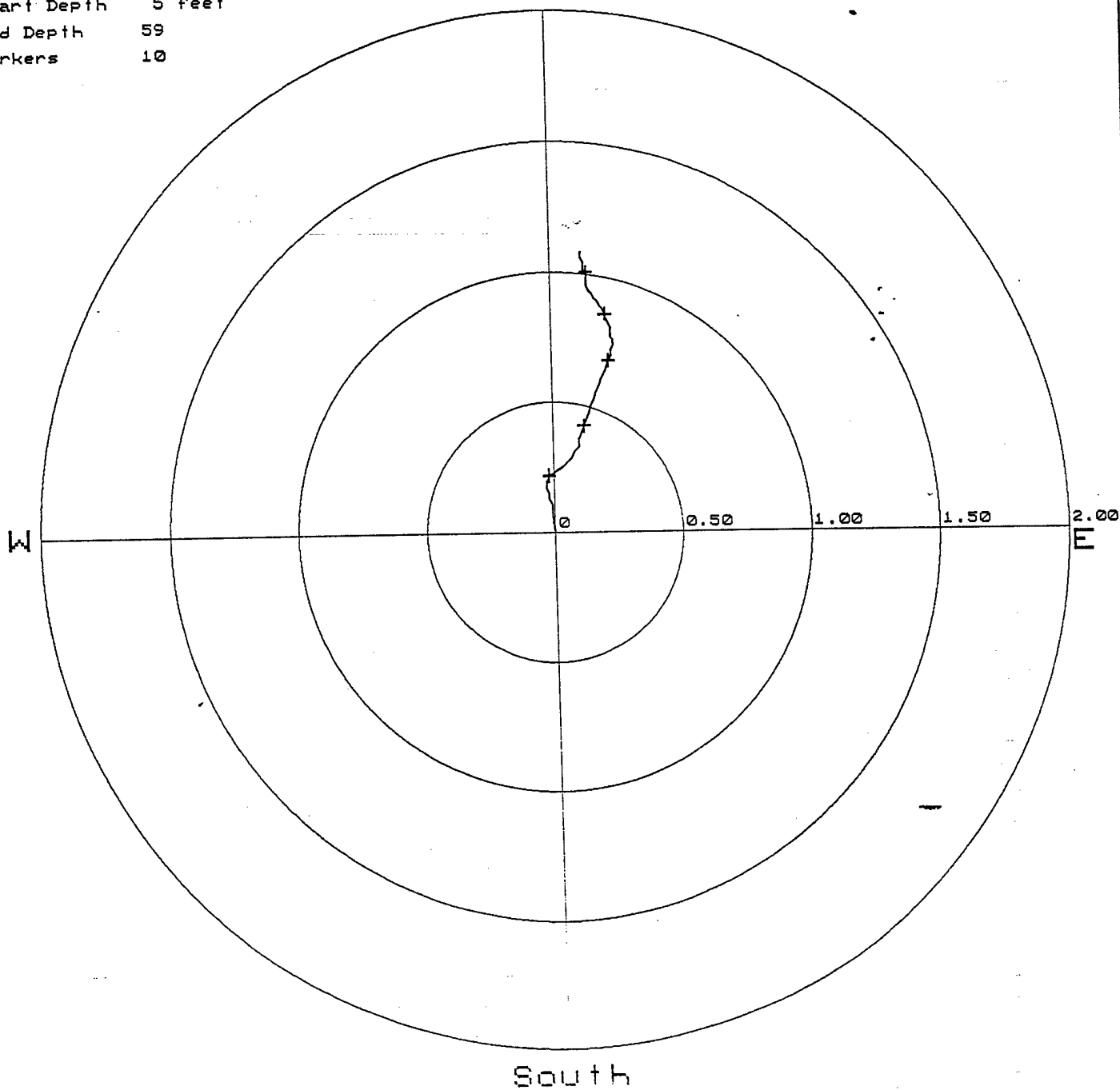

Robertson Geologging Ltd. - Verticality Analysis

Appendix D Electronic Data Summary

Included in this Appendix is a CD-ROM (IBM format) which contains electronic data files for the demonstration. The following files can be found on the CD-ROM:

<u>Name</u>	<u>Description</u>	<u>File Format</u>
F_PB_Rpt.pdf	Final Report (this document)	PDF (Adobe Acrobat)
TESTS.XLS	Data from Tests 1 through 6	Microsoft Excel 97

Files in the PDF (Portable Document Format) are viewable and printable with the free Adobe Acrobat Reader software commonly used for publishing documents on the internet. This software is downloadable from the Adobe Corporation home page at <http://www.adobe.com/>. Links within the FReport .pdf file can be used to automatically open and view individual PDF files or internet links.

Appendices C and F are only available in the hard copy form of the report.

The Microsoft Excel file containing the data downloaded from the data acquisition system (TESTS.XLS) is quite large (over 40 MB). Depending on their computing power and capacity, users wishing to manipulate or view this data may need to divide the file into parts to facilitate analysis.

Appendix E
Photo Documentation

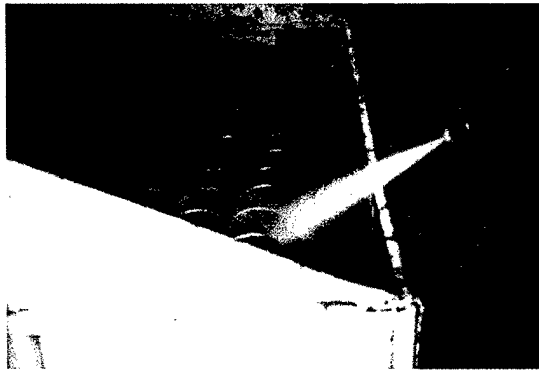

Photo 1. Decontamination of drilling equipment.

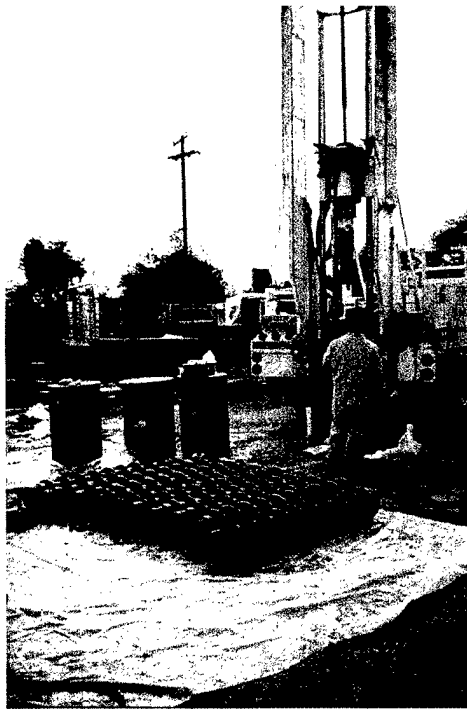

Photo 2. Setup of drill rig.



Photo 3. Mobilization of support equipment.

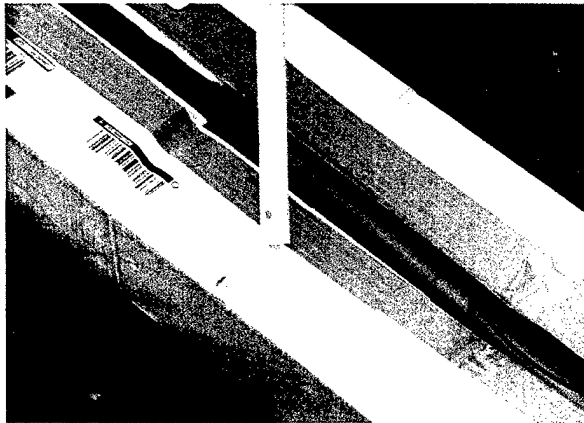

Photo 4. Oxygen sensor.

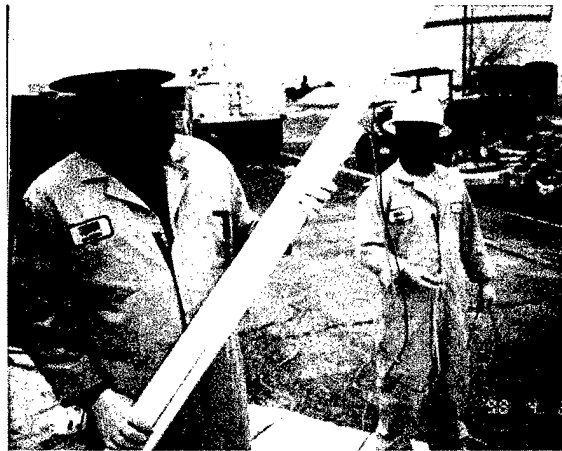

Photo 5. Attachment of sensor to PVC casing.



Photo 6. Installation of sensor through hollow stem auger.

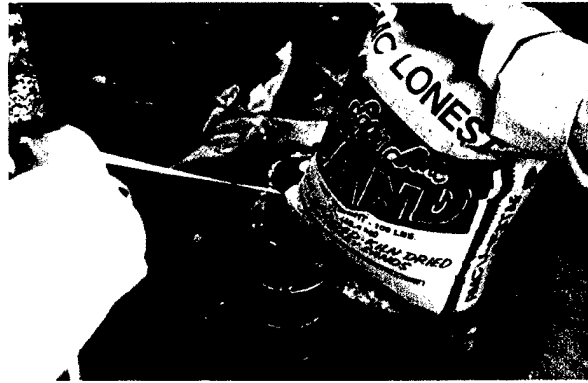

Photo 7. Placement of sand filter pack.



Photo 8. Verticality measurement in VMP.



Photo 9. Oxygen sensor/VMP surface completion.

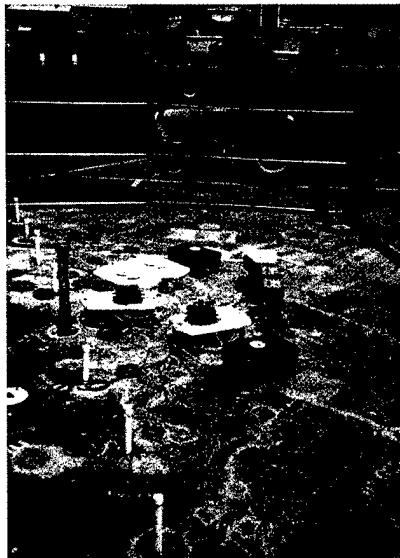

Photo 10. Site overview showing VW, VMPs, and data acquisition system.

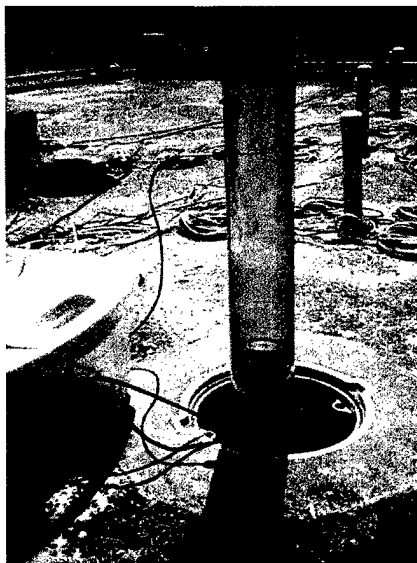

Photo 13. VW with passive valve and air flow transducer.



Photo 11. Collection of soil vapor samples.

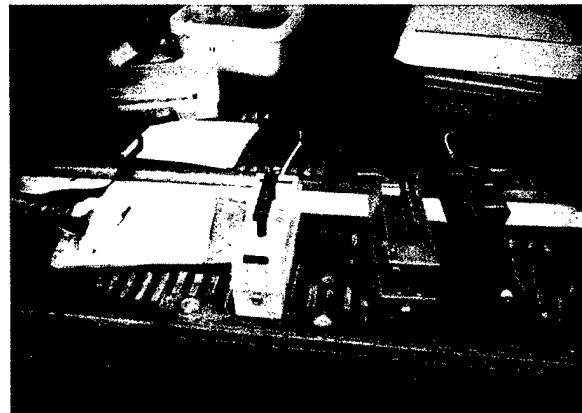
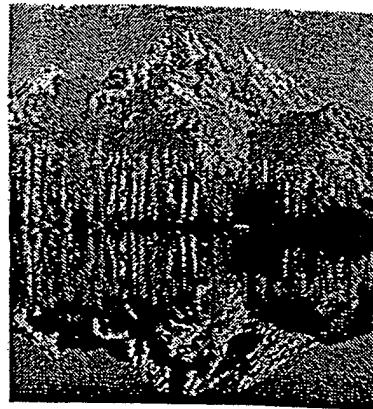

Photo 12. Oxygen and hydrocarbon field meters.

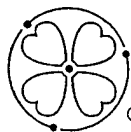

Photo 14. Modular data acquisition system.

Appendix F
Equipment Details and Specifications



In-Situ Inc.
Helping monitor the earth's resources



In-Situ Inc.
Helping monitor the earth's resources

210 South Third Street
P.O. Box I
Laramie, Wyoming 82070-0920 USA
Tel: 307 742 8213
800 446 7488
Fax: 307 721 7598
Internet: <http://www.in-situ.com>

HERMIT 3000
Data Logger
Operator's Manual

October 1997

Providing in-place, continuous, monitoring of oxygen in unsaturated soils



Applications:

- optimization and monitoring of bioventing systems
- area-of-influence determination of air injection and vapor extraction systems
- determination of dynamic localized respiration rates for in situ and *ex situ* bioremediation of soil.

Distributed by BioRenewal Technologies, Inc.
and manufactured by Datawrite Research Company.

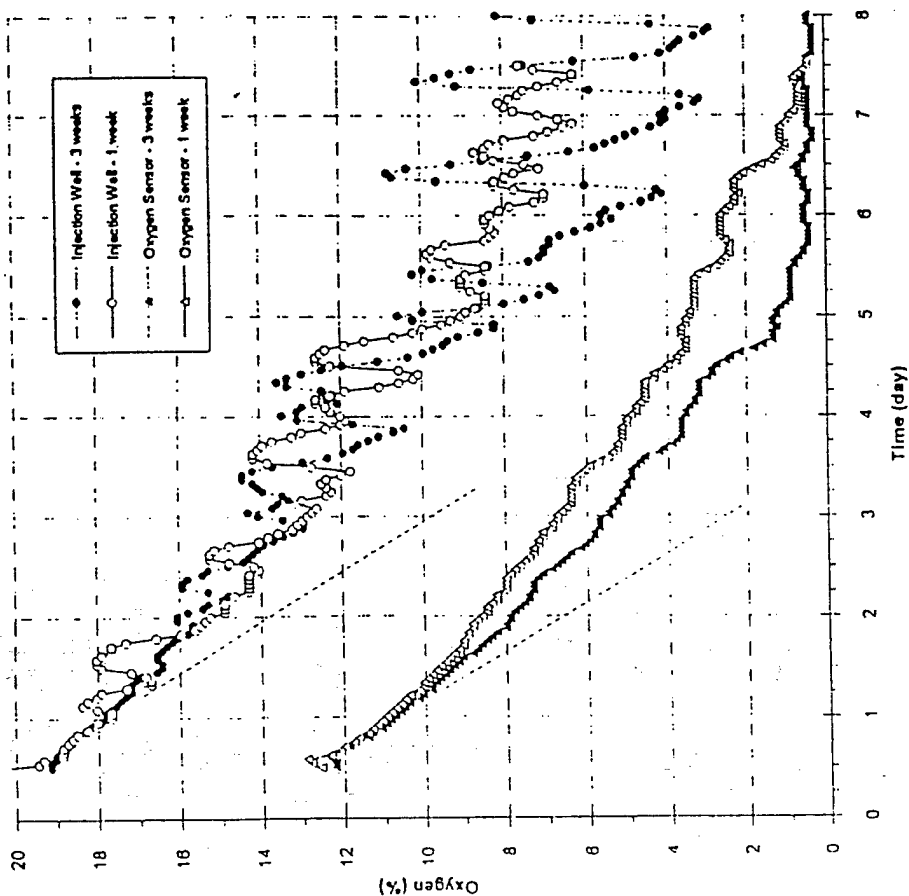

Oxygen concentration readings from an oxygen sensor in the injection well and an *in situ* sensor in a hydrocarbon plume during a respirometry test at a former service station site.

Reference: Li, Dong X. 1995. "Continuous Bioventing Monitoring Using New Sensor Technology." In: R.E. Hinchey, C.S. Douglas, and S.K. Ong (eds.), *Monitoring and Verification of Bioremediation*. Battelle Press, Columbus, OH. pp. 115-126.

Specifications



General

Case material	Injected plastic
Dimensions	12" wide, 10" deep, 6.75" high (30.5 x 25.41 x 17.2 cm)
Weight	8.5 lb. (3.9 kg) alkaline, 8.2 lb. (3.7 kg) lithium
Operating/storage temperature	
with alkaline battery	-10° to 45°C (14° to 113°F)
with lithium battery	-40° to 70°C (-40° to 158°F)
barometric sensor	-20° to 70°C (-4° to 158° F)

Data Sampling

Number of channels	8 external plus 1 internal (barometric pressure sensor)
Memory type	Non-volatile
Capacity	944 Kilobytes (at least 475,000 data points)
Accuracy	±0.05% full scale
LCD	5.75" x 1.25" (14.6 x 3.2 cm), 4 lines of 40 characters each

Transducer Input

Type	Standard 4-20 mA probes, type is software-selectable
Source voltage	20 V DC, pulsed
Source current	80 mA max.
Source pulse width (probe warmup time)	50 milliseconds to 30 seconds, user adjustable
Input resistance	150 ohms typical
Maximum cable length	5000 ft. (with In-Situ pressure probe)
Relays	2 relays (2 amperes max.) 30 V DC or 30 V AC max.

Communications

Type	RS232 and RS422 (for networking)
Hardware compatibility	IBM 9-pin

Battery Options

Alkaline	Up to 500,000 (est.) data points or 2 years within the operating temperature range, assuming use of one probe, external power during setup and downloading
Lithium	Up to 1,500,000 (est.) data points or 5 years within the operating temperature range, assuming use of one probe, external power during setup and downloading
Lead-Acid	
Clock/memory battery	5-year factory-replaceable long-life backup battery

External Power Input

Input voltage	15 V (RS232), 48 V (RS422)
Input current	200 to 500 mA (with backlight)

Due to continuing product development this information is subject to change without notice.

To place an order, call 888/276-8908, fax form to 608/273-6989, or e-mail request to info@biorenewal.com. For current product information and pricing, visit our web site at www.biorenewal.com.

Contact name: _____ Date: _____

Company: _____

Delivery address: _____ Billing address: Same

Method of payment: COD Check PO (# _____, attach copy)
 VISA MC AE Card # _____ Exp. Date ____/____

Shipping & Handling: (US only)
Up to \$100 = \$5, \$101 to \$500 = \$12
\$501 to \$1000 = \$19, \$1000 up, = \$25
Express delivery add \$20. Call for int'l rates.

Order summary
Subtotal of 1 through 5 (from below and reverse side) _____
Tax (in WI only*) _____
Shipping & Handling (see box to left) _____

* BioRenewal does not collect or remit sales/use taxes on its products purchased outside of Wisconsin. It is your responsibility to remit these taxes to your state whenever applicable.
BioRenewal payment terms are net 30 days.

TOTAL _____

Ordering Form

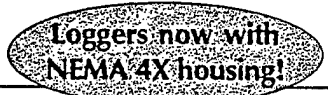

Oxygen Monitoring

Quantity	Unit	Product	Product #	Price (\$)	Total
_____	ea	Oxygen sensor (with 25 ft. cable)	DRC-XT253	219	_____
_____	ea	Oxygen sensor (with 50 ft. cable)	DRC-XT253-50	233	_____
_____	ea	Oxygen sensor (with 75 ft. cable)	DRC-XT253-75	247	_____
_____	ea	Ported oxygen sensor (with 25 ft. cable)	DRC-XT253SP	239	_____
_____	ea	Ported oxygen sensor (with 50 ft. cable)	DRC-XT253SP-50	264	_____
_____	ea	Ported oxygen sensor (with 75 ft. cable)	DRC-XT253SP-75	289	_____
_____	ea	PVC Pogo-probe oxygen sensor (36" PVC)	DRC-XT252PG	239	_____
_____	ea	Pogo-probe oxygen sensor (60" aluminum)	DRC-XT253PGM	339	_____
_____	ea	Hand-held Oxygen Meter - 200mV	DRC-MT200-A	219	_____
_____	ea	Oxygen data logger	DRC-EX064-E	219	_____
				Subtotal 1	_____

Sensors are available in 1.1-inch diameter anodized aluminum or Delrin[®].
Delrin[®] is non-corrosive and inert.

Hydrocarbon Monitoring

Quantity	Unit	Product	Product #	Price (\$)	Total
_____	ea	Hydrocarbon sensor (with 25 ft. cable)	DRC-ADS201	239	_____
_____	ea	Hydrocarbon sensor (with 50 ft. cable)	DRC-ADS201-50	264	_____
_____	ea	Hydrocarbon sensor (with 75 ft. cable)	DRC-ADS201-75	289	_____
_____	ea	Hydrocarbon data logger	DRC-EAD100-E	219	_____
				Subtotal 2	_____

Sensors are 0.8-inch diameter anodized aluminum. 1.1-inch diameter Delrin[®] or PVC available by special order.

(See reverse side for additional products)

Ordering Form (cont'd)

Water Level Monitoring

Quantity	Unit	Product	Product #	Price (\$)	Total
_____	ea	5 PSI Water Level sensor (with 50 ft. cable)	DRC-WTLO05-50	249	_____
_____	ea	15 PSI Water Level sensor (with 50 ft. cable)	DRC-WTLO15-50	249	_____
_____	ea	Water level data logger	DRC-100-E	219	_____
				Subtotal 3	_____

* Add \$1/ft. for additional cable length
 5 PSI sensors have 11.5 ft. sensing range, 15 PSI sensors have 34.5 ft. sensing range.
 Standard sensor has 0.8-inch diameter anodized aluminum housing. Also available in 1.1-inch diameter Delrin®.

Temperature Monitoring

Quantity	Unit	Product	Product #	Price (\$)	Total
_____	ea	Temperature logger (-25 to 39 deg.C)	DRC-ETK039-E	219	_____
_____	ea	Temperature logger (0 to 65 deg.C)	DRC-ETK064-E	219	_____
_____	ea	Temperature logger (0 to 128 deg. C)	DRC-ETK128-E	219	_____
_____	ea	Thermocouple sensor (with 15 ft. cable*)	DRC-TK024	65	_____
				Subtotal 4	_____

*Add \$.75/ft for additional cable length.
 Thermocouple is K-type, 24 awg., Teflon®, smp connector.

Low Pressure Monitoring

Quantity	Unit	Product	Product #	Price (\$)	Total
_____	ea	Low pressure sensor, +0.5" to -0.5" H ₂ O*	DRC-EPLO05	229	_____
_____	ea	Low pressure sensor, +0.1" to -0.1" H ₂ O*	DRC-EPLO10	229	_____
_____	ea	Low pressure sensor, +5" to -5" H ₂ O*	DRC-EPLO50	229	_____
_____	ea	Low pressure sensor, +10" to -10" H ₂ O*	DRC-EPL100	229	_____
_____	ea	Low pressure data logger	DRC-EPL508	219	_____
				Subtotal 5	_____

Additional pressure ranges are available on request.

System and Computer Interface/Additional Products

Quantity	Unit	Product	Product #	Price (\$)	Total
_____	ea	Software and User's Guide (for IBM PCs/compatibles)	DRC-TA312	59	_____
_____	ea	9-pin RS232 connecting cable	DRC-TA316	59	_____
_____	ea	25-pin RS232 connecting cable	DRC-TA317	59	_____
_____	ea	HP200LX Palmtop connector	DRC-TA318	59	_____
_____	ea	4-20 ma converter, external (for oxygen sensors)	DRC-XMC420A	79	_____
_____	ea	4-20 ma converter, internal (for oxygen sensors)	DRC-XMC420SE	59	_____
_____	ea	T connector (for networking up to 8 data loggers)	DRC-NET	59	_____
				Subtotal 6	_____

Subtotal of 1 through 6 _____
 (See front side for completion)

Note: All loggers can be networked and ship with NEMA 4X enclosures. A System Interface Kit should include: Data logger software and instructions, and communications adapters as appropriate to download data from the data recorder to a palmtop, laptop or other IBM PC compatible computer. Palmtop connector and 9- or 25-pin RS232 connectors are available. Multi-channel data loggers are available by special order.

SENSORS

Oxygen Sensor Specifications

DRC Part #:	XT252-XX, (were XX = length in feet.)
Sensor Type:	Electrochemical cell
Sensor Life :	≈ 7 years
Temperature Compensation:	Internal thermistor
Pressure Compensation:	None, (see pressure compensation notes)
Accuracy (full scale)	≈ 1% for oxygen depleting
Storage Temperature:	0 - 70° C.
Storage Orientation:	Vertical
Operating Orientation:	Vertical
Operating Temperature:	0 - 70° C.
Output Signal:	Milivolt or 4-20ma.
Maintenance Required:	None
Responce Time:	12 Sec. (5 min. for temp compensation)
Calibration Requirements:	Calibrate in air before installation. (see long term stability fig 1)
Installation Methods:	2" or larger monitoring well or directly burred in soil.

Influence of Various Gases,

Influence Level

Unaffected

Affected

Gas Type

CO₂, CO, H₂S, SO₂, H₂, CL₂, CFC's,

CH₄, N₂, etc...

Nh₃ (ammonia), Ozone

Datawrite Research Company
2140 S. Church St.
Visalia, CA. 93277

Specifications for interfacing DRC oxygen sensors via "Mv to 4-20 MA. Converter".
External 4-20 ma converter.. part number: XTM420-A.
Oxygen sensor with internal 4-20 MA converter option.. part number: XTM420-SE.

Drawing shows 4-20 ma converter internal to sensor.

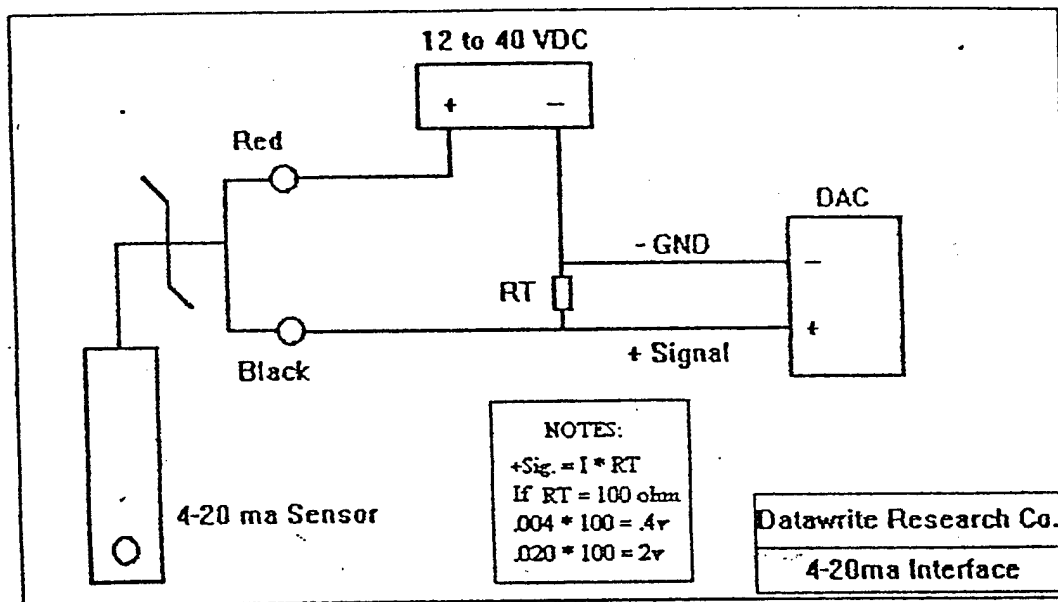

4-20 ma adapter response ... 0v = 4 ma., 2.5 Mv = 4.71 ma., 56.5 Mv = 20 ma.
See oxygen sensor specifications for more information.

**Model 8455/8465/8475
Air Velocity Transducer
Operation and Service
Manual**

August 1997

**Manuel
D'utilisation et D'entretien
Transducteur de Vitesse
Aérodynamique
Modèle 8455/8465/8475**

Août 1997

**Modell 8455/8465/8475
Luftgeschwindigkeitssonde
Bedienungs- und
Wartungshandbuch**

August 1997

**Manual de
Operación y Servicio del
Transductor de Velocidad del
Aire Modelo 8455/8465/8475**

Agosto 1997

P/N 1980239 Rev. A

TSI

TSI Incorporated

Specifications

Models 8455, 8465, 8475

	8455	8465	8475
Accuracy.....	±2.0% of reading ¹ ±0.5% of full scale of selected range	±2.0% of reading ¹ ±0.5% of selected full scale range	±3.0% of reading ² ±1.0% of selected full scale range
Repeatability.....	<±1.0% of reading ³	<±1.0% of reading ³	NA
Response Time to Flow...	0.2 sec ⁴	0.2 sec ⁴	5 sec ⁴

Common specifications to all models

Field Selectable Velocity Ranges

Model 8455/8465 0.125m/s to 1.0, 1.25, 1.50, 2.0, 2.5, 3.0, 4.0, 5.0, 7.5, 10.0, 12.5, 15.0, 20.0, 25.0, 30.0, 40.0, 50.0 m/s (25 ft/min to 200, 250, 300, 400, 500, 750, 1000, 1250, 3000, 4000, 5000, 7500, 10000 ft/min)

Model 8475 0.05 m/s to 0.5, 0.75, 1.00, 1.25, 1.50, 2.0, 2.5 m/s (10 ft/min to 100, 125, 150, 200, 250, 300, 400, 500 ft/min)

Minimum Resolution ..0.07% of selected full scale

Input Power 11-30 VDC or 18-28 VAC, 350mA max⁵

Output Impedance..... Voltage mode: less than 1 ohm, 20 mA max source current

Output Resistance..... Current mode: 500 ohms maximum load resistance

Output Signal (field selectable)0-5V, 0-10V, 1-5V, 2-10V, 0-20mA, 4-20mA

Output Time Constant (field selectable) 0.05 to 10 seconds.

Probe Length7.5 cm, 15 cm, 21.5 cm or 30 cm (3 in, 6 in, 9 in or 12 in)

Temperature Compensation Range: 0 to 60°C (32 to 140°F)

Sensor Operation: 0 to 93°C (32 to 200°F)

Electronics Operation: 0 to 93°C (32 to 200°F)

Storage: 0 to 93°C (32 to 200°F)

¹ from 18 to 28°C(64.4 to 82.4°F), outside this range add 0.2% per °C(0.11% per °F), within temperature compensation range.

² from 20 to 26°C(68 to 78.8°F), outside this range add 0.5% per °C(0.28 % per °F), within temperature compensation range.

³ Standard deviation based on one minute average from 0.5 to 5.0 m/s (100 to 1000 ft/min).

⁴ For 63% of final value, tested at 7.5 m/s (1000 ft/min).

⁵ Input voltage must be maintained within specifications at the transducer.

Calibration occurs with sensor oriented horizontally in a horizontal air flow.

Uncertainty increases in downward vertical flow at velocities less than 0.25 m/s (50 ft/min). Directional sensitivity of the Model 8475 is +5%/-20% of reading +0/-0.05 m/s (+0/-10 ft/min) over 270° solid angle regardless of flow direction.

SERIES 607 DIFFERENTIAL PRESSURE TRANSMITTER

Specifications - Installation and Operating Instructions

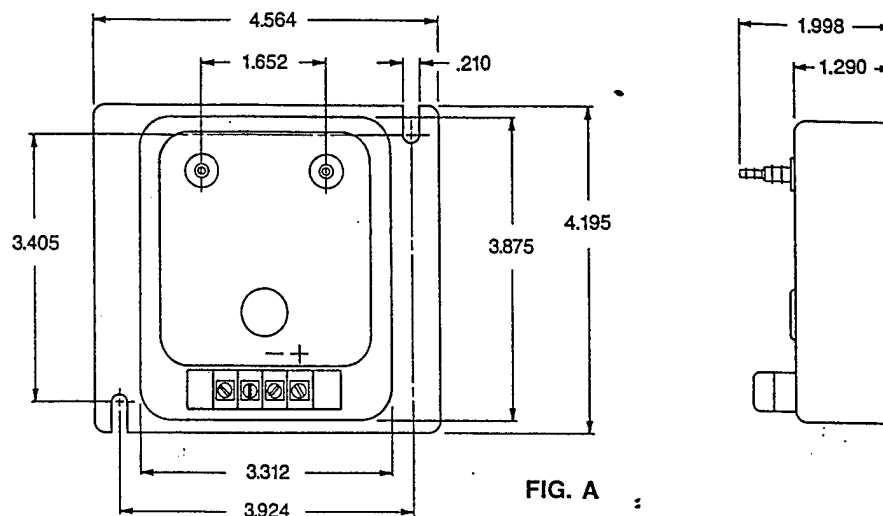
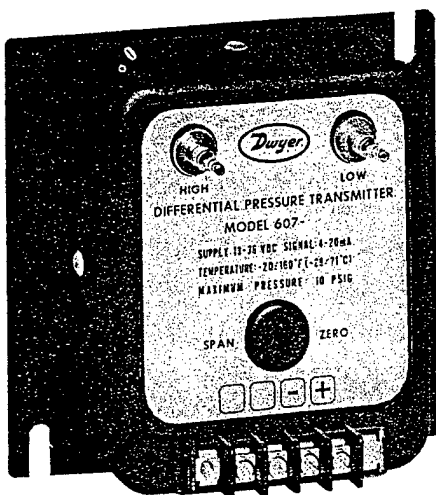

FIG. A

The Dwyer Series 607 Differential Pressure Transmitter converts positive, negative (vacuum) or differential pressures of clean, dry air or other non-conductive, non-corrosive gases into a standard two wire, 4-20 mA output signal. Several factory calibrated models are available with ranges from 0-10" W.C. to 0-25" W.C. All models employ a variable capacitance transducer with a micro-machined, ultra thin silicon diaphragm enabling precision measurement and control of very low pressures. The diaphragm deflects only a few microns yet measures accurately within $\pm 0.5\%$ of full span. Because no epoxies or other organics are used to seal the sensor, performance is exceptionally stable and drift free. It is also highly resistant to overpressure, shock and vibration. See specifications for complete details.

MODEL NUMBER	RANGE INCHES W.C.	MODEL NUMBER	RANGE INCHES W.C.
607-0	0-0.10	607-4	0-2.0
607-1	0-0.25	607-7	0-5.0
607-2	0-0.50	607-8	0-10
607-3	0-1.0	607-9	0-25

SPECIFICATIONS

GENERAL

Maximum Pressure: 10 psig
Media Compatibility: Air and non-conductive, non-corrosive gases.

ELECTRICAL:

Power Supply: 13-36 VDC unregulated
Output Signal: 4-20 mA DC, two wire
Loop Resistance: 0-1045 ohms
 $V_{min.} = 13V + [(0.022A)(R_L)]$
Current Consumption: 3.6 mA (min.)
Warm-up Time: 15 seconds

PERFORMANCE AT 70°F:

Output at zero: 4 mA
Output at full span: 20 mA
Accuracy: (Includes linearity, hysteresis, and repeatability) $\pm 0.5\%$ of full span output
Stability: $\pm 1\%$ of full span/year
Response Time: 250 msec maximum

TEMPERATURE LIMITS:

Operating: -20 to 160°F
(10-95% RH, non-condensing)
Compensated: 35 to 135°F
Storage: -40 to 180°F

MECHANICAL:

Housing: Epoxy coated steel (NEMA 2)
Pressure Connections: Dual barbed, 1/8" and 1/4" stainless steel
Weight: 14 ounces
Span and Zero: Factory set to specified range. Externally accessible for fine adjustment. Non-interactive.

DWYER INSTRUMENTS, INC.

P. O. BOX 373 • MICHIGAN CITY, INDIANA 46360, U.S.A.

Telephone 219/879-8000

Fax 219/872-9057 Telex 25916

INSTALLATION:

1. **LOCATION:** Select a clean, dry location free of excess vibration where the temperature of the unit will be between -20 and 160°F. Distance from the receiver is limited only by total loop resistance. See "Electrical Connections". The tubing supplying pressure to the transmitter can be run practically any distance. Long tubing lengths will not affect accuracy but response time will be increased slightly.
2. **POSITION:** The Series 607 Transmitter is not position sensitive. However it is recommended that you avoid mounting with pressure connections pointing up because of the chance of condensed moisture entering the interior. Moisture can also be avoided by routing tubing with a low point just ahead of the transmitter.
3. **MOUNTING:** Attach to mounting surface with two #8 or #10 screws in the mounting slots provided.
4. **PRESSURE CONNECTIONS:** The Series 607 Transmitter is shipped with a short length of tubing installed between the ports to keep the interior clean. Remove it and discard after unit is mounted. Connect positive (above atmospheric) pressure to port marked "HIGH" and vent the "LOW" port. Connect negative (vacuum) pressure to port marked "LOW" and vent the "HIGH" port. For differential pressures, connect the higher one to the "HIGH" port and the lower one to the "LOW" port.

ELECTRICAL CONNECTIONS:

CAUTION: DO NOT EXCEED SPECIFIED SUPPLY VOLTAGE RATING. PERMANENT DAMAGE NOT COVERED BY WARRANTY WILL RESULT. THIS UNIT IS NOT DESIGNED FOR AC VOLTAGE OPERATION.

Electrical connections to the Series 607 Transmitter are made to the two screws on the terminal strip labeled + and -. If polarity is inadvertently reversed, the loop will not function properly but no damage will be done to the transmitter because of internal circuit protection. An external power supply delivering 13 to 36 VDC with a minimum current capability of 25 milliamps must be used to power the control loop in which the transmitter is connected. Refer to Figure B for connection of the power supply, transmitter and receiver. The power required to generate the 4-20 mA output signal depends on the loop resistance of the circuit and is proportional to that resistance according to the graph and formula in Figure C. A shielded two conductor cable is recommended for control loop wiring. The maximum length that can be used in the current loop is a function of wire size and receiver resistance. Make sure the total loop resistance is within the operating region as shown in Figure C.

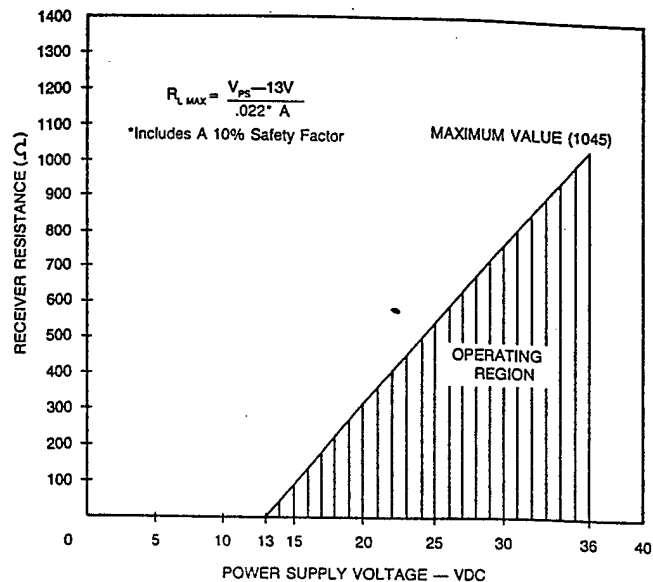
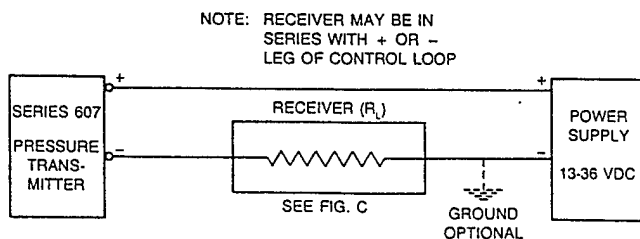

CALIBRATION

Each Series 607 Transmitter is factory calibrated to the range listed in the model number chart. Range is defined as that pressure which when applied to the transmitter will produce a 20 milliamp current in the loop. Zero pressure will produce 4 milliamps. If fine adjustment of calibration is required, use the following procedure:

1. With the transmitter connected to its' companion receiver, insert a milliammeter in series with the current loop. A controllable pressure source should be teed to the high pressure port of the transmitter and to an accurate pressure gage or manometer.
2. Apply electrical power to the system and allow 15 seconds for components to stabilize.
3. With no pressure applied to the transmitter remove blowout disc and adjust "zero" control so loop current is 4 mA.
4. Apply full span pressure and adjust loop current to 20 mA using "span" control.
5. Remove the milliammeter from the circuit, replace blowout disc, and place system in service.

MAINTENANCE/REPAIR

The Series 607 Differential Pressure Transmitter needs no routine maintenance. A periodic check of system calibration is recommended. These units are not field repairable and should be returned to the factory if service is required.



PS9000 SUBMERSIBLE PRESSURE TRANSMITTER

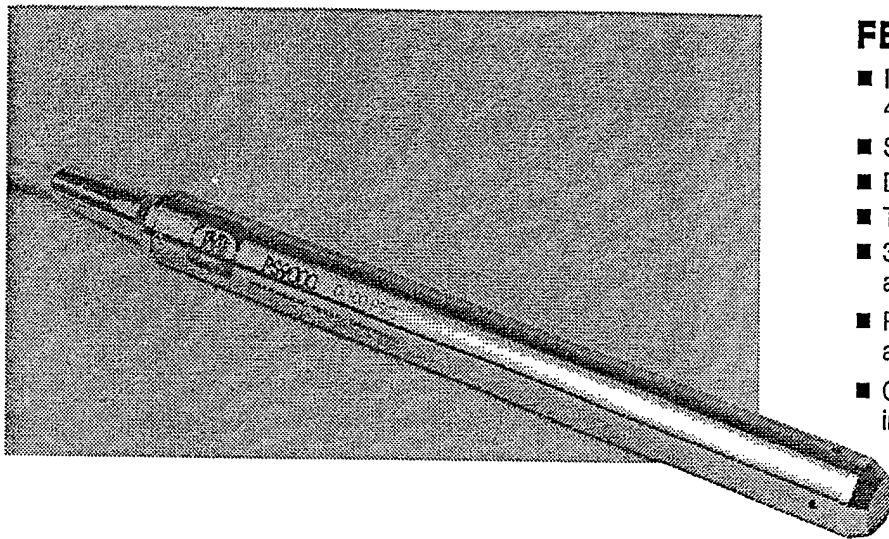

FEATURES

- Industry standard, two-wire, 4-20mA configuration
- Small diameter
- Double-sealing
- Temperature compensation
- 316 stainless steel, Viton® and Teflon® construction
- Polyethylene, polyurethane and FEP Teflon® cable options
- Competitive pricing, immediate availability

DESCRIPTION

INW's patented PS9000 submersible pressure transmitter is designed to provide accurate level measurement in most types of liquid environments. A 4-20mA output device, it features the latest in silicon, micro-machined, piezoresistive, strain gauge technology and is compatible with a wide range of measurement and control equipment.

The updated cable harness design reduces the probability of leakage and protects the cable jacket from damage by providing double-sealing; 316 stainless steel, Viton® and Teflon® construction increases corrosion resistance. The transmitter's end cone is inter-changeable with a 1/4" NPT inlet which allows for increased application use, easy hook-up and field calibration. The modular-designed PS9000 may be easily factory serviced and repaired.

OPERATION

The PS9000 pressure transmitter is powered by a datalogger or control system. The internal electronic circuit controls the amount of current flowing through the loop based on the signal from the internal pressure sensor. An above-surface probe will draw 20mA and once submerged, the current flow increases linearly with pressure (or depth). At full-scale pressure (depth), the transmitter will draw 20mA. A data acquisition/or control system then measures this current and computes the pressure or level.

APPLICATIONS

Due to its rugged construction and proven reliability, the PS9000 is used successfully to monitor groundwater, well, tank and tidal levels, as well as for pump testing and flow monitoring.

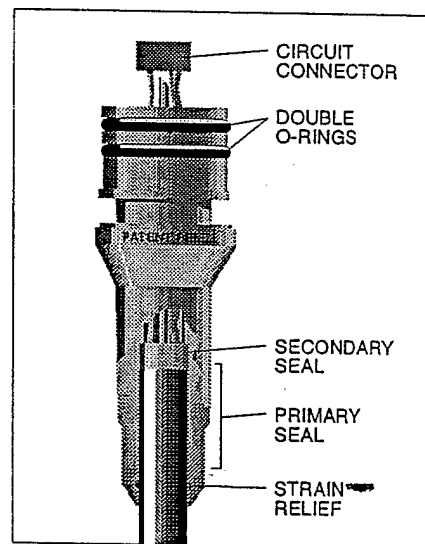

PS9000 cable harness design showing double seal and strain relief.



INSTRUMENTATION
NORTHWEST, INC.

1-800-776-9355

PS9000 SUBMERSIBLE PRESSURE TRANSMITTER

DIMENSIONS AND SPECIFICATIONS

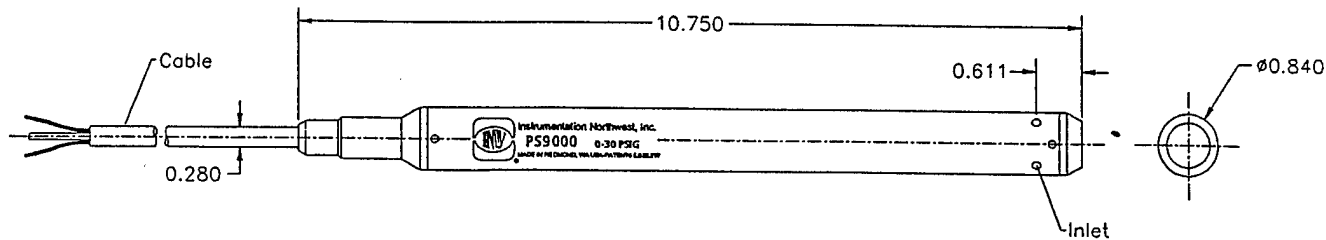

HOW TO ORDER

- Choose the transmitter with the required pressure range.
- Determine cable type and specify length.
- Pick the appropriate cable harness.
- For PSIG versions, select a high - or standard-capacity desiccant chamber or a vent tube protector.
- Contact INW for a full list of accessories.

MECHANICAL

TRANSMITTER

Body Material	316 stainless steel
Wire Seal Materials	Viton® and Teflon®
Desiccant	High- and standard-capacity packs available
Terminating Connector	Available
Weight	.75 lbs.

CABLE

Conductor Type	2-conductor
Vent Tube	Nylon
OD	0.28" maximum
Break Strength	138 lbs.
Maximum Length	2000 feet
Weight	4 lbs. per 100 feet

ELECTRICAL

Linearity/	±0.25% FSO (maximum)
Repeatability/	±0.1% FSO (typical)
Hysteresis at 20° C*	
Maximum	±0.5% FSO
Zero Offset at 20° C	
Sensitivity Accuracy	±0.25% FSO (maximum)
at 20° C	±0.125% FSO (typical)
Maximum Power	0.3% FSO
Supply Sensitivity	
Maximum	±2.0% FSO
Temperature Error	
Thermal Hysteresis	
Output typically return to within 0.25% FSO of its initial reading subsequent to one full cycle over the compensated temperature range	
Transmitter Voltage	9 - 24 VDC
Compensated	0 - 40° C
Temperature Range	
Operating	
Temperature Range	-5° C to 70° C
Over Range	2x (except 300 PSIA)
Protection	

*Best fit straight line

1-800-776-9355

PS9000 SUBMERSIBLE PRESSURE TRANSMITTER RANGES

3C205	5 PSIG	3C240	100 PSIG
3C215	15 PSIG	3C242	100 PSIA
3C230	30 PSIG	3C244	300 PSIA
3C235	50 PSIG		

PS9000 CABLE OPTIONS

6E499	Non-Vented, High-Density PE	6E505	Non-Vented PU
6E500	Vented PU	6E518	Vented FEP Teflon®
6E501	Vented, High-Density PE		

PS9000 CABLE HARNESS

3C145	Vented	3C144	Non-Vented
-------	--------	-------	------------

MISCELLANEOUS

6E410	1/4" NPT Adapter Kit	6E457	High-Capacity Desiccant Chamber
6E455	Standard-Capacity Desiccant Chamber	6E465	Vent tube Protector

Information in this document is subject to change without notice.

INSTRUMENTATION NORTHWEST, INC.



Sales and Service Locations
14962 NE 31st Circle, Redmond, Washington 98052 USA
(206) 895-3729 • (206) 867-0404 FAX • www.inwusa.com

4620 Northgate Boulevard, Suite 170 • Sacramento, California 95834
(916) 922-2900 • (916) 648-7766 FAX • www.inwusa.com

PRODUCTS

RGL

VERTICALITY PROBE

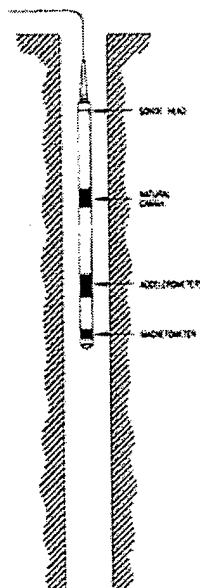

The RG verticality probe provides accurate, continuous measurements of borehole inclination and direction. These are output directly as log traces or processed further to produce tabular and graphical outputs of borehole position, borehole drift and true vertical depth.

The probe includes a triaxial magnetometer to deduce the probe bearing relative to magnetic North and two accelerometers to measure inclination. The outputs from the transducers are processed by a downhole microprocessor to give final borehole inclination and azimuth data in real time.

The operation of the probe is limited in steel casing or in the presence of magnetic minerals which affect the magnetometer. Under such conditions, only borehole inclination (without directional information) can be logged. The gyroscopic verticality probe should be used in preference to the standard verticality probe in these cases.

MEASUREMENTS

Direct:
Borehole inclination

Borehole direction
Derived:
Borehole drift
True vertical depth

APPLICATIONS:

Bed thickness estimation
Surveying and deviation checks
True seam depth

OPERATING CONDITIONS:

Max hole depth: 2000m
Borehole diameter: minimum 50mm
Borehole type: open or plastic cased; water / air-filled
Centralisation: non-magnetic centralisers required
Logging speed: 4 to 6m/min

SPECIFICATIONS

Diameter: 48mm
Length: 1.73m
Weight: 7kg
Maximum temperature: 60°C
Maximum pressure: 2MPa
Azimuth range: 0 to 360°
Azimuth accuracy: +/-2°
Inclination range: 0 to 30° / 0 to 70° (extended ranges available)
Inclination accuracy: +/-0.25° (30° range)
Natural gamma detector: NaI(TL) scintillation crystal
size: 50mm x 25mm (larger sizes available)

SALES INFORMATION

Probe:

- 25 095 000 Verticality probe 30°
- 25 097 000 - includes natural gamma
- 25 096 000 Verticality probe 70°
- 25 098 000 - includes natural gamma

Accessories:

- 21 035 000 Centraliser range 90 - 180mm (non-magnetic)
- 21 036 000 Centraliser range 180 - 260mm (non-magnetic)
- 21 037 000 Centraliser range 269 - 342mm (non-magnetic)
- 21 038 000 Centraliser range 342 - 472mm (non-magnetic)
- 20 071 000 Natural gamma API calibrator without source
- 30 010 000 3.7MBq ¹³⁷Cs source for natural gamma calibrator

*Enquire for higher temperature and pressure ratings.

Appendix G Cost Estimates

The attached cost estimating sheets were generated using the *Bioventing Cost Estimator (BVCE) and User's Guide* (NFESC, 1996). Some modifications were made to the cost estimating sheets generated by the BVCE with information that was available and specific to Castle Airport (*e.g.*, drilling costs and blower configuration).

Instrumentation and Monitoring Devices

Site Name and Location: PFFA
 Project Estimator: M. Phelps
 Estimation Date: 1/19/99

Estimated Parameters:

Area to be Biovented, Ac	2.6
Blower 2 HP, cfm	160
Radius of Influence, ft	110
Depth of Contamination, ft	60
Depth of Construction, ft	65
Number of Vent Wells, calculated	3
Number of Soil Gas MPs, calculated	3
Top of Screen (vent well), ft	25
Bottom of Screen (vent well), ft	65
Upper Screen Depth (SG MP), ft	25
Lower Screen Depth (SG MP), ft	55
Borehole Diameter (vent well), in	10
Borehole Diameter (SG MP well), in	8
Drill Rate, ft/hr	8
Soil Sample Spacing, 1/ft	15
Mob/Demob Distance, mi	200
Bulking Factor for Soil, unitless	1.3
Heterogeneity Factor (samples/well)	1
Screen Diameter, in	4
Screen Length, ft, calculated	40
SG MP Screen Interval, ft	15
Bentonite Plug Thickness, ft	5
Instrumentation Total Cost	\$1,760

User Options:

Rental	<input checked="" type="checkbox"/>	HNu rental
		Helium detector
Purchase	<input type="checkbox"/>	HNu purchase
		Helium detector
None	<input type="checkbox"/>	No Purchase

Instrumentation and Monitoring Device Item & Cost:

Item	Unit	Unit Cost	Number	Cost	Vendor/source
HNu rental	daily	\$85.00	6	\$510.00	Hazco
Helium detector, rental	weekly	\$370.00	2	\$740.00	Hazco
OVA Rental	daily	\$85.00	6	\$510.00	Hazco
Total				\$1,760.00	

Comments:

For instrument purchase prices (instead of rental), see FXCOSTS sheet.

Assumed that permeability tests will be performed over a manageable portion of the site.

Helium meter rented for helium tracer test during pilot testing

Soil Gas Survey

Site Name and Location: PFFA
 Project Estimator: M. Phelps
 Estimation Date: 1/19/99

Estimated Parameters:

Area to be Biovented, Ac	2.6
Blower 2 HP, cfm	160
Radius of Influence, ft	110
Depth of Contamination, ft	60
Depth of Construction, ft	65
Number of Vent Wells, calculated	3
Number of Soil Gas MPs, calculated	3
Top of Screen (vent well), ft	25
Bottom of Screen (vent well), ft	65
Upper Screen Depth (SG MP), ft	25
Lower Screen Depth (SG MP), ft	55
Borehole Diameter (vent well), in	10
Borehole Diameter (SG MP well), in	8
Drill Rate, ft/hr	8
Soil Sample Spacing, 1/ft	15
Mob/Demob Distance, mi	200
Bulking Factor for Soil, unitless	1.3
Heterogeneity Factor (samples/well)	1
Screen Diameter, in	4
Screen Length, ft, calculated	40
SG MP Screen Interval, ft	15
Bentonite Plug Thickness, ft	5
Soil Gas Survey Total Cost	\$8,635

Soil Gas Survey Item & Cost:

Item	Unit	Unit Cost	Number	Cost	Vendor/source
Carbon dioxide, size s3 10% bal N ₂	ea	\$124.00	2.6	\$322.40	Scott Specialty Gases
Hexane, size s3 4800 in air	ea	\$124.00	2.6	\$322.40	Scott Specialty Gases
Oxygen, size s3 10% balance N ₂	ea	\$124.00	2.6	\$322.40	Scott Specialty Gases
Demolition electric hammer	ea	\$1,600.00	0	\$0.00	KVA Associates
CPT Mob/Demob Rate	mile	\$3.00	400	\$1,200.00	Greg Drilling
CPT Rate (incl. grouting)	feet	\$8.50	180	\$1,530.00	Greg Drilling
CPT Soil Vapor Sample Collection	ea	\$150.00	12	\$1,800.00	Greg Drilling
CPT Soil Sample Collection	ea	\$100.00	12	\$1,200.00	Greg Drilling
Demolition hammer adaptor	ea	\$288.00	0	\$0.00	KVA Associates
Intercnctng nipple hollow Ni pltd	ea	\$23.00	0	\$0.00	KVA Associates
Intercnctng nipple solid S/S	ea	\$18.00	0	\$0.00	KVA Associates
Latex tubing 3/16 in I.D.	100 ft	\$52.58	1	\$52.58	NewAge Industries
Nylon tubing 1/4 in (natural)	50 ft pk	\$19.25	1	\$19.25	Cole-Parmer
Plastic flasks 250 ml	12/case	\$6.27	0	\$0.00	U.S. Plastics
Soil gas probe shaft section 2.5 ft	ea	\$255.00	0	\$0.00	KVA Associates
Soil probe jack adptr (special made)	ea	\$200.00	0	\$0.00	
Tedlar bags	10/box	\$82.00	5.2	\$426.40	SKC
Utility Jack	ea	\$100.25	0	\$0.00	Grainger
Well pt slotted intake assy 3 ft	ea	\$478.00	0	\$0.00	KVA Associates
Labor (1 geo)	hr	\$60.00	24	\$1,440.00	
Labor (2 techs)	hr	\$120.00	0	\$0.00	
Soil Gas Survey Total				\$8,635.43	

Comments:

Fixed Costs Independent of Site Size

Site Name and Location: PFFA
 Project Estimator: M. Phelps
 Estimation Date: 1/19/99

Purchase Options:

Valve tag stamps numbers 1/4 in <input checked="" type="checkbox"/>	GasTech 3250X CO ₂ /O ₂ <input checked="" type="checkbox"/>
Valve tag stamps letters 1/4 in <input type="checkbox"/>	GasTech GT105 TPH <input type="checkbox"/>
Valve tag stamps numbers 1/2 in <input type="checkbox"/>	Oil/Water interface probe 100 ft <input type="checkbox"/>
Valve tag stamps letters 1/2 in <input type="checkbox"/>	Water level probe 300 ft <input type="checkbox"/>

Fixed Costs Independent of Site Size:

Item	Unit	Unit Cost	Number	Cost	Vendor/source
Valve tag stamps numbers 1/4 in	ea	\$21.70	1	\$21.70	Seton
Valve tag stamps numbers 1/2 in	ea	\$42.70			Seton
Valve tag stamps letters 1/4 in	ea	\$56.20	1	\$56.20	Seton
Valve tag stamps letters 1/2 in	ea	\$111.80			Seton
GasTech 3250X CO ₂ /O ₂	ea	\$3,700.00	1	\$3,700.00	Control Analytics
GasTech GT105 TPH	ea	\$1,548.75			Control Analytics
HNu purchase	ea	\$4,620.00			Hazco
HNu carrying case	ea	\$250.00			Hazco
Helium detector	ea	\$4,500.00			Mark Products Inc.
Diluter kit OVA purchase	ea	\$750.00	1	\$750.00	Hazco
Flow meter, K72-05-0171	ea	\$135.40	1	\$135.40	King Instruments
GasTech GT105 test kit	ea	\$126.00	1	\$126.00	Control Analytics
HNu calibration kit	ea	\$109.80	1	\$109.80	Hazco
1/3 HP compressor/vacuum pump	ea	\$228.00	4	\$912.00	Grainger
Magnehelic gauge 0-0.25 in H ₂ O	ea	\$54.00	5	\$270.00	Dwyer
Magnehelic gauge 0-0.50 in H ₂ O	ea	\$47.00	5	\$235.00	Dwyer
Magnehelic gauge 0-2.0 in H ₂ O	ea	\$47.00	5	\$235.00	Dwyer
Magnehelic gauge 0-10 in H ₂ O	ea	\$47.00	5	\$235.00	Dwyer
Stop watch	ea	\$39.95	5	\$199.75	Fisher
Male connector 68PL-4-2	ea	\$1.31	30	\$39.30	Forberg Scientific
1/4 in tube x 1/8 in MPT connector	ea	\$1.52	30	\$45.60	Forberg Scientific
Tee swivel 172PL-4-2	ea	\$2.48	5	\$12.40	Forberg Scientific
Labor & material for Magnehelic	ea	\$135.00			Tim Goodrich
Oil/Water interface probe 100 ft	ea	\$1,665.00			ORS Env. Equip.
Water level probe 300 ft	ea	\$265.00			Forestry Suppliers
Pressure gauge 0-30 psi	ea	\$20.00	2	\$40.00	Cole-Parmer
Thermocouple readout (Fluke 52)	ea	\$199.00	2	\$398.00	Grainger
Vacuum gauge (high) 0-30 in H ₂ O	ea	\$192.85			Cole-Parmer
Vacuum gauge (low) 0-10 in H ₂ O	ea	\$192.85			Cole-Parmer
Valve 5-way multiport	ea	\$69.30	5	\$346.50	Scioto Valve
Total				\$7,867.65	

Comments:

For instrument rental costs, see instrumentation assembly.

Other Costs

Example of Other Costs:

<i>Design Costs:</i>	\$28,400
<i>Documentation Costs:</i>	
Health and Safety Plan	\$10,000
Pilot-scale Work Plan	\$10,000
Full-scale Remedial Action work Plan	\$25,000
Quality Assurance Program Plan (QAPP) or Contractor Quality Control (CQC) Plan	\$10,000
Project Final Report	\$50,000
Total Documentation Costs	\$105,000
<i>Site Closure (Sampling and Analysis) Costs:</i>	\$2,520
Number of Soil Samples Assumed	18
Number of Soil Vapor Samples Assumed	9
<i>Contingency Costs:</i>	\$26,200
<i>Total Other Costs</i>	\$162,120

Comments:

Labor is low due to overlap with respiration test.

Permeability Test:

Item	Unit	Unit Cost	Number	Cost	Vendor/source
Magnehelic gauge 0-0.25 in H ₂ O	ea	\$54.00			Dwyer
Magnehelic gauge 0-0.50 in H ₂ O	ea	\$47.00			Dwyer
Magnehelic gauge 0-2.0 in H ₂ O	ea	\$47.00			Dwyer
Magnehelic gauge 0-10 in H ₂ O	ea	\$47.00			Dwyer
Stop watch	ea	\$39.95			Cole-Parmer
Nylon tubing 1/4 in (natural)	50 ft pk	\$19.25	1	\$19.25	Cole-Parmer
Labor	hr	\$60.00	48	\$2,880.00	
Permeability Test Total				\$2,899.25	

Comments:

Number of items required defaults to zero due to the items being accounted for in *instrumentation*.

Respiration Test:

Item	Unit	Unit Cost	Number	Cost	Vendor/source
Latex tubing 3/16 in I.D.	100 ft	\$52.58	1	\$52.58	NewAge Industries
Tedlar bags	10/box	\$82.00	4	\$328.00	SKC
GasTech 3250X CO ₂ /O ₂	ea	\$3,700.00			Control Analytics
GasTech GT105 O ₂ /TPH	ea	\$1,548.75			Control Analytics
Carbon dioxide, size s3 10% bal N ₂	ea	\$124.00	4	\$496.00	Scott Specialty Gases
Hexane, size s3 4800 in air	ea	\$124.00	4	\$496.00	Scott Specialty Gases
Oxygen, size s3 10% balance N ₂	ea	\$124.00	4	\$496.00	Scott Specialty Gases
Thermocouple readout (Fluke 52)	ea	\$199.00			Grainger
Labor	hr	\$45.00	60	\$2,700.00	
Respiration Test Total				\$4,568.58	

Comments:

Assumed respiration tests will be performed on pilot scale system or manageable portion of system only.

TOTAL

\$28,626.69

Vent Well Installation

Site Name and Location: PFFA
 Project Estimator: M. Phelps
 Estimation Date: 1/19/99

Estimated Parameters:

Area to be Biovented, Ac	2.6
Blower 2 HP, cfm	160
Radius of Influence, ft	110
Depth of Contamination, ft	60
Depth of Construction, ft	65
Number of Vent Wells, calculated	3
Number of Soil Gas MPs, calculated	3
Top of Screen (vent well), ft	25
Bottom of Screen (vent well), ft	65
Upper Screen Depth (SG MP), ft	25
Lower Screen Depth (SG MP), ft	55
Borehole Diameter (vent well), in	10
Borehole Diameter (SG MP well), in	8
Drill Rate, ft/hr	8
Soil Sample Spacing, 1/ft	15
Mob/Demob Distance, mi	200
Bulking Factor for Soil, unitless	1.3
Heterogeneity Factor (samples/well)	1
Screen Diameter, in	4
Screen Length, ft, calculated	40
SG MP Screen Interval, ft	15
Bentonite Plug Thickness, ft	5
VW Installation Total Cost	\$13,011

User Option:

3-1/4 in Environ. soil sampling kit	<input checked="" type="checkbox"/>
PVC 2 in sch 40 screen 5 ft	<input type="checkbox"/>
PVC 2 in sch 40 screen 10 ft	<input checked="" type="checkbox"/>
PVC 4 in sch 40 screen 5 ft	<input type="checkbox"/>
PVC 4 in sch 40 screen 10 ft	<input type="checkbox"/>
PVC 2 in sch 40 casing 5 ft	<input type="checkbox"/>
PVC 2 in sch 40 casing 10 ft	<input checked="" type="checkbox"/>
PVC 4 in sch 40 casing 5 ft	<input type="checkbox"/>
PVC 4 in sch 40 casing 10 ft	<input type="checkbox"/>

Vent Well Installation Item & Cost:

Item	Unit	Unit Cost	Number	Cost	Vendor/source
Driller Mob/Demob of equipment	mile	\$3.00	400	\$1,200.00	Gregg Drilling
Driller travel	crew hr	\$60.00			Layne Env Services
Driller Per diem, per crew	crew day	\$168.00	3	\$504.00	Gregg Drilling
Driller charge rate, (labor & equip)	hour	\$210.00			Layne Env Services
Driller charge rate (labor & equip)	foot	\$25.00	130	\$3,250.00	Gregg Drilling
3-1/4 in Environmental soil sampling kit	ea	\$1,394.00	1	\$1,394.00	EnviroTech
55 gallon drum reconditioned (closed)	ea	\$25.00	19	\$475.00	Environmental Well
Misc. Safety	set	\$500.00	1	\$500.00	Estimate
Travel (2 people)	rnd trip	\$2,000.00			Estimate
Van rental	week	\$250.00	1	\$250.00	Estimate
per diem (1 per)	day	\$100.00	3	\$300.00	Estimate
labor (1 geo)	hr	\$60.00	30	\$1,800.00	Estimate
shipping	ea	\$50.00	13	\$650.00	Estimate
Analysis - TPH and BTEX (soil)	ea	\$75.00	9	\$650.00	Alpha Analytical Inc.
Analysis - Bulk density (soil)	ea	\$10.00	4	\$40.00	Alpha Analytical Inc.
Analysis - Grain size (soil)	ea	\$50.00	4	\$200.00	Alpha Analytical Inc.
Analysis - Particle density (soil)	ea	\$50.00	4	\$200.00	Alpha Analytical Inc.
Analysis - Total porosity (soil)	ea	\$7.00	4	\$28.00	Alpha Analytical Inc.
Bentonite chips, (assumed 0.75 ft ³)	bag	\$10.16	46	\$467.36	Unitek
Plastic cable ties 8 in long	100/bag	\$6.00	1	\$6.00	Instmnt Lab Estimt
PVC 2 in male/female pts/plugs	ea	\$3.85			Boundary Waters
PVC 2 in sch 40 screen 5 ft	ea	\$12.25			Boundary Waters
PVC 2 in sch 40 screen 10 ft	ea	\$17.90	12	\$214.80	Boundary Waters
PVC 4 in sch 40 screen 5 ft	ea	\$26.00			Boundary Waters
PVC 4 in sch 40 screen 10 ft	ea	\$43.00			Boundary Waters
PVC 2 in sch 40 casing 5 ft	ea	\$7.75			Boundary Waters
PVC 2 in sch 40 casing 10 ft	ea	\$19.00	8	\$152.00	Boundary Waters
PVC 4 in sch 40 casing 5 ft	ea	\$12.50			Boundary Waters
PVC 4 in sch 40 casing 10 ft	ea	\$31.50			Boundary Waters
Ball valve, 2 in	ea	\$20.74	3	\$62.22	Pipe Valves
Ball valve, 4 in	ea	\$163.81			Pipe Valves
Quickcrete ready mix, 80 lb bags	ea	\$3.69	3	\$11.07	Columbus Hardware
Silica sand, ft ³ /bag	bag	\$11.86	55	\$652.30	Unitek
Std brass valve tags 1.5 in natural	ea (1-99)	\$1.30	3	\$3.90	Seton
Total				\$13,010.65	

Comments:

Assumes one of the required VWs is already installed from the pilot test.

SG Monitoring Point Installation

Site Name and Location: PFFA
 Project Estimator: M. Phelps
 Estimation Date: 1/19/99

Estimated Parameters:

Area to be Biovented, Ac	2.6
Blower 2 HP, cfm	160
Radius of Influence, ft	110
Depth of Contamination, ft	60
Depth of Construction, ft	65
Number of Vent Wells, calculated	3
Number of Soil Gas MPs, calculated	3
Top of Screen (vent well), ft	25
Bottom of Screen (vent well), ft	65
Upper Screen Depth (SG MP), ft	25
Lower Screen Depth (SG MP), ft	55
Borehole Diameter (vent well), in	10
Borehole Diameter (SG MP well), in	8
Drill Rate, ft/hr	8
Soil Sample Spacing, 1/ft	15
Mob/Demob Distance, mi	200
Bulking Factor for Soil, unitless	1.3
Heterogeneity Factor (samples/well)	1
Screen Diameter, in	4
Screen Length, ft, calculated	40
SG MP Screen Interval, ft	15
Bentonite Plug Thickness, ft	5
SG MP Installation Total Cost	\$13,468

User Option:

3-1/4 in Environ. soil sampling kit

Soil Gas Monitoring Point Item & Cost:

Item	Unit	Unit Cost	Number	Cost	Vendor/source
Driller Per diem, per crew	crew day	\$168.00	2	\$336.00	Gregg Drilling
Driller charge rate (labor & equip)	hour	\$210.00			Layne Env Services
Driller charge rate (labor & equip)	foot	\$35.00	130	\$4,550.00	Gregg Drilling
3-1/4 in Environmental soil sampling kit	ea	\$1,394.00	1	\$1,394.00	EnviroTech
55 gallon drum reconditioned (closed)	ea	\$25.00	13	\$325.00	Environmental Wells
Analysis - TPH and BTEX (soil)	ea	\$75.00	9	\$650.00	Alpha Analytical Inc.
Analysis - Bulk density (soil)	ea	\$10.00	4	\$40.00	Alpha Analytical Inc.
Analysis - Grain size (soil)	ea	\$50.00	4	\$200.00	Alpha Analytical Inc.
Analysis - Particle density (soil)	ea	\$50.00	4	\$200.00	Alpha Analytical Inc.
Analysis - Total porosity (soil)	ea	\$7.00	4	\$28.00	Alpha Analytical Inc.
Misc. Safety	set	\$500.00			Estimate
Travel (2 people)	md trip	\$2,000.00			Estimate
Van rental	week	\$250.00	1	\$250.00	Estimate
per diem (1 geo)	day	\$100.00	3	\$300.00	Estimate
labor (1 geo)	hr	\$60.00	25	\$1,500.00	Estimate
shipping	ea	\$50.00	13	\$650.00	Estimate
Al flush mount well cover (8 in solid)	ea	\$98.42	3	\$295.26	Global Drilling
Bentonite chips (assumed 0.75 ft ³)	bag	\$10.16	33	\$335.28	Unitek
Quickcrete ready mix, 80 lb bags	ea	\$3.69	3	\$11.07	Columbus Hardware
Silica sand (assumed 3/4 ft ³)	bag	\$11.86	45	\$533.70	Unitek
Mini male thermocouple plug	ea	\$3.18	2	\$6.36	Instrmnt Lab Estim
Thermocouple wire (type K) 125 ft	roll	\$62.83	1	\$62.83	L.H. Marshall
MPT male connector 3/8 in X 1/4 in tube	ea	\$1.31	11	\$14.41	NewAge Industries
Nylon tubing 1/4 in	50 ft pk	\$19.25	9	\$173.25	Cole-Parmer
Plastic cable ties 8 in long	100/bag	\$6.00	7.8	\$46.80	Instrmnt Lab Estim
Qck cnct F X 1/4 in tube 4Z-Q4CN-BBP	ea	\$12.10	11	\$133.10	Forberg Scientific
Qck cnct protector CP-Q4C-BB	ea	\$5.01	11	\$55.11	Forberg Scientific
Std brass valve tags 1.5 in natural	ea	\$1.30	11	\$14.30	Seton
Suction strainer (monitoring pt) 3/4 in	ea	\$6.72	11	\$73.92	Grainger
Gravel for suction screen 50 lbs	bag	\$20.00	1	\$20.00	Estimate
Vapor samples 1L SUMMA, TPH/BTEX	ea	\$130.00	7	\$910.00	Air Toxics LTD.
Labor (1 geo)	hr	\$60.00	6	\$360.00	
Total				\$13,468.39	

Comments:

Driller mobilization/demobilization is accounted for in the vent well installation assembly.

Travel costs are accounted for in the vent well installation assembly.

Assumes one of the required VMPs is installed during the pilot test.

Blower System Installation

Site Name and Location: PFFA
 Project Estimator: M. Phelps
 Estimation Date: 1/19/99

Estimated Parameters:

Area to be Biovented, Ac	2.6
Blower 2 HP, cfm	160
Radius of Influence, ft	110
Depth of Contamination, ft	60
Depth of Construction, ft	65
Number of Vent Wells, calculated	3
Number of Soil Gas MPs, calculated	3
Top of Screen (vent well), ft	25
Bottom of Screen (vent well), ft	65
Upper Screen Depth (SG MP), ft	25
Lower Screen Depth (SG MP), ft	55
Borehole Diameter (vent well), in	10
Borehole Diameter (SG MP well), in	8
Drill Rate, ft/hr	8
Soil Sample Spacing, 1/ft	15
Mob/Demob Distance, mi	200
Bulking Factor for Soil, unitless	1.3
Heterogeneity Factor (samples/well)	1
Screen Diameter, in	4
Screen Length, ft, calculated	40
SG MP Screen Interval, ft	15
Bentonite Plug Thickness, ft	5
Blower System Installation Total Cost	\$20,762

User Options:

PVC 2 in 90 deg elbow sch 40	<input checked="" type="checkbox"/>
PVC 2 in sch 40 pipe	<input checked="" type="checkbox"/>
PVC 2 in coupler sch 40	<input checked="" type="checkbox"/>
PVC 2 in sch 40 Tee	<input checked="" type="checkbox"/>
PVC 4 in 90 deg elbow sch 40	<input type="checkbox"/>
PVC 4 in sch 40 pipe	<input type="checkbox"/>
PVC 4 in coupler sch 40	<input type="checkbox"/>
PVC 4 in sch 40 Tee	<input type="checkbox"/>
PVC 2 in 90 deg elbow sch 80	<input type="checkbox"/>
PVC 2 in sch 80 pipe	<input type="checkbox"/>
PVC 2 in coupler sch 80	<input type="checkbox"/>
PVC 2 in sch 80 Tee	<input type="checkbox"/>
PVC 4 in 90 deg elbow sch 80	<input type="checkbox"/>
PVC 4 in sch 80 pipe	<input type="checkbox"/>
PVC 4 in coupler sch 80	<input type="checkbox"/>
PVC 4 in sch 80 Tee	<input type="checkbox"/>
Trenching & Excavation	<input checked="" type="checkbox"/>

Blower System Installation Item & Cost:

Item	Unit	Unit Cost	Number	Cost	Vendor/source
Explosion-proof regenerative blower	ea	\$1,019.15	1	\$1,019.15	Isaacs
Blower inlet filter with filter cover	ea	\$115.00	1	\$115.00	Grainger
Electrical parts/set-up	total	\$3,000.00	1	\$3,000.00	Atwater Electric
PVC 2 in to 1-1/2 in reducing bushing	ea	\$4.98	1	\$4.98	U.S. Plastics
PVC 1-1/2 in cap sch 80	ea	\$7.71			U.S. Plastics
PVC 1-1/2 in 90 deg elbow sch 80	ea	\$2.62	1	\$2.62	U.S. Plastics
PVC 1-1/2 in sch 80 pipe	100 ft	\$160.29	0.02	\$3.21	U.S. Plastics
Magnehelic gauge 0 - 100 in H ₂ O	ea	\$47.00	1	\$47.00	Dwyer
Magnehelic gauge 0 - 100 in H ₂ O	ea	\$49.00	1	\$49.00	Dwyer
Anemometer, hot wire	ea	\$795.00	1	\$795.00	TSI Inc
PVC cement	quart	\$12.32	5.2	\$64.06	U.S. Plastics
PVC primer	quart	\$9.56	5.2	\$49.71	U.S. Plastics
PVC 2 in end cap sch 40	ea	\$0.82			U.S. Plastics
PVC 2 in 90 deg elbow sch 40	ea	\$1.21	15.6	\$18.88	U.S. Plastics
PVC 2 in sch 40 pipe	20 ft	\$23.48	42.5	\$997.90	U.S. Plastics
PVC 2 in coupling sch 40	ea	\$0.73	42.5	\$31.03	U.S. Plastics
PVC 2 in sch 40 Tee	ea	\$1.49	3	\$4.47	U.S. Plastics
PVC 4 in end cap sch 40	ea	\$6.54			U.S. Plastics
PVC 4 in 90 deg elbow sch 40	ea	\$7.85			U.S. Plastics
PVC 4 in sch 40 pipe	20 ft	\$69.00			U.S. Plastics
PVC 4 in coupler sch 40	ea	\$3.60			U.S. Plastics
PVC 4 in sch 40 Tee	ea	\$11.65			U.S. Plastics
PVC 2 in end cap sch 80	ea	\$7.71			U.S. Plastics
PVC 2 in 90 deg elbow sch 80	ea	\$2.62			U.S. Plastics
PVC 2 in sch 80 pipe	20 ft	\$32.00			U.S. Plastics
PVC 2 in coupler sch 80	ea	\$3.25			U.S. Plastics
PVC 2 in sch 80 Tee	ea	\$9.30			U.S. Plastics
PVC 4 in end cap sch 80	ea	\$31.09			U.S. Plastics
PVC 4 in 90 deg elbow sch 80	ea	\$10.46			U.S. Plastics
PVC 4 in sch 80 pipe	20 ft	\$95.68			U.S. Plastics
PVC 4 in coupler sch 80	ea	\$11.52			U.S. Plastics
PVC 4 in sch 80 Tee	ea	\$14.65			U.S. Plastics
Trenching Costs	ft	\$16.00	850	\$13,600.00	Marcor
Labor	hr	\$60.00	16	\$960.00	
Total				\$20,762.00	

Comments:

Assumed manifold to be 3 rows of 5 vent wells each.
 For Pilot test, only one (1) vent well will be installed and operated, however, the cost for full system manifold construction are included. One blower was purchased for pilot test; only use this blower cost to scale up to full site size.
 Number of blowers required based on replacement of soil void volume every 1 day, assuming porosity of 0.3, and blower flowrate into soil is 0.25 of blower capacity.

Appendix H

Sample Calculation for Radius of Influence Estimate

A method for estimating the required air flow rate to meet the maximum demand of the microorganisms is provided in Section 2.2 of Volume II of the USEPA bioventing protocol (USEPA ORD, 1995):

$$Q = \frac{k_o \cdot V \cdot \theta_a}{(C_{\max} - C_{\min})} \quad (\text{H-1})$$

where:

- Q = volumetric air flow rate [cubic feet per day (cfd)]
- k_o = oxygen-utilization rate (*in situ* respiration rate) [%/day]
- V = volume of contaminated soil [cubic feet]
- θ_a = air-filled porosity [volume air/volume soil]
- C_{max} = oxygen concentration of background/injected air [%] (typically 20.9%)
- C_{min} = minimum oxygen concentration for aerobic conditions [%] (typically 5.0%)

Assuming that the volume of contaminated soil which is being treated by air injection is cylindrical (resulting from air injection at one central vent well):

$$V = \pi \cdot R_i^2 \cdot h \quad (\text{H-2})$$

where:

- V = volume of treated soil [cubic feet]
- R_i = radius of influence [feet]
- h = thickness of treated soil [feet] (typically screened interval or total thickness of permeable soil through which air flows)

Equation (H-1) can be rearranged and combined with Equation (H-2) to solve for the radius of influence, R_i, which can be achieved at a given air flow rate, Q:

$$R_i = \sqrt{\frac{Q \cdot (C_{\max} - C_{\min})}{\pi \cdot h \cdot k_o \cdot \theta_a}} \quad (\text{H-3})$$

Using the data from Test 4 presented in Table 6:

- | | |
|------------------------------------|----------------------------|
| Q = 175,000 cf/52 days = 3,365 cfd | h = 35 feet |
| C _{max} = 20.9 % | k _o = 1.0 %/day |
| C _{min} = 5.0 % | θ _a = 0.27 |

and substituting into Equation (H-3):

$$R_i = \sqrt{\frac{3365 \cdot (20.9 - 5.0)}{\pi \cdot 35 \cdot 1.0 \cdot 0.27}} = 42 \text{ feet.}$$

PFFABOS02
MERCED
04-08-98

Start Depth 5 feet
End Depth 58
Markers 10

True North

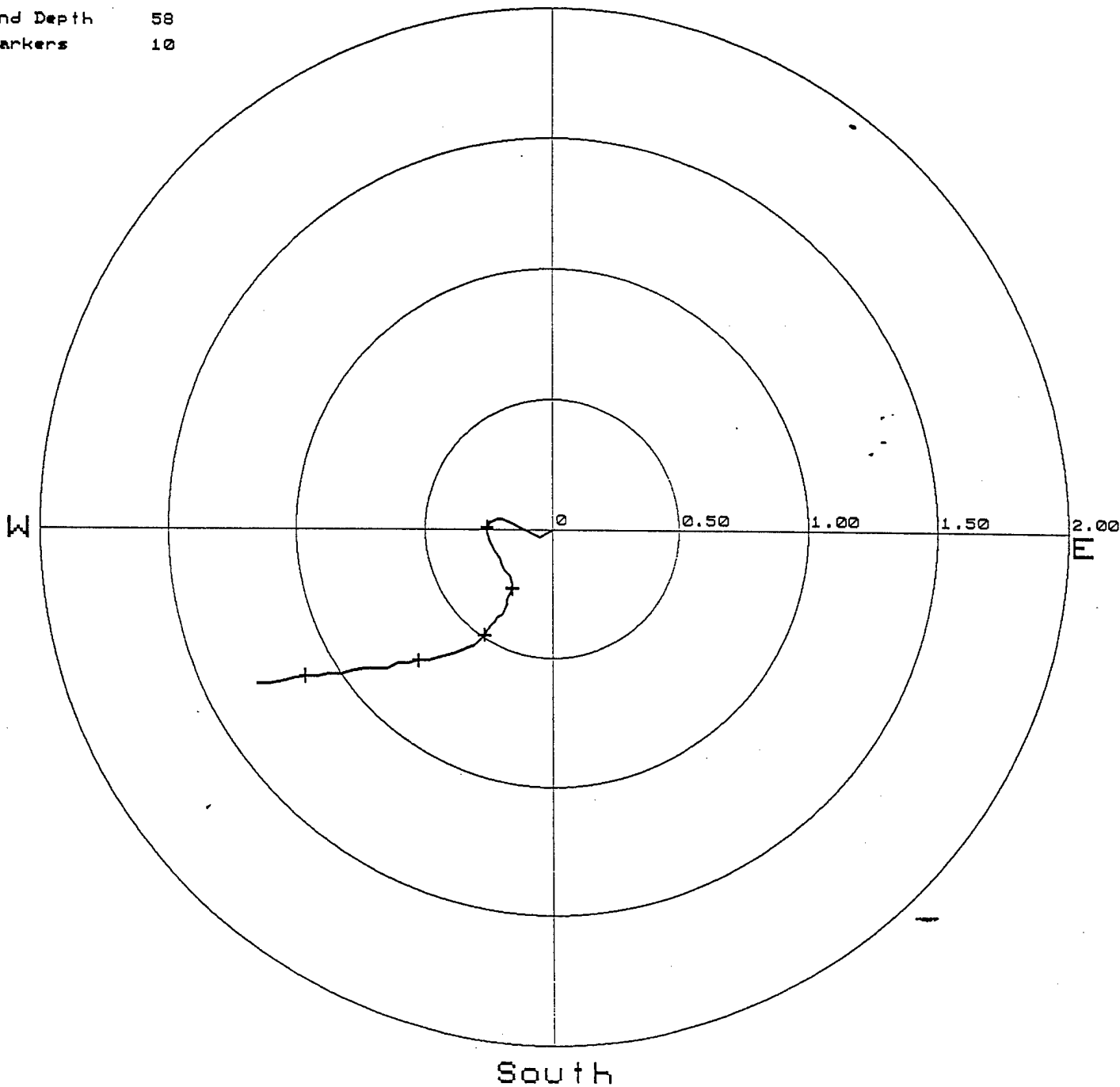

Robertson Geologging Ltd. - Verticality Analysis