

NAVAL POSTGRADUATE SCHOOL
Monterey, California



THESIS

**ABSOLUTE CALIBRATION TECHNIQUES FOR UV
SPECTROSCOPY BASED UPON PLATINUM EMISSION
LINE SPECTRA**

by

Daniel W. Kuriger

December 2001

Thesis Advisor:
Co-Advisor:

D. Scott Davis
Richard Harkins

Approved for public release; distribution is unlimited.

Report Documentation Page

Report Date 19Dec2001	Report Type N/A	Dates Covered (from... to) -
Title and Subtitle Absolute Calibration Techniques for UV Spectroscopy Based Upon Platinum Emission Line Spectra	Contract Number	
	Grant Number	
	Program Element Number	
Author(s) Kuriger, Daniel	Project Number	
	Task Number	
	Work Unit Number	
Performing Organization Name(s) and Address(es) Naval Postgraduate School Monterey, California	Performing Organization Report Number	
Sponsoring/Monitoring Agency Name(s) and Address(es)	Sponsor/Monitor's Acronym(s)	
	Sponsor/Monitor's Report Number(s)	
Distribution/Availability Statement Approved for public release, distribution unlimited		
Supplementary Notes The original document contains color images.		
Abstract		
Subject Terms		
Report Classification unclassified	Classification of this page unclassified	
Classification of Abstract unclassified	Limitation of Abstract UU	
Number of Pages 83		

THIS PAGE INTENTIONALLY LEFT BLANK

REPORT DOCUMENTATION PAGEForm Approved OMB No.
0704-0188

Public reporting burden for this collection of information is estimated to average 1 hour per response, including the time for reviewing instruction, searching existing data sources, gathering and maintaining the data needed, and completing and reviewing the collection of information. Send comments regarding this burden estimate or any other aspect of this collection of information, including suggestions for reducing this burden, to Washington headquarters Services, Directorate for Information Operations and Reports, 1215 Jefferson Davis Highway, Suite 1204, Arlington, VA 22202-4302, and to the Office of Management and Budget, Paperwork Reduction Project (0704-0188) Washington DC 20503.

1. AGENCY USE ONLY (Leave blank)	2. REPORT DATE December 2001	3. REPORT TYPE AND DATES COVERED Master's Thesis
4. TITLE AND SUBTITLE Absolute Wavelength Calibration Techniques for UV Spectroscopy Based Upon Platinum Emission Line Spectra		5. FUNDING NUMBERS
6. AUTHOR (S) Kuriger, Daniel W.		
7. PERFORMING ORGANIZATION NAME(S) AND ADDRESS(ES) Naval Postgraduate School Monterey, CA 93943-5000		8. PERFORMING ORGANIZATION REPORT NUMBER
9. SPONSORING / MONITORING AGENCY NAME(S) AND ADDRESS(ES)		10. SPONSORING/MONITORING AGENCY REPORT NUMBER

11. SUPPLEMENTARY NOTES The views expressed in this thesis are those of the author and do not reflect the official policy or position of the U.S. Department of Defense or the U.S. Government.

12a. DISTRIBUTION / AVAILABILITY STATEMENT Approved for public release; distribution is unlimited.	12b. DISTRIBUTION CODE
--	-------------------------------

13. ABSTRACT (maximum 200 words)

Imaging spectrometry requires precise knowledge of wavelength in order to perform various spectral analyses. This thesis project was tasked with performing wavelength calibration as part of the ongoing development of the Naval Postgraduate School's Lineate Imaging Near Ultraviolet Spectrometer (LINUS). This calibration was necessary for the ability of LINUS to detect, to classify, and to quantify several different chemical species by observation over the near-ultraviolet wavelength band of 200 to 400 nm.

Experiments were conducted to detect diffracted emission lines from a platinum hollow cathode lamp by using the LINUS optical train and five different UV filters. A Matlab program was developed to compare the catalogued wavelengths of this known ultraviolet source with the emission line positions observed on the LINUS detector. Affine transformation and cross-correlation of the data produced wavelength calibration curves for the LINUS detector in each of the five associated UV wavelength regions.

14. SUBJECT TERMS Calibration, Hyperspectral, Sensors, Spectral Imaging, Spectrometer, Remote Sensing, Ultraviolet		15. NUMBER OF PAGES	
17. SECURITY CLASSIFICATION OF REPORT Unclassified	18. SECURITY CLASSIFICATION OF THIS PAGE Unclassified	19. SECURITY CLASSIFICATION OF ABSTRACT Unclassified	20. LIMITATION OF ABSTRACT UL

THIS PAGE INTENTIONALLY LEFT BLANK

Approved for public release; distribution is unlimited.

**ABSOLUTE CALIBRATION TECHNIQUES FOR UV SPECTROSCOPY BASED
UPON PLATINUM EMISSION LINE SPECTRA**

Daniel W. Kuriger
Lieutenant, United States Navy
B.S., San Diego State University, 1994

Submitted in partial fulfillment of the
requirements for the degree of

MASTER OF SCIENCE IN APPLIED PHYSICS

from the

**NAVAL POSTGRADUATE SCHOOL
December 2001**

Author:

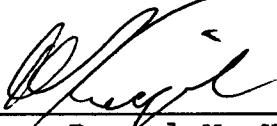

Daniel W. Kuriger

Approved by:



D. Scott Davis, Thesis Advisor



Richard Harkins, Co-Advisor



William B. Maier II, Chairman
Department of Physics

THIS PAGE INTENTIONALLY LEFT BLANK

ABSTRACT

Imaging spectrometry requires precise knowledge of wavelength in order to perform various spectral analyses. This thesis project was tasked with performing wavelength calibration as part of the ongoing development of the Naval Postgraduate School's Lineate Imaging Near Ultraviolet Spectrometer (LINUS). This calibration was necessary for the ability of LINUS to detect, to classify, and to quantify several different chemical species by observation over the near-ultraviolet wavelength band of 200 to 400 nm.

Experiments were conducted to detect diffracted emission lines from a platinum hollow cathode lamp by using the LINUS optical train and five different UV filters. A Matlab program was developed to compare the catalogued wavelengths of this known ultraviolet source with the emission line positions observed on the LINUS detector. Affine transformation and cross-correlation of the data produced wavelength calibration curves for the LINUS detector in each of the five associated UV wavelength regions.

THIS PAGE INTENTIONALLY LEFT BLANK

TABLE OF CONTENTS

I. INTRODUCTION.....	1
A. PROJECT CONTEXT.....	1
B. PROJECT OBJECTIVE.....	1
C. OUTLINE.....	2
II. BACKGROUND.....	3
A. SPECTRAL IMAGING.....	3
B. LINUS.....	6
III. EXPERIMENTAL MEASUREMENTS.....	11
A. PURPOSE.....	11
B. EXPERIMENTAL SETUP.....	12
C. DATA COLLECTION.....	17
IV. DATA ANALYSIS.....	23
A. OVERVIEW.....	23
B. COMPUTATIONAL THEORY.....	23
1. Preprocessing of Platinum Standard Spectral Data.....	23
2. Preprocessing of LINUS Data.....	26
3. Pattern Matching and Cross-correlation.....	27
V. RESULTS.....	33
A. OVERVIEW.....	33
B. 220NM FILTER.....	33
C. 289NM FILTER.....	36
D. 300NM FILTER.....	39
E. 334NM FILTER.....	42
F. 370NM FILTER.....	45
VI. CONCLUSIONS AND RECOMMENDATIONS.....	49
APPENDIX: WAVELENGTH CALIBRATION PROGRAM CODE.....	51
LIST OF REFERENCES.....	65
INITIAL DISTRIBUTION LIST.....	67

THIS PAGE INTENTIONALLY LEFT BLANK

LIST OF FIGURES

Figure 1.	Hyperspectral Cube of Industrial Smokestacks, Recorded by NUVIS (From Marino,10).....	5
Figure 2.	LINUS Field-Support Equipment.....	7
Figure 3.	LINUS Optical Design.....	10
Figure 4.	Pt Hollow-Cathode Lamp and DC Power Supply...	13
Figure 5.	Placement of Pt Lamp Along Optical Axis.....	13
Figure 6.	Filter Transmission Curve: 220BP10.....	15
Figure 7.	Filter Transmission Curve: 289BP10.....	15
Figure 8.	Filter Transmission Curve: 300BP10.....	16
Figure 9.	Filter Transmission Curve: 334BP10.....	16
Figure 10.	Filter Transmission Curve: 370BP10.....	17
Figure 11.	Diffraction Emission Lines: 220nm Filter.....	19
Figure 12.	Diffraction Emission Lines: 289nm Filter.....	19
Figure 13.	Diffraction Emission Lines: 300nm Filter.....	20
Figure 14.	Diffraction Emission Lines: 334nm Filter.....	20
Figure 15.	Diffraction Emission Lines: 370nm Filter.....	21
Figure 16.	Removal of Low Intensity Emission Lines.....	25
Figure 17.	Simulated Broadening and Filtering of Representative Platinum Spectra in the 3200-3700 Angstrom Spectral Region.....	26
Figure 18.	LINUS Image Capture and Preprocessing:.....	27
Figure 19.	Cross-Correlation Peak vs. Elongation Factor.	29
Figure 20.	Correlogram Showing Peak at Best Shift.....	29
Figure 21.	Aligned LINUS and NIST Data.....	30
Figure 22.	Wavelength Calibration Curve.....	31
Figure 23.	Pt Standard Preprocessing: 220nm Filter.....	34
Figure 24.	Raw LINUS Image of Pt Spectrum Using 220 nm Filter.....	34
Figure 25.	Coadded Pt Spectrum and Threshold Subtraction Using 220nm Filter.....	35
Figure 26.	Data Alignment Using 220nm Filter.....	35
Figure 27.	Wavelength Calibration Curve Using 220 nm Filter.....	36
Figure 28.	Pt Standard Preprocessing: 289nm Filter.....	37
Figure 29.	Raw LINUS Image of Pt Spectrum Using 289 nm Filter.....	37
Figure 30.	Coadded Pt Spectrum and Threshold Subtraction Using 289nm Filter.....	38
Figure 31.	Data Alignment Using 289nm Filter.....	38
Figure 32.	Wavelength Calibration Curve Using 289 nm Filter.....	39

Figure 33.	Pt Standard Preprocessing: 300nm Filter.....	40
Figure 34.	Raw LINUS Image of Pt Spectrum Using 300 nm Filter.....	40
Figure 35.	Coadded Pt Spectrum and Threshold Subtraction Using 300nm Filter.....	41
Figure 36.	Data Alignment Using 300nm Filter.....	41
Figure 37.	Wavelength Calibration Curve Using 300 nm Filter.....	42
Figure 38.	Pt Standard Preprocessing: 334nm Filter.....	43
Figure 39.	Raw LINUS Image of Pt Spectrum Using 334 nm Filter.....	43
Figure 40.	Coadded Pt Spectrum and Threshold Subtraction Using 334nm Filter.....	44
Figure 41.	Data Alignment Using 334nm Filter.....	44
Figure 42.	Wavelength Calibration Curve Using 334 nm Filter.....	45
Figure 43.	Pt Standard Preprocessing: 370nm Filter.....	46
Figure 44.	Raw LINUS Image of Pt Spectrum Using 370 nm Filter.....	46
Figure 45.	Coadded Pt Spectrum and Threshold Subtraction Using 370nm Filter.....	47
Figure 46.	Data Alignment Using 370nm Filter.....	47
Figure 47.	Wavelength Calibration Curve Using 370 nm Filter.....	48

LIST OF TABLES

Table 1.	UV Filter Characteristics.....	14
Table 2.	Minimum χ^2 Parameters for Calibration Results Associated with Spectral Region of Each Filter....	33

THIS PAGE INTENTIONALLY LEFT BLANK

ACKNOWLEDGEMENTS

The author would like to thank Dr. D.S. Davis and Mr. Richard Harkins for their guidance during this project. Special thanks are due to Ms. Sarah Grindle, who introduced the exciting world of physics to countless young students. Finally, the author would like to extend his deepest gratitude and admiration to his wife, Victoria, for her unending love and patience. This thesis could not have been completed without her unwavering support.

THIS PAGE INTENTIONALLY LEFT BLANK

I. INTRODUCTION

A. PROJECT CONTEXT

The completion of this thesis project marked the passing of another milestone in the continued development of the Naval Postgraduate School's Lineate Imaging Near Ultraviolet Spectrometer (LINUS). Upon becoming fully operational, the LINUS instrument will be the third imaging spectrometer designed and constructed at NPS and will possess greatly improved capabilities over its forerunners.

The study of remote sensing has produced significant experience with imaging spectrometers in the NPS Physics Department. The first such instrument, the Dual-Use Ultra-Violet Imaging Spectrometer (DUUVIS), was completed in 1996. In 1997 a follow-on instrument, the Naval Postgraduate School Ultra-Violet Imaging Spectrometer (NUVIS), possessed notably improved capabilities over its predecessor. NUVIS demonstrated the ability to accurately detect and quantify SO₂ emissions present in distant chemical plumes (Marino,75). Following the successful use of NUVIS to detect a single potentially hazardous chemical species, the LINUS project was conceived. LINUS was designed for significantly enhanced capability over NUVIS, especially with regard to the measurement of spectral images over a much larger wavelength band at improved sensitivities.

B. PROJECT OBJECTIVE

Spectral image data from the LINUS instrument consists of intensity measurements as a function of spectral

wavelength and of two-dimensional spatial coordinates within an image. In order for wavelength data to be useful for analyses such as chemical identification via spectral absorption, an accurate wavelength calibration of the instrument must first be performed. Furthermore, the capability of the LINUS instrument to observe data over several, perhaps discontinuous subdivided spectral regions necessitates the requirement for a rapid, pseudo-autonomous method for wavelength calibration. Therefore, this thesis project was developed with the goal of developing a software-based method for wavelength calibration utilizing known wavelength standards and the LINUS instrument in the non-imaging spectrometer mode of operation.

C. OUTLINE

This thesis is organized into six chapters. After this brief introduction, Chapter II discusses the fundamentals of hyperspectral imaging and gives an overview of the LINUS design. Chapter III outlines the wavelength calibration process and details the experimental setup. Chapter IV describes the mathematical calculations necessary for automated wavelength calibration and discusses the development and operation of the calibration program. Chapter V presents the results of the wavelength calibration over all five spectral regions studied thus far. Chapter VI presents conclusions and recommends areas for future research. Finally, the relevant software code is included in the Appendix.

II. BACKGROUND

A. SPECTRAL IMAGING

Spectral imaging is a rapidly advancing area in the field of remote sensing (Wolfe, 3). Imaging spectrometers have combined the venerable techniques of imaging and spectroscopy, thus making available extremely useful, integrated data sets that could not be acquired by using either technique alone.

Traditional imaging is concerned with the accurate measurement of light intensity over a two-dimensional scene. Spatial variations in intensity are used to detect features and patterns. This is very useful for the detection of objects, but there are certain inherent limitations. Spatial features such as size, shape, color, or pattern must be relied upon to characterize such objects. Physical attributes such as material composition can be difficult to determine using purely image-based means. Furthermore, camouflage can be used with varying degrees of success to interfere with detection by imaging sensors, such as by artificially disguising edge features in a target scene. Decoys with properly reproduced features can be used to disrupt the accuracy of image interpretation. These drawbacks can therefore result in inaccurate knowledge of an imaged scene.

Spectroscopy is a well-established field concerned with the study of variations in light intensity as a function of wavelength or frequency. Differing materials exhibit different spectral properties due to their atomic and molecular composition. These characteristics include

material-specific wavelengths where electromagnetic energy is absorbed (absorption lines or bands) or emitted (emission lines or bands). Under favorable circumstances, spectrometers capable of detecting such spectral characteristics can be used to determine both the materials being observed and some characteristics of their environment, such as ambient temperature.

Spectral imaging integrates imaging and spectroscopy to collect voluminous amounts of information from a scene. Incident light from a scene is detected and recorded according to both position within the image and wavelength. A spectral image is thus a function of a three-dimensional group of independent variables, typically displayed as an abstract hyperspectral cube, or hypercube. For each spatial element (pixel) of the image, a spectral imager records not just the total intensity of incident light in a single wavelength band, but the intensity over many bands of differing wavelength. The hypercube can then be dissected and analyzed as a collection of two-dimensional images at various wavelengths.

Due to the different spectral responses of various materials, features or objects previously indistinguishable using a conventional imager can be detected and classified. Furthermore, the spectral responses of individual pixels can be examined in order to determine the material composition and environmental conditions in those small portions of an image. Careful comparisons with nearby pixels can then aid in the identification of variations in the materials present in an emitting target.

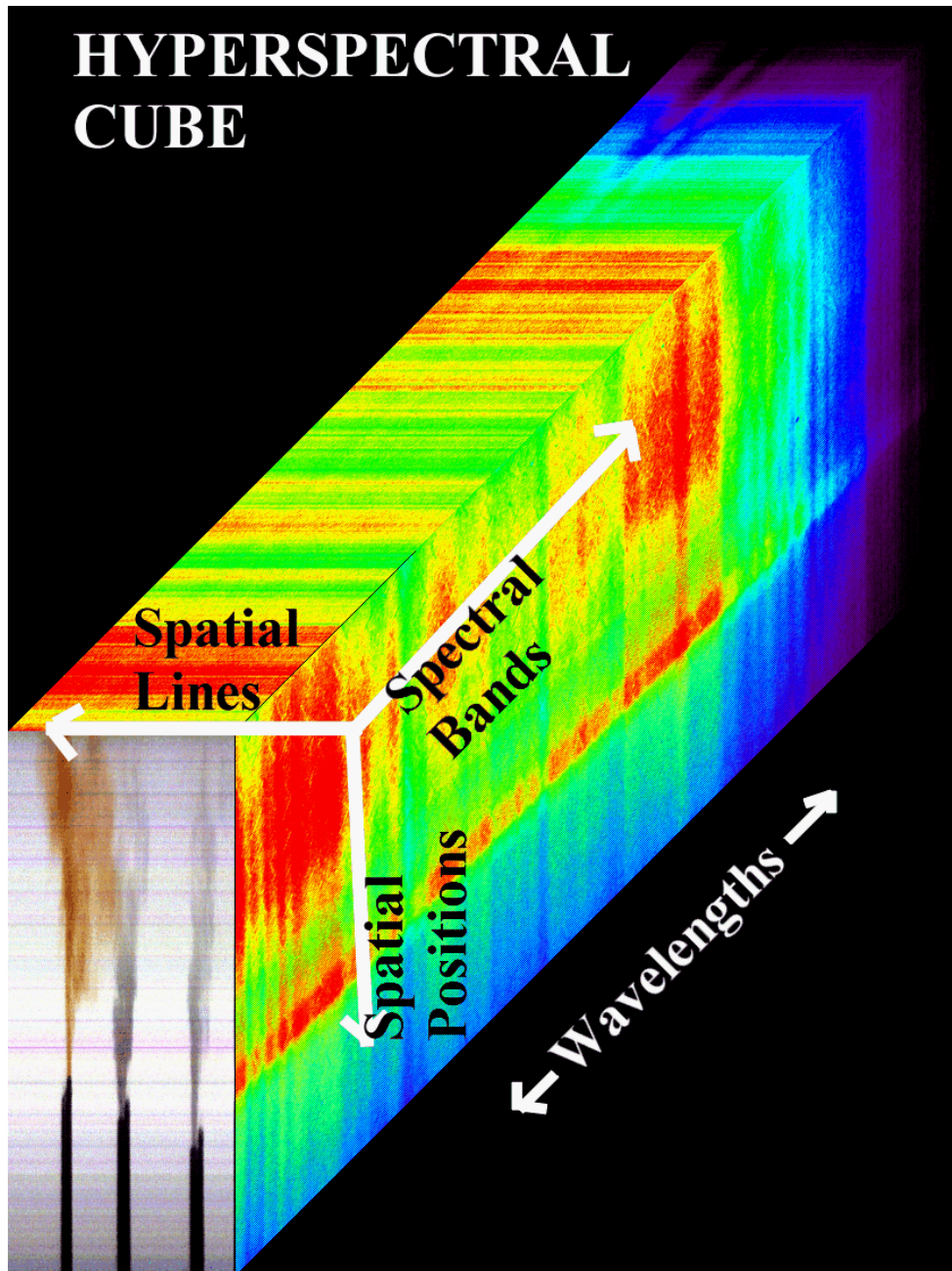

Figure 1. Hyperspectral Cube of Industrial Smokestacks, Recorded by NUVIS (From: Marino,10)

Spectral imagers have many civilian and military applications for remote sensing. The ability to determine different material compositions across a scene has tremendous potential for Earth sciences and resource

identification purposes. Likewise, the defeat of simple optical camouflage techniques by examining many regions of the electromagnetic spectrum is a valuable capability for military sensors. The vast potential for spectral imaging devices has therefore resulted in recent research into their further development. One product of this research is the LINUS project at the Naval Postgraduate School.

B. LINUS

The LINUS project was founded following the successful use of its predecessor, NUVIS, to detect and measure SO₂ concentrations in atmospheric plumes. The NUVIS optical design was limited to the relatively small ultraviolet (UV) spectral band of approximately 300 to 375nm. LINUS was developed to apply lessons from the NUVIS experience and to incorporate several enhancements, such as the instrument's tunability across the near UV spectrum.

In order to detect and measure many other potentially harmful chemical or biological agents, LINUS was designed to operate with greater resolution over the much larger ultraviolet spectral range from 200 to 400 nm. For the purposes of this thesis research, this region has been subdivided into five smaller bands that are segregated by the use of individual UV filters.

All LINUS components have been selected to enable rugged field use of the instrument. The actual detector assembly is mounted on a heavy-duty tripod and sealed within a black Acrylonitril Butadiene Styrene (ABS) plastic shell to shield the optics from external UV sources and environmental contamination. A field-ruggedized PC-type

data acquisition and control computer and power conditioning hardware have been mounted in shockproof transportation containers to allow their use in the field. While all developmental work to date has been conducted in a laboratory environment, LINUS will be capable of operation in harsher outdoor conditions.



Figure 2. LINUS Field-Support Equipment

The LINUS optical design uses an image-intensified CCD camera, optimized for the ultraviolet region, several compound lenses, a planar image-scanning mirror, and a diffraction grating in order to generate spectral image

data. Incident light from a distant target is reflected off the scanning mirror and through a UV bandpass filter with a moderate bandwidth of approximately 20 nanometers (nm). The UV light transmitted through the filter passes through an initial objective lens system, which focuses an image of the distant scene onto a narrow slit. This slit allows only a thin vertical slice of the scene to enter the spectrometer. During data recording, successive slices are selected by rotating the scanning mirror under computer control. The vertical image slice then passes through a collimating lens system and on to a plane diffraction grating. The grating disperses the light according to the grating equation

$$m\lambda = d(\sin \theta_i - \sin \theta_o) \quad [\text{Eq. 2.1}]$$

where:

m = Order of the diffraction set ($\pm 1, \pm 2, \pm 3 \dots$),

λ = Wavelength of the diffracted light,

d = Diffraction grating inter-ruling spacing,

θ_i = incident angle,

θ_o = output angle.

Since m , d , and θ_i are fixed, light of different wavelengths (λ) will be diffracted through different angles (θ_o). The result is a horizontal dispersion of the incident light corresponding to its wavelength.

The light is then focused by a camera objective lens system onto a UV-sensitive microchannel plate coupled to a 512x512 pixel charge-coupling device (CCD) detector array.

Because the optical design is stigmatic, the vertical positions of light incident on the CCD array correspond to the vertical location of corresponding portions of the thin slice of scene being imaged. Thus the vertical coordinates of the recorded image's pixels are in one-to-one correspondence with the vertical coordinates of the scene being focused on the slit. The horizontal pixel coordinate of the measured image corresponds to the wavelength of light diffracted from each vertical element of the scene. This image is recorded as a single two-dimensional slice of the final hyperspectral cube. In order to generate the second, horizontal scene dimension required for a full 2-D image, the mirror is slightly rotated by a precision closed-loop DC servo system. This allows an adjacent vertical slice of scene to be imaged by the camera. The entire spectral image is built up by interleaving image frames with the small rotations of the camera mirror until the entire scene has been panned across the camera's instrument's entrance slit. The data acquisition computer then stores the resultant spectral image for later analysis.

If the instrument is operated at its full data resolution of 512 horizontal image samples by 512 vertical image samples by 512 wavelength samples by 12 bits (2 bytes) per pixel, the total data storage requirement for one scene will be $512 \times 512 \times 512 \times 2 = 268,435,456$ bytes. In practice one will seldom need such a large volume of spectral imaging data.

LINUS Optical Layout

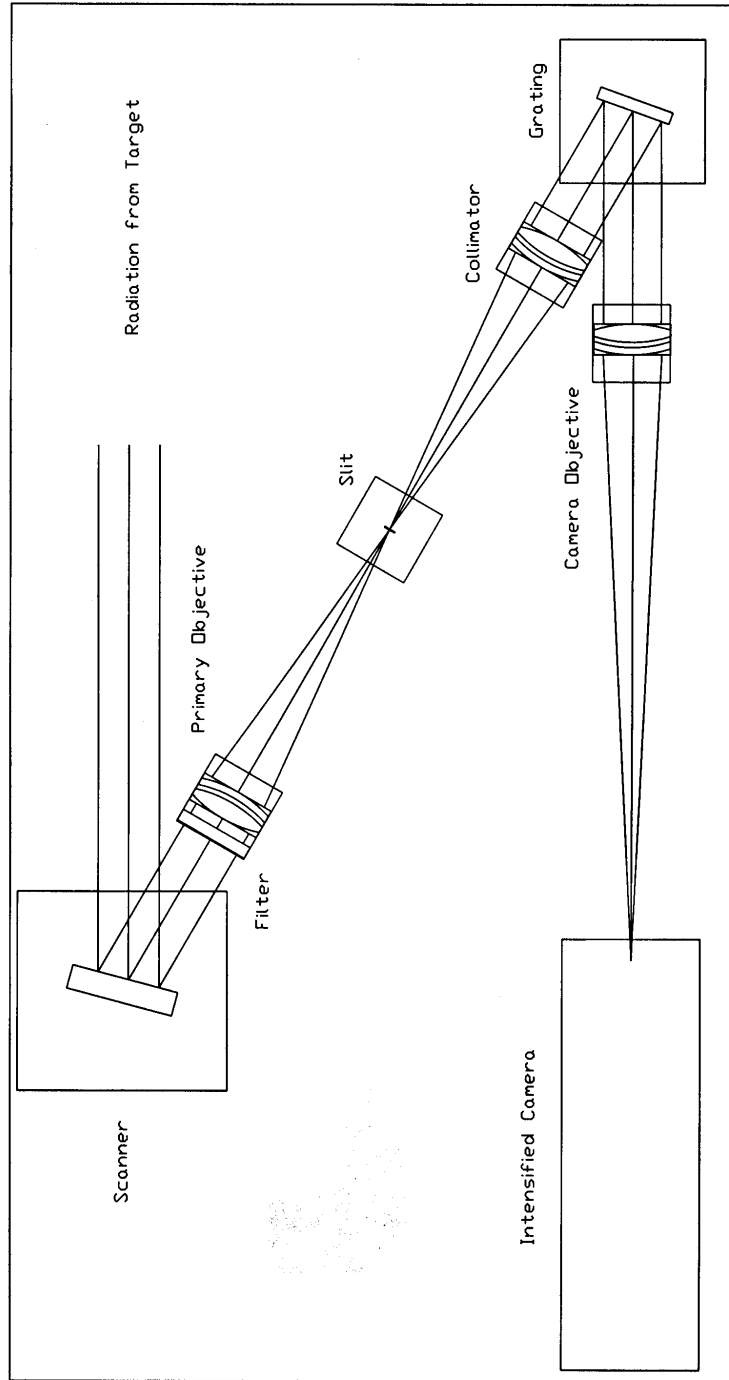

Figure 3. LINUS Optical Design

III. EXPERIMENTAL MEASUREMENTS

A. PURPOSE

In order for the information from a hypercube of spectral data to be of maximum usefulness, the dimensions of all three axes must be accurately calibrated. The two physical image dimensions (x and y) can be calibrated from the properties (i.e. effective focal lengths) of the optical components and their relative spacing within the instrument. This spatial calibration can be verified by imaging an object of known size and distance and determining its resultant size in terms of pixel width and height. The third, wavelength (λ), axis can also be calibrated in principle by using the grating equation and the focal properties of the optical train. In practice, however, such calculations are useful only for rough approximations of measured wavelengths. There are two primary reasons for this. First, the use of chromatic lenses in the optics causes variations in focal length, and hence in image scale, because of chromatic aberration (Pedrotti and Pedrotti, 102). The large spectral range over which LINUS is designed to operate aggravates this effect. Second, the inherent non-linearity of the diffraction grating equation (Eqn. 2.1) leads to a nonlinear wavelength scale across the recorded image plane. In order to perform spectral absorption analysis and other meaningful wavelength-based studies, wavelength must be precisely known. This thesis project was therefore initiated to develop a method for wavelength calibration by

using the LINUS optical train as a spectrometer to observe an independently calibrated spectral standard source.

B. EXPERIMENTAL SETUP

In order to conduct this wavelength calibration research, LINUS's ability to perform two-dimensional imagery was not needed. The instrument was configured in a purely spectroscopic mode. Readers who are interested in LINUS's image scanning subsystem can find a thorough description in the earlier thesis by R. Kompatzki (Kompatzki, 25). For convenient access during the experiments, all of LINUS's optical and optomechanical components, except the image scanner, were removed and positioned on an optical table.

A platinum (Pt) hollow cathode lamp was used as the spectral calibration standard source. Atomic platinum exhibits a rich spectrum of emission lines across the entire near-ultraviolet region. The National Institute of Standards and Technology (NIST) has catalogued the precise wavelengths and relative intensities of these emission lines, and has made the data readily available on their website (Sansonetti). This has made platinum hollow cathode lamps one of the most commonly used wavelength standards for ultraviolet analysis. Additionally, a regulated DC power supply was built to consistently deliver the optimum rated current to the platinum lamp. As shown in Figure 5, the lamp was placed along the optical axis of the instrument, in approximately the position that would normally be occupied by the scanning mirror.

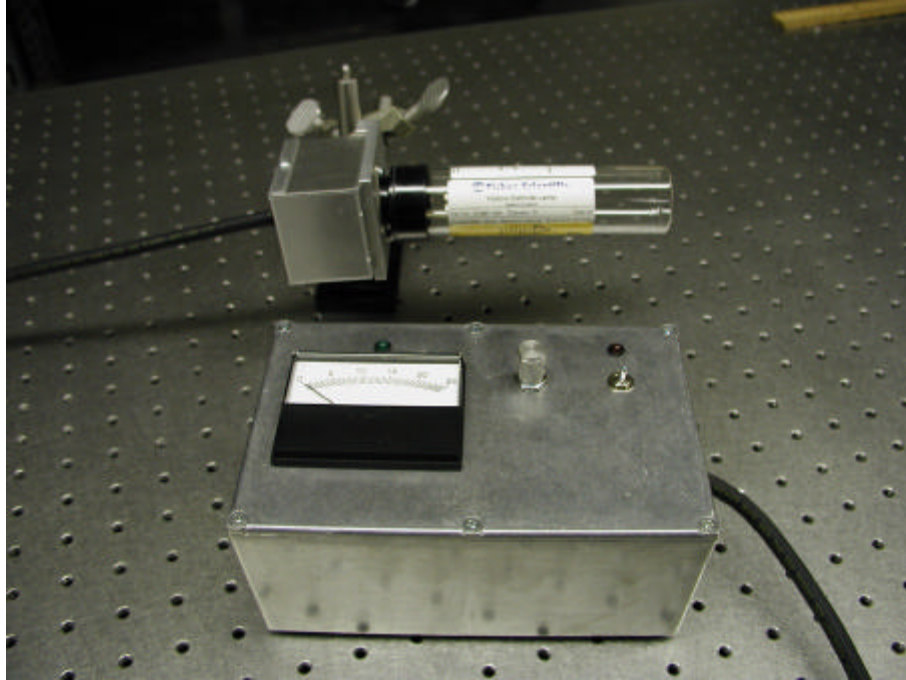

Figure 4. Pt Hollow-Cathode Lamp and DC Power Supply



Figure 5. Placement of Pt Lamp Along Optical Axis

Once the LINUS optical components and platinum lamp were mounted to the table, simple light-blocking baffles were installed to reduce the amount of stray ultraviolet light reaching the camera to an acceptable level. The different UV spectral regions were selected by using filters with different pass bands. The filter characteristics are summarized in Table 1, and the manufacturer's transmission curves are shown in Figures 6 through 10 (Omega Optical Company).

Filter Number	Manufacturer Designation	Peak Transmission Wavelength(nm)	Passband (50% of Peak) (nm)
1	220BP10	220	216-226
2	289BP10	286	283-293
3	300BP10	296	293-304
4	334BP10	330	326-346
5	370BP10	367	363-375

Table 1. UV Filter Characteristics

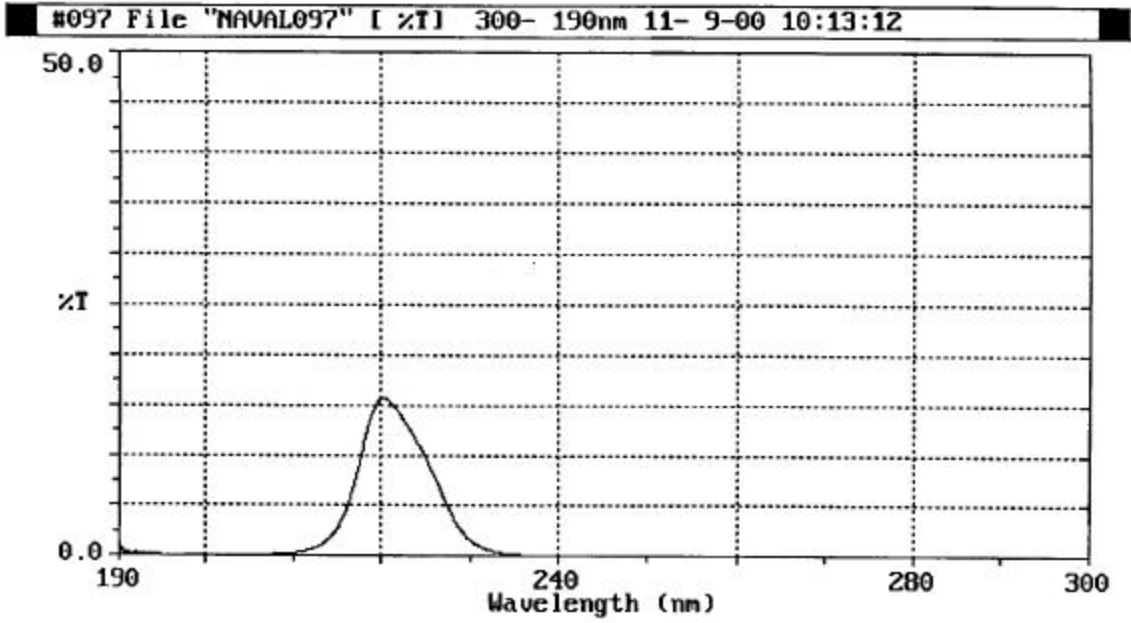

Figure 6. Filter Transmission (%T) Curve: 220BP10

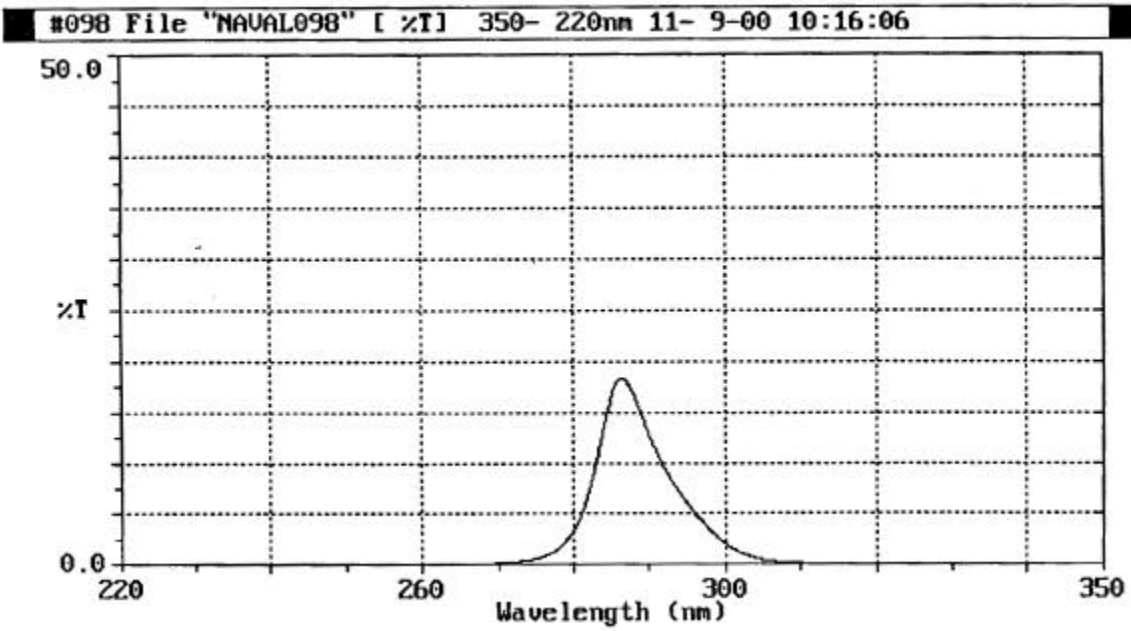

Figure 7. Filter Transmission (%T) Curve: 289BP10

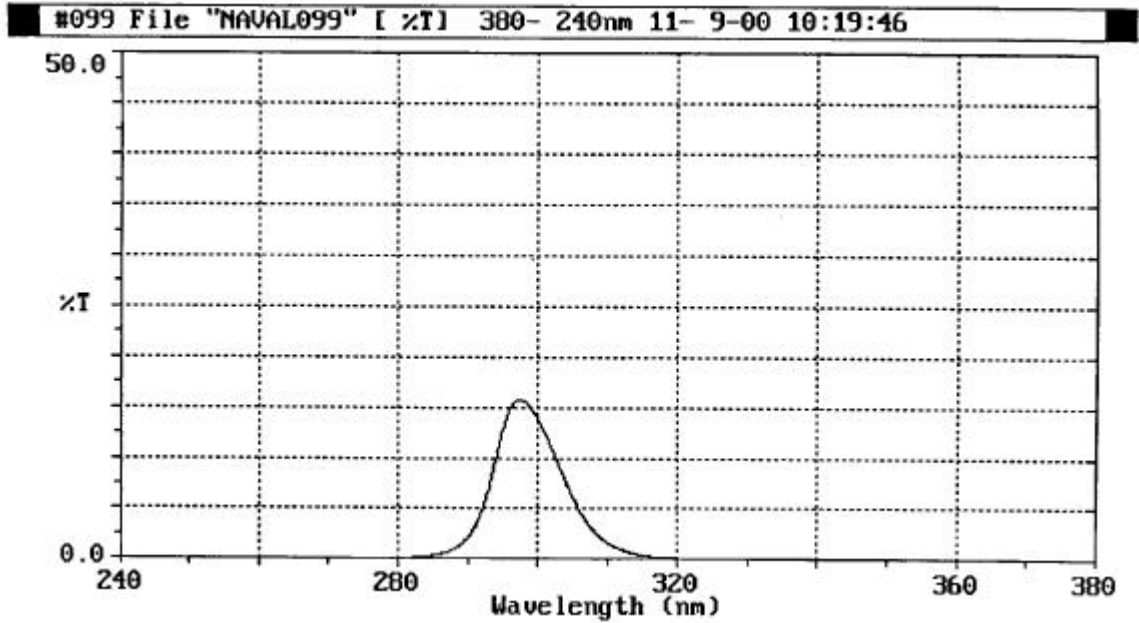

Figure 8. Filter Transmission (%T) Curve: 300BP10

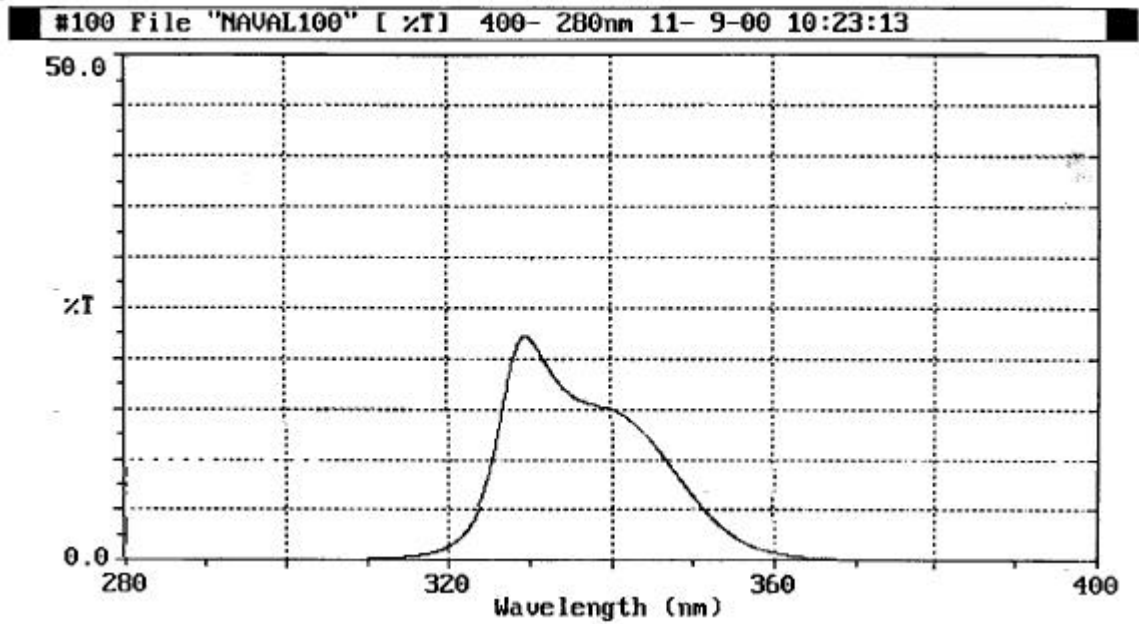

Figure 9. Filter Transmission (%T) Curve: 334BP10

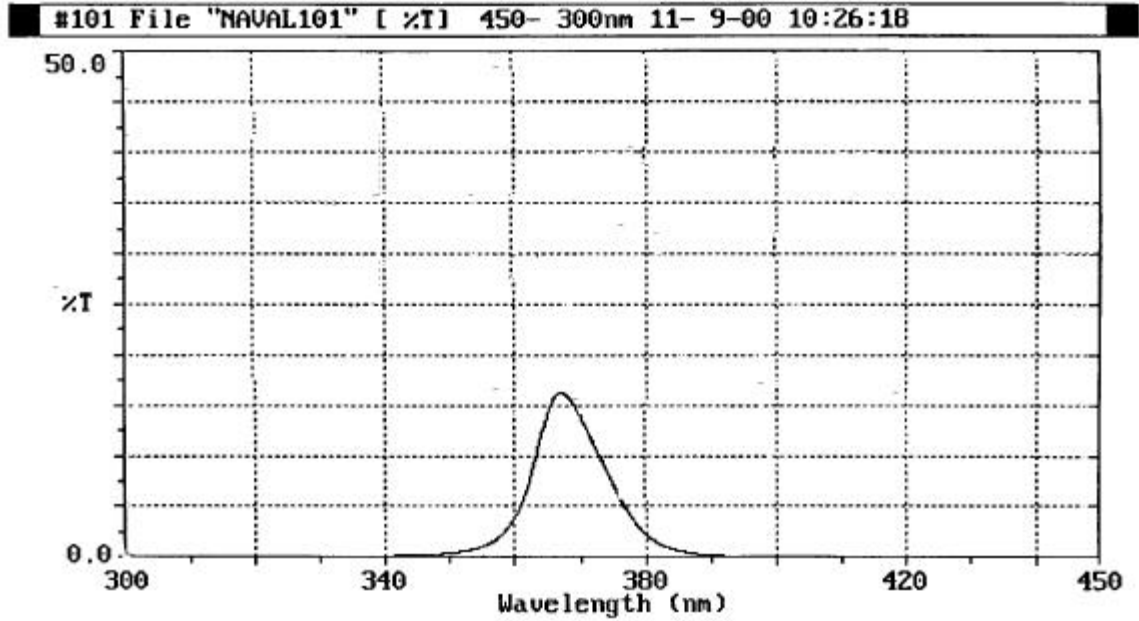

Figure 10. Filter Transmission (%T) Curve: 370BP10

C. DATA COLLECTION

Before any data was taken, several exercises were conducted for familiarization with the data acquisition software. First, one of the UV bandpass filters was selected and installed. Then, after the proper operation of the equipment was verified, the platinum lamp was energized and raised to its specified operating current level. The diffraction grating was rotated so that the zeroth order image of the slit was properly focused onto the camera's image intensifier. The slit width was narrowed until its image appeared crisp and the measured intensity level at the camera was acceptable, without either excessive noise or intensity saturation.

The diffraction grating was then rotated until the first order set of diffraction lines became centered in the

camera's field of view. Rough focusing was accomplished by alternately adjusting the positions of the collimating and objective lenses with respect to the slit and the camera focal plane, respectively. Finer adjustment of the focus was accomplished by using the camera's image acquisition software, WinView/32 (Roper Scientific), to enlarge a small region of the viewable area containing several weak emission lines and further refining the lens' positions to sharpen the image.

Once the diffracted emission lines were properly focused, the image was recorded and saved in Tagged Image File (.TIF) format. This image was subsequently exported to and processed by the calibration program written with the MATLAB software package. The procedure was then repeated for the remaining UV filters. Representative images for each of the five filters are shown in Figures 11 through 15.

In these figures, as discussed earlier, the vertical dimension corresponds to vertical spatial information, while the horizontal dimension is the spectral dispersion direction.

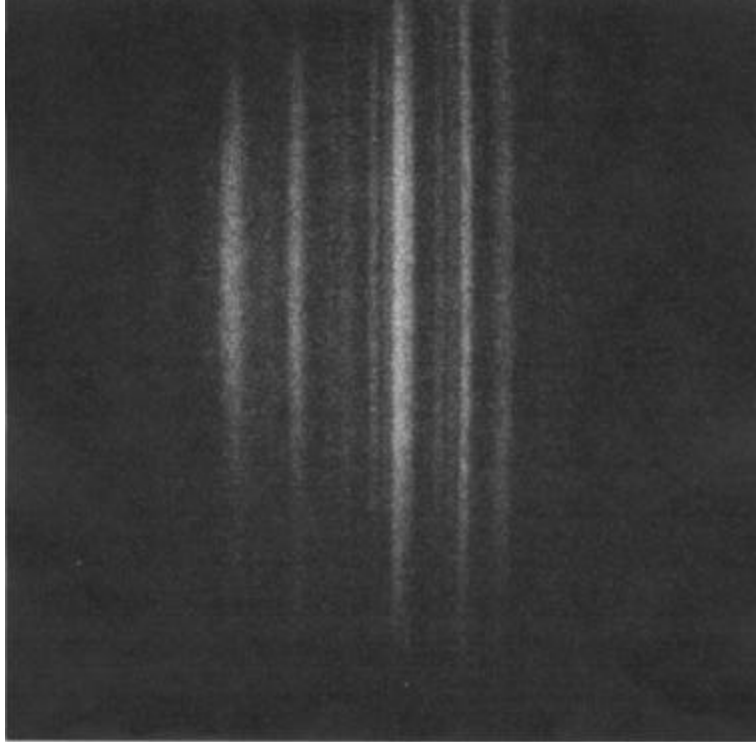

Figure 11. Diffracted Emission Lines: 220nm Filter

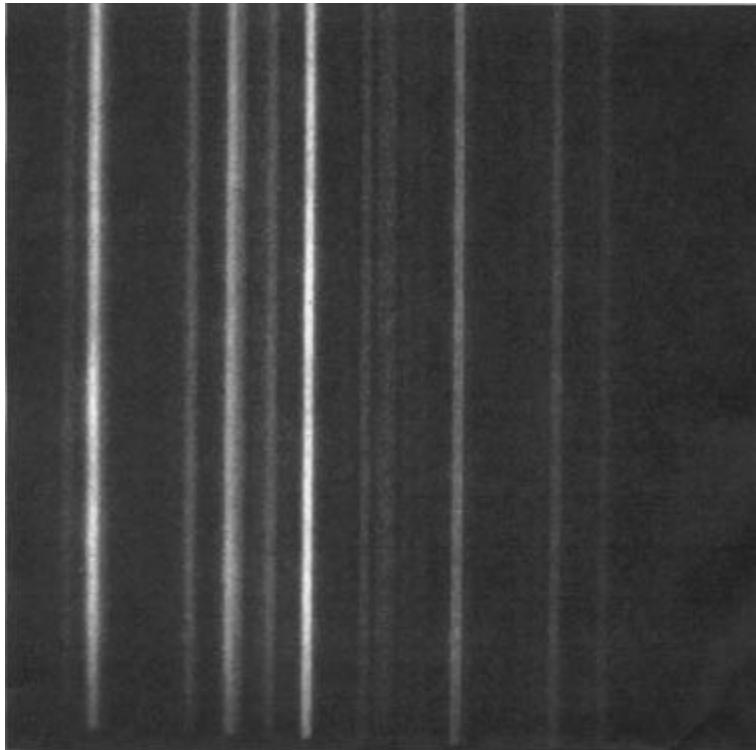

Figure 12. Diffracted Emission Lines: 289nm Filter

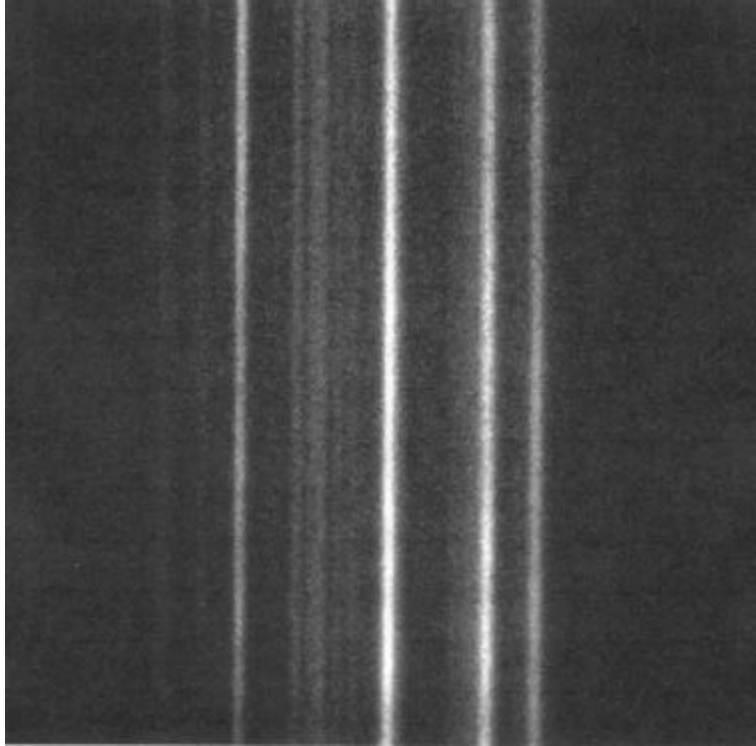

Figure 13. Diffracted Emission Lines: 300nm Filter

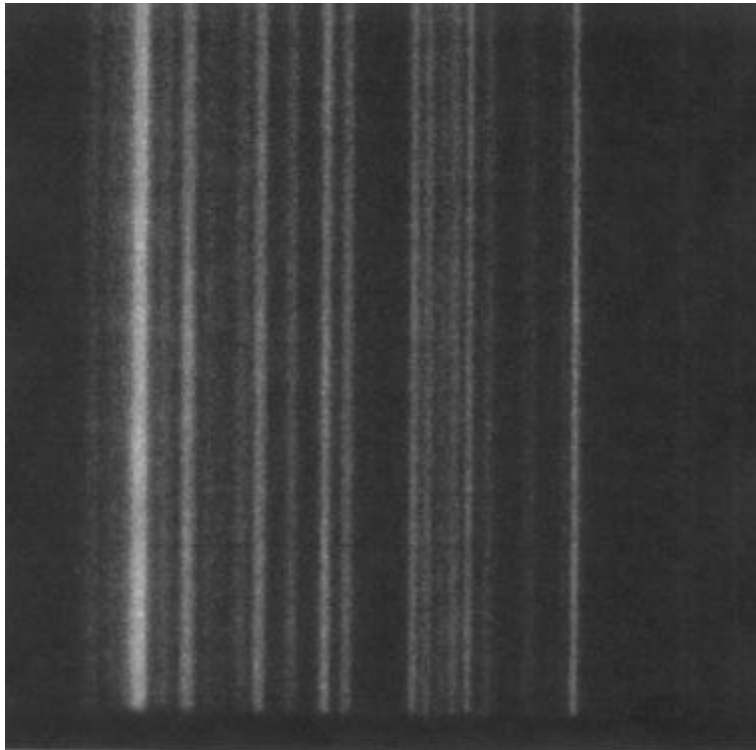

Figure 14. Diffracted Emission Lines: 334nm Filter

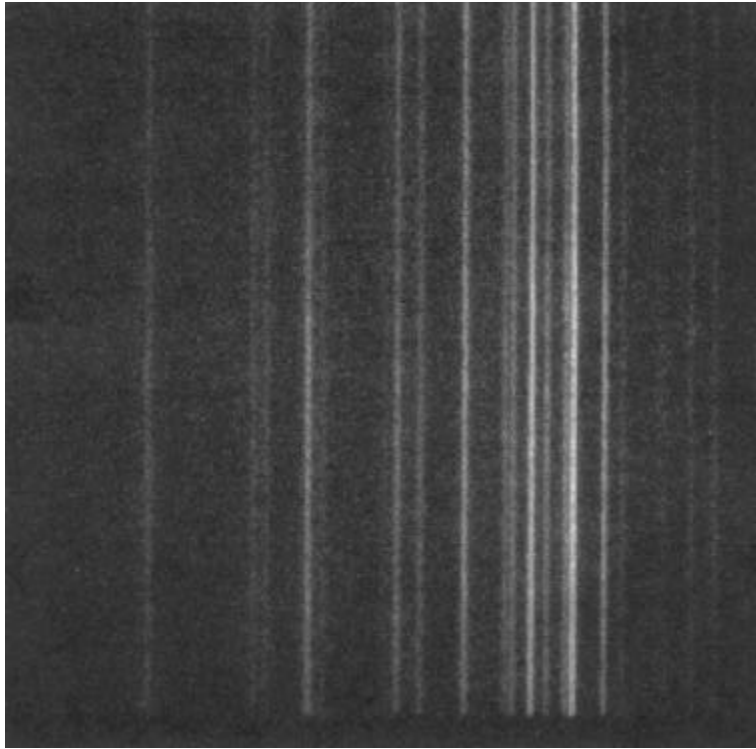

Figure 15. Diffracted Emission Lines: 370nm Filter

THIS PAGE INTENTIONALLY LEFT BLANK

IV. DATA ANALYSIS

A. OVERVIEW

The bulk of the work involved in this thesis project consisted of creating a MATLAB software program capable of performing pattern-matching operations between measured spectra and corresponding known or standard spectra. The desired product was a calibration curve that relates image pixel number versus wavelength across each observed spectral band. Cross-correlation, which is a familiar mathematical method for comparing the similarity of two different patterns, was used to optimize the alignment between the measured and standard spectral data. Spectral line data recorded by LINUS were compared to expected values from the tabulated NIST Pt standard line list (Sansonetti). The NIST wavelength scale was incrementally contracted or elongated, then shifted until the LINUS and standard emission lines were optimally matched, essentially performing an affine transformation on the wavelength scale. Once the Pt standard spectral lines, for which relative intensity and absolute wavelength were known, were properly aligned with the LINUS spectral lines the known wavelengths could be associated with the LINUS lines. Finally, relating the pixel location of the spectral lines to their corresponding wavelengths completed the wavelength calibration process.

B. COMPUTATIONAL THEORY

1. Preprocessing of Platinum Standard Spectral Data

Significant preprocessing of the NIST spectral data was required in order for a valid correlation to be made

with the measured LINUS data. This preprocessing included elimination of irrelevant data and simulating the attenuation of the UV bandpass filters within each spectral band that was studied.

The tabulated data contained wavelength and relative intensity information on over 3200 emission lines between the wavelengths of 2000 and 4000 angstroms. Given the large calculational requirements of repeatedly conducting cross-correlation within iteration loops, inclusion of irrelevant spectral lines would have been extremely inefficient and computationally slow. Therefore, after loading the NIST data from a ".dat" data file, all values significantly outside of the given UV filter passband were discarded. Furthermore, the user could specify a minimum intensity threshold below which weaker lines that were less discernable by LINUS could be discarded. The resultant data filtering typically reduced the number of lines considered during a given calibration to between 50 and 100, which was much less processor-intensive.

Since the tabulated NIST data do not include actual line profiles, but only peak intensities, a Gaussian line shape function was used to broaden each of the tabulated standard spectral lines via simple numeric convolution. Neighboring lines, particularly those whose wavelengths differed by an amount less than or equal to the characteristic width of the simulated line shape function, were blended together by this process. This blending was also expected in the experimental LINUS spectrum.

Additional preprocessing was necessary to account for the transmissibility effects of the UV filters. Transmissibility versus wavelength was included for many

data points within each filters' passband. Interpolation for each relevant NIST emission line determined the expected transmissibility at that wavelength. The relative intensity of each line was then modified by its corresponding transmission factor. The resultant data represented the expected relative intensities of spectral lines measured by LINUS.

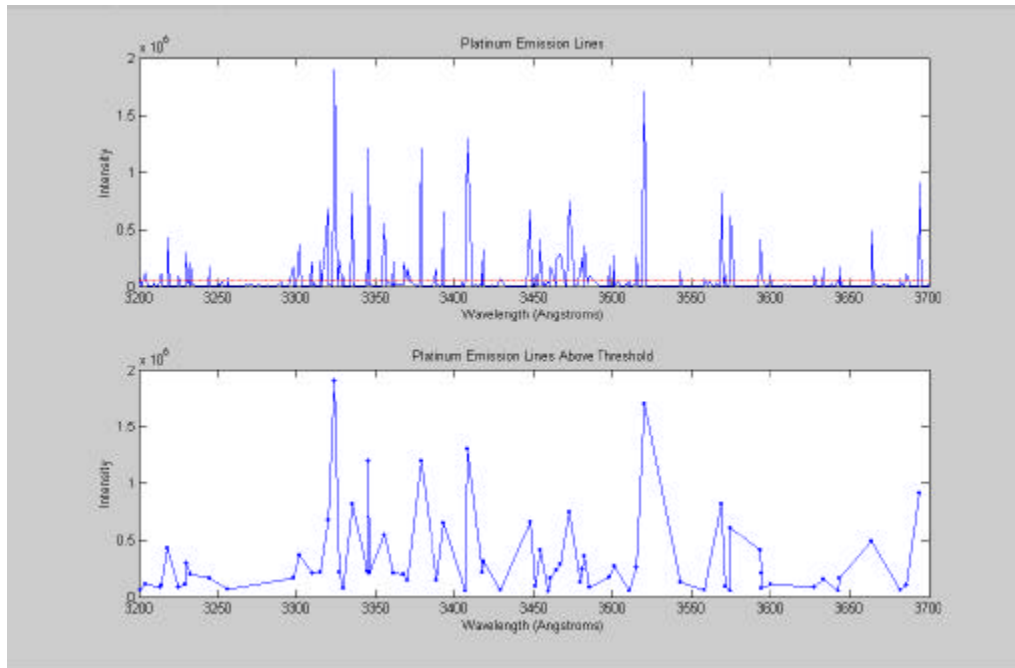

Figure 16. Removal of Low Intensity Emission Lines

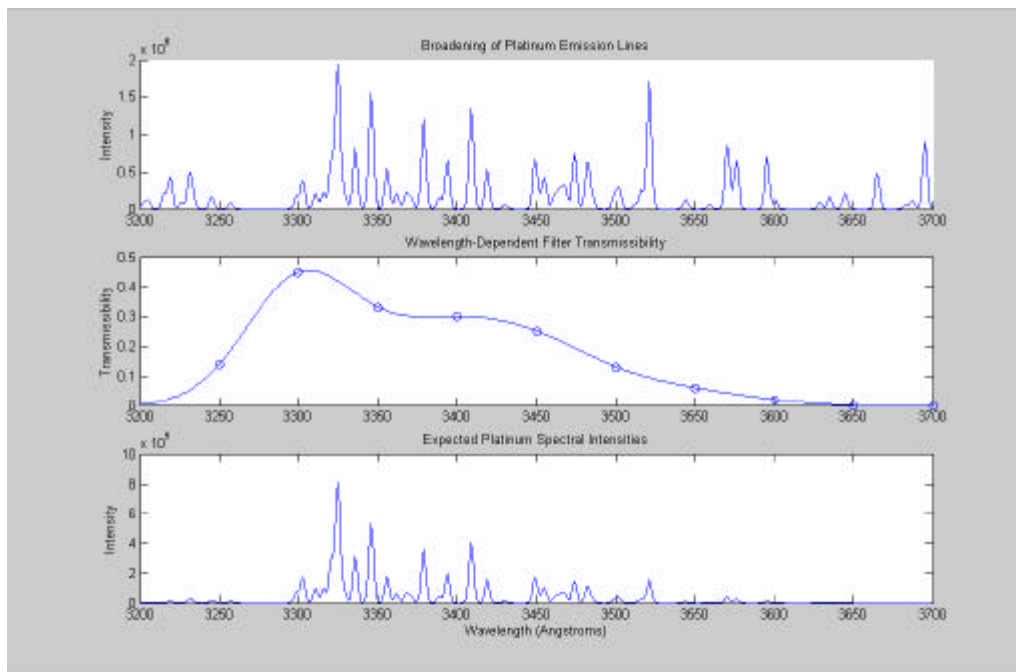

Figure 17. Simulated Broadening and Filtering of Representative Platinum Spectra in the 3200-3700 Angstrom Spectral Region

2. Preprocessing of LINUS Data

The filtered and spectrally dispersed light from the laboratory platinum hollow cathode lamp formed a two-dimensional image on the LINUS camera focal plane. In order to compare data from this image with intensity and wavelength data from the NIST standard, the vertical spatial information in each image was not needed. Therefore, to improve signal-to-noise characteristics of the spectrum, the light intensity reaching each element in a vertical pixel row was summed, or coadded. In addition, the user was able to specify an intensity threshold in order to account for the intensity-independent noise floor across the CCD array. The result was a one-dimensional measured spectral intensity value versus image pixel row

address, stored in a data array that was suitable for subsequent correlation with the corresponding array of NIST standard spectral data as outlined above.

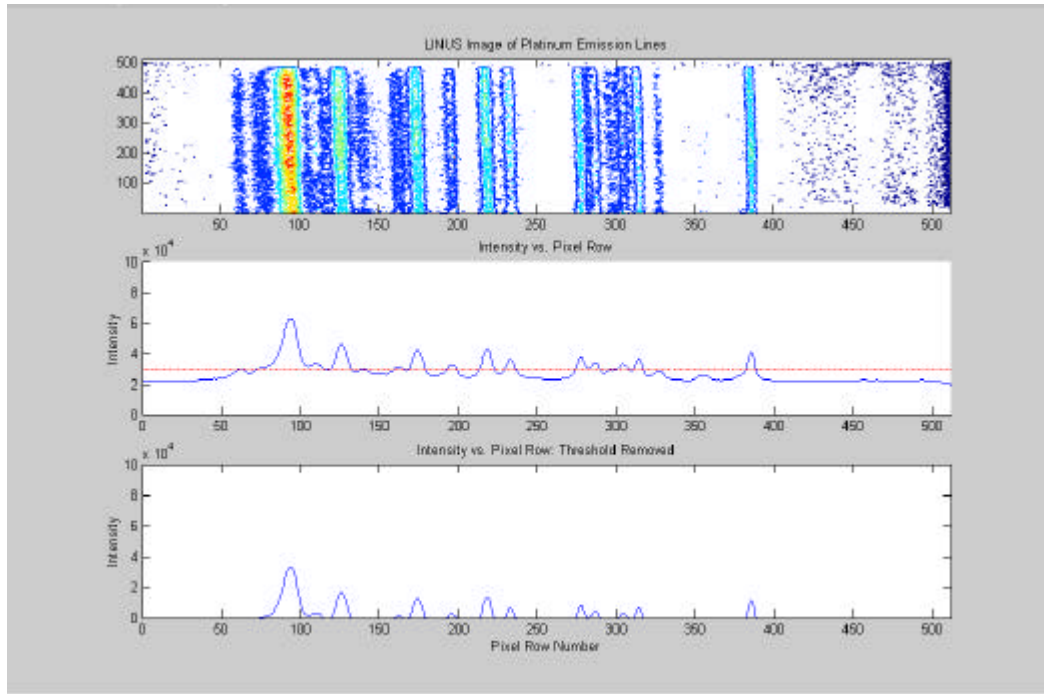

Figure 18. LINUS Image Capture and Preprocessing:
Top Frame: Raw 2-Dimensional Data
Middle Frame: Noise Threshold Definition
Bottom Frame: Resultant Preprocessed Data

3. Pattern Matching and Cross-correlation

Cross-correlation is a method of measuring the degree of similarity between different signals. In the context of this thesis project, two conditions must be met in order for two signals to reach maximum agreement. First, the horizontal data scale, such as time or frequency, must be equal. For this project the horizontal scale was wavelength, scaled as described above. Second, the two signals must be optimally aligned with each other, i.e. any lateral shifts between the emission lines must be

minimized. When both of these conditions are met, the cross-correlation of two signals will reach a maximum value. The equation for cross-correlation as a function of data series offset, $r(d)$, is given by: (Bourke)

$$r(d) = \frac{\sum_{i=1}^n [(x(i) - \bar{x}) * (y(i-d) - \bar{y})]}{\sqrt{\sum_{i=1}^n [(x(i) - \bar{x})^2]} * \sqrt{\sum_{i=1}^n [(y(i-d) - \bar{y})^2]}} , \quad [\text{Eq. 3.1}]$$

where

- $x(i)$ = first data series being compared,
- $y(i)$ = second data series being compared,
- i = index of the data sample (1,2,3... n),
- n = length of the data samples,
- d = sample offset between $x(i)$ and $y(i)$
(0,1,...n-1).

The second signal is shifted relative to the first by iterating the delay term, d , yielding a maximum value of cross-correlation when the signals are best aligned.

The MATLAB one-dimensional cross-correlation function "xcorr1" was implemented to compare the preprocessed LINUS data with the modified NIST spectrum. Because the wavelength scale of the LINUS data was unknown a priori, an algorithm was developed to perform an affine transform on the NIST data wavelength scale by iteration of the horizontal scale through a specified band. At each iteration of wavelength scaling, the peak cross-correlation value was recorded. Plotting the maximum cross-correlation value against the scale elongation factor enabled the point for which the LINUS and NIST data best agreed to be readily identified.

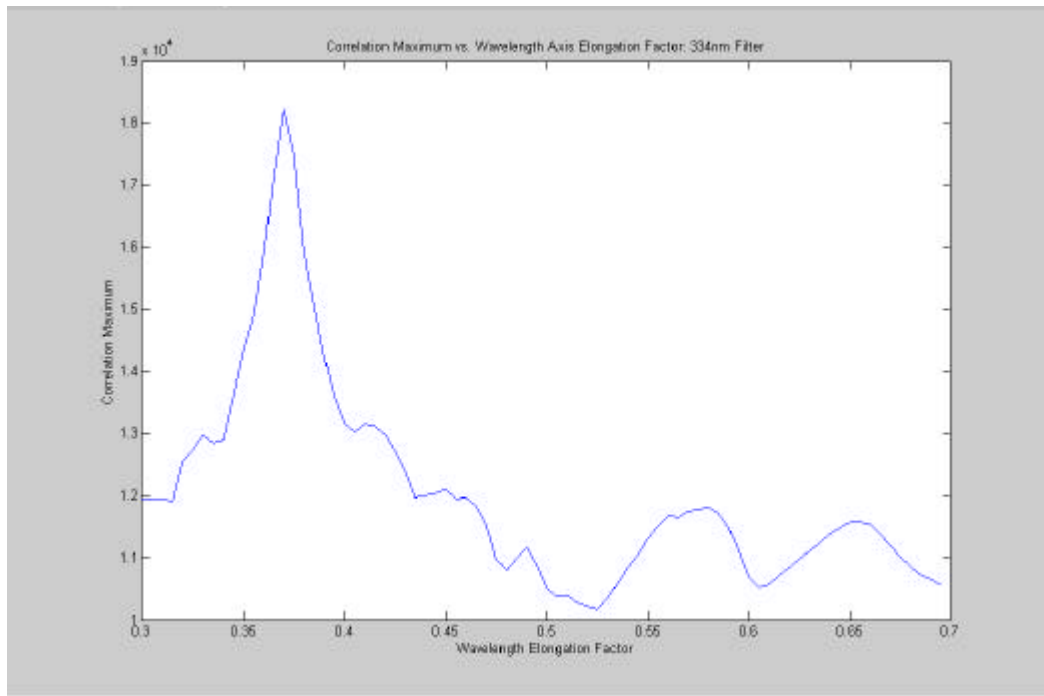

Figure 19. Cross-Correlation Peak vs. Elongation Factor

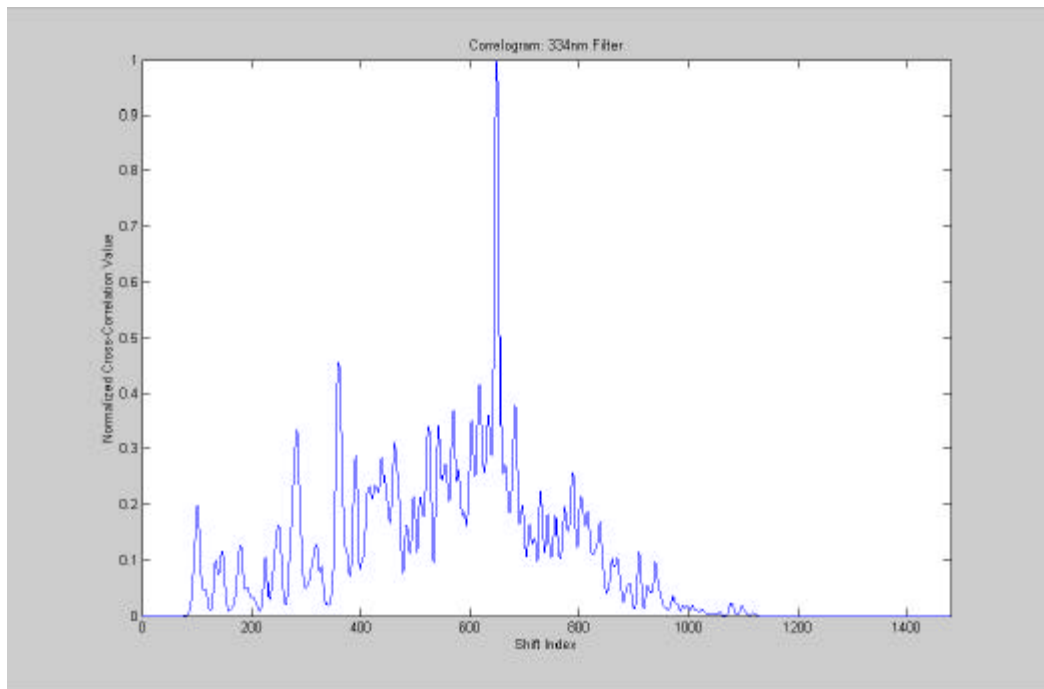

Figure 20. Correlogram Showing Peak at Best Shift

This "best scale factor" was used to reiterate the cross-correlation and to determine the optimum shift required to maximize the cross-correlation. Application of this shift to the horizontal axis of LINUS data, i.e. pixel number, finally resulted in the alignment of NIST and LINUS spectral lines with equally scaled spectral wavelengths.

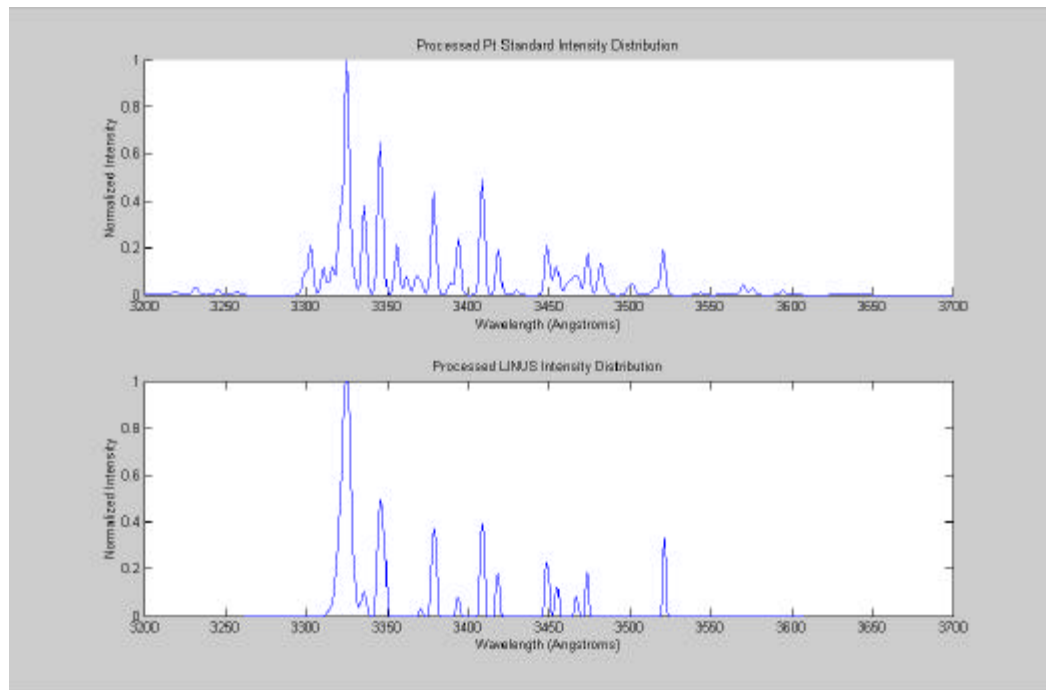

Figure 21. Aligned LINUS and NIST Data

The LINUS horizontal scale, pixel row number, could therefore be related to the NIST horizontal scale, wavelength.

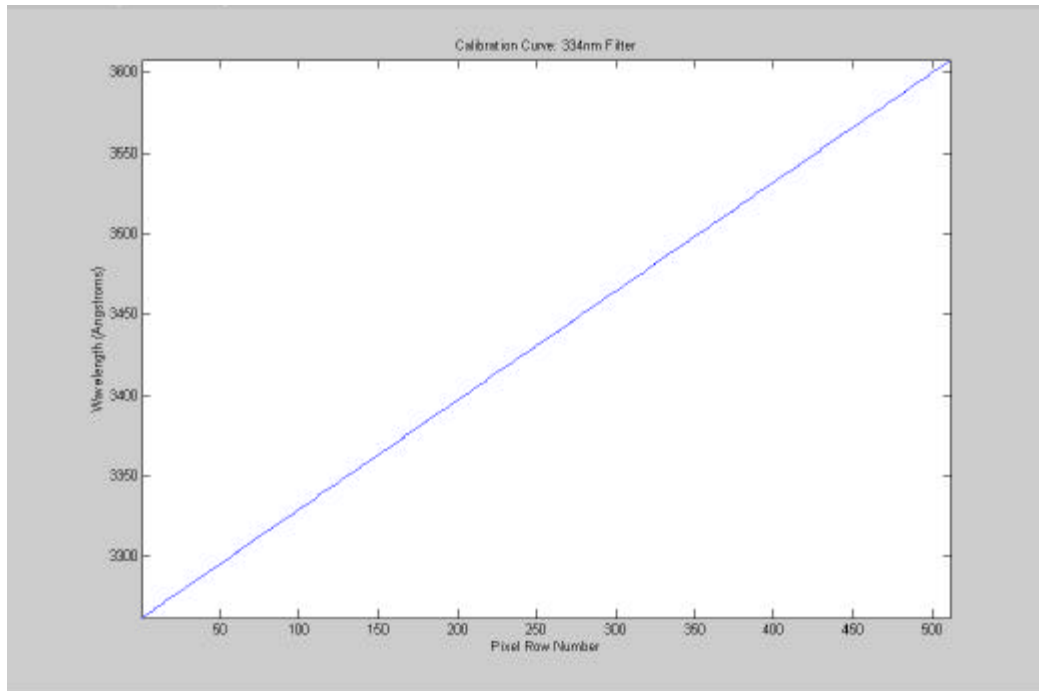

Figure 22. Wavelength Calibration Curve

The reader must be cautioned that such a linear calibration will necessarily be valid over only a limited range of wavelengths, and that it must be performed for each spectral region. The diffraction grating equation is nonlinear (sinusoidal), meaning that the wavelength scale will also be nonlinear.

A widely accepted measure of goodness-of-fit between two distributions is the χ^2 parameter. (Taylor) Once the cross-correlated LINUS and standard spectra have been matched, a χ^2 value may be calculated to characterize the agreement. The χ^2 parameter is generated as follows:

$$c^2 = \sum_{i=1}^n \frac{(a_i - b_i)^2}{b_i}, \quad [\text{Eqn. 4.1}]$$

where a_i and b_i are the corresponding samples of the distributions, and the summation is over all relevant samples. For the purpose of this research, a_i was the LINUS spectrum of interest, and b_i was the corresponding NIST spectrum.

Analysis of the χ^2 parameter was conducted to verify the pattern-matching capability of the cross-correlation program. A "best fit" between two distributions exists when the χ^2 parameter is minimized. This value was first calculated for the matched intensity distributions. The alignment of the intensity distributions was then shifted by user-specified amounts. The χ^2 parameter was calculated for the manually offset intensity distributions and verified to be greater than the χ^2 value for the aligned distributions.

V. RESULTS

A. OVERVIEW

Separate wavelength calibrations were performed for the ultraviolet bands associated with each of the five filters. In each case, the automated results were confirmed for proper alignment with the NIST spectral data by visual comparison and by analysis of the χ^2 parameter. The minimum χ^2 parameters for each spectral band are presented in tabular form.

Filter	Minimum χ^2 Value
220nm Filter	6.16 E7
289nm Filter	9.59 E6
300nm Filter	1.29 E5
334nm Filter	1.63 E5
370nm Filter	1.44 E3

Table 2. Minimum χ^2 Parameters for Calibration Results Associated with Spectral Region of Each Filter

B. 220NM FILTER

In this wavelength range, the 512 pixel rows of the camera's focal plane were found to span a wavelength interval of 51.1 nm, from 197.8 to 248.9nm.

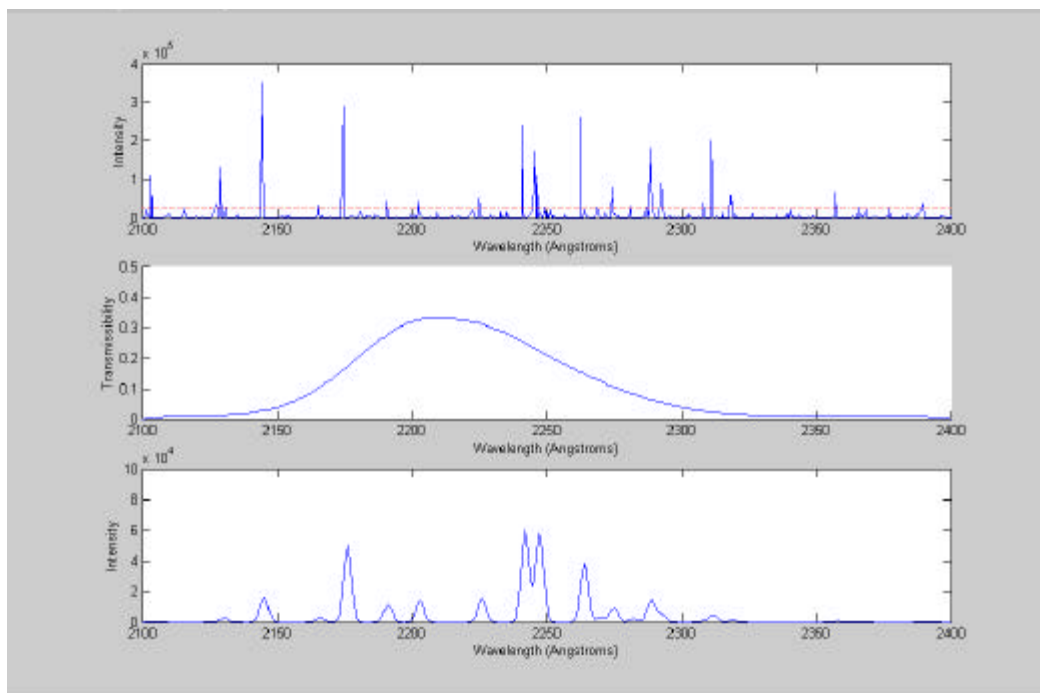

Figure 23. Pt Standard Preprocessing: 220nm Filter
 Top Panel: Pt Standard Emission Lines
 Middle Panel: 220 nm Filter Curve
 Bottom Panel: Final Preprocessed Output

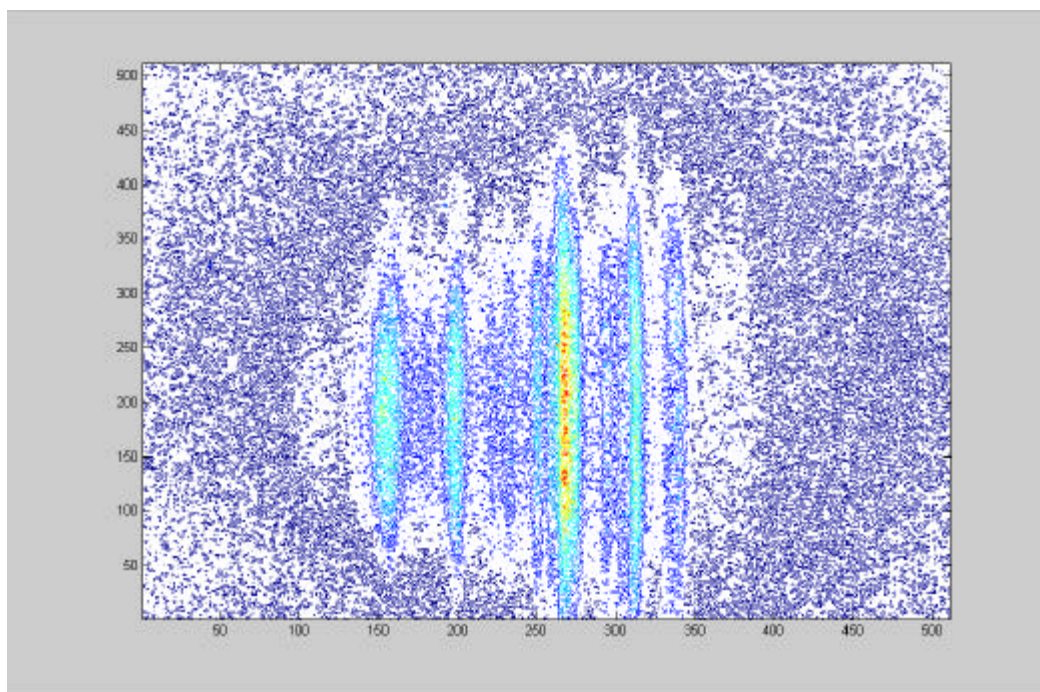

Figure 24. Raw LINUS Image of Pt Spectrum Using 220 nm Filter (Axes Correspond to Pixel Numbers)

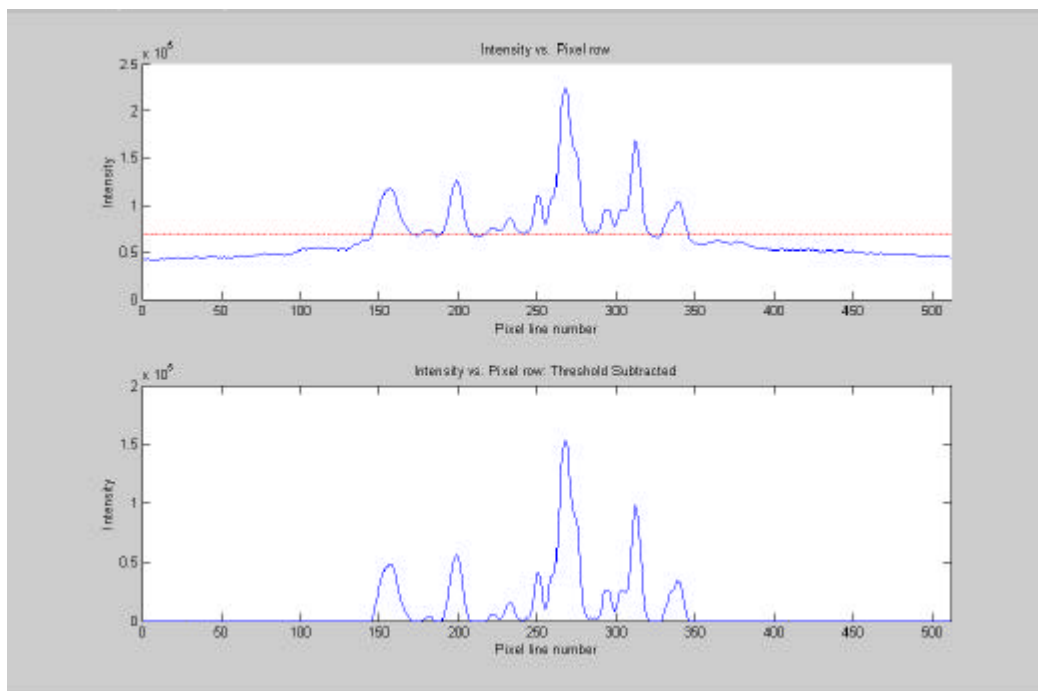

Figure 25. Coadded Pt Spectrum and Threshold Subtraction Using 220nm Filter

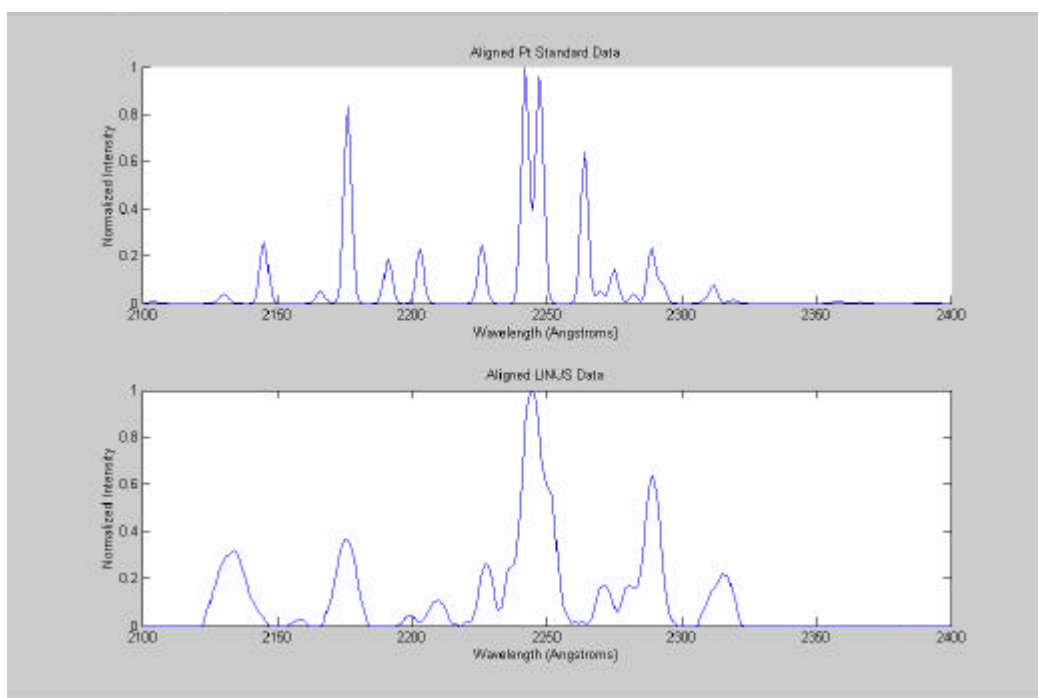

Figure 26. Data Alignment Using 220nm Filter
 Top Panel: Preprocessed NIST Reference Data
 Bottom Panel: Aligned LINUS Data

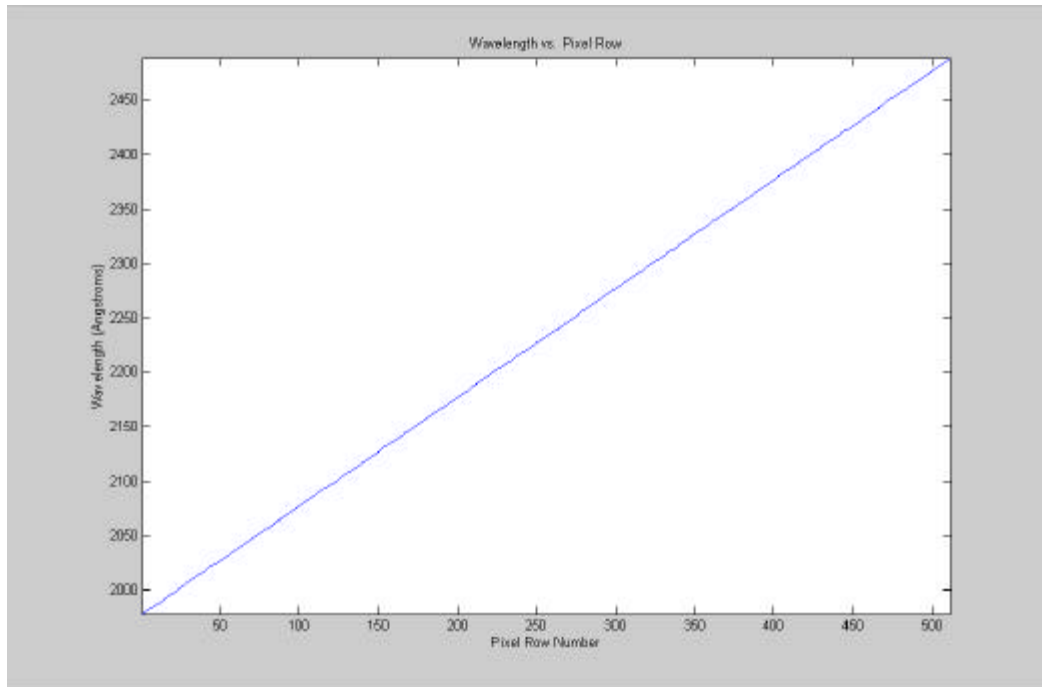

Figure 27. Wavelength Calibration Curve Using 220 nm Filter

C. 289NM FILTER

The camera's focal plane was found to span a wavelength interval of 22.0 nm, from 274.1 to 296.1 nm.

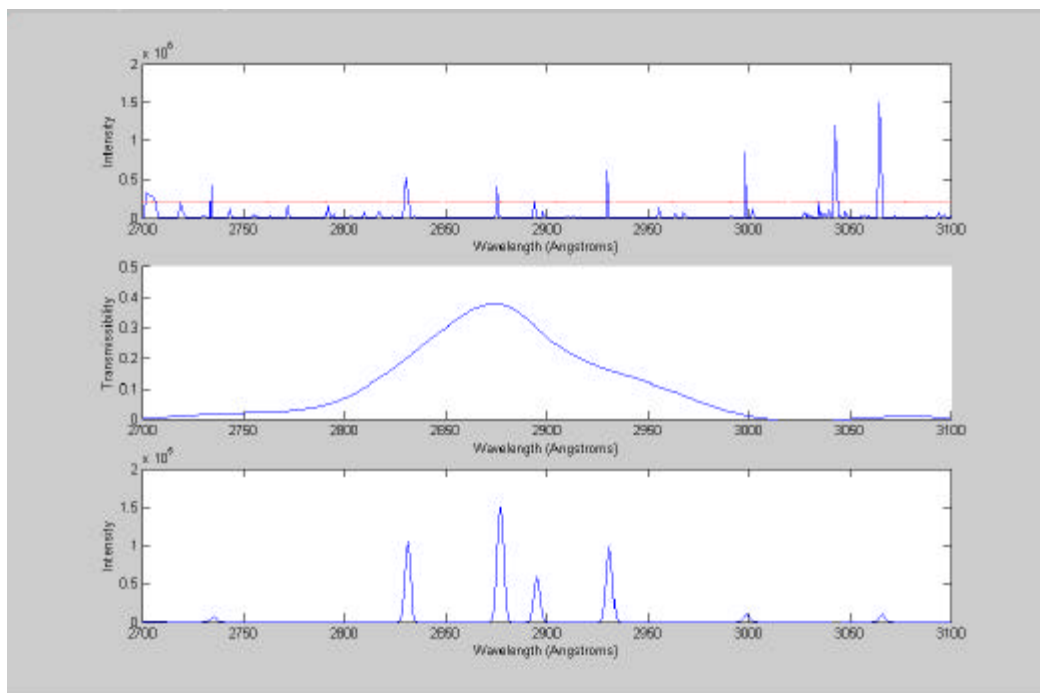

Figure 28. Pt Standard Preprocessing: 289nm Filter
 Top Panel: Pt Standard Emission Lines
 Middle Panel: 289 nm Filter Curve
 Bottom Panel: Final Preprocessed Output

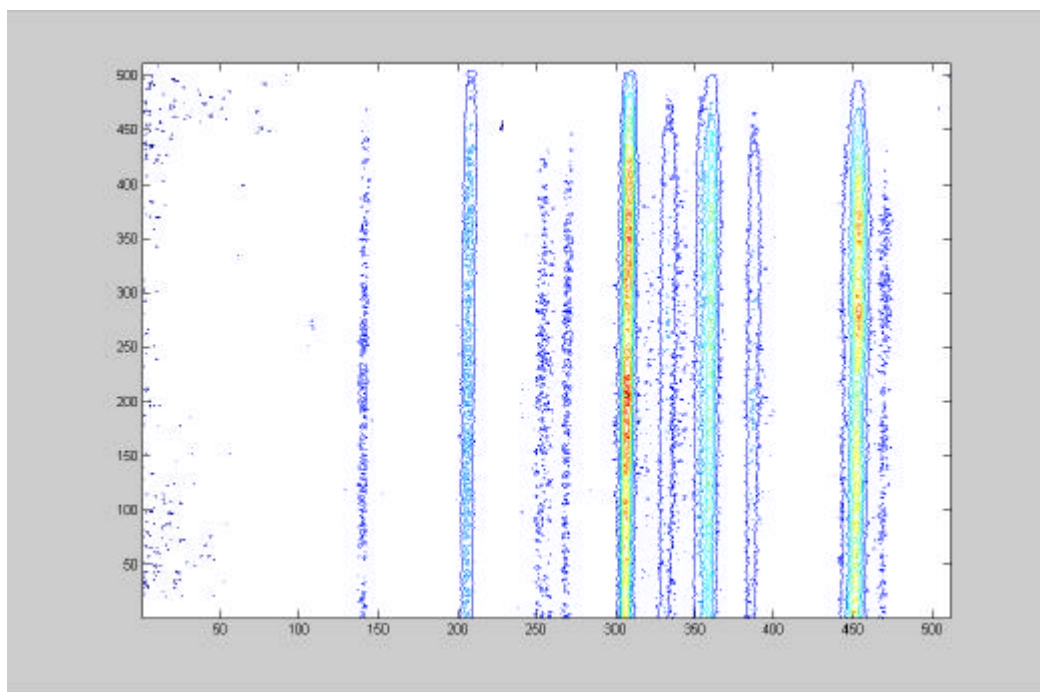

Figure 29. Raw LINUS Image of Pt Spectrum Using 289 nm Filter (Axes Correspond to Pixel Numbers)

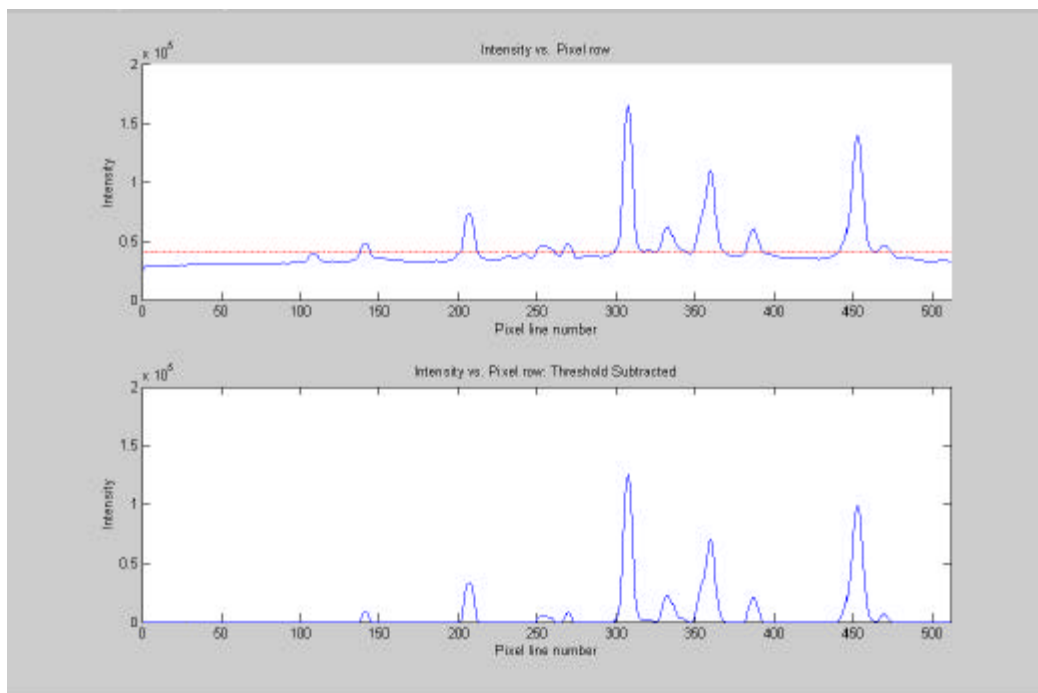

Figure 30. Coadded Pt Spectrum and Threshold Subtraction Using 289nm Filter

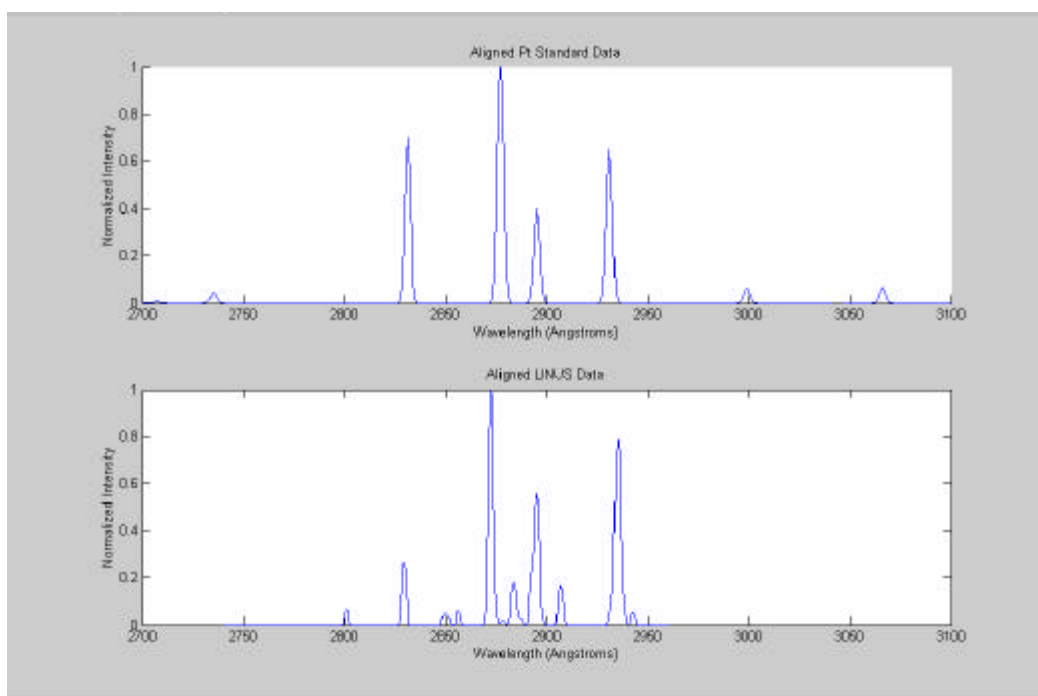

Figure 31. Data Alignment Using 289nm Filter
 Top Panel: Preprocessed NIST Reference Data
 Bottom Panel: Aligned LINUS Data

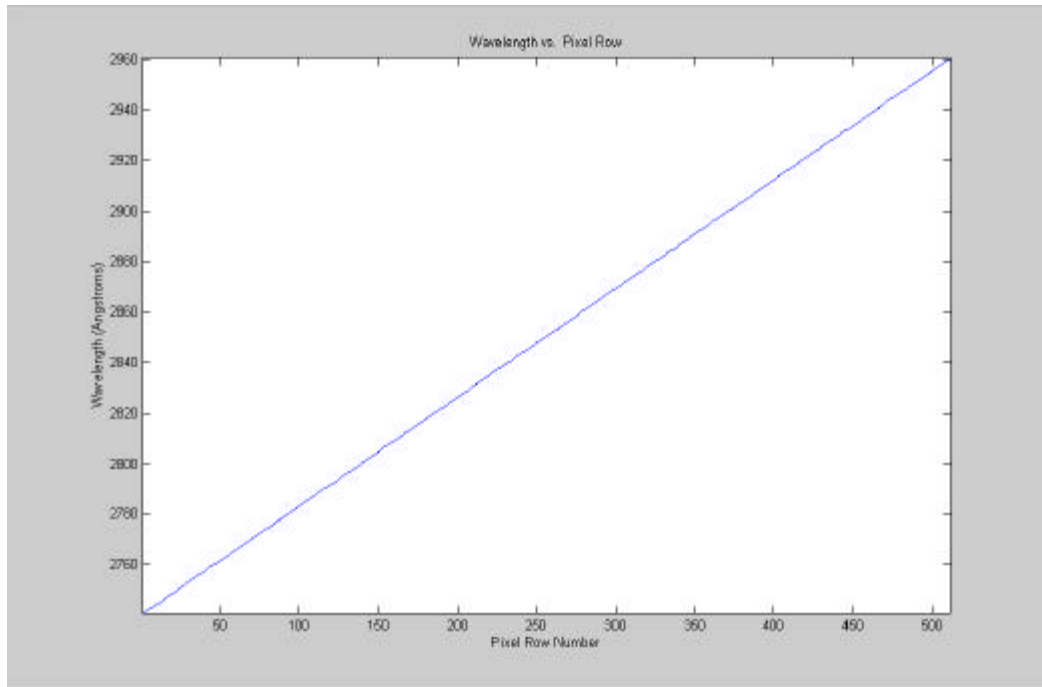

Figure 32. Wavelength Calibration Curve Using 289 nm Filter

D. 300NM FILTER

The camera's focal plane was found to span a wavelength interval of 34.5 nm, from 282.4 to 316.9 nm.

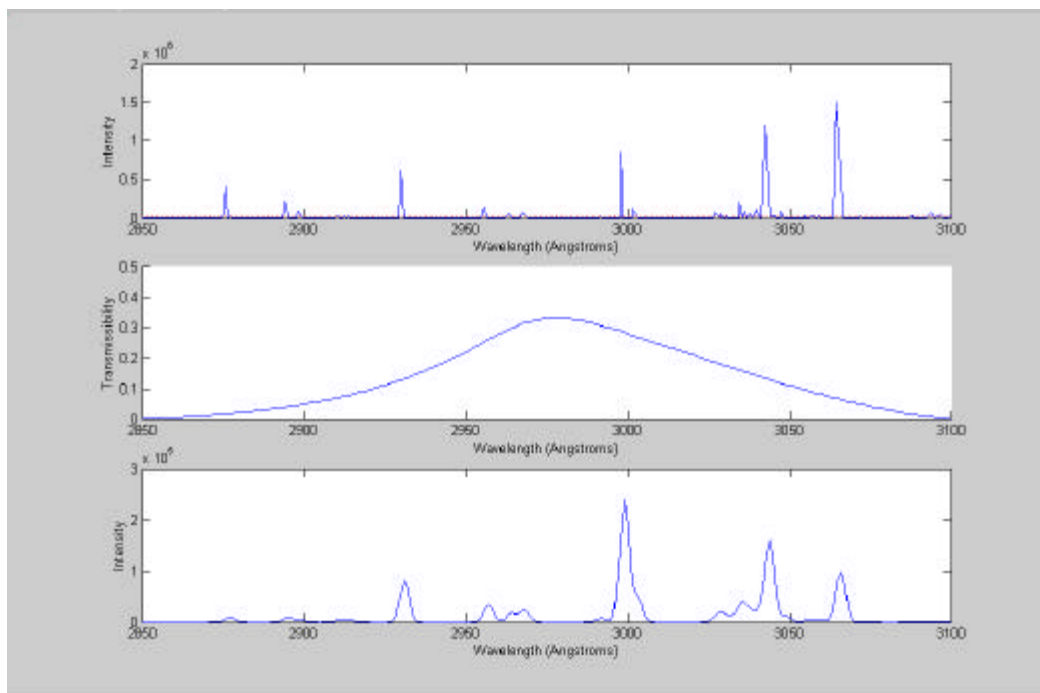

Figure 33. Pt Standard Preprocessing: 300nm Filter
 Top Panel: Pt Standard Emission Lines
 Middle Panel: 300 nm Filter Curve
 Bottom Panel: Final Preprocessed Output

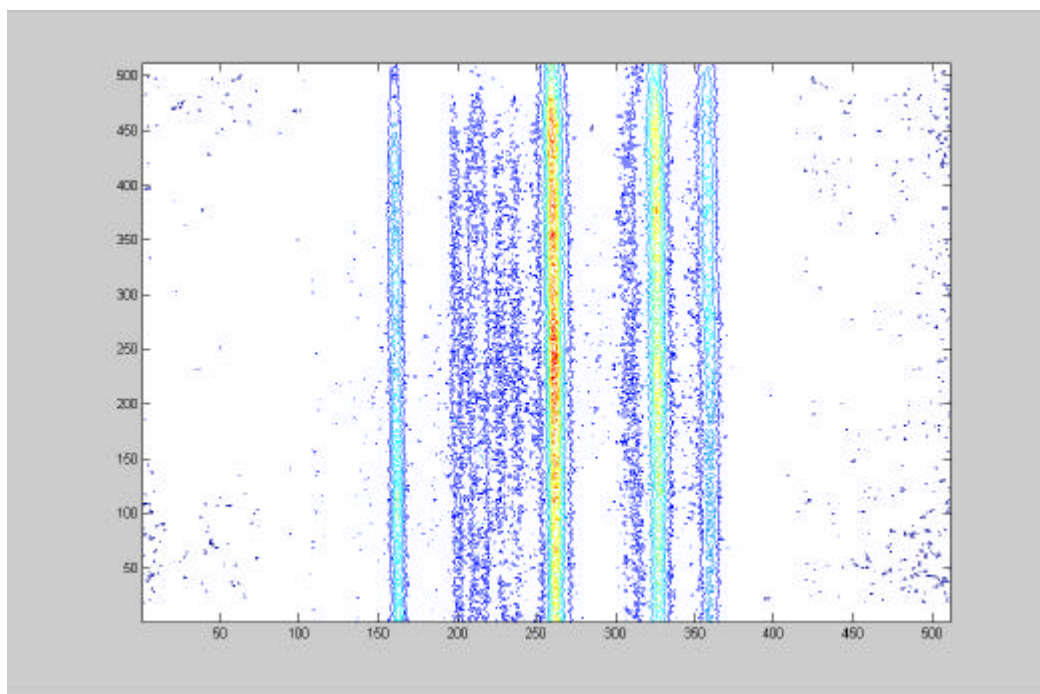

Figure 34. Raw LINUS Image of Pt Spectrum Using 300 nm Filter (Axes Correspond to Pixel Numbers)

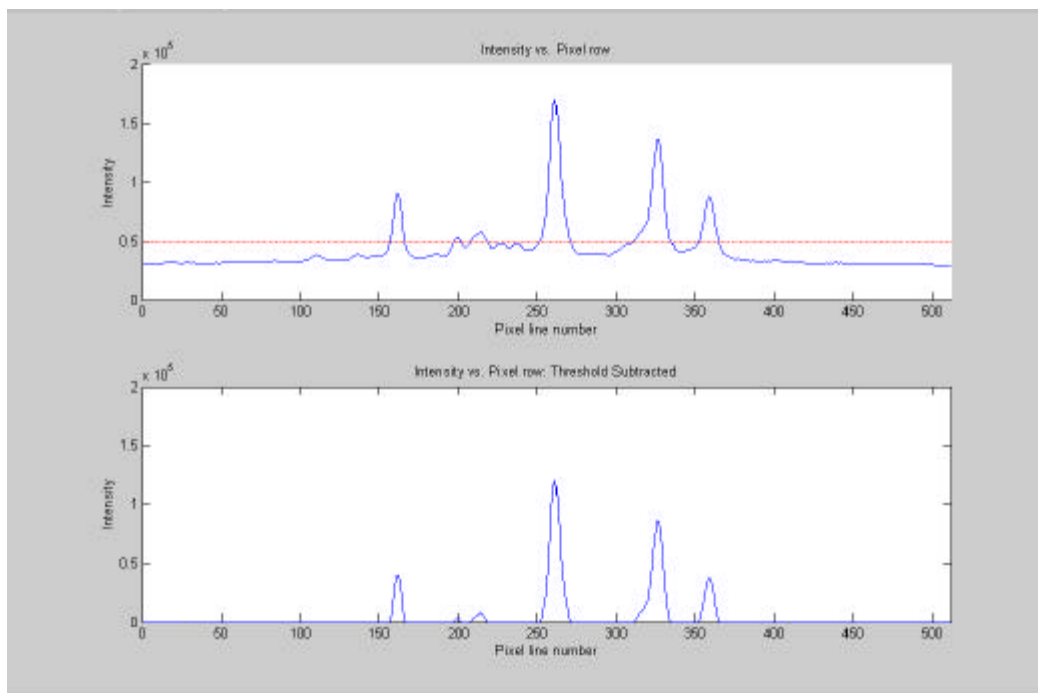

Figure 35. Coadded Pt Spectrum and Threshold Subtraction Using 300nm Filter

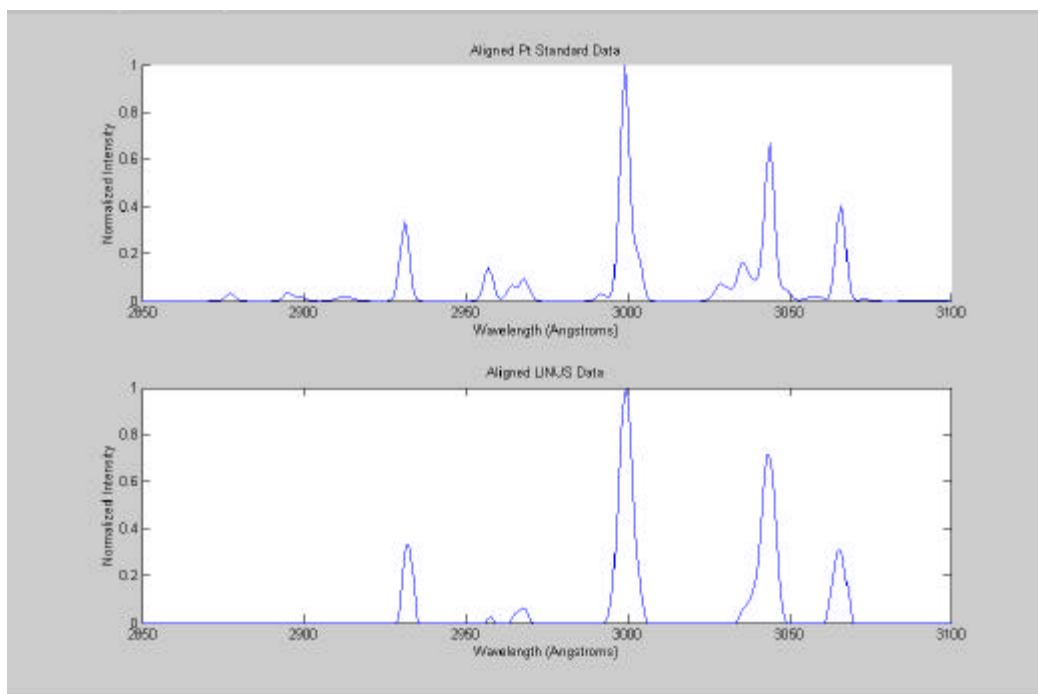

Figure 36. Data Alignment Using 300nm Filter
 Top Panel: Preprocessed NIST Reference Data
 Bottom Panel: Aligned LINUS Data

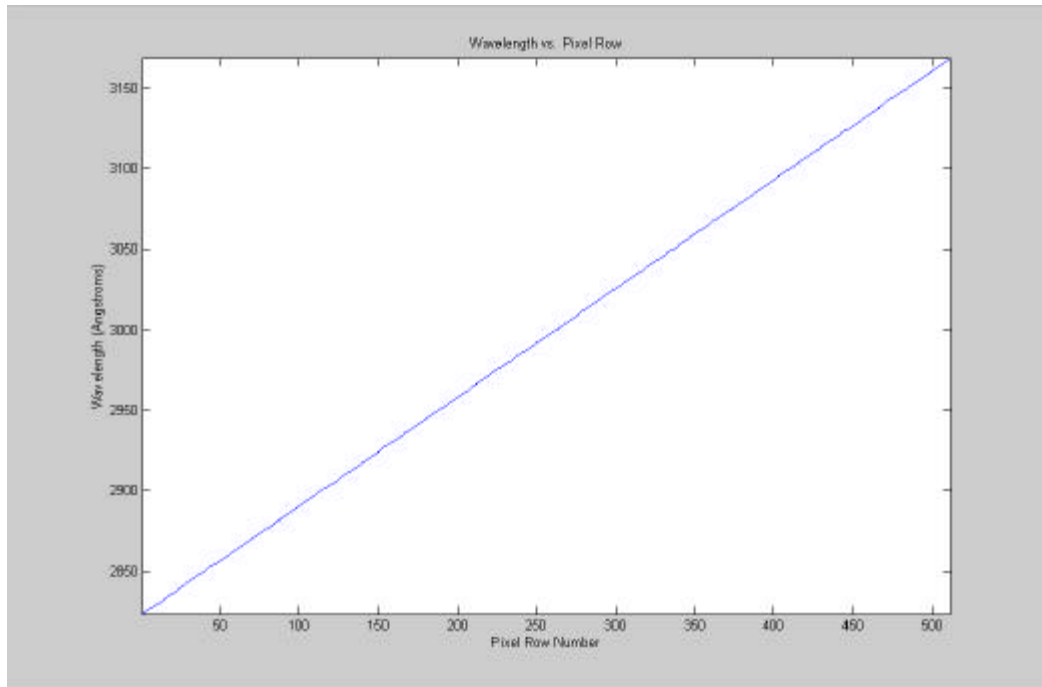

Figure 37. Wavelength Calibration Curve Using 300 nm Filter

E. 334NM FILTER

The camera's focal plane was found to span a wavelength interval of 34.5 nm, from 326.2 to 360.7 nm.

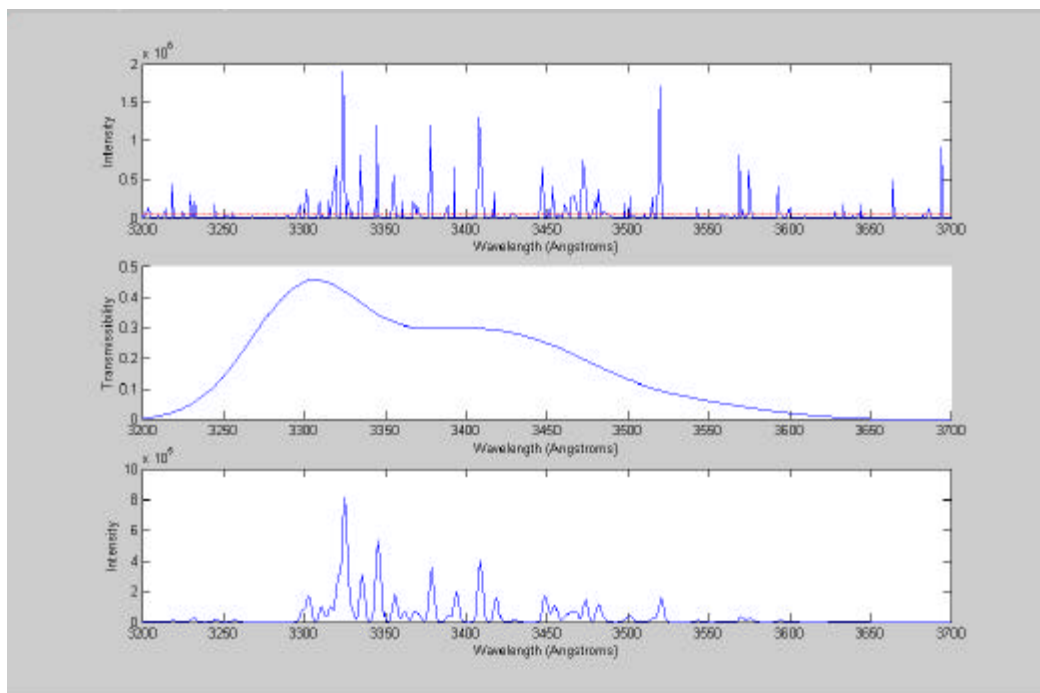

Figure 38. Pt Standard Preprocessing: 334nm Filter
 Top Panel: Pt Standard Emission Lines
 Middle Panel: 334 nm Filter Curve
 Bottom Panel: Final Preprocessed Output

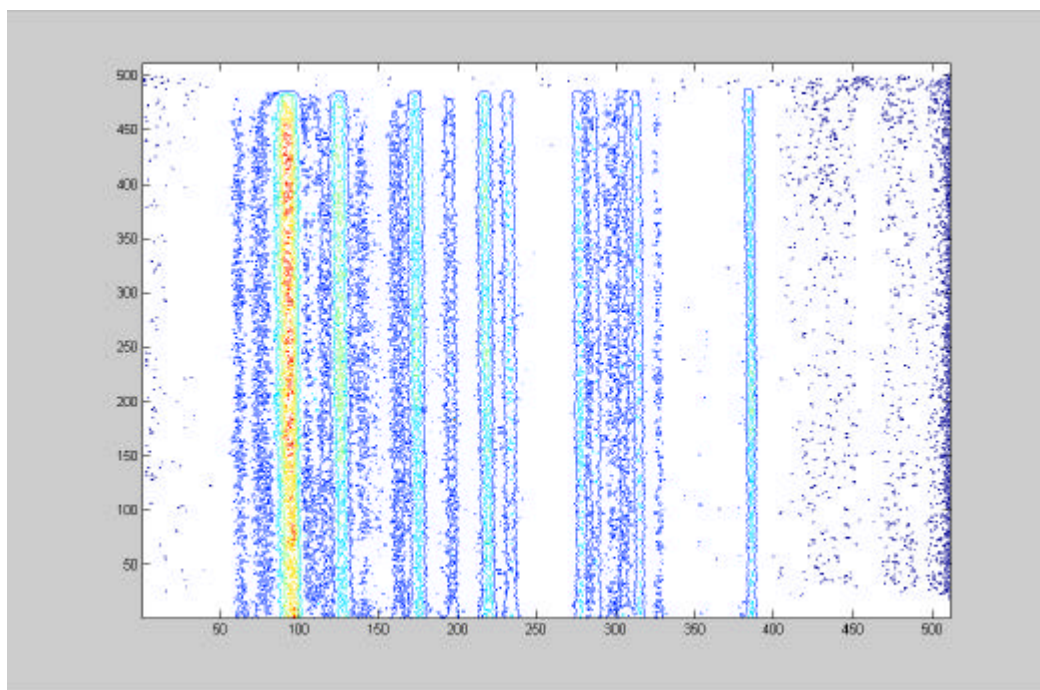

Figure 39. Raw LINUS Image of Pt Spectrum Using 334 nm Filter (Axes Correspond to Pixel Numbers)

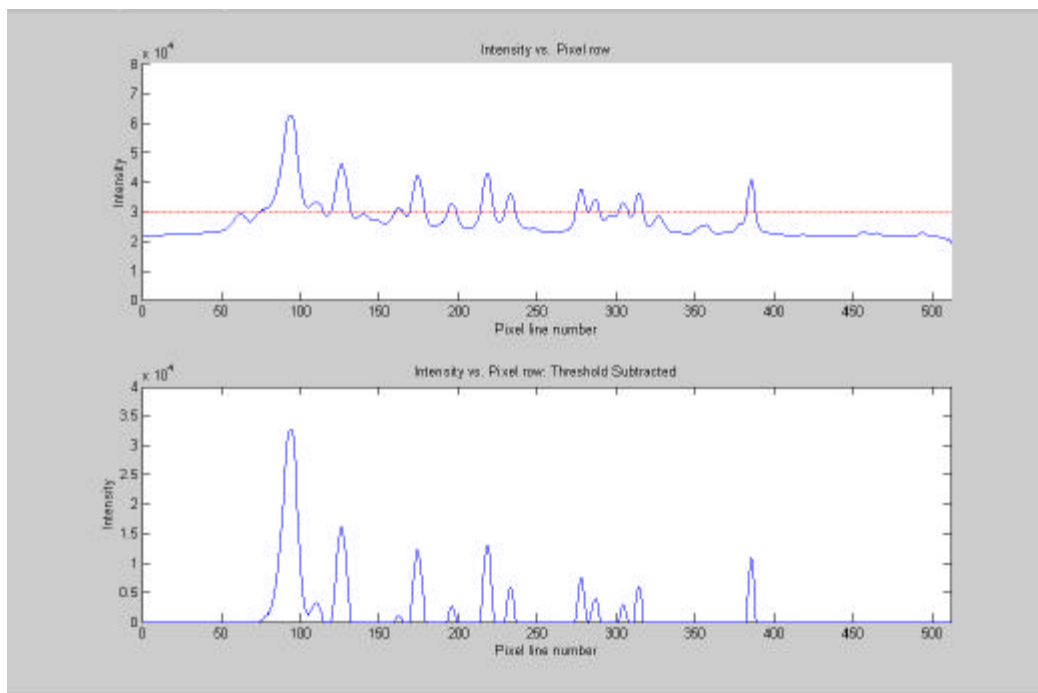

Figure 40. Coadded Pt Spectrum and Threshold Subtraction Using 334nm Filter

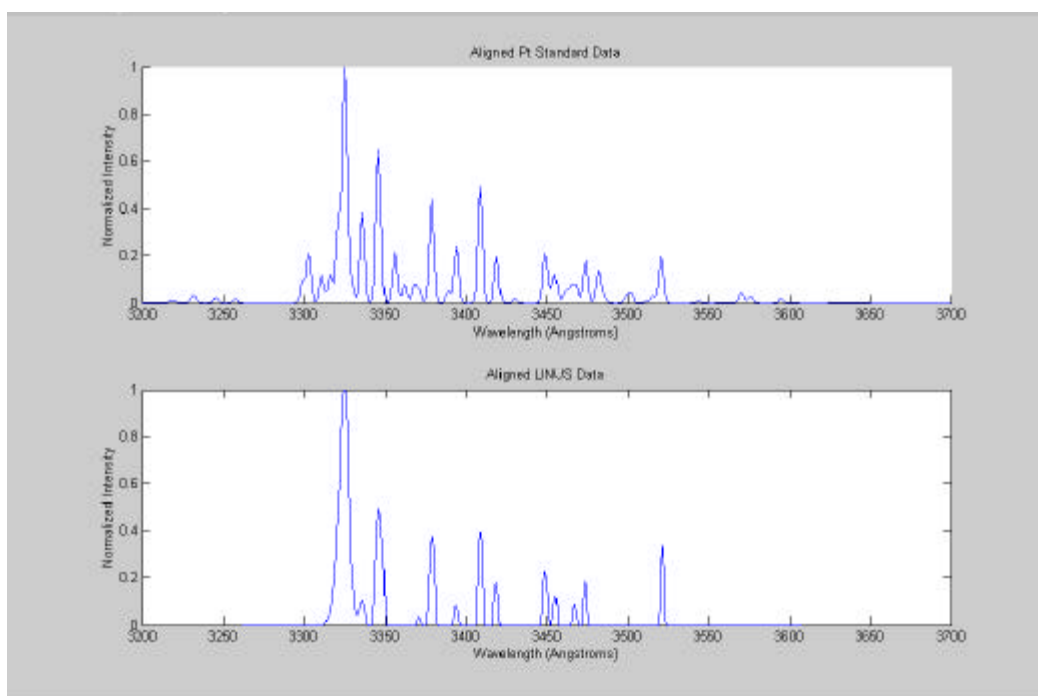

Figure 41. Data Alignment Using 334nm Filter
 Top Panel: Preprocessed NIST Reference Data
 Bottom Panel: Aligned LINUS Data

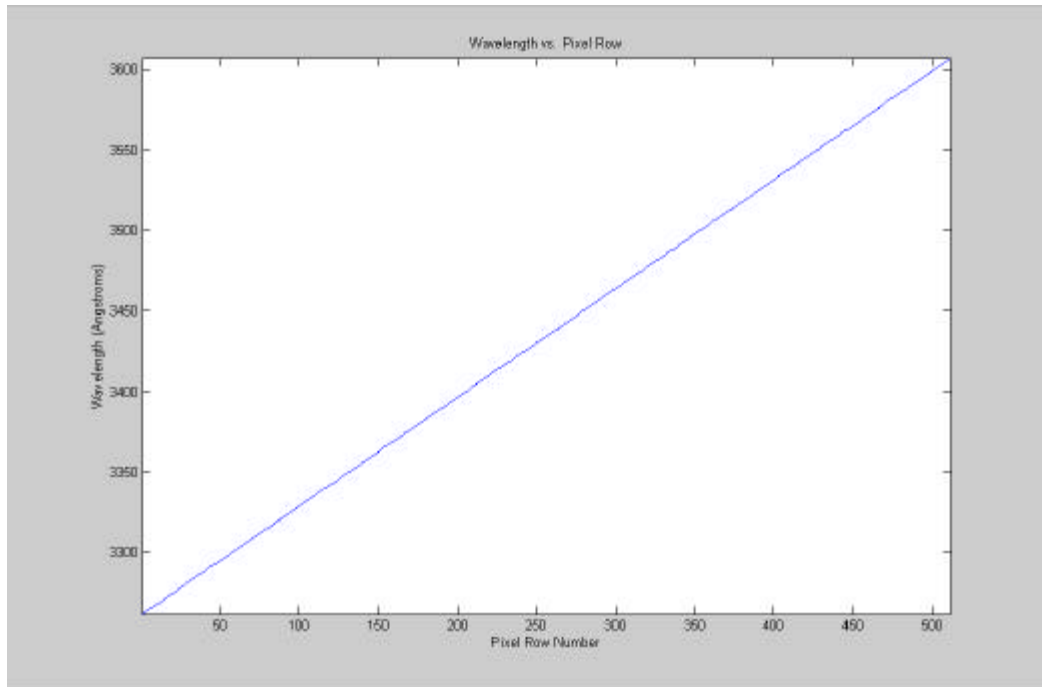

Figure 42. Wavelength Calibration Curve using 334 nm Filter

F. 370NM FILTER

The camera's focal plane was found to span a wavelength interval of 34.1 nm, from 345.8 to 379.9 nm.

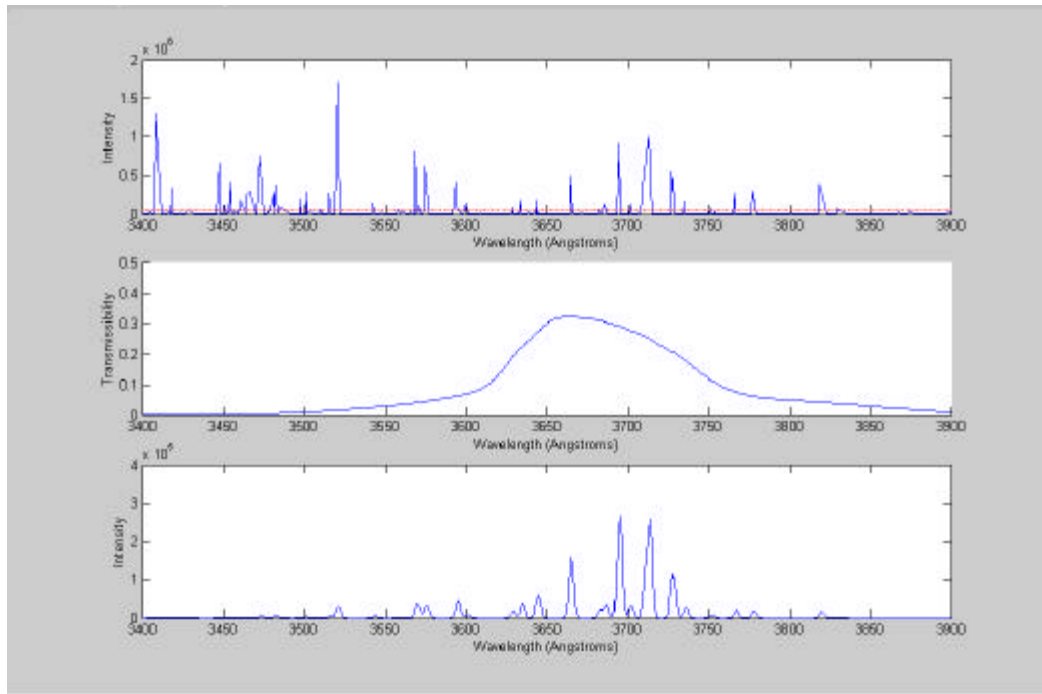

Figure 43. Pt Standard Preprocessing: 370nm Filter
 Top Panel: Pt Standard Emission Lines
 Middle Panel: 370 nm Filter Curve
 Bottom Panel: Final Preprocessed Output

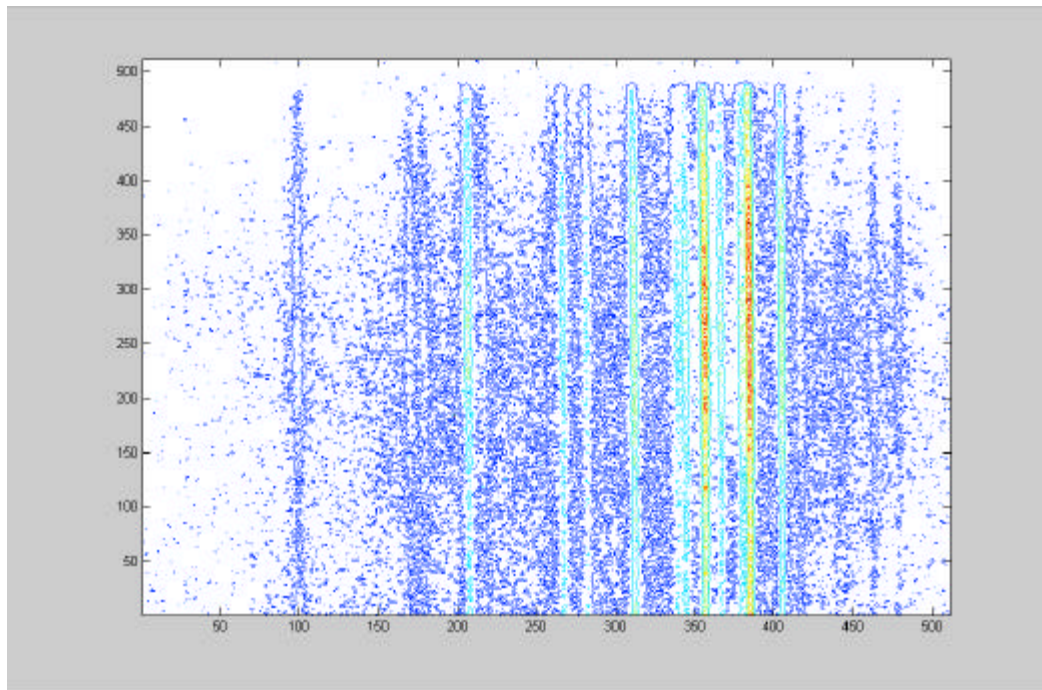

Figure 44. Raw LINUS Image of Pt Spectrum Using 370 nm Filter (Axes Correspond to Pixel Numbers)

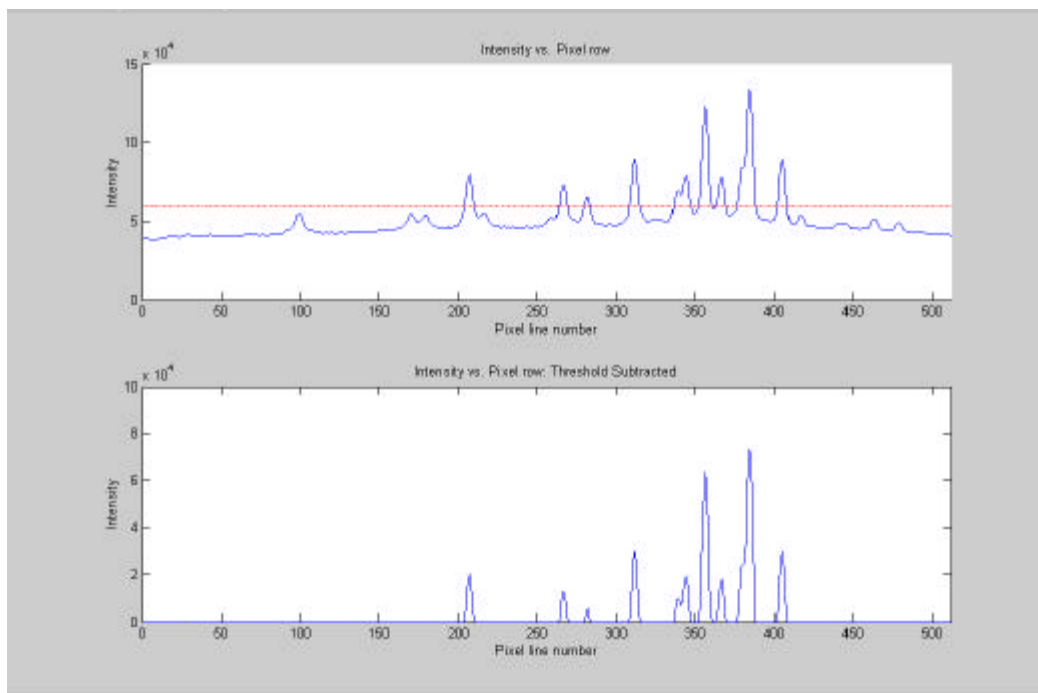

Figure 45. Coadded Pt Spectrum and Threshold Subtraction Using 370nm Filter

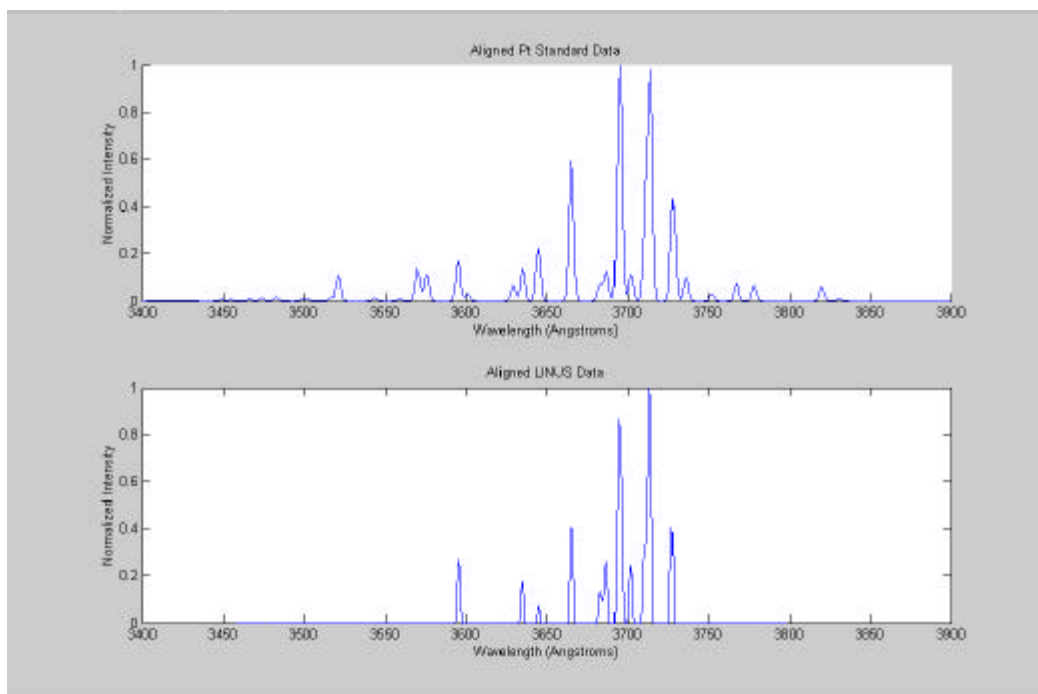

Figure 46. Data Alignment Using 370nm Filter
 Top Panel: Preprocessed NIST Reference Data
 Bottom Panel: Aligned LINUS Data

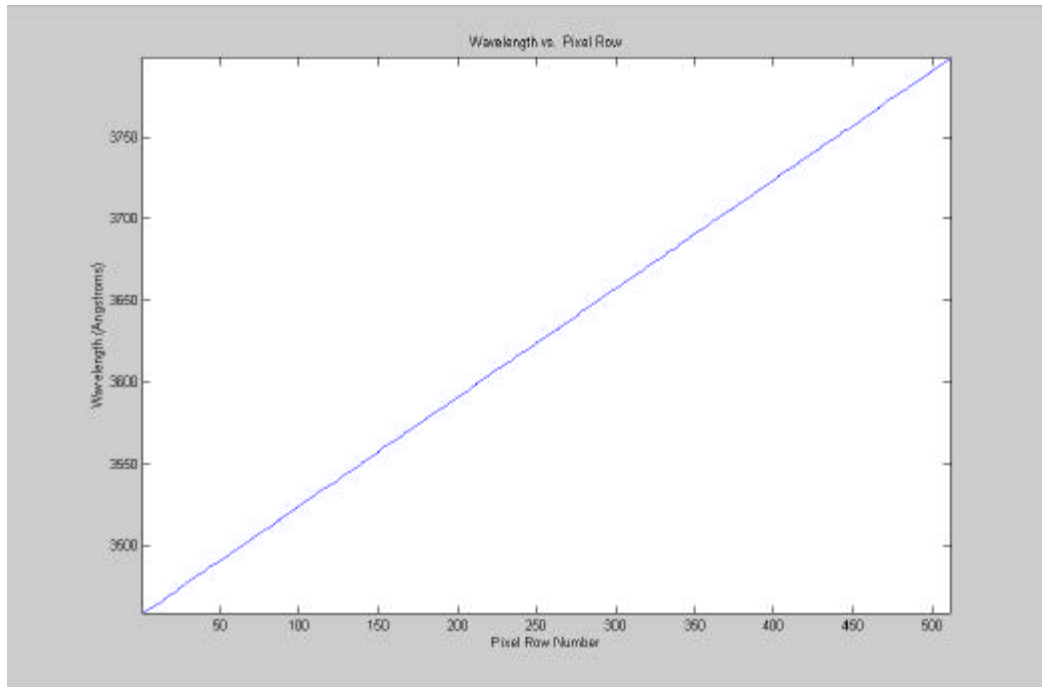

Figure 47. Wavelength Calibration Curve Using 370 nm Filter

VI. CONCLUSIONS AND RECOMMENDATIONS

This project was successful in generating wavelength calibration data for the LINUS instrument. The automatic wavelength calibration for all five spectral bands was easily verified qualitatively by eye. Quantitatively, the aligned observed LINUS data generated minimal χ^2 error values when compared to the platinum standard.

The calibration program as completed is capable of generating accurate calibration curves for all of the spectral bands studied to date. These five spectral bands do not, however, completely span the entire LINUS design operating band of 200-400nm. It is therefore recommended that additional filters be procured to span these gaps in the LINUS operating band. Once the calibration procedure has been conducted for the remaining filters, LINUS will be capable of detecting and quantifying a large number of chemical species.

THIS PAGE INTENTIONALLY LEFT BLANK

APPENDIX: WAVELENGTH CALIBRATION PROGRAM CODE

```
%%%%%%%%%%%%%%%%%%%%%%%%%%%%%%%%%%%%%%%%%%%%%%%%%%%%%%%%%%%%%%%%%%%%%%%%
%%      LINUS Wavelength Calibration Program      %%
%%%%%%%%%%%%%%%%%%%%%%%%%%%%%%%%%%%%%%%%%%%%%%%%%%%%%%%%%%%%%%%%%%%%%%%%

%   This program integrates previously developed
%   subprograms in order to perform wavelength
%   calibration of the LINUS UV imaging spectrometer.
%
%   The process consists of:
%       1.  Preprocessing NIST data
%           Loading from .dat file
%           Pre-filtering for intensity, filter
passband
%           Correcting for UV filter transmission
%           Broadening the spectral lines
%           Reindexing for x-axis graduation
%
%       2.  Preprocessing LINUS data
%           Loading from .tif file
%           Converting 2-D image to 1-D intensity
%           Pre-filtering for intensity
%
%       3.  Cross-correlation
%           "Stretch" NIST for maximum xcorr value
%           Using "Best stretch", find best shift
between NIST and LINUS
%           Complete calibration - wavelength vs. pixel
line number

%%  VERSION NOTES:

clear

%  USER SPECIFIED PARAMETERS
filterChoice    = 1%    1=220nm, 2=289nm, 3=300nm, 4=334nm,
5=370nm
flipLINUS       = 0    % 0 if image normal, 1 if image
flipped
                                % 289nm data only (to date)

if (filterChoice==1) % 220nm
    MinWavelength    =    2100;
%[Angstroms]
```

```

    MaxWavelength          =    2400;
%[Angstroms]
    IntensityThreshold     =    2.5e4;           %3e4
    LINUSIntensityThreshold =    7e4           %2e4
    LINUSfile = 'a220nmlst.tif'
    %   Input filter transmission data
    y = [0.00 0.010 0.04 0.13 0.320 0.33 0.300 0.210 0.040
0.010 0.000]';
    t = 10*[210 212 215 217 220 221 223 225 230 235 240]';

    %   Affine Transformation Range
    InitialStretchFactor = .14%.20%.25;% .14
    FinalStretchFactor = .17%.25%.29;% .16
    StretchInterval = .005;
end

if (filterChoice==2) % 289nm
    MinWavelength          =    2700;
%[Angstroms]
    MaxWavelength          =    3100;
%[Angstroms]
    IntensityThreshold     =    2e5;           %8e4
    LINUSIntensityThreshold =    4e4;           %4e4
    LINUSfile = 'a289nmlstMoreMCP.TIF'
    flipLINUS              = 1    % 0 if image normal, 1 if image
flipped
                                % 289nm data only (to date)
    %   Input filter transmission data
    y = [0.000 0.010 0.020 0.070 0.300 0.370 0.270 0.120
0.010 0.000 0.000]';
    t = 10*[270 272 275 280 285 288 290 295 300 305 310]';
    %   Affine Transformation Range
    InitialStretchFactor = .463%.46;% .50
    FinalStretchFactor = .5%.50;% .52
    StretchInterval = .001;
end

if (filterChoice==3) % 300nm
    MinWavelength          =    2850;
%[Angstroms]
    MaxWavelength          =    3100;
%[Angstroms]
    IntensityThreshold     =    2e4;           %3e4
    LINUSIntensityThreshold =    5e4;           %6e4
    LINUSfile = 'a300nmlstFoc2.tif'
    %   Input filter transmission data

```

```

y = [0.000 0.001 0.050 0.220 0.320 0.280 0.110 0.000]';
t = 10*[280 285 290 295 297 300 305 310]';

% Affine Transformation Range
InitialStretchFactor = .12;%0.12
FinalStretchFactor = .19;%0.14
StretchInterval = .005;
end

if (filterChoice==4) % 334nm
    MinWavelength = 3200;
%[Angstroms]
    MaxWavelength = 3700;
%[Angstroms]
    IntensityThreshold = 5e4; %3e4
    LINUSIntensityThreshold = 3e4; %2e4
    LINUSfile = 'a334nmlst.tif'
    % Input filter transmission data
y = [0.000 0.003 0.140 0.450 0.330
0.300 0.250 0.130 0.060 0.020
0.000 0]';
t = 10*[315 320 325 330 335 340 345 350 355 360 365 370]';
% Affine Transformation Range
InitialStretchFactor = .3;%0.37BSF
FinalStretchFactor = .7;%
StretchInterval = .005;
end

if (filterChoice==5) %370nm
    MinWavelength = 3400;
%[Angstroms]
    MaxWavelength = 3900;
%[Angstroms]
    IntensityThreshold = 5e4; %3e4
    LINUSIntensityThreshold = 6e4; %2e4
    LINUSfile = 'a370nmlst.tif'
    % Input filter transmission data
y = [0 .003 .01 .03 .07 .13 .2 .25 .30 .32 .30 .28 .26
.23 .20 .16 .12 .05 .03 .01 0 0]';
t = 1000*[3.40 3.45 3.50 3.55 3.60 3.62 3.63 3.64 3.65
3.67 3.69 3.70 3.71 3.72 3.73 3.74 3.75 3.80 3.85 3.90 3.95
4.00]';
% Affine Transformation Range
InitialStretchFactor = .35;%0.37
FinalStretchFactor = .41;%0.29
StretchInterval = .005;

```

```

end

% Other Definitions:
% Sampling parameter for NIST elongation
divisions = 2000;
% define gaussian curve shape
gauss = [.002 .018 .105 .368 .779 1 .779 .368 .105
.018 .002];

%%%%%%%%%%%%%%%%%%%%%%%%%%%%%%%%%%%%%%%%%%%%%%%%%%%%%%%%%%%%%%%%%%%%%%%%
%%%%%%%%%%%%%%%%%%%%%%%%%%%%%%%%%%%%%%%%%%%%%%%%%%%%%%%%%%%%%%%%%%%%%%%%

% 1.1 Data import and assignment into two Nx1 matrices
load NISTFull.dat;
NISTWavelength = NISTFull(:,1);
NISTIntensity = NISTFull(:,2);

NISTlength = length(NISTWavelength)
waveband = MinWavelength:1:MaxWavelength;

figure(1)
subplot (4,1,1);
plot(NISTWavelength,NISTIntensity)
hold on
xdatum=MinWavelength:1:MaxWavelength;
plot(xdatum,IntensityThreshold,'-r');
hold off
axis([MinWavelength,MaxWavelength,0,4e5]);

%%%%%%%%%%%%%%%%%%%%%%%%%%%%%%%%%%%%%%%%%%%%%%%%%%%%%%%%%%%%%%%%%%%%%%%%
%%% FINAL DISPLAY PLOT
figure(40)
subplot (3,1,1);
plot(NISTWavelength,NISTIntensity)
hold on
xdatum=MinWavelength:1:MaxWavelength;
plot(xdatum,IntensityThreshold,'-r');
hold off
axis([MinWavelength,MaxWavelength,0,4e5])%2e6
xlabel('Wavelength (Angstroms)');
ylabel('Intensity');
%%%%%%%%%%%%%%%%%%%%%%%%%%%%%%%%%%%%%%%%%%%%%%%%%%%%%%%%%%%%%%%%%%%%%%%%
hold on
figure(1)

```

```

% 1.2 Discard values outside of bandwidth and below
threshold
i=1;
while i <= NISTlength
    if (NISTWavelength(i)<MinWavelength |
NISTWavelength(i)>MaxWavelength |
NISTIntensity(i)<IntensityThreshold)
        NISTIntensity(i)=[];
        NISTWavelength(i)=[];
        NISTlength=NISTlength-1;
        i=i-1;
    end
    i=i+1;
end

NISTlength = length(NISTWavelength)
subplot (4,1,2);
plot(NISTWavelength,NISTIntensity)

% 1.3 Gaussian broaden each spectral line
NISTwl = NISTWavelength; % Irregularly spaced,
fractional Angstroms
NISTint = NISTIntensity;
NISTwl = round(NISTwl); % Rounds to integer number
of Angstroms

%figure(20)
subplot(4,1,3)
plot(gauss)
axis([1,length(gauss),0,1])

newNISTwl = zeros(1,length(NISTwl)*length(gauss));
newNISTint = zeros(1,length(NISTwl)*length(gauss));
halfwidth = (length(gauss)-1)/2;

A = 1;
while(A<=length(NISTint))
    B = 1;
    while(B<=length(gauss))
        C=(A-1)*length(gauss)+B;
        newNISTwl(C) = NISTwl(A)-halfwidth+B;
        newNISTint(C)= gauss(B)*NISTint(A);
        B=B+1;
    end
    A=A+1;

```

```

end

newNISTwl; % Broadened, overlapping values
newNISTint;

subplot(4,1,4)
plot(newNISTwl,newNISTint,'r')

% 1.4 Sum overlapping intensity distributions
F = [];
G=1;
H = 1;
J = [];
K = [];

while (G<=length(waveband))%was spectrum
    while (H<=length(newNISTwl))
        F(H) = isequal(newNISTwl(H),waveband(G));
        H=H+1;
    end
    J(G)=sum(newNISTint(F));
    H=1;
    G=G+1;
end
J;
figure(2)
subplot(3,1,1)
plot(newNISTwl,newNISTint,'r')
hold on
plot(waveband,J)
hold off

NISTWavelength = waveband;
NISTIntensity = J;

% 1.3 NIST SPECTRUM MODIFICATION

% 1.3.1 SPLINE CURVE FIT
% Interpolate transmissability at each relevant
wavelength
T2=NISTWavelength;
FilterT = spline(t,y,T2);

subplot (3,1,2);
plot(t,y,'o')

```

```

axis([MinWavelength,MaxWavelength,0,.5]);
hold on
plot(T2,FilterT,'r.')
```

% 1.3.2 COMPUTE EXPECTED POST-FILTER INTENSITY VALUES

```

FilteredIntensity = FilterT.*J;
```

```

subplot (3,1,3);
plot(NISTWavelength,FilteredIntensity,'g')
axis([MinWavelength,MaxWavelength,0,1e5]);
```

```

%%%%%%%%%%%%%%%%%%%%%%%%%%%%%%%%%%%%%%%%%%%%%%%%%%%%%%%%%%%%%%%%%%%%%%%%
%% FINAL DISPLAY PLOT
figure(40)
subplot (3,1,2);
%plot(t,y,'o')
axis([MinWavelength,MaxWavelength,0,.5]);
hold on
plot(T2,FilterT)
xlabel('Wavelength (Angstroms)');
ylabel('Transmissibility');
```

```

subplot (3,1,3);
plot(NISTWavelength,FilteredIntensity)
axis([MinWavelength,MaxWavelength,0,1e5]);%2e5,3e5,1e6,4e5
xlabel('Wavelength (Angstroms)');
ylabel('Intensity');
```

```

%%%%%%%%%%%%%%%%%%%%%%%%%%%%%%%%%%%%%%%%%%%%%%%%%%%%%%%%%%%%%%%%%%%%%%%%
```

% 2 PROCESS LINUS SPECTRAL RESPONSE

% 2.1 Data import and assignment into 2 Nx1 matrices

```

LINUSimage = imread(LINUSfile);
if(flipLINUS==1)
    LINUSimage = fliplr(LINUSimage);
end
```

```

figure(3)
subplot (3,1,1);
contour(LINUSimage)
```

```

%%%%%%%%%%%%%%%%%%%%%%%%%%%%%%%%%%%%%%%%%%%%%%%%%%%%%%%%%%%%%%%%%%%%%%%%
%%%%%%%%
```

```

figure(41)
contour(LINUSimage)
figure(3)
%%%%%%%%%%%%%%%%%%%%%%%%%%%%%%%%%%%%%%%%%%%%%%%%%%%%%%%%%%%%%%%%%%%%%%%%

LINUSintensity = sum(LINUSimage,1);
DATAlength = length(LINUSintensity);

subplot (3,1,2);
hold on
plot(LINUSintensity);
xxdatum=1:1:512;
plot(xxdatum,LINUSIntensityThreshold,'-r');
hold off
%Title('Intensity vs. Pixel row');
xlabel('Pixel line number');
ylabel('Intensity');
axis([0,DATAlength,0,5e5]);

%%%%%%%%%%%%%%%%%%%%%%%%%%%%%%%%%%%%%%%%%%%%%%%%%%%%%%%%%%%%%%%%%%%%%%%%
%%%%%%%%%%%%%%%%%%%%%%%%%%%%%%%%%%%%%%%%%%%%%%%%%%%%%%%%%%%%%%%%%%%%%%%%
figure(42)
subplot (2,1,1);
hold on
plot(LINUSintensity);
xxdatum=1:1:512;
plot(xxdatum,LINUSIntensityThreshold,'-r');
hold off
Title('Intensity vs. Pixel row');
xlabel('Pixel line number');
ylabel('Intensity');
axis([0,DATAlength,0,2.5e5]);%2e5,8e4,8e4,1.5e5
figure(3)
%%%%%%%%%%%%%%%%%%%%%%%%%%%%%%%%%%%%%%%%%%%%%%%%%%%%%%%%%%%%%%%%%%%%%%%%

i=1;

% 2.2 Discard values outside of bandwidth and below
threshold
while i <= DATAlength
    if (LINUSintensity(i)<LINUSIntensityThreshold)
        LINUSintensity(i)=0;
    else
        LINUSintensity(i)=LINUSintensity(i)-
LINUSIntensityThreshold;
    end

```

```

        i=i+1;
end

LINUSintensity;
DATAlength = length(LINUSintensity);

subplot (3,1,3);
plot(LINUSintensity)
>Title('Intensity vs. Pixel row: Post-threshold');
xlabel('Pixel line number');
ylabel('Intensity');
axis([0,DATAlength,0,5e5]);

%%%%%%%%%%%%%%%%%%%%%%%%%%%%%%%%%%%%%%%%%%%%%%%%%%%%%%%%%%%%%%%%%%%%%%%%
%%%%%%%%
figure(42)
subplot (2,1,2);
plot(LINUSintensity)
Title('Intensity vs. Pixel row: Threshold Subtracted');
xlabel('Pixel line number');
ylabel('Intensity');
axis([0,DATAlength,0,2e5]);%, ,4e4,1e5
%%%%%%%%%%%%%%%%%%%%%%%%%%%%%%%%%%%%%%%%%%%%%%%%%%%%%%%%%%%%%%%%%%%%%%%%

%   3   REINDEX NIST

%   3.1 Data import and assignment into 2 Nx1 matrices

%   Graduation of horizontal axes
gradNISTx =waveband;

gradNISTy =J;%%%NEW IN V9

%%% Remove NaN Problem in gradNISTs
check = find(isnan(gradNISTy));
gradNISTy(check)=0;

%Normalizing
FilteredIntensity=FilteredIntensity/max(FilteredIntensity);
LINUSintensity=LINUSintensity/max(LINUSintensity);

figure(4)

```

```

subplot (2,1,1);
hold on
plot(NISTWavelength,FilteredIntensity,'g')
hold off
axis([MinWavelength,MaxWavelength,0,1]);

subplot (2,1,2);
plot(LINUSintensity)
axis([1,DATAlength,0,1]);

%%%%%%%%%%%%%%%%%%%%%%%%%%%%%%%%%%%%%%%%%%%%%%%%%%%%%%%%%%%%%%%%%%%%%%%%

StretchFactor = InitialStretchFactor;
Index = (FinalStretchFactor-
StretchFactor)/StretchInterval+1;
I=1;
maxCorrMod      = [];
maxCorrUnmod    = [];
stretchFactorAxis = [];
lengthCorr      = [];
figure(5)

while (I <= Index)
    interval = (MaxWavelength-
MinWavelength)/(StretchFactor*divisions);
    StretchNISTx = MinWavelength:interval:MaxWavelength;
    StretchNISTy =
interp1(gradNISTx,gradNISTy,StretchNISTx);

    subplot(Index,2,1+2*(I-1))
    hold on
    plot(StretchNISTy,'g')%,'.g')
    plot(LINUSintensity)
    %axis([0,512,0,4e5]);
    axis([0,512,0,1]);
    hold off

    crosscorrelation = xcorr(LINUSintensity,StretchNISTy);
    maxCorrUnmod(I) = max(crosscorrelation);

    % For "Pseudo-Normalization" of xcorr values
    lc = length(LINUSintensity)+length(StretchNISTy)-1;
    %% Necessary since, from MATLAB helpguide...
    %%c = xcorr(x,y) returns the cross-correlation
sequence in a length 2*N-1 vector, where x and y are

```

```

    %%length N vectors (N>1). If x and y are not the same
length, the shorter vector is zero-padded to
    %%the length of the longer vector.
    lengthCorr(I) = lc;
    crosscorrelation = crosscorrelation / lc;
    maxCorrMod(I) = max(crosscorrelation);
    stretchFactorAxis(I) =StretchFactor;

    subplot(Index,2,2*I)
    plot(crosscorrelation)
    %axis([0,1200,0,1e9]);

    StretchFactor = StretchFactor + StretchInterval;
    I=I+1;
end

figure(6)
subplot(3,1,1)
plot(stretchFactorAxis,maxCorrUnmod)

subplot(3,1,2)
plot(stretchFactorAxis,lengthCorr,'r')

% Peak corresponds to point of maximum correlation growth
% when referenced to growth of correlation length
subplot(3,1,3)
plot(stretchFactorAxis,maxCorrMod)

% Redisplay of above alone for emphasis
figure(7)
plot(stretchFactorAxis,maxCorrMod)

%%%%%%%%%%%%%%
% Relating pixel line number to wavelength

[BestCorrValue,BestCorrIndice] = max(maxCorrMod)

BestStretchFactor = InitialStretchFactor +(BestCorrIndice-
1)*StretchInterval
%BestStretchFactor = .168 %Manual Override increase
decreases LINUS width
interval = (MaxWavelength-
MinWavelength)/(BestStretchFactor*divisions);
StretchNISTx = MinWavelength:interval:MaxWavelength;

StretchNISTy = interp1(gradNISTx,gradNISTy,StretchNISTx);

```

```

crosscorrelation = xcorr(LINUSintensity,StretchNISTy);
maxCorrUnmodFinal = max(crosscorrelation);

lc = length(LINUSintensity)+length(StretchNISTy)-1;
lengthCorr(I) = lc;
crosscorrelation = crosscorrelation / lc;
[maxCorrModFinal,maxCorrIndice] = max(crosscorrelation)
lengthCorr = length(crosscorrelation)

figure(8)
    plot(crosscorrelation)
    %axis([0,1200,0,3e9]);

lengthStretch = length(StretchNISTx)
StretchNISTx';
StretchIndice = 1:1:lengthStretch;
offset = maxCorrIndice-
max(lengthStretch,DATAlength);%%%FIXED!!!
%offset = 835-
max(lengthStretch,DATAlength);%%%FIXED!!!289,sf=.643

pixelWidth = interval

LinusMin = MinWavelength - offset*pixelWidth
LinusMax = LinusMin + 511*pixelWidth
LINUSwavelength = LinusMin:interval:LinusMax;

figure(9)
LINUSline = 1:1:512;
MinPlotWavelength = min(LINUSwavelength)
MaxPlotWavelength = max(LINUSwavelength)
plot(LINUSline,LINUSwavelength)
axis([1,512,MinPlotWavelength,MaxPlotWavelength]);
Title('Wavelength vs. Pixel Row');
xlabel('Pixel Row Number');
ylabel('Wavelength (Angstroms)');

figure(10)
subplot (2,1,1);
hold on
plot(NISTWavelength,FilteredIntensity)
hold off
axis([MinWavelength,MaxWavelength,0,1]);

```

```

Title('Aligned Pt Standard Data');
xlabel('Wavelength (Angstroms)');
ylabel('Normalized Intensity');

subplot (2,1,2);
plot(LINUSwavelength,LINUSintensity)
axis([MinWavelength,MaxWavelength,0,1]);
Title('Aligned LINUS Data');
xlabel('Wavelength (Angstroms)');
ylabel('Normalized Intensity');

% Computation of spectral properties
SprectralRangeCamera = MaxPlotWavelength-MinPlotWavelength
SprectralRangePixel =
SprectralRangeCamera/length(LINUSline)

figure(11)
hold on
plot(NISTWavelength,FilteredIntensity,'g')
plot(LINUSwavelength,LINUSintensity)
hold off

```

THIS PAGE INTENTIONALLY LEFT BLANK

LIST OF REFERENCES

1. Bourke, P., *Cross-Correlation*, <http://astronomy.swin.edu.au/pbourke/analysis/correlate>, August 1996.
2. Kompatzki, R.C., *Design and Development of the Image Scanner for Lineate Imaging Near Ultraviolet Spectrometer (LINUS)*, Master's Thesis, Naval Postgraduate School, Monterey, California, December 1999.
3. Lindley, C.A., *Practical Image Processing in C*, John Wiley and Sons, Inc., 1991.
4. Marino, S.A., *Operation and Calibration of the NPS Ultraviolet Imaging Spectrometer (NUVIS) in the Detection of Sulfur Dioxide Plumes*, Master's Thesis, Naval Postgraduate School, Monterey, California, December 1999.
5. Omega Optical Company, *Spectral Transmission Curves*, Brattleboro, Vermont, 2000.
6. Pedrotti, F.L., and Pedrotti, L.S., *Introduction to Optics*, Second Edition, Prentice Hall, 1993.
7. Roper Scientific, *WinView User's Manual*, P/N4411-0046, 1999.
8. Sansonetti, J.E., Reader, J. and Sansonetti, C.J. *Atlas of the Spectrum of Platinum/Neon Hollow-Cathode Lamp in the Region 1130-4330 Angstroms*, <http://physics.nist.gov/PhysRefData/platinum/contents.html>, 1992 National Institute of Standards and Technology, 1992.
9. Taylor, J.R., *An Introduction to Error Analysis*, University Science Books, 1982.
10. Wolfe, W.L., *Introduction to Imaging Spectrometers*, SPIE-The International Society for Optical Engineering, Washington, 1997.

THIS PAGE INTENTIONALLY LEFT BLANK

INITIAL DISTRIBUTION LIST

1. Defense Technical Information Center 2
Ft. Belvoir, Virginia
2. Dudley Knox Library 2
Naval Postgraduate School
Monterey, California
3. David S. Davis, Code PH 2
Naval Postgraduate School
Monterey, California
4. Richard M. Harkins, Code PH 1
Naval Postgraduate School
Monterey, California
5. Richard C. Olson, Code PH 1
Naval Postgraduate School
Monterey, California
6. Chairman, Code PH 1
Naval Postgraduate School
Monterey, California
7. Curricular Officer, Code 31 1
Naval Postgraduate School
Monterey, California
8. LT Daniel W. Kuriger, Code 31 5
Naval Postgraduate School
Monterey, California