



Gear Crack Detection Using Tooth Analysis

Harry J. Decker

U.S. Army Research Laboratory, Glenn Research Center, Cleveland, Ohio

DISTRIBUTION STATEMENT A
Approved for Public Release
Distribution Unlimited

20020625 034

The NASA STI Program Office . . . in Profile

Since its founding, NASA has been dedicated to the advancement of aeronautics and space science. The NASA Scientific and Technical Information (STI) Program Office plays a key part in helping NASA maintain this important role.

The NASA STI Program Office is operated by Langley Research Center, the Lead Center for NASA's scientific and technical information. The NASA STI Program Office provides access to the NASA STI Database, the largest collection of aeronautical and space science STI in the world. The Program Office is also NASA's institutional mechanism for disseminating the results of its research and development activities. These results are published by NASA in the NASA STI Report Series, which includes the following report types:

- **TECHNICAL PUBLICATION.** Reports of completed research or a major significant phase of research that present the results of NASA programs and include extensive data or theoretical analysis. Includes compilations of significant scientific and technical data and information deemed to be of continuing reference value. NASA's counterpart of peer-reviewed formal professional papers but has less stringent limitations on manuscript length and extent of graphic presentations.
- **TECHNICAL MEMORANDUM.** Scientific and technical findings that are preliminary or of specialized interest, e.g., quick release reports, working papers, and bibliographies that contain minimal annotation. Does not contain extensive analysis.
- **CONTRACTOR REPORT.** Scientific and technical findings by NASA-sponsored contractors and grantees.

- **CONFERENCE PUBLICATION.** Collected papers from scientific and technical conferences, symposia, seminars, or other meetings sponsored or cosponsored by NASA.
- **SPECIAL PUBLICATION.** Scientific, technical, or historical information from NASA programs, projects, and missions, often concerned with subjects having substantial public interest.
- **TECHNICAL TRANSLATION.** English-language translations of foreign scientific and technical material pertinent to NASA's mission.

Specialized services that complement the STI Program Office's diverse offerings include creating custom thesauri, building customized data bases, organizing and publishing research results . . . even providing videos.

For more information about the NASA STI Program Office, see the following:

- Access the NASA STI Program Home Page at <http://www.sti.nasa.gov>
- E-mail your question via the Internet to help@sti.nasa.gov
- Fax your question to the NASA Access Help Desk at 301-621-0134
- Telephone the NASA Access Help Desk at 301-621-0390
- Write to:
NASA Access Help Desk
NASA Center for Aerospace Information
7121 Standard Drive
Hanover, MD 21076



Gear Crack Detection Using Tooth Analysis

Harry J. Decker

U.S. Army Research Laboratory, Glenn Research Center, Cleveland, Ohio

Prepared for the
56th Meeting
sponsored by the Society for Machinery Failure Prevention Technology
Virginia Beach, Virginia, April 15-19, 2002

National Aeronautics and
Space Administration

Glenn Research Center

Available from

NASA Center for Aerospace Information
7121 Standard Drive
Hanover, MD 21076

National Technical Information Service
5285 Port Royal Road
Springfield, VA 22100

Available electronically at <http://gltrs.grc.nasa.gov/GLTRS>

Gear Crack Detection Using Tooth Analysis

Harry J. Decker
U.S. Army Research Laboratory
Glenn Research Center
21000 Brookpark Road
Cleveland, Ohio 44135
Email: Harry.J.Decker@grc.nasa.gov

Abstract: Gear cracks are typically difficult to diagnose with sufficient warning time. Significant damage must be present before algorithms detect the damage. A new feature extraction and two new detection techniques are proposed. The time synchronous averaging concept was extended from revolution-based to tooth engagement-based. The detection techniques are based on statistical comparisons among the averages for the individual teeth. These techniques were applied to a series of three seeded fault crack propagation tests. These tests were conducted on aerospace quality spur gears in a test rig. The tests were conducted at speeds ranging from 2500 to 5000 revolutions per minute and torques from 184 to 228 percent of design load. The inability to detect these cracks with high confidence may be caused by the high loading required to initiate the cracks. The results indicate that these techniques do not currently produce an indication of damage that significantly exceeds experimental scatter.

Introduction: There is considerable work being performed in Health and Usage Monitoring Systems (HUMS) to reduce maintenance of mechanical components such as gearboxes and to increase vehicle safety. Health and Usage Monitoring can be classified into two major areas: diagnostics and prognostics. Diagnostics deals with the consistent and accurate detection of damage, while prognostics includes both damage estimation and estimating the remaining useful life.

A major concern of current HUMS systems is their reliability. A recent report proposes that the current fault detection rate of a vibration-based system is 60 percent. A false alarm is typically generated every hundred hours. [1,2]

Since 1988, NASA Glenn Research Center has been working on improving gear damage detection using vibration monitoring. Most of the effort has focused on pitting and other surface distress failures. Later, the testing expanded into both oil debris monitoring-based HUMS as well as vibration based crack detection and propagation. Gear cracks, although potentially more catastrophic, are much less common, thus more difficult to study.

Theory: Many different techniques have been proposed to detect damage in mechanical power transmissions. These methods include vibration, oil debris detection, chemical element detection, and acoustic emission. The focus of this paper is the analysis of the vibration.

One of the processes that virtually all of the existing diagnostic techniques require is synchronous averaging. Synchronous averaging has two desirable effects: (1) it reduces the effects of items in the vibration signal that are not synchronous with shaft and mesh frequencies; (2) because of this, the amplitudes of the desired parts of the signal are effectively amplified relative to the noise. The averaging technique typically used is synchronous with time (revolution). This paper presents a different averaging technique which will be referred to as tooth-based averaging.

Time Synchronous Averaging: A once per revolution tachometer pulse is required to synchronize different parts of the vibration signal. The tachometer signal is used to divide the digitized vibration signal into blocks representing exactly one revolution of the gear being studied. The beginning and end data points are interpolated to provide more accurate and consistent averages. Each block's data record is then interpolated to provide a convenient number of equally spaced points (typically a power of two, such as 1024) for the feature detection and extraction process. By interpolating each revolution into an equal number of points, slight changes in the rotational speed can be accommodated. Since each point in the signal now refers to the same angular position for all the sampled rotations, the blocks are simply averaged. A simple linear average is used since experience has shown that the interpolation method is not significant. [3]

Tooth-based Averaging: Tooth-based averaging is related to time synchronous averaging and has similar characteristics. The main differences are: 1) more information about the gear geometry is required, 2) the time relationship between the tachometer pulse and the engagement of a given tooth on the gear must be known.

In the meantime, the delay from the tachometer signal to when the time the tooth enters mesh must be taken into account. By measuring the rotational delay between the two points, it is easy to normalize this delay as a fraction of a revolution as follows:

$$D_{\text{percent}} = \frac{D_{\text{deg}}}{360} \quad (1)$$

The procedure is the same as for time synchronous averaging except that instead of basing the averaging on one complete revolution, it is now based on the period that an individual tooth is in contact with the mating tooth. It is not difficult to see how important the gear geometry is. A tooth from a gear that has a high contact ratio will remain in mesh longer than will a tooth of low contact ratio.

This type of analysis may detect smaller differences in the vibration from a damaged tooth that may be masked by data from other teeth that are in good condition. This method complements the more traditional methods that detect distributed damage. The combination of the methods may provide a more comprehensive detection capability.

The implementation of this type of analysis, although straightforward, is tedious. In this work, a once per revolution tachometer was mounted on the input shaft. A measurement of the angular distance between the beginning of the tachometer pulse and the start of engagement of a reference tooth is required. This, plus the known geometry, allows the identification of the beginning and ending of the mesh cycle for each tooth on the gear.

The arc of action is defined to be the distance expressed in radians and/or degrees that a given tooth is in contact. This answers the question of "how long" for the analysis. The arc of action is further expanded to include the arc of approach and the arc of recession. The arc of approach is the angle from initial tooth contact until the point when the tooth is in contact at the pitch point. The arc of recession is defined to be the rotational angle from the pitch point until the tooth no longer is in contact. The sum of these is the arc of action. The computation of the arc of action for external spur gears is relatively straightforward. [4,5]

The calculation begins with some basic geometry. The first of these is the addendum of the pinion (a_p , equation 2), which is a function of the diametral pitch of the pinion (P_p).

$$a_p = \frac{1}{P_p} \quad (2)$$

The pitch circle radius is the pitch diameter (D_p , equation 3) divided in half

$$R_p = \frac{D_p}{2} \quad (3)$$

The radius of the highest point on the involute of the pinion (Rob_p , equation 4) is simply the addendum added to the pitch circle radius with the edge break or chamfer (B_p) removed.

$$Rob_p = R_p + a_p - B_p \quad (4)$$

The base circle radius of the pinion (Rb_p , equation 5) is a function of the pitch circle radius and the operating pressure angle (ϕ_{op}).

$$Rb_p = R_p \cos\left(\phi_{op} \frac{\pi}{180}\right) \quad (5)$$

The arc of approach of the pinion (βa_p , equation 6) is the angle through which the gear tooth travels from the theoretical point where it comes into contact with the mating tooth to the pitch point.

$$\beta a_p = \beta r_g = \frac{\sqrt{Rob_p^2 - Rb_p^2} - R_p \sin\left(\phi_{op} \frac{\pi}{180}\right)}{Rb_g} \quad (6)$$

The arc of recession of the pinion (βr_p , equation 7) is the angle through which the gear tooth travels from the pitch point to the end of contact.

$$\beta r_p = \beta a_g = \frac{\sqrt{R_o b_g^2 - R b_g^2} - R_g \sin\left(\phi_{og} \frac{\pi}{180}\right)}{R b_p} \quad (7)$$

The arc of action (β) is the sum of the arcs of approach and recession, and is the total angular distance that the tooth is engaged.

The above calculations are for the pinion of a spur gear set. To calculate the values for the gear, simply substitute the appropriate subscripts. It is interesting to note that the arc of approach for the pinion is the same as the arc of recession for the gear. Since the gears used in this case have the same dimensions, the angles of approach and recession are equal.

The resultant averaged signals are then analyzed using the following techniques: root mean square (RMS), Crest Factor (CF), and the kurtosis (Kurt). In an attempt to eliminate speed and torque effects on the various parameters, a simple technique of normalizing the parameters to one of two methods is also examined. The parameters are normalized to the mean and a chosen distance from the mean. By normalizing to the condition of the other teeth, the time varying effects should be factored out. This chosen distance is the 90 percent probability level of a normal distribution.

The root mean square (RMS) is a simple measure of the effect of a fluctuating signal and is defined to be the square root of the average of the sum of the squares of the signal.

The Crest Factor [6] is calculated by dividing the maximum positive peak value by the RMS value of the signal.

The kurtosis [7] is the fourth moment of the signal normalized by the square of the variance of the signal. The kurtosis is a statistical measure of the number and amplitude of the peaks in a signal. A signal with a Gaussian distribution has a kurtosis of approximately three.

Experiment Configuration:

A spur gear fatigue test stand at the NASA Glenn Research Center in Cleveland, Ohio, was used to perform the testing. This facility, shown in Figure 1, allows the study of effects of gear tooth design, gear materials, and lubrication on the fatigue lives of aerospace quality gears. The test stand operates using the closed loop torque regeneration principle. The test gears are connected by shafts to a pair of helical gears that complete the loop. The torque is applied through a hydraulic loading mechanism that twists one slave gear relative to the shaft that supports it; therefore the torque is usually reported as a function of the hydraulic pressure. The drive motor only has to supply enough power to overcome the losses in the system. The test gears are lubricated with an independent oil system. The speed, torque, and input oil test temperatures can all be controlled.

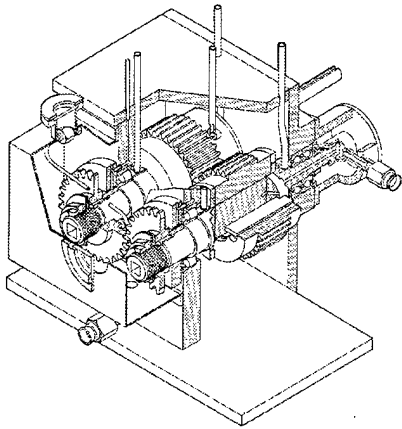

Figure 1. Spur Gear Test Apparatus

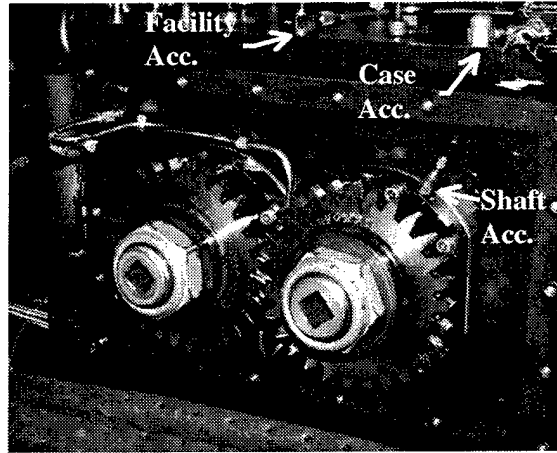

Figure 2. Accelerometer mounting locations

During health monitoring tests, an infrared optical sensor monitors the input shaft using a timing mark. Typically, there are two accelerometers used for HUMS research, one mounted on the outside of the test housing, with the other mounted in the test section directly on the bearing cover plate.

The once per revolution tachometer signal is generated using an infrared optical sensor that is located on the input shaft to the test gearbox. The sensor detects a change in the reflectivity of an infrared light. The connecting shaft has a piece of highly reflective silver colored tape cemented to the black oxide coated shaft. This provides a reliable signal that has good dynamic performance.

Two research accelerometers were mounted on the test gearbox. The first one, (and only one for the first test) was located on the housing of the gearbox. The location was chosen based upon previous modal analysis testing on an identical gearbox. [8] In this paper, this accelerometer is noted as the "Case" accelerometer. It is piezoelectric with a frequency response from 20 Hz to 50 kHz. The second accelerometer is also piezoelectric, but smaller and has a frequency range from 1 Hz to 10 kHz. This is mounted 30 degrees clockwise from the vertical centerline for the right (driven) shaft on the bearing retention cap inside the gearbox. The location is in the load zone of the bearing and provides the most direct transfer path for the vibration to travel. This accelerometer is referred to as the "Shaft" accelerometer. The configuration is shown in Figure 2.

The test rig uses a pair of spur gears having 28 teeth, a pitch diameter of 88.9 mm (3.50 inch), and a face width of 6.35 mm (0.25 inch). During a surface fatigue test, the gear faces are offset by 2.8 mm (0.11 inch) to allow a higher surface stress without a corresponding increase in the bending stress. For these tests however, the gears were in contact across the full face width. The tests were also run at a higher torque than normal. A photograph of a test gear is shown in Figure 3. The test gear geometry produced an arc of action of 0.342 radians (19.59 degrees).

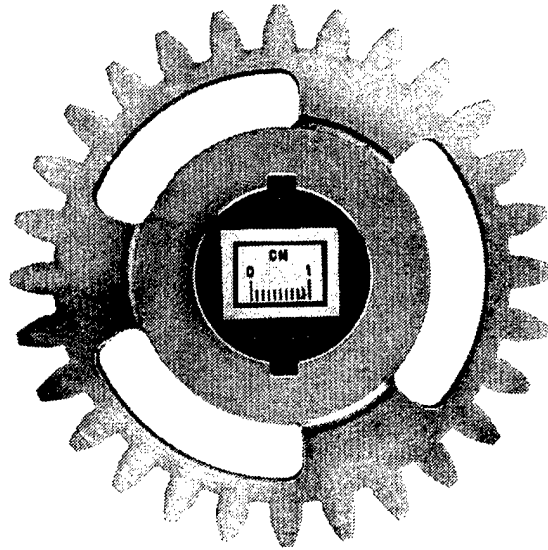

Figure 3. Representative gear for crack tests

A notch was machined in the root area of the gear to provide a concentrated flaw from which a crack could initiate. This location was chosen since this is the point of highest tensile stress on the gear tooth surface. The higher stress provides the best opportunity for crack propagation.

The notch traversed the entire face width of the gear and was created using electrical discharge machining (EDM); this process was chosen for its ability to control the size of the notch. The size of the notch is controlled by both the shape and electric current of the electrode and is typically 0.254 mm (0.010 inch) deep.

Results: These tests were run at an overloaded condition to accelerate testing. It will be shown that it is difficult to determine crack initiation on these gears. It would be beneficial to run the tests at overloaded conditions to initiate a crack, and then reduce the load to observe stable crack growth. This would allow a more accurate study of the vibration signature during the critical crack growth period.

During the first test, only the case mounted accelerometer was used. The “shaft” accelerometer was installed between the first and second tests, and was available for the remainder of the tests.

Test 1: This test, run at 125-155 Nm (92-114 ft-lb) torque and 2500 rpm produced a tooth fracture (Figure 4) after almost 237 hours. The original notch is readily visible in the fillet on the left side of the gear tooth. The crack initiated at the edge of the notch and progressed to the fillet on the right.

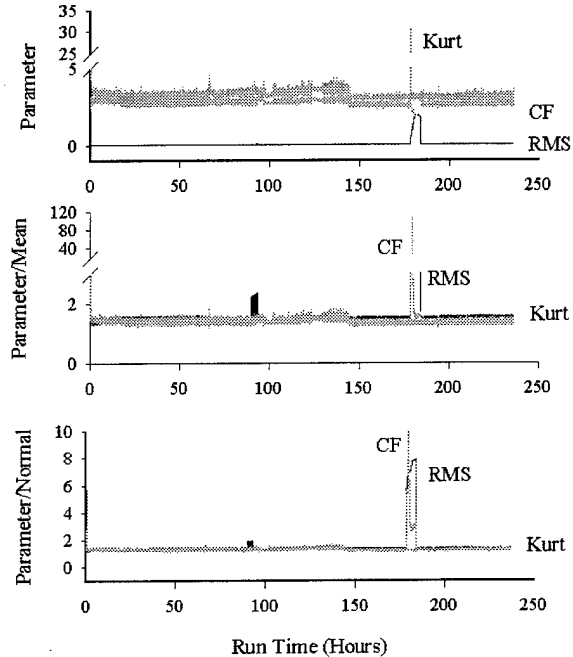
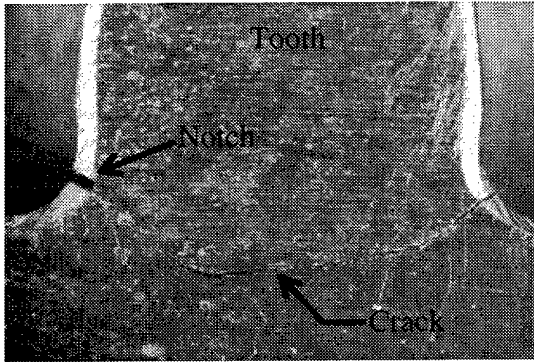

Figure 4. Gear tooth fracture after test 1 Figure 5. Test 1, case accelerometer analysis

Figure 5 shows the result of computing the RMS, Crest Factor, and kurtosis on the vibration signal of each tooth during its arc of action. The chart on the top of the figure (and all subsequent) is the maximum value for any of the 28 teeth. The middle plot shows the result of normalizing the maximum by the mean of the remaining teeth. This is intended to give a measure of how the one tooth is performing compared to the remaining teeth at exactly the same conditions. The lower plot is the result of normalizing the maximum by the sum of the mean and a statistical confidence value.

Figure 5 also shows the results of when the facility accelerometer lost power and shut the facility down (at approximately 70 hours), and an unexplained set of conditions at about 170 hours. Experience has shown that several of the diagnostic parameters take a significant amount of time to settle back into steady state like conditions after an interruption, if at all. It is important to note the amplitude of these disturbances for comparison later on. During a shutdown, the temperature decrease may change the system dynamics by altering the clearances and contact stresses from the previous conditions. In this figure there is no obvious indication of crack initiation, progression or separation of the gear tooth.

Test 2: Test 2 was conducted at 5000 rpm and 155 Nm (114 ft-lb) torque. This test ended at 1.7 hours with a fracture through the rim (Figure 6), which may have been caused by operation near a gear resonance condition. At 1.25 hours, high vibration levels caused an automatic test shutdown. The gear was examined and a mark taken to be dirt or fuzz was noticed. This may have actually been the crack that eventually propagated through the rim.



Figure 6. Gear rim fracture after test 2

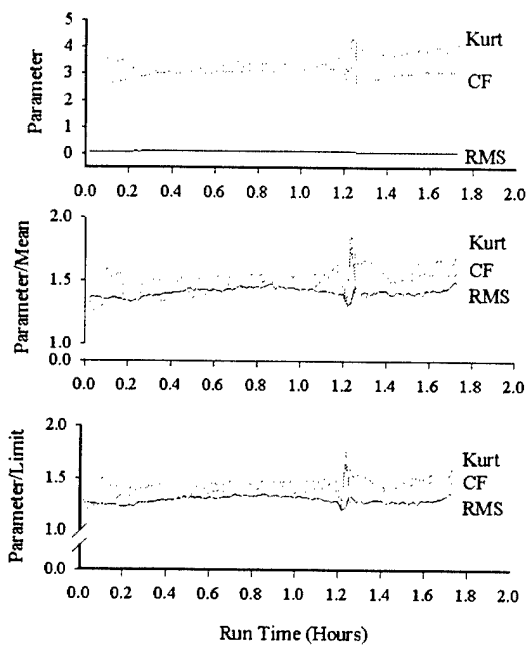

Figure 7. Test 2, case accelerometer analysis, 5000 rpm

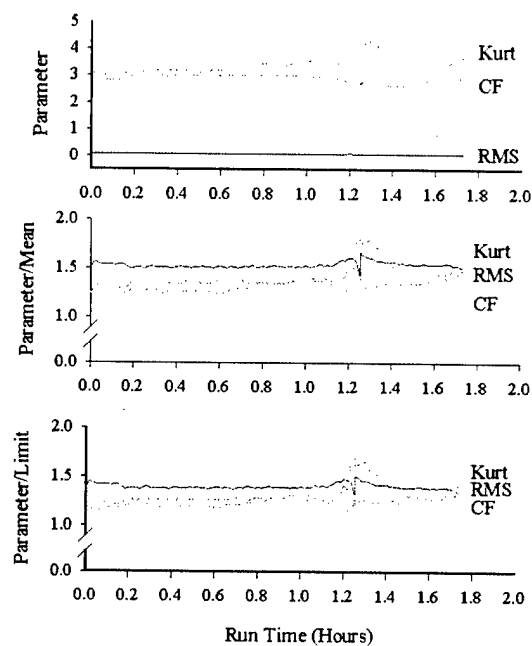

Figure 8. Test 2, shaft accelerometer analysis, 5000 rpm

Figures 7 and 8 present the results of applying the parameters to the vibration recorded by the two accelerometers. In this test, almost all of the techniques examined indicate something at 1.25 hours. The variations due to the shutdown and subsequent startup are readily visible.

The ideal parameter would show a step change at initiation of damage, a linear increase during damage progression with another step increase to a high level to indicate the loss of the tooth for the remainder of the run. In the top chart of Figure 8, the kurtosis comes the closest to being an ideal parameter. It shows an increase before the shutdown and increases as the damage progresses while not reducing to a value less than the undamaged condition. The kurtosis normalized to the mean shows several of the characteristics of an undesirable parameter.

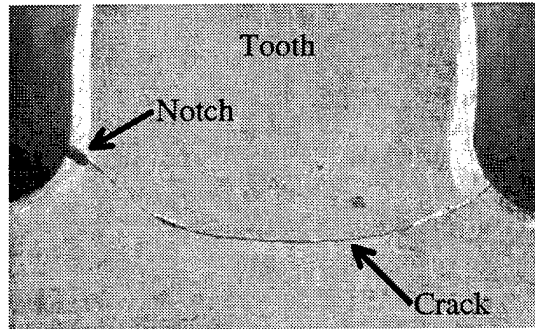

Figure 9. Gear tooth fracture after test 3

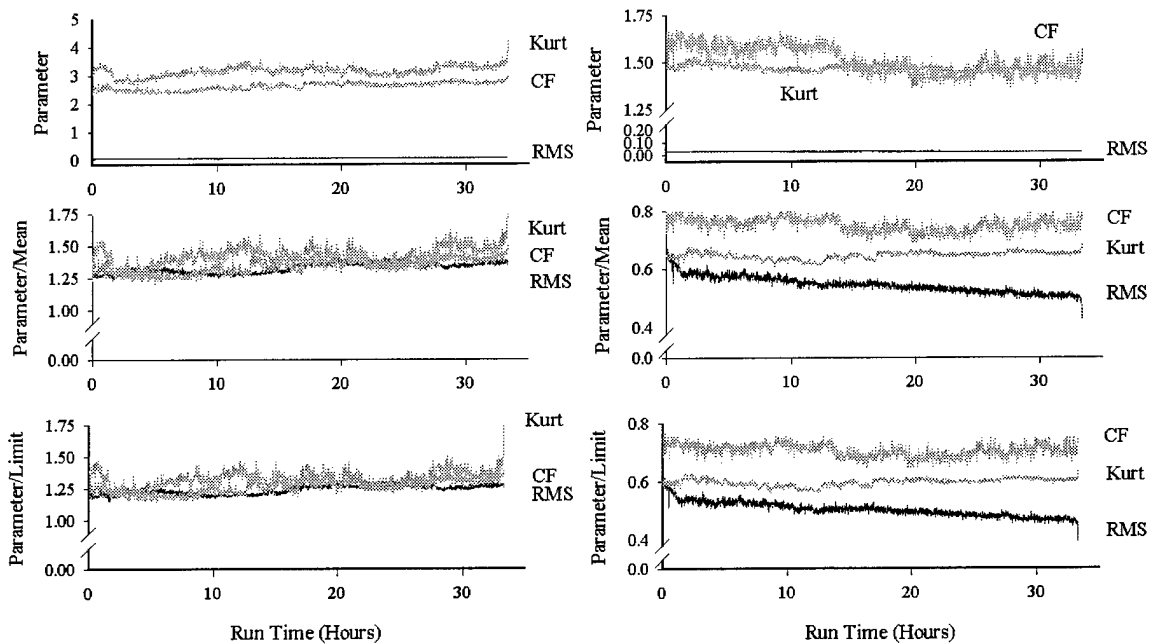

Figure 10. Test 3, case accelerometer filtered analysis, 4925 rpm

Figure 11. Test 3, shaft accelerometer filtered analysis, 4925 rpm

Test 3: This test also produced a fractured tooth (Figure 9). This fracture was not complete and progressed about two-thirds of the width of the tooth. The facility monitoring accelerometer detected a high vibration level due to the crack and shut down the system before the loss of the tooth. The shutdown occurred after almost 420 hours of 4925 rpm at torques of 125, 139, and 155 Nm (92, 106, and 114 ft-lb) of torque. The gear was later run at various torques until complete fracture occurred.

Applying the tooth analysis approach yields Figures 10 and 11. Although not definitive, it appears that the damage is being detected. When isolating the individual tooth, the kurtosis appears to indicate the damage, especially when normalized to the mean of the remainder of the teeth.

Conclusions: The tests conducted in this study reflect other previous experiments that show that no individual technique routinely outperforms the others for gear crack detection. Several methods for feature extraction and detection appear to be required. At times, some failures are not detected. This leads to several important conclusions that can be obtained from this testing:

1. For the commonly used vibration diagnostic parameters examined here, there is no single parameter that will reliably and accurately detect gear fractures until there is significant, possibly secondary damage (complete loss of tooth).
2. The techniques presented in this paper, while improving on existing techniques, still do not have sufficient robustness and accuracy. They may, however, provide the feature extraction necessary for future detection algorithms.
3. Using current techniques, it is almost impossible to be able to reliably detect a tooth fracture in sufficient time to be able to monitor its growth.

References:

1. Dempsey, P.J. "A Comparison of Vibration and Oil Debris Gear Damage Detection Methods Applied to Pitting Damage," Proceedings of COMADEM 2000, 13th International Congress on Condition Monitoring and Diagnostic Engineering Management. Houston, TX, also NASA/TM—2000-210371, September 2000.
2. Stewart, R.M., "Some Useful Data Analysis Techniques for Gearbox Diagnostics," Report MHM/R/10/77, Machine Health Monitoring Group, Institute of Sound and Vibration Research, University of Southampton, July 1977.
3. Decker, H.J., and Zakrajsek, J.J., 1999, "Comparison of Interpolation Methods as Applied to Time Synchronous Averaging," Proceedings of 53rd Meeting of the Society for Mechanical Failure Prevention Technology, Virginia Beach, VA, April 1999. NASA/TM—1999-209086, ARL—TR—1960, NASA Lewis Research Center.
4. Drago, R.J., Fundamentals of Gear Design, Butterworth-Heinemann, Stoneham, MA, 1988.
5. American Gear Manufacturers Association, "Geometry Factors for Determining the Pitting Resistance and Bending Strength of Spur, Helical and Herringbone Gear Teeth," AGMA 908-B89, American Gear Manufacturers Association, Alexandria, VA, April 1989.
6. Swansson, N.S., "Application of Vibration Signal Analysis Techniques to Signal Monitoring," Conference on Friction and Wear in Engineering 1980. Institution of Engineers, Australia, Barton, Australia, 1980.
7. Miller, Irwin, Freund, John E., Probability and Statistics for Engineers 3rd Edition, Prentice-Hall, Inc., Englewood Cliffs, New Jersey, 1985.
8. Zakrajsek, J.J., Townsend, D.P., Oswald, F.B., and Decker, H.J., "Analysis and Modification of a Single-Mesh Gear Fatigue Rig for Use in Diagnostic Studies," NASA TM-105416, AVSCOM TR 91-C-049, May 1992.

REPORT DOCUMENTATION PAGE

Form Approved
OMB No. 0704-0188

Public reporting burden for this collection of information is estimated to average 1 hour per response, including the time for reviewing instructions, searching existing data sources, gathering and maintaining the data needed, and completing and reviewing the collection of information. Send comments regarding this burden estimate or any other aspect of this collection of information, including suggestions for reducing this burden, to Washington Headquarters Services, Directorate for Information Operations and Reports, 1215 Jefferson Davis Highway, Suite 1204, Arlington, VA 22202-4302, and to the Office of Management and Budget, Paperwork Reduction Project (0704-0188), Washington, DC 20503.

1. AGENCY USE ONLY (Leave blank)		2. REPORT DATE April 2002	3. REPORT TYPE AND DATES COVERED Technical Memorandum	
4. TITLE AND SUBTITLE Gear Crack Detection Using Tooth Analysis			5. FUNDING NUMBERS WU-708-90-13-00 1L161102AH45	
6. AUTHOR(S) Harry J. Decker			8. PERFORMING ORGANIZATION REPORT NUMBER E-13259	
7. PERFORMING ORGANIZATION NAME(S) AND ADDRESS(ES) National Aeronautics and Space Administration John H. Glenn Research Center at Lewis Field Cleveland, Ohio 44135-3191			10. SPONSORING/MONITORING AGENCY REPORT NUMBER NASA TM-2002-211491 ARL-TR-2681	
9. SPONSORING/MONITORING AGENCY NAME(S) AND ADDRESS(ES) National Aeronautics and Space Administration Washington, DC 20546-0001 and U.S. Army Research Laboratory Adelphi, Maryland 20783-1145			11. SUPPLEMENTARY NOTES Prepared for the 56th Meeting sponsored by the Society for Machinery Failure Prevention Technology, Virginia Beach, Virginia, April 15-19, 2002. Responsible person, Harry J. Decker, organization code 5950, 216-433-3964.	
12a. DISTRIBUTION/AVAILABILITY STATEMENT Unclassified - Unlimited Subject Categories: 07 and 37 Available electronically at http://gltrs.grc.nasa.gov/GLTRS This publication is available from the NASA Center for AeroSpace Information. 301-621-0390.			12b. DISTRIBUTION CODE Distribution: Nonstandard	
13. ABSTRACT (Maximum 200 words) Gear cracks are typically difficult to diagnose with sufficient warning time. Significant damage must be present before algorithms detect the damage. A new feature extraction and two new detection techniques are proposed. The time synchronous averaging concept was extended from revolution-based to tooth engagement-based. The detection techniques are based on statistical comparisons among the averages for the individual teeth. These techniques were applied to a series of three seeded fault crack propagation tests. These tests were conducted on aerospace quality spur gears in a test rig. The tests were conducted at speeds ranging from 2500 to 7500 revolutions per minute and torques from 184 to 228 percent of design load. The inability to detect these cracks with high confidence may be caused by the high loading required to initiate the cracks. The results indicate that these techniques do not currently produce an indication of damage that significantly exceeds experimental scatter.				
14. SUBJECT TERMS Diagnostics; Fracture; Gear; Health monitoring; Synchronous average			15. NUMBER OF PAGES 16	
			16. PRICE CODE	
17. SECURITY CLASSIFICATION OF REPORT Unclassified	18. SECURITY CLASSIFICATION OF THIS PAGE Unclassified	19. SECURITY CLASSIFICATION OF ABSTRACT Unclassified	20. LIMITATION OF ABSTRACT	