

NAVAL POSTGRADUATE SCHOOL

Monterey, California



THESIS

**FREE SPACE OPTICS AND WIRELESS BROADBAND
RADIO FREQUENCY TECHNOLOGY: BRINGING HIGH-
SPEED NETWORK ACCESS TO THE LAST MILE**

by

John W. Sprague

March 2002

Thesis Advisor:
Second Reader:

Bert Lundy
James Bret Michael

Approved for public release; distribution is unlimited

THIS PAGE INTENTIONALLY LEFT BLANK

REPORT DOCUMENTATION PAGE			Form Approved OMB No. 0704-0188	
Public reporting burden for this collection of information is estimated to average 1 hour per response, including the time for reviewing instruction, searching existing data sources, gathering and maintaining the data needed, and completing and reviewing the collection of information. Send comments regarding this burden estimate or any other aspect of this collection of information, including suggestions for reducing this burden, to Washington headquarters Services, Directorate for Information Operations and Reports, 1215 Jefferson Davis Highway, Suite 1204, Arlington, VA 22202-4302, and to the Office of Management and Budget, Paperwork Reduction Project (0704-0188) Washington DC 20503.				
1. AGENCY USE ONLY (Leave blank)		2. REPORT DATE March 2002	3. REPORT TYPE AND DATES COVERED Master's Thesis	
4. TITLE AND SUBTITLE: Free Space Optics and Wireless Broadband Radio Frequency Technology: Bringing High-speed Network Access to the Last Mile			5. FUNDING NUMBERS	
6. AUTHOR(S) John Watson Sprague				
7. PERFORMING ORGANIZATION NAME(S) AND ADDRESS(ES) Naval Postgraduate School Monterey, CA 93943-5000			8. PERFORMING ORGANIZATION REPORT NUMBER	
9. SPONSORING /MONITORING AGENCY NAME(S) AND ADDRESS(ES) N/A			10. SPONSORING/MONITORING AGENCY REPORT NUMBER	
11. SUPPLEMENTARY NOTES The views expressed in this thesis are those of the author and do not reflect the official policy or position of the Department of Defense or the U.S. Government.				
12a. DISTRIBUTION / AVAILABILITY STATEMENT Approved for Public Release; Distribution is Unlimited			12b. DISTRIBUTION CODE	
13. ABSTRACT (maximum 200 words) Existing copper phone and cable infrastructure no longer provide the required broadband for today's emerging applications. Homes and businesses in the "last mile" require the same access to broadband speeds available inside the fiber optic ring. It is not economically feasible, however, to bring fiber optic cable to each and every home and business in the "last mile." Free Space Optics and Wireless Broadband Radio Frequency are two technologies gaining popularity as an alternative broadband infrastructure. Free Space Optics uses lasers and Wireless Broadband uses Radio Frequency waves to send large amounts of data from one place to another. Both are wireless technologies that use free space. As a result, they are quickly deployed, easily scaled, and cheaper to install and upgrade than wired infrastructures. These characteristics support missions of the Armed Forces in which wire-bound infrastructure is not dependable, is impractical to build and maintain, or requires a high degree of mobility. This thesis addresses the "last mile" problem including why current infrastructure will not provide a broadband solution. Free Space Optics and Wireless Broadband Radio Frequency technologies are explored and discussed. Finally, an economic analysis of alternative network designs utilizing the two emerging technologies is applied to a fictitious city with a population of one million.				
14. SUBJECT TERMS Free Space Optics, Wireless Networking, Wireless Broadband, Radio Frequency, Network Infrastructure			15. NUMBER OF PAGES 83	
			16. PRICE CODE	
17. SECURITY CLASSIFICATION OF REPORT Unclassified	18. SECURITY CLASSIFICATION OF THIS PAGE Unclassified	19. SECURITY CLASSIFICATION OF ABSTRACT Unclassified	20. LIMITATION OF ABSTRACT UL	

THIS PAGE INTENTIONALLY LEFT BLANK

Approved for public release; distribution is unlimited

**FREE SPACE OPTICS AND WIRELESS BROADBAND RADIO FREQUENCY
TECHNOLOGY: BRINGING HIGH-SPEED NETWORK ACCESS TO THE
LAST MILE**

John W. Sprague
Lieutenant Commander, United States Navy
M.S., Naval Postgraduate School, 1996
B.S., The Pennsylvania State University, 1990

Submitted in partial fulfillment of the
requirements for the degree of

**MASTER OF SCIENCE IN
COMPUTER SCIENCE**

from the

**NAVAL POSTGRADUATE SCHOOL
March 2002**

Author: John W. Sprague

Approved by: Bert Lundy, Thesis Advisor

James Bret Michael, Second Reader

Chris Eagle, Chairman
Department of Computer Science

THIS PAGE INTENTIONALLY LEFT BLANK

ABSTRACT

Existing copper phone and cable infrastructure no longer provide the required broadband for today's emerging applications. Homes and businesses in the "last mile" require the same access to broadband speeds available inside the fiber optic ring. It is not economically feasible, however, to bring fiber optic cable to each and every home and business in the "last mile."

Free Space Optics and Wireless Broadband Radio Frequency are two technologies gaining popularity as an alternative broadband infrastructure. Free Space Optics uses lasers and Wireless Broadband uses Radio Frequency waves to send large amounts of data from one place to another. Both are wireless technologies that use free space. As a result, they are quickly deployed, easily scaled, and cheaper to install and upgrade than wired infrastructures. These characteristics support missions of the Armed Forces in which wire-bound infrastructure is not dependable, is impractical to build and maintain, or requires a high degree of mobility.

This thesis addresses the "last mile" problem including why current infrastructure will not provide a broadband solution. Free Space Optics and Wireless Broadband Radio Frequency technologies are explored and discussed. Finally, an economic analysis of alternative network designs utilizing the two emerging technologies is applied to a fictitious city with a population of one million.

THIS PAGE INTENTIONALLY LEFT BLANK

TABLE OF CONTENTS

I.	INTRODUCTION.....	1
A.	MOTIVATION FOR THESIS.....	1
B.	THESIS OBJECTIVES	4
C.	ORGANIZATION OF REPORT	4
II.	THE LAST MILE PROBLEM	7
A.	LAST MILE HOMES WANT BROADBAND SPEED	7
B.	CURRENT INFRASTRUCTURE ALTERNATIVES	8
1.	Twisted Pair Phone Line	8
2.	Asymmetric Digital Subscriber Line	8
3.	Coaxial Cable.....	10
C.	OTHER NETWORK ACCESS ALTERNATIVES	11
1.	Fiber Optic Cable.....	11
2.	Satellite Access.....	12
D.	HOW MUCH BANDWIDTH IS ENOUGH?.....	12
E.	LAST MILE PROBLEM DEFINED	13
F.	SUMMARY.....	13
III.	FREE SPACE OPTICS TECHNOLOGY.....	15
A.	WHAT IS FSO	15
B.	FSO APPLICATIONS.....	17
1.	AirFiber Inc.	17
2.	TeraBeam Corporation	20
3.	LightPointe Communications, Inc.....	21
C.	FSO BENEFITS	22
D.	FSO LIMITATIONS	22
E.	SUMMARY.....	23
IV.	WIRELESS BROADBAND RADIO FREQUENCY TECHNOLOGY.....	25
A.	WHAT IS WIRELESS BROADBAND RADIO FREQUENCY.....	25
B.	WIRELESS BROADBAND RADIO FREQUENCY APPLICATIONS..	26
1.	Alvarion.....	26
2.	Alcatel.....	29
3.	Universal Internet	31
C.	WIRELESS BROADBAND RF BENEFITS	32
D.	WIRELESS BROADBAND RF LIMITATIONS	32
E.	SUMMARY.....	33
V.	NETWORK DESIGN AND ANALYSIS USING FSO AND WIRELESS BROADBAND.....	35
A.	NETWORK DESIGN ALTERNATIVES	35
B.	HIGH-SPEED SERVICES	35
1.	Services Provided	35
2.	General Assumptions Made	36
C.	NETWORK DESIGN ALTERNATIVES	38

1.	All Fiber Optic Cable.....	38
2.	All Free Space Optics.....	40
3.	Hybrid Alternative of FSO and Wireless Broadband RF.....	42
D.	COST ANALYSIS OF NETWORK DESIGN ALTERNATIVES.....	43
1.	All Fiber Optic Cable.....	44
2.	All Free Space Optics.....	45
3.	Hybrid of FSO and Wireless Broadband RF.....	47
4.	Income versus Cost.....	49
E.	SUMMARY.....	49
VI.	CONCLUSION.....	51
A.	SUMMARY.....	51
B.	FUTURE RESEARCH.....	54
	APPENDIX A AIRFIBER'S FREE SPACE OPTIC SPECIFICATIONS.....	55
	APPENDIX B ELECTROMAGNETIC SPECTRUM CHARACTERISTICS.....	57
	APPENDIX C NETWORK DESIGN USING FSO AND RF.....	59
	APPENDIX D FSO AND RF COMMERCIAL ALTERNATIVES.....	61
	APPENDIX E NETWORK DESIGN COST ANALYSIS.....	63
	LIST OF REFERENCES.....	65
	INITIAL DISTRIBUTION LIST.....	67

LIST OF FIGURES

Figure 1.	Graphical Representation of the Last Mile	3
Figure 2.	Digital Subscriber Line (DSL) Spectrum [From: DSLR02]	9
Figure 3.	DSL in the Home [From: DSLR03]	10
Figure 4.	Cable Modem Tree Structure [After: CABL01]	11
Figure 5.	LightPointe Communications Inc. Node [From: WILL01]	16
Figure 6.	AirFiber OptiMesh Rooftop Node [From: AIRF04]	18
Figure 7.	AirFiber Mesh Topology [From: AIRF04]	19
Figure 8.	TeraBeam Corporation Topology [From: TERA01]	20
Figure 9.	LightPointe Communications Point to Point Topology [From: LIGH01]	21
Figure 10.	LightPointe Communications Ring Topology [From: LIGH01]	21
Figure 11.	Radio Frequency Electromagnetic Spectrum [From: ELEC01]	26
Figure 12.	Alvarion Base Station and CPE Architecture [From: ALVA01]	27
Figure 13.	Alcatel Base Station and Customer Premise Equipment [From: ALCA01]	31
Figure 14.	Generic City of Wireless	37
Figure 15.	Standard Fiber Optic Cable Neighborhood	39
Figure 16.	All FSO Ring and Spokes	41
Figure 17.	All FSO Neighborhood Node	41
Figure 18.	Wireless Broadband RF Neighborhood Node	42
Figure 19.	Wireless Broadband RF Customer Premise Equipment	43
Figure 20.	Alternatives Available for a Typical Metro Center [From: AIRF04]	52
Figure 21.	Solutions Based on Transmission Rate and Topology [From: AIRF04]	53

THIS PAGE INTENTIONALLY LEFT BLANK

LIST OF TABLES

Table 1.	FSO Atmospheric Attenuation [From: AIRF01]	23
Table 2.	City of Wireless General Assumptions	38
Table 3.	Total Amount of Fiber Optic Cable Required	40
Table 4.	All Fiber Optic Cable Cost Metrics	45
Table 5.	All Free Space Optics Cost Metrics	47
Table 6.	Hybrid Option Cost Metrics.....	48

THIS PAGE INTENTIONALLY LEFT BLANK

LIST OF ABBREVIATIONS, ACRONYMS, SYMBOLS

ADSL	Asynchronous Digital Subscriber Line
ATM	Asynchronous Transfer Mode
BWA	Broadband Wireless Access
CD	Compact Disc
CMTS	Cable Modem Termination System
CO	Central Office
CPE	Customer Premise Equipment
db	Decibel
DSL	Digital Subscriber Line
EMS	Element Management System
FCC	Federal Communications Commission
FSO	Free Space Optics
Gbps	Giga bits per second
GHz	Gigahertz
Hz	Hertz
IP	Internet Protocol
ISM Band	Industrial, Scientific and Medical Frequency Band
ISP	Internet Service Provider
Kbps	Kilo bits per second
kHz	Kilohertz
km	Kilometer
LAN	Local Area Network

LOS	Line of Sight
m ²	Meters squared
Mbps	Mega bits per second
NM	Nanometer
NOC	Network Operations Center
NPS	Naval Postgraduate School
NPS	Naval Postgraduate School
OC	Optical Carrier
PMP`	Point to Multi-Point
POTS	Plain Old Telephone System
QoS	Quality of Service
RBOC	Regional Bell Operating Center
RF	Radio Frequency
SME	Small and Medium Enterprises
SNMP	Simple Network Management Protocol
SONET/SDH	Synchronous Optical Network / Spatial Data Handling
STM	Synchronous Transport Modules
TV	Television
U.S.	United States
VoIP	Voice over Internet Protocol
VPN	Virtual Private Network
WiPOP	Wireless Point of Presence

I. INTRODUCTION

A. MOTIVATION FOR THESIS

The increasing speed of technology and innovation and the widely used “Internet” are revolutionizing the way business is conducted around the globe. In the beginning, the commercial Internet was used mostly as a text message exchange or small file transfer, but later ECommerce emerged and more recently voice over IP (VoIP) and streaming video. The Internet is now truly an information superhighway. Bandwidth-intensive graphics, video and audio applications are becoming more and more popular, especially among the younger generations. Television, movies, videos, music and other applications are in high demand. The desire for fast access to information you want right now at your fingertips has never been so resounding. However, the Internet is more than an entertainment delivery system. The military is embracing the Internet in support of its network-centric warfare and using web based applications for things ranging from operational issues to distance learning.

Computer chip processing speed was the limiting factor on how applications were developed and where the market went with respect to innovation. However, with evolving computer chip technology, computer-processing speed has grown at an enormous rate and is becoming less and less the problem [INTE01]. The slow speed of the physical media (twisted pair, coaxial cable) is becoming the focus now as the least common denominator when developing applications. Some large companies and corporations worldwide, particularly in major cities, have relatively fast access speeds usually with fiber optic cable for their employees. However, these speeds are usually at least ten times faster than what is currently available at the home. This large difference in network access speed is making some web page applications offer text only versions to download at home so you can view it relatively quickly with the slower access speeds. Conversely, at work with the faster access speeds, you can view the web page applications with their large files including graphics, audio and video. So the problem facing the market today is getting high-speed network access to the last mile in order to

utilize these high-bandwidth-intensive applications (e.g., graphics, streaming video) that users have become accustomed to at the workplace.

The last mile is defined as the portion of the network from the central office where there is typically a high-transmission line to homes and businesses where the network access speeds tend to be very small. See Figure 1 for a graphical representation of the last mile. Consequently, it has not been economically viable to lay new access cables to each and every home and business. As will be discussed later in chapter 5, the cost to lay or hang the cables would be more than most Internet Service Providers (ISPs) and consumers are willing to pay. However, a wireless approach is the most recent technology in providing broadband services in both the commercial and residential sectors (e.g. see [WILL01]). This is primarily due to their low cost, quick installation and inherent flexibility when compared with current wired access systems. Two emerging technologies that will be discussed throughout this thesis are Free Space Optics (FSO) and Wireless Broadband Radio Frequency systems. *Free Space Optics* is an optical technology that uses invisible beams of light over the air (instead of fiber optic cable) to deliver reliable high-bandwidth connections more cost effectively and quickly than traditional physical fiber systems. [LIGH02]. *Wireless Broadband Radio Frequency* is a point-to-multi-point communication system using both the licensed and unlicensed Radio Frequency (RF) spectrum to provide high data rates. There are attempts underway to standardize such technology for home networking, such as the Wireless 1394 specification (e.g., see [ZHAN01]).

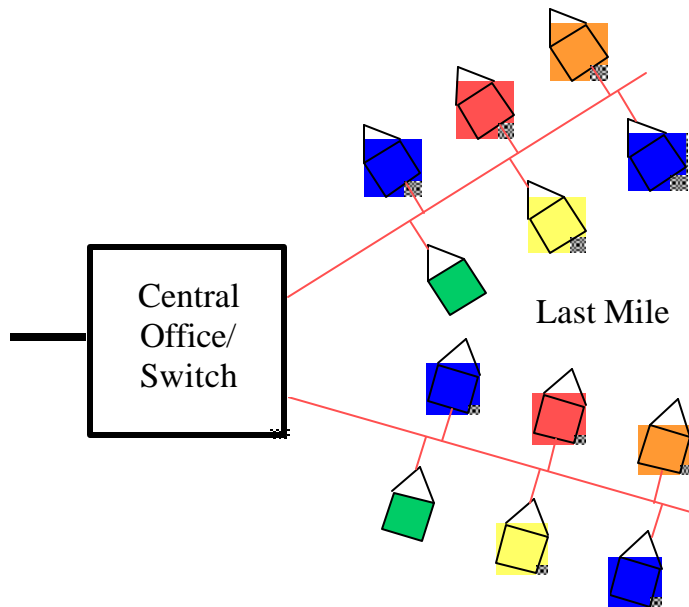

Figure 1. Graphical Representation of the Last Mile

The motivation behind this thesis is to develop a network design and analysis utilizing these two broadband systems to aid in a solution to help solve the last mile problem. This may not be the full solution, but arguably these alternatives will play a significant role in the near future. This thesis will focus towards applying this technology to a fictitious city of one million people in the United States, but will have relevance to any city and in many areas of the world. Commercially, FSO laser technology was utilized immediately following the September 11th bombing in New York City when many of the fiber optic lines and current infrastructure was destroyed (e.g., see [BERM01]). It was rapidly deployed and provided large amounts of bandwidth, which was used by federal agencies, commercial industries, and private ventures.

In Monterey, for example, FSO links could improve the data communications service between the Naval Postgraduate School (NPS) and military housing at the former Ford Ord to provide high-speed network access in that area. Operationally, many military missions today depend on similar response and require fast paced deployment to areas without an existing infrastructure or where the wired-based infrastructure is unstable. The commercial sector and the military must work close together to provide solutions that engage the enemy and win wars. Many military technologies today need a broadband infrastructure that can be deployed rapidly, can scale rapidly and is cheap enough to be

expendable when the mission is complete. With the advent of such a new broadband infrastructure, numerous commercial and military applications will certainly follow.

B. THESIS OBJECTIVES

The objective of this thesis is to provide an in-depth study of two emerging wireless broadband technologies that have been proposed as a solution to the last mile problem: Free Space Optics and Wireless Broadband radio frequency. More specifically, research goals can be summarized as follows:

- List and discuss the problems associated with “wired” connections to homes and businesses in the last mile.
- Provide an objective assessment of Free Space Optics wireless broadband systems.
- Provide an objective assessment of Wireless Broadband radio frequency systems.
- Conduct a network design and analysis using Free Space Optics and Wireless Broadband radio frequency technologies to provide a high broadband solution aimed at solving the last mile problem.

C. ORGANIZATION OF REPORT

This thesis is organized as follows: chapter II discusses the current U.S. telecommunications alternatives available utilizing existing infrastructure and the problems associated with those alternatives. It continues by addressing problems associated with providing a broadband system of laying new wire to every last mile node. Chapter III describes Free Space Optic technology, discussing current alternatives available today and in the near future with respect to emerging wireless technologies. Chapter IV describes Wireless Broadband radio frequency technology, also discussing current alternatives available today and in the near future. Chapter V presents a Network Design and Analysis applying both Free Space Optics and Wireless Broadband radio

frequency technology to help solve the last mile problem. The basis of the design and analysis is a hypothetical city of one million people. Chapter VI provides concluding remarks and suggestions for future research.

THIS PAGE INTENTIONALLY LEFT BLANK

II. THE LAST MILE PROBLEM

A. LAST MILE HOMES WANT BROADBAND SPEED

This thesis began with the quest to understand why there are high broadband access speeds at work within most major U.S. cities but not in last mile homes or businesses. In fact, speeds are not even remotely close. Most areas of the world, which have an Internet connection at home, navigate at speeds up to 56Kbps through the use of a high-speed modem. Some areas of the world, particularly North America, are beginning to provide higher access speeds through existing infrastructure including Digital Subscriber Line (DSL) and cable modems. The number of North American residential broadband Internet subscribers more than doubled in 2001. Cable modems in 2001 reached 8.7 million people in North America; this is 10.7 percent of all cable subscribers, up from 7.4 percent at the end of 2000. DSL reached 4.3 million people in North America at the end of 2001. Therefore, at the end of 2001, U.S. broadband penetration reached 10 percent, compared to over 22 percent in Canada, yielding a blended 11.5 percent North American penetration rate. On average, broadband service providers installed more than 17,000 subscribers per day in 2001 [KINE01].

The network design and analysis, designed in chapter 5, will not focus on cable or DSL infrastructures because both utilize existing copper wire. This copper infrastructure is at its maximum capacity and not a viable long-term solution to high broadband speeds required of many new applications available even today. DSL and cable speeds may reach a maximum of two Mbps depending on distance from the central office or the number of neighborhood homes online, but even two Mbps is not feasible for running telephone, streaming video, and other high-bandwidth-intensive-applications concurrently. In this thesis we explore the possibility of achieving upwards of thirty Mbps to the home. However, it is important to discuss these existing DSL and cable modem alternatives in order to understand the existing baseline infrastructure and to help define the last mile problem.

B. CURRENT INFRASTRUCTURE ALTERNATIVES

Currently, twisted pair telephone line and coaxial cable (cable TV) are the two most common wired infrastructures available to send and receive near real-time information rapidly to the last mile. Digital Subscriber Line (DSL) is a technology trying to utilize existing copper phone line infrastructure to increase digital bandwidth to the home, but its speed is limited. Fiber Optic cable provides the required bandwidth, but is both too expensive and time consuming for most users to afford. Satellites are a one-way communications broadcast link to receive large amounts of information (although recently users can obtain a satellite uplink at slow speeds). However as discussed later, satellites are not an acceptable two-way link for high-speed data access.

1. Twisted Pair Phone Line

The twisted pair phone line infrastructure was designed more than one hundred years ago for analog voice signals at a frequency of 4kHz. Originally, phone line modems were the only affordable way to access the Internet at home and at very slow speeds. As the demand for higher speeds increased, new modems were invented up to the 56Kbps modem widely used today. This is the theoretical maximum bandwidth modems can reach utilizing the 4kHz frequency. Telephone lines are composed of two single core copper wires that are twisted around each other. There is no shielding, and the copper may date back to the 1950s, hence the difficulty designing standards and equipment that will work reliably on such a variable quality pathway. As a result, a good 56Kbps modem on a clean line will manage at most 48Kbps [DSLRO1]. Most online customers using a 56Kbps modem and their existing phone line as a dial up are frustrated just surfing the Internet, let alone using any high-bandwidth applications.

2. Asymmetric Digital Subscriber Line

Home users tend to be more of a consumer of data than a producer. As a result, Digital Subscriber Line (DSL) trades a slower upload speed for a faster download speed. In addition, the DSL standard allows for regular phone service to be squeezed into the low end of the frequency spectrum (0-4kHz). Figure 2 illustrates the DSL spectrum

[DSLRO1]. Another advantage of DSL over a standard 56Kbps phone line modem is the ability to always be connected. There are some major disadvantages with respect to DSL. Home users must live within three miles from a DSL equipped central office of the phone company and even then it does not mean you can get access to DSL. If the phone company finds a problem, the DSL could be cancelled. Installation time can vary and the Phone Company is under no obligation to provide DSL capable lines, or DSL, to everyone.

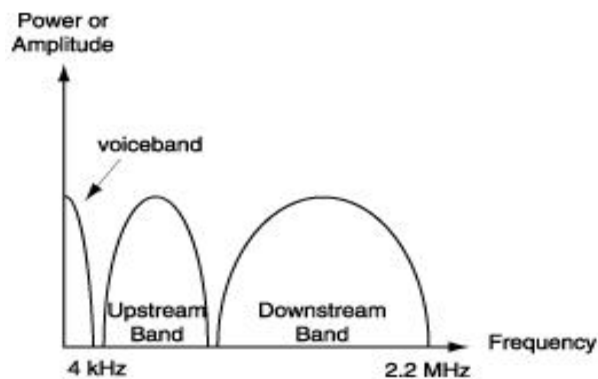

Figure 2. Digital Subscriber Line (DSL) Spectrum [From: DSLR02]

Digital Subscriber Line (DSL) has expanded in some areas of North America using existing phone lines to reach speeds upwards of about two Mbps. There are some changes that need to occur in the home (see Figure 3) [DSLRO3] including a DSL modem, new RJ11 sockets and a splitter. There is a maximum theoretical limit, however, on what can be sent over the current two-wire telephone lines. High-bandwidth-intensive applications, such as streaming video, can never truly be utilized for real time over this transmission medium.

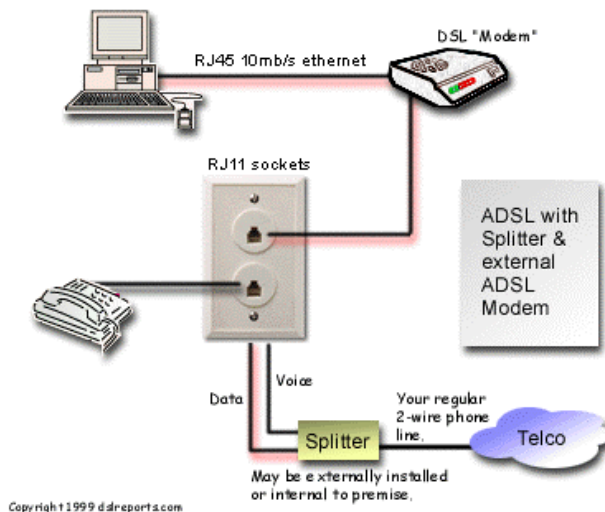

Figure 3. DSL in the Home [From: DSLR03]

3. Coaxial Cable

The other transmission medium infrastructure currently available to most North American homes and businesses in the last mile is coaxial cable. Coaxial cable is used to receive cable TV and is another method to consider accessing high-bandwidth applications. In some areas of North America, cable modems are fast becoming the best choice for the price available at the time of this writing for high-speed Internet access. A cable modem is a box that uses existing coaxial cable for TV signals to transmit data. It has theoretical connection speeds ranging from 3-50 Mbps over a distance of 100 km [CABL01]. In reality, speeds average two Mbps maximum to most cable subscribers. Similar to DSL, cable modems have a faster download speed and a slower upload speed. Another advantage of DSL is the ability of the user to always be “online.”

Cable modem access also has some disadvantages. First, cable modems are arranged in a tree structure shown in Figure 4 [CABL01]. Since cable TV was designed as a broadcast system, the cable is shared amongst many people in a small area, and only recently have cable companies offered data upload capability. The Cable Modem Termination System (CMTS) can talk to all the cable modems, but cable modems can only talk to the CMTS. For example, if two cable modems need to talk to each other, the CMTS will have to relay the messages. The main disadvantage, however, is the shared access with the entire neighborhood. For instance; at peak times when many people in a neighborhood are “online,” the effective transmission speeds in that neighborhood can diminish substantially and therefore not support high-bandwidth-intensive applications.

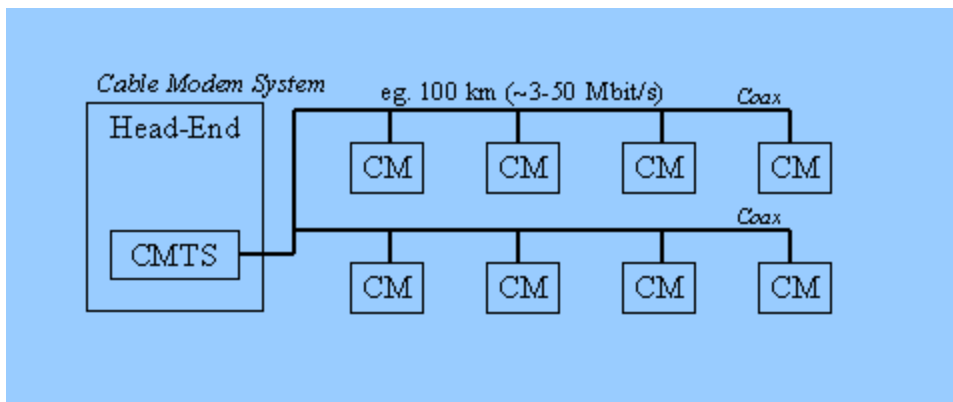

Figure 4. Cable Modem Tree Structure [After: CABL01]

C. OTHER NETWORK ACCESS ALTERNATIVES

Based on the foregoing discussion of twisted pair phone line and coaxial cable transmission mediums, one can conclude that these are not practical ways to send and receive high-bandwidth applications to homes and businesses in the last mile. The two current transmission mediums were not designed to send and receive large amounts of digital data and simply cannot physically support the high-bandwidth required of current and envisioned applications. There are high-bandwidth alternatives at some workplaces in large office buildings though, where fiber optic lines achieve speeds from 1.54 Mbps to well over 12 Gbps. The goal of this thesis is to make these network access alternatives that businesses are using available to last mile homes and businesses.

1. Fiber Optic Cable

Fiber optics is a relatively recent transmission medium using light to allow digital data to be sent and received at high broadband speeds. Many large corporations worldwide are now connected via a fiber optic line at speeds upwards of twelve Gbps (OC256). So the obvious question is why not have fiber optic cable to every home and business in the last mile? The main answers are cost and the telephone monopolies. Cost includes not only the minimal cost of the cable but also the significant cost of physically getting the fiber optic cable to each and every home and business. Ditches would have to be dug and streets would have to be torn up while fiber optic wire is laid or hung to every home and business not already connected. If hung, fiber optic wire is not as rugged as twisted pair or coaxial cable and care would have to be exercised in hanging it vice laying it underground. Moreover, whenever the current bandwidth capacity laid no longer supports current applications, new fiber optic lines would need to replace the old slower lines, again at a substantial cost. Telephone monopolies in the U.S. lobby congress to get laws passed that benefit them and use their market power and money to crush the competition and their innovation.

Some new construction communities, which are being built from the ground up, are getting fiber optic cable to the home. Roads need to be built and ditches need to be dug in the community so laying fiber optic cable is cost effective. These new communities, however, are minimal. Fiber optic cable will continue to remain an alternative in other areas of the country, however the average home user cannot afford the cost of getting it to their home. It is also time intensive and political to get the permits to dig up roads or hang fiber optic cable from poles. So the fiber optic cable alternative, while technically feasible, does not appear to be practical from a cost or time perspective. Fiber optic cable alternatives will be discussed later in this thesis.

2. Satellite Access

It is possible to get Internet access over some digital TV standard satellites. The key limitation of commercial TV/Internet satellites is, however, the upstream capability. The TV satellite technology now in use is not suited to receiving weak signals that small home units could produce. Instead, the satellite listens to its base stations for instructions on what to send to all users, and all users get it and decide whether it is meant for them, or just discard the transmission. The link from the home to the Internet must travel over a plain old phone line modem and suffers all the same disadvantages as discussed above. Another disadvantage of satellite is the high latency inherent in such a link. This is a function of the sheer distance between earth and the geo-synchronous satellites. Of course in areas devoid of alternatives, satellite TV may be the only choice and should continue to remain an alternative. Since satellites are just now getting some attention with respect to sending and receiving data, satellites will not be discussed in detail in this thesis.

D. HOW MUCH BANDWIDTH IS ENOUGH?

A valid question to ponder is when is enough bandwidth enough bandwidth? History has shown that whenever higher speed fiber optic cable becomes available, the additional bandwidth is rapidly utilized as the market comes up with new and innovative ways to utilize it. The need for Gigabit speeds is not uncommon even now and future

applications will likely be invented to use all this bandwidth. Imagine for a moment the ability to select any TV program or movie to watch whenever desired. Imagine entire household appliances being periodically checked for failure and having the most recent updated software whenever it became available sent to the appliances. Imagine a videophone, audio music CDs, streaming video games, and Internet surfing all at the same time. The past has shown us that if a high-bandwidth infrastructure is built, the bandwidth-intensive applications will certainly follow.

E. LAST MILE PROBLEM DEFINED

So there is a demand for high-bandwidth applications to the last mile and what we currently have is insufficient. Additionally, the cost of laying fiber optic cable to every last mile home or business is currently not cost prohibitive. The problem then becomes what are the alternatives to achieve a high-bandwidth transmission medium to homes and businesses in the last mile at a reasonable cost? Moreover, what are the alternatives in underdeveloped countries around the world? They will also demand high-bandwidth at a low cost.

In this thesis we investigate technical and economical issues related to realizing a high-bandwidth transmission medium at a reasonable cost with easy options to upgrade to faster speeds as they develop. In particular, we will explore the use of Free Space Optics (FSO) to address the lack of adequate bandwidth to the last mile. In addition, we will explore existing Wireless Broadband Radio Frequency alternatives for solving the last mile problem. Finally, combining these alternatives into a solution for not only now but the future will be discussed. Network access companies will likely combine all the alternatives together in order to provide a reliable, always on and never interrupted high-speed super highway to each and every home and business in the last mile, in an economically viable way.

F. SUMMARY

So what is a solution to provide high-speed broadband network access to homes and businesses in the last mile? It is clear that the existing copper infrastructure is at or

close to its maximum. The most obvious answer then is to extend fiber optic cable to the last mile and provide the required high broadband network access. There are challenges associated with this alternative, such as addressing the cost of hanging fiber or digging trenches to lay the fiber, and resistance to competition initiated by the telecommunication monopolies. Once fiber is laid or hung, the same problem arises with the need to upgrade to higher bandwidth fiber in the future.

The other end of the spectrum would be to have homes and businesses in the last mile get their broadband access via satellites. Satellites are utilized for broadcast to a large area in a downlink (e.g., satellite television) but the problem is their ability to handle individual user uplink and will therefore not be a viable solution in the near future. So a solution to provide high-speed broadband to the home and businesses in the last mile that is cheaper and scalable than laying or hanging fiber and more feasible than satellites is the wireless technologies of FSO and Wireless Broadband Radio Frequency.

III. FREE SPACE OPTICS TECHNOLOGY

A. WHAT IS FSO

The invention and application of fiber optics has significantly changed the course of telecommunications around the world. Fiber optic cables connect all major countries around the world as well as all telecom switches in the U.S. What is lacking, as discussed in the previous chapter, is the high-speed communication line between these telecom switches and the last mile. Today, only three to five percent of commercial buildings in the U.S. are connected to fiber for high-bandwidth services, and the percentages are even smaller in Europe and other parts of the world [AIRF01].

FSO is wireless laser-based point-to-point communications in which the points have clear line-of-sight between them. See Appendix A [AIRF04] for AirFiber's FSO technical specifications. This line-of-sight technology currently enables full duplex optical transmissions at gigabit per second speeds over metropolitan distances of a few city blocks to a few kilometers. This is more than enough to support data, voice and video traffic, in addition providing for connectivity without deploying fiber-optic cable or securing spectrum licenses. FSO is not a new technology, since lasers have been around since the 1970's, but is recently gaining popularity as a broadband alternative. FSO applications started as an emerging solution to expediently and affordably extend high-bandwidth access to buildings not already connected to fiber without digging trenches or laying fiber.

Wireless optical networking is an innovative technology that improves upon the relatively new concept of FSO. Typically, the optical transceivers are mounted on building rooftops or placed in large windows. The optical transceiver consists of a laser transmitter and a detector to provide full duplex capability. Figure 5 compares the outgoing signal to the incoming signal and illustrates LightPointe Communications Inc.'s laser node. FSO can provide for rapid deployment of broadband access services to office buildings, multiple tenant buildings and other remote areas.

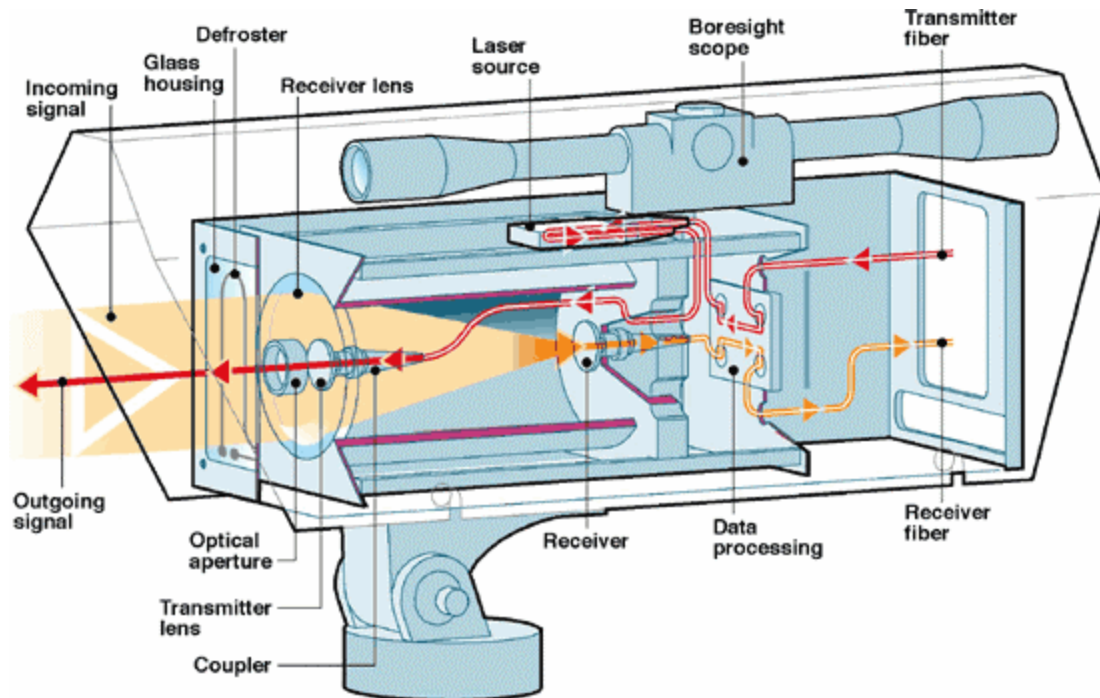

Figure 5. LightPointe Communications Inc. Node [From: WILL01]

FSO operates in the infrared region of the electromagnetic spectrum at a wavelength just smaller than visible light (See Appendix B). This small wavelength or large frequency is in the worldwide-unlicensed range (greater than 300 GHz) and therefore requires no spectrum license approval. The laser industry has adopted the 850nm and 1550nm wavelength standards, which FSO has also embraced. This is the same type of semiconductor laser used in writable CD ROMs. The difference in the two wavelengths may seem slight but is proving commercially to be quite significant.

The smaller wavelength (850nm) is one-tenth the price of the larger (1550nm) wavelength to manufacture. Why then not just operate at the 850nm wavelength? It is because the larger wavelength allows for much greater power to travel over a greater distance at a very high data rate. A recent example has an 850nm laser costing about 5,000 dollars with a data rate at about 10 Mbps over a few hundred yards while a 1550nm laser costs about 50,000 dollars but gets a data rate up in the gigabits per second range over a few kilometers [WILL01]. Both wavelengths have application and there is room for both standards to succeed in the market. Many businesses today may only need the smaller cheaper bandwidth while some infrastructures or areas require larger bandwidth

over greater distances or higher power alternatives, for example in areas of known fog. Future research may reduce the size, performance, and cost of FSO technology.

B. FSO APPLICATIONS

There are two factors driving the adoption of Wireless Optical Networking. The first is demand for high-bandwidth services from businesses. A few fiber optic T1 lines no longer supply enough bandwidth for most businesses. The second factor is the aggressive competition between carriers, which creates demand from carriers for a technology that can get high-bandwidth services to buildings in days instead of months. Currently, there are a few alternatives for implementing available FSO technology.

In this thesis, we discuss the FSO applications provided by three companies. Although all three companies have minor differences in their business approach, all three have the same purpose of providing high-speed bandwidth through the air without the high cost associated with fiber optic cables. The market segment targeted by all three companies is large office complexes and companies without fiber optic cables and within a couple of kilometers of a fiber optic ring. Due to FSO's infancy, the cost is not low enough yet to target individual homes in the last mile. However, with further research and innovation, the cost may continue to drop and the node sizes may get smaller. Chapter 5 provides more detail about a potential FSO solution for the home market.

1. AirFiber Inc.

AirFiber utilizes their FSO technology and OptiMesh topology, essentially creating an "Internet in the Sky." OptiMesh uses an innovative mesh configuration of short redundant links between optical transceivers (nodes) to extend broadband access from "on-net" buildings with fiber to "near-net" buildings requiring up to OC12 speeds. OptiMesh includes Rooftop System, Element Management System (EMS) and Link Acquisition system. All network management functions for the system are performed from a terminal typically located in the carrier's Central Office (CO) or Network Operations Center (NOC) via signaling connections to the control processors in each node. New nodes and buildings can be added to the EMS at the NOC and rapidly

installed at the customer premises. The EMS is a graphical, easy to use, cross platform software package that manages the mesh network and each of its nodes, including configuration, fault management, accounting, performance management, and security. The EMS can be integrated with most NOC network management platforms, including Hewlett Packard's OpenView and Nortel's Preside [AIRF04].

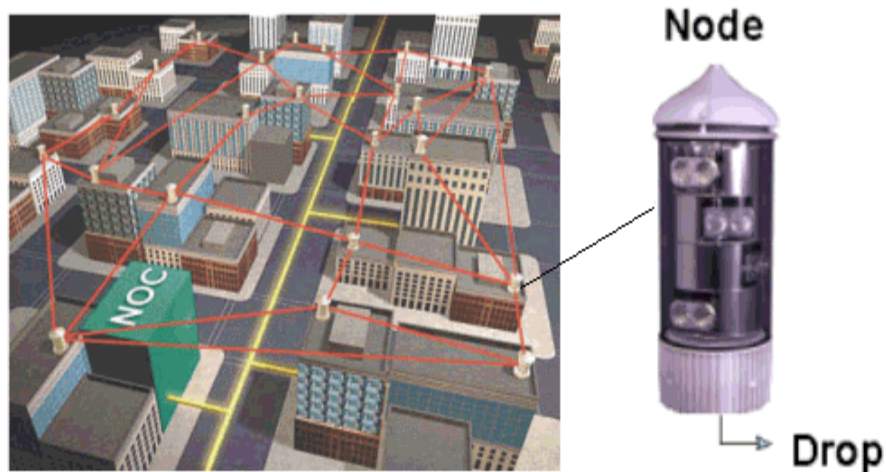

Figure 6. AirFiber OptiMesh Rooftop Node [From: AIRF04]

Figure 6 is the node manufactured by AirFiber Inc. and marketed by Nortel Networks. The four-transceiver node is 13 inches by 38 inches and weighs 52 pounds. There is also a two-transceiver node that is 13 inches by 29.5 inches and weighs 44 pounds [AIRF03]. Each node in a network serves as an access point for one building and a relay point for traffic originating elsewhere in the topology. Each node is equipped with up to four optical transceivers, a drop to the building demarcation, a control microprocessor, software and a small 6 X 6 ATM switch for transporting voice, data and multimedia services. The links between nodes are relatively short (about 200 to 500 meters, depending on atmospheric conditions), but yields 622 Mbps access. AirFiber has recently formed an agreement with Alcatel to offer a comprehensive metropolitan area network system using Alcatel's switches, with interfaces now including compact nodes mounted on the rooftops of various buildings and connected by line-of-sight provide the mesh network function (see Figure 7) [AIRF01]. The nodes are equipped with automatic tracking capabilities that allow for variables such as building sway and solar load, and the short optical links yield high over-the-air availability, even in dense fog. The mesh

network automatically reroutes traffic around temporary link outages and equipment failures.

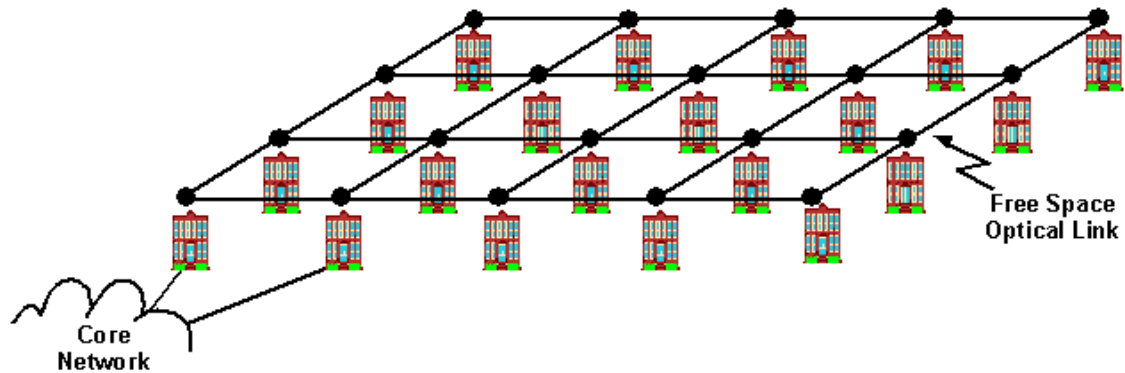

Figure 7. AirFiber Mesh Topology [From: AIRF04]

Each OptiMesh rooftop node supports a mesh network of wireless optical links capable of 622Mbps transmission rates. The telecommunications drop interfaces currently supported are OC3c/STM-1 (155Mbps) and OC12c/STM-4 (622Mbps). Any bandwidth up to 622Mbps can be dropped to a building from a single node. If more bandwidth is desired, then multiple nodes can be employed on a single rooftop. Nortel is selling AirFiber's optical transceiver rooftop node calling it the OPTerra Metro 2400 Open Air System. Its features include:

- Nodes typically installed on the top of buildings and linked together by line of sight mesh networking of open-air optical links
- Short links of 200 - 500 meters to ensure carrier grade availability (99.999%)
- Bi-directional 622Mbps transmission rates
- Nodes equipped with up to four optical transceivers, a control microprocessor, an ATM switch for routing, and software
- Tracking capability of optical transceiver to automatically adjust alignment for building sway and thermal expansion
- Standard OC3c/STM1 or OC12c/STM4 interfaces

- Compact design (12" diameter X 35" height for 4 links)
- Easy to install, no need for routine maintenance and are designed for an eight-year life.
- The system power source can be 120 VAC, 50/60 Hz or 240 VAC, 50/60 Hz with a 4 –8 hour battery backup. [NORT01]

2. TeraBeam Corporation

One of AirFiber’s competitors, TeraBeam Corporation based in Seattle, Washington, uses similar FSO technology. TeraBeam installs an optical transceiver in a window that connects customers to their metropolitan access network. TeraBeam’s focus connects customers through the window vice the roof but also requires line of sight. This flexibility allows them to connect virtually any office in a metro area within reach of their hub site. Figure 8 illustrates the TeraBeam topology. In April 2000, TeraBeam launched a strategic partnership with Lucent Technologies. Under the agreement, Lucent invested cash, intellectual property and other considerations valued at \$450 million and gathered an additional 105 million in funding [TERA01]. Their network provides IP over Ethernet at 10 or 100 Mbps connection speeds.

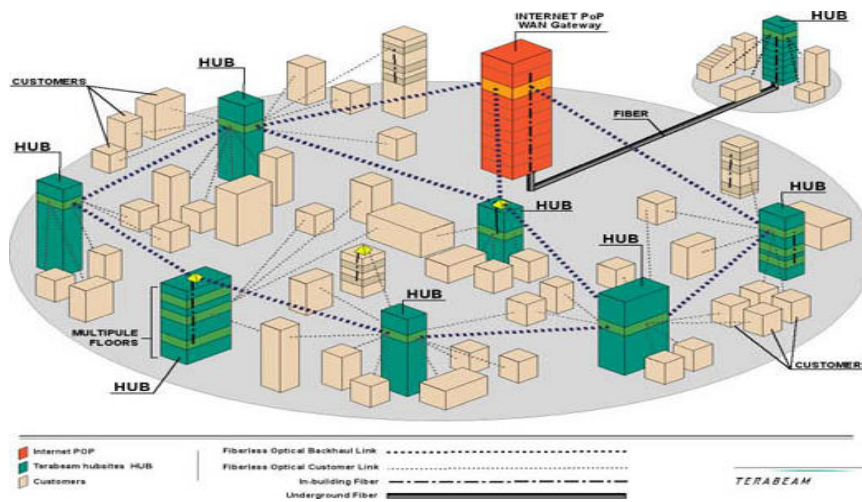

Figure 8. TeraBeam Corporation Topology [From: TERA01]

service providers to serve customers with SONET/SDH, ATM, and Gigabit Ethernet. Fast means that LightPointe's FSO products currently operate at speeds of 10 Mbps up to 2.5 Gbps, again at wavelengths of 850nm and 1550nm. Product installation is simple, and connections of varying distances are available, based on bandwidth and environmental considerations. One of their products, FlightSpectrum, has a distance of approximately 6000 meters [LIGH01].

C. FSO BENEFITS

Wireless optical networking is a carrier-grade last mile technology based on a network of interconnected free-space optical communication links. The network provides multiple routes to each building, rerouting around network faults and interconnectivity to other communications networks. The benefits of FSO systems, like the ones being marketed today, are that no FCC license is required, it is high capacity, it is rapid to deploy, it is simple to integrate, is jamming resistant and, due to the narrow laser beam, has a higher signal security than other wireless solutions.

Additionally, the lasers used in FSO systems are safe. The sensitivity of the human eye is very low at the 850 and 1550nm wavelengths and the beams are invisible. If you look directly along the line-of-sight (i.e., stand directly in front of a node), a small red dot from the transmit optics is weakly visible within a cone of about 0.1 degrees [AIRF04]. There is no interaction in the air between two crossing beams. If a bird completely blocks the small two-inch diameter transmit or receive aperture, the connection is temporarily broken. Once the bird has passed through the beam, the optical link is automatically reestablished.

D. FSO LIMITATIONS

There are some problems, however, associated with FSO operating at this area in the spectrum including scintillation, scattering, beam spread and beam wander. Scintillation is defined as the temporal or spatial variations in light intensity caused by atmospheric turbulence such as wind or temperature gradients. Scintillation causes the illuminated area at the receiver to have a distribution of light and dark patches. At the

short link ranges discussed in all FSO systems, scintillation is not a significant factor. Scattering is the loss of the beam strength due to weather condition such as fog or rain. Beam spread is the spreading of the beam caused by distance. Beam wander is movement of the laser beam slightly caused by conditions such as building sway [AIRF04].

Free Space Optic networks are typically designed for 99.999% availability. The main atmospheric impact to availability is fog as shown in Table 1 below:

Condition	Attenuation
Clear Air Attenuation	5-15 dB/km
Rain Attenuation	20-50 dB/km
Snow Attenuation	50-150 dB/km
Fog Attenuation	30-300 dB/km

Table 1. FSO Atmospheric Attenuation [From: AIRF01]

Planning tools use the position of the sun versus time at each location to determine which pointing angles would result in any turret in that specific network pointing into the sun. Links with a potential for a solar crossing are generally omitted from a network plan except as backup links. A solar crossing (i.e., an occurrence of a transceiver looking directly into the sun) will not harm the products. Rain does not present a problem over the recommended operating ranges of most products. Fog, however, has historically been a major stumbling block attaining high levels of reliability in wireless optical networks. The development of a unique short-link optical mesh network has been explored to address this issue.

E. SUMMARY

FSO is alive and well in the commercial industry. The primary focus now is getting high-bandwidth to office buildings close to where fiber optic cables are already laid. It is a solution to the last mile problem, with many potential benefits and few drawbacks. This new technology changes the business model from “sell then build” to “build then sell.” High-bandwidth wireless optical networks provide high availability

with short automatic tracking links (200-500 meters) and sometimes multiple paths to customers. It is fast and easy to deploy compared to other technologies available. Recalibration is not usually required since there is a tracking system built in the nodes, but if any link fails the nodes may need to be investigated. There is no additional planned or scheduled maintenance for most systems except battery replacement every few years.

It may be possible to make this technology cheaper and smaller in order to provide a solution for individual homes and smaller businesses in the last mile. Nodes use all the current technologies and come in many varying topologies. The initial research shows that it might be difficult today to achieve a FSO link to each home in the last mile. These technologies work well for buildings close to fiber optic cables, usually in major cities, but solutions and smaller devices would need to be made available at a low cost for this to be optimal in the true last mile. As this technology and its application mature, FSO may become a viable solution for serving individual homes and businesses in the last mile.

IV. WIRELESS BROADBAND RADIO FREQUENCY TECHNOLOGY

A. WHAT IS WIRELESS BROADBAND RADIO FREQUENCY

FSO laser technology can transmit large amounts of data from one point to another very rapidly. As discussed in the previous chapter, its topologies currently are point-to-point or mesh type. The technology has not evolved enough yet to get a true point to multi-point topology. Nodes are big and expensive and require too much precision to employ them to each and every home and business in the last mile. As the commercial market continues to evolve in the future, Free Space Optics may become an alternative for each and every entity in the last mile. Wireless Broadband Radio Frequency, however, can capture the last mile inexpensively. Radio Frequency, similar to lasers in FSO, is also not a new technology (cellular phones have been around for a while) but is gaining momentum as a wireless infrastructure alternative in the last mile solution.

Wireless Broadband Radio Frequency technology that exists today does operate on the point to multi-point topology and is good for broadband network access. Radio Frequency is a more mature technology and the equipment is cheaper, easier to install and requires less precision. The data rates are significantly smaller than Free Space Optics but the distances tend to be relatively greater. Both of these solutions, however, require clear line of sight and can be affected by weather. Many Internet Service Provider (ISP) companies that exist today are offering wireless broadband radio frequency as an alternative for broadband access to last mile homes and businesses. The market is still in its infancy, but as this alternative becomes more and more available in many more areas, its popularity will likely increase.

Radio frequency propagation has been around for many decades and has been used to transmit voice and data through the air. However, the speeds have been very slow and vary depending on the frequency and wavelength. Wireless Broadband Radio Frequency is an innovative extension that improves upon the technology and allows high-speed data transfer over relatively short distances. Typically, radio antennas are mounted

on rooftops or mountaintops in order to provide a clear line of sight to a large area. Antennas at the homes or businesses point to the main antenna and provide full duplex capability.

Figure 11 displays the radio frequency electromagnetic spectrum. Appendix B is a more detailed look at the electromagnetic spectrum and lists many important attributes of the radio frequency spectrum. Frequency and wavelength are related by the formula:

$$\text{Wavelength} = \text{Speed of Light} / \text{Frequency in Hz}$$

where the speed of light is approximately 3.0×10^8 meters per second. Radio waves incorporate most of Appendix B, however, it also shows the infrared region where FSO operates.

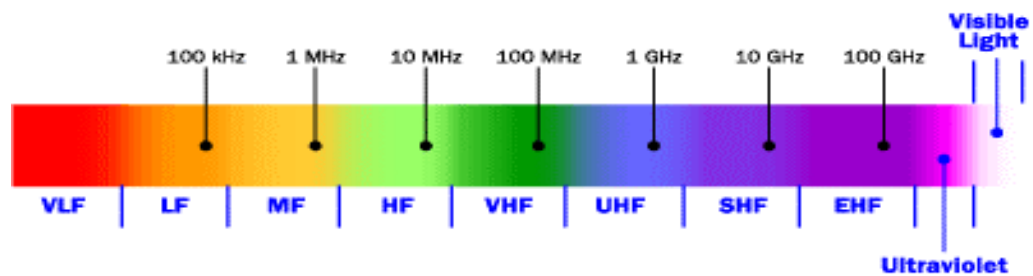

Figure 11. Radio Frequency Electromagnetic Spectrum [From: ELECO1]

B. WIRELESS BROADBAND RADIO FREQUENCY APPLICATIONS

1. Alvarion

Alvarion is a Carlsbad, California based company created through the merger of BreezeCOM and Floware. Alvarion is a premier provider of solutions based on Point-to-Multipoint (PMP) Broadband Wireless Access (BWA), a technology essential to the growth of broadband markets. The company supplies integrated BWA alternatives to telecom carriers, Internet Service Providers (ISPs) and enterprises all over the world. These various alternatives allow for a tiered approach, both in terms of bandwidth and pricing; the more money provided the more bandwidth that can be guaranteed. The initial capital investment required by an ISP is minimal with a fast return on investment, providing alternative solutions everywhere, even where DSL and cable will never

affordably be able to go. Operating cost is minimal and since there is no interconnect charges with an all-wireless solution under the same carrier or ISP, the entire “broadband revenue pie” belongs to the carrier/ISP. Management of the network is easy through the use of the well know and widely used Simple Network Management Protocol (SNMP) [ALVA01].

Alvarion BWA infrastructure, illustrated in Figure 12, consists of two major parts: the base station and the end user Customer Premise Equipment (CPE). One base station can handle up to one thousand users each with three Mbps (uplink and downlink) at a reasonable cost. It consists primarily of an antenna and a router connected to the Internet. It can be deployed in three main ways. It can be line of sight and may be up to tens of kilometers depending on line of sight and atmospheric conditions. It can be non-line of sight but then the radius shrinks drastically, primarily less than one Kilometer. It can be a hybrid of the first two, in areas where non line of sight exists near the antenna and line of sight exists for users further away from the base stations. Again, the focus is on providing as many alternatives as possible to carriers and ISPs.

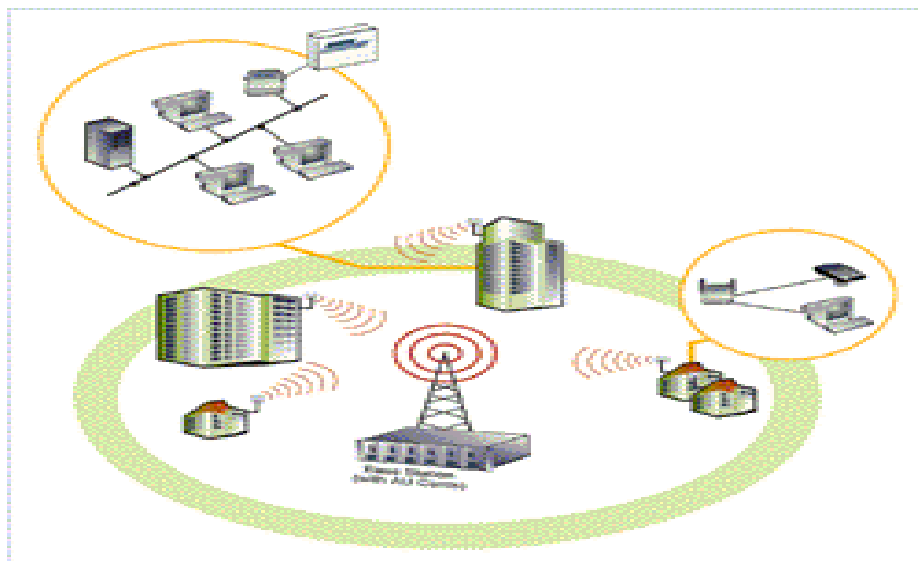

Figure 12. Alvarion Base Station and CPE Architecture [From: ALVA01]

The Customer Premise Equipment (CPE) comes in primarily two distinct infrastructures. The first is just an indoor unit for wireless access and the second and more applicable architecture consists of an indoor unit and an outdoor unit. The outdoor

unit consists of a radio module and an antenna. The outdoor unit connects to the indoor unit through the use of coaxial antenna cable and has typically has an Ethernet port standard interface. There can additionally be a standard Plain Old Telephone System (POTS) interface that connects a user telephone through a RJ-11 port. These various architectures depend on the user needs and desires and provides flexibility in meeting various end user requirements.

Alvarion equipment operates in the licensed (3.5, 3.8 and 2.6 GHz) or unlicensed range. It can also be merged with cell phone telephony base stations. The latest WALKair 3000 system can support up to 34 Mbps uplink and downlink per user at 26 GHz frequencies. WALKair is Alvarion's Point-to-Multi-Point (PMP) Broadband Wireless Access system, which enables telecom operators to cost-effectively connect small and medium enterprise (SME) business subscribers in "last-mile" urban and suburban areas to their network. WALKair utilizes dynamic bandwidth allocation to maximize bandwidth capacity and facilitates the widest range of differentiated high-speed data and voice services at the lowest cost to customers. Multi-frequency band support, large-capacity base stations and multi-service support make WALKair the wireless access solution of choice for new competitive carriers and incumbents seeking diversification [ALVA01]. WALKair 1000 highlights include:

- Enables carriers to provide small to medium enterprises with always-on broadband Internet / Intranet / VPN / LAN Interconnect Access as well as Voice over IP (VoIP), Legacy Telephony, Data Network Access, Video Conferencing, web hosting and E-commerce.
- Each base station provides a coverage area of 10 Km in a 360° radius at the 3.5 GHz and 10 GHz frequencies. Bandwidth allocation can be subdivided according to need, enabling high-performance support of up to hundreds of terminal stations (located at customer sites) from a single base station.
- IP Quality-of-Service (QoS) and fiber-optic quality voice and data enable carriers to offer highly differentiated and flexible provisioning of IP services.

- Low infrastructure investment – a multi-carrier approach from the base station reduces the number of terminal station outdoor units and minimizes the new carrier’s initial investment. [ALVA01]

Last mile users will vary in terms of bandwidth required and the price they are willing to pay. Currently, DSL and cable modems, in places where they are available, do not provide alternatives to the user. Another advantage of BWA is the total independence from landline infrastructure, which will in the future allow for quick and cost effective upgrade to the latest technology and equipment available. Scalability is perhaps the best advantage to carriers and ISPs. Bandwidth flexibility, combined with the quick to deploy and affordable characteristics, make these RF alternatives a solid solution to the last mile problem. Much attention is being focused on this technology now to increase both distance and bandwidth as a viable alternative solution for the last mile. It can provide the tier approach with respect to both pricing and bandwidth to provide alternatives and solutions for every type of end user.

2. Alcatel

Alcatel is a French based company formed from the merger of CIT-Alcatel and Thomson Telecommunications in 1985. It is a leading architect of Internet communications solutions and is involved in all areas of telecommunications including optical fiber, mobile networks and space systems. The company is critical in migration from today’s TDM network to a packet-based infrastructure. Alcatel currently has a footprint in every Regional Bell Operating Center (RBOC) and major Telecommunications company in the U.S. Alcatel is currently the broadband wireless access market leader with more than one hundred customers in commercial and trial deployments. Alcatel’s success in broadband wireless access can be attributed to:

- Reliable, high-performance products available immediately for mass commercial deployment
- Availability of end-to-end networking solutions including products for Core, Edge, Transmission, and Network Service management

- Global turnkey deployment experience combined with strong local/in-country presence and deployment support
- Full ranges of license support services, including business case analysis, network design engineering, and customized financing assistance when applicable [ALCA01]

Alcatel is just one of numerous other worldwide commercial companies offering broadband wireless solutions. Many companies are realizing the potential market available and working on solutions to provide broadband access to the last mile areas around the world. The technology and the companies to implement the technology both exist to bring wireless broadband network access to the last mile home. Alcatel's prime motivation is to:

- Provide services to 100% of their potential customers
- Turn up and provision services rapidly
- Provide a return on investment that balances revenue generating services and deployment costs while protecting their investment in existing infrastructure [ALCA01]

These principles are consistent with other companies competing with Alcatel and strict competition should provide better services and alternatives for consumers in the future. Figure 13 shows Alcatel's equipment setup and topology required for both the base station and customer premise sites and it is similar to what other carriers are offering.

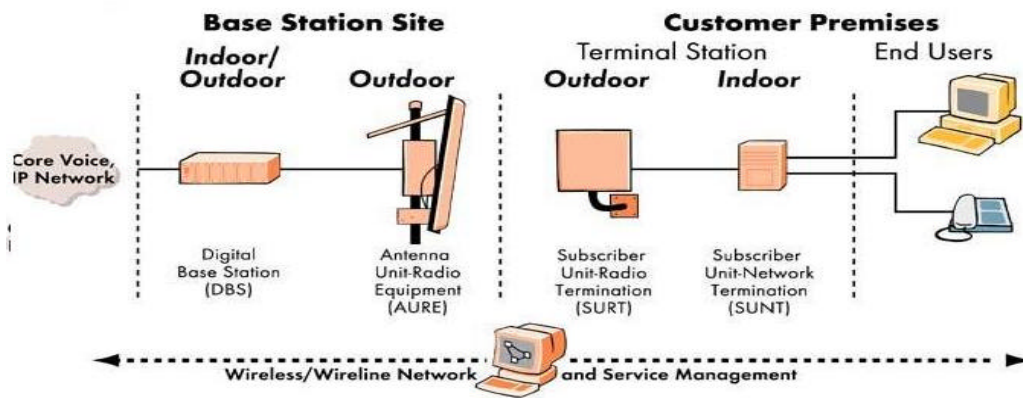

Figure 13. Alcatel Base Station and Customer Premise Equipment [From: ALCA01]

3. Universal Internet

Universal Internet is a local ISP in the Monterey, California area based in Carmel, California. Silicon Valley investors David Mariani and Robert Serventi have recently acquired the company. Universal Internet offers various alternatives to last mile homes and businesses including DSL, ISDN, Frame Relay, Dial up, and Wireless Broadband. Their wireless broadband service operates in the 2.4 GHz range and therefore is less affected by atmospheric conditions and can have a range upwards of three miles with direct line of sight. A site survey is required prior to wireless broadband service and if there is no line of sight to an antenna, then wireless service is either denied or another Wireless Point of Presence (WiPOP) is installed.

The author currently has a wireless broadband connection with Universal Internet. The self-install option was chosen and the equipment cost 450 dollars in 2001 and includes an antenna, a signal analyzer and coaxial antenna cable to connect the two. The particular equipment provided in the purchase is made by BreezeCOM (now called Alvarion through a merger) and has the capacity of up to three Mbps with one Ethernet port. A monthly fee of 45 dollars provides a guaranteed 256 Kbps (the author gets upwards of 800K up and down due to proximity to antenna) and the more money paid the more bandwidth guaranteed up to the three Mbps maximum currently available. This gives a wireless always on connection, one static IP address and two email addresses. There is a sliding cost scale and the more money you pay the faster service you get. For

example, the home or local business in the last mile can pay the maximum cost of 250 dollars per month and yield a guaranteed 1.1 Mbps and up to 64 IP addresses [UNIV01].

C. WIRELESS BROADBAND RF BENEFITS

There are certain fixed wireless broadband benefits over cable and DSL. Wireless technology alternatives are becoming popular for many reasons. DSL and cable have stumbled in deployment, price and convenience, and have not provided the satisfaction consumers were promised. Fixed wireless can serve many urban and rural areas at comparable costs where the alternatives were not available previously. Wireless Broadband is an alternative for areas outside DSL coverage range or in rural areas where cable is not economical to run. Homes and businesses can connect rapidly, without waiting weeks for the phone or cable companies to process their order or determine availability. No phone lines and no phone bills are required with wireless broadband. In 2001, connections are very fast with speeds ranging from 250 Kbps up to 11 Mbps and faster.

Many of the same benefits of FSO are also benefits with Wireless Broadband Radio Frequency. Most operate in the unlicensed frequency band or in the already FCC approved Industrial, Scientific, and Medical (ISM) frequency band (902 to 928 MHz) similar to cell phones or cordless phones in the home. As a result, weather and atmospheric conditions do not affect Wireless Broadband Radio Frequency like it does with FSO. Scalability and ease of upgrade provide quick and easy installation with new areas being reached daily. The primary benefit of Wireless Broadband Radio Frequency over FSO is the true point to multi-point architecture where one base station can provide service to numerous users making the cost cheaper for the ISPs and therefore the end users in the last mile.

D. WIRELESS BROADBAND RF LIMITATIONS

The disadvantage of fixed wireless broadband is the lack of availability in most areas and the requirement to be in direct line of sight to one of the transmit facility access points (AP). A site survey is usually required to determine if current availability exists.

However if it does not, another transmit facility access point can usually be deployed. Distance can also be a factor to consider in wireless broadband alternatives. Bandwidth is relatively smaller than Free Space Optics, however, is still above both DSL and cable modems.

E. SUMMARY

Wireless Broadband Radio Frequency is proving to be a viable alternative solution for carriers and ISPs in the last mile. It provides high-bandwidth to last mile consumers in areas where other alternatives are cost prohibitive or not available. The equipment is affordable and can be rapidly upgraded as new technology emerges and new equipment becomes available. Single IP for personal home use up to numerous IPs for small to medium size businesses are available and give consumers alternatives. The high-density traffic at peak times is avoided and interaction with phone companies or cable companies is non-existent.

Wireless Broadband Access can service many users from one location unlike FSO. Radio Frequency is a mature technology that has just recently been applied to provide high-speed broadband access. This wireless network access is an alternative and viable solution to the last mile problem. FSO and Wireless Broadband Radio Frequency can both complement each other to provide the best high-speed access to homes and businesses in the last mile without laying or hanging fiber optic cable to the home. The next chapter will address a solution to best utilize these two emerging technologies to apply an alternative for carriers and ISPs worldwide.

THIS PAGE INTENTIONALLY LEFT BLANK

V. NETWORK DESIGN AND ANALYSIS USING FSO AND WIRELESS BROADBAND

A. NETWORK DESIGN ALTERNATIVES

The last mile problem and two emerging technologies have been discussed thus far. This chapter will attempt to apply current FSO and Wireless Broadband Radio Frequency technology available on the market today to a hypothetical city, called Wireless, of one million people [LUND01]. In this chapter we pose and compare three alternatives for providing high-speed network access to last mile homes and businesses. The first is to provide fiber optic cable throughout the city of Wireless, both above ground or buried four feet in the ground. The second alternative is to use FSO throughout the city all the way to the home or business. The third alternative is to use a mixture of fiber optic cable, FSO and Wireless Broadband RF. There may be room in the market place for all three alternatives, since the last mile problem is unique in different parts of the country and around the world.

B. HIGH-SPEED SERVICES

In this section we treat the services that a generic high-speed network can provide and all of the decision factors that will remain constant for all three alternatives. In order to compare the three alternatives, a generic template was created for the network. The author understands that there may be unique circumstances in various parts of the world, but the underlying assumptions need to be made in order to create a baseline on which to compare the three alternatives [LUND01].

1. Services Provided

A high-speed access network to last mile homes and business will package together many of the services provided by various vendors using various different transmission mediums and all charging large fees for the use of their service. In some cases, these companies have monopolies in certain areas and the home user has no real alternatives to choose from. If a high-speed access network is provided to each and every

home and business in the last mile, then the applications that can be developed are endless and the door can be opened wider to free market. The following services will utilize this high-speed network and the current costs associated with them can therefore be eliminated or at least significantly reduced (assuming a cost to activate certain services through the Internet arises):

- High-speed Internet
- Television
- Telephony (multiple connections possible at the same time)
- Long Distance Telephone
- Music and movies on demand
- Appliance software updates
- Numerous other services possible

2. General Assumptions Made

Before proceeding, it is important to diagram the hypothetical city of Wireless to be used as a template, which will be the basis to compare all three alternatives. The city will have a population of one million people. It will consist of 500 neighborhoods each containing 400 homes or businesses for a total of 200,000 last mile end nodes. Each end node will require some type of home equipment based on the alternative being considered. The topology of the city is represented in Figure 14 and will be round or oval shaped approximately 16 Kilometers (km) in diameter. There is a ring around the center of the city, similar to the fiber optic ring found in most U.S. cities today, with spokes emanating out from the ring to each of the 500 neighborhoods. The backbone ring around the center of the city will be 25 km in length and each spoke to the neighborhood will be an average of 2 km in length. Each neighborhood will consist of two streets of 200 homes or businesses (100 on each side of the road) and each home lot will be 25 m².

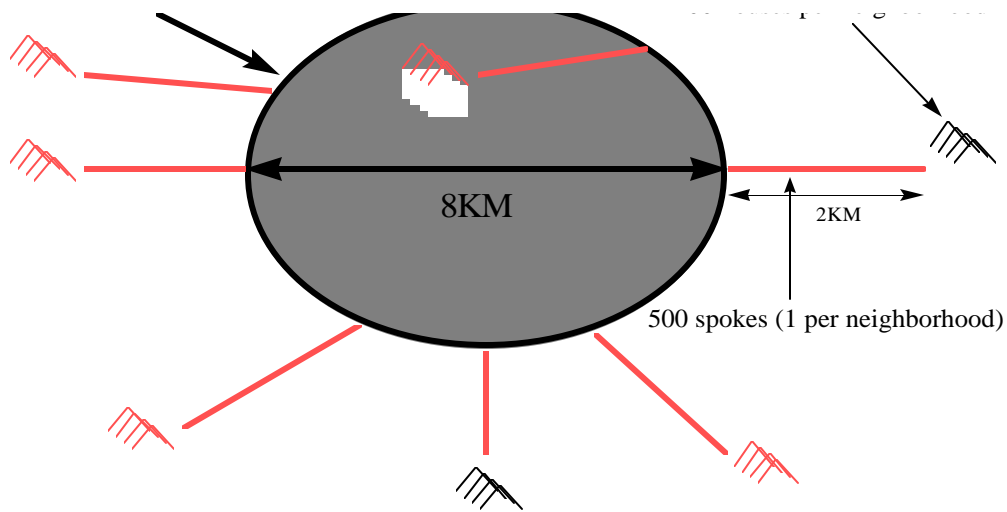

Figure 14. Hypothetical City of Wireless

The following summarizes all the options that will apply to all three alternatives:

1. City of Wireless is comprised of one million people, with an average home size of five people yields 200,000 homes or businesses.
2. City of Wireless is round or slightly oval shaped 16 km in diameter.
3. The entire network will be constructed from scratch, not utilizing any existing infrastructure. Additionally, each home and business will have access to the high-speed network.
4. The center ring around the city is approximately 8 km in diameter by 4 km in height so that the total ring around the city (8 km X 2 top and bottom plus 4 km X 2 for each side) is 24 km. This will be rounded up to 25 km for the center ring.
5. There will be spokes from the center ring to each neighborhood with an average length of two km per spoke. Each neighborhood has 400 homes or businesses and there are exactly 500 neighborhoods of 400 homes per neighborhood for a total of 200,000 homes or businesses.
6. Each home will require some type of equipment based on the alternative being considered.

Table 2 below summaries the assumptions that will apply to all three alternatives being considered.

Population	One million people
Average Household	Four people
Total homes	200,000 homes
Backbone Center Ring	25 km
Spokes	500 spokes
Neighborhoods	500 neighborhoods
Homes per neighborhood	400 homes

Table 2. City of Wireless General Assumptions

C. NETWORK DESIGN ALTERNATIVES

Here each of the three alternatives will be discussed in detail. Other assumptions will need to be made for each individual alternative but the general assumptions discussed above will remain the same. Advantages and disadvantages of each alternative will be explored along with the strengths and weaknesses of each alternative listed. Appendix E is a comparison of all three alternatives listing various variables and how they change among the alternatives.

1. All Fiber Optic Cable

Some additional assumptions need to be considered before proceeding with the all fiber optic cable alternative.

1. From each of the 500 spokes there is a trunk line that runs down the street in front of the homes and from this trunk line passes a line to each home or business.
2. Each neighborhood lot is 25 m² so each neighborhood has two streets of 200 homes or businesses (100 on each side of the street). Therefore, each trunk line is 100 lots by 25 meters each multiplied by the two streets in each neighborhood yields 5 km of fiber optic cable required per neighborhood.

3. For each home or business there is a 20-meter line from the trunk to each home. Assuming each home or business is wired, there will be 400 homes per neighborhood multiplied by the 20 meters for each home yields 8 km of cable from the trunk to each home per neighborhood. So 500 neighborhoods multiplied by 8 km per neighborhood yields 4,000 km.

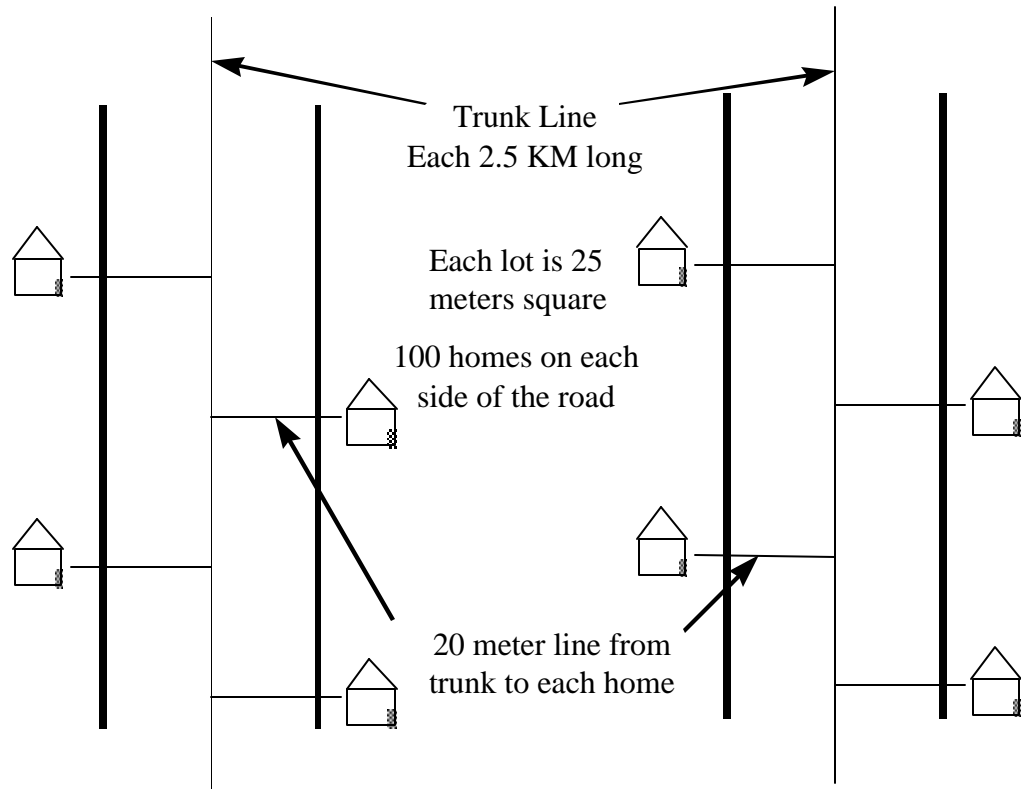

Figure 15. Standard Fiber Optic Cable Neighborhood

See Figure 15 for a graphical representation of the neighborhood assumptions and Table 3 for a listing of total amount of fiber optic cable required. An adjustment factor was added in order to provide some leeway and to round up the total distance to a total of 8,000 km.

Backbone Ring	25 km
Spokes	1,000 km
Trunks (500 neighborhoods X 5 KM)	2,500 km
Neighborhoods (500 neighborhoods X 8	4,000 km

KM per neighborhood)	
Leeway factor	475 km
Total length of fiber optic cable required	8,000 km

Table 3. Total Amount of Fiber Optic Cable Required

2. All Free Space Optics

FSO was the first technology the author researched to bring to each home and business in the last mile. There are various alternatives available from many different vendors (see Appendix D for a partial list of some of the alternatives available), however, for the purpose of this research Nortel's OPTerra Metro 2400 with a data rate of 622 Mbps and a distance between 500-800 meters will be used. A data rate of 2.5 Gbps is on the horizon and will be available in the near future. Nortel's OPTerra works on a mesh topology and has four lasers that can be pointed to four other nodes to create the mesh topology. For the backbone ring and the spokes to the neighborhoods in the city of Wireless, Opterra 2400 FSO nodes are placed 500 meters apart. The backbone ring is comprised of fifty FSO nodes and each spoke is comprised of four FSO nodes. This closeness allows for the high data rates and helps mitigate the effects of weather in most areas of the world, such as scintillation, scattering, beam spread and beam wander discussed earlier in chapter 3.

See Figure 16 for a graphical view of the all FSO ring and spokes and Figure 17 for the graphical view of the all FSO neighborhood. The mesh topology allows for links to go down intermittently but reliability to remain high as traffic is automatically rerouted through other links that remain up. As additional nodes are added to the homes or businesses in the last mile, the mesh topology grows larger. This has the advantage of building the network as you go and as the demand increases.

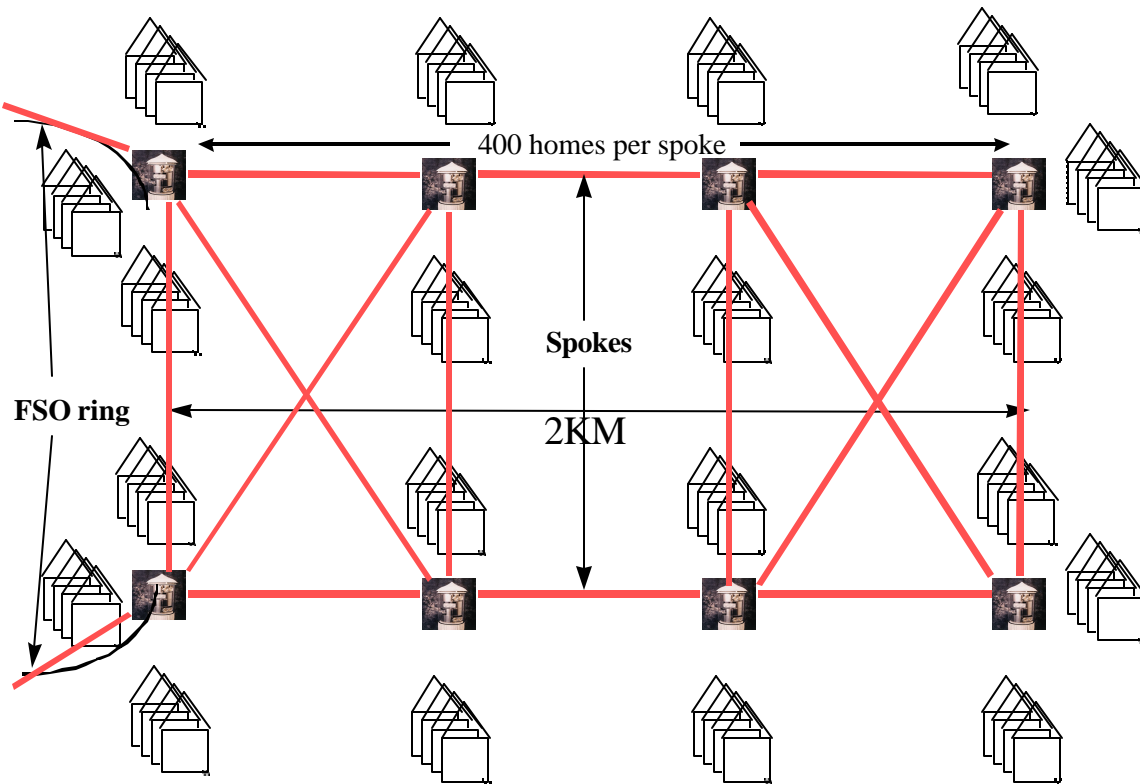

Figure 16. All FSO Ring and Spokes

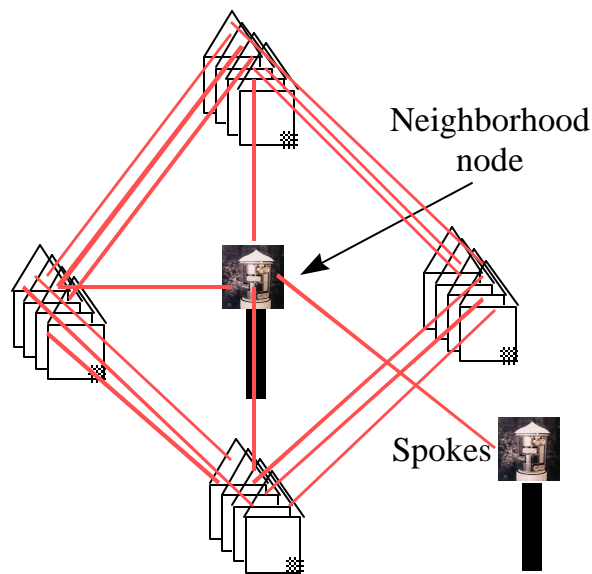

Figure 17. All FSO Neighborhood Node

If homes or more likely big businesses that move out from the fiber optic ring to the last mile where land is more available and cheaper require more than 622 Mbps, then two nodes are installed to give the added bandwidth. Perhaps the biggest drawback to this alternative at each and every home is cost. Currently, there are no FSO nodes available on the market that provide smaller bandwidth at a cheaper price for individual homes.

3. Hybrid Alternative of FSO and Wireless Broadband RF

Since FSO nodes do not yet exist that are affordable for the individual home, the author looked for other existing technologies that could be utilized to bring wireless access to the home. Wireless Broadband Radio Frequency is the solution that currently exists to get high-bandwidth wireless access from the FSO neighborhood node to the individual homes and businesses. In this hybrid alternative, FSO nodes are used for the backbone ring and for all the spokes the same as discussed in the all FSO alternative above. There are four FSO nodes for each spoke and attached to each FSO node in the spokes is the wireless broadband RF antenna. Since there are four FSO nodes per spoke and 400 homes per spoke, each RF antenna on average services approximately 100 homes (again assuming every home and business in the last mile is connected). Figure 18 provides a look at the wireless broadband RF neighborhood node.

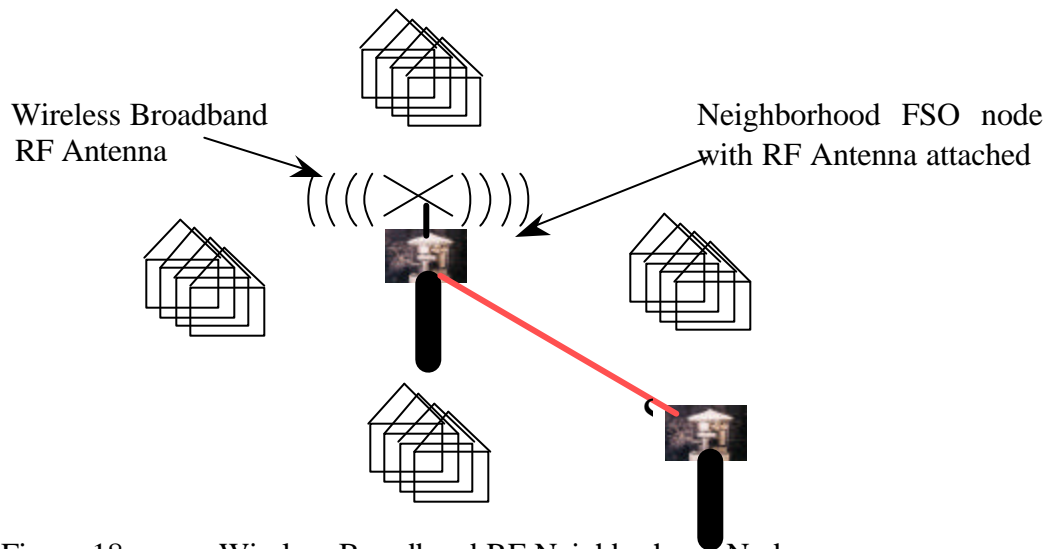

Figure 18. Wireless Broadband RF Neighborhood Node

The best product on the market for the wireless broadband RF at the time of this writing seems to be Alvarion's WalkAir 3000, which has a data rate of 34 Mbps net payload per customer premise equipment and a range of a few kilometers. See Chapter 4 for a detailed explanation of the WalkAir 3000 features. The base station resides on the

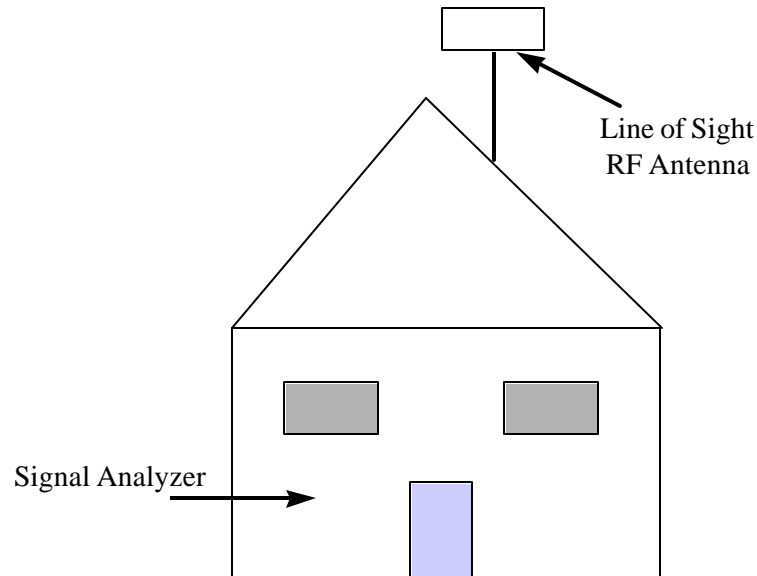

Figure 19. Wireless Broadband RF Customer Premise Equipment

same platform as the FSO node in the spoke and each house will have customer premise equipment consisting of an antenna and signal analyzer. See Figure 19 for a view of what the home or business would look like with the customer premise equipment.

D. COST ANALYSIS OF NETWORK DESIGN ALTERNATIVES

Perhaps cost is the most influential variable in all three of these alternatives. It can be the best equipment providing the best bandwidth with the best reliability but be too expensive for each home or business to afford in the last mile. It is therefore vital to not only look at the best technologies and products available, but also the best product for the lowest cost. All costs included here are the best estimate costs at the time of this writing in U.S. dollars. Many corporations and carriers are sensitive to providing cost estimates because there are many variables that can change the cost including the amount purchased, the contract length, age of technology, location, etc.

This analysis assumes the entire network is being constructed from scratch. However, in practice it would be wise to use existing fiber optic cable and existing conduits from power companies, natural gas lines, sewers, subways, etc. This analysis also assumes that all homes and businesses will have access. In practice there may be no need to construct a section of the network in areas where the subscription rate will not be high and therefore not profitable. See appendix E for a comparison of the three alternatives.

1. All Fiber Optic Cable

The first cost analysis to be examined is the all fiber optic cable including the fiber optic center ring, the spokes, and all wire in the neighborhoods up to the home. As discussed earlier, it would require approximately 8,000 km of fiber optic cable to fully wire the city of one million people. Assuming all the fiber optic cable was buried in the ground four feet deep, the total cost of the cable alone would be 800 million dollars (8000 km * 100 dollars per meter). If we could hang the cable above ground throughout the city to each home, then we could reduce the amount down to approximately 240 million dollars. However, it is impractical to think we can hang fiber optic cable throughout an entire city. The price will probably fall somewhere in between the extremes of 240 million and 800 million dollars. Other costs involved include adding in two switches each at 15 million dollars, 100 Point of Presence (POPs) routers (including the room for transmission equipment) at 500,000 each and home equipment at 200 dollars for each of the 200,000 homes or businesses in the last mile. Adding in this additional 120 million dollars brings the total cost to provide high-speed fiber optic cable to each of the 200,000 homes or businesses in the city of one million people to between 360 million dollars and 920 million dollars. See Appendix E for a detailed listing. Table 4 summarizes the key variables involved in the all fiber optic cable cost alternative.

Price of fiber buried 4 feet deep	100 dollars per meter
Price of fiber above ground	20 dollars per meter
Home equipment	200 dollars per home

All Buried (8,000 KM * \$100/meter)	800 Million dollars
All above ground (8,000 KM * \$30/meter)	240 Million dollars
Switches (15 Million dollars * 2 of them)	30 Million dollars
POP's (100 POPs * \$500,000 dollars)	50 Million dollars
Home Equipment (200,000 homes X \$200)	40 Million dollars
Total Buried (800M + 120M)	920 Million dollars
Total Above Ground (240M + 120M)	360 Million dollars

Table 4. All Fiber Optic Cable Cost Metrics

The advantages of this alternative are that everyone in the city gets high-speed reliable network access and weather or atmospheric conditions does not affect it. However, fiber optic cable has been around for a couple of decades now and the only homes or businesses with fiber optic cable to their residence are some new construction sites and areas where people were willing to pay the high cost of running cable to the home. It is just too time consuming and not cost effective to lay fiber optic cable above or below the ground to last mile homes and businesses.

2. All Free Space Optics

The next cost analysis is that of utilizing all FSO to the home. Most of the distance using fiber optic cable is in the individual neighborhoods. In fact, the backbone ring and the spokes comprise a relatively small amount (approximately 13%) of the total distance under the fiber optic alternative. The neighborhoods are the areas to leverage in order to provide a substantial cost difference. As stated earlier, this alternative utilizes Nortel's OPTerra Metro 2400 FSO nodes spaced 500 meters apart for both the backbone ring and the spokes. The author was unable to obtain an accurate cost of the FSO node, but from current research into the technology has made a very conservative but educated guess of 50,000 dollars per node. Using this figure, the cost to lay fiber for the backbone and the spokes is exactly the same as putting FSO nodes 500 meters apart. If the nodes turn out to be cheaper, then it would be cheaper to use FSO nodes. Eliminating the cost

for the backbone ring and the spokes, the decision then returns to the advantages and disadvantages of each of the technologies as discussed in previous chapters.

The true savings lie in the individual neighborhoods where approximately 85 percent of the fiber optic cable would need to be laid. With FSO, trunk cables as well as cables from the trunks to each individual home or business is avoided. We will assume that the 80 million dollar cost of switches and POPs in the fiber optic cable alternative above is reduced to 60 million dollars for any infrastructure costs involved. Each FSO node comes with a switch (for example the OPTerra Metro 2400 comes with an ATM switch but others are available including Ethernet), but electrical power would have to be made available wherever the nodes are installed.

The main disadvantage right now of having an all FSO neighborhood is the unavailability of a small and inexpensive FSO node for the home. The author assumes a home-use FSO node could be manufactured at an affordable price. As stated in the previous chapter on FSO, this application of FSO technology is in its infancy and now only reaches large buildings just outside the fiber optic backbone within most cities. As the demand for home use rises, companies may begin to offer an affordable solution for individual homes and businesses in the last mile. If hypothetically that node could be manufactured for 1,000 dollars maximum, then the cost for the city of 200,000 homes and businesses would be 200 million dollars. The total cost for the all FSO alternative is then 382.5 million dollars. This is a savings between 0 percent (all fiber optic cable above ground is about the same) and 58 percent (all fiber optic cable buried) over the all fiber optic cable alternative. See Appendix E for a detailed listing. Table 5 provides a snapshot of the all FSO metrics considered in this alternative.

Backbone Ring (25,000 meters / 500 meters)	50 FSO nodes required
Spokes (800,000 meters / 500 meters)	2,000 FSO nodes required
FSO node price (conservative)	50,000 dollars
Backbone cost (50 * \$50,000)	2.5 Million dollars
Spoke cost (2000 * \$50,000)	100 Million dollars

Infrastructure, Electrical power	60 Million dollars
Equipment Cost per home	1,000 dollars
Total Equipment cost (200,000 * \$1000)	200 Million dollars
Total Cost for all FSO alternative	362.5 Million dollars

Table 5. All Free Space Optics Cost Metrics

Interestingly enough, it would cost about the same to bring fiber optic cable above the ground to the last mile as it would to bring FSO nodes to every neighborhood. It then again falls back to the strengths and weaknesses of both alternatives as presented above. The limiting factor in this alternative is that affordable nodes do not yet exist for individual homes. Once they can be manufactured below the \$1,000 dollar per home maximum price imposed in this alternative by the author, then the savings will clearly be in the favor of FSO.

3. Hybrid of FSO and Wireless Broadband RF

Since FSO nodes are not affordable for the last mile home or business yet, this study would be incomplete without trying to obtain a current way to use all wireless technology to the home, thereby eliminating fiber optic cable all together. This last alternative will use a hybrid of the FSO technology discussed in Chapter 3 and the Wireless Broadband RF technology discussed in Chapter 4 to obtain the all-wireless fiber optic cable independent city. Similar to the all FSO alternative above, OPTerra Metro nodes would be used for the backbone ring and the spokes to the neighborhoods. As stated earlier, this cost is approximately the same as if fiber optic cable was laid so either alternative would work. One of the main objectives of this study is to provide carriers, ISPs and consumers with various alternatives in which to choose from. Since we assumed we were starting from the ground up in the city, we will use the FSO alternative for the backbone ring and spokes.

In this alternative, an Alvarion's WalkAir 3000 Wireless Broadband RF base station will be installed at each FSO node in the spokes. This base station will plug into the FSO node and use its high-bandwidth (622 Mbps minimum) as its physical medium

back to the backbone ring. Each base station will be its own Local Area Network (LAN) servicing approximately 100 homes on average. Again, the author was unable to obtain a price quote for the Alvarion WalkAir 3000 base station. However, a conservative cost per base station of 10,000 dollars will be used. Customer Premise Equipment (CPE) costs approximately 400 dollars per home or business. The total cost for this alternative is 262.5 million dollars, a savings of 100 million dollars (27%) compared to the all FSO alternative and a savings of 657.5 million dollars (71%) over buried fiber optic cable.

The drawback to this alternative is that the data rate is significantly less than fiber optic cable that is available today and the FSO alternative of 622 Mbps. However, it still can provide about 34 Mbps. This is more than 70 times faster than a 500 Kbps connection, if any home or business is currently lucky enough to have that speed. It can still provide enough broadband for many of the applications and a service desired today, and is scalable and upgradeable as new technology becomes available. See Appendix E for a detailed listing of all three alternatives. Table 6 shows the hybrid alternative cost metrics.

Backbone Ring (25,000 meters / 500 meters)	50 FSO nodes required
Spokes (800,000 meters / 500 meters)	2,000 FSO nodes required
FSO node price (conservative)	50,000 dollars
Backbone cost (50 * \$50,000)	2.5 Million dollars
Spoke cost FSO (2000 * \$50,000)	100 Million dollars
Spoke cost RF (2000 * \$10,000)	20 Million dollars
Infrastructure, Electrical power	60 Million dollars
Equipment Cost per home	400 dollars
Total Equipment cost (200,000 * \$400)	80 Million dollars
Total cost for hybrid alternative	262.5 Million dollars

Table 6. Hybrid Alternative Cost Metrics

4. Income versus Cost

Now that the costs of three different alternatives have been discussed, it is important to look at the potential income home users could save or the maximum price they would be willing to pay for the high-speed network. Assume the high-speed network access can provide the following services: Internet access, local telephone, long distance telephone, TV and radio. This high-speed network access would then eliminate the current costs associated with these services. Let us assume a typical home user has the following monthly costs associated with these services:

Service	Price
DSL or Cable modem Internet Access (250Kbps)	\$ 40.00
Local Telephone	\$ 10.00
Long distance Telephone	\$ 10.00
Cable TV	\$ 40.00
Radio	Free
<hr/>	
Total Monthly Cost for a typical home	\$100.00

It is conceivable that the home user would pay half of this cost for all their services combined into one so a charge of 50 dollars per month is certainly reasonable for access to the high-speed network.

If the typical home user pays approximately 100 dollars per month for all these services now and we charge 50 dollars per month for the high-speed network that eliminates or minimizes all the costs above, then the home user saves an average of 50 dollars per month. The fifty dollars per month per home or business that we can charge multiplied by the 200,000 homes in the city yields a potential monthly income of 10 million dollars or 120 million dollars a year. If this is the case and home equipment is provided for free, then it could potentially take 2.6 years to make back the capital investment for the hybrid alternative and 3.6 years for the all FSO alternative.

E. SUMMARY

This chapter discussed the network design and analysis of a city of one million people. It discussed the potential services that can be provided by a high-speed network access to homes and businesses in the last mile. It looked at three different alternatives and discussed the approximate cost associated with each. The all fiber optic cable alternative provided high-speed access but at a cost ranging from 360-920 million dollars depending on whether the cable is buried or hung on poles. The cost is mostly associated with obtaining permits and digging trenches. It is not very scalable when new technology or faster fiber optic cable emerges and this alternative would take years to complete. The all FSO alternative cost 362.5 million dollars and is about the same as hanging fiber optic cable from alternative one. It provided the same high-bandwidth as fiber optic cable but would be much faster to employ. The technology, however, is still in its infancy and smaller affordable FSO nodes for the home or business are not yet available. The third alternative presented the best solution using FSO nodes for the backbone ring and spokes to the neighborhood and using Wireless Broadband Radio Frequency within the neighborhoods. This alternative cost 262.5 million dollars or over 100 million dollars cheaper than the other two alternatives. It would provide much lower access speeds than fiber optic cable or FSO, however, would still provide enough bandwidth needed for today's applications.

The backbone cost of 2.5 million dollars and the spoke cost of 100 million dollars is the same in all three alternatives. It is a relatively small cost compared to the total and running fiber optic cable or installing FSO nodes cost the same. The real cost savings and where the most leverage can be obtained is within the neighborhoods. Clearly, the installation of fiber optic cable just within the neighborhoods in the last mile is very costly (240–800 million dollars depending on whether it is hung or buried). Wireless alternatives eliminate this high cost and therefore reduce network access companies initial investment required to provide high-speed access to the last mile. The low cost and the high potential income utilizing free space with FSO or RF is the best alternative solution to solving the last mile problem.

VI. CONCLUSION

A. SUMMARY

The last mile problem is real and is getting a lot of attention by companies looking to take advantage of the possibilities that exist. The current infrastructure of twisted pair and coaxial cable is at its upper limit, so new and innovative ways are required to reach last mile homes and businesses with access to a high-speed network. Fiber Optic cable is the most mature high-speed alternative available, but proves too costly (upwards of one billion dollars to wire a city of one million people) to implement due to the time and cost associated with obtaining permits and digging trenches. Once fiber cable was installed, the problem of scalability and replacing old cable with newer high-speed fiber becomes difficult and the same problems occur again.

Wireless Optical and RF technologies are gaining significant momentum today in helping to solve the last mile problem. FSO and Wireless Broadband RF are two emerging technologies aimed at improving network access to last mile homes and businesses. FSO, utilizing laser technology, provides high-speed network access but is still in its infancy and only now affordable by large corporations or multi-unit dwellings close to the backbone ring. FSO also needs to be relatively precise and distances are relatively short. Weather and atmospheric conditions can also adversely affect it. Wireless Broadband RF, on the other hand, uses the radio frequency spectrum. RF can go greater distances without being affected as much by weather and atmospherics, but the access speeds are relatively smaller. The cost to provide network access speeds using wireless technologies to a city of one million people is about one third the cost of using fiber optic cable or about 260-360 million dollars.

There are several other last mile access technologies available today besides FSO and Wireless Broadband, including fiber, microwave, and copper. As shown in Figure 20 below, wireless optical networking is an excellent technology and only part of the solution for last mile access in urban and industrial environments.

Typical Metro Center

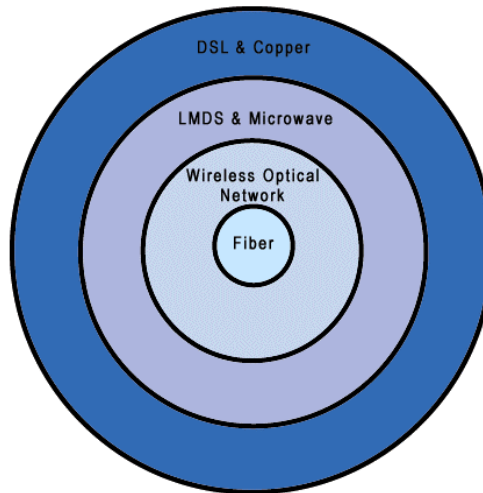

Figure 20. Alternatives Available for a Typical Metro Center [From: AIRF04]

The goal of this thesis was to present various alternatives available to help solve the last mile problem. Areas of the U.S. as well as areas all around the world are quite different and various solutions may be better in various parts of the world. If fog is commonplace in an area then FSO nodes may not be the best solution for that area. The aim was to wrap up Internet access, phone access, long distance access and cable access into one network link to the home, thereby eliminating the services of each individual provider and their associated cost.

The best solution today for the hypothetical city in this case study seems to be a hybrid alternative of many of the various alternatives. Fiber optic cable and FSO nodes are best for the backbone ring and the spokes out to the various neighborhoods. Most cities have existing fiber optic cable and this installed infrastructure should be taken advantage of and not be ignored. FSO nodes can be added rapidly to expand network access to last mile areas. Wireless optical networking is very complementary to these last mile technologies. Figure 22 shows how these technologies address different market segments based on the technologies, technical capabilities (reach, bandwidth), and economic realities.

Wireless broadband and 802.11 standards are potentially technically and economically feasible solutions today for providing the network access within individual

neighborhoods. It is rapidly deployed, can service many various customers in a price hierarchy in order to provide affordable bandwidth to all homes and businesses. Line of sight is still the major drawback but inspiring and innovative solutions are being developed daily to overcome these obstacles. Scalability, reliability, and the ability to upgrade to the latest technology in a timely manner are helping to fuel interest in applying wireless technology for high-speed communications.

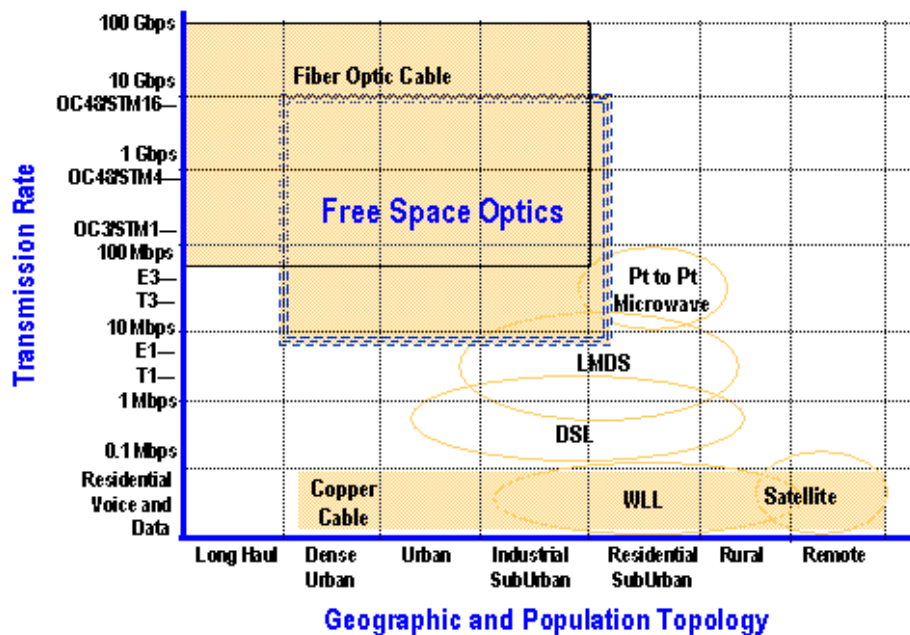

Figure 21. Solutions Based on Transmission Rate and Topology [From: AIRF04]

There is room for other technologies and other alternatives to solve the last mile problem. The more alternatives available the better the competition among them and the better solutions will arise. Many homes and businesses in the world may be too far for practical FSO or RF solutions and satellite access may be their best solution. In 2002, Earthlink began to provide satellite Internet access but the speeds are very slow (128-400 Kbps). However, it does provide a solution for some customers in the remote areas of the world. Lots of attention and money is being directed at wireless satellite access but a viable solution for high-speed net access still seems years away.

Customers without existing cable and twisted pair infrastructures are embracing the wireless technologies rapidly and without hindrance from telecommunications

monopolies that have a lot to lose from wireless technology, unless they are the owners of that infrastructure. It is really all about alternatives and the more ways there are to get network access to last mile homes and businesses, the more backup there will be if something goes wrong and the more reliability might be enhanced. For example, if FSO nodes are utilized and dense fog is preventing the network from communicating, then fiber optic cable is an alternative backup to keep the network running. There is room for many alternatives in the market place for last mile solutions and each and every alternative should be considered.

B. FUTURE RESEARCH

There is ongoing research from all sectors of the market addressing solutions to the last mile problem. Satellite companies, fiber optic cable companies, cell phone companies, wireless optical companies and utility companies are all vying for a piece of the market share. Future research into all these solutions should be pursued. All have their strengths and weaknesses and all have room in the last mile market place. If a high-speed network is available to homes and businesses in the last mile, then numerous applications will certainly follow riding on the physical media.

APPENDIX A AIRFIBER'S FREE SPACE OPTIC SPECIFICATIONS

Bit Error Rate:

Less than 10^{-12}

Transmit wavelength:

780 nm or 0.78 microns, near infrared, single beam

Transmit power:

Average: 9.5 mWatts

Peak: 19 mWatts

Transmitter aperture:

50mm, single transmitter

Receiver:

APD detector

Receiver aperture:

Aperture is 50mm

Modulation technique:

Simple on/off keying

Beam acquisition, alignment, and tracking and response times (Hz), range of motion:

Each optical link has a field of view of 360 degrees horizontally and +/- 20 degrees vertically. Each optical link automatically tracks out any sub Hertz movement of the building (e.g., movement caused by wind loading or thermal building expansion).

[From: AIRF01]

THIS PAGE INTENTIONALLY LEFT BLANK

APPENDIX B ELECTROMAGNETIC SPECTRUM CHARACTERISTICS

Frequency Band	Frequency Range	Wavelength (meters)	Energy (eV)	Region	Propagation Models	Characteristics
ELF	< 3kHz	> 100 KM	< 10 ⁻⁵	Radio	Surface Wave	Worldwide, military and submarine
VLF	3-30 kHz	100-10 KM			Ionosphere	Worldwide, military and navigation
LF	30-300 kHz	10 - 1 KM			Surface Wave	Stable signal, distance up to 1500 KM
MF	300 kHz – 3MHz	1KM-100 Meters			Surface wave (Short)/Sky wave (Long)	Radio broadcasting. Long distance sky-wave signals subject to fading
HF	3-30 MHz	100 - 10 Meters			Sky wave but very limited	3-6 MHz continental, 6-30 MHz Intercontinental, Land and ship-to-shore comms
VHF	30-300 MHz	10 - 1 Meters		TV	Space Waves	Close to line of sight over short distances, Broadcasting and land mobile
UHF	300 MHz - 3 GHz	1Meter-1 cm			Space Waves	Essentially line of sight over short distances, Broadcasting and land mobile
SHF	3-30 GHz	1cm - 100cm	10 ⁻⁵ - 0.01	Microwave	Space Waves	The "workhorse" microwave band. LOS. Terrestrial and satellite relay links
EHF	30-300 GHz	100cm - 1mm			Space Waves	Line of sight millimeter waves. Space to space links, military uses, and possible future uses
	300GHz - 430 NHz	1mm - 700 nm	0.01 - 2	Infrared		
	430-750 NHz	700-400 nm		Visible		
	750-3000 NHz	400 - 1 nm	3 - 10 ³	Ultraviolet		
	3000 - 3x10 ¹⁹	10 ⁻⁹ - 10 ⁻¹¹	10 ³ - 10 ⁵	X-Rays		
	> 3x10 ¹⁹	< 10 ⁻¹¹	> 10 ⁵	Gamma Rays		
10 ⁻⁹ - Nano	10 ³ - Kilo	Wavelength = Speed of Light / Frequency in hertz (where speed of light = 3 X 10 ⁸)				
10 ⁻⁶ - Micro	10 ⁶ - Mega					
10 ⁻³ - Milli	10 ⁹ - Giga					
10 ⁻² - Centi	10 ¹² - Nano					

[Derived from multiple sources]

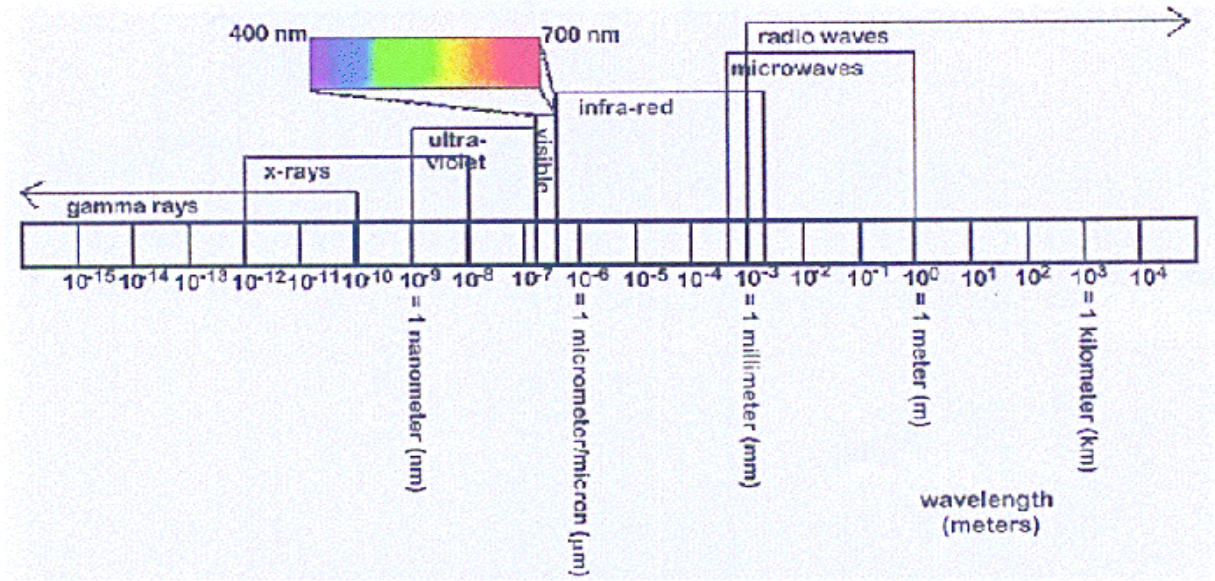

Electromagnetic Spectrum: [From: ELEC01]

APPENDIX C NETWORK DESIGN USING FSO AND RF

City of Wireless

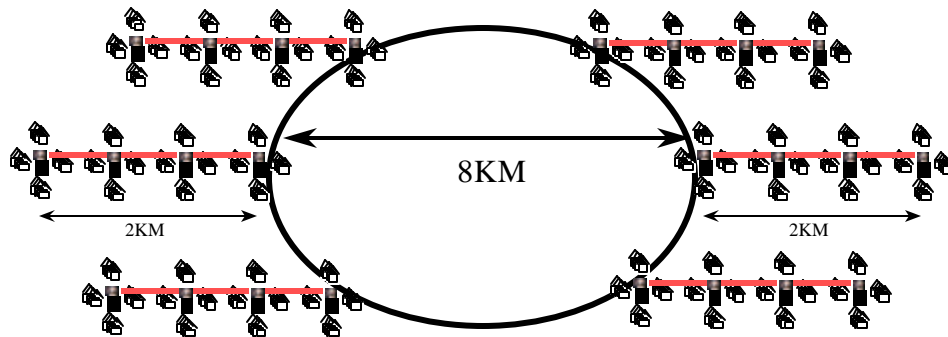

500 spokes (1 per neighborhood)
400 houses per neighborhood

Free Space Optics (FSO) to the neighborhood
RF to the homes

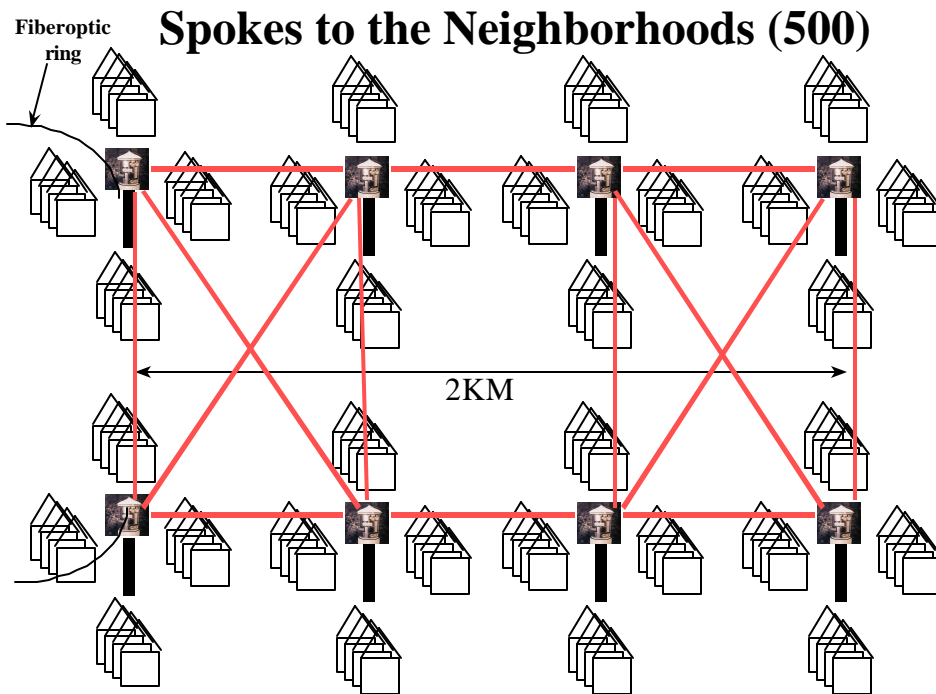

Neighborhood to Homes (400)

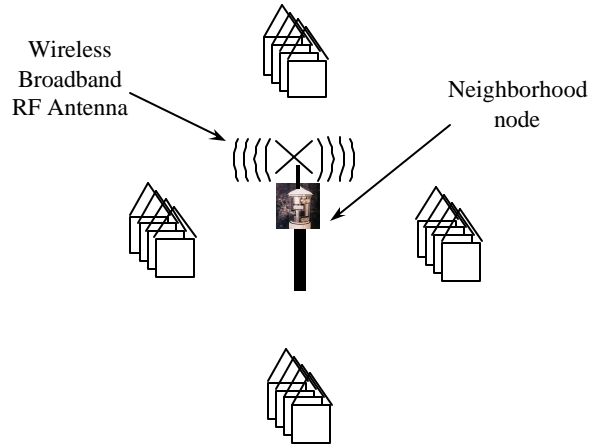

Home

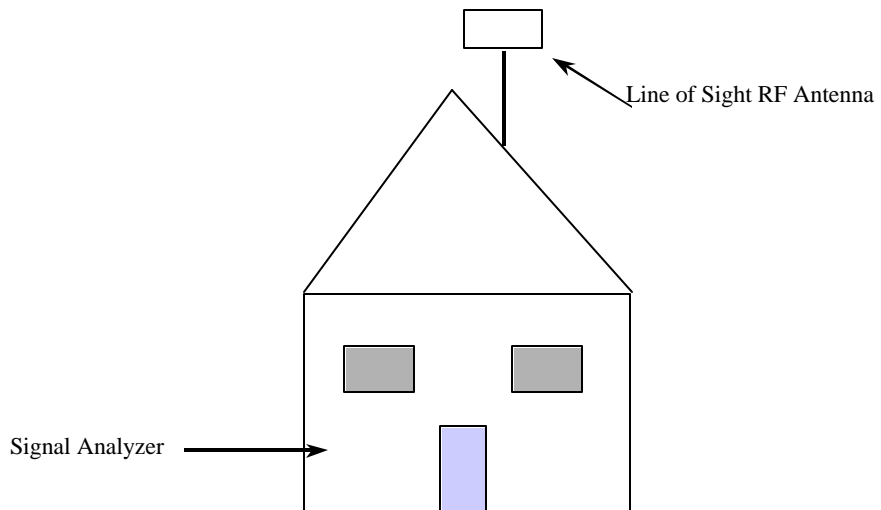

APPENDIX D FSO AND RF COMMERCIAL ALTERNATIVES

Free Space Optics (FSO) and Broadband Wireless RF Alternatives						
Product	Wavelength	Data Rate	Future Data Rate	Distance	Notes	
Nortel Opterra 2400 (AirFiber)	780 NM/1550NM	622 Mbps	2.5 Gbps	500-800 Meters	ATM	NO FCC Approval required
FlightSpectrum 155 (LightPointe)	850 NM	155 Mbps		2000 Meters	Sonet ATM FDDI Ethernet Fast Ethernet	
FlightSpectrum 622 (LightPointe)	850 NM	622 Mbps		1000 Meters		
FlightSpectrum 1.25 (LightPointe)	850 NM	1.25 Gbps		1000 Meters		
FlightSpectrum (LightPointe)	1550 NM		2.5 Gbps	1000 Meters		
BreezeAccess II	2.4 GHz ISM band	3 Mbps		50 KM (30 Miles)	up to 60 Mph	
"		10 Mbps		25 KM (15 Miles)		
WalkAir 3000	26 GHz	34 Mbps				
Notes: Worldwide Unlicensed Range > 300 GHz						
850 NM cheaper						
1550 NM higher power, greater distance						
ex. 850NM \$ 5,000, 10 Mbps, few hundred meters						
1550NM \$50,000, 1 Gbps, 1-2 KM						
Problems: Scintillation, scattering, beam spread, beam wander						

THIS PAGE INTENTIONALLY LEFT BLANK

APPENDIX E NETWORK DESIGN COST ANALYSIS

Background	All Fiber	FSO Spokes, RF to homes	All FSO to the home
Backbone ring/meters	25,000	25,000	25,000
Buried Fiber/meter	\$100	\$100	\$100
Fiber above ground/meter	\$30	\$30	\$30
Number of hoods/Spokes/Trunks	500	500	500
Number of FSO nodes/RF nodes	N/A	2,000	2,000
Length of spokes/meters	2,000	2,000	2,000
Length of trunks/meters	5,000	N/A	N/A
Trunk to home length	20	N/A	N/A
Fiber Leeway Factor/meters 6%	475,000	N/A	N/A
Number of homes per hood	400	400	400
Total homes	200,000	200,000	200,000
Cost per FSO	N/A	\$50,000	\$50,000
Cost per RF	N/A	\$10,000	\$10,000
Home Equip cost	\$200	\$400	\$1,000
Switch cost	\$15,000,000	N/A	N/A
POP cost	\$500,000	N/A	N/A

City	All Fiber	FSO Spokes, RF to homes	All FSO to the home
Ring	\$2,500,000	\$2,500,000	\$2,500,000
Spokes (FSO)	\$100,000,000	\$100,000,000	\$100,000,000
Spokes (RF)	N/A	\$20,000,000	N/A
Trunks	\$250,000,000	N/A	N/A
Neighborhood homes	\$400,000,000	N/A	N/A
Fiber Leeway factor	\$47,500,000	N/A	N/A
FSO Infrastructure cost	N/A	\$60,000,000	\$60,000,000
Home Equip	\$40,000,000	\$80,000,000	\$200,000,000
Switches	\$30,000,000	N/A	N/A
POP	\$50,000,000	N/A	N/A
Total (Buried Cable)	\$920,000,000	\$262,500,000	\$362,500,000

THIS PAGE INTENTIONALLY LEFT BLANK

LIST OF REFERENCES

- [AIRF01] AirFiber Inc. Official Website, <http://www.airfiber.com/index.shtml>
- [AIRF02] AirFiber Press Release, *AirFiber and Alcatel Provide Multi-Tenant Access Via Free-Space Optics*,
<http://www.airfiber.com/news/news102201mnn.htm>
- [AIRF03] AirFiber Node Characteristics,
<http://www.airfiber.com/products/nodechar.htm>
- [AIRF04] AirFiber Frequently Asked Questions,
<http://www.airfiber.com/products/faq.htm>
- [ALCA01] Alcatel Official Website, <http://www.cid.alcatel.com>
- [ALVA01] Alvarion Inc. Official Website,
<http://www.alvarion.com/RunTime/HomePage.asp>
- [BERM01] Berman, Dennis, *Disaster Gives New Life to Wireless Telecom Firms*,
Wall Street Journal, 2001.
- [CABL01] Cable-Modems.Org Official Website, <http://www.cable-modems.org/tutorial/05.htm>
- [DSL01] DSL Reports Official Website, <http://www.dslreports.com/>
- [DSL02] DSL Reports, <http://www.dslreports.com/information/kb/ADSL>
- [DSL03] DSL Reports,
<http://www.dslreports.com/information/kb/DSL/pictures>
- [EART01] Earthlink Inc. Official Website, <http://www.earthlink.com>
- [EART02] Earthlink, <https://register.earthlink.net/cgi-bin/wsisa.dll/broadband/satellite/satellite.html>
- [ELEC01] Electromagnetic Spectrum, available at
http://violet.pha.jhu.edu/~wpb/spectroscopy/em_spec.html
- [INTE01] Intel Processor History,
http://www.intel.com/intel/intelis/museum/exhibit/hist_micro/hof/hof_main.htm

- [KINE01] Kinetic Strategies Inc., Cable Datacom News,
<http://www.cabledatacomnews.com/cm/cmic/cm16.html>
- [KIRB01] Kirby, Ron, *Fiber – Can't Find Its Way Home?*, Network Magazine,
Sept 2001.
- [KURO01] Kurose, James and Ross, Keith, *Computer Networking: A Top-Down
Approach Featuring the Internet*, Addison Wesley, 2001.
- [LIGH01] LightPointe Communications Inc. Official Website,
<http://www.lightpointe.com>
- [LIGH02] LightPointe Frequency Asked Questions,
<http://www.lightpointe.com/index.cfm/fuseaction/technology.faqs>
- [LUND01] Lundy, Bert, *Business Plan for Telecommunications in Mexico*,
unpublished, 2001.
- [NORT01] Nortel Networks Inc. Official Website,
<http://www.nortelnetworks.com>
- [NORT02] Nortel Networks Inc. OPTera 2400,
<http://www.nortelnetworks.com/products/01/optera/metro/2400/faq.html>
- [PARK01] Parkes, Sarah, *Competition in the Last Mile Remains Elusive*, FTD
Telecoms, July 2001.
- [STAL98] Stallings William, *High-speed Networks TCP/IP and ATM Design
Principles*, Upper Saddle River, NJ: Prentice Hall, 1998.
- [TERA01] TeraBeam Networks Inc. Official Website,
<http://www.terabeam.com/hom.html>
- [UNIV01] Universal Internet Inc. Official Website, http://www.universal-net.com/internet_connect.htm
- [WILL01] Willebrand, H.A. and Ghuman, B.S., *Fiber Optics Without the Fiber*,
IEEE Spectrum 38, 8 (Aug. 2001), 40-45.
- [ZHAN01] Zhang, Honggang et al, *Wireless 1394: A New Standard for
Integrated Wireless Broadband Home Networking*, In Proceedings of
the 53rd Vehicular Technology Conference, Vol. 2, IEEE, 2001, pp.
1124-1128.

INITIAL DISTRIBUTION LIST

1. Defense Technical Information Center
Ft. Belvoir, Virginia
2. Dudley Knox Library
Naval Postgraduate School
Monterey, California
3. Engineering and Technology Curricular Office
Naval Postgraduate School
Monterey, CA
4. Dr. Bert Lundy
Department of Computer Science
Naval Postgraduate School
Monterey, CA
5. Dr. James Bret Michael
Department of Computer Science
Naval Postgraduate School
Monterey, CA
6. LCDR John W. Sprague
San Diego, California