

# Woods Hole Oceanographic Institution

---

## **CBLAST-Low 2001 Pilot Study** Mooring Deployment Cruise and Data Report; FV Nobska, June 4 to August 17, 2001

by

Mark Pritchard<sup>1</sup>

Jason Gobat<sup>2</sup>

William M. Ostrom<sup>1</sup>

Jeffrey Lord<sup>1</sup>

Paul Bouchard<sup>1</sup>

Robert A. Weller<sup>1</sup>

<sup>1</sup> Upper Ocean Processes Group, Woods Hole Oceanographic Institution

<sup>2</sup> Applied Physical Laboratory, University of Washington

May 2002

## **Technical Report**

Funding provided by the Office of Naval Research under Contract No. N00014-01-1-0029  
and from the Secretary of the Navy / CNO Chair Grant No. N00014-99-1-0090.

Approved for public release; distribution unlimited.



**Upper Ocean Processes Group**  
**Woods Hole Oceanographic Institution**  
**Woods Hole, MA 02543**  
**UOP Technical Report 2002-02**

20021008 021

WHOI-2002-03  
UOP-2002-02

**CBLAST-Low 2001 Pilot Study**  
**Mooring Deployment Cruise and Data Report;**  
**FV *Nobska*, June 4 to August 17, 2001**

by

Mark Pritchard<sup>1</sup>  
Jason Gobat<sup>2</sup>  
William M. Ostrom<sup>1</sup>  
Jeffrey Lord<sup>1</sup>  
Paul Bouchard<sup>1</sup>  
Robert A. Weller<sup>1</sup>

<sup>1</sup> Upper Ocean Processes Group, Woods Hole Oceanographic Institution

<sup>2</sup> Applied Physical Laboratory, University of Washington

May 2002


**Technical Report**

Funding provided by the Office of Naval Research under Contract No. N00014-01-1-0029 and from the Secretary of the Navy / CNO Chair Grant No. N00014-99-1-0090.

Reproduction in whole or in part is permitted for any purpose of the United States Government. This report should be cited as Woods Hole Oceanog. Inst. Tech. Rept., WHOI-2002-03.

Approved for public release; distribution unlimited.

Approved for Distribution:



Nelson G. Hogg, Chair

Department of Physical Oceanography



## **Abstract**

During the summer of 2001, several moorings and cruises were used as part of the CBLAST-Low (Coupled Boundary Layer Air-Sea Transfer under low wind conditions) pilot experiment in the North Atlantic, south of Martha's Vineyard Island, MA, USA. Six subsurface tide gauges were deployed around the study site for a period of approximately 3 months during the summer of 2001. Further, two surface buoys equipped with meteorological instrumentation and subsurface arrays that measured temperature, conductivity and velocity were deployed during the months of July and August 2001. For a short intensive operating period during July 2001, a newly manufactured three-dimensional mooring designed to sample three-dimensional properties of the upper ocean was deployed for a period of 6 days. During the Intensive Operating Period (IOP) along-shelf and across-shelf conductivity-temperature-depth (CTD) sections were completed as well as a drifting array designed to passively collect data from the upper water column released for approximately 24 hours. This report describes the instrumentation and type of moorings deployed by the Woods Hole Oceanographic Institution Upper Ocean Processes (WHOI UOP) group as well as data return and quality from the CBLAST-Low 2001 pilot study. This is summarized in graphical and tabular form in this report.

## Table of Contents:

## Page No.

Abstract .....	iii
Table of Contents .....	iv
List of Figures .....	vi
List of Tables .....	vii
1. Introduction.....	1
2. Mooring Location and Deployment Timetable.....	3
3. Observations And Instrumentation .....	3
3.1. Tide Gauge Moorings Description and Hardware .....	3
3.1.1. Tide Gauge Deployment .....	8
3.1.2. Tide Gauge Recovery .....	8
3.2. Meteorological Buoys and Subsurface Mooring .....	9
3.2.1. CBLAST-Low Meteorological Buoys and Subsurface Mooring Description and Hardware .....	9
3.2.2. CBLAST-Low Buoy ASIMET Instrumentation.....	10
3.2.3. CBLAST-Low Mooring Deployment.....	13
3.2.4. CBLAST-Low Mooring Recovery .....	14
3.2.5. SecNav Buoy Description and Instrumentation.....	14
3.2.6. SecNav Mooring Hardware, Buoy and Subsurface Mooring Deployment ..	18
3.2.7. SecNav Mooring Hardware, Buoy and Subsurface Mooring Recovery .....	19
3.3. Three-dimensional Net Array Mooring Description.....	20
3.3.1. Three-dimensional Net Instrument Allocation Protocol .....	21
3.3.2. Three-dimensional Net Deployment.....	21
3.3.3. Three-dimensional Net Recovery .....	38
3.4. Long-line Deployments .....	39
3.4.1. Long-line Instrumentation and Hardware.....	39
3.4.2. Long-line Deployment .....	40
3.4.3. Long-line Recovery .....	41
3.5. CTD Surveys.....	42
3.6. ADCP Sled Deployment and Recovery .....	42

4.	CBLAST-Low Cruise And Deployment Chronology .....	43
5.	Data Report .....	44
5.1.	Tide Gauge Moorings Data.....	44
5.2.	CBLAST-Low, SecNav Buoy and Subsurface Array Data .....	47
5.3.	Three-dimensional Net Data .....	53
5.4.	Long-line Data .....	54
5.5.	CTD Survey .....	56
6.	Summary .....	58
7.	Acknowledgements.....	59
8.	References.....	59
9.	Appendices.....	60
9.1	Cruise Participants .....	60
9.2	Manufacturers Instrument Descriptions and Specifications .....	61

## List of Figures:

Figure No.	Page No.
1	Positions of CBLAST-Low moorings during 2001 pilot experiments .....4
2	Schematic diagram of tide gauge mooring hardware .....5
3	Schematic diagram of CBLAST-Low ASIMET mooring .....10
4	Plane and elevation of CBLAST-Low ASIMET buoy tower .....11
5a	Schematic diagram of SecNav surface mooring. ....16
5b	Schematic diagram of SecNav subsurface mooring. ....17
6	Three-dimensional net vertical string array .....22
7	CBLAST-Low three-dimensional net instrument allocation map .....23
8	Photograph of rigging method for Brancker temperature loggers .....24
9	Photograph of rigging method for SBE 37 .....24
10	Plan of FV <i>Nobska</i> fantail and machinery layout .....28
11a	CBLAST-Low three-dimensional net corner mooring and tensioning hardware....29
11b	CBLAST-Low three-dimensional net corner pennant assembly .....29
12	Pre-deployment loading on FV <i>Nobska</i> .....30
13a	Schematic flow diagram of deployment procedure for three-dimensional net.....33
13b	Schematic flow diagram of deployment procedure for three-dimensional net.....34
13c	Schematic flow diagram of deployment procedure for three-dimensional net.....35
13d	Schematic flow diagram of deployment procedure for three-dimensional net.....36
14	Three-dimensional net array fully deployed with instrumentation.....37
15a-c	Time series plots of tidal elevation, temperature and salinity .....45
16a,b	Time series plot of towed tide gauge sea surface elevation and conductivity cell ...46
17a,b	Standard meteorological measurements recorded by ASIMET .....48
18	Air-sea fluxes during July-August 2001 deployment .....49
19	Temperature time series data during 2001 pilot experiment .....50
20a,b	Standard meteorological measurements during 2001 deployment .....51
21	Air-sea fluxes during 2001 deployment period .....52
22	Calibrated time series data during 2001 pilot experiment IOP .....53
23	Velocity vector components during 2001 pilot experiment IOP .....54
24	Velocity vector components during 2001 pilot experiment IOP .....55
25	Temperature time/spatial series during 2001 pilot experiment IOP .....55
26	Driving buoy and long-line track during 2001 pilot IOP .....56
27	Geographical location of CTD transects during 2001 IOP .....57
28	Example of CTD survey record during 2001 IOP .....57

## List of Tables:

<b>Table No.</b>		<b>Page No.</b>
1	Mooring type, duration of deployment and geographical position.....	6
2	Summary details of SeaBird SBE 26 tide gauge moorings .....	7
3	Subsurface instrumentation details .....	12
4	ASIMET instrument specifications and mounting heights .....	13
5	SecNav buoys subsurface instrumentation sampling rates .....	15
6a	Three-dimensional net and instrument allocation.....	25
6b	Three-dimensional net and long-line instrument types and sampling rates.....	26
6c	Positions of the vertical strings on three-dimensional net .....	26
7	Geographical positions of three-dimensional net array corner anchorages .....	37
8	Long-line instrumentation details .....	40
9	CTD chronology and survey type .....	42
9-1	Manufacturers specification of instruments.....	61

## 1. Introduction

The long range goal of the Office of Naval Research (ONR) Coupled Boundary layer, Air-Sea Transfer Experiment in Low to Moderate Winds (CBLAST-Low) is to understand air-sea interaction and coupled boundary layer dynamics at low to moderate wind speeds. The site chosen for the study was in the North Atlantic, South of Martha's Vineyard Island, Cape Cod, Massachusetts, USA.

To achieve the CBLAST-Low objectives, the study has been split into a collaborative effort where specialized groups of investigators concentrate their expertise and resources on specific aspects of the investigation. Hopefully this will eventually lead to a better overall understanding and quantification of the dominant physics responsible for the exchange or flux processes active in air-sea exchange under a low wind regime.

This report focuses on the deployments, instrumentation and mooring efforts of the Upper Ocean Processes group (UOP) in the oceanic component of the CBLAST-Low 2001 pilot study. The aim was to explore the temporal and spatial variability in the upper ocean mixed layer in low wind conditions on temporal and spatial scales ranging from minutes to months and meters (m) to kilometers (km), respectively. Additional emphasis was also put into the testing and feasibility of some new and conceptual ideas for oceanographic data collection.

The 2001 deployments for the CBLAST-Low pilot study were completed on several different cruises and consisted of different kinds of instrumentation and mooring arrangements to achieve the goals of CBLAST-Low. This included the trial of new mooring array designs to be used in the Intensive Operating Period (IOP) of the CBLAST- Low 2002 field experiments.

The general experimental design, which was reflected in the mooring types and positions, is aimed at providing data on local atmospheric forcing and oceanic variability. Data on meteorological conditions comes from the ASIMET (Arabian Sea IMET, reflecting a significant hardware upgrade made prior to the Arabian Sea program) systems mounted on two buoys, which provided hourly data that was transmitted via ARGOS or ORBCOMM.

One surface buoy was deployed specifically for CBLAST-Low and is referred to as the 'CBLAST-Low ASIMET buoy'. The second buoy was deployed for Weller's Secretary of the Navy/CNO chair and was deployed during the pilot experiment for further testing. This buoy is called the 'SecNav buoy'. A companion subsurface mooring was deployed next to the SecNav surface mooring.

The meteorological data included surface long and short wave radiation, relative humidity, air temperature, wind speed and direction, barometric pressure, precipitation, sea surface temperature and salinity. These measurements enabled the computation of air-fluxes through the Tropical Ocean Global Atmosphere-Coupled Ocean-Atmosphere Response Experiment (TOGA-COARE) 2.6b bulk algorithms. In addition, subsurface hydrographic data including sea-surface height, temperature and conductivity from tide gauges and velocity, temperature, conductivity and pressure through most of the water column at the buoy sites were collected to study the oceans vertical structure at the study site.

A new mooring design comprising of a buoyant 2-dimensional square net or a mesh platform was deployed during the CBLAST-Low IOP. The mooring was used to suspend vertical arrays to record temperature, conductivity, pressure and velocity at various depths. This mooring provided three-dimensional information on the temporal and short spatial variability of the upper ocean.

Other instrumentation was a long-line drifting array designed to measure surface variability over kilometer scales.

This report describes the mooring types, instrumentation, deployments and recoveries carried out by the UOP group and the chronological account of the CBLAST-Low 2001 pilot experiments. The report concludes with a brief data report and synopsis of all the CBLAST-Low cruises during 2001.

## **2. Mooring Location and Deployment Timetable**

The CBLAST-Low pilot experiment consisted of a series of deployments/recoveries of moorings from June 4, 2001, to August 17, 2001, plus an IOP. During the IOP, July 18–26, 2001, an additional temporary short-term mooring and a drifting array were deployed and recovered. Figure 1 shows a map of the study area with depth contours and the positions of moorings deployed by UOP during the 2001 pilot study.

Timing of the IOP was set to coincide with other efforts from CBLAST-Low participants that included remote sensing using the Long EZ aircraft platform, acquisition of passive and active Satellite imagery (e.g. AVHRR, IR and SAR) and other ship-borne measurements of air-sea flux parameters and meteorology. A summary of all moorings deployed during the CBLAST-Low pilot study is shown in Table 1. The table describes the type of mooring, instrumentation, positions, times and duration of deployment and recovery.

All mooring deployments and fieldwork with the exception of the SecNav buoy deployment were conducted from *FV Nobska*, a fishing vessel chartered from Stommel Fisheries Inc. The generalized deck layout can be seen in Figure 8 in the three-dimensional net deployment and recovery section.

## **3. Observations and Instrumentation**

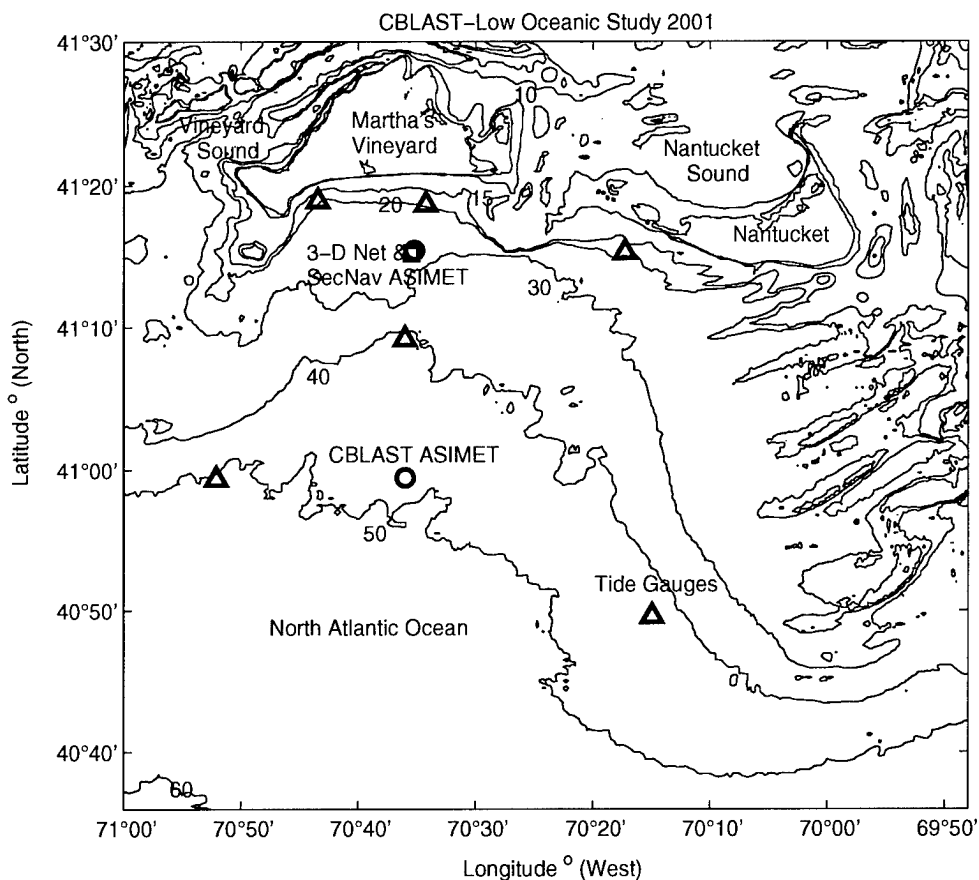
### **3.1 Tide Gauge Mooring Description and Hardware**

As part of the subsurface hydrographic study, 6 SeaBird tide gauges (model SeaBird SBE 26) were deployed around the CBLAST-Low study area. Each tide gauge recorded water temperature, conductivity and pressure approximately one meter off the seabed at 10-minute time increments. Using these measurements and the hydrostatic relation of pressure and density it is possible to compute sea surface height above the seabed. Table 2 shows the deployment details of each respective tide gauge mooring.

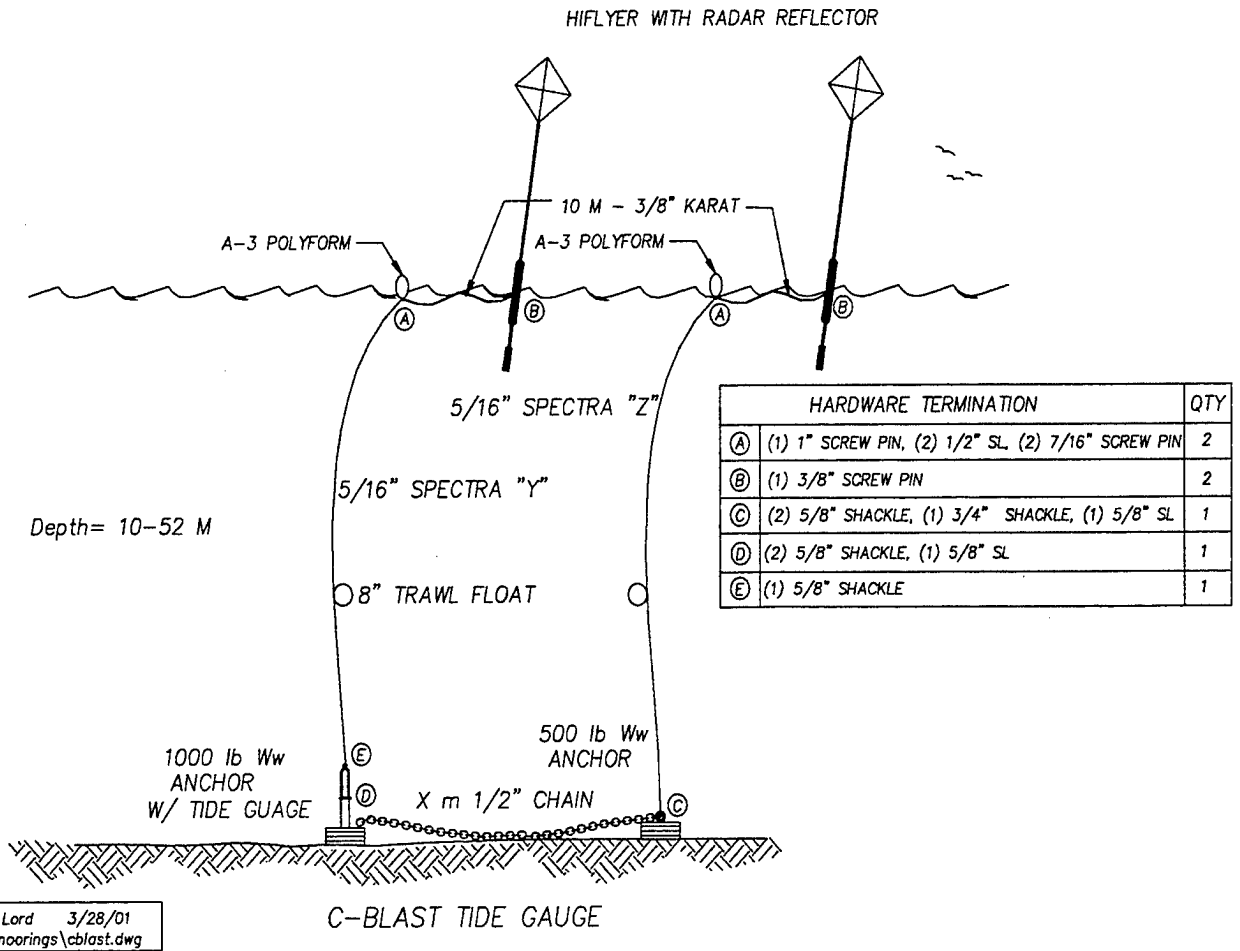
Heavy fishing activity in the survey area, and concerns about potential instrument loss, dictated the stout and robust mooring system used for the tide gauge deployments. Redundant surface expressions, and a ground chain were used to reduce the risk (see

Figure 2). In addition, surface floats and high flier radar reflectors mimicked popular fishing gear in an attempt to reduce tampering.

Each tide gauge instrument was mounted to a steel housing bolted to a 1000 lb. cast steel anchor. A surface line of 5/16" SPECTRA (9,000 lb breaking strength) was attached from the instrument frame to an A-3 polyform float. A 10 m tether ran from the float to a high flier radar reflector.



**Figure 1:** Map of North Atlantic, south of Martha's Vineyard showing the positions of the CBLAST-Low moorings during the 2001 pilot experiments.



**Figure 2:** Schematic diagram of the tide gauge mooring hardware used during the CBLAST-Low 2001 pilot study.

**Table 1:** Mooring type, duration of deployment and geographical position of each mooring deployed during UOP's CBLAST-Low 2001 pilot experiment.

<b>Mooring</b>	<b>Instrumen- tation</b>	<b>Instru- ment Serial #s</b>	<b>Geograph- ical Position</b>	<b>Deploy- ment Time/ Date (UTCZ)</b>	<b>Recovery Time/ Date (UTCZ)</b>	<b>Depth (m)</b>
Tide Gauge (subsurface)	Seabird SBE 26 + Conductivity Cell	0047 041181	41°18.940'N 70°43.522'W	17:54 6/4/01	15:00 8/16/01	17.5
Tide Gauge (subsurface)	Seabird SBE 26 + Conductivity Cell	0043 041166	41°18.681'N 70°34.259'W	19:16 6/4/01	16:21 8/16/01	17.5
Tide Gauge (subsurface)	Seabird SBE 26 + Conductivity Cell	0041 041163	41°15.303'N 70°17.288'W	21:20 6/4/01	21:00 8/16/01	16.5
Tide Gauge (subsurface)	Seabird SBE 26 + Conductivity Cell	0045 041183	41°09.166'N 70°36.026'W	10:04 6/5/01	00:10 8/17/01	40.0
Tide Gauge (subsurface)	Seabird SBE 26 + Conductivity Cell	0049 041625	40°59.327'N 70°52.097'W	08:05 6/5/01	Presumed Missing	49.0
Tide Gauge (subsurface)	Seabird SBE 26 + Conductivity Cell	0046 041184	40°49.590'N 70°14.960'W	04:05 6/5/01	01:10 8/17/01	40.5
CBLAST ASIMET	ASIMET+subsur -face vertical array	See Table 4	40°59.475'N 70°35.846'W	01:40 7/18/01	08:00 8/17/01	47.0
SecNav ASIMET	ASIMET+subsur -face vertical array		41°15.43'N 70°35.23'W	15:00 7/30/01	12:00 8/17/01	27.0
3-D Net Array	See Table 6a	See Table 6a	41°15.235'N 70°35.471'W	16:30 7/21/01	09:30 7/26/01	27.0
DRIFTAR &Long-line	See Table 6a & Table 8	Table6& Table 8	41°18.94'N 70°43.522'W	0300 7/22/01	00:40 7/23/01	25.0

**Table 2:** Summary details of SeaBird SBE 26 tide gauge moorings during CBLAST-Low 2001 pilot study.

<b>Tide Gauges</b>	<b>Instru- ment Serial #s</b>	<b>Geographical Position</b>	<b>Deploy- ment Time/ Date (UTCZ)</b>	<b>Recovery Time/ Date (UTCZ)</b>	<b>Samp- ling Rate (secs)</b>	<b>Depth</b>
Seabird SBE 26 + Conductivity Cell	0047 041181	41°18.940'N 70°43.522'W	17:54 6/4/01	15:00 8/16/01	600	17.5
Seabird SBE 26 + Conductivity Cell	0043 041166	41°18.681'N 70°34.259'W	19:16 6/4/01	16:21 8/16/01	600	17.5
Seabird SBE 26 + Conductivity Cell	0041 041163	41°15.303'N 70°17.288'W	21:20 6/4/01	21:00 8/16/01	600	16.5
Seabird SBE 26 + Conductivity Cell	0045 041183	41°09.166'N 70°36.026'W	10:04 6/5/01	00:10 8/17/01	600	40.0
Seabird SBE 26 + Conductivity Cell	0049 041625	40°59.327'N 70°52.097'W	08:05 6/5/01	Presumed Missing	600	49.0
Seabird SBE 26 + Conductivity Cell	0046 041184	40°49.590'N 70°14.960'W	04:05 6/5/01	01:10 8/17/01	600	40.5

A ground chain (1/2" proof coil) equal to 2 times water depth was attached to the 1000 lb anchor, and ran laterally on the sea floor to a 500 lb cast steel anchor. Another surface line of SPECTRA, polyform float, and high flier were attached to this anchor.

This configuration allowed instrument recovery from either surface float. In the event that both surface lines were destroyed, dragging a hook between the two anchors would allow recovery by the ground chain.

As an additional safety measure, whenever possible the tide gauges were deployed near known wrecks. As a general rule, fishing activity is reduced in these areas.

### *3.1.1 Tide Gauge Deployment*

All 6 tide gauges were deployed from the FV *Nobska* during June 6-7, 2001. The procedure used for deploying a tide gauge was to first wind one surface line and one ground chain on the vessel's winch drums. The first high flier, tether, A-4 polyform float and surface line were deployed by hand from the stern of the vessel. Following this, the 500 lb anchor was eased over the stern ramp and lowered to the bottom by the ground chain on the winch. Next, the tide gauge and anchor were eased over the stern and lowered by the second surface line, also on the winch. Once the anchor was on the bottom the polyform float and high flier were attached to the slack line and tossed over the stern. The geographical positions of both the tide gauge and 500 lb anchor were accurately recorded so as to aid recovery and if necessary dragging for the mooring in the event of losing the surface expressions.

### *3.1.2 Tide Gauge Recovery*

The tide gauges were recovered on August 16-17 by approaching the surface expressions and high flier arrangement and then grappling for the line between the A4-polyform floats. This line was then brought through the A-frame at the stern of the ship. After detaching the high flier and polyform floats the SPECTRA line was attached and wound on the rear drum of the ship. The line was then wound up on the drum and the tide gauge recovered. Once the tide gauge was on board and secured. The ground chain was detached from the tide gauge anchor and wound up on the drum effectively recovering the 500 lb anchor.

One of the six instruments was never found (see Table 1) and was presumed dragged up by fishing activity. One other tide gauge had one of the surface lines cut, and another had both lines cut. This mooring was recovered by dragging the seabed with grapples and then hauling up the recovered ground chain on the rear drum. Most of the recovered mooring hardware from the tide gauge experiments was in good condition and serviceable for future deployments.

### **3.2 Meteorological Buoys and Subsurface Mooring**

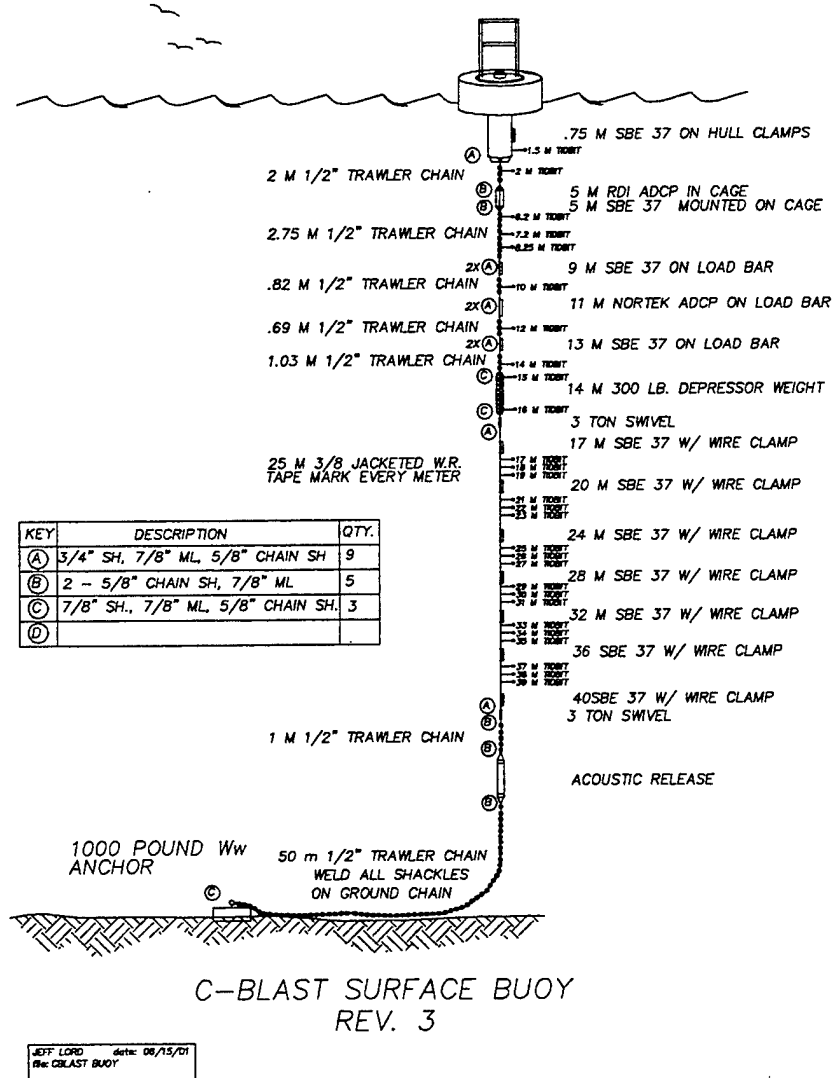
Three buoy systems provided additional environmental data during the study period. Two surface buoys were used to provide meteorological and subsurface hydrographic data. A third subsurface mooring that was instrumented to within 2 m of the seabed provided near real time hydrographic data via an acoustic modem to the surface.

Both surface moorings used existing small buoys, adapted for the ASIMET systems, and modified to meet mooring and subsurface instrument requirements.

#### *3.2.1 CBLAST-Low Meteorological Buoys, Subsurface Mooring Description and Hardware*

The CBLAST-Low ASIMET buoy was constructed from a modified SAR buoy well/bridle and hull. The buoy's well was reconfigured to house one of the new generation ASIMET data loggers and batteries. The buoy tower was constructed from aluminum stock and was designed for low interference between ASIMET sensor modules that were mounted on the tower.

The CBLAST-Low mooring system (Fig. 3), deployed in 47 m of water, used segments of 1/2" chain to cluster instruments for the top 14 m of the mooring. Instruments were installed in cages or mounted to load carrying 'tension bars' between sections of chain. A 300 lb depressor weight was installed at 14 m to maintain a near vertical attitude for current meter profiling. Below the depressor weight, 3/8" wire rope was used to within 5 m of the sea bed. Instruments were clamped to the wire for ease of handling and reduced hardware cost. An acoustic release was used to aid in recovery. Below the release, 50 m of 1/2" trawler chain was used as a damper.



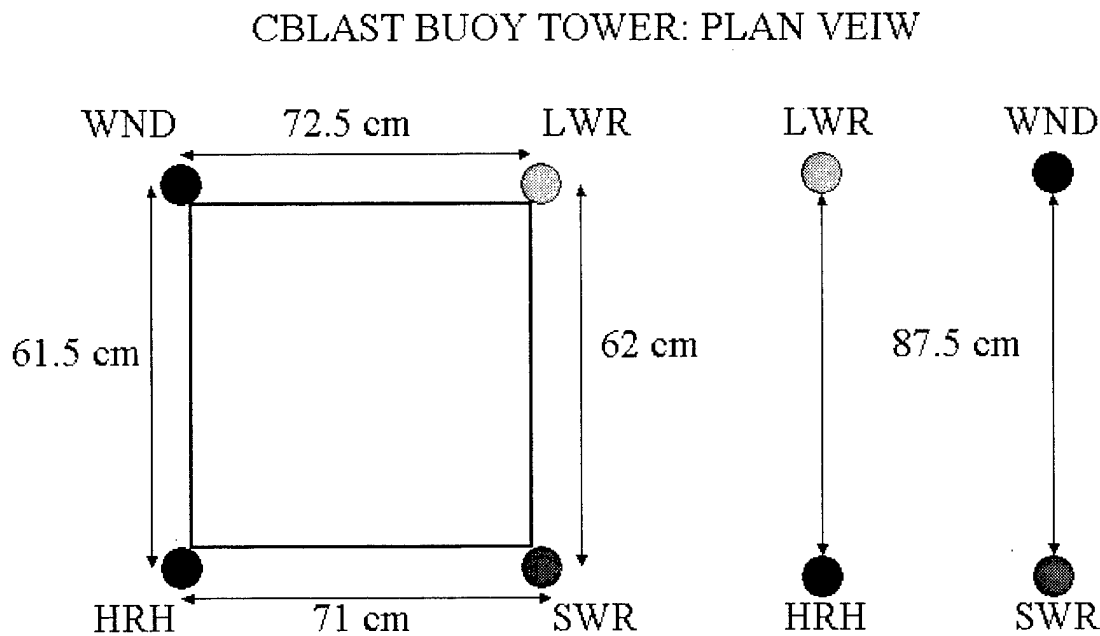
**Figure 3:** Schematic diagram of CBLAST-Low ASIMET mooring configuration showing the relevant components of hardware used to build the mooring. See Table 3 and Table 4 for a detailed description of instrumentation mounted on the mooring.

### 3.2.2 CBLAST-Low Buoy ASIMET Instrumentation

Table 4 catalogues the mounting heights of each type of ASIMET module on the CBLAST-Low buoy tower and buoy bridle. During the IOP, hourly averaged meteorological data from ARGOS transmissions were used to continually update the CBLAST-Low study area meteorological conditions posted on the UOP CBLAST-Low website. An additional subsurface transmitter was fitted to the bridle of the buoy that

would be automatically activated in the event of the buoy losing the anchor and capsizing. This would allow tracking and recovery. Fig 4 shows the arrangement of the ASIMET modules on the buoy tower.

The CBLAST-Low subsurface mooring was designed to provide relatively high-resolution vertical profiles of velocity (1 m and 0.2 m bins), temperature (1 m) and conductivity (4 m) in the top 40 m of the water column throughout the duration of its deployment. Table 3 describes the instrumentation, instrument logging rates and the relative vertical position of instrument or sensor used during the 2001 experiments.



**Figure 4:** Plan and elevation of CBLAST-Low ASIMET buoy tower and instrument configuration.

**Table 3:** CBLAST-Low 2001 pilot experiment subsurface instrumentation details.

Depth (m)	Instrument	Sampling Rate (sec)	Serial Number
41	SBE37	30	1912
40	Tidbit	600	221
39	Tidbit	600	212
38	Tidbit	600	210
37	SBE37	30	1908
36	Tidbit	600	208
35	Tidbit	600	182
34	Tidbit	600	180
33	SBE37	30	1907
32	Tidbit	600	160
31	Tidbit	600	159
30	Tidbit	600	158
29	SBE37	30	1900
28	Tidbit	600	153
27	Tidbit	600	142
26	Tidbit	600	136
25	SBE37	30	1906
24	Tidbit	600	126
23	Tidbit	600	119
22	Tidbit	600	118
21	SBE37	30	1910
20	Tidbit	600	117
19	Tidbit	600	100
18	Tidbit	600	95
17	SBE37	30	1905
16	Tidbit	600	83
15	Tidbit	600	56
14	Tidbit	600	50
13	SBE37	30	1899
12	Tidbit	600	49
11	Nortek	600	AQP 0274
10	Tidbit	600	35
9	SBE37	30	1903
8	Tidbit	600	30
7	Tidbit	600	29
6	Tidbit	600	26
5	SBE37 RDI	30/300	1901/1825
4	Tidbit	600	16
3	Tidbit	600	14
2	Tidbit	600	2

**Table 4:** CBLAST-Low 2001 pilot experiment buoy ASIMET instrument specifications and mounting heights.

Sensor Type	Serial Number	Height from Buoy Deck
Long Wave Radiation	LWR 205	182.5 cm
Short Wave Radiation	SWR 502	183 cm
Wind Speed & Direction	WND 344	173 cm
Barometric Pressure	BPR 504 Heise	136 cm
Precipitation	PRC 502	155 cm
Relative Humidity/Air Temperature	HRH 502	182.5 cm
Sea Surface Temperature	SBE-37 S/N:1835	119.5 cm (below buoy deck)
SIS PTT Argos Transmitter	ID#34338	
ARGOS PTT Transmitter	ID#14644	
	14652	
	14653	

### 3.2.3 CBLAST-Low Mooring Deployment

The buoy and subsurface array was deployed on July 19, 2001, and recovered on August 17, 2001. The FV *Nobska* was used for both deployment and recovery. Deployment of this system required hanging the depressor weight and all instruments from 14 m to the surface in the water prior to putting the surface buoy in the water. The 3/8" wire rope, with instruments attached, led from the bottom of the depressor back up to the vessel. With the first 15 m of the mooring attached, the buoy was lifted and swung out over the side of the vessel using the boom crane. The load of the 14 m of mooring components in the water was transferred to the buoy before it was set in the water. This load provided additional stability for the buoy during deployment.

Once the buoy was released in the water, it drifted astern and the rest of the instrumented mooring wire was paid out by hand. At the end of the wire, the acoustic release was attached and eased down the stern ramp. The 50 m of ground chain was faked out on the deck and tied to a chain fixed on the 'fish chute'. Cutting the stopper lines tied into the chain allowed sections of the chain to be parceled out during the deployment. A 750 lb anchor was attached to the chain and slipped over the stern using the outhaul block on the vessel.

### 3.2.4 CBLAST-Low Mooring Recovery

The recovery of the buoy proved a straightforward operation. The acoustic release was contacted through the deck transponder and then released. The buoy was then grappled and a snap hook attached to one of the bails on top of the buoy's hull. The buoy was then lifted out of the water with the boom winch and brought over onto the FV *Nobska's* deck. The subsurface mooring was stopped off below the buoy and the buoy was then detached from the rest of the mooring. Once the buoy was safely stowed, the upper chain section of the mooring was retrieved in several bites, removing instrumentation until the depressor weight was removed and stowed onboard. At this point a cable from one of the ship's galleys winch was attached to the mooring wire through a pulley at the stern of the ship and the rest of the mooring retrieved in bites, removing various bolt-on instrumentation along the way. Finally the acoustic release was reached and man handled onboard the vessel.

### 3.2.5 SecNav Buoy Description and Instrumentation

The SecNav observing system consists of a surface and subsurface mooring pair deployed side-by-side. Instrument specification and serial numbers are given in Gobat *et al.* (2001). This arrangement allows the entire water column to be instrumented with simple, easy to deploy mooring configurations. All instruments in the SecNav system log good high-resolution time series data. Additionally, the mooring line instruments periodically report averaged data to the buoys via inductive modems. On the subsurface mooring, this averaged data is sent to the surface buoy using an acoustic modem. Inductively coupled mooring line instrumentation includes conductivity, temperature, and pressure sensors, acoustic current meters, and optical backscattering and absorption sensors. In addition to mooring line instruments, the surface buoy collects averaged data from meteorological sensors, including wind speed and direction, barometric pressure, relative humidity, air temperature, precipitation, longwave and shortwave radiation, sea surface temperature and conductivity, and wave height and period. Data from both mooring lines and from the surface meteorological sensors is telemetered to shore via line-of-sight radio and satellite.

The mechanical platforms, instrumentation, telemetry system, and control electronics and software are described in detail in (Gobat *et al.*, 2001). That report documents the system as it was deployed during Kernel Blitz 2001, a U.S. Navy fleet exercise off California in March 2001. The system deployed for CBLAST-Low in August 2001 was slightly different than that initial deployment. Those differences are described below.

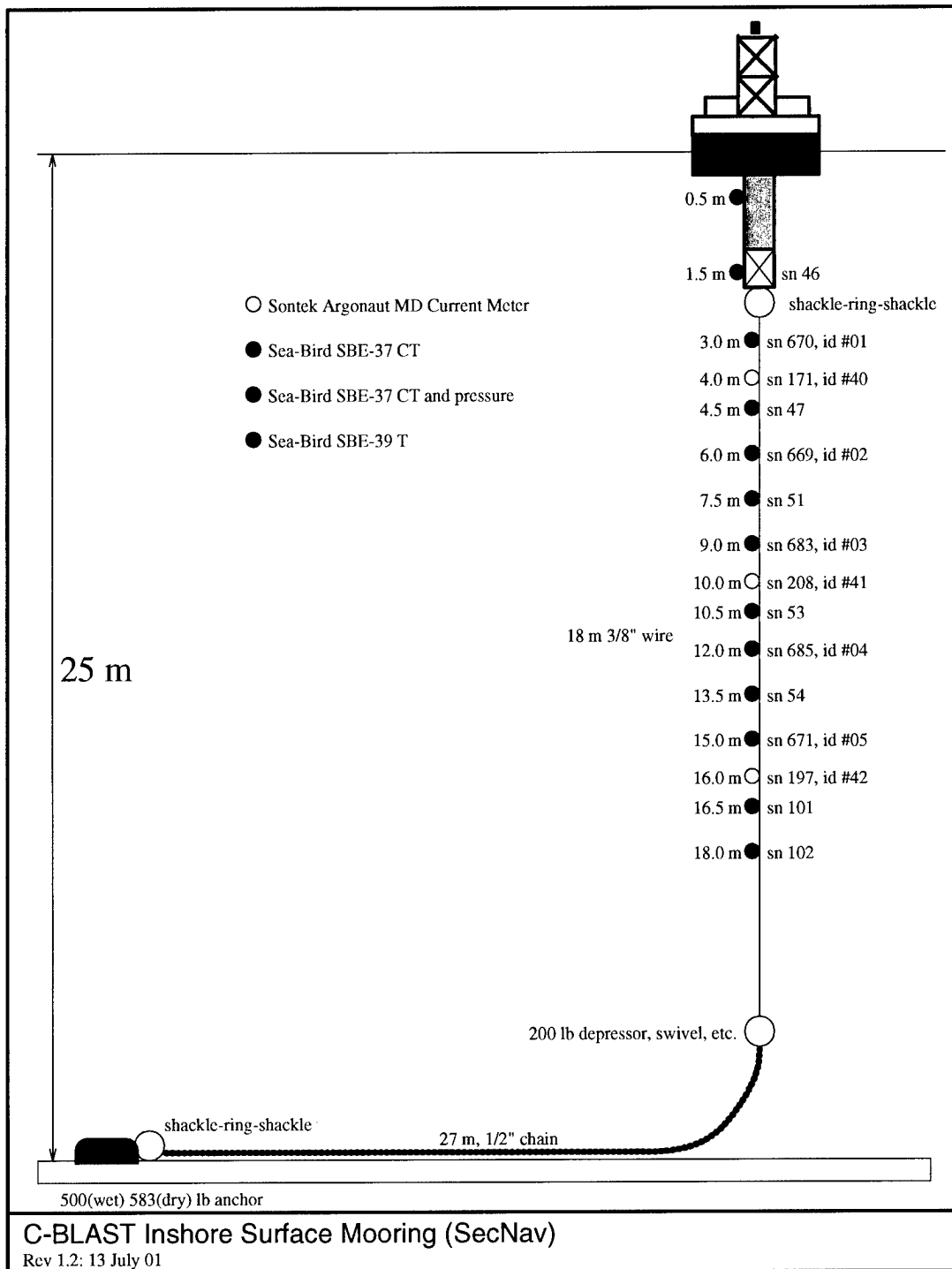
Moorings diagrams for the surface and subsurface systems are shown in Fig 5a and Fig 5b. The moorings were deployed on 30 July 2001 at approximately 1500 UTC. The anchor for the surface mooring was dropped at 41°15.43'N, 70°35.23'W in approximately 27 m of water. The subsurface mooring was set approximately 40 m east of this location. All instrument-sampling rates deployed on the SecNav surface and subsurface moorings are shown in Table 5.

**Table 5:** SecNav buoys subsurface instrumentation sampling rates during the CBLAST-Low 2001 pilot experiment.

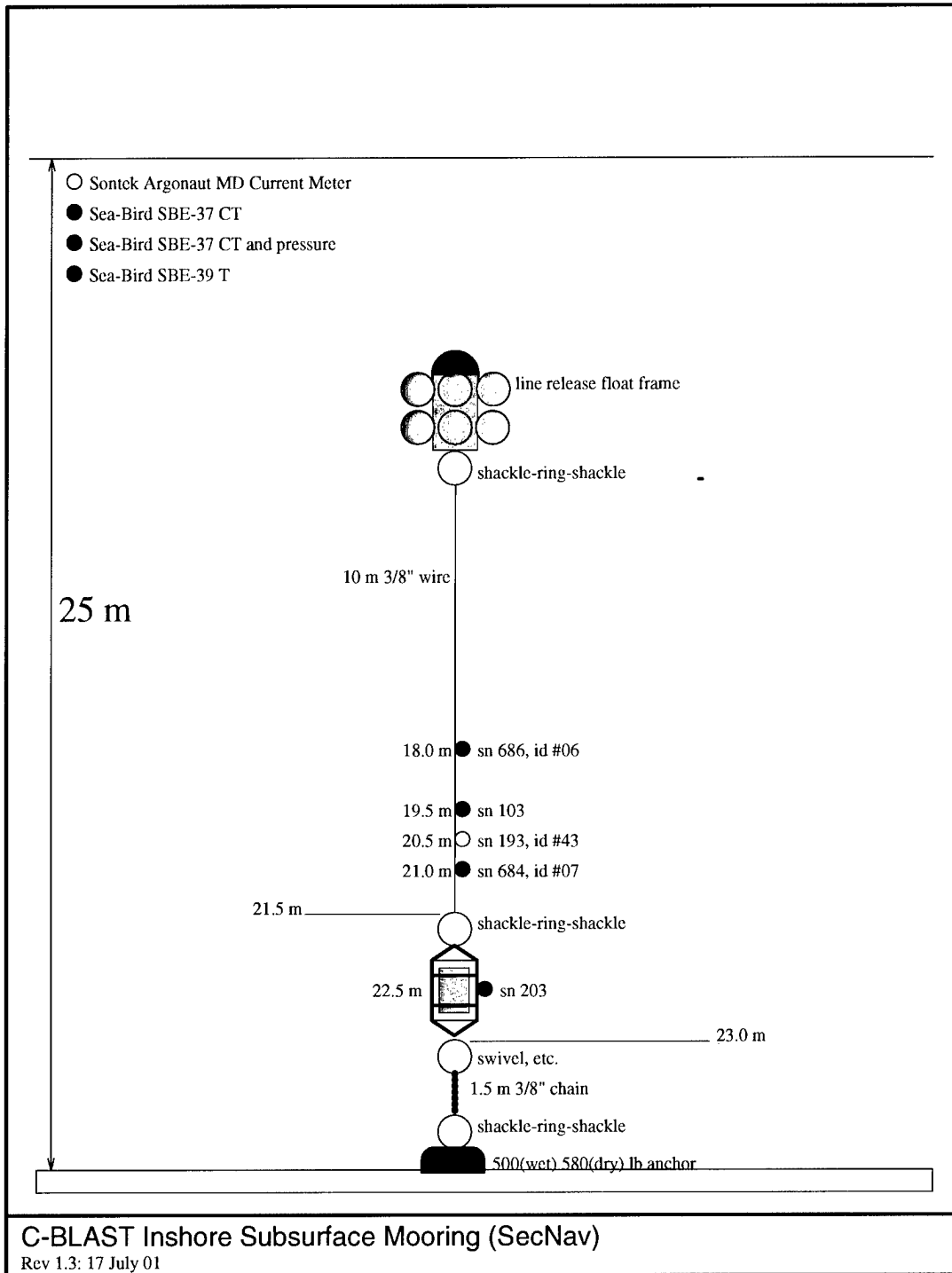
Instrument	Sampling Rate (seconds)
SeaBird SBE 37	30
SeaBird SBE 39	30
Sontek Argonaut ADCM	60

Compared to the Kernel Blitz configuration, the a-Beta optical instruments were not deployed and an additional Sontek Argonaut-MD acoustic doppler current meter was deployed on the surface mooring. Also, the acoustic modems were LinkQuest UWM-2000s rather than WHOI UAMs. Radio telemetry was not used; wireless telemetry from the surface buoy was via ORBCOMM only.

Because the UWMs have a vertical beam pattern of 35° off the vertical, the moorings were deployed as close as practically possible to one another. However, the large scope catenary configuration of the surface mooring precludes the possibility of the surface and subsurface UWMs always being acoustically visible to one another. Even after relocating the subsurface electronics frame and UWM to the bottom of the mooring (1.5 m above the anchor) to improve the angle to the surface, the configuration is not ideal.



**Figure 5a:** Schematic diagram of SecNav surface mooring



**Figure 5b:** Schematic diagram of SecNav subsurface mooring.

Only 8 of 403 possible transmissions from subsurface to surface were received. The successful transmissions occurred during a period when both the current and the wind had relatively strong components toward the east, likely pushing the surface mooring into a more favorable position relative to the subsurface.

The ORBCOMM transceiver was a Panasonic KX-G7101 Data Communicator with built-in GPS receiver. The antenna was a Tecom Tophat VHF/GPS combination, model 508044. RF interference coming from the ASIMET modules on the buoy tower required some trade-offs in antenna position and ground plane selection. The antenna was mounted without a ground plane near the top of a fiberglass pole that runs from just outside the buoy endcap to the outside of the guard ring around the upper instruments. This placed the antenna away from many of the modules and the pole provided a path (also away from modules) down which to run cables.

In testing, this configuration resulted in an acceptable satellite acquisition rate. As deployed, however, there were gaps when no hourly transmissions were received. In part, this may be due to the control system only giving the ORBCOMM communicator 20 minutes to clear its queue before going to sleep until the next wake cycle. However, it is also very likely due in part to the poor antenna placement and residual RF interference. The communicator's built-in buffering does mitigate the effect of these gaps, as all of the data was eventually being received.

Through the full deployment 175 of 405 hourly messages were received on time. Of the 230 other messages the average latency between the sample time and receive time was 4 hours. These latent messages occurred during 61 periods in which at least one hourly transmission was missed. Fifty-three of these gaps lasted 6 hours or less. The maximum gap between received messages was 13 hours.

### *3.2.6 SecNav Mooring Hardware, Buoy and Subsurface Mooring Deployment*

The SecNav surface buoy, and subsurface system was deployed on July 30, 2001, using WHOI's smallest research vessel, the RV *Asterias*. An earlier attempt to deploy these moorings was aborted due to severe weather conditions.

The lightweight surface mooring was fully instrumented and connected from the buoy to the anchor termination, prior to deployment operations. The 27 m section of 1/2"

chain was wound on the vessel's winch. The buoy was positioned at the stern of the vessel, and the 500 lb anchor was positioned on a 'tip plate,' also on the stern. To begin the deployment sequence, the buoy was lifted off the deck and held steady with tag lines. Several meters of the instrumented mooring wire were paid out by hand prior to setting the buoy in the water and releasing it. As the buoy drifted behind the vessel, the rest of the instrumented wire was paid out by hand. At the end of the instrumented wire was a 200 lb depressor weight used for stability in the mooring. This depressor weight was lifted over the stern with a quick release on the boom crane. As weight entered the water, the load was transferred to the chain on the mooring winch. Once the load was transferred, the weight was released from the boom crane. The 1/2" chain was paid out with the mooring winch and stopped off with about two meters of slack at the end. The slack end of the chain was shackled to the anchor on the tip plate.

As the vessel approached the targeted mooring location, the load from the mooring was transferred to the anchor using a slip line. Using the boom crane attached to the tip plate, the anchor was deployed over the mooring site.

The subsurface mooring was very light and easy to handle. All instrumentation and mooring components were assembled prior to the start of deployment. The 300 lb anchor was positioned on the tip plate at the stern. As the vessel approached the target location, two people lifted the float/recovery package over the port rail and dropped it in the water. As the float drifted aft, instrumented wire was paid out. The instrument cage with controller and acoustic modem was eased over the stern, and the entire mooring was towed to the predetermined mooring site. Once at the site, the anchor was tipped in using the boom crane. The entire operation took less than 3 minutes.

### *3.2.7 SecNav Mooring Hardware, Buoy and Subsurface Mooring Recovery*

The recovery of the SecNav moorings was made from FV *Nobska* on August 17, 2001. The recovery procedure follows that of the CBLAST-Low buoy. However, on this occasion the ground chain and anchor was also recovered. The SecNav subsurface mooring was recovered by first releasing the recovery package via the acoustic deck transmitter and then grappling the small buoy onto the deck. The SPECTRA line released from the recovery package was then fed through one of the rear pulleys on the A-frame of

the FV *Nobska* and wound up by the gallows winch. Instrumentation was removed from the mooring's wire as the wire was progressively wound onboard. The anchor was then brought onboard and stowed.

### 3.3 Three-Dimensional Net Array Mooring Description

The concept of the three-dimensional mooring was to provide a coherent framework or base from which vertical arrays of instrumentation could be suspended to simultaneously measure physical properties of the upper ocean in three-dimensional space and time. Thus, this arrangement of instrumentation has the potential to provide a unique perspective of the active physics and processes in the upper water column.

The three-dimensional net array was designed and built by Matt Stommel of Stommel Fisheries, Inc. Associated hardware and flotation was fabricated and provided by the WHOI Rigging Shop.

The mooring's total dimensions were 183 m  $\times$  183 m (600'  $\times$  600'), constructed as a 20 $\times$ 20, 9 m  $\times$  9 m (30' $\times$ 30') mesh from 1/2" Novatec foam core rope. This provided a total of 400 nodes within its perimeter where vertical arrays of instrumentation could be attached. Each node was marked with a brass identification tag in an organized 'roadmap' style grid system. This facilitated experimental design, instrument allocation and position in the grid. Correct identification of each node was paramount to the success of the mooring deployment and critical to the analysis of the data set.

The net's outer framework was constructed from 1-1/8" Novatec Blue steel poly-steel 12 grade rope that was interwoven with the outer border of the integral lighter weight mesh. This effectively gave some rigidity and strength to the mooring once it was deployed. Each net corner was fitted with a thimble for attachment to steel flotation balls and anchor system.

Vertical 'string arrays' were used to attach self-logging instrumentation such as temperature recorders (also marked with identification tags) to pre-selected grid points on the mooring. The vertical arrays were fabricated from monofilament long-line fishing line. Each 'string' was 25m long with a loop for instrument attachment every meter and small 'sinker' to keep the line vertical once deployed. At the surface, 2-8" floats with a

buoyancy of approximately 16 lbs were attached to each string so as to support some of the heavier temperature or temperature/conductivity recorders. During the deployment phase, the vertical strings were fastened to the net by a simple standard long-line clip and secured with a plastic cable tie. An artist's impression of a three-dimensional net vertical string is shown in Fig 6.

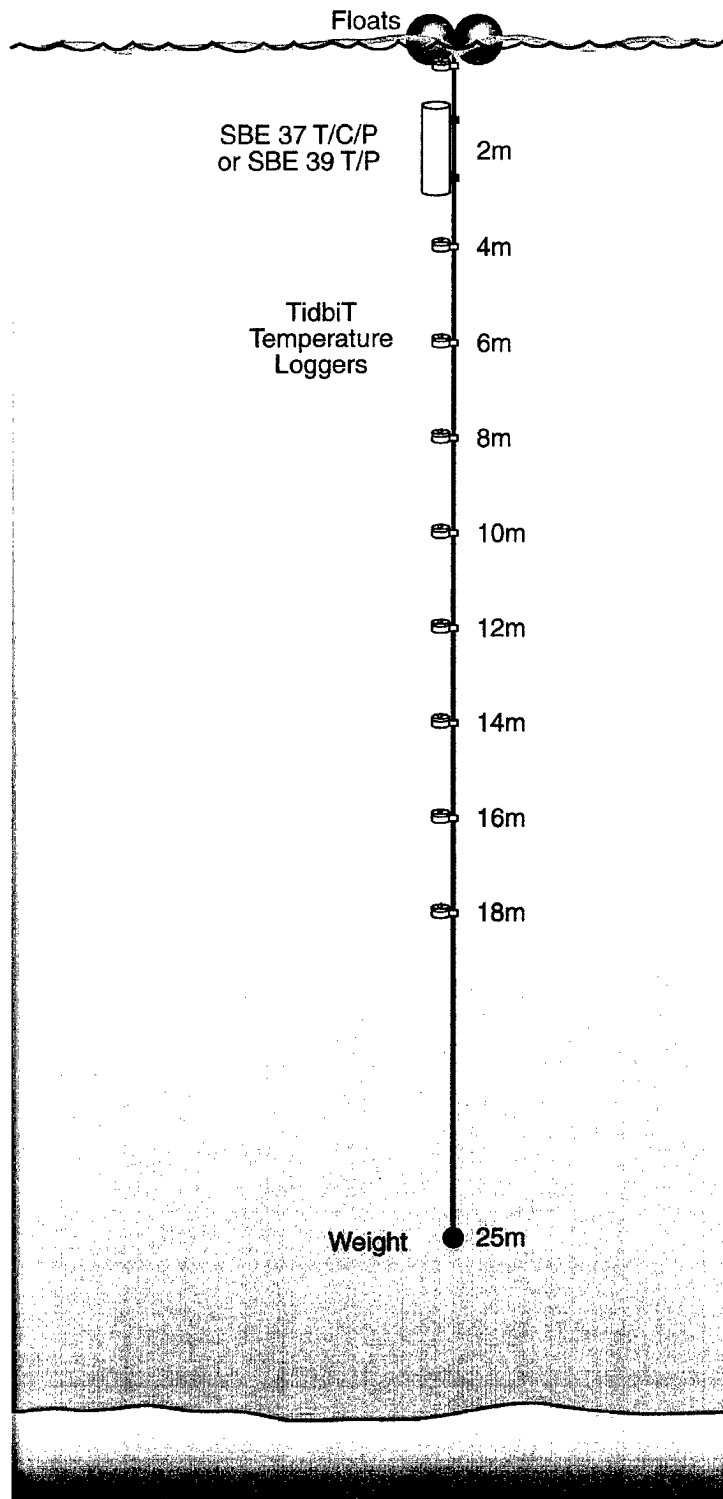
### *3.3.1 Three-Dimensional Net Instrument Allocation Protocol*

The aim of the three-dimensional net experiment was to map the temporal and spatial response of the upper ocean on scales of meters under low to moderate wind conditions. Therefore, to provide the necessary horizontal and vertical resolutions to reach this goal within the 'control' volume of the net required an abundance of instrumentation. The majority of the instruments used on the three-dimensional net mooring were made up of the small and robust Onset Tidbit temperature recorders. The remainder included SeaBird SBE 37, temperature/conductivity recorders, SeaBird SBE 39 temperature recorders, Brancker XL105 temperature recorders and MTR temperature recorders. Velocity measurements were made by a 1 MHz Nortek Aquadopp Current Profiler situated in the center of the net. Instrument string allocation, logging rates and positions of the vertical arrays within the three-dimensional net are shown in Table 6a, Table 6b, Table 6c and Fig 7 respectively. Examples of how the Brancker temperature and SBE 37 temperature recorders were rigged are shown in Fig 8 and Fig 9, respectively.

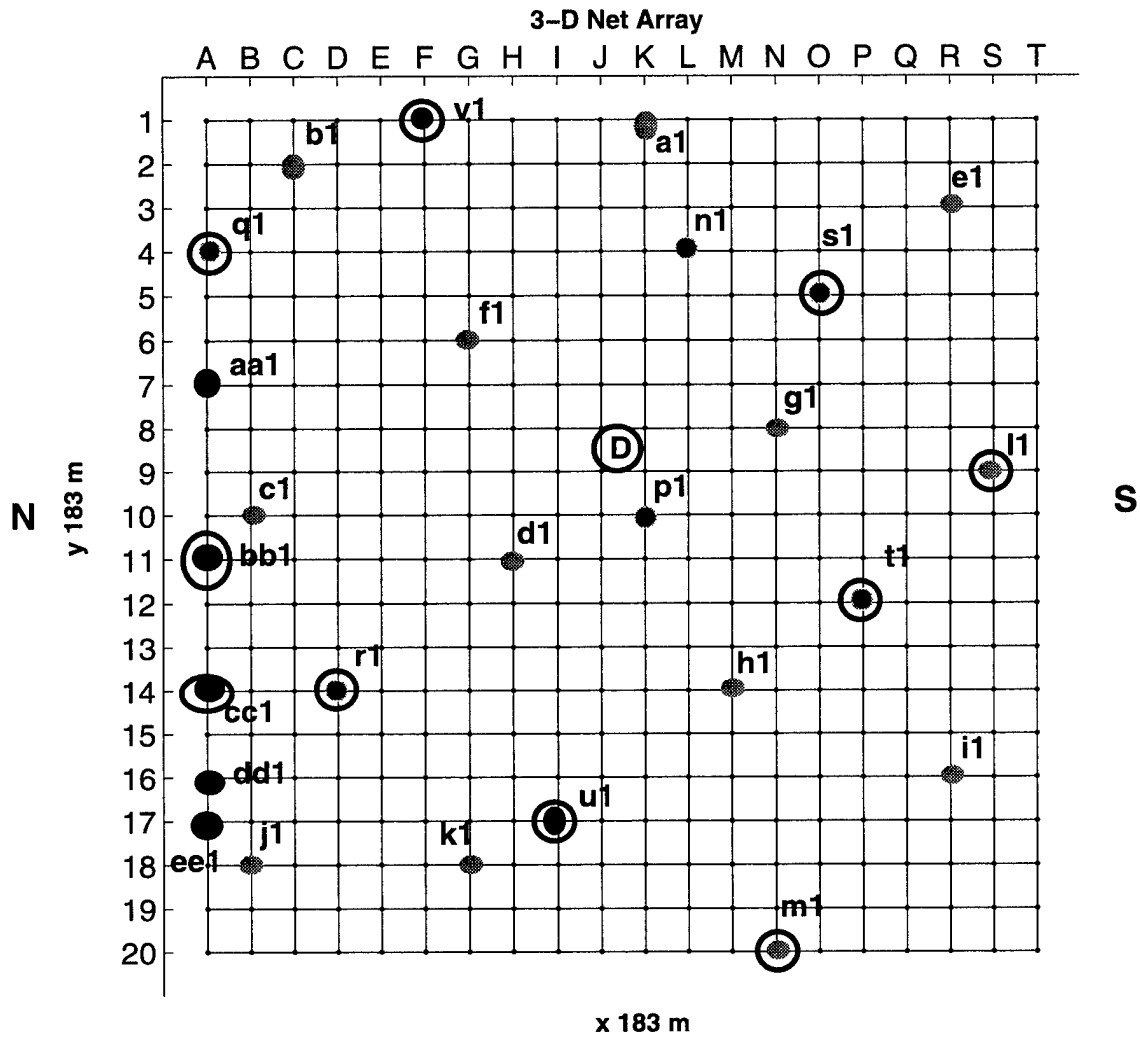
### *3.3.2 Three-Dimensional Net Deployment*

The CBLAST-Low net deployment was accomplished from the FV *Nobska* in the following sequence. Fig 10 details the FV *Nobska* fantail deck machinery layout. The prevailing sea swell at the CBLAST-Low site was from the southwest. The four moorings used to secure the net to the sea bottom were set in the following order: southwest, southeast, northwest and northeast. The southeast and southwest mooring legs used 4000 lb. DorMor anchors and the northwest and northeast moorings used 2200 lb cylinder anchors.

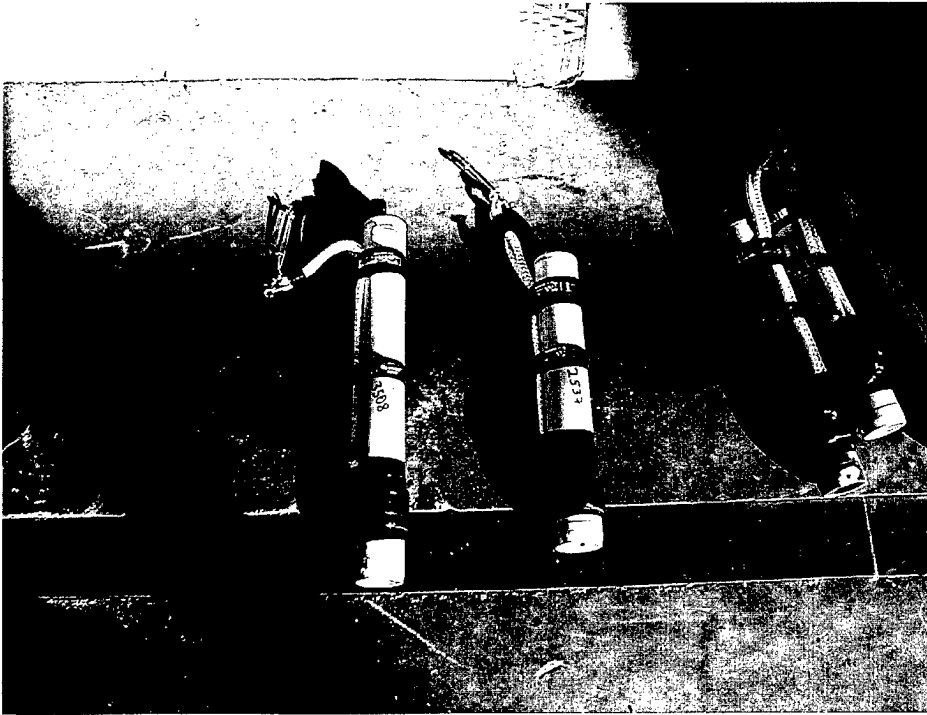
## Vertical CBLAST Instrument String



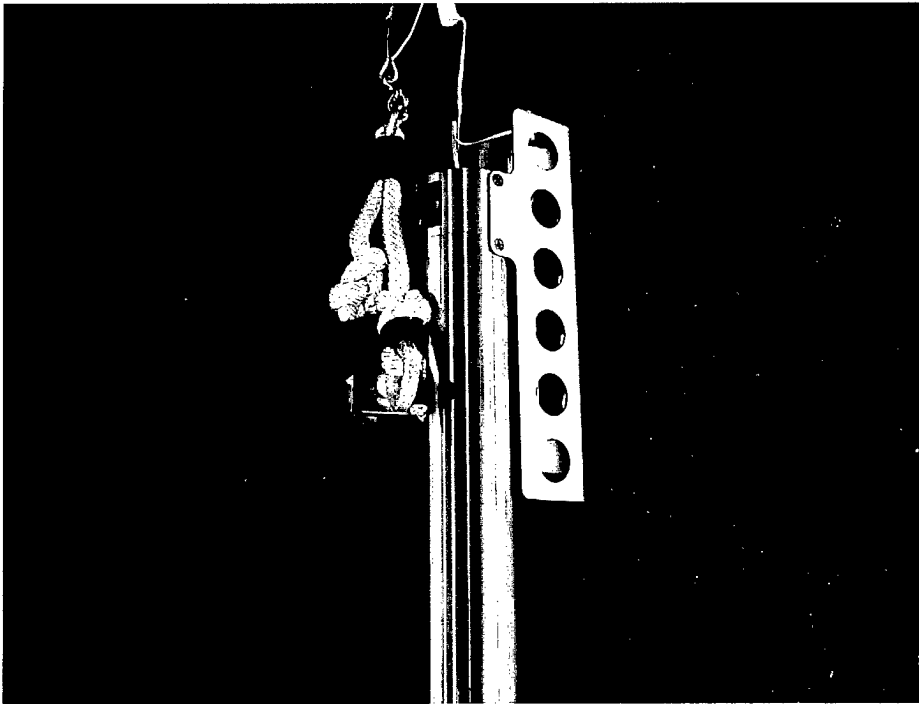
**Figure 6:** Artists impression of a three-dimensional net vertical string array with attached instrumentation for the CBLAST-Low 2001 pilot experiment.



**Figure 7:** CBLAST-Low three-dimensional net instrument allocation map for the CBLAST-Low 2001 pilot study.



**Figure 8:** Photograph of the rigging method for Brancker temperature loggers used on the three-dimensional array.



**Figure 9:** Photograph of the rigging method for SBE 37 temperature/conductivity recorders used on the three-dimensional array.



**Table 6b:** Three-dimensional net and long-line instrument types and sampling rates during the CBLAST-Low 2001 pilot study.

Instrument	Sampling Rates (seconds)
Tidbit temperature loggers	300
SeaBird SBE 39 T/C/P	10
Brancker XL105 temperature loggers	60
MTR Temperature Loggers	60
WADAR temperature loggers	60
Nortek Aquadopp ADCP	300

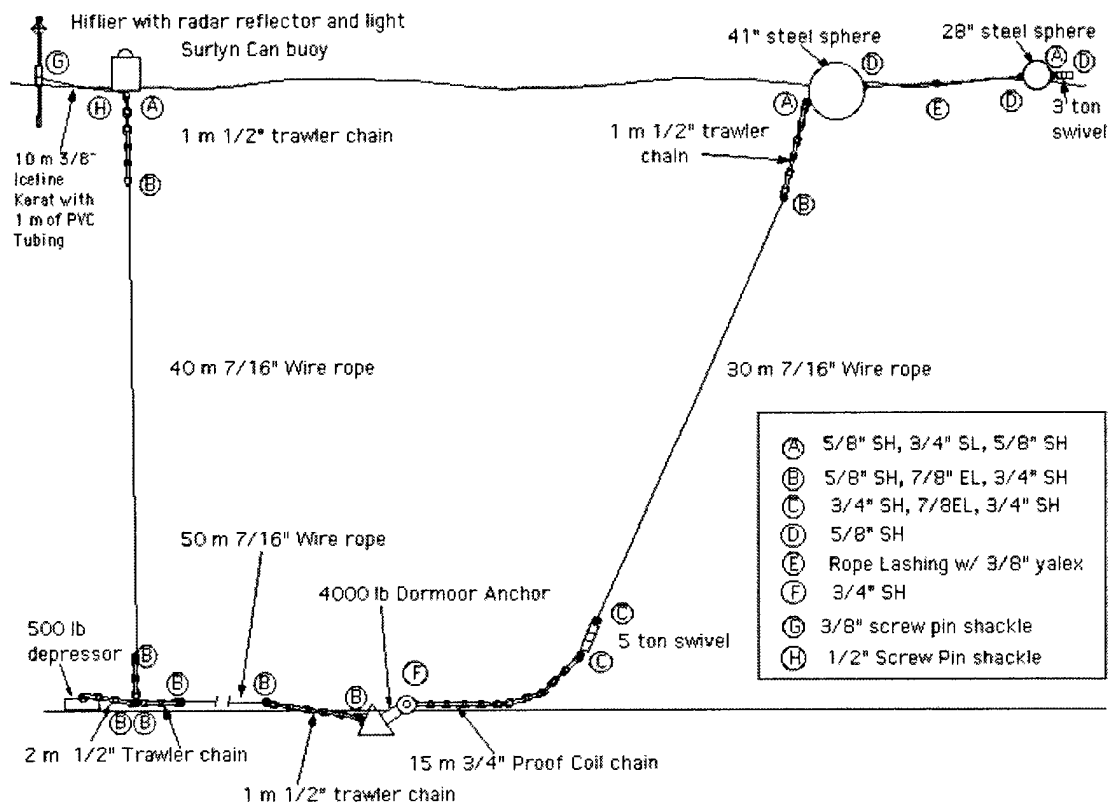
**Table 6c:** Positions of the vertical strings on three-dimensional net.

3-D net grid node	Vertical string identity
K1	a1
C2	b1
B10	c1
H11	d1
R3	e1
G6	f1
N8	g1
M14	h1
R16	i1
B18	j1
G18	k1
S9	l1
N20	m1
L4	n1
K10	p1
A4	q1
D14	r1
O5	s1
P12	t1
I17	u1
F1	v1
A7	aa1 (added on 7/22/01)
A11	bb1 (added on 7/22/01)
A14	cc1 (added on 7/22/01)
A16	dd1 (added on 7/22/01)
A17	ee1 (added on 7/22/01)

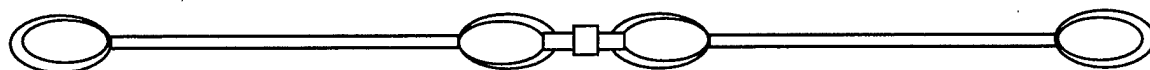
The mooring design used for the corner moorings, which secured the three-dimensional net, implemented the use of a ground wire and Surlyn crown buoys attached to the main corner mooring. The design illustrated in Fig 11a illustrates how the FV *Nobska* tightened or relaxed the three-dimensional net by hauling on the Surlyn crown buoy. Because of the need of fluidity in this operation, to prevent fouling of the net, once it was deployed onto the sea surface, the two DorMor mooring legs were pre-rigged on the ship. Fig 12 details how these two corner moorings were wound onto the ship's winches. The three-dimensional net was rolled onto the aft net drum, paying out from the bottom of the reel to allow for easier handling during the net deployment. The net was wound onto the aft net drum, so that as the net was being paid out, at mid pay out, the southwest and northeast corners would roughly unfold aft of the ship. A 28" steel sphere was shackled to the leading corner of the net. A Polysteel pennant was coiled and lashed to the top of the sphere. This pennant was made up from two 5m lengths of 1" Polysteel lines lashed together using 3/8" Yalex line. This two-part pennant design allowed the sphere and attached net to be towed by the small boat at the mid point of the line leaving the other half of the pennant free for attachment to the 42" sphere corner buoys under no load. Fig 11b details this pennant assembly. Four 30-m 7/16" mooring wires were wound onto the middle net drum. Onto each of the gallow winches a 7/16" 40 m wire and 50 m ground wire were wound. Two 2 m lengths of 1/2" trawler chain were shackled between the two shots of wire. This chain segment was added to allow for the fast attachment of the 500 lb depressor weight during the deployment phase of the ground wire. An interface tarp was placed between the ship's gallows wire and the mooring wire shots in an attempt to prevent damage to the mooring wire due from the hanging weight of the DorMor anchor.

The loose end of the 50 m ground wire was passed thru the gallows block and shackled to a 1m length of 1/2" trawl chain shackled to the bottom bail of the 4000 lb DorMor anchor. The gallow winches were wound up to lift and invert the DorMor anchor against the gallow block. The 500 lb depressor weights for the Surlyn can moorings were spotted on the ship's deck under the gallows block. The 28" and 42" steel spheres were stowed along the port and starboard rails. The ship's small boat was stored on its cradle, which breasted between the aft and middle net drums.



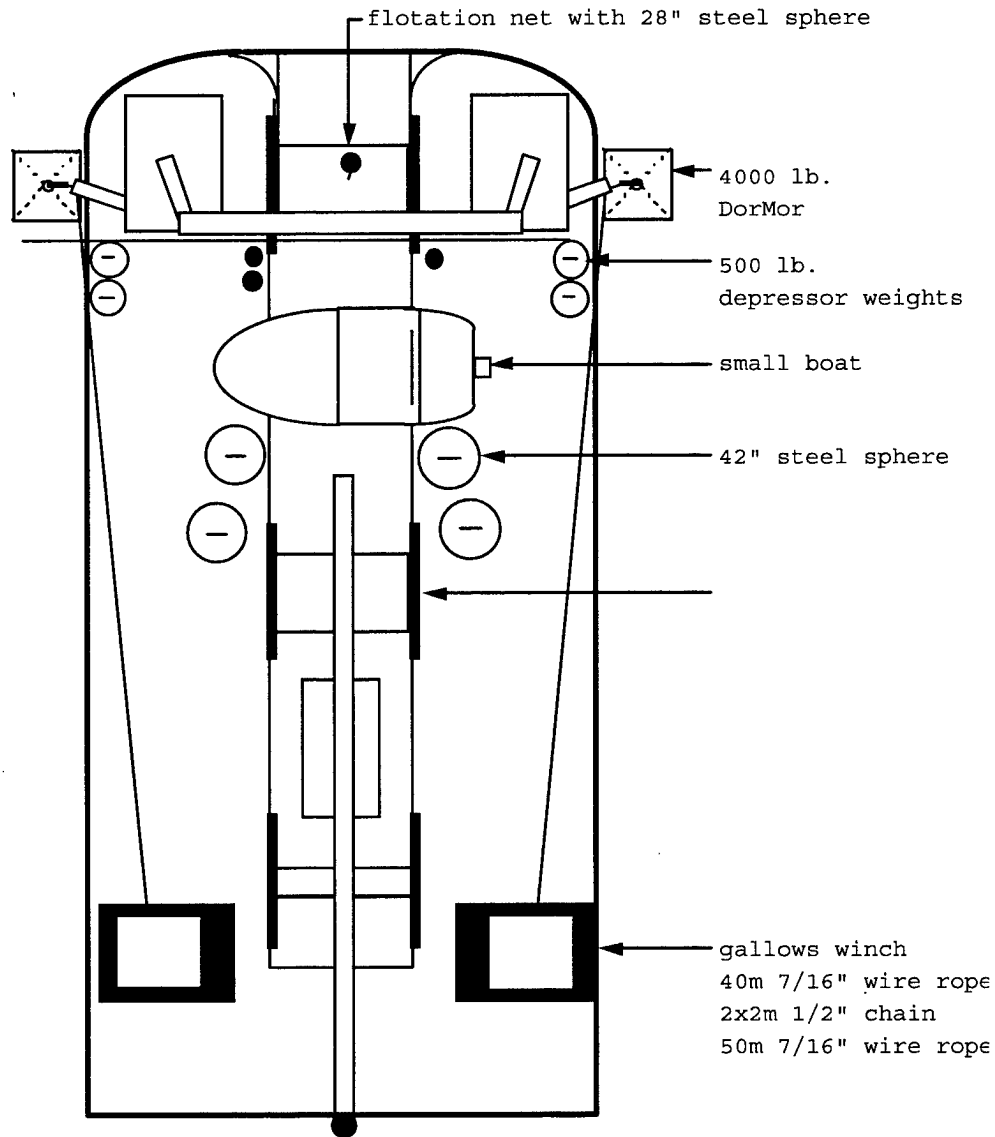


**Figure 11a:** CBLAST-Low three-dimensional net corner mooring and tensioning hardware.



CBLAST net corner pennant  
 2 x 5m 1"dia. 12 strand Polysteel line  
 4 x 1" wire rope thimbles  
 3/8" Yalex lashing

**Figure 11b.** CBLAST-Low three-dimensional net corner pennant assembly.



F/V Nobska - CBLAST net deck lay out  
scale 1"=10'

**Figure 12:** Pre-deployment loading on FV *Nobska* of three-dimensional net for the CBLAST-Low 2001 pilot experiment.

The deployment commenced by first launching the small boat with a boat operator and one line handler on board. The FV *Nobska* then deployed the southwest corner and Suryln can mooring assembly. This mooring's anchor location was deployed at the desired final southwest corner location. The FV *Nobska* than repositioned, so that

the starting point for the net deployment would be approximately 2 km down current from the southwest mooring.

The net was paid out until the southwest and northeast corners became accessible on the aft net drum. A 28" sphere and pennant were secured to each corner. The northeast sphere and pennant were lashed to the northeast corner of the net. The southwest sphere's pennant was passed to the small boat. The line handler on the small boat bent a 50 ft 3/4" nylon towline thru the thimble of the pennant segment secured to the 28" sphere. The small boat maintained forward way, approximately 40° off the starboard side of the FV *Nobska*, as the net continued to pay out. The small boat's function during this phase of the operation was to keep the northeast and southwest spheres and attached net corners separated, approximately 50 ft as the remainder of the net was being paid out.

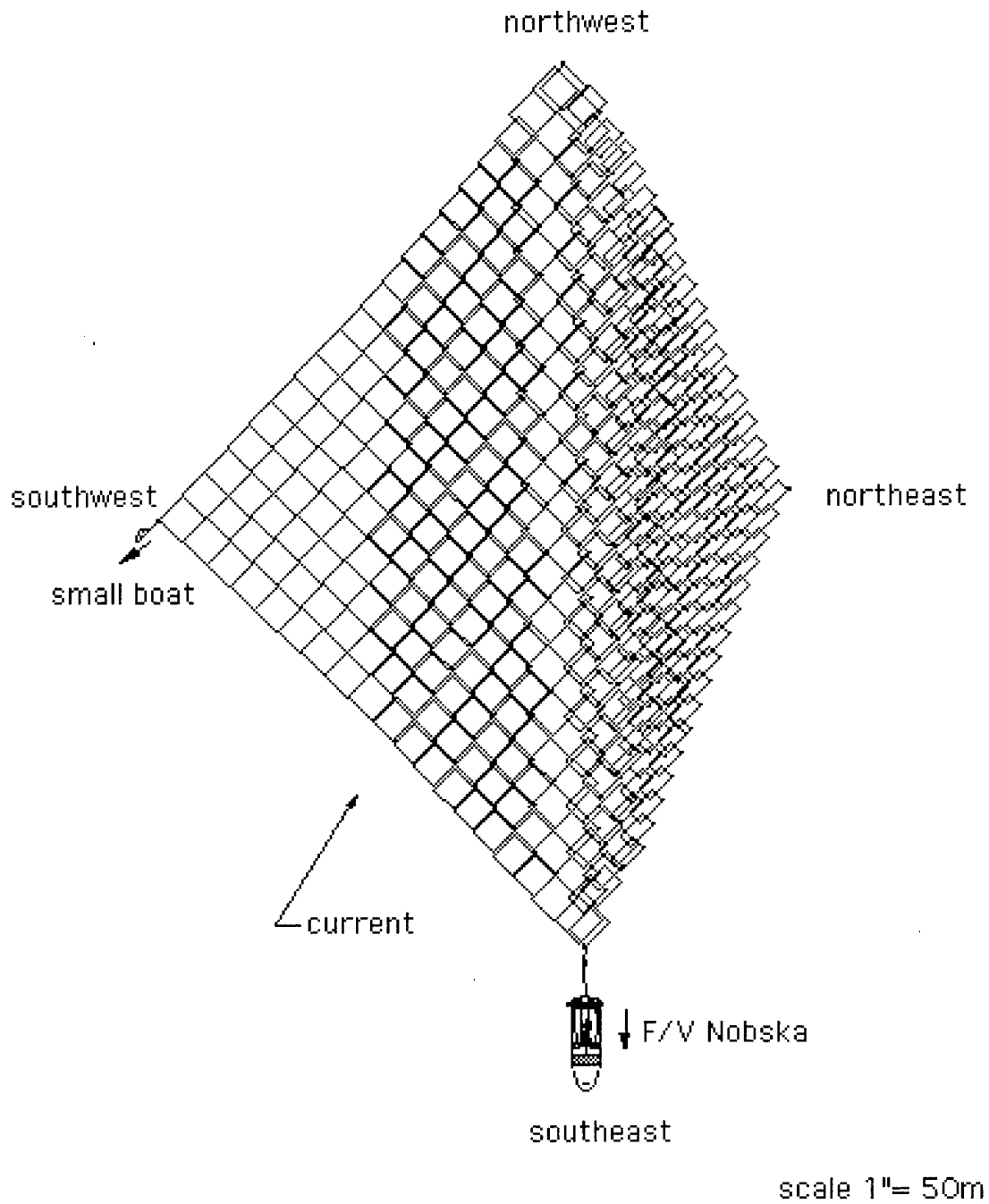
Once the southeast corner of the net was paid out, a 28" sphere and pennant was shackled on. The free end of the pennant was then attached to the 42" sphere positioned under the aft net reel. The free end of the 30m length of 7/16" wire wound on the middle net drum was secured to a 1 m shot of chain attached to the bottom of the 42" sphere. The middle net drum was paid out allowing the two spheres and south corner of the net to be deployed. At the end of the 30 m mooring wire a 15 m length of 3/4" chain was shackled to it. The free end of the chain was passed out thru the stern and around to the starboard DorMor anchor, where it was shackled to the top bail of the anchor. The towing tension was transferred from the middle net drum onto the gallows winch, which held up the DorMor anchors. The gallows winch paid out the ground wire lowering the DorMor anchor to the bottom. The two 2 m lengths of 1/2" trawler chain separating the ground and Surlyn crown wires were allowed to pass just thru the gallows block. The free end of a 2m-chain leader shackled to the 500 lb depressor weight was shackled to the 7/8" end link joining the two chain shots. The gallows winch hauled in the Surlyn crown wire causing the depressor weight to be lifted off the deck and outboard of the ship's rail. The gallows winch then lowered the depressor and Surlyn crown wire. When the Surlyn crown wire had gone slack, the remainder of the wire on the drum was manually pulled off and the free end of that wire was shackled to a Surlyn crown buoy. This buoy was cast overboard completing the deployment of the southeast corner mooring.

The FV *Nobska* then repositioned downcurrent and proceeded to deploy the southwest, northwest and northeast mooring legs. During each of the deployments, the small boat towed each respective net corner towards an opposing net corner. This was done to allow the FV *Nobska* enough maneuvering room to deploy the three mooring corners close to the relaxed net. At the conclusion on each corner mooring deployment, the small boat towed each respective net corner using the corner pennant to its 42" corner buoy and shackled the two together. Fig 13a-d details the orientation of the net during the corner mooring deployments.

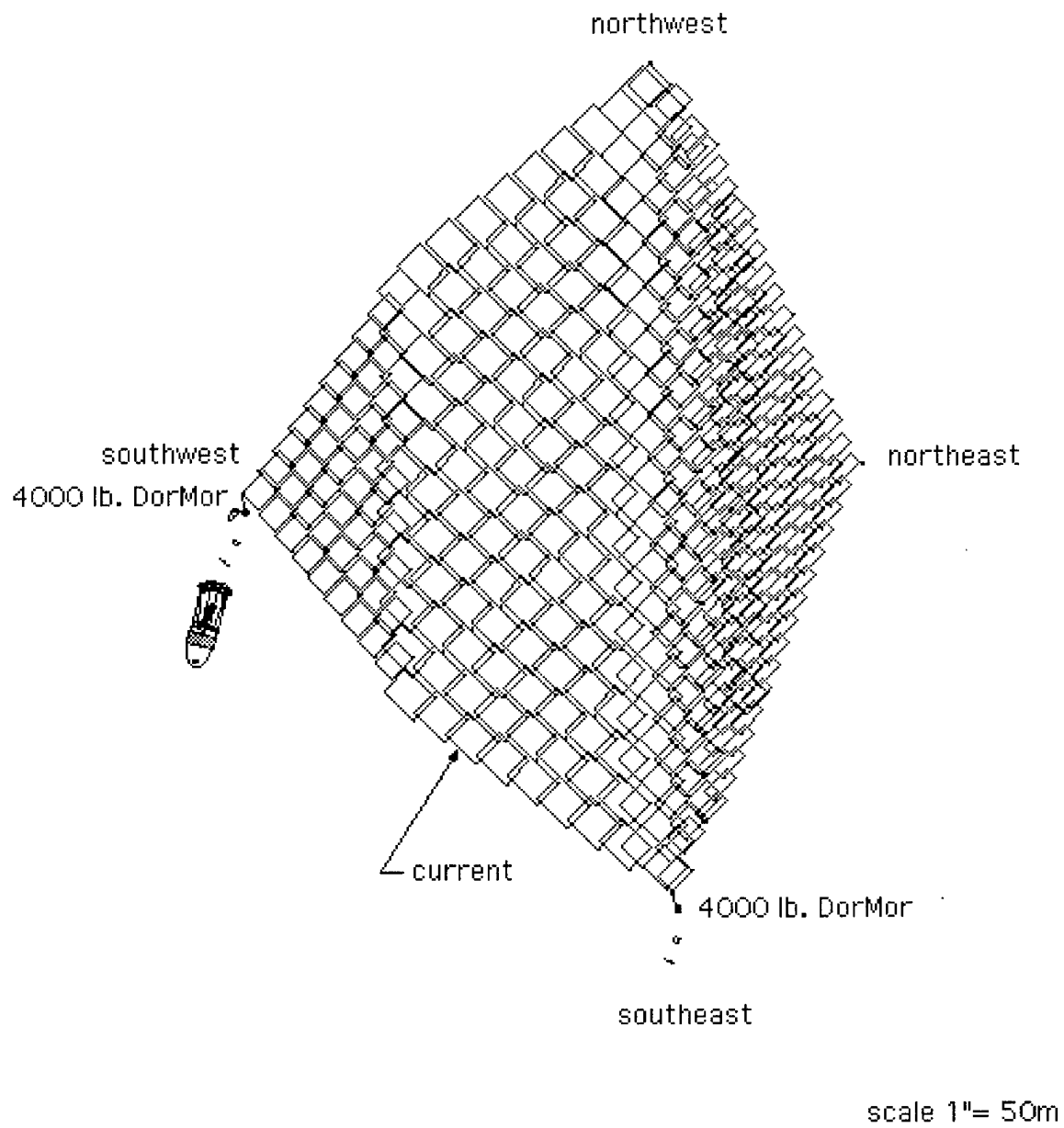
Once the four moorings were in place with the net corners secured, the ship proceeded to recover the southwest Surlyn crown buoy. The buoy was removed and the Surlyn crown wire was hauled up onto the gallows winch. The ship then slowly steamed away from the net and dragged the DorMor mooring anchor causing the net to be brought under tension. This process of hauling on the Surlyn crown lines to tension the net was monitored by watching the 42" sphere corner buoys disappearing and reappearing below the sea surface. Once all four spheres were approximately 1m or less underwater the net was set in position. Following this, a high flier buoy was attached to each corner Surlyn crown buoy using the small boat.

After deployment and tensioning, the geographical location of each of the three-dimensional net's 4 corners was recorded cruising by each corner in a small boat and recording the position of the first steel ball from a Garmin GPSmap 76 hand held GPS receiver. The position of each respective corner is shown in Table 7. Once the scientific part were happy with the overall symmetry of the net, the small boat was loaded with the pre assembled vertical 'string' arrays. With the aid of a position map and pre-marked strings the small boat entered the net by pulling the boat along by the meshes to the appropriate preselected positions of the vertical arrays. Once at the correct node the vertical arrays were attached to the node and then uncoiled and lowered down into the water column. The last instrument to be attached was the Nortek 1MHz Aquadopp ADCP. This was suspended from 3 separate lines at a depth of approximately 20 m in the center of the net array. A small sinker was suspended below the ADCP for stability. The full instrumentation of the array took approximately 3 hours to complete. An artist's impression of the fully deployed three-dimensional array is shown in Fig 14.

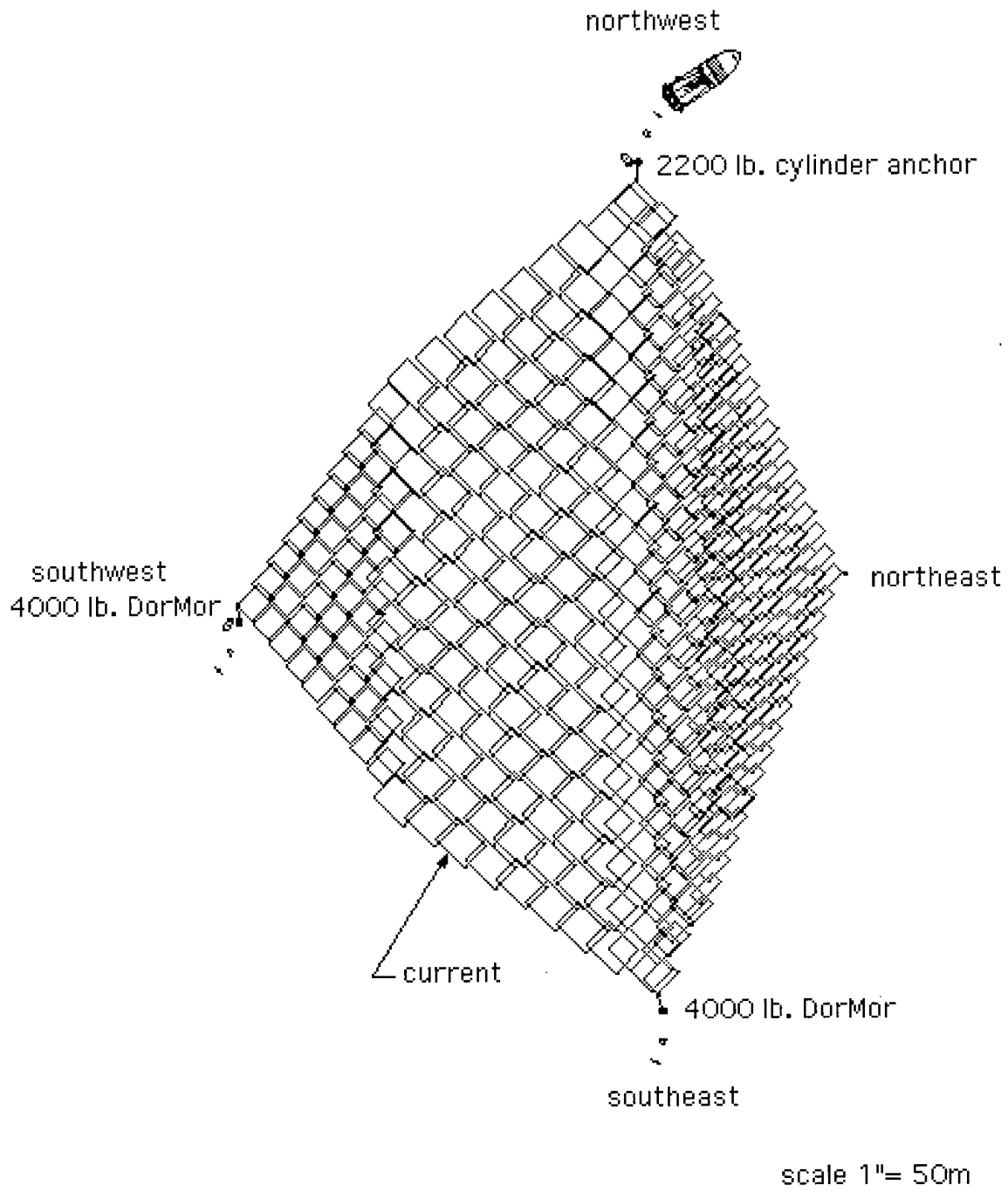
**Figures 13a-13d.** A Schematic flow diagram of the deployment procedure for the three-dimensional net from the FV *Nobska* during the CBLAST-Low 2001 pilot experiment.



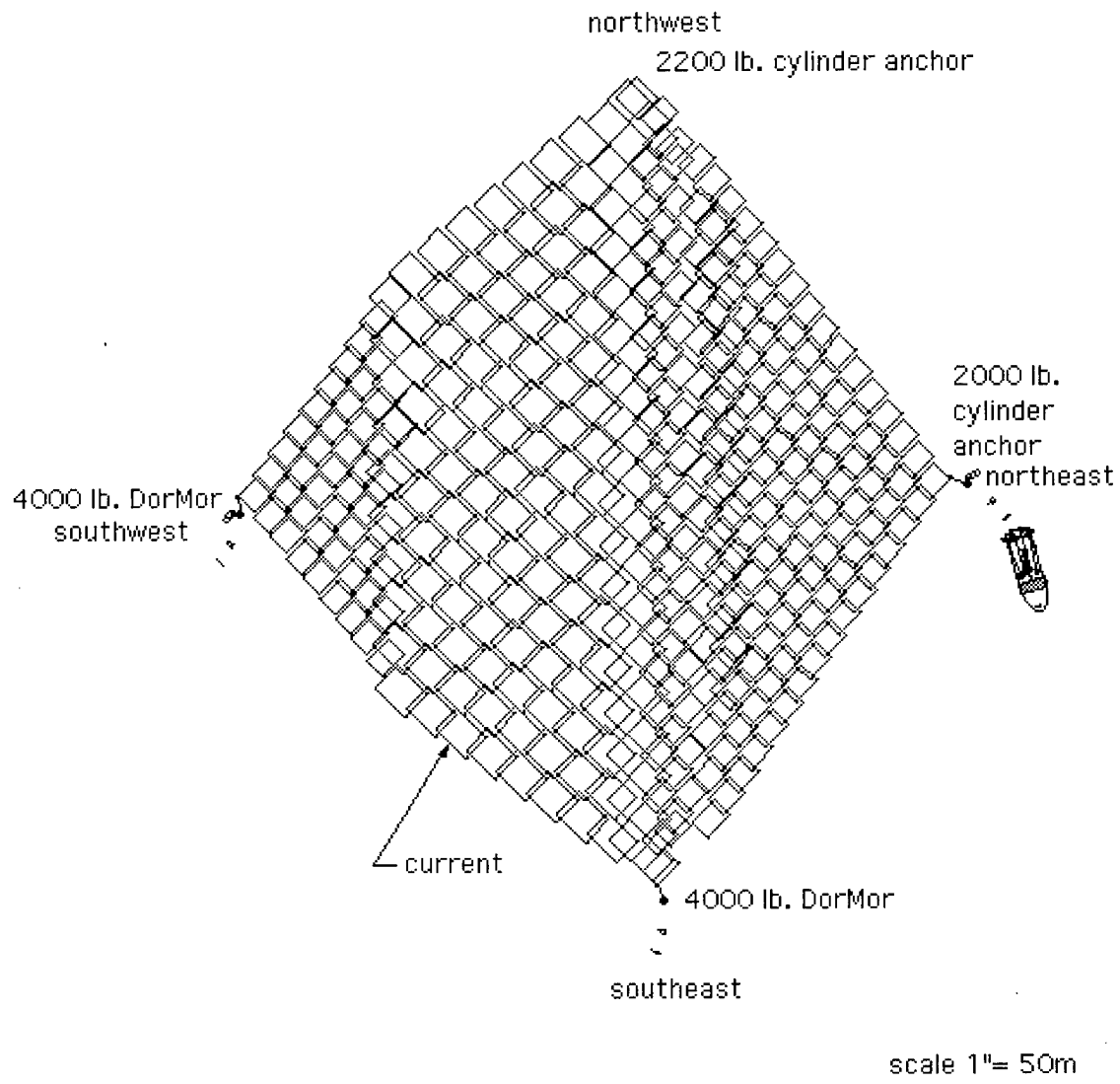
**Figure 13a**



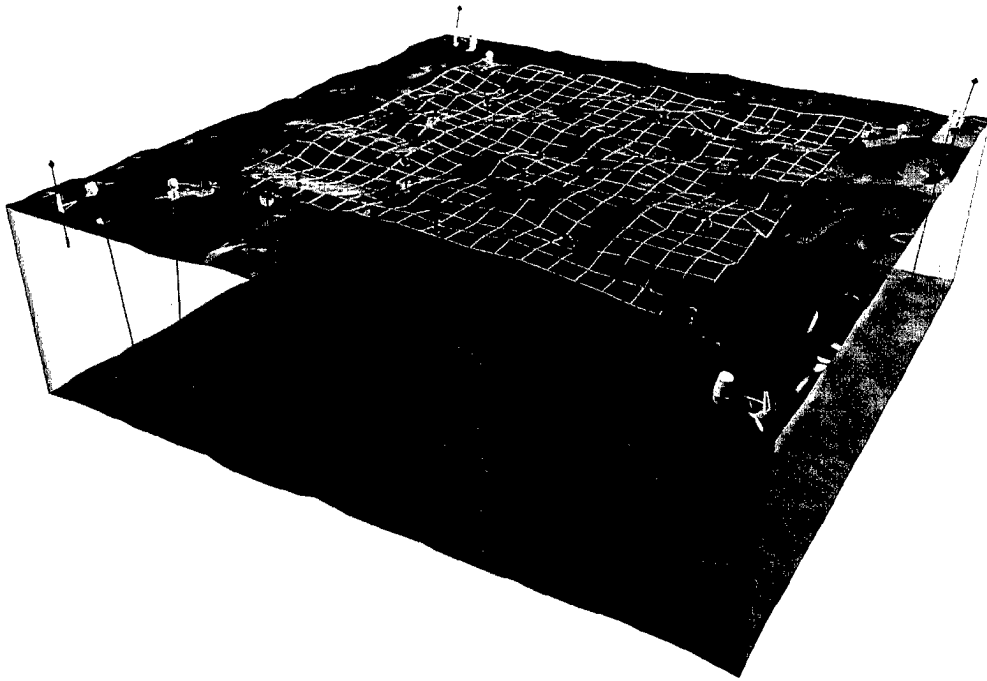
**Figure 13b**



**Figure 13c**



**Figure 13d**



**Figure 14:** Artist's impression of the three-dimensional net array fully deployed with all instrumentation attached to the two-dimensional grid.

After altering the sampling and deployment of the long-line array (discussed in the next section) 5 extra strings were added to the three-dimensional net on the morning of July 22, 2001. The position of these strings is shown in Table 6c and Fig 7.

**Table 7:** Geographical positions of three-dimensional net array corner anchorages at the time of deployment and recovery.

<b>Corner Orientation</b>	<b>Latitude 7/21/01</b>	<b>Longitude 7/21/01</b>	<b>Latitude 7/26/01</b>	<b>Latitude 7/26/01</b>
SE	41° 15.235'	70° 35.471'	41° 15.224'	70° 35.461'
SW	41° 15.210'	70° 35.593'	41° 15.190'	70° 35.571'
NW	41° 15.307'	70° 35.609'	41° 15.307'	70° 35.609'
NE	41° 15.317'	70° 35.479'	41° 15.333'	70° 35.470'

Under the low wind conditions, the net appeared to maintain its form and the four corners their geographical positions and it was possible to observe the structure of the mesh system inside the net perimeter. Observations made from the FV *Nobska* bridge confirmed only a small deformation of the mesh on the 'down' tide end of the frame. This bow in the net frame was only approximately 3-7 m over the entire length of the net.

After the second day of deployment weather conditions began to deteriorate with increasing wind speed and sea state. Nevertheless, the anchor system held despite the net receiving a battering from wind waves and longer period heavier swell propagating from the south.

Before the recovery of the three-dimensional net on July 26, 2001, the positions of the 4 anchors were checked again from the small boat with the handheld GPS. The results from this survey are shown in Table 7. Calculations of distance between diagonal corners of the net using the traditional 'joiners square' method showed that the anchorages had moved only a few meters through the duration of the deployment despite the unseasonable weather and sea conditions.

### *3.3.3 Three-Dimensional Net Recovery*

Due to the adverse weather conditions on the day of the net's recovery it proved necessary to alter the recovery procedure of the net and instrumentation to preserve both the instrumentation and most importantly maintain safety. Due to high seas and swell conditions it was unsafe to use the small boat inside the net for instrument recovery. Therefore, it was decided to effectively collapse the mooring with all instrumentation still attached by releasing three of the anchorages. The one remaining anchorage was on the up tide end of the collapsed net. After the net was collapsed the small boat rode along side the net removing and collecting the instrument strings. Once this procedure was completed the last anchor and hardware was hauled onboard the FV *Nobska* and the net wound onto the rear drum of the ship. After the small boat and crew were safely aboard, the remaining 3 anchorages were recovered through use of the gallows winches and the pulleys at the stern of the ship. All equipment was then safely tied down and stowed on deck.

On recovery of the instrumentation it was noted that several instrument strings had been lost during the three-dimensional net's deployment (see Table 6a). The losses were caused by line breakages just below the string flotation buoys. These breakages were caused by friction and consequently chaffing between the net grid and the vertical string just below the flotation buoys. This was a result of wind waves continually throwing the buoys over the net grid rails and causing a sawing like action on the strings.

The majority of the equipment attached to the lost strings was salvaged at a later date.

### **3.4 Long-Line Deployments**

The ethos of the CBLAST-Low experiments was to measure variability in the upper ocean on a variety of spatial and temporal scales. To achieve this objective of mapping the upper oceans variability on scales of 100's to 1000's of meters, a long-line type of deployment was proposed as a relatively cheap and viable method of deploying vertical arrays of temperature sensors from a survey vessel. This would effectively allow their recovery and aid tracking capability though the use of high flier radar detectors from the survey vessel.

#### *3.4.1 Long-Line Instrumentation and Hardware*

Deployed along with the long-line was a buoy made up from 3-glass balls housed in a tubular frame. This effectively supported an upward looking 2MHz Nortek Aquadopp ADCP set at a depth of approximately 6 m. In addition, 8 Onset Tidbit temperature sensors were spaced at 0.5 m depth increments down one of the bridle supports. Details on sampling rates are shown in Table 8.

An ORBCOMM Panasonic KX-G7101 Data Communicator with built-in GPS receiver positioning and transmitter unit and battery packs used to track the buoy through the duration of the deployment were housed in a watertight container fastened to the top of the buoy. The small whip antenna used in satellite communication was incorporated into the top of the housing, thus forming a fairly compact, robust and complete tracking device.

**Table 8:** Long-line instrumentation details for the CBLAST-Low 2001 pilot experiment.

Instrument / Array		Depth (m)	Sampling Rate (secs)	Serial Number
Tidbit		0	300	97
Tidbit		0.5	300	82
Tidbit		1.0	300	98
Tidbit		1.5	300	6
Tidbit		2.0	300	22
Tidbit		2.5	300	84
Tidbit		3.0	300	79
Tidbit		3.5	300	53
Nortek ADCP	Aquadopp	6.0	300	AQP 0273
Vertical Arrays	String	see Table 4a	300	see Table 4a
o1		see Table 4a	300	see Table 4a
x1				
y1		Surface	300	
Siemac GPS loggers				

The signal transmitted from the ORBCOMM unit contained the time and geographical position of the buoy and was received via the ORBCOMM satellite network and sent to UOP at WHOI via the Internet as an email message. Once the automated server at WHOI received the email message from ORBCOMM, all unnecessary text was removed and the message containing time and position relayed back via ORBCOMM satellite to an ORBCOMM receiver unit via an antenna that was set up on the FV *Nobska's* bridge. The message was read on laptop PC via Procomm software. This simple procedure conceptually allowed near real time tracking of the buoys whereabouts. The only problems encountered were the sporadic reception of the ORBCOMM messages. The gaps and sudden bursts of messages received on the FV *Nobska* from the tracking were attributed to the same problems encountered with the SecNav buoy.

### 3.4.2 Long-Line Deployment

On the evening of July 21 it was the intention to deploy approximately 10 km of long-line with sensors attached at various lag scales. However, due to extremely high fishing activity it was thought unwise to deploy such an array as it had a high probability

of becoming snared or broken by fishing boats in the immediate area. As a compromise, it was decided to deploy a shorter 1 km section of long-line and vertical arrays of temperature recorders near to the CBLAST-Low three-dimensional net site.

The buoy was deployed over the side of the FV *Nobska* with the boom winch with a length of long-line fed from the fore net drum and fed through the A-frame at the stern of the ship and then attached to the DRIFTAR frame. As the buoy was released the line was paid out from the drum. As line passed out through the stern, vertical temperature arrays were attached with long-line clips at preselected lags. In addition, 3 self-contained Seimac GPS logger/receivers were fastened to the top of 3 high fliers at intervals along the long-line. To increase the visibility of the long-line, 8" floats were clipped on the line as it passed through the A-frame. A total length of 750 m of line was deployed during this experiment with 3 temperature arrays attached at lags along its entire length. The end of the line was terminated with an A4-polyfoam float.

The long-line and buoy were allowed to drift freely for approximately 24 hours before recovery. In this time the array had moved from its release site, just west of the three-dimensional net site to the far west of Martha's Vineyard before altering course in a large arc back towards the east. During its deployment, the long-line for several hours was fully extended but at some point in the release thereafter became slightly tangled. By the time of the recovery, sections of the line were in disarray and required cutting to free certain array components from the 'nests' that had formed along its length.

#### *3.4.3 Long-Line and Buoy Recovery*

The recovery of the drifting buoy was virtually a reverse procedure of its deployment. A snap hook and sling was attached to the frame of the DRIFTAR and it was eventually winched on board the FV *Nobska*. The long-line was pulled on board in numerous bites and the high fliers, GPS loggers/receivers and vertical temperature arrays removed as required.

### 3.5 CTD Surveys

Four comprehensive CTD surveys using a SeaBird SBE 19 of the Martha's Vineyard study site were completed during the pilot experiment (see Table 9). The CTD was deployed from the FV *Nobska* on a hydrowire attached to the deck's boom winch. The maximum depth obtained from this method was approximately 40 m. One survey ran parallel to the coast of Martha's Vineyard and hugged the 25 m isobaths along an east to west transit. The other 3 surveys were completed across shelf from depths of approximately 12 m inshore of the proposed ASIT tower site to the offshore position of the CBLAST-Low ASIMET buoy in a water depth of approximately 47 m. CTD casts were conducted approximately every half nautical mile on the across shelf survey and every nautical mile during the onshore-offshore surveys. A total of 135 CTD casts were made during the pilot IOP.

**Table 9:** CBLAST-Low 2001 pilot experiment CTD chronology and survey type.

<b>Time / Date of Survey</b>	<b>Type of Survey</b>
22:46 UTCZ 7/22/01 – 06:35 UTCZ 7/23/01	Along shelf
08:02 UTCZ 7/23/01 – 16:04 UTCZ 7/23/01	Across shelf
10:12 UTCZ 7/24/01 – 21:00 UTCZ 7/24/01	Across shelf
09:50 UTCZ 7/25/01 – 19:10 UTCZ 7/25/01	Across shelf

### 3.6 ADCP Sled Deployment and Recovery

An ADCP sled belonging to the AOPE group participants in the CBLAST-Low was deployed and recovered by FV *Nobska* on June 19, 2001, and August 17, respectively, by the Upper Ocean Processes group. The ADCP was deployed at 41°19.583'N, 70°25.491'W in Muskeget Channel to measure tidal currents through the channel and provide data for the modeling efforts of other CBLAST-Low participants and investigators.

The sled was deployed through the fish chute at the stern of the vessel using the stern net drum and a wire. Once the sled hit bottom the wire was freed by an acoustic release fired from the deck. The recovery procedure involved firing an acoustic release mechanism that released a buoyant steel ball attached to the sled frame. The ball was grappled at the surface and coupled to the rear net drum and the sled was then brought onboard through the fish chute at the stern on the FV *Nobska*.

#### 4. CBLAST Pilot Experiment Chronology

The following chronology gives a brief synopsis of the events leading up to, during and after the 2001 CBLAST Low pilot IOP.

Date	Events
June 6-7, 2001	Loaded FV <i>Nobska</i> Deployment of tide gauges.
July 18-19, 2001	Loaded FV <i>Nobska</i> Deployment of CBLAST Low ASIMET buoy and sub-surface array plus ADCP Sled.
July 20, 2001	Load FV <i>Nobska</i> with three-dimensional net, long-line and all associated instrumentation
July 21, 2001	Three-dimensional net deployment and instrumentation of net CTD survey Release and monitor long-line Tend three-dimensional net
July 22, 2001	CTD survey Monitor long-line Tend three-dimensional net
July 23, 2001	CTD survey Monitor and recover long-line Tend three-dimensional net
July 24, 2001	CTD survey Tend three-dimensional net
July 25, 2001	CTD survey Tend three-dimensional net
July 26, 2001	Recover three-dimensional net Return to port
August 16-17, 2001	Recovery of tide gauges, CBLAST-Low mooring, SecNAV moorings and ADCP sled.

## 5. Data Report

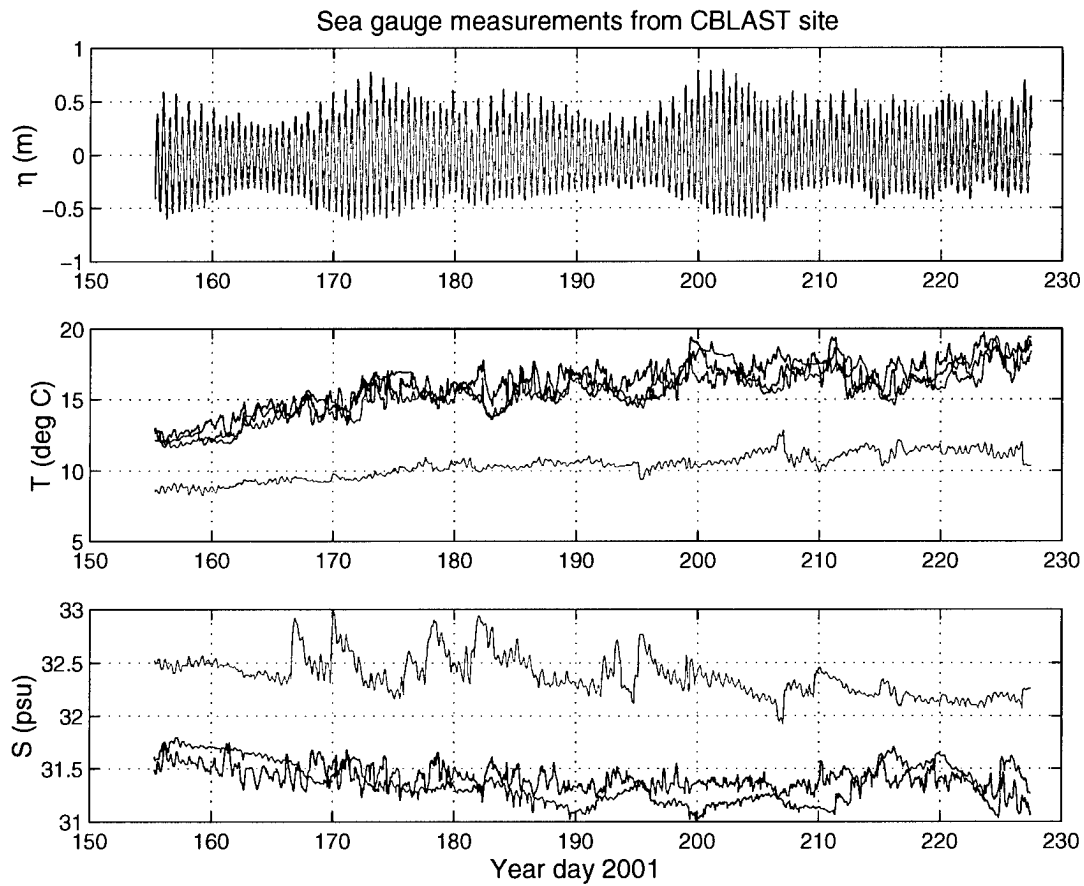
All data were downloaded from all instrumentation as they were recovered during the different phases of the experiments. Data were transferred from various laptop and desktop computers and backed up on CD-ROM.

The respective locations of the failed instruments on each array or its geographical position are shown in Table 6a, Table 6c and Table 7.

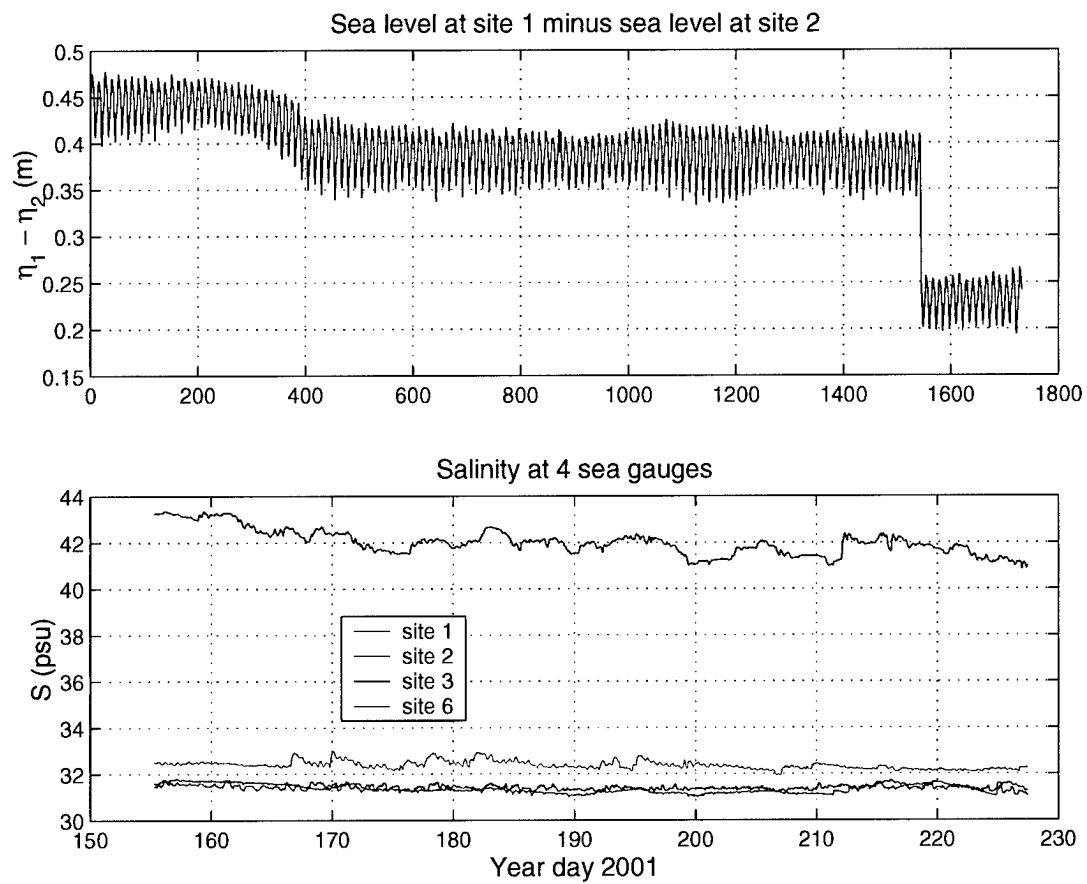
Instrument loss on the three-dimensional array was a direct result of mechanical failure of the vertical strings used for instrument attachment to the three-dimensional net grid as discussed in Section 3.3.3. Losses include a number of tidbit temperature sensors SB 37 T/C/P, SBE 39 T/P and Brancker XL105 TP. All these losses are documented in Table 6a after salvaging 4 arrays by dragging with grapples from the FV *Nobska*. All losses and failures on the three-dimensional array are highlighted in Table 9.

### 5.1 Tide Gauge Data

Examples of the results (provided by J. Trowbridge, AOPE) from the tide gauge deployments are shown as a series plots in Fig 15a to 15c, Fig 16a and Fig 16b. Fig 15a shows the tidal elevation at 3 of the tide gauge mooring sites. Pressure records appeared to be of the correct magnitude. Temperature and salinity measurements shown in Fig 15b and 15c illustrate subtle differences in between the inshore and offshore sites. Fig 16a shows the tidal elevation recorded at Site 1 at  $41^{\circ}18.940'N$ ,  $70^{\circ}43.522'W$  (see Fig 1). The sudden drop in sea level elevation at about sample 1480 is thought due to the instrument being snagged and towed by a fishing vessel in the area. In addition, Fig 15b shows one of the salinity measurements had recorded a 42+ PSU time series, which is unrealistic for the deployment sites around Martha's Vineyard. The post-calibration of this instrument may hope to improve these observations.



**Figures 15a-15c:** Time series plots of tidal elevation, temperature and salinity at the CBLAST-Low tide gauge mooring sites during the 2001 pilot experiment.



**Figures 16a-16b:** Time series plot of the towed tide gauge sea surface elevation and the problematic conductivity cell during the 2001 pilot experiment.

## 5.2 CBLAST-Low, SecNav Buoy and Subsurface Array Data

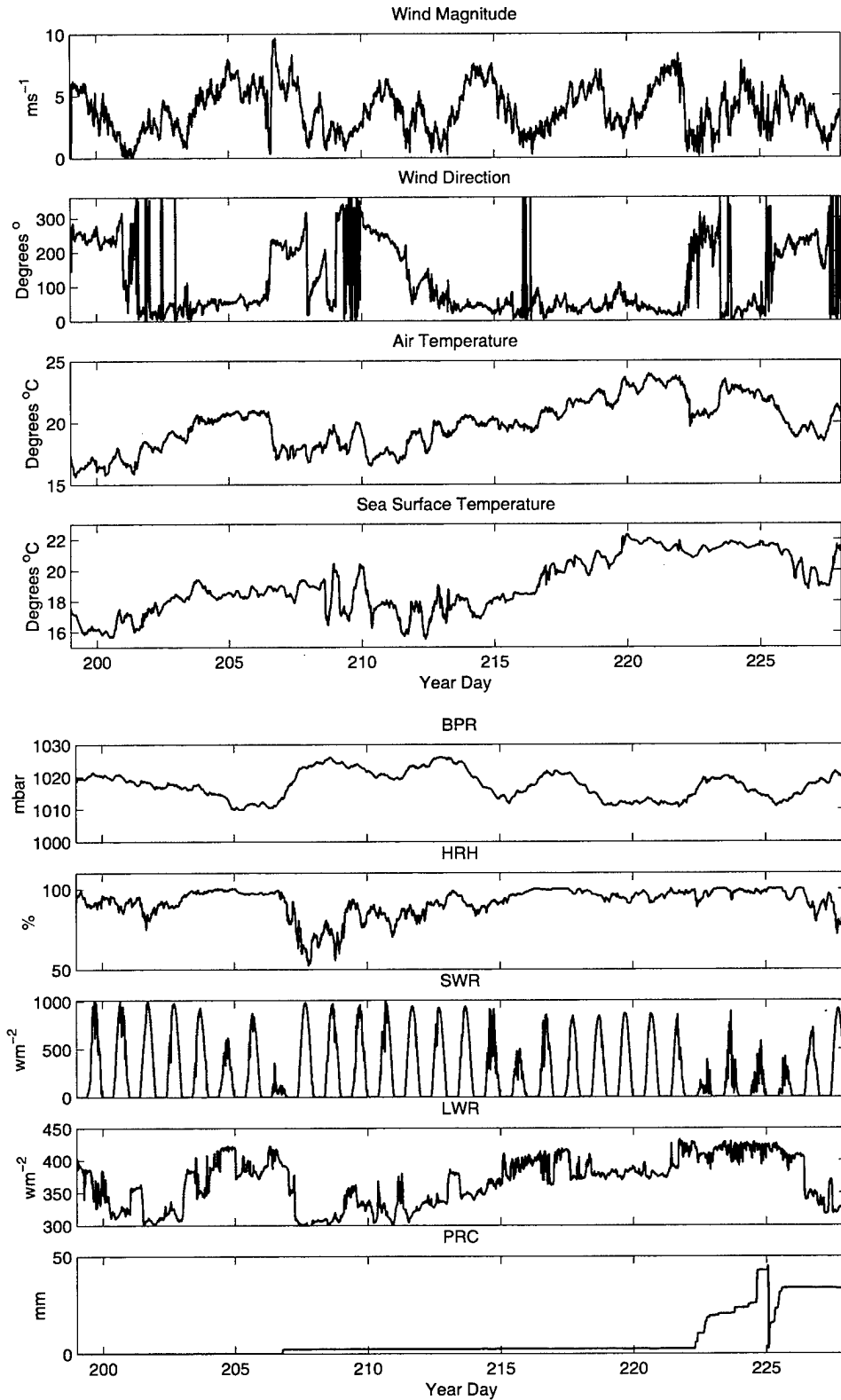
Both the CBLAST-Low and SecNav buoys provided continuous time series data through the entire duration of their deployments. Examples of the meteorological time series data provided by the CBLAST-Low buoy at the offshore site are shown in Fig 17a and Fig 17b. Data appeared of a high quality with the exception of some 'spikes' in the wind data. Since these experiments, the problems with the wind module have been resolved through an upgrade in data logger software.

The resulting components of the air-sea fluxes computed from the standard meteorological measurements using the TOGA-COARE 2.6b bulk algorithms are shown in Fig 18. Plots of the net respective components of the fluxes used to study air-sea interaction appeared to be within the range of acceptable values.

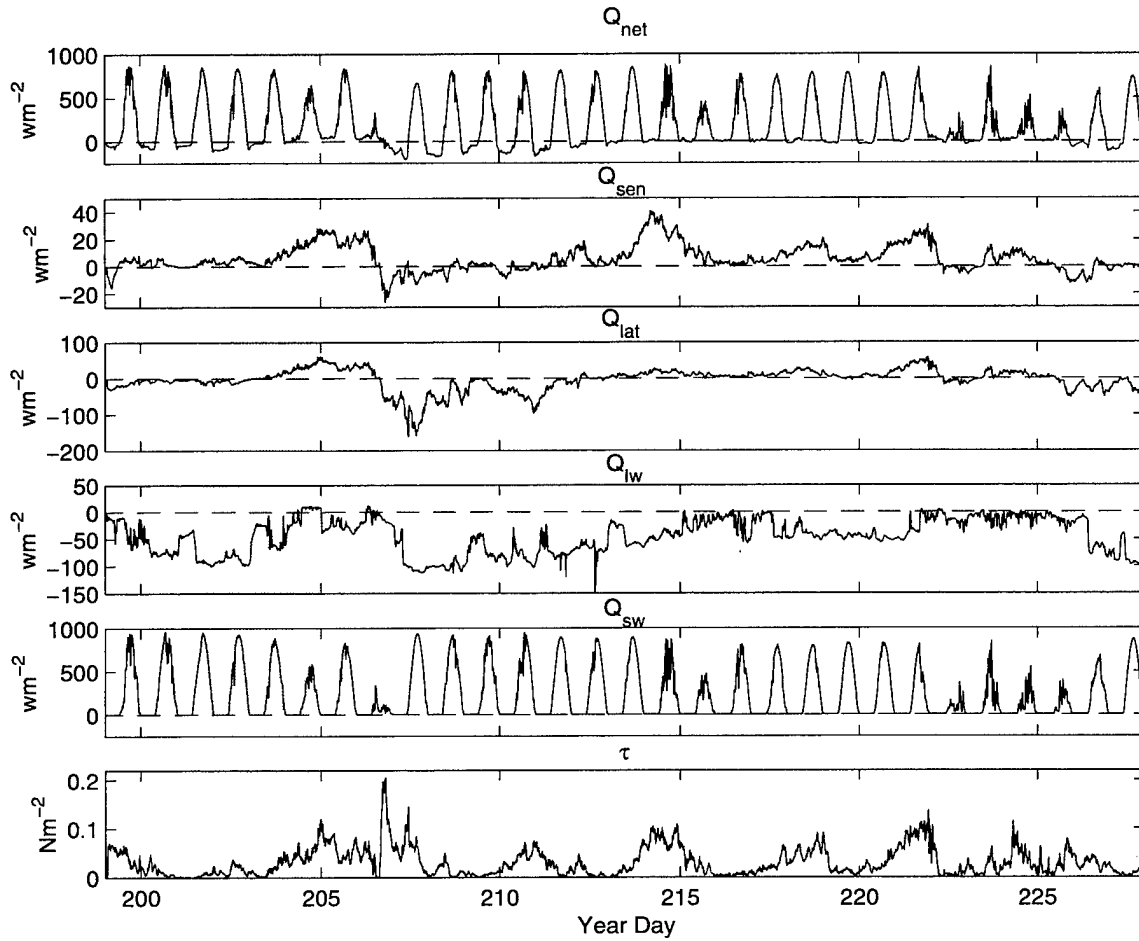
The CBLAST-Low buoy subsurface mooring provided a continuous record of temperature, salinity and velocity throughout the deployment. Data type provided by the high-resolution vertical temperature record is shown in Fig 19 where Onset Tidbit temperature sensors provided the majority of this data.

The RDI and Nortek ADCP's that recorded current measurements on the CBLAST-Low mooring provided near complete data return where only small gaps (odd failure of one ensemble increments – 300 secs) in some depth bins due to bad acoustic returns were recorded.

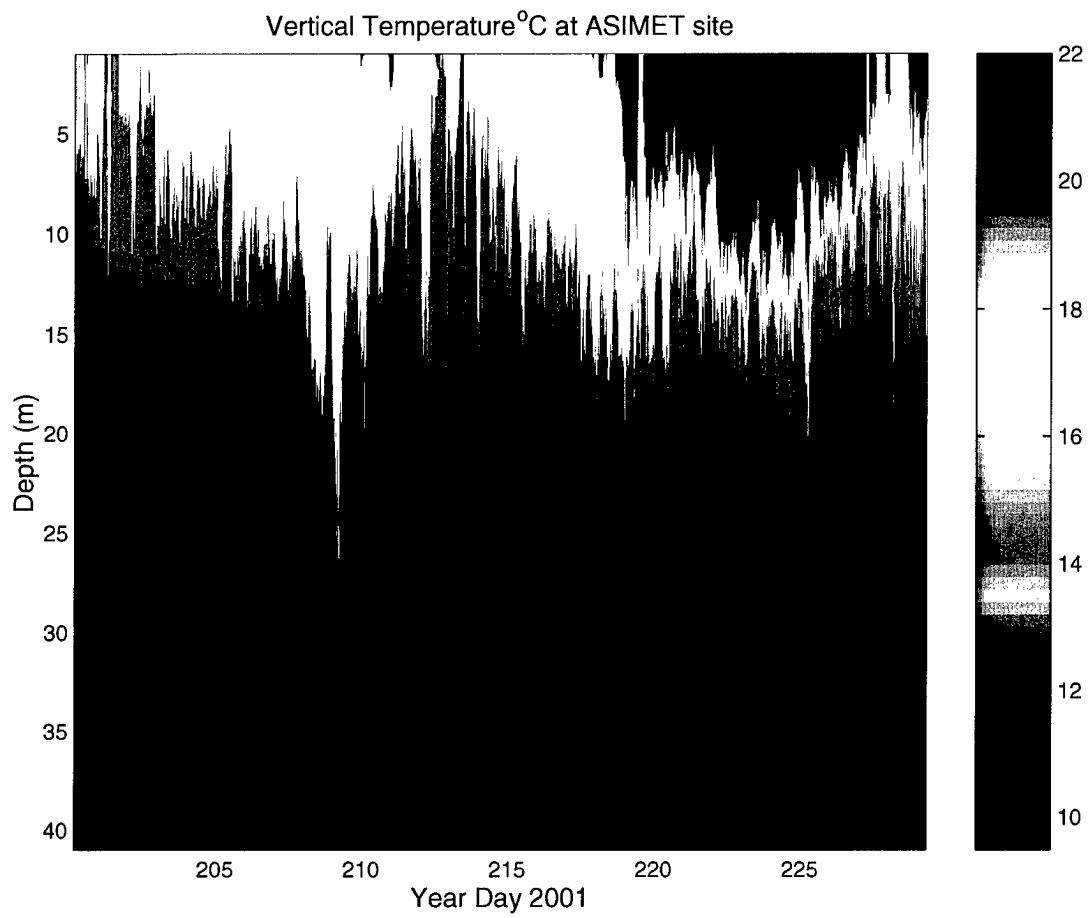
The SecNav buoy recorded data internally throughout its deployment period despite the problems encountered between the acoustic modems in the field as discussed in Section 3.2.5. Figures of the raw meteorological and air-sea flux data are shown in Figs. 20a-20b and Fig 21 respectively.



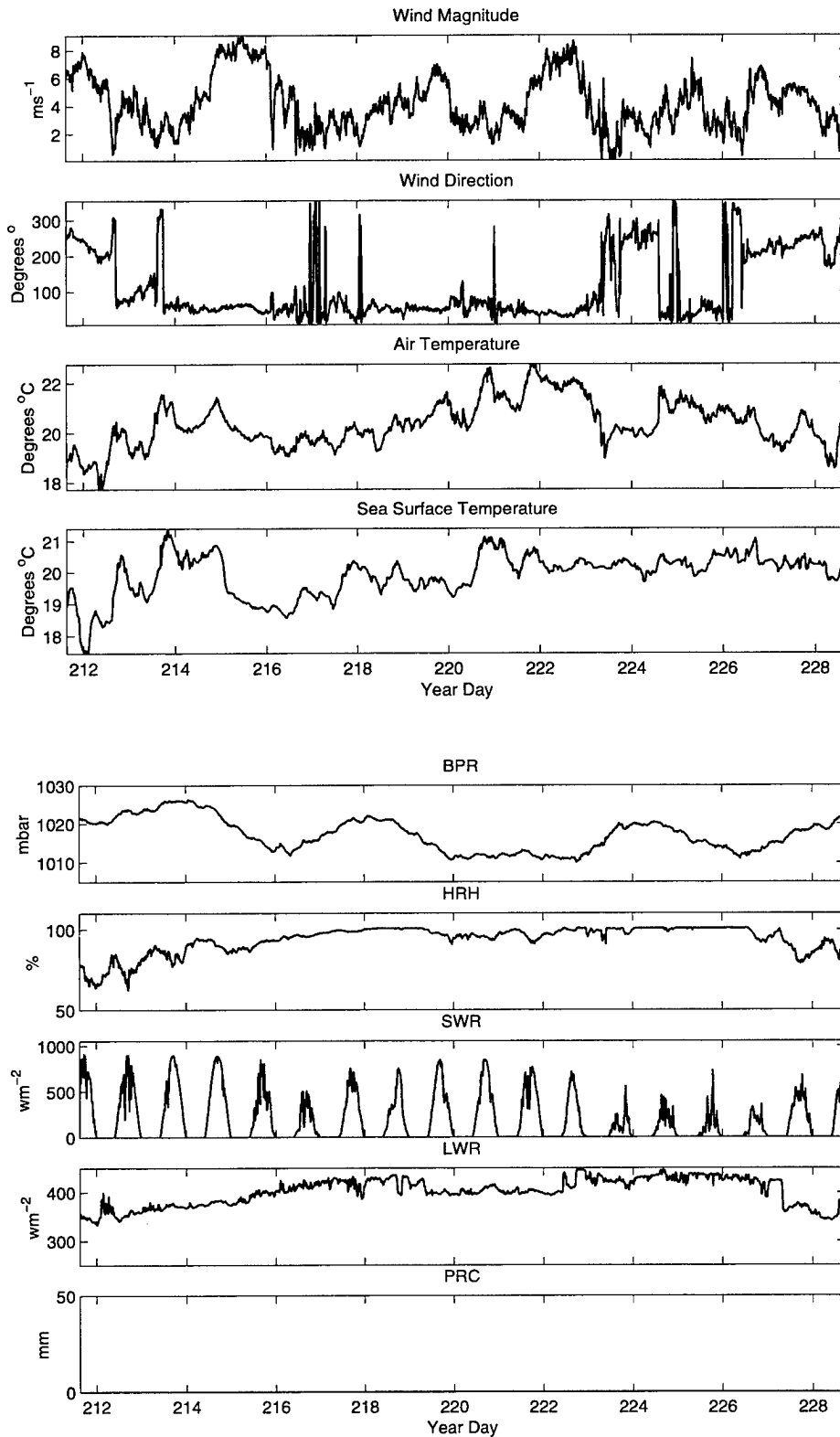
**Figures 17a-17b:** Standard meteorological measurements recorded by the CBLAST-Low buoy ASIMET system during the July–August 2001 deployment period. Shaded areas indicate the time of the IOP.



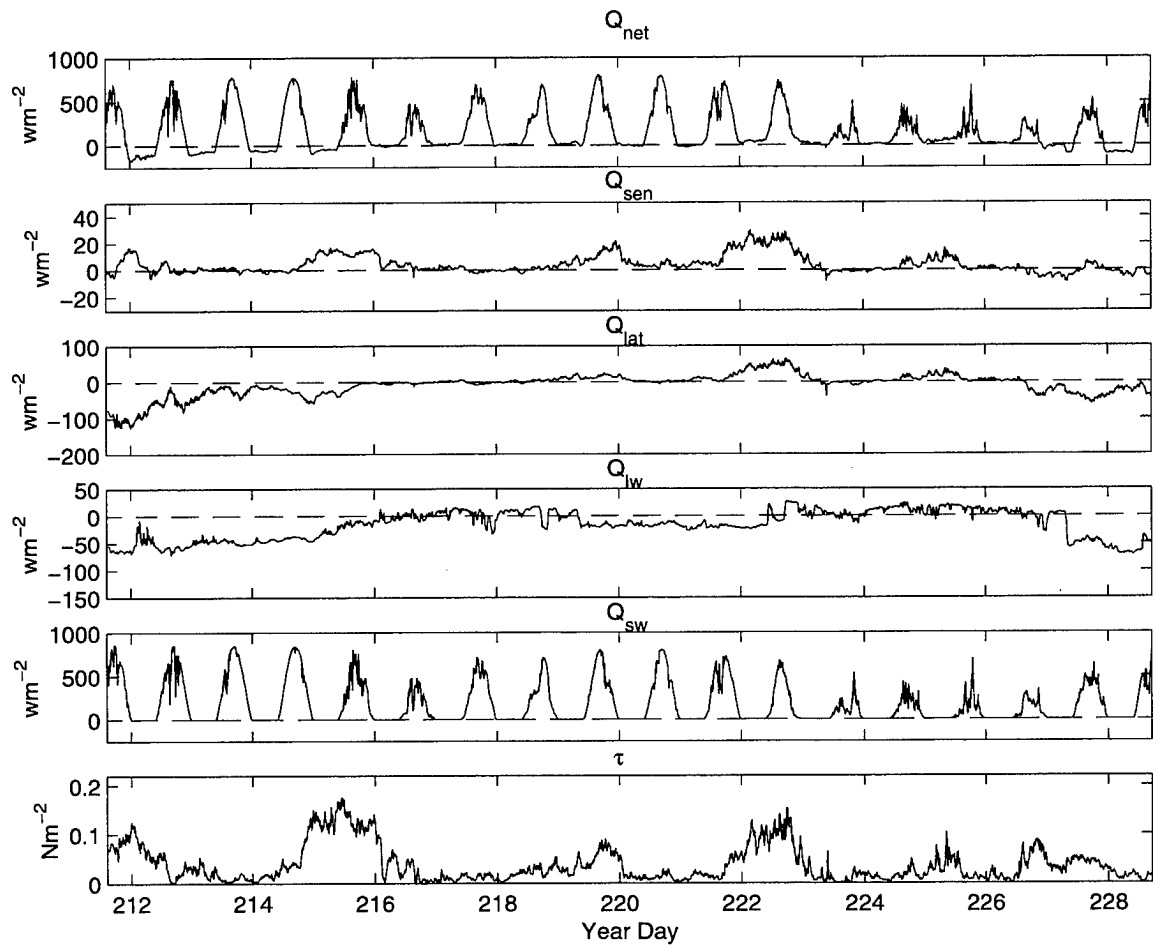
**Figure 18:** Air-Sea fluxes computed from the CBLAST-Low ASIMET buoy data during July-August 2001 deployment. Shaded areas indicate the time of the IOP.



**Figure 19:** Temperature time series data recorded by the CBLAST subsurface mooring during the 2001 pilot experiment.



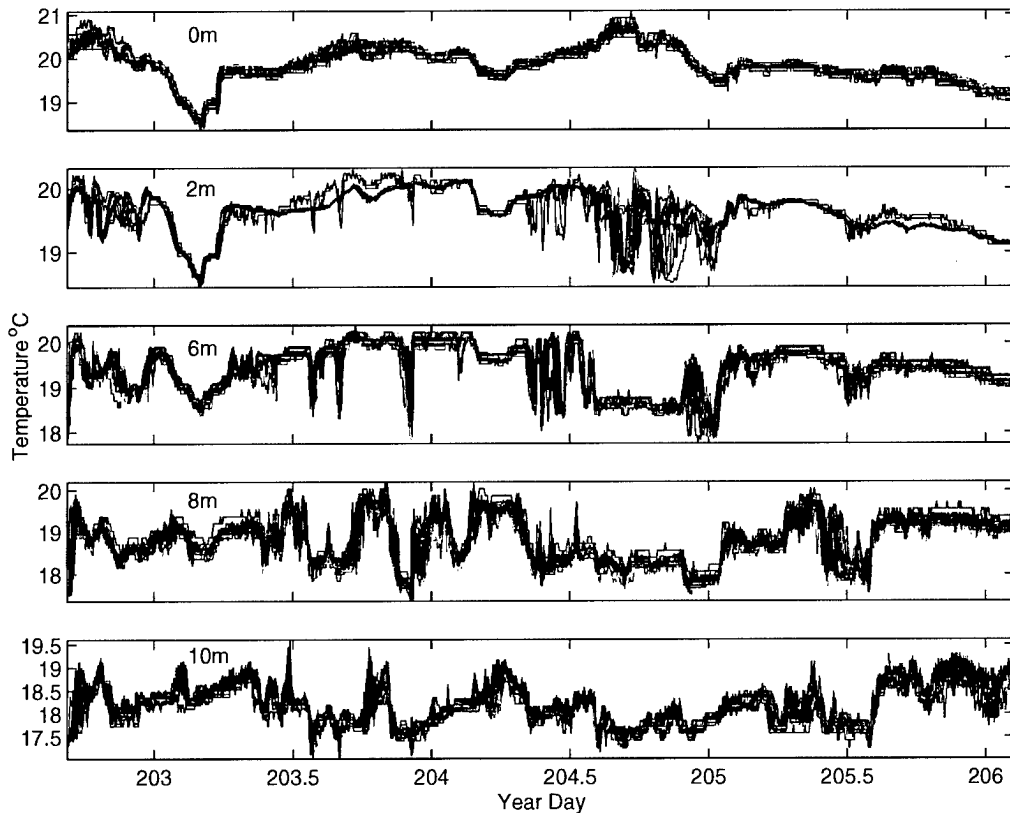
**Figures 20a-20b:** Standard meteorological measurements recorded by the CBLAST-Low SecNav ASIMET system during the July-August 2001 deployment period.



**Figure 21:** Air-Sea fluxes computed from the CBLAST-Low SecNav buoy data during the July-August 2001 deployment period.

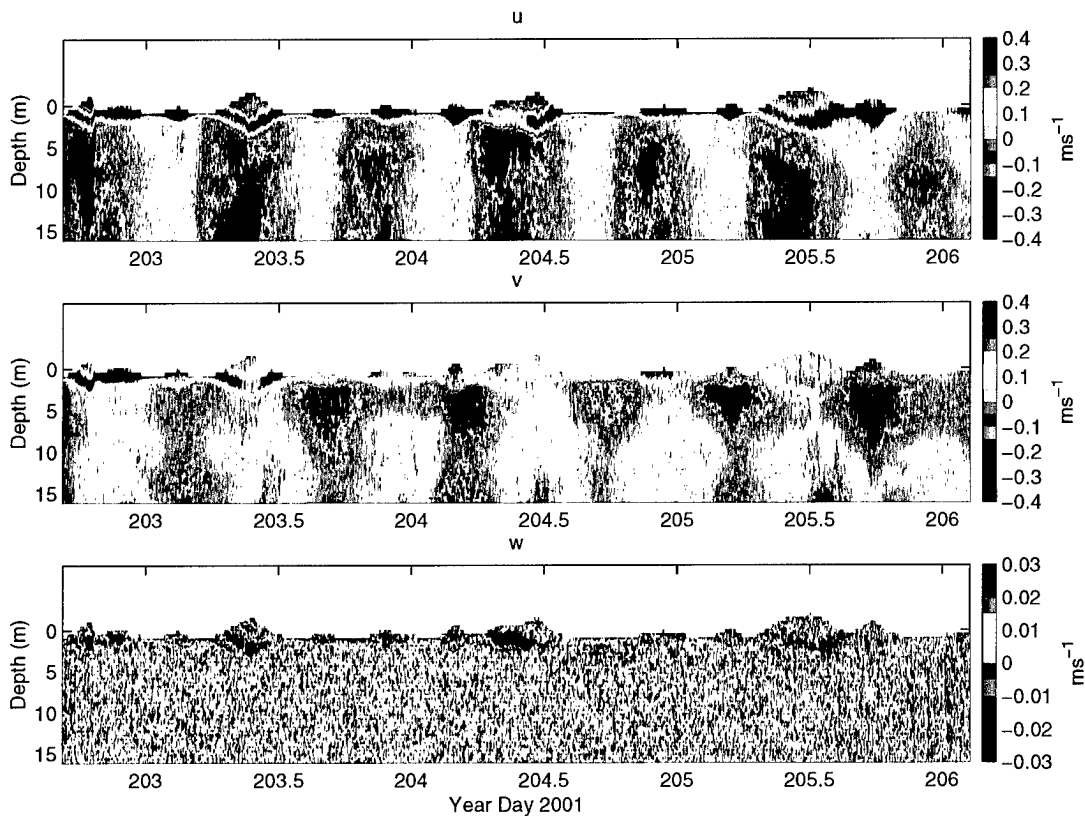
### 5.3 Three-Dimensional Net Data

Despite some loss, the percentage data return from the three-dimensional net vertical arrays was high. The variety and volume of instrumentation deployed on this one mooring accounted for the majority of the CBLAST-Low 2001 pilot instrumentation. Where necessary on instruments such as the MTR, WADAR and Brancker temperature recorders the appropriate calibration coefficients were applied and data converted into ASCII format and archived. Following this, all temperature data was again converted into MATLAB 'mat' format. An example of raw time series temperature data recorded at 5 upper levels in the three-dimensional array is shown in Figure 22.



**Figure 22:** Calibrated time series data recorded by instrumentation attached to the three-dimensional array at the 0m, 2m, 6m, 8m and 10m depth levels during the 2001 pilot experiment IOP.

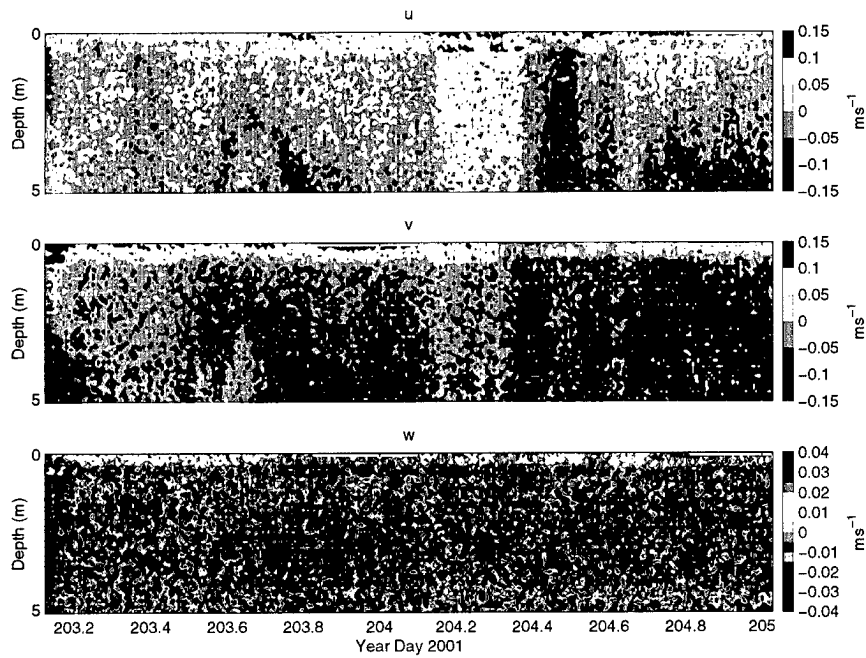
Fig 23 shows the three-dimensional velocity data recorded by the Nortek 1 MHz ADCP sited approximately 16 m below the center of the three-dimensional net. The figure illustrates the sinusoidal dominance of the semi-diurnal tidal currents in the deployment area at various levels in the water column.



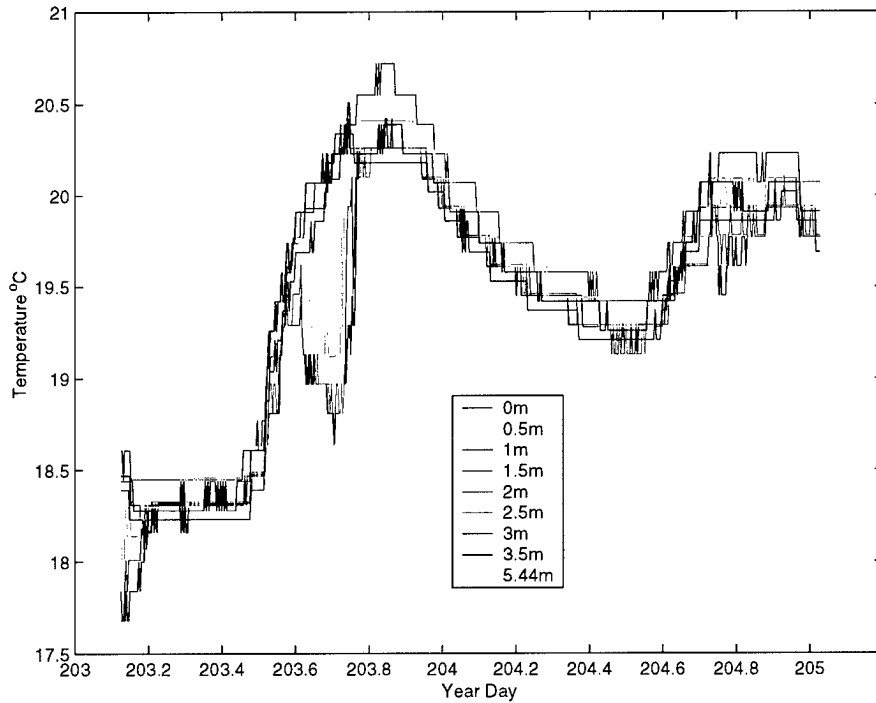
**Figure 23:** Velocity vector components recorded by the three-dimensional net Nortek 1Mhz ADCP during the 2001 pilot experiment IOP.

#### 5.4 Long-Line Data

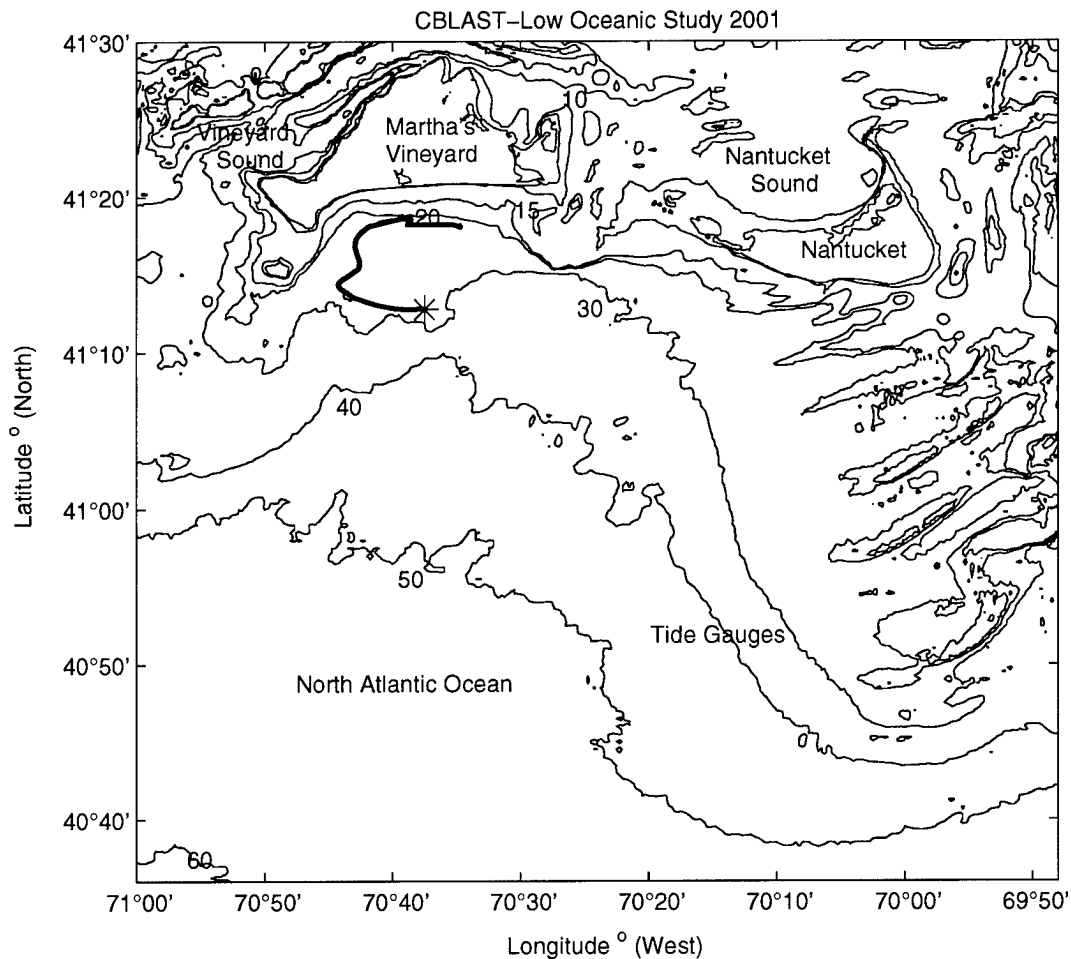
Fig 24 and Fig 25 show the results of the velocity and temperature records, respectively, recorded by Tidbit temperature sensors and the Nortek 2 MHz ADCP after release from the FV *Nobska*. The track of the buoy and long-line as recorded by ORBCOMM satellite telemetry is shown in Fig 26.



**Figure 24:** Velocity vector components recorded by the three-dimensional net Nortek 2Mhz ADCP attached to the buoy released during the 2001 pilot experiment IOP.



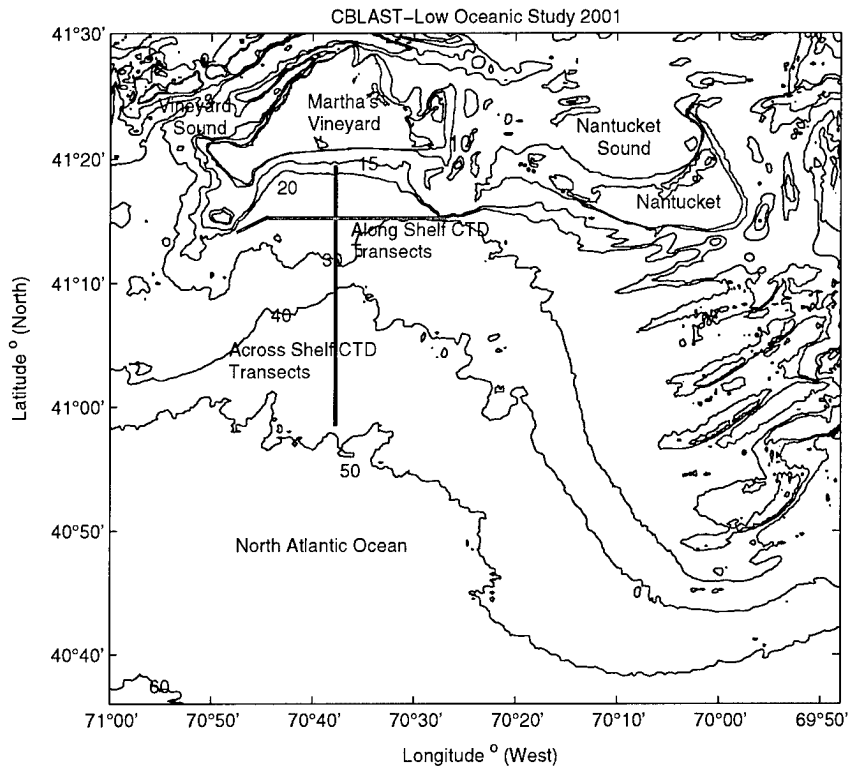
**Figure 25:** Temperature time/spatial series recorded at 8 vertical levels on the drifting buoy attached to the long-line whilst released during the 2001 pilot experiment IOP.



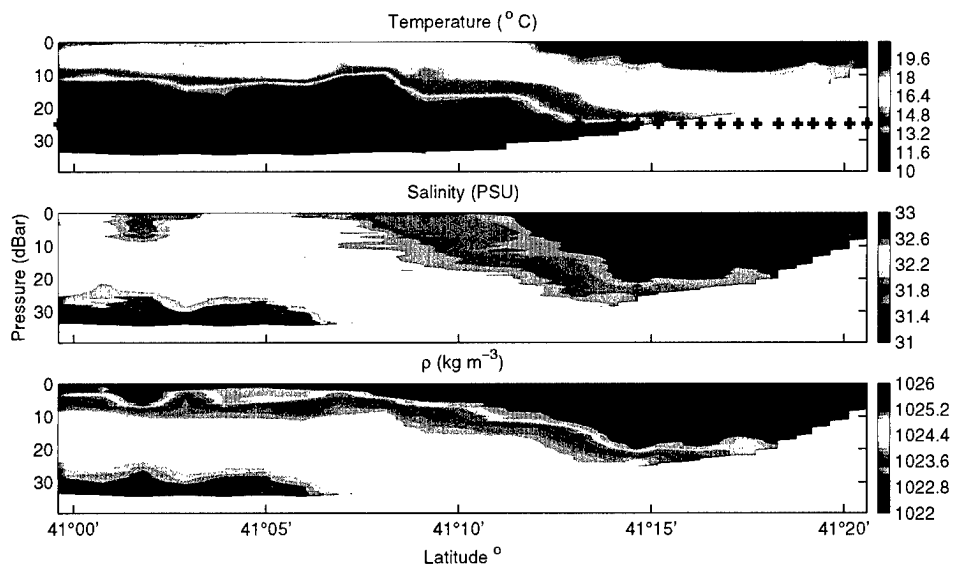
**Figure 26:** The drifting buoy and long-line track during its release in the CBLAST-Low 2001 pilot IOP. Star indicates the release point.

### 5.5 CTD Survey

Fig 27 shows the locations of the 4 CTD surveys completed along and cross shelf during the IOP period. Over 135 CTD cast data were downloaded from the instruments and all data appeared good quality. Post processing of the CTD data used SeaBird software to bin average data at standard depths and also compute density using the UNESCO International Equation of State for Seawater. An example of the processed profile data for the across shelf transect during July 25, 2001, is shown in Fig 28.



**Figure 27:** Geographical location of completed CTD transects recorded during the CBLAST-Low 2001 IOP.



**Figure 28:** An example of a CTD survey recorded on an across shelf transect during the CBLAST-Low 2001 IOP.

## 6. Summary

The 2001 CBLAST-Low pilot study proved a success and provided a high data return. In addition, the pilot experiment gave the opportunity to test out some new mooring concepts and ideas on survey methods and data collection in preparation for the main experiment.

The CBLAST and SecNav ASIMET meteorological systems and subsurface arrays also returned a complete data set. Analysis of the data sets will hopefully provide a good account of air-sea interaction in the study area. Comparisons between the measurements collected from the buoys will hopefully give a good account of the spatial and temporal variability in air-sea interaction across the shelf at the Martha's Vineyard study site.

The three-dimensional net mooring was probably the most innovative and daring aspect of this study. Through relatively simple but efficient engineering and fishing techniques, it was shown that the design and deployment of a three-dimensional mooring is viable. Despite rougher than anticipated environmental conditions the mooring 'weathered the storm' providing unique data.

However, some loss of instrumentation due to wave and swell that caused the nets supporting mesh ropes to saw or chafe through the top of the vertical arrays did occur. Fortunately, the majority of the instrumentation was recovered at a later date through dragging thus reducing the losses. Nevertheless, this raised some serious issues with the engineering, in particular the method of vertical string attachment to the net mesh. The fact that the three-dimensional net had only been deployed for approximately 4 days before instruments became detached was worrying. These problems are currently under investigation and a number of tests will be carried out at WHOI. We are optimistic that the issue of abrasion and wear at the points of instrument attachment will be resolved for the main experiment.

As discussed earlier in this report, long-line deployments across the New England shelf south of Martha's Vineyard were found not to be a viable option due to the intense fishing activity. This idea conceptually would work under open ocean conditions. The shortened long-line experiment using ORBCOMM tracking during the pilot experiment

was a learning experience and the probable outcome of this experiment will be the deployment of drifting buoys with no long-line arrays attached during the main CBLAST-Low experiments.

## **7. Acknowledgements**

We would like to thank Matt Stommel and the crew of FV *Nobska* for their hard work and commitment to making this study work. We are also in debt to Rick Trask and the Rigging Shop, Buoy and Mooring Operations Group, Ryan Brown for helping with instrument allocation and preparation, Nan Galbraith for computer support during the study and Rob Handy for instrument and mooring preparation.

CBLAST-Low funding to R.A. Weller comes from ONR Grant N00014-01-1-0029. Support for the SecNav buoy comes from the Secretary of the Navy / CNO Chair grant N00014-99-1-0090 to R.A. Weller.

## **8. References**

Gobat, J. I., R. A. Weller, B. S. Way, J. Lord, M. Pritchard, and J. Smith, 2001. A compact coastal ocean observing system for Kernel Blitz 2001. Woods Hole Oceanographic Institution Technical Report No. WHOI-2001-18, UOP Report No 2001-03, 53 pp.

## **9. Appendices**

### **9.1 Cruise Participants**

Woods Hole Staff

Tide Gauge Deployments

Mark Pritchard  
John Trowbridge  
Jeff Lord  
Ryan Brown

CBLAST-Low Buoy and ADCP Sled Deployment

Mark Pritchard  
Bob Weller  
Will Ostrom  
Paul Bouchard  
Ryan Brown

CBLAST-Low IOP

Mark Pritchard  
Bob Weller  
Paul Bouchard  
Jeff Lord  
Will Ostrom  
Brian Ward

CBLAST-Low Recoveries

Mark Pritchard  
Jim Ryder  
Jim Dunn

## 9.2 Manufacturers Instrument Descriptions and Specifications

Manufacturers specification of instruments used on various moorings during CBLAST-Low 2001 Pilot Experiment (excluding SecNav Buoy and subsurface mooring instrumentation , see Gobat *et al.*, 2001, for details).

**Table 9-1**

<b>Instrument</b>	<b>Property Measured</b>	<b>Accuracy</b>
SeaBird SBE 37	Temperature	0.002 °C
	Conductivity	0.0003 S/m
	Pressure	0.1 % FS
SeaBird SBE39	Temperature	0.002 °C
Brancker XL105	Temperature	± 29 m°C
MTR	Temperature	± 3.6 m°C
WADAR	Temperature	± 1.4 m°C
Onset Tidbit	Temperature	± 0.1°C
Nortek 1 MHz Aquadopp ADCP	Velocity u, v, w	± 0.02ms <sup>-1</sup>
Nortek 2 MHz Aquadopp ADCP	Velocity u, v, w	± 0.02ms <sup>-1</sup>
RDI 600KHz Workhorse ADCP	Velocity u, v, w	± 0.006ms <sup>-1</sup> SD (50, 1m bins)
SeaBird SBE 26 Tide Gauge	Pressure	± 0.01% FS
	Temperature	± 0.02 m°C
	Conductivity	± 0.0003 S/m
Seimac GPS	Geographical Position	± 10 m

## DOCUMENT LIBRARY

*Distribution List for Technical Report Exchange - July 1998*

University of California, San Diego  
SIO Library 0175C  
9500 Gilman Drive  
La Jolla, CA 92093-0175

Hancock Library of Biology & Oceanography  
Alan Hancock Laboratory  
University of Southern California  
University Park  
Los Angeles, CA 90089-0371

Gifts & Exchanges  
Library  
Bedford Institute of Oceanography  
P.O. Box 1006  
Dartmouth, NS, B2Y 4A2, CANADA

NOAA/EDIS Miami Library Center  
4301 Rickenbacker Causeway  
Miami, FL 33149

Research Library  
U.S. Army Corps of Engineers  
Waterways Experiment Station  
3909 Halls Ferry Road  
Vicksburg, MS 39180-6199

Marine Resources Information Center  
Building E38-320  
MIT  
Cambridge, MA 02139

Library  
Lamont-Doherty Geological Observatory  
Columbia University  
Palisades, NY 10964

Library  
Serials Department  
Oregon State University  
Corvallis, OR 97331

Pell Marine Science Library  
University of Rhode Island  
Narragansett Bay Campus  
Narragansett, RI 02882

Working Collection  
Texas A&M University  
Dept. of Oceanography  
College Station, TX 77843

Fisheries-Oceanography Library  
151 Oceanography Teaching Bldg.  
University of Washington  
Seattle, WA 98195

Library  
R.S.M.A.S.  
University of Miami  
4600 Rickenbacker Causeway  
Miami, FL 33149

Maury Oceanographic Library  
Naval Oceanographic Office  
Building 1003 South  
1002 Balch Blvd.  
Stennis Space Center, MS, 39522-5001

Library  
Institute of Ocean Sciences  
P.O. Box 6000  
Sidney, B.C. V8L 4B2  
CANADA

National Oceanographic Library  
Southampton Oceanography Centre  
European Way  
Southampton SO14 3ZH  
UK

The Librarian  
CSIRO Marine Laboratories  
G.P.O. Box 1538  
Hobart, Tasmania  
AUSTRALIA 7001

Library  
Proudman Oceanographic Laboratory  
Bidston Observatory  
Birkenhead  
Merseyside L43 7 RA  
UNITED KINGDOM

IFREMER  
Centre de Brest  
Service Documentation - Publications  
BP 70 29280 PLOUZANE  
FRANCE

REPORT DOCUMENTATION PAGE	1. REPORT NO. <b>WHOI-2002-03</b>	2. <b>UOP-2002-02</b>	3. Recipient's Accession No.
4. Title and Subtitle <b>CBLAST-Low 2001 Pilot Study</b> Mooring Deployment Cruise and Data Report; FV <i>Nobska</i> , June 4 to August 17, 2001		5. Report Date <b>May 2002</b>	
7. Author(s) <b>Mark Pritchard<sup>1</sup>, Jason Gobat<sup>2</sup>, William M. Ostrom<sup>1</sup>, Jeffrey Lord<sup>1</sup> Paul Bouchard<sup>1</sup>, Robert A. Weller<sup>1</sup></b>		8. Performing Organization Rept. No. <b>WHOI-2002-03</b>	
9. Performing Organization Name and Address  <b>Woods Hole Oceanographic Institution Woods Hole, Massachusetts 02543</b>		10. Project/Task/Work Unit No.  11. Contract(C) or Grant(G) No. (C) <b>N00014-01-1-0029</b> (G) <b>N00014-99-1-0090</b>	
12. Sponsoring Organization Name and Address  <b>Office of Naval Research</b>		13. Type of Report & Period Covered <b>Technical Report</b>	
15. Supplementary Notes <b>This report should be cited as: Woods Hole Oceanog. Inst. Tech. Rept., WHOI-2002-03.</b>			
16. Abstract (Limit: 200 words) <p>During the summer of 2001, several moorings and cruises were used as part of the CBLAST-Low (Coupled Boundary Layer Air-Sea Transfer under low wind conditions) pilot experiment in the North Atlantic, south of Martha's Vineyard Island, MA, USA. Six subsurface tide gauges were deployed around the study site for a period of approximately 3 months during the summer of 2001. Further, two surface buoys equipped with meteorological instrumentation and subsurface arrays that measured temperature, conductivity and velocity were deployed during the months of July and August 2001. For a short intensive operating period during July 2001, a newly manufactured three-dimensional mooring designed to sample three-dimensional properties of the upper ocean was deployed for a period of 6 days. During the Intensive Operating Period (IOP) along-shelf and across-shelf conductivity-temperature-depth (CTD) sections were completed as well as a drifting array designed to passively collect data from the upper water column released for approximately 24 hours. This report describes the instrumentation and type of moorings deployed by the Woods Hole Oceanographic Institution Upper Ocean Processes (WHOI UOP) group as well as data return and quality from the CBLAST-Low 2001 pilot study. This is summarized in graphical and tabular form in this report.</p>			
17. Document Analysis    a. Descriptors <b>CBLAST-LOW</b> <b>low wind</b> <b>air-sea interaction</b>  b. Identifiers/Open-Ended Terms          c. COSATI Field/Group			
18. Availability Statement  <b>Approved for public release; distribution unlimited.</b>		19. Security Class (This Report) <b>UNCLASSIFIED</b>	21. No. of Pages <b>72</b>
		20. Security Class (This Page)	22. Price