

**Synchrotron Radiation Based Study of X-Ray Absorption of
Flame Generated Nanoparticles**

Final Report on EOARD Contract Number :

F61775-01-WE060

J. Brian A. MITCHELL

**Physique des Atomes, Lasers, Molecules et Surfaces (PALMS), Université
de Rennes I, 35042 Rennes cedex, France**

16 September 2002

REPORT DOCUMENTATION PAGE

Form Approved OMB No. 0704-0188

Public reporting burden for this collection of information is estimated to average 1 hour per response, including the time for reviewing instructions, searching existing data sources, gathering and maintaining the data needed, and completing and reviewing the collection of information. Send comments regarding this burden estimate or any other aspect of this collection of information, including suggestions for reducing the burden, to Department of Defense, Washington Headquarters Services, Directorate for Information Operations and Reports (0704-0188), 1215 Jefferson Davis Highway, Suite 1204, Arlington, VA 22202-4302. Respondents should be aware that notwithstanding any other provision of law, no person shall be subject to any penalty for failing to comply with a collection of information if it does not display a currently valid OMB control number.
PLEASE DO NOT RETURN YOUR FORM TO THE ABOVE ADDRESS.

1. REPORT DATE (DD-MM-YYYY) 03-10-2002	2. REPORT TYPE Final Report	3. DATES COVERED (From - To) 5 September 2001 - 05-Sep-02
--	---------------------------------------	---

4. TITLE AND SUBTITLE Synchrotron Radiation Based Study of X-Ray Absorption of Flame Generated Nanoparticles	5a. CONTRACT NUMBER F61775-01-WE060
	5b. GRANT NUMBER
	5c. PROGRAM ELEMENT NUMBER

6. AUTHOR(S) Professor J. Brian A. Mitchell	5d. PROJECT NUMBER
	5d. TASK NUMBER
	5e. WORK UNIT NUMBER

7. PERFORMING ORGANIZATION NAME(S) AND ADDRESS(ES) University of Rennes I Campus de Beaulieu Rennes 35042 France	8. PERFORMING ORGANIZATION REPORT NUMBER N/A
---	--

9. SPONSORING/MONITORING AGENCY NAME(S) AND ADDRESS(ES) EOARD PSC 802 BOX 14 FPO 09499-0014	10. SPONSOR/MONITOR'S ACRONYM(S)
	11. SPONSOR/MONITOR'S REPORT NUMBER(S) SPC 01-4060

12. DISTRIBUTION/AVAILABILITY STATEMENT
Approved for public release; distribution is unlimited.

13. SUPPLEMENTARY NOTES

14. ABSTRACT

This report results from a contract tasking University of Rennes I as follows: The contractor will perform a 'study of soot growth and nucleation by a time-resolved synchrotron radiation based x-ray absorption method'. A gaseous fuel burner will be constructed that will allow a stable flame to be produced. It is here proposed to perform synchrotron-based experiments in which the mobility of the charged species can be studied. Such measurement is possible since the synchrotron radiation has a well-defined time structure and pump-probe type experiments can be performed. In order to do this correctly however, it is desirable to perform the experiments under vacuum and so a pre-mixed type of flame will be used. The burner assembly will be mounted in a vacuum chamber that can be mounted on the synchrotron radiation experimental bench. It is proposed to use cryopumping in order to achieve the high pumping rates necessary to allow a flame to burn in vacuum. (Cryopumping rates are typically 10 l/sec per square centimeter of cryosurface). In addition to the mobility experiments, it is proposed to examine the effects of incident wavelength on the absorption process in order to compare the results so obtained with existing models of x-ray absorption by graphite dust particles.

The goal of this work is to study the influence of the incident x-ray wavelength on the absorption process. The experimentation will be performed at the University of Rennes using the UV lasers in their laboratory. These will be used to investigate the thermal ionization of soot particles. The experiment will also be tried at the Vacuum Ultra Violet undulator beamline SU5 at the LURE synchrotron in Paris. If scheduling permits, this experiment will be performed using UV light in the 5-40 eV range.

15. SUBJECT TERMS
EOARD, Combustion, Soot Formation

16. SECURITY CLASSIFICATION OF:			17. LIMITATION OF ABSTRACT UL	18. NUMBER OF PAGES	19a. NAME OF RESPONSIBLE PERSON Wayne Donaldson
a. REPORT UNCLAS	b. ABSTRACT UNCLAS	c. THIS PAGE UNCLAS			19b. TELEPHONE NUMBER (Include area code) +44 (0)20 7514 4299

INTRODUCTION

The work described in this report is a continuation of a research program begun in 2001 under EOARD support (contract number F61775-00-WE039). The research concerns the use of high energy x-rays, produced at a synchrotron radiation facility for the study of soot particle distributions in both diffusion and premixed flames. Such information is important for our understanding of the basic mechanisms of soot formation in combustion. The observations made during this research have proved to be very exciting for it is found that ionization of the soot particles seems to occur via a co-operative phenomenon involving secondary electron emission and subsequently field induced electron emission, made possible by the nanometer dimensions of the target particles being irradiated. This phenomenon has applications outside combustion including astrophysics (x-ray irradiation of dust particles in circumstellar clouds) and in dusty plasmas.

Three scientific papers have already been published or accepted for publication resulting from work performed under EOARD support and these are listed below. A fourth paper, describing the construction and initial testing of a new apparatus has been prepared for submission and this is presented in the next section. This paper summarizes the work performed during the present contract period and thus serves as the final report.

Although falling outside the current contract period, a synchrotron radiation run is planned for 1 October 2002 and this will be performed at the LURE synchrotron radiation facility in Paris, France. This experiment will involve the irradiation of soot particles by vacuum ultra violet photons in the energy range from 75 to 200 eV and thus will be complementary to the studies performed at the ESRF facility in Grenoble, France where the irradiating photon energy range was from 5 to 35 keV.

As a result of the research performed under the previous contract phase and the demonstration of x-ray induced ionization of nanoparticles, a proposal was prepared for submission to the French Government sponsored Programme Nationale du Physico-Chimie du Milieu Interstellaire (PCMI) for the purchase of a high resolution, Reflectron Time-of-Flight mass spectrometer. This proposal was successful and this instrument will be purchased in the coming year. This will greatly enhance the capabilities of the apparatus described in this reported and constructed with funding from EOARD.

Publications arising from Research Performed under the Previous EOARD

Contract Number F61775-00-WE039

1. J. B. A. Mitchell, C. Rebrion-Rowe, J-L. LeGarrec, G. Taupier, N. Huby and M. Wulf

The use of x-ray synchrotron radiation to probe soot distributions in diffusion flames

(Accepted for publication by Combustion and Flame, 2002)

2. J. B. A. Mitchell, C. Rebrion-Rowe, J-L. LeGarrec, G. Taupier, N. Huby and M. Wulf

A New Apparatus for the Measurement of X-Ray Absorption by Flame Generated Particles

J.B.A. Mitchell, J.L. LeGarrec, D. Travers, C. Rebrion-Rowe, B.R. Rowe

P.A.L.M.S., U.M.R. no. 6627 du C.N.R.S.

Université de Rennes I, 35042 Rennes France

and

R.J. Randler, A. Plech and M. Wulff

European Radiation Radiation Facility (ESRF) Grenoble, France

I. Introduction

Mitchell et al. [1] have recently demonstrated a new technique for mapping soot particulates in a diffusion flame. This technique involves the detection of ionization produced following the absorption of high energy x-rays, generated by a third generation synchrotron radiation source (ESRF). The detection was accomplished by measuring the current to an electrically biased cylindrical probe that was maintained at a fixed distance from the path of the x-ray beam as it traversed the flame. The burner and probe assembly were mounted on a moveable platform so that the location of the intersection of the x-ray beam in the flame could be scanned horizontally and vertically in order to achieve the mapping. It was found that a strong ionization signal was observed that was a factor of ten greater than the ionization due to background air molecule absorption. Given the much lower density of carbon atom targets in the flame compared to oxygen and nitrogen molecules in the surrounding air, the

explanation of the flame ionization signal requires a cooperative ionization process that occurs in an aggregated solid particle [2,3]. Models of such processes have been developed by astrophysicists interested in high energy x-ray interaction with interstellar dust particles [4-5] but such models are directly applicable to other types of aggregated particulates.

A predicted outcome of this ionization process is the Coulomb induced fragmentation of the absorbing target structure. In order to test this hypothesis it is necessary therefore to search for evidence of such a fragmentation. To accomplish this, a new apparatus has been constructed that incorporates a time-of-flight mass spectrometer to sample the flame while it is irradiated by high intensity x-radiation.. Initial tests of this apparatus have been performed at the ESRF (European Synchrotron Radiation Facility) and these are described in the present report.

II Experimental Apparatus

A diagram of the apparatus is shown in figure 1.

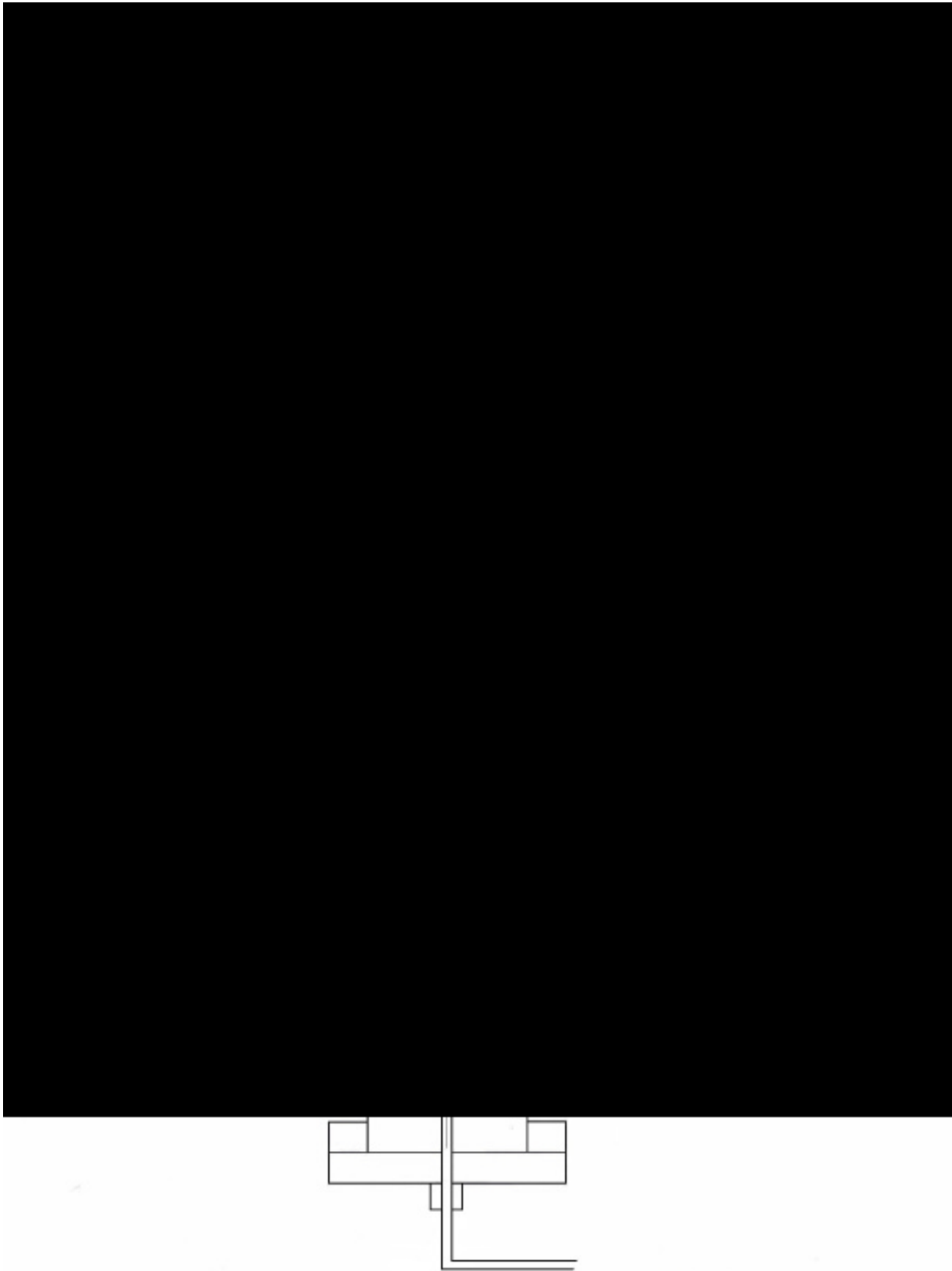

Fig. 1. Schematic of the new vacuum flame apparatus for use in synchrotron radiation experiments on x-ray and VUV radiation absorption by soot nanoparticles.

The fundamental difference between this apparatus and that used for the previous x-ray absorption flame experiment [1] is that, in order to perform the mass spectrometric sampling while employing vacuum pumps of a reasonable size, that can be easily transported to a synchrotron radiation laboratory, the flame must be burned under vacuum conditions. In order to do this, a premixed flame is used rather than a diffusion flame as in [1].

ii. Flame Production

Though it is certainly possible to burn a flame under vacuum condition, this requires special considerations with regard to the design and operation of the burner. Perhaps the most important of these is the necessity to have a sufficiently wide burner mouth so as to avoid auto-extinguishment. If the burner mouth is too small, the flame radicals can be quenched out at the surface since the mean free path is greater under vacuum conditions. Hence, in order to maintain the combustion, the burner walls must be farther away. In the present set-up, a burner having a mouth of 4 cm was used and with ethylene as a fuel gas, it was found that operation of the flame could be maintained down to about 20 torr. Below this, the flame self-extinguished.

The burner consisted of a cylindrical drum, 2 cm in height, 4 cm in diameter that was fed by a 6mm diameter tube through which the premixed air/fuel mixture passed. In order to achieve a uniform flow through the burner, the cylindrical drum was filled with 1 mm diameter glass beads, laid down in two layers, separated by stainless steel mesh screens. The supply tube was attached to the base-flange of the apparatus using a Ultra-Torr © O-ring sealed fitting that allowed the vertical position of the burner to be varied thus allowing the x-ray beam to interrogate different heights of the flame.

The flame produced by this burner had a luminosity that under vacuum conditions ranged from bright turquoise for fuel rich conditions to dull blue when air was in excess. This luminosity was seen in a flat disk, approximately 5 mm in height that was either attached to the exit screen of the burner or stood off by 2 or 3 mm from the output screen, depending upon fuel flow. Under very fuel rich conditions, a yellow luminous region was observed downstream of the flame disk indicating the presence of visible light emitting soot particles.

Ignition of the flame was performed while the system was at atmospheric pressure and once stable burning was achieved, the system was pumped down using a 340 liters/min rotary vacuum pump. It was found that this operation could be performed while maintaining chambers II and III under vacuum though for safety purposes, the turbomolecular pump, used to pump chamber II was reduced to stand-by mode (50% rotation speed). While chamber I was at atmospheric pressure, the pressures in chambers II and III respectively were 6 torr and 1×10^{-4} torr.

iii. Mass Spectrometer

The system is equipped with a Wiley-McLaren type time-of-flight mass spectrometer [6]. Ions enter chamber II through a 0.2 mm diameter aperture located at the center of an electrically insulated molybdenum disk. A vacuum seal between chambers I and II was obtained by compressing this plate between two teflon rings. Following passage through this aperture, the ions approach the first plate of the mass spectrometer but positive ions are normally repelled from this plate as it is maintained at a positive potential. This plate can however be pulsed to ground, thus allowing ions to pass through its aperture following the region between the first and second plates whereupon the voltage is returned to its original

state. This serves not only to block further entry of positive ions but to eject those in the inter-plate region causing the resulting packet of ions to move towards the third plate which is maintained a negative potential. The ions are thus accelerated by this potential and subsequently drift upward along the long tube before reaching the first dynode of the electron multiplier at the top of the apparatus. Negative potentials on the second and third plates serve not only to accelerate the positive ion packet but to repel any negative ions or electrons entering from the flame.

iv. X-Ray Beam

The ID09 beamline at the ESRF was used for these experiments. Technical details of this line's features together with specifications of beam characteristics are available at reference [7]. This line is capable of yielding either a monochromatic beam or a white beam and in fact the latter was used for these experiments. This beam, produced by an undulator, has a spectrum that extends between about 5 and 35 keV. The beam passes through the air and this was the reason for choosing hard x-rays as a probe for flame particles in the original experiments that were performed using an atmospheric pressure flame [1]. In order to permit entry of the x-ray beam into the flame chamber, an aluminum window was used that was transparent to the x-ray radiation yet maintained a vacuum tight seal. This window was constructed using ordinary 10 micron thick commercial aluminum foil, epoxied onto a 14 mm outer diameter, 6mm diameter aperture, stainless steel washer, that was fitted into a 1/4" Ultra-Torr © fitting [8]. The vacuum seal was completed using a means of a circular rubber washer placed between the foil supporting washer and a second stainless steel washer, epoxied to the inside part of the Ultra-Torr fitting. The whole assembly is illustrated in figure 2.

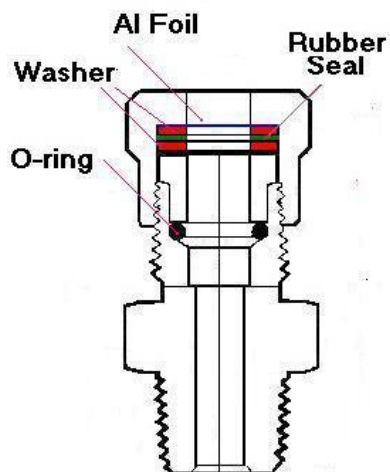

Fig. 2. Diagram of the aluminium window assembly through which the x-ray beam passes into the flame chamber.

This very inexpensive device proved to be very rugged, yielded no vacuum concerns and allowed passage of a sufficient x-ray intensity to perform the required experiments. Indeed, so intense was the beam that it produced dark spots in the pyrex exit window (and on a mirror mounted at 45° outside the apparatus) due to the formation of color-centers.

III. Results and Discussion

The apparatus received its first test at the ESRF in May, 2002 during a four day run. Unfortunately, the mass spectrometer was not operational during this run but other aspects of the apparatus and of the x-ray absorption were tested. As mentioned above, the ions formed in the flame (in chamber I) pass through a 0.2 mm diameter aperture in the sampling cone and enter chamber II and thence through a second 0.2 mm diameter aperture, thus passing into chamber III where the mass spectrometer assembly is located. This second aperture is electrically isolated and it was found that by applying a bias voltage, using a floating power supply, a current that was due to flame ions could be measured using a Keithley electrometer. In practice, a bias of -22V was used for these measurements. Figure 3 show the current measured on this aperture plate as a function of distance between the burner mouth and the tip of the first (earthed) sampling cone.

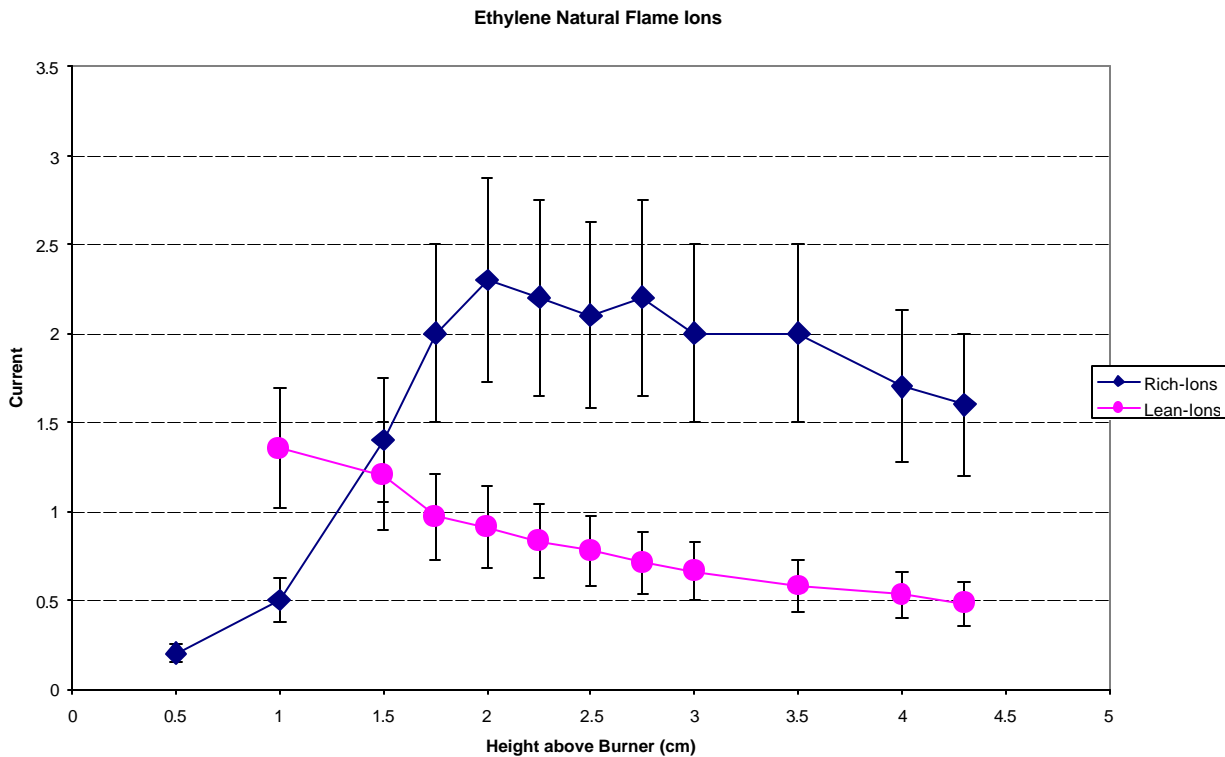

Fig. 3. Current measured as a function of height above the burner on the entrance electrode to mass spectrometer due to natural flame ionization for lean and fuel rich ethylene flames.

This current is due to the natural flame ionization and is the result of chemiionization reactions, for short burner sample cone distances and to the thermal ionization of large molecular species and of soot particles for larger distances. The measurement was taken for a lean ethylene flame that showed no soot luminosity and a fuel rich flame that displayed the characteristic orange-yellow emission due to the presence of hot soot particles. Extensive studies have been made by other workers of these ionization processes and of the distribution of ionization as a function of height for premixed flames [9]. The total ionization results shown here are similar to those found by other workers who have used either Langmuir probes or mass spectrometers to detect the ions.

It is seen that the natural ionization increases with height for the rich flame and this is because the soot particle density rises with height in the region displayed and these particles are constantly being thermally ionized. The natural ionization decreases with height for the lean flame as the natural flame ions formed in the reaction zone recombine with free electrons in the flame and there is not enough soot particles to provide much thermal ionization.

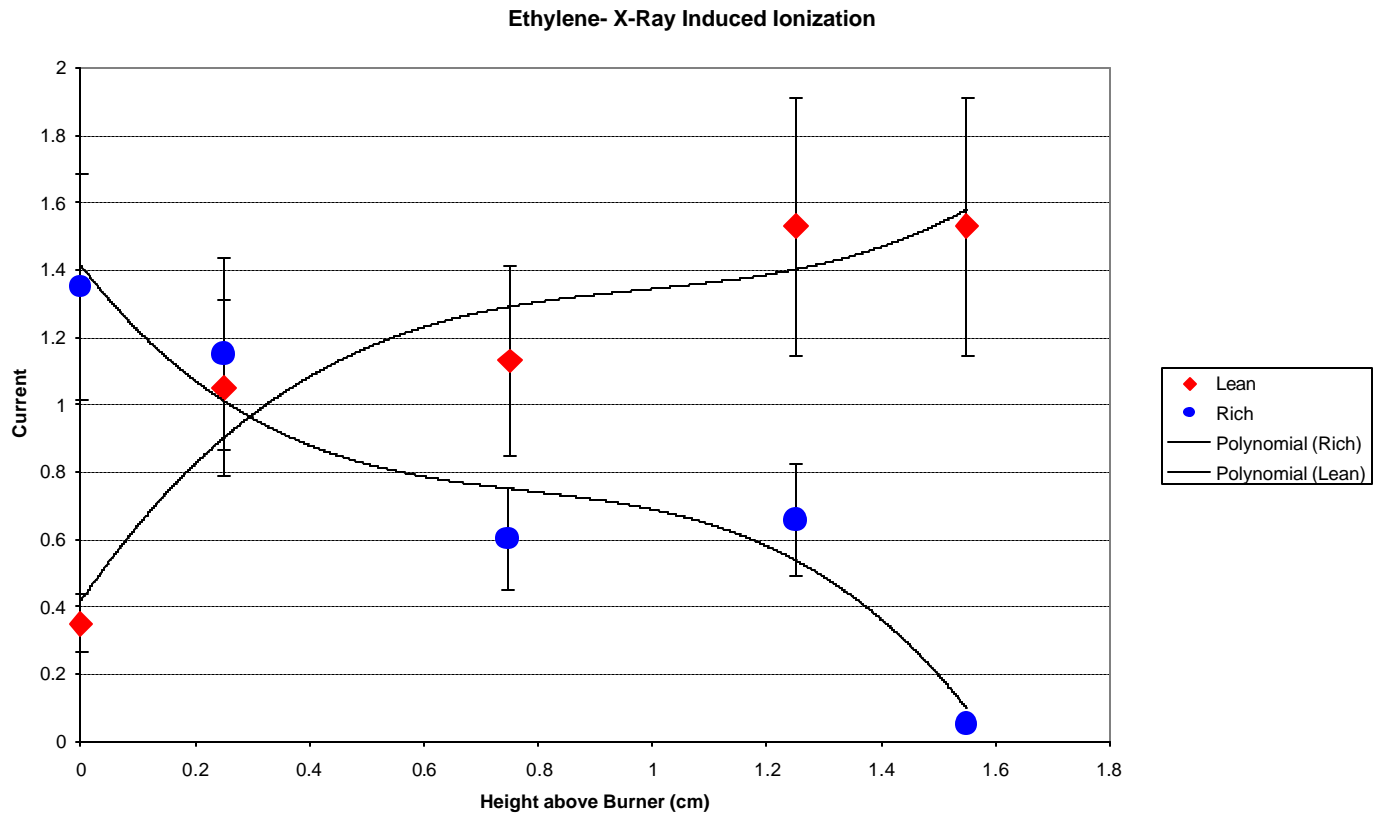

Fig. 4. Ionization current due to x-ray absorption, measured on entrance electrode to mass spectrometer as a function of height above burner. The lines serve rather to guide the eye.

Figure 4 shows the ionization signals produced due to passage of the x-ray beam through the lean and fuel rich flames respectively. Here an interesting observation for it is seen that once in the region where soot particles have been formed, the signal is rather steady for the lean flame. The signal is seen to decrease however for the case of the rich flame. Not only does the soot particle density rise higher up in the rich flame but the particle size also increases [10]. This implies that either the ionization becomes less efficient as the particle size

increases or that the ionized particles are more easily neutralized when larger. The latter proposition seems to run counter to what is seen in figure 3.

Hessler and co-workers [11] have studied the small angle scattering (SAS) of x-rays by soot particles in flames and information concerning particle size can be extracted from their observations. In a recent experiment where ionization yields were measured concurrently with SAS it has been found that the highest ionization yields correspond to the presence of small soot particles [12].

Clearly further study is necessary to shed more light on this interesting phenomenon of x-ray induced ionization of soot nanoparticles. Such studies are planned and will include not only the application of mass spectrometry to the process but an extension of the research to other wavelength domains including the vacuum ultra violet. The vacuum capabilities of the above described apparatus will make such studies possible.

Acknowledgements

The authors would like to acknowledge the financial support of the European Office of Aerospace Research and Development, Air Force Office of Scientific Research, Air Force Laboratory under Contract No. F61775-01-WE060. Additional financial support was provided by the European Synchrotron Radiation Facility and by the French Programme Nationale du Physico-Chimie du Milieu Interstellaire. Special thanks are due to Jacques Sorieux, Jacques Katan and Sandrine Evenot for the construction of the apparatus and to the staff of the ESRF for their assistance with the experimental measurements.

References

1. J. B. A. Mitchell, C. Rebrion-Rowe, J-L. LeGarrec, G. Taupier, N. Huby and M. Wulf

The use of x-ray synchrotron radiation to probe soot distributions in diffusion flames

(Combustion and Flame) 2001

2. J. B. A. Mitchell, C. Rebrion-Rowe, J-L. LeGarrec, G. Taupier, N. Huby and M. Wulf

(2002)

Nanoparticle Destruction by X-Ray Absorption

Astronomy and Astrophysics **386**, 743

3. J.B.A. Mitchell

Electron Collisions with Aggregated Matter

(Sousmis à Electron Scattering from Atoms, Molecules, Nuclei and Bulk Matter (ed. C.T.

Whelan)

Kluwer Academic, Plenum Publishers, London 2002

4. W.D. Watson and E.E. Salpeter, *Astrophys. J.* **174**, 321, 1972.

5. B.T. Draine and E.E. Salpeter, *Astrophys. J.* **231**, 77, 1979.

6. W.C. Wiley and I.H. McLaren, *Rev. Sci. Instrumen.* **26**, 1150, 1955.

7. WWW.esrf.fr.

8. Swagelok Corporation, Solon, OH 44139, USA.

8. A.B. Fialkov, *Prog. Energy Combust. Sci.* **23**, 399, 1997.

9. R.A. Dobbins and C.M. Megaridis, *langmuir* **3**, 254, 1987.

10. J.P. Hessler, S. Seifert, R.E. Winans and T.H. Fletcher, *Faraday Discussions* **119**, 395,

2001.

11. J.P. Hessler (private communication).

Appendix I

J. B. A. Mitchell, C. Rebrion-Rowe, J-L. LeGarrec, G. Taupier, N. Huby and M. Wulf (2002)

The use of x-ray synchrotron radiation to probe soot distributions in diffusion flames

(Accepted for publication by

Combustion and Flame,)

X-Ray Synchrotron Radiation Probing of an Ethylene Diffusion Flame

J. B. A. Mitchell, C. Rebrion-Rowe, J-L. LeGarrec, G. Taupier, N. Huby

Equipe d'Astrochimie Expérimentale, P.A.L.M.S. , U.M.R. du C.N.R.S. No. 6627,

Université de Rennes I, 35042 Rennes cedex, France

and

M. Wulff

European Synchrotron Radiation Facility (ESRF)

BP 220, F-38043, Grenoble cedex, France

ABSTRACT

Experimental results are presented from an experiment in which ionization created by a high energy x-ray synchrotron radiation beam intersecting an ethylene diffusion flame is measured. The ionization signal is believed to arise from x-ray absorption by aggregated soot particles. Comparisons are made between these ionization profiles and those due to natural flame ionization. Visible light absorption measurements were also performed to determine the soot volume fraction in the beam and the results compared with the x-ray induced signals.

1. INTRODUCTION

The purpose of this report is to present the first results from an alternative flame sampling method that uses x-rays to probe soot particles. The method is based upon detecting the charged species formed from the ionization of soot nanoparticles by x-ray absorption, a process commonly referred to as *photoemission*. High energy X-rays are very penetrating due to their weak interaction with matter and thus the problems associated with absorption or re-absorption of visible or ultraviolet light can be avoided. This weak interaction makes it difficult to use scattering or transmission methods for assessing the presence of soot particles but the high efficiency with which charged particles can be detected renders the technique feasible. Indeed in the experiment described below, detection of the ionization currents was achieved with the use of a simple electrically biased wire probe.

2. EXPERIMENTAL METHOD

The experiment was carried out using the ID09 beamline at the European Synchrotron Radiation Facility (ESRF) in Grenoble, France. The photon flux was 3×10^{11} photons/sec and the beam dimensions at the flame were $50\mu\text{m} \times 50\mu\text{m}$. The beam were produced using an undulator that yielded x-rays ranging in energy from 10 to 30 keV. For the present experiment, no monochromatization of the beam was performed thus it is referred to as a

white beam. Details of the synchrotron and the ID9 beamline including operating characteristics can be found in ref. [1]. The flame was formed on a 11 mm diameter cylindrical tube through which the fuel flowed. This tube was surrounded by a 100 mm diameter tube through which air from a compressor was made to pass. A fuel flow rate of 62 ml/min of ethylene and 39 l/min of air yielded a flame with a visible height of 40 mm. The flame was scanned horizontally and vertically by the x-ray beam in order to map out the location of soot particles formed during the combustion process. They were detected by measuring the ionization current, resulting from x-ray absorption, using a 1 mm diameter, stainless steel rod, held at a fixed distance of 18 mm with respect to the point of entry of the x-ray beam. A ± 22 V electrical bias was applied to the probe using a floating power supply which was connected to ground via an electrometer. A schematic of the experimental arrangement is shown in figure 1.

Prior to performing measurements on the actual flame, ionization produced by passage through the background air and while ethylene gas flowed through the burner was measured in order to determine the baseline ionization signal. It was found that air and ethylene produced similar ionization yields.

In a separate experiment, the absorption of 632.8 nm light from a helium-neon laser was measured, as a function of radial and vertical distances in the flame and this measurement was used to determine the soot volume fraction distribution.

3. RESULTS

The probe was biased respectively with voltages of +22V and -22V and currents were measured as the flame was scanned across the x-ray beam at a given height above the burner mouth. This procedure was repeated for a range of heights from 1 mm to 38 mm. In each case measurements were made with and without the x-ray beam. Additional scans were made without the flame present so that just the background air was responsible for measured currents and this measurement was repeated with ethylene gas flowing through the burner but without the flame being ignited. It was found that there was no significant difference whether ethylene was present or whether the absorption was just in air. The current values obtained in these no-flame measurements were subtracted from the x-ray induced flame signals discussed in the next paragraph.

A selection of results are shown for negative measured currents in figure 2 and for positive currents in figure 3. The figures show the currents obtained without the beam and

with the x-ray beam. The difference in these measured values (with the background ionization signal removed) is also shown, as is the ionization signal measured without the flame present. It is seen that there is a small difference at low heights above the burner. On the other hand a strong difference in the signals is seen for heights above about 14 mm. Thus this demonstrates that x-ray absorption by flames can be observed and this may serve as an additional technique for sampling components of a flame. A number of factors have to be analyzed however, in order to understand what exactly is responsible for the ionization signals observed.

i. X-ray absorption

High energy X-ray photons are absorbed primarily by atomic inner-shell electrons (rather than outer-shell valence electrons as is the case for ultra-violet absorption). The electrons are ejected from the atom and thus a primary ionization event occurs that leaves one or more inner-shell vacancies in the target atom. This vacancy is then filled by an electron from a higher level either of the target atom or of a neighboring atom. In this event a high energy photon can be emitted (fluorescence) or the energy release can be absorbed by the ejection of another electron from the atom (the Auger effect). If a lower lying electron is ejected then a second such Auger process can occur etc. This is known as an Auger cascade though in fact for carbon, only one, 262.4 eV Auger electron is released [2].

Since the target atom is located within a solid matrix (i.e. the soot particle), the departing primary photoelectron and the Auger electron must traverse this material in order to escape. The mean free path of a 10 keV electron in carbon is of the order of 1200 nm so it will most likely simply leave the particle without further interaction. That for a 260 eV electron is of the order of 5 nm however, and so it will undergo inelastic collisions with other atoms in the solid, resulting in secondary electron emission. Thus the primary x-ray absorption can lead to the ejection of a number of electrons. If these electrons do not return to the particle, the positive charge built up will give rise to an electric potential and a corresponding electric field can thus be created around the particle and also within the particle if it is non-conducting. The removal of relatively few electrons can lead to the production of very high electric fields for articles with nanometer dimensions. Studies [3-5] have shown that fields of the order of between 10^6 and 10^7 V/m induce field emission of electrons from carbon substrates. From an isolated particle, this phenomenon can be a runaway process and it has been predicted [6-8] that this can lead to the actual disruption of the particle that will break up into positively charged fragments and free electrons. Electron microscopic [9-11] and mass spectrometric [12] studies of soot particles have shown that they display a fractal-like, aggregated structure

and at medium heights in the flame they consist of both graphite like and aromatic or polyaromatic materials. It is very likely therefore that strong electric fields can be induced within such particles that would lead to their subsequent disruption [8]. The mechanism of x-ray induced ionization is discussed in more detail elsewhere [13].

ii. Soot particle density in the flame

As mentioned above, visible light absorption measurements were performed in order to map the soot volume fraction in the flame. The laser beam intensity transmitted through the flame was measured using a power-meter. The ratio between absorbed and initial intensities I/I_0 can be related to the soot volume fraction f_v according to the formula [14] :

$$f_v = \frac{I}{KL} \ln\left(\frac{I}{I_0}\right) \dots\dots\dots(1)$$

where λ is the wavelength of the light (632.8 nm), L is the optical path length of the beam through the flame and K is a constant that depends upon the refractive index of the soot. We have used a value of $K=4.9$ as recommended by Choi et al. [14].

Measurements were made as a function of distance across the flame for a range of heights from 1 mm to 40 mm. The results of these measurements are seen as a series of curves of f_v versus radial distance in figure 4 . These curves can be subject to tomographic reconstruction [15,16] in order to render the radial distribution of soot particles but for the purposes of the present paper we chose not to display the data in this form since it is used to compare with the x-ray absorption measurement, shown in figures 2 and 3.

It can be seen from figure 4 that the soot volume fraction is low up to around 10 mm above the burner and this coincides with the region where there is little signal due to x-ray absorption. Above this however, and up to about 40 mm, the soot volume fraction is high, and it is in this region where the strong x-ray induced ionization signals are seen.

Some of the curves seen in figure 4 are also shown in the plots shown in figures 2 and 3. The purpose of this exercise is to indicate the respective spatial zones where the visible light and x-ray absorption processes occur.

iii. Current measurement

The actual current registered by the cylindrical probe is determined by a number of factors and the basic theory for the high pressure electrostatic probe has been presented by Clements

and Smy [17]. This theory applies to a flowing medium and under this condition, the current is brought to the probe by convection rather than by diffusion as happens when the electrostatic (Langmuir) probe under used at low pressure (vacuum) conditions. One can write down an equation for the measured current, thus:

$$i = 5.3 \left(\epsilon_0 \mu_i r V^2 e^3 u^3 n_i^3 \right)^{1/4} L \dots\dots(2)$$

where ϵ_0 is the permittivity of free space, μ is the mobility, V , the probe bias potential, u , the flow velocity, r the probe radius, e is the electronic charge, n_i the charge density and L is the length of the probe.

It can be seen that the measured current is proportional to the fourth root of the mobility of the charge carrier, i.e. $(\mu)^{1/4}$. The mobility in turn is a function of the square root of the ion mass

$$\mu_i = \frac{3 e}{8 n \sigma} \left[\frac{1}{2} \frac{\pi m_i + m}{k T m_i} \right]^{1/2} \dots\dots\dots(3)$$

or an inverse function of charge carrier diameter for particulates.

$$\mu_p = e / (3 \eta d) \dots\dots\dots(4)$$

where e is the electronic charge, n the number density of molecules in the gas, σ the ion collision cross section, T , the temperature, k , Boltzmann's constant, m the mass of the molecules and m_i the ion mass. η is the gas viscosity and d the particle diameter.

Thus for example, electrons are very highly mobile in comparison with positive or negative molecular ions. (Typical mobilities for free electrons in flames are 2000-6000 $\text{cm}^2\text{V}^{-1}\text{s}^{-1}$ while for atomic ions (Na^+) the value is typically 1 $\text{cm}^2\text{V}^{-1}\text{s}^{-1}$. Mobilities for soot particles range from 10^{-2} - 10^{-3} $\text{cm}^2\text{V}^{-1}\text{s}^{-1}$ [18]).

Current vs voltage (I-V) characteristics for the probe used in the present experiment showed that neither the electron nor the ion signal reaches saturation even when high bias voltages are used and in fact this is typical for probes used at high pressures [18,19]. It is also seen that for the ± 22 V used in the x-ray absorption experiments, the electron current at this height is about a factor of four larger than the respective positive ion signal.

Figure 5 shows a plot of the x-ray absorption induced negative and positive ionization currents as a function of height above the burner. It can be seen from these figures that over

most of the height range, the negative current is considerably larger than the positive current. The positive current rises steadily over the range, reaching a maximum around 35 mm while the negative current peaks at around 15 mm, subsequently falling off at greater heights until it attains a value close to that of the positive current. This observation can be explained in light of equation 2. The number of negatively charged species produced by x-ray absorption must equal the number of positively charged species in order to maintain charge neutrality. This suggests therefore, that the mobility of the negative carriers is decreasing in the range where the positive current is seen to decrease. An explanation for this is that, if low in the flame, the negative charges are carried by electrons or by light negative ions, then further up, these electrons or negative ions attach themselves to soot particles thus resulting in a reduction of mean mobility.

iv. Natural flame ionization

It is well known that flames contain ions that are produced via chemiionization processes such as:

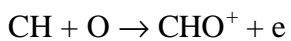

in lean flames and

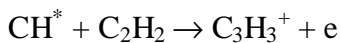

in fuel rich flames. As soot particles form, they also can be thermally ionized as their ionization potential is low (4.4 eV for graphite). Extensive studies have been performed using both Langmuir probes and mass spectrometric sampling to plot out the distribution of such ionized species as a function of height in premixed flames burned both under atmospheric pressure and under vacuum conditions. A very extensive review of this subject has been given by Fialkov [18] and it is therefore not necessary to further elaborate on the state of our knowledge in this area, here. As can be seen in figures 2 and 3 however, when the x-ray beam is off, there is a always strong ionization signal seen and this is due to the natural flame ionization.

As mentioned above, a probe with a diameter of 1 mm was used and the burner mouth had a diameter of 12 mm. Given these dimensions, it can be seen that the positive and negative ion (electron) currents fall within a cylindrical region having the diameter of the burner but remain much wider than the light absorbing (emitting) soot regions, illustrated in figure 4. The dimensions of the probe are such that perturbation of the flame can be expected and this will doubtless influence the measurement of the natural flame ions. Given that the probe was located downstream of the point of entry of the x-ray into the flame, it should not

however, effect the measurements due to x-ray absorption except with regard to collection efficiency of the charged species. The position of the probe with respect to the x-ray beam was decreased from 18 to 5 mm in a separate series of measurements but apart from a change in signal strength, no other obvious effect was noted.

4. DISCUSSION

Examination of figures 2 and 3 and comparison with the results of the light absorption experiments (figure 4) indicate that at least spatially, there is little relationship between the species responsible for the x-ray absorption and that responsible for the laser light absorption i.e small soot particles. Comparison with the natural flame ionization shown in figures 2 and 3 indicates that low in the flame, there is no relationship while above 14 mm, the x-ray ionization profile begins to closely resemble that of the natural flame ionization. As mentioned in the section concerning x-ray ionization processes, the large ionization current seen in the synchrotron measurements demands a mechanism whereby several electrons are produced per ionization event and this can be understood , at least qualitatively, if the Auger electron traverses an extended particle thus causing secondary ionization events and eventual runaway field ionization. This suggests therefore that the absorption induced ionization is not the signature of a small spherical particles but more likely of a mature agglomerated structure.

i. Soot aggregation

A great deal of work has been done previously to characterize the structure of the diffusion flame and in the present study, we have not sought to reproduce this analysis but rather to demonstrate a new method of flame sampling. We can however use the data collected by other workers to interpret what is seen here. If one examines the work of Santoro and co-workers on the characterization of an ethylene diffusion flame, [20], it seen that the structure of the soot volume fraction found in those experiments resembles what we have found here using the simple absorption method. Absorption has a limitation however, for as discussed by Dobbins and Megaridis [21], the absorption cross section for a porous aggregated structure consisting of n primary particles is simply n times the absorption cross section for the individual primary particles. Hence an absorption measurement cannot yield information as to whether the absorbing particles are individual or aggregated.

Light scattering techniques are sensitive however to aggregate structure and using refined theoretical methods [21,22], optical measurements can yield structure information that is in agreement with what is found by Transmission Electron Microscopic (TEM)

examination of thermophoretically sampled soot particles [9,22]. Such methods have been employed by Puri et al. [23] for a re-examination of the soot particle distribution in an ethylene diffusion flame. As seen in figures 3 and 5 of that paper, while the primary particle number density is rather constant over most of the height of the flame, the number of aggregated structures diminishes by about one and a half orders of magnitude. The diameters of the primary particles doubles over the same region while the radius of gyration of the aggregates increases by about a factor of three. This clearly shows that aggregation is a dominant process over most of the flame and that the majority of soot particles are in fact aggregated. Puri et al. have suggested that the flame can be divided into four regions. I: a soot inception and coagulation region close to the burner mouth; II: a growth region where aggregation and surface growth dominates; III: a region where aggregation and oxidation compete and IV: a region where soot particles that survive oxidation are released into the surroundings as smoke particles. This concept has however recently been disputed by di Stasio [24].

Thermophoretic sampling of soot from diffusion flames by Dobbins and Megaridis [9] has shown that the annular region is rich in aggregated particles and comparison with temperature profiles taken by Santoro et al. [25], shows that this is a region where the temperature is highest. Dobbins and Megaridis also found that the primary particle size in the aggregates increased with increasing height in the flames and that particles inside the annular region were less aggregated and smaller in size. Studies of Homann [26], Calcote [27] and others have shown that soot particles often carry electric charges and that positively charged particles tend to be in excess. This is explained as being due to electron loss due to thermionic emission and the high temperature in the annular region will be conducive to this effect. (Negative charging of soot particles is due to electron or negative ion attachment). As noted above, in our measurements of natural flame ionization, the signals higher up in the flame are due to thermal ionization of soot particles and the data correlates well with the radial distribution of x-ray ionization signals. This suggests a common origin for these signals. Soot charging is believed to be an important factor in enhancing soot agglomeration [19,28,29] and so it is reasonable to expect that the region where the temperature is highest might display the largest amount of aggregation.

SUMMARY

This paper presents for the first time, a demonstration that high energy x-rays can be used to probe soot particles in flames. This technique may prove useful as a method of sampling heavily sooting, fuel rich flames that would otherwise be opaque to visible light. The mechanism by which the ionization signal is produced has been proposed to involve a cascading electron emission enhanced by field emission that eventually leads to the disintegration of the particle in a form of Coulomb explosion. Experiments are planned to investigate this hypothesis by using time-of flight mass spectrometry to search for charged and neutral fragments resulting from such a disintegration. The proposed electron cascade is initiated by the formation of secondary electrons as an Auger electron passes through an extended particle and so it would seem that this method is sensitive to large aggregated soot structures that are resistant to oxidation.

It should be noted that there has been another recent experiment [30], performed at the Advanced Light Source (APS) in the US in which measurements of small-angle scattering (SAS) of x-rays by soot particles in an acetylene flame have been performed. This measurement has shown that it is possible to obtain evidence concerning the size and structure of soot particles with this method. Similar measurements were attempted by us during our experiment at the ESRF but were unsuccessful. This was due to the fact that the air scattering in our apparatus masked any effect due to soot scattering and the choice of ethylene rather than acetylene as fuel gas resulted in a more dilute target density.

ACKNOWLEDGEMENTS

The financial support of the European Office of Aerospace Research and Development (EOARD), Air Force Office of Scientific Research (AFOSR) under Contract No. F61775-01-WE060 and of the European Synchrotron Radiation Facility, (ESRF) are gratefully acknowledged. Thanks are also due to the staff of the European Synchrotron Radiation Facility, to Mr. Daniel Travers and Mr. René Jaffré of the University of Rennes for the construction of the apparatus and to Dr. Bertrand Rowe for useful comments and discussions concerning the manuscript.

REFERENCES

1. www.esrf.fr.
2. Dwek, E. and Smith, R.K. *Astrophys.J.* 459: 686-700 (1996).
3. Rinzler, A.G. Hafner, J.H., Nikolaev, P., Lou, L., Kim, S.G., Tomanek, D., Nordlander, P., Colbert, D.T. and Smalley, R.E., *Science* 269: 1550 (1995).
4. Bonard, J.M., Salvétat, J.P., Stöckli, Forró and Châtelain, A. *Appl. Phys. A.* 69: 245-254 (1999).
5. Ferrari, A.C., Satyanarayana, B.S., Robertson, J., Milne, W.I., Barborini, E., Piseri, P. and Milani, P. *Europhy. Lett.* 46: 245 (1999).
6. B.T. Draine and E.E. Salpeter
Astrophys. J. 231: 77-94, 1979.
7. Chang, C.A., Schiano, A.V.R. and Wolfe, A.M.
Astrophys. J. 322: 180-200 (1987).
8. Ball, R.T., Howard, J.B. 13th (Int.) Symposium on Combustion, p. 353, The Combustion Institute, Pittsburgh (1971).
9. Dobbins, R.A. and Megaridis, C.M.
Langmuir, 3: 254-259 (1987).
10. R.A. Dobbins, R.A. Fletcher, W. Lu, *Combust. Flame* 100: 301 (1995).
11. Xu, F. and Faeth, G.M. *Combust. Flame* 125: 804-819 (2001)
12. Reilly, P.T.A., Gieray, R.A., Whitten, W.B. and Ramsey, J.M.
Combust. Flame 122: 90-104 (2000).
13. J. B. A. Mitchell, C. Rebrion-Rowe, J-L. LeGarrec, G. Taupier, N. Huby and Wulff, M
(Accepted for publication by *Astron. Astrophys.*, 2002).
14. Choi, M.Y., Mulholland, G.W., Hamins, A. and Kashiwagi, T.
Combust. Flame 102: 161-169 (1995).
15. Dasch, C.J.
Applied Optics 31: 1146-1152 (1992).
16. Santoro, R.J., Semerjian, H.G., Emmerman, P.J. and Goulard, R.
Int. J. Heat Mass Transfer 24: 1139-1150 (1981).

17. Clements, R.M. and Smy, P.R.
J. Appl. Phys. 41: 3745 (1970).
18. Fialkov, A.B. Prog. Energy Combust. Sci. 23: 399-528, 1997.
19. Mitchell, J.B.A. and Miller, D.J.M. Combust. Flame 75: 45-55 (1989).
20. Santoro, R.J., Semerjian, H.G. and Dobbins, R.A.
Combust. Flame, 51: 203 (1983).
21. Dobbins, R.A. and Megaridis, C.M. Appl. Optics 30: 4747, 1991
22. Koylu, U.O. and Faeth, G.M. Combust. Flame 89: 140, 1992.
23. Puri, R., Richardson, T.F., Santoro, R.J. and Dobbins, R.A. Combust. Flame 92: 320-333 (1993).
24. di Stasio, S. Carbon 39: 109-118 (2001).
25. Santoro, R.J., Yeh, T.T., Horvath, J.J. and Semerjian, H.G.
Combust. Sci. Tech. 53: 89-115, 1987.
26. Homann, .K.H and Wolf, H. Ber. Bunsenges Phys. Chem. 87:1073-1077 (1983)
27. Calcote, H.F. Combust. Flame 42: 215-242 (1981)
28. Haynes, B.S., Jander, H. and Wagner, H.G. *17th Int. Symp. Combustion*, p. 1365,
Combustion Institute, Pittsburgh, 1979.
29. Feugier, A. *Adv. Chem. Ser. 166 (Evaporation-Combust. Fuels)*: p.178 (1978).
30. Hessler, J.P., Seifert, S., Winans, R.E. and Fletcher, T.H. Faraday Discuss. 119: 395-407 (2001).

Figure Captions

1. Schematic of the experimental set-up showing the cylindrically symmetric burner assembly that can be moved vertically and horizontally so that the flame can be scanned by the x-ray beam from the synchrotron. The probe collects positive and negative currents depending upon the polarity of the bias voltage.
2. Plots of negative currents measured using a positively biased probe for the following heights-above-burner (a) 1mm; (b) 14 mm; (c) 32 mm.

Flame ionization current, no x-rays; O Flame ionization current + contribution from x-ray induced ionization; ▲ X-ray induced ionization signal with background gas ionization subtracted; + background gas ionization current; ◇ Soot volume fraction measured by He-Ne laser light absorption (Inverted for comparison).

3. Plots of positive currents measured using a negatively biased probe for the following heights-above-burner (a) 1mm; (b) 14 mm; (c) 32 mm.

Flame ionization current, no x-rays; O Flame ionization current + contribution from x-ray induced ionization; ▲ X-ray induced ionization signal with background gas ionization subtracted; + background gas ionization current; ◇ Soot volume fraction measured by He-Ne laser light absorption .

4. Plots of soot volume fraction measured by He-Ne laser light absorption as a function of radial distance for height-above burner 5 mm; ■ 10 mm; O 15 mm; ● 20 mm; ▲ 25 mm; Δ 30 mm; ◆ 35 mm; ◇ 40 mm.
5. X-ray induced ionization currents measured on vertical axis of flame as a function of height. O Negative current measured with positive bias on the probe. (Polarity changed for comparison purposes). ● Positive current measured with negative bias on the probe.

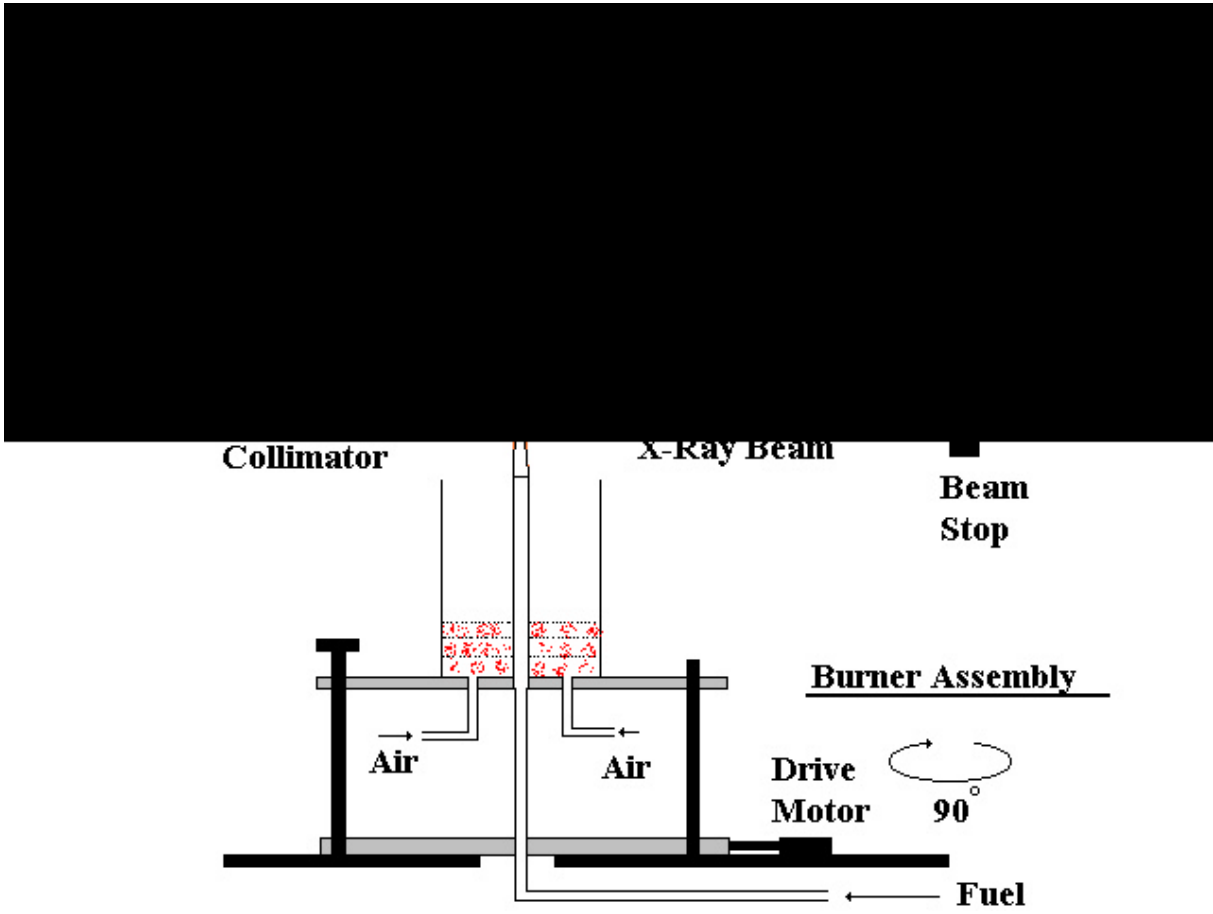

Figure 1.

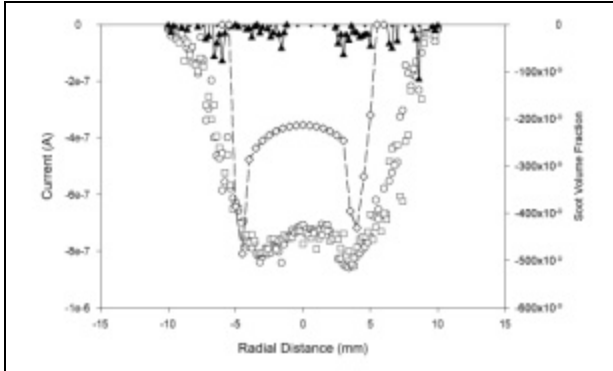

Fig. 2a

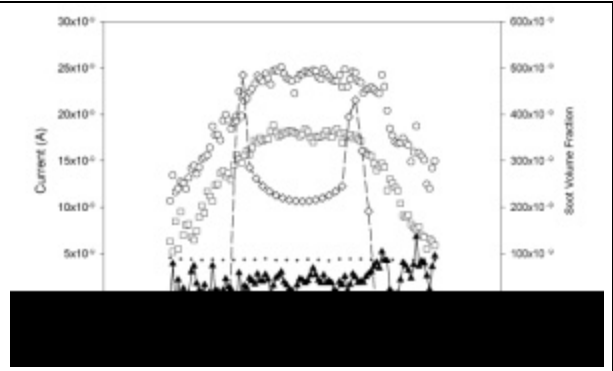

Fig. 3a

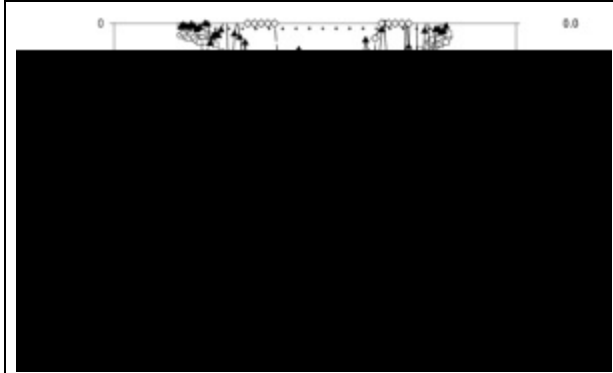

Fig. 2b

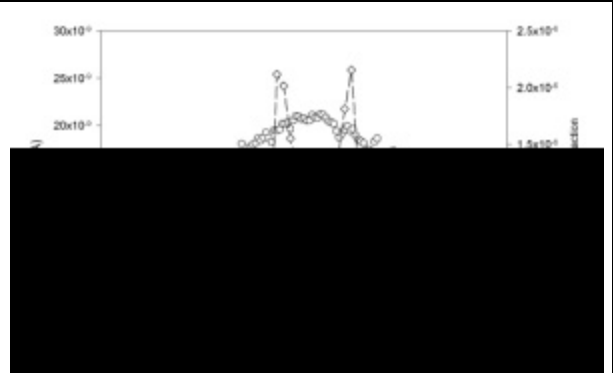

Fig. 3b

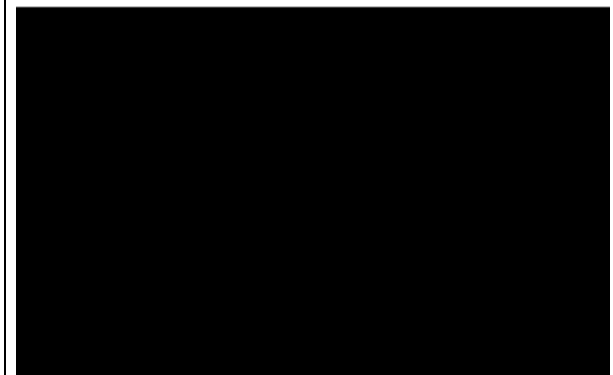

Fig. 2c



Fig. 3c

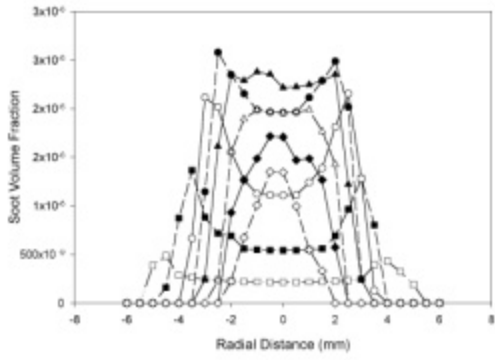

Fig. 4

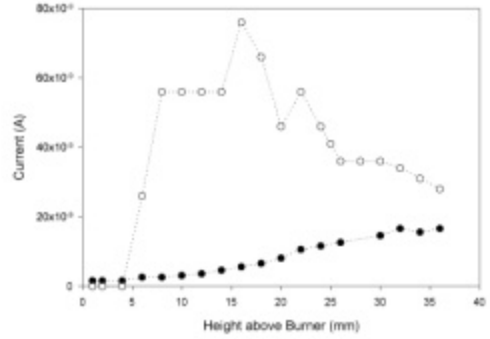

Fig. 5

Appendix II

J. B. A. Mitchell, C. Rebrion-Rowe, J-L. LeGarrec, G. Taupier, N. Huby and M. Wulf (2002)

Nanoparticle Destruction by X-Ray Absorption

Astronomy and Astrophysics **386**, 743

Appendix III

J.B.A. Mitchell (2002)

Electron Collisions with Aggregated Matter

Accepted by

Electron Scattering from Atoms, Molecules, Nuclei and Bulk Matter (ed. C.T. Whelan)

Kluwer Academic, Plenum Publishers, London