

230312C8

MEMORANDUM FOR PRS (Contractor/In-House Publication)

FROM: PROI (TI) (STINFO)

23 June 1999

SUBJECT: Authorization for Release of Technical Information, Control Number: AFRL-PR-ED-TP-FY99-0158
M.E. Fajardo and S. Tam, "Rapid Vapor Deposition on Millimeters Thick Optically Transparent Parahydrogen
Matrices"

Gordon Research Conference (International)

(Statement A)

Rapid Vapor Deposition of Millimeters Thick Optically Transparent Parahydrogen Matrices

Mario E. Fajardo and Simon Tam

US Air Force Research Laboratory, Propulsion Directorate
(AFRL/PRSP Bldg. 8451, Edwards AFB, CA 93524-7680)
mario_fajardo@ple.af.mil

High Energy Density Matter (HEDM) Cryosolid Propellants

UV/Vis Spectroscopy of Li & B Atoms in Solid Hydrogen

Rapid Vapor Deposition of Thick Parahydrogen (pH₂) Matrices

IR/Raman Spectroscopic Characterization of Pure pH₂ Solids

Dopant-induced IR Activity in pH₂ Solids (the "solvent" speaks)

High Resolution IR Spectroscopy in Vapor Deposited pH₂ Solids

Summary and Future Directions

DISTRIBUTION STATEMENT A
Approved for Public Release
Distribution Unlimited

20021121 043

HEDM Cryosolid Propellants Payoffs

Increased Specific Impulse

$$I_{sp} \propto \sqrt{\Delta H_{sp}}$$

$$\text{LOX/LH}_2 : I_{sp} = 390 \text{ s}$$

$$5\% \text{ B/sH}_2 + \text{LOX} : I_{sp} = 500 \text{ s (+30%)*}$$

350 → 650

* calculated for $P_{\text{chamber}} = 1000 \text{ ^{psia}PSIA}$, $P_{\text{exhaust}} = 14.7 \text{ ^{psia}PSIA}$

Greater Propellant Density

liquid H_2 @ 20 K : $\rho = 0.070 \text{ g/cm}^3$

solid H_2 @ 2 K : $\rho = 0.087 \text{ g/cm}^3$ (+25%)

50/50 liquid He/solid H_2 : $\rho = 0.105 \text{ g/cm}^3$ (+50%)

W/1001
ASAP TO
@MCM7

HEDM dopant recombination/reaction

* ideally:



* in practice:

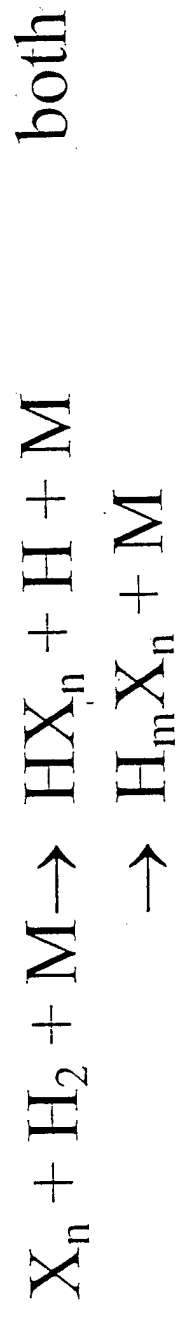
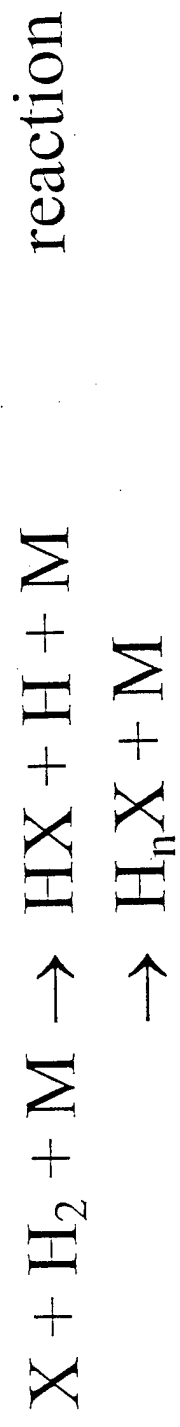
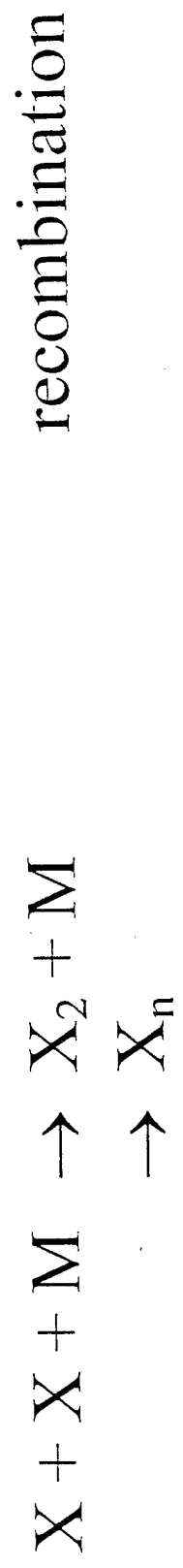

Scientific/Technological Motivations

<u>Issue</u>	<u>Scientific Motivation</u>	<u>Tech. Application</u>
Chemical stability of M/pH ₂ samples	Chemical reactivity @ low T (1-10 K) ↳ existence of small reaction barriers ↳ in M + H ₂ reaction ↳ matrix host effects	Identify candidate M's
Microscopic model of sample deposition process	Molecular dynamics of "simple" condensed phase systems (models for more complicated chemistry)	Maximize [M]
Simulation of M/RGS and M/pH ₂ spectroscopy	Spectroscopy in condensed phases ↳ spectrum ↔ structure/fluctuations	Measure [M] and determine fuel ρ
Diffusion/recombination of M's	Diffusion in "classical" and "quantum" solids	Determine thermal stability of M/H ₂ fuel
Maximum attainable [M]	Limits of chemical energy storage	fuel performance

Experimental Diagram (c.1993)

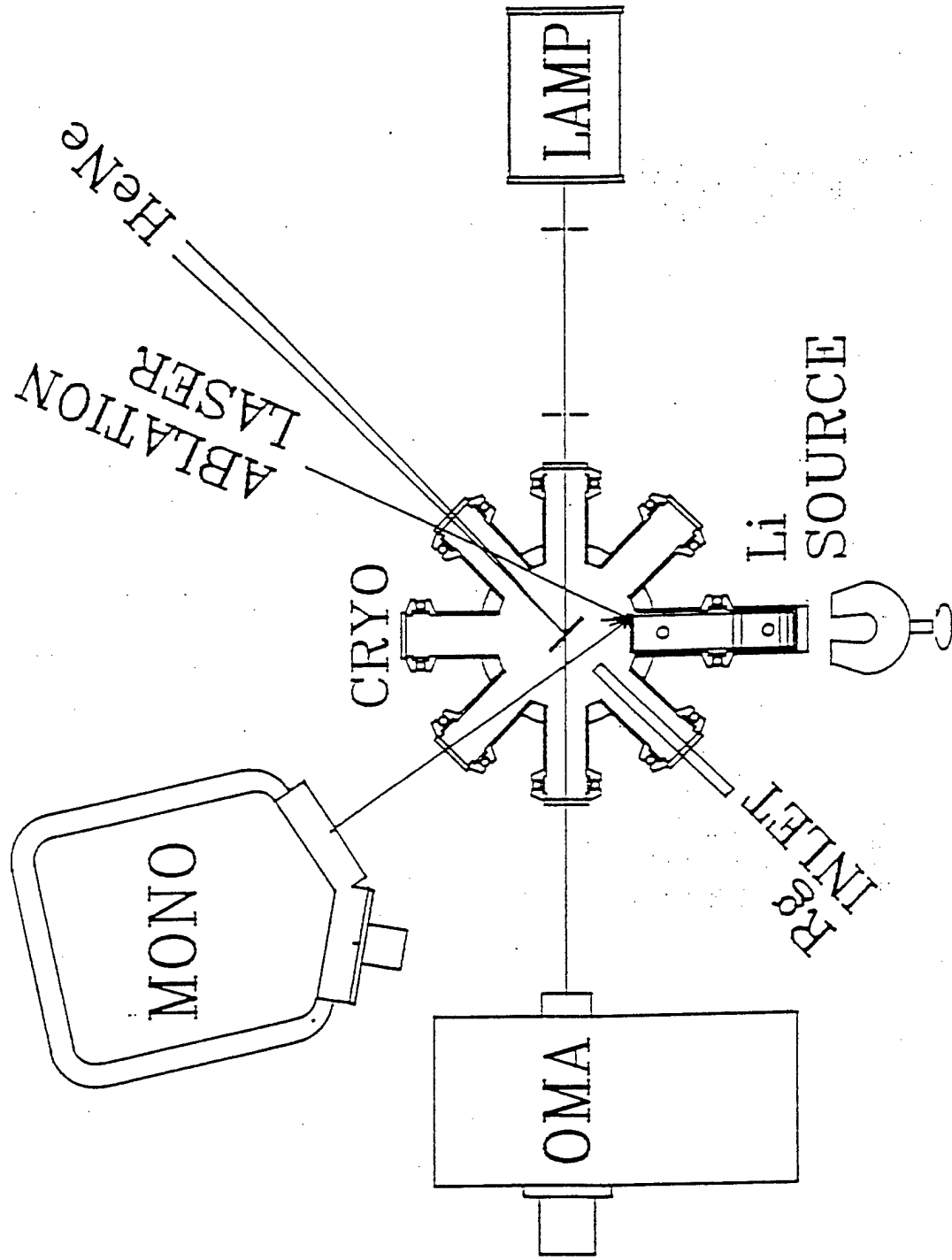

Li/H₂ T=3K

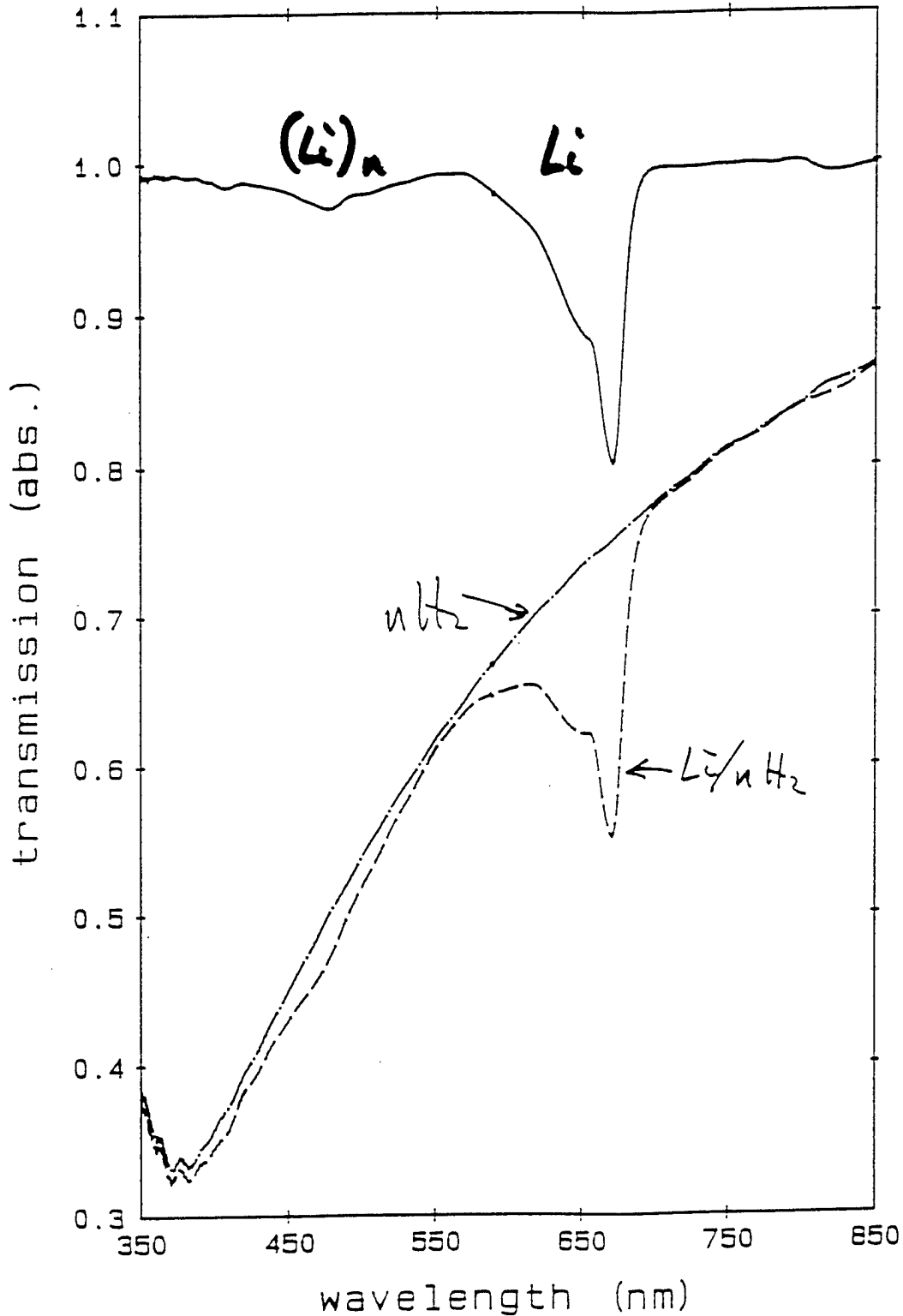

M.E. FAJANO, J. Chem. Phys. 98, 110 (1993).

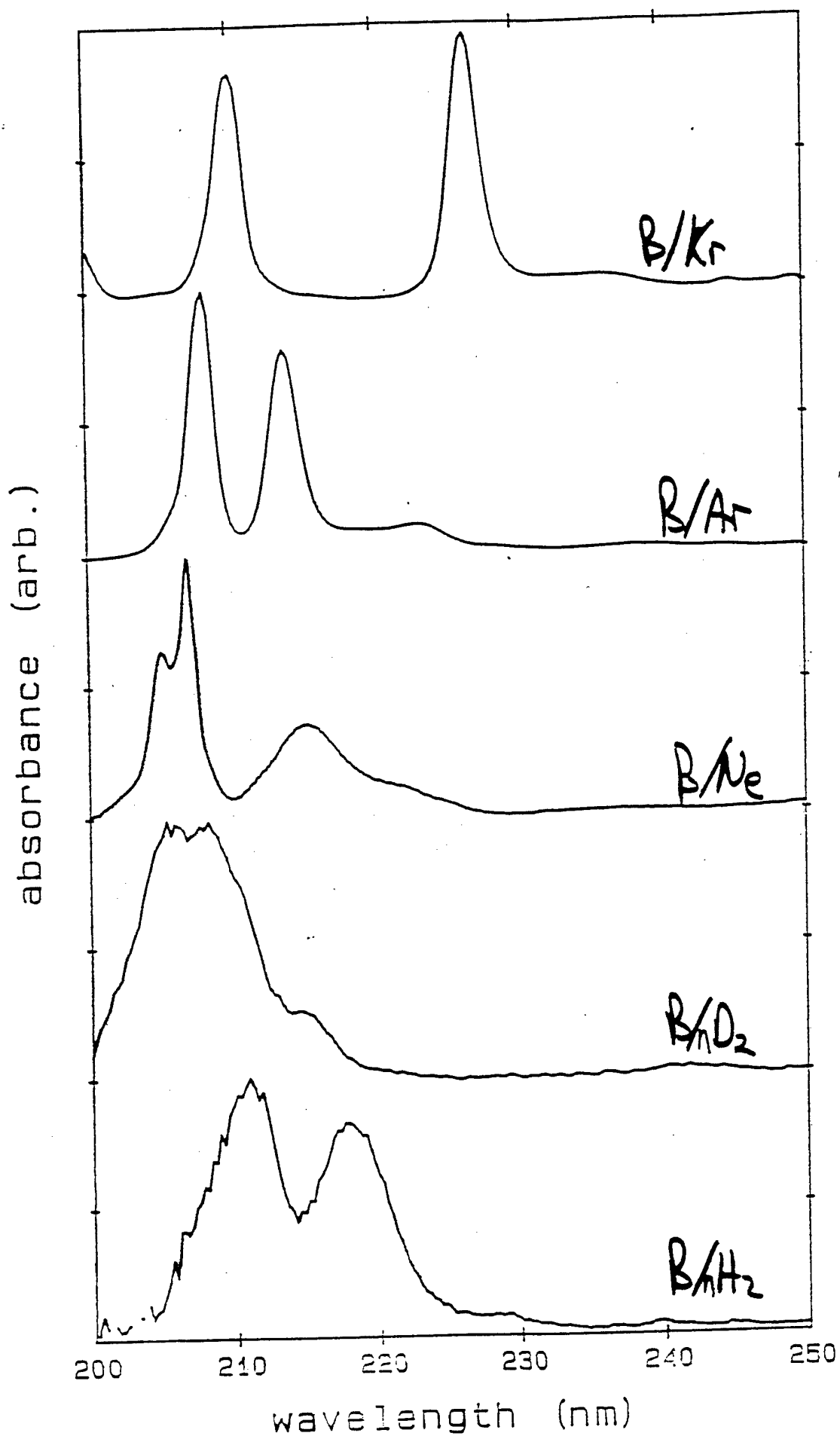

S. TAM + M. E. FASANO, UNPUBLISHED.

B/H2 raw data (c1993)

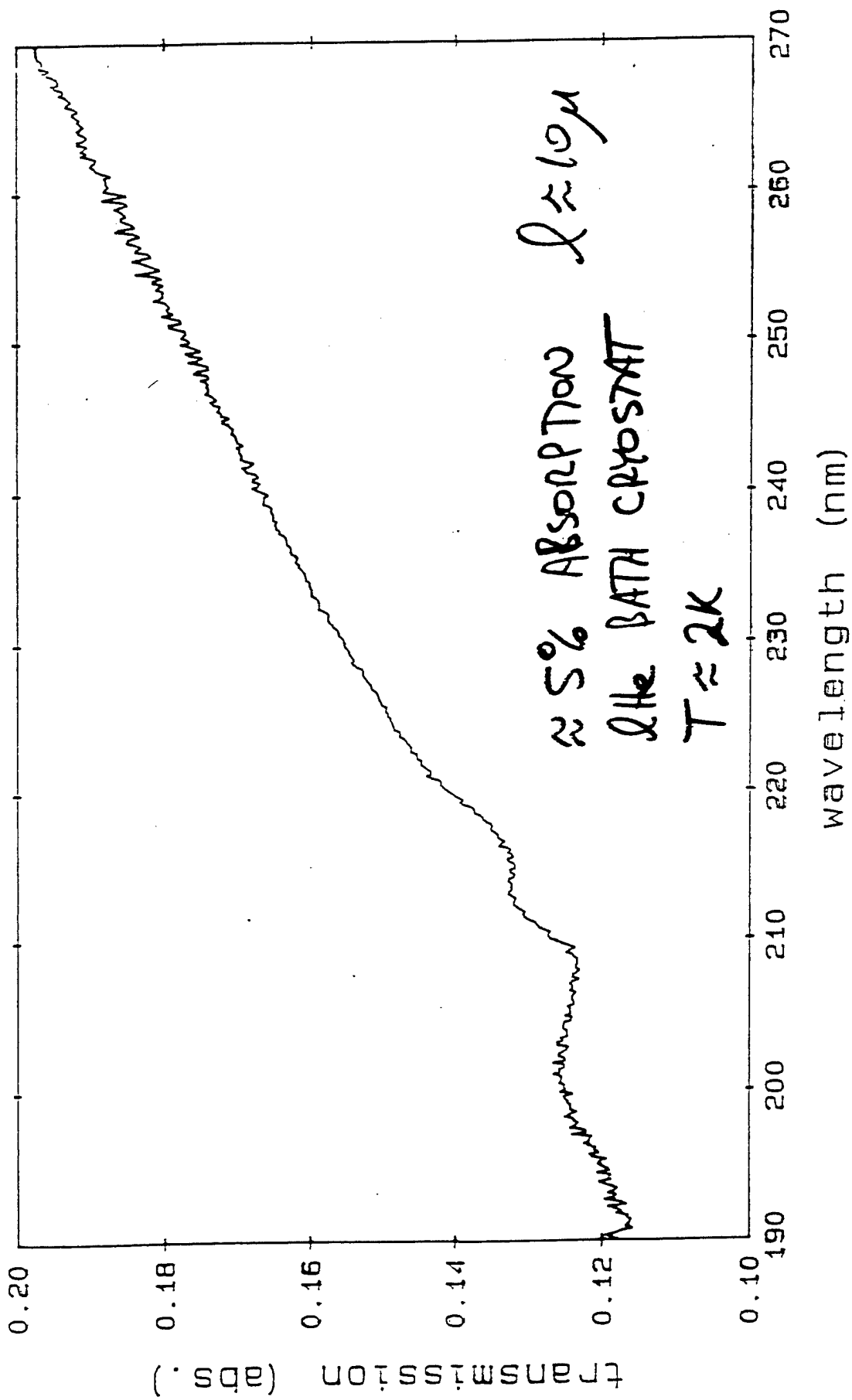

Optical Scattering in Solid Hydrogen

Crystal Growing and Quality (p. 81)

“There is a considerable art to growing hydrogen crystals of high quality. Good crystals are always grown slowly from the melt; a rapid freeze from the gas produces snow.”

Crystallite Light Scattering (p. 83)

“The reason that a good hydrogen crystal is so hard to see is its low refractive index...an estimated 1.16!

Yet a ~~1~~mm-thick layer of hydrogen crystallites can be a completely opaque brown-black.”

P.C. Souers,
Hydrogen Properties for Fusion Energy
(UC Press, Berkeley, 1986).

Deposition Cartoon

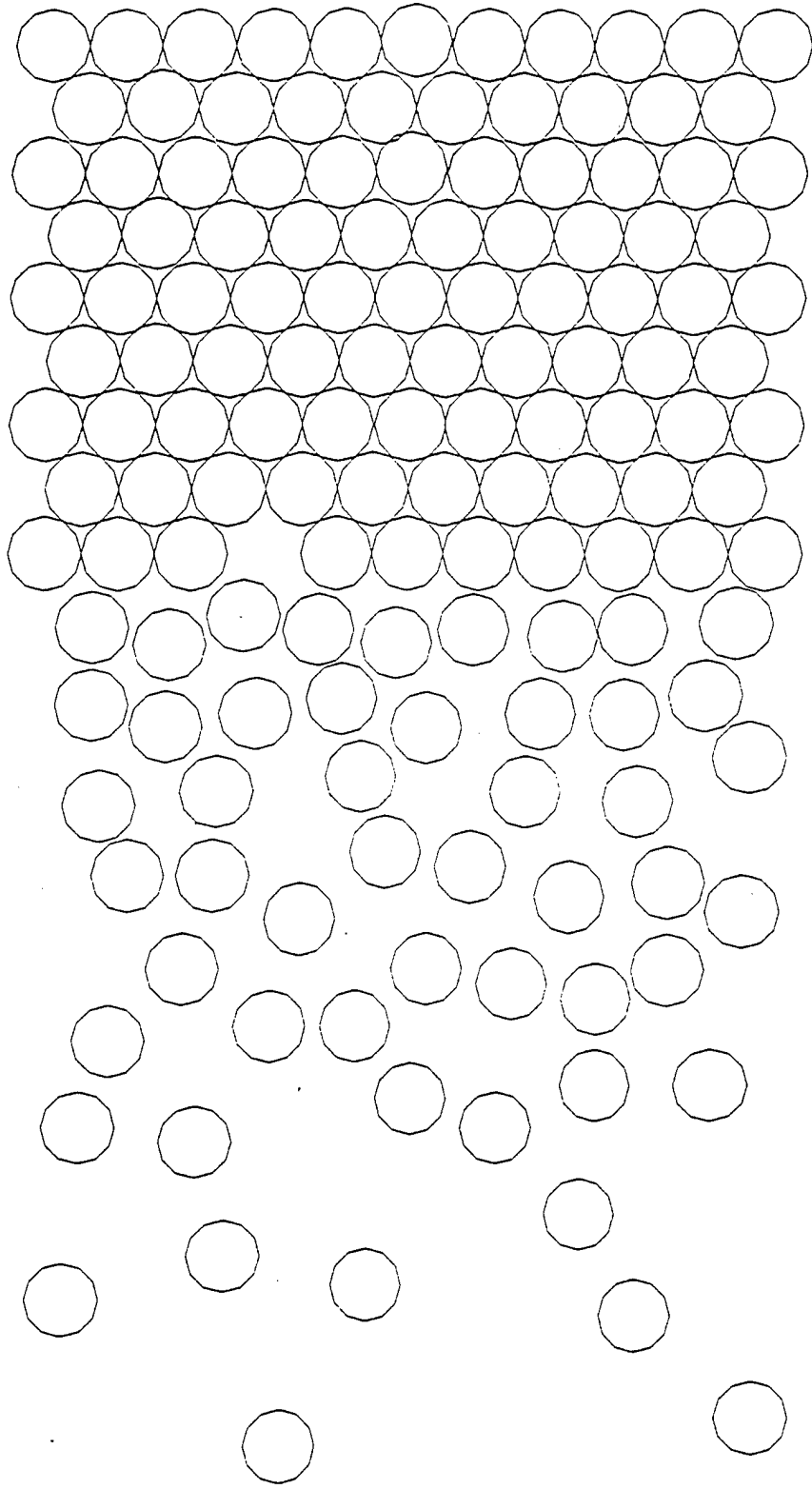

gas phase | accretion layer | solid hydrogen

Ortho and Para Hydrogen

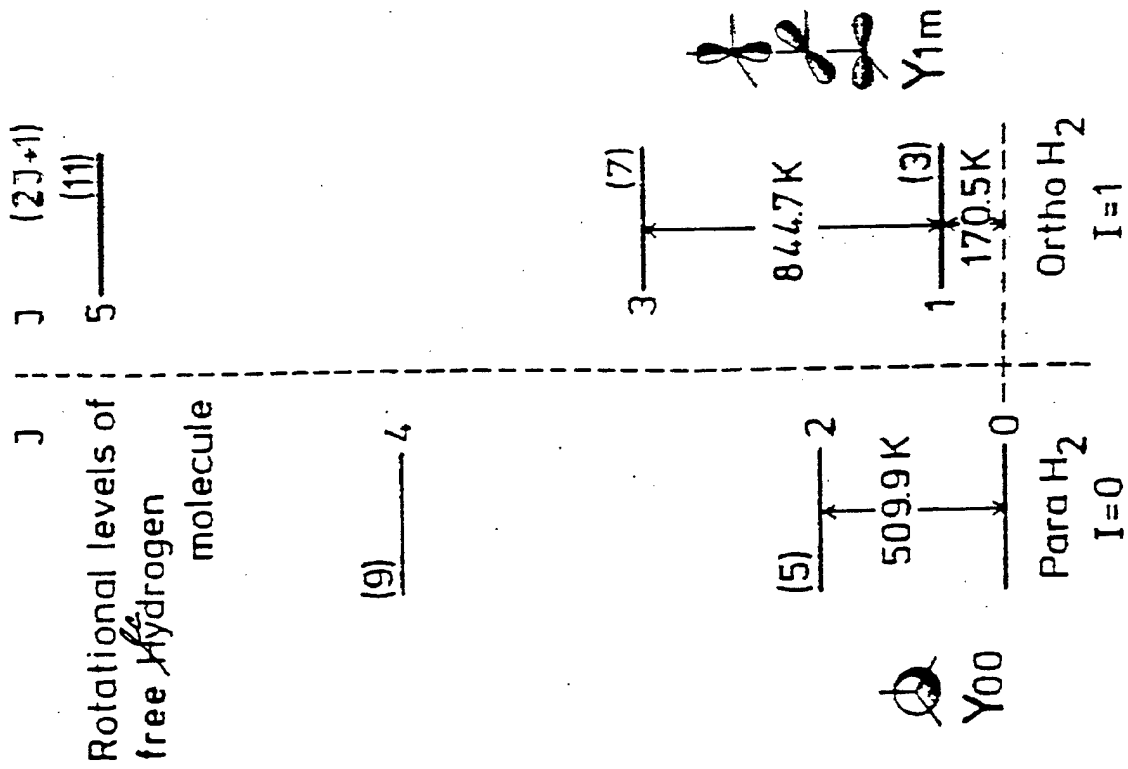

I.F. Silvera,
 Rev. Mod. Phys. **52**, 393 (1980).

Experimental Diagram (c1997)

M.E. Fajardo and S. Tam, J. Chem. Phys. **108**, 4237 (1998)

S. Tam and M.E. Fajardo, Rev. Sci. Instrum. **70**, 1926 (1999)

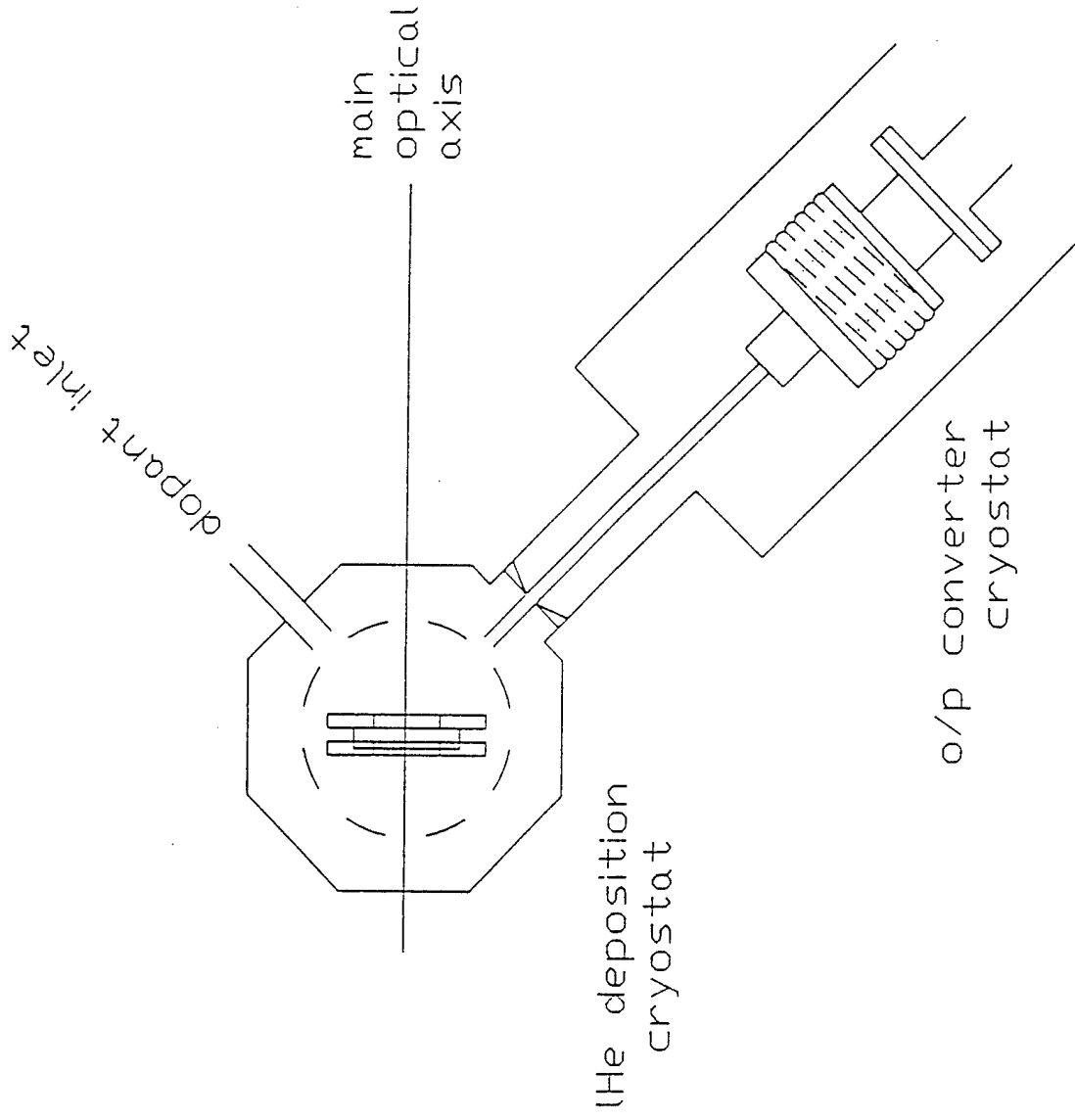

UV Transmission of 1-mm Thick B/pH₂ Sample

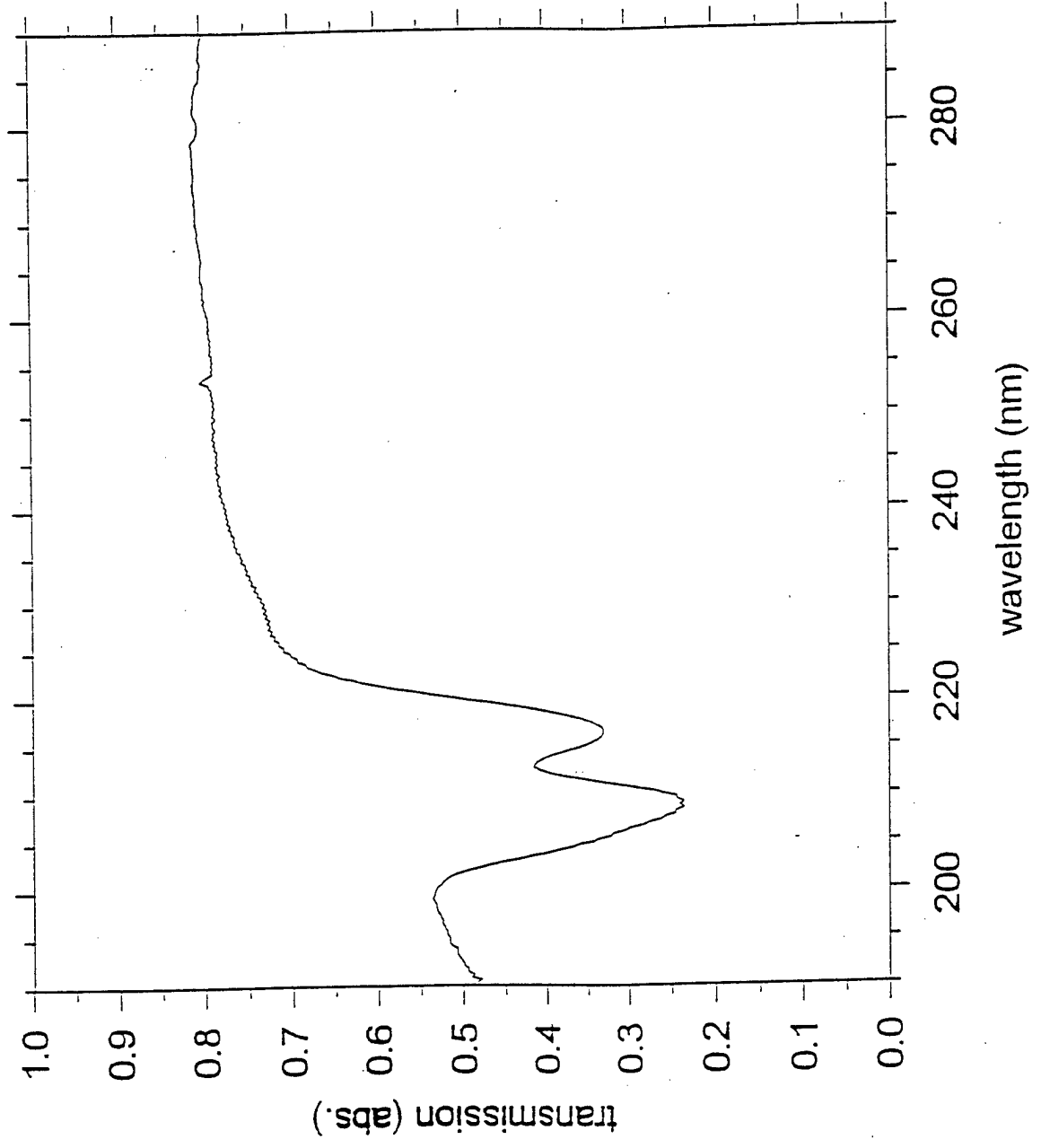

B/pH₂ LIF
 $\lambda_{\text{exc}} = 207, 210, 217, \text{ and } 220 \text{ nm}$

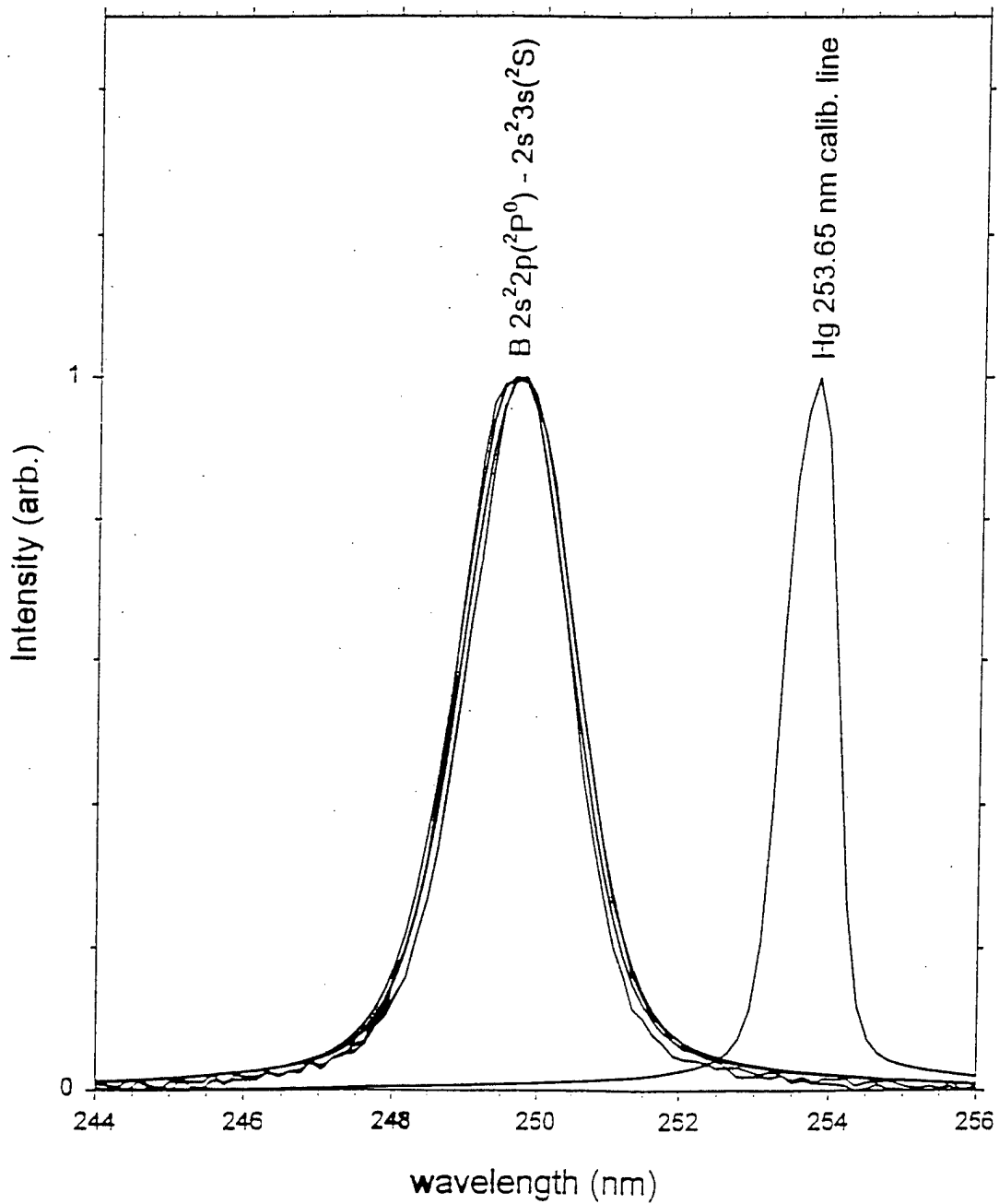

B/pH₂ LIF Cartoon

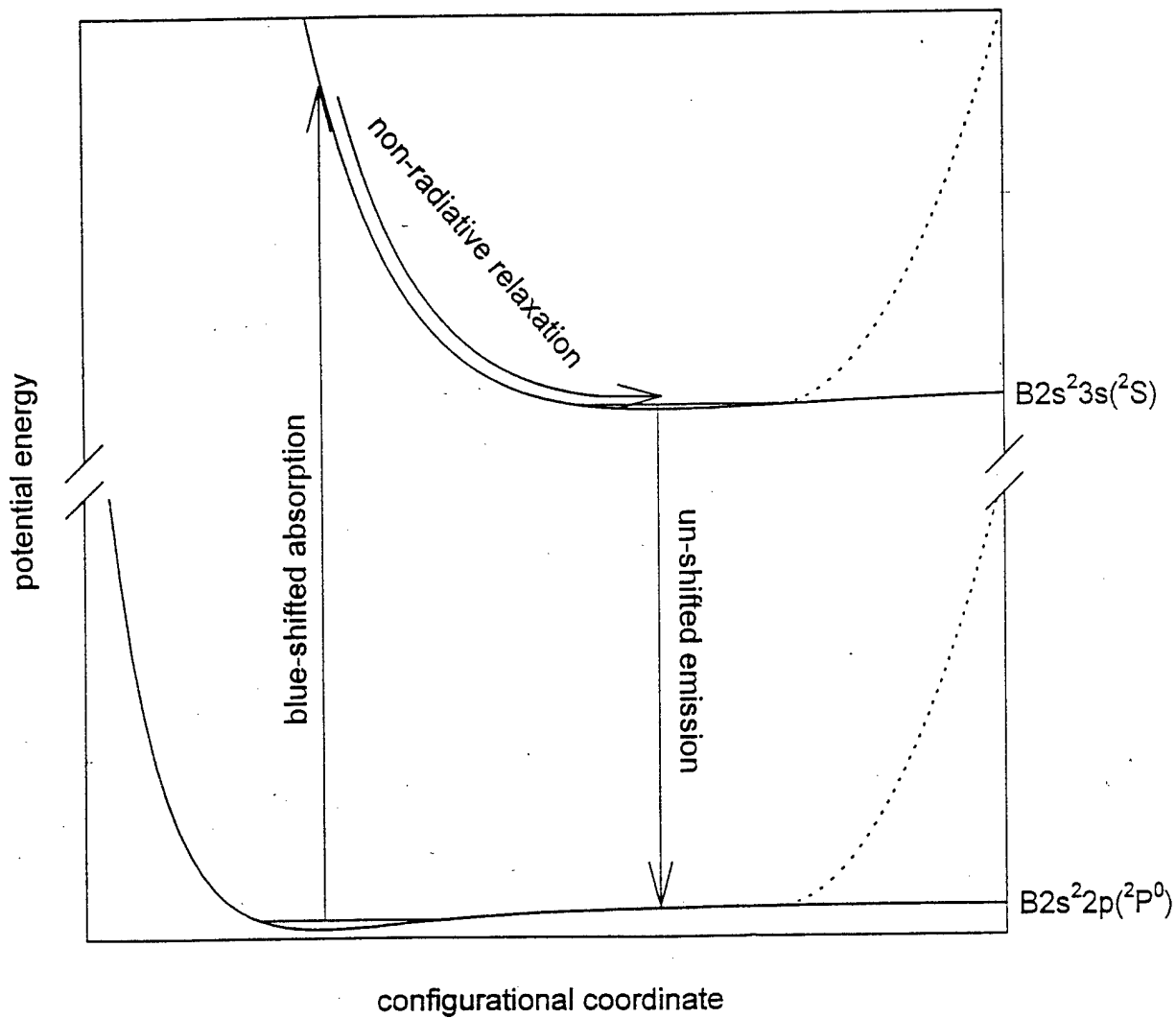

IR Absorption of 6 mm Thick Parahydrogen Solid

T = 2 K.

Non-observation of the $Q_1(0)$ transition (4153 cm^{-1}) demonstrates the absence of $o\text{H}_2$ impurities, and that the microscopic structure is not amorphous or porous.

Observation of $S_1(0)$ transition demonstrates the absence of inversion symmetry for some H_2 molecular environments.

[J. van Kranendonk and H.P. Gush, Phys. Lett. 1, 22 (1962)]

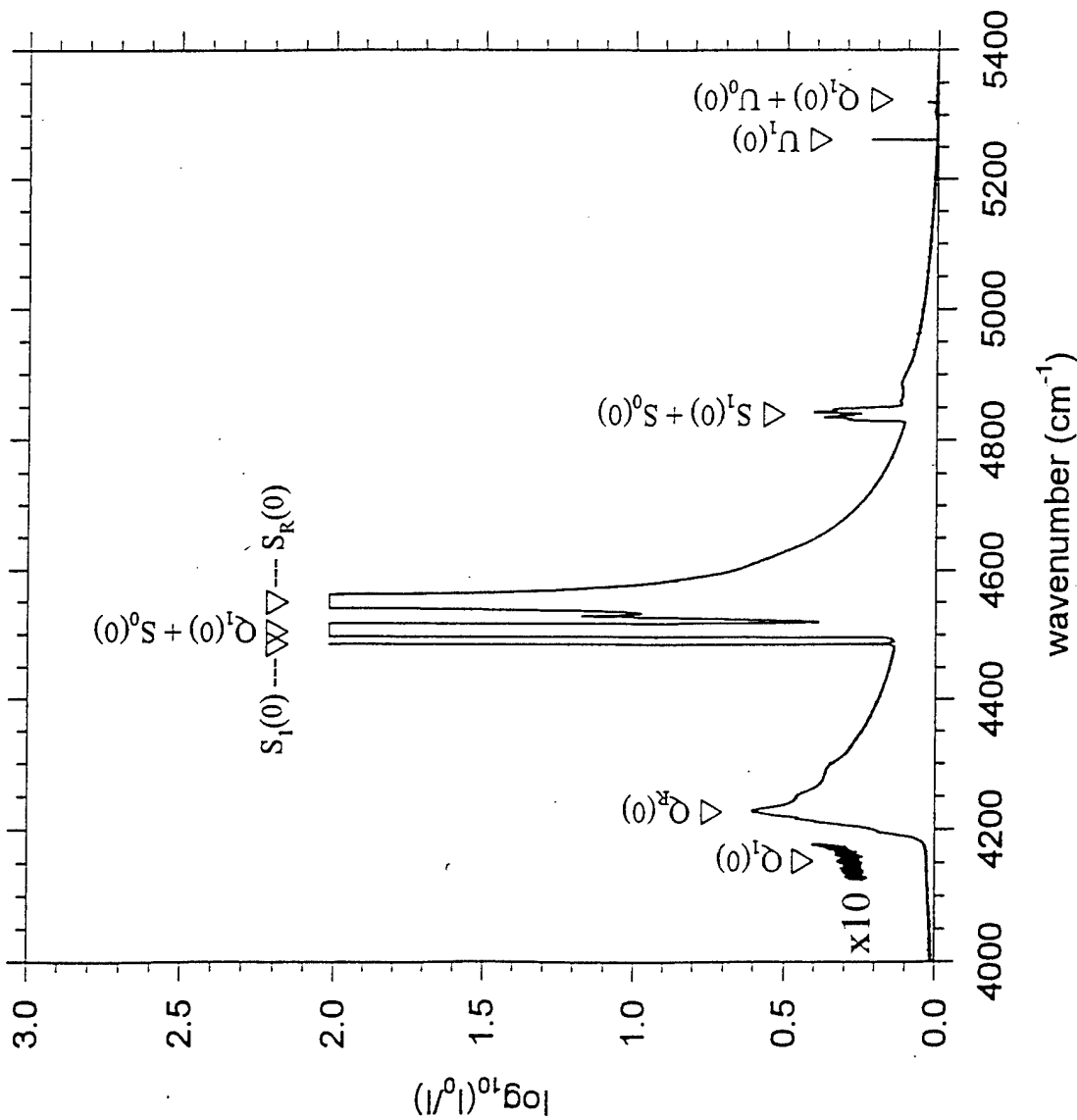

Raman Spectra of 4.5 and 6 mm Thick Parahydrogen Solids

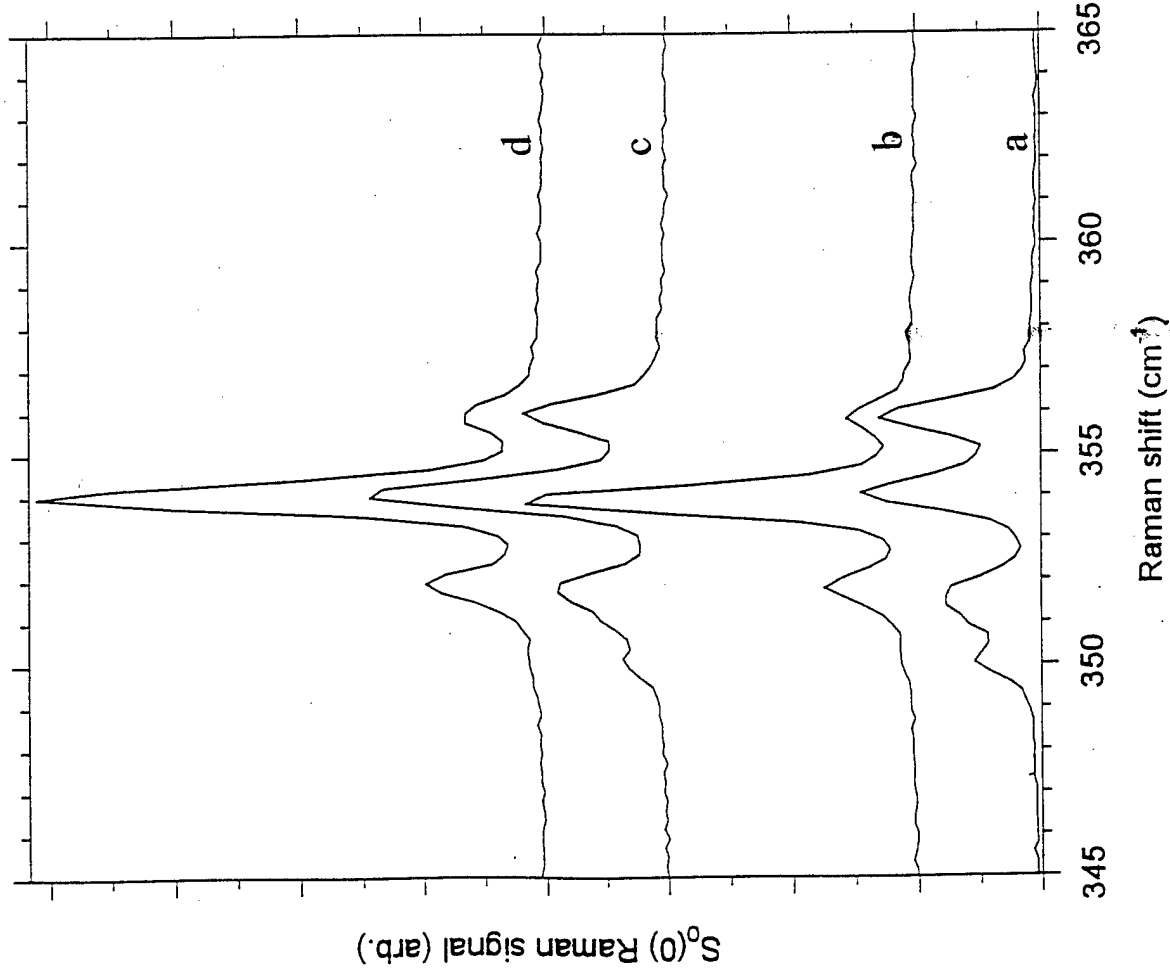

Mixed hcp/fcc as-deposited structure, anneals to hcp; compare with:

G.W. Collins, et al.,
Phys. Rev. B **53**, 102 (1996).

(d) sample in (c) warmed to 4.5 K.

(c) 4.5 mm sample as deposited at 3.3 K ($\Phi = 290$ mmol/hr).

(b) sample in (a) warmed to 4.5 K.

(a) 6 mm sample as deposited at 3.1 K ($\Phi = 200$ mmol/hr).

(Thanks, Ingrid!)

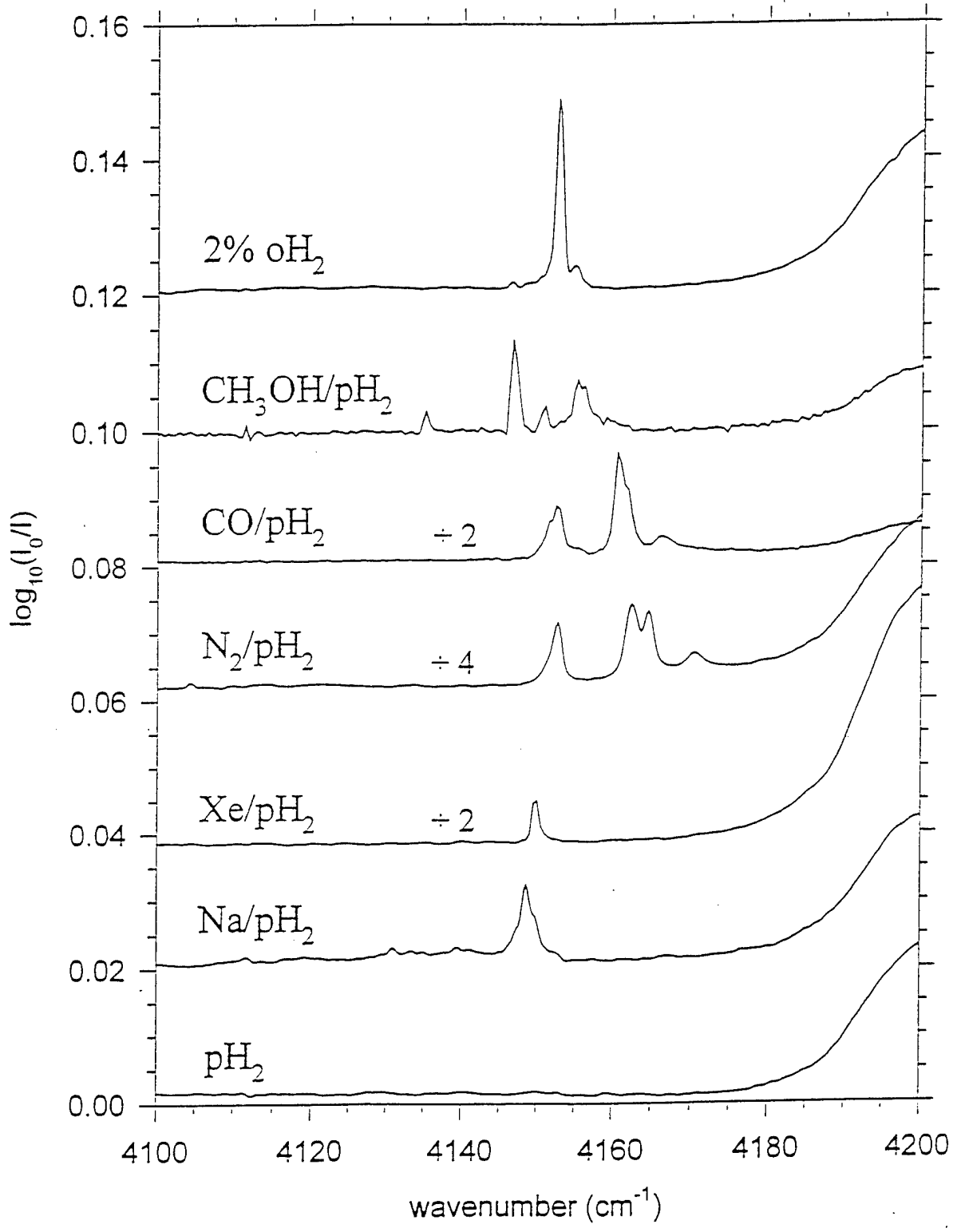

charged dopant induced H₂ absorptions

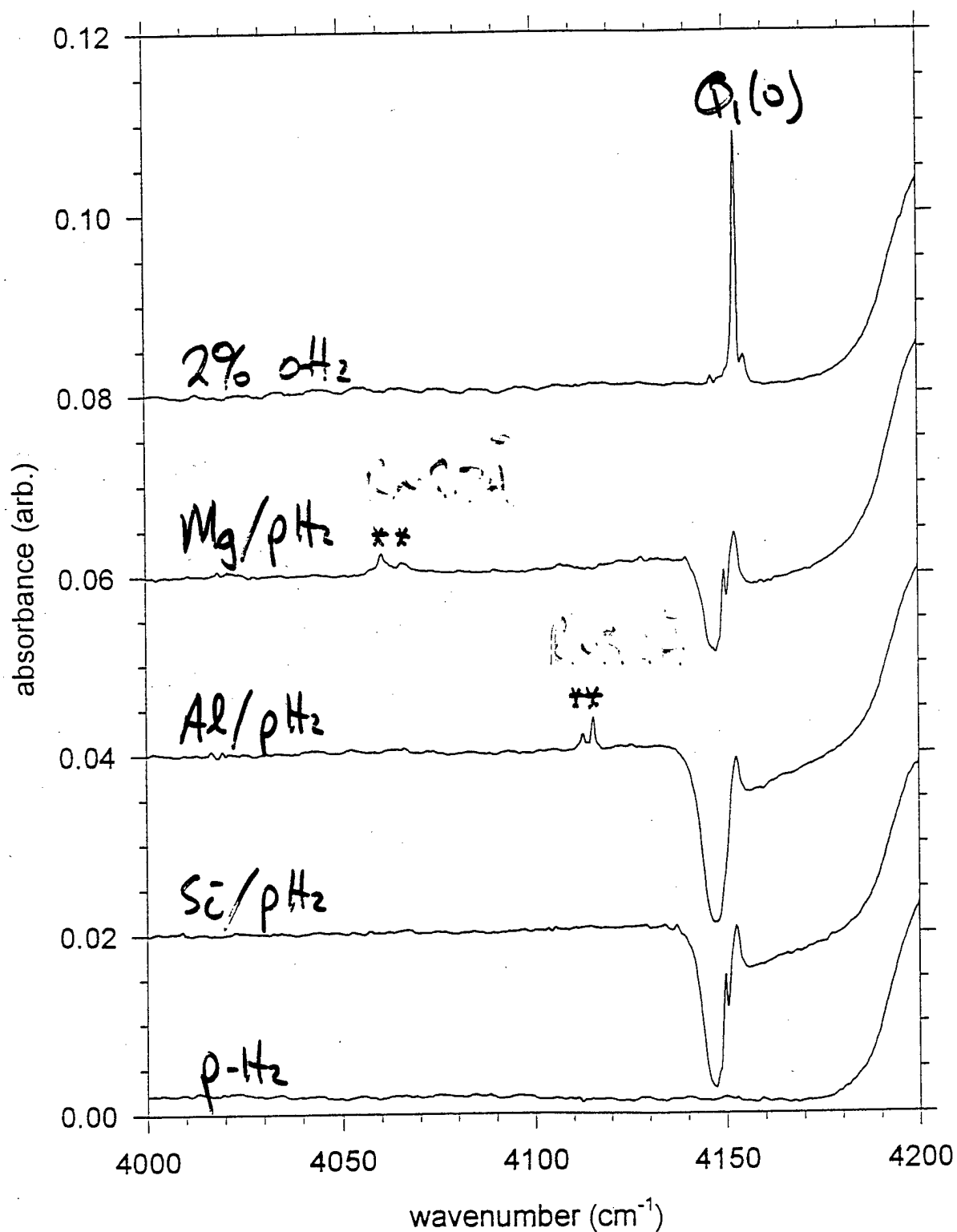

= 1 - U₂

Full 1 Unit
25% O₂, 74% H₂

High Resolution IR Spectroscopy in Solid pH_2

T. Momose, K.E. Kerr, D.P. Weliky, C.M. Gabrys, R.M. Dickson and T. Oka,
J. Chem. Phys. **100**, 7840 (1994).

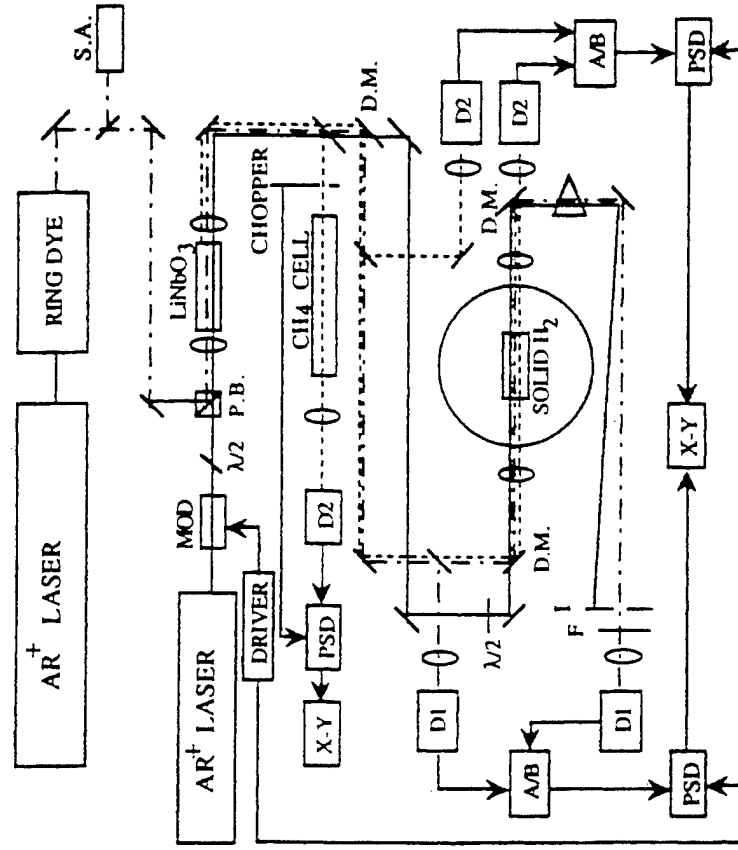
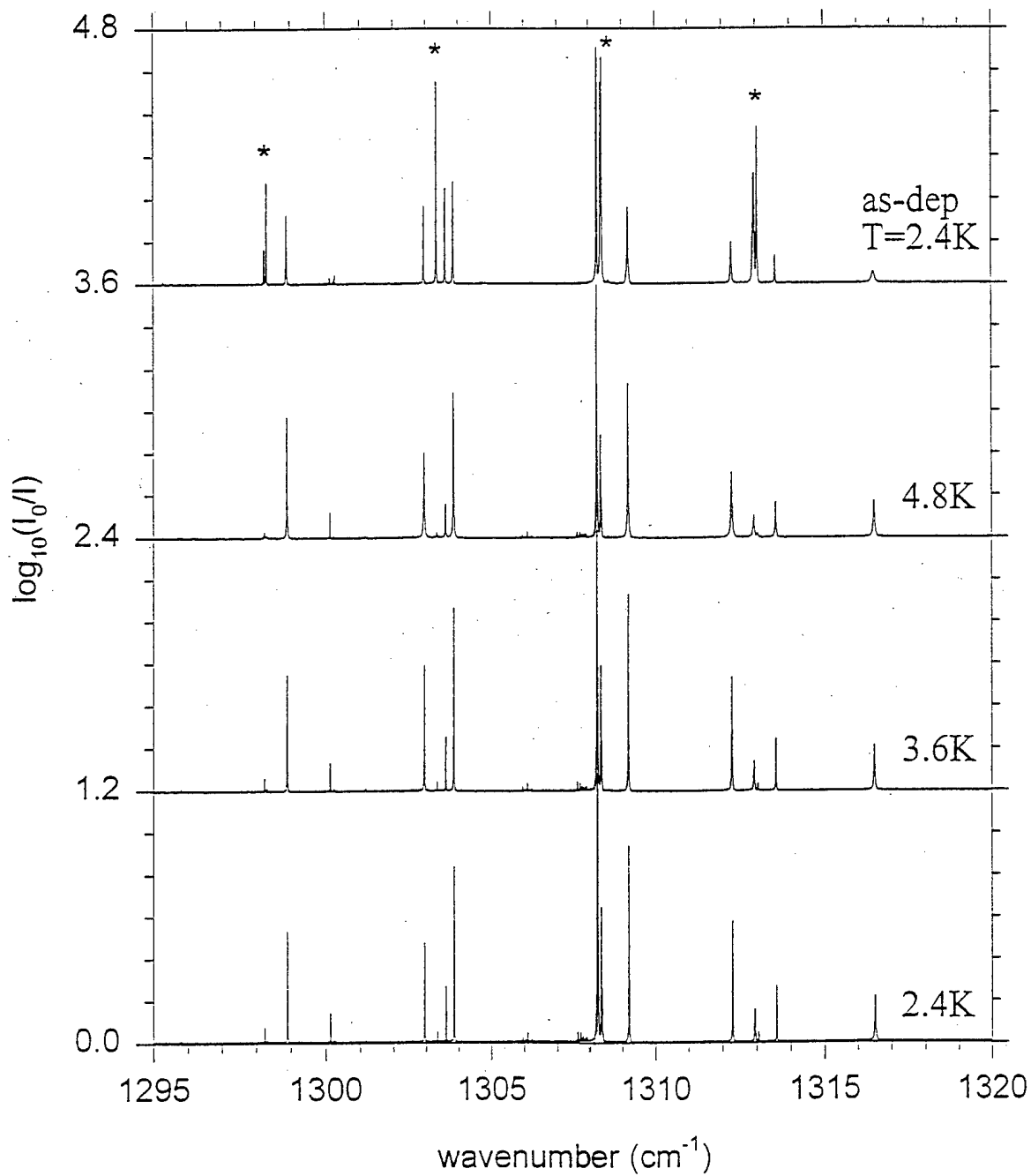
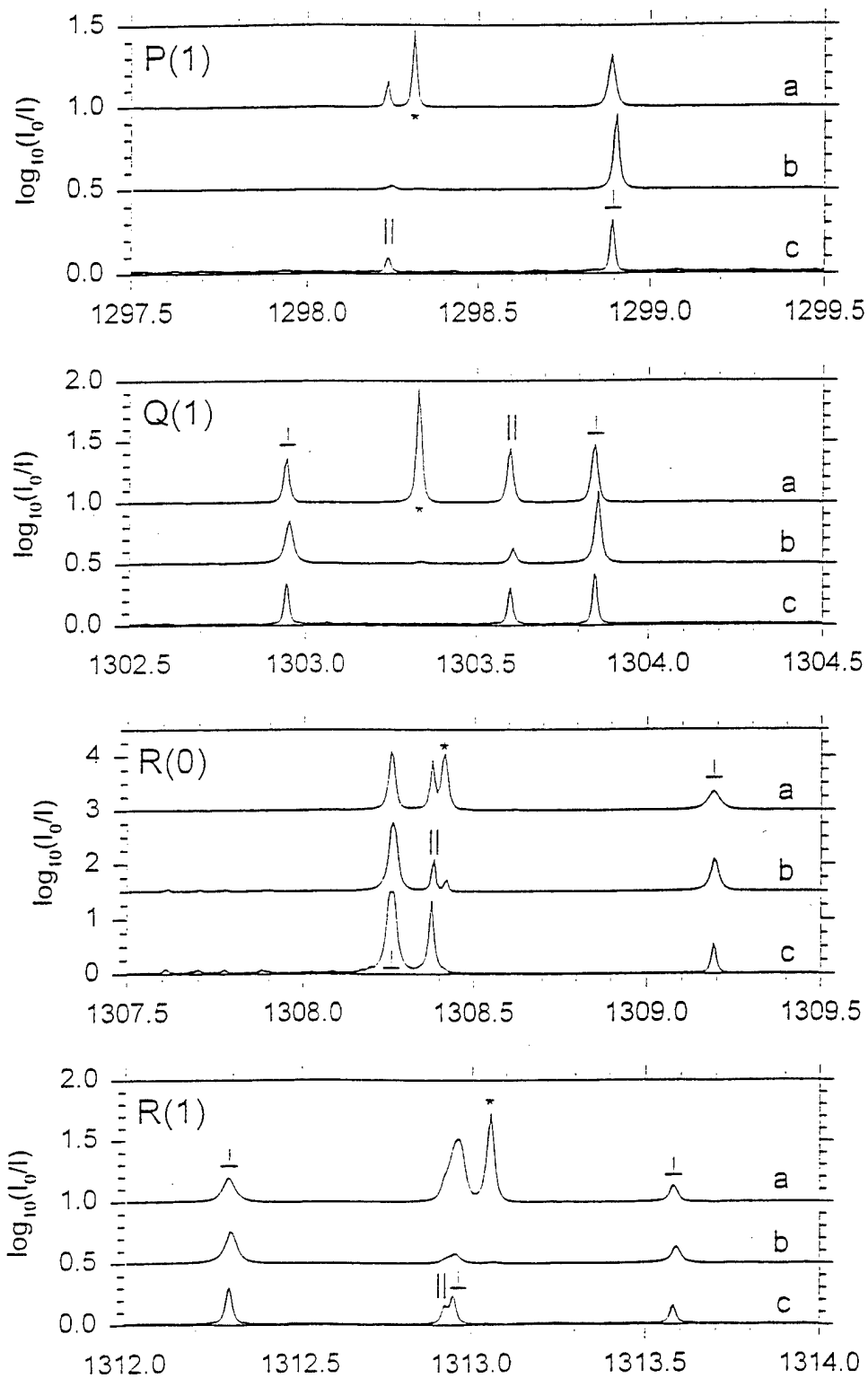

FIG. 1. Apparatus for the simultaneous spectroscopy of the infrared and Raman transitions. The nonlinearity of LiNbO_3 is used for the former and that of solid H_2 is used for the latter. D.M., dichroic mirror; S. A., spectrum analyzer; P. B., polarizer beamsplitter.

ν_4 CH₄/pH₂ absorptions



ν_4 CH₄/pH₂ Absorptions



CH₄/pH₂ Energy Levels

S. Tam, M.E. Fajardo, H. Katsuki, H. Hoshina, T. Wakabashi, and T. Momose, J. Chem. Phys., submitted.

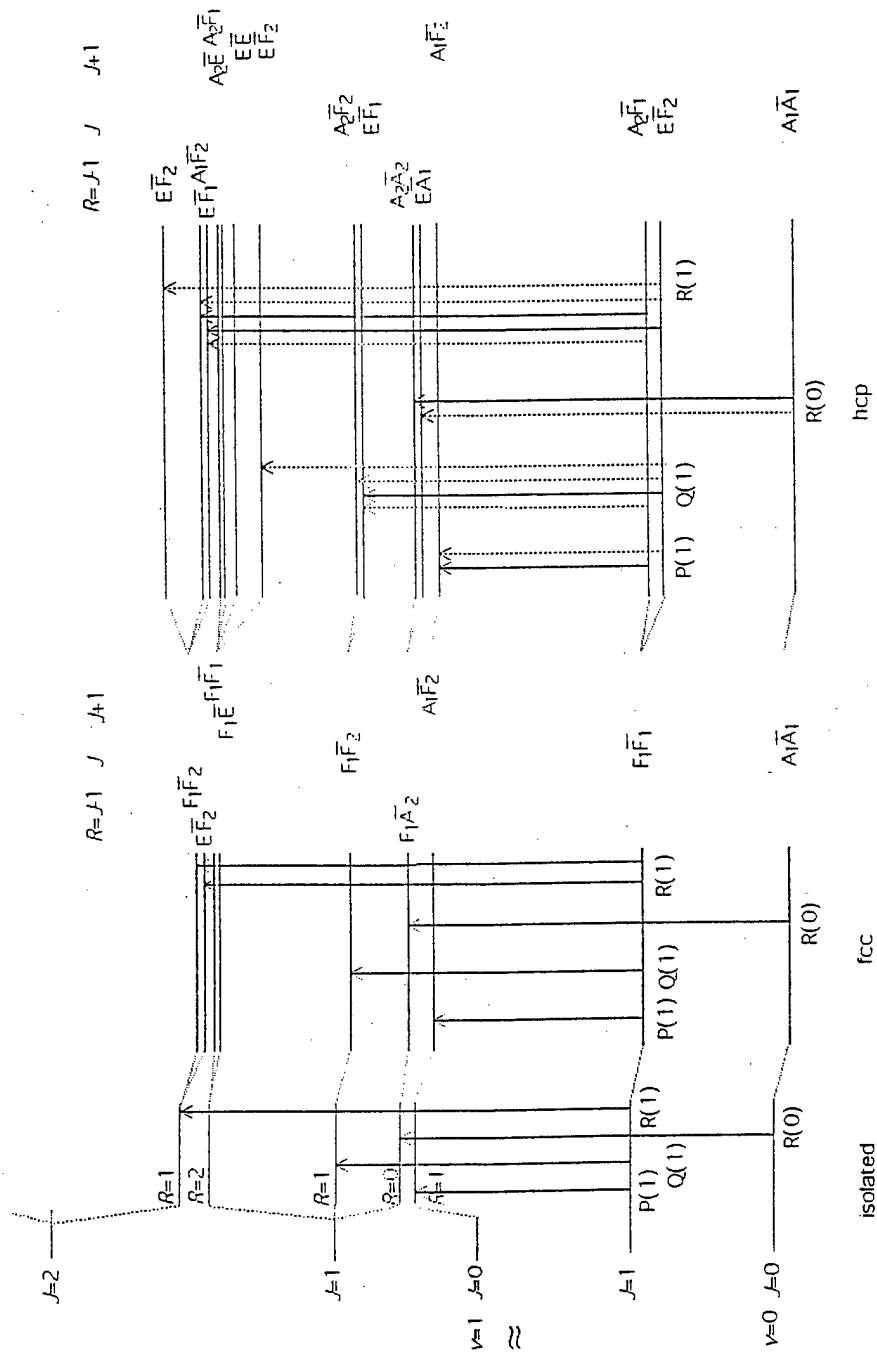

88 PPM HCl/pH₂ d≈3mm

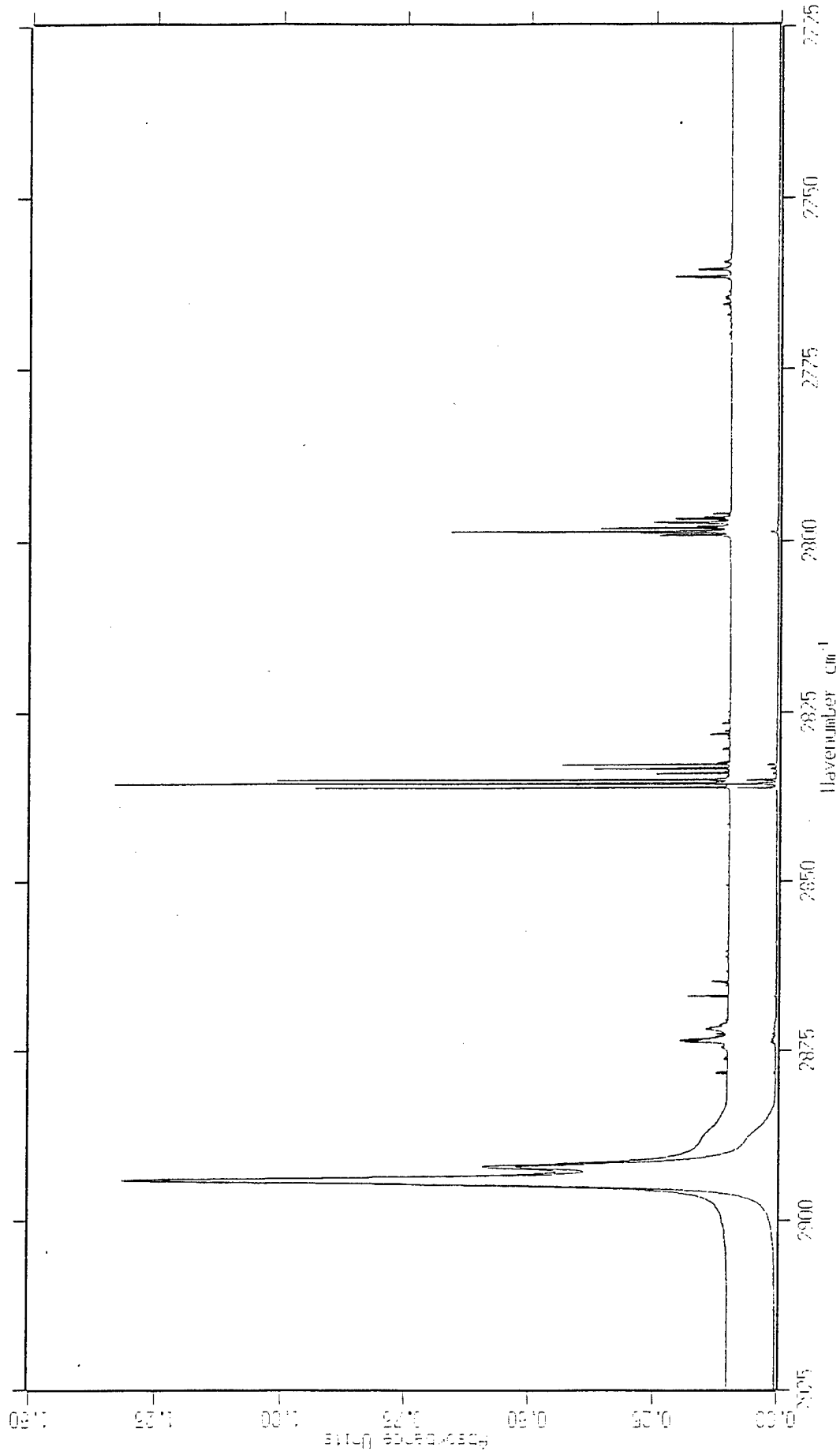

st27061.11 annealed T=2.4K

st27061.7 as deposited T=2.4K

resolution = 0.0075 cm⁻¹

irreversible T dependences

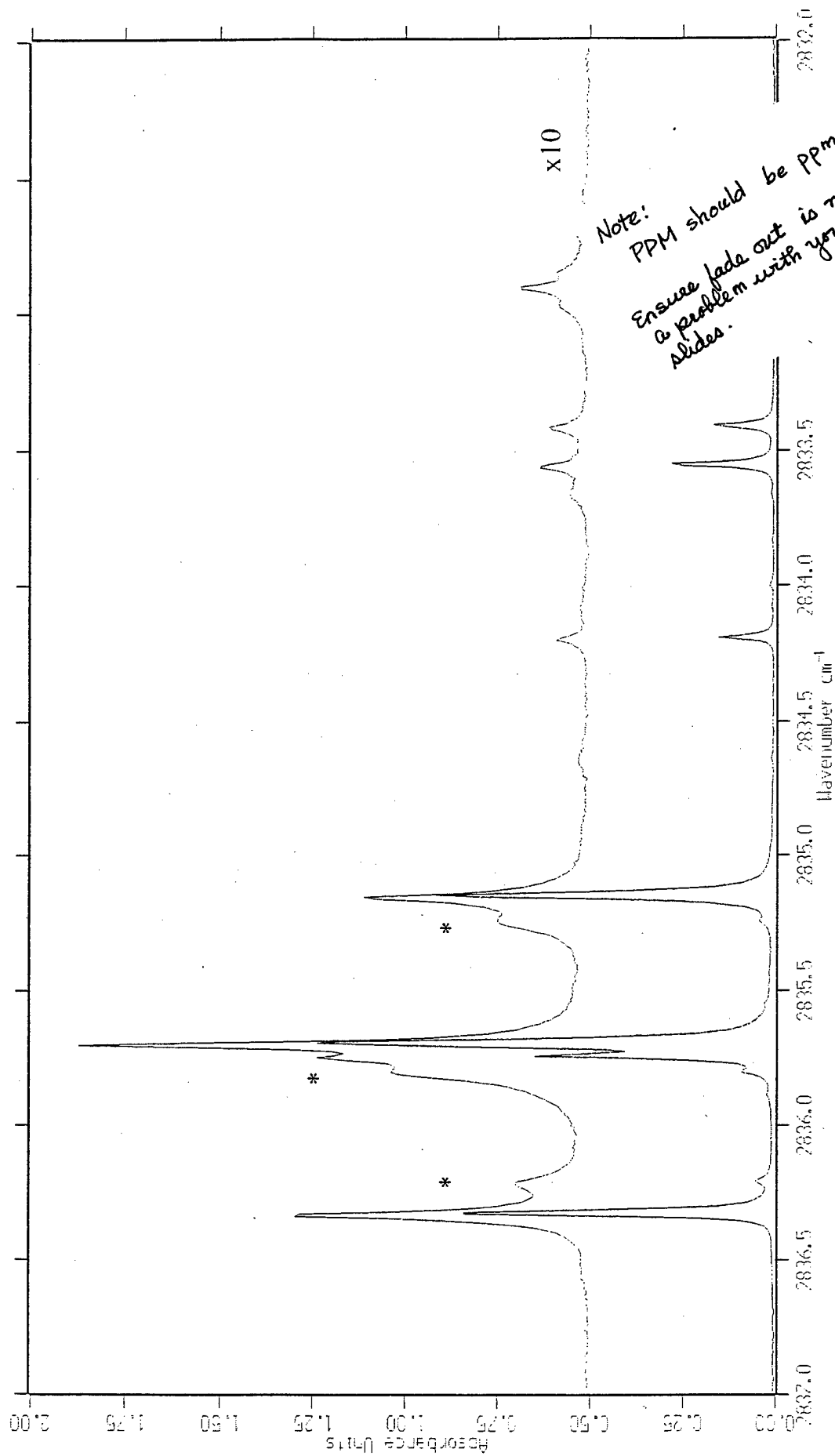

88 PPM HCl/pH₂ d \approx 3mm
st27061.7 as deposited T=2.4K
st27061.11 annealed T=2.4K

reversible T dependences

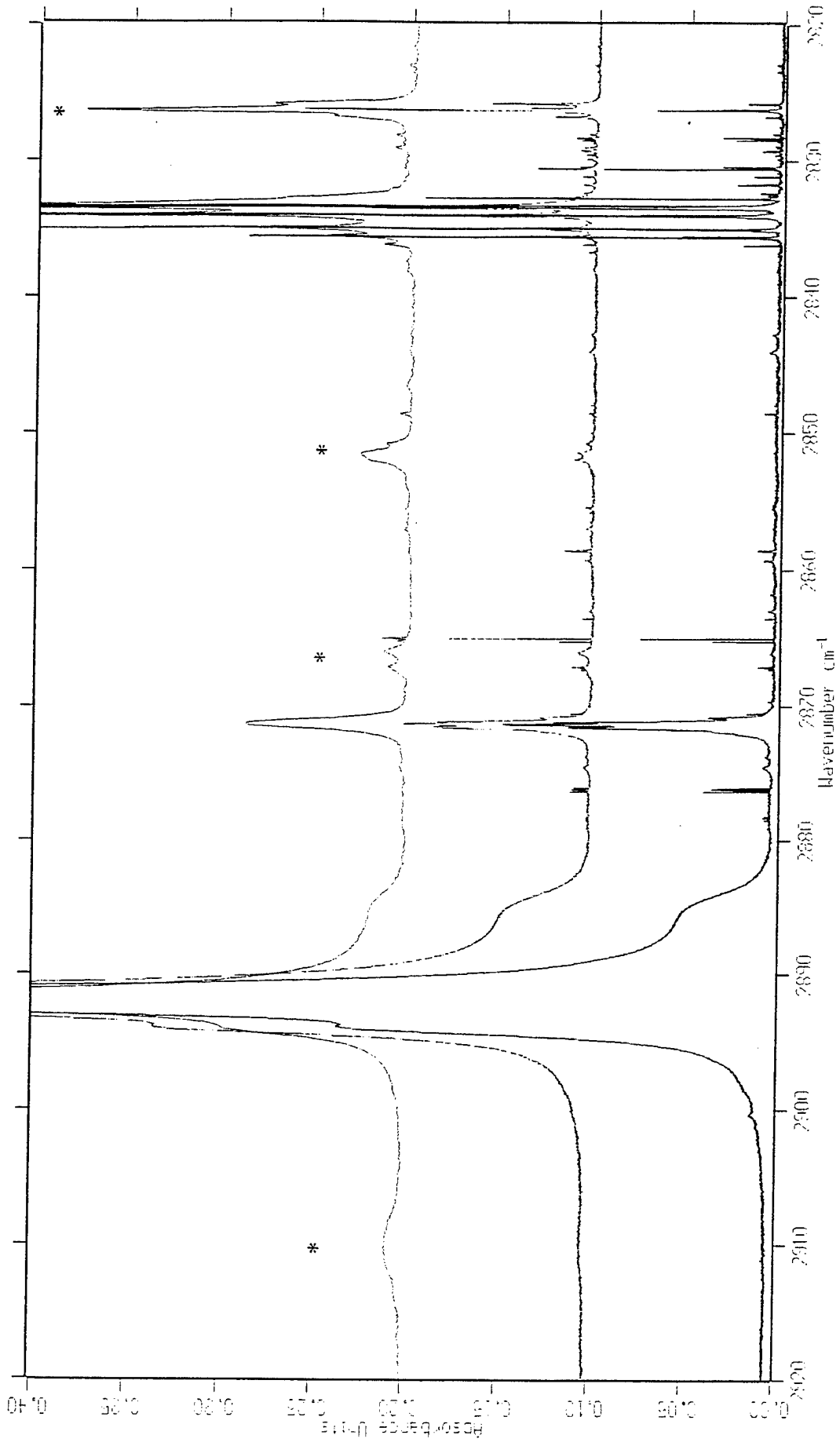

st27103.13 evaporating T≈10K
st27103.4 annealing T=4.8K
st27061.11 annealed T=2.4K

94 PPM H³⁷Cl

gas phase HCl and (HCl)₂ transitions

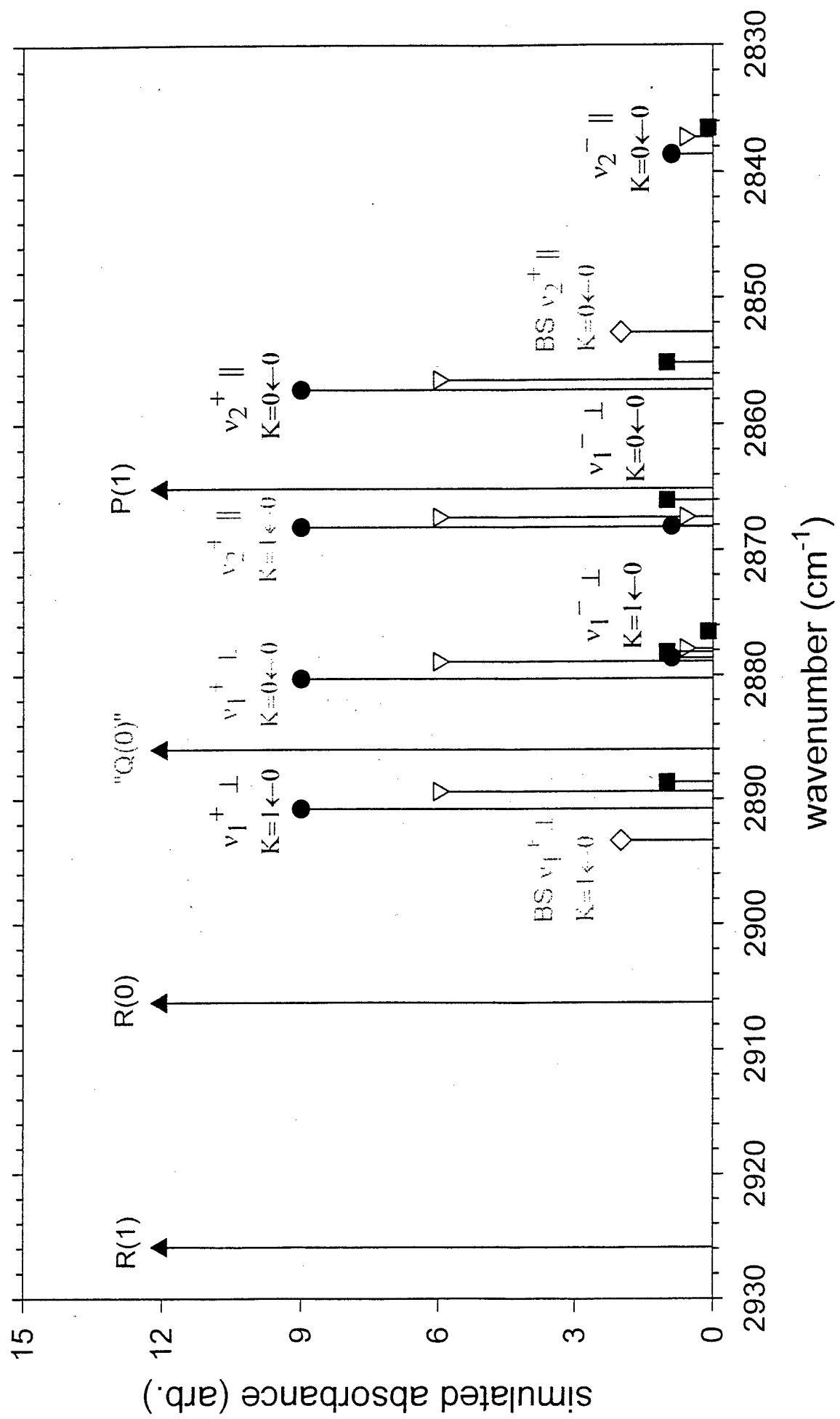

$(\text{HCl})_2 \text{V}_2^+$ region

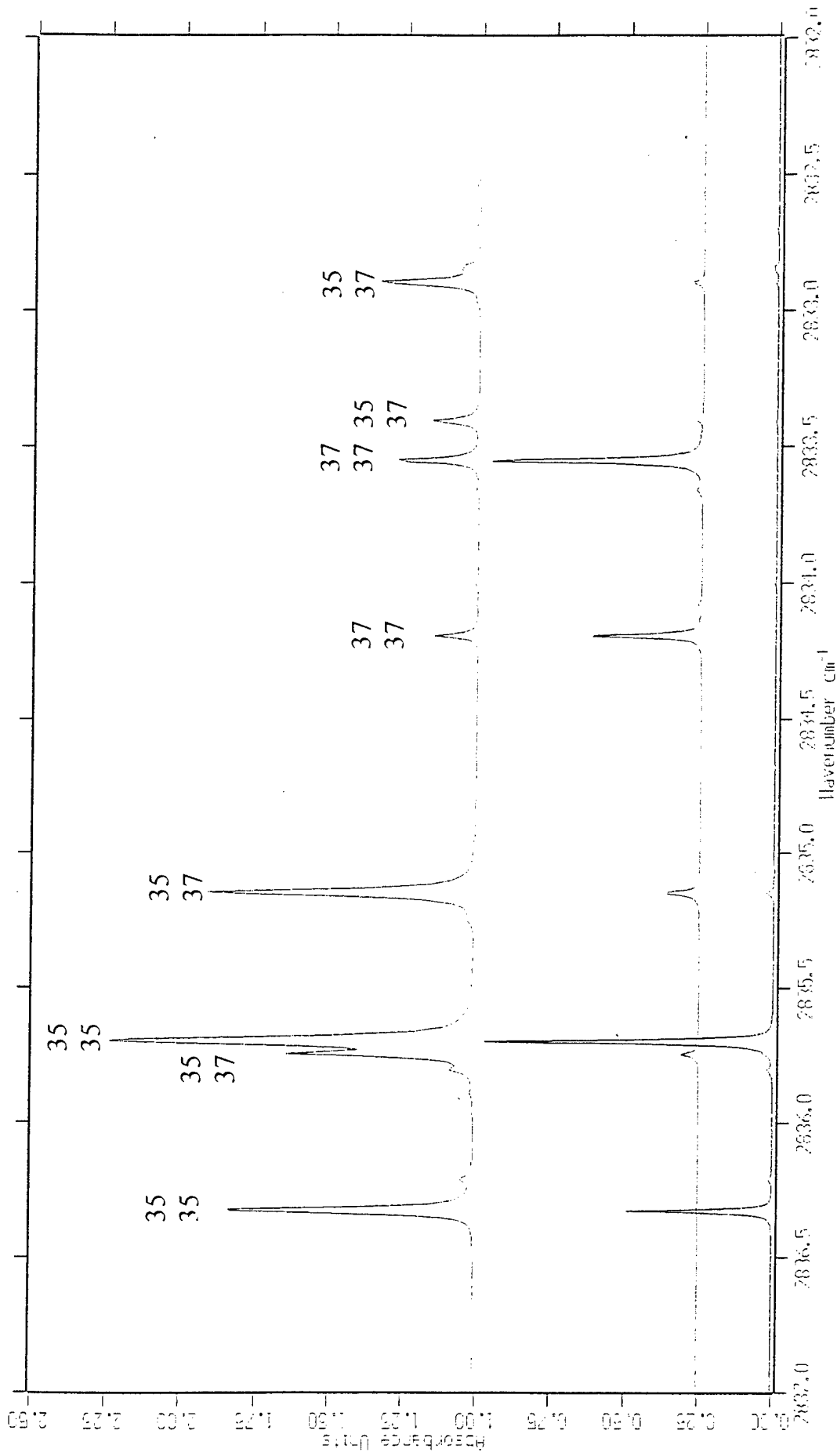

st27061.11 annealed T=2.4K 88 PPM HCl
 st27097.6 annealed T=2.4K 33 PPM ^{37}Cl
 st27073.17 annealed T=2.4K 30 PPM ^{35}Cl

v_0, v_1, v_2 gas phase energy levels
for $(\text{H}^{35}\text{Cl})_2$, $\text{H}^{35}\text{ClH}^{37}\text{Cl}$, and $(\text{H}^{37}\text{Cl})_2$

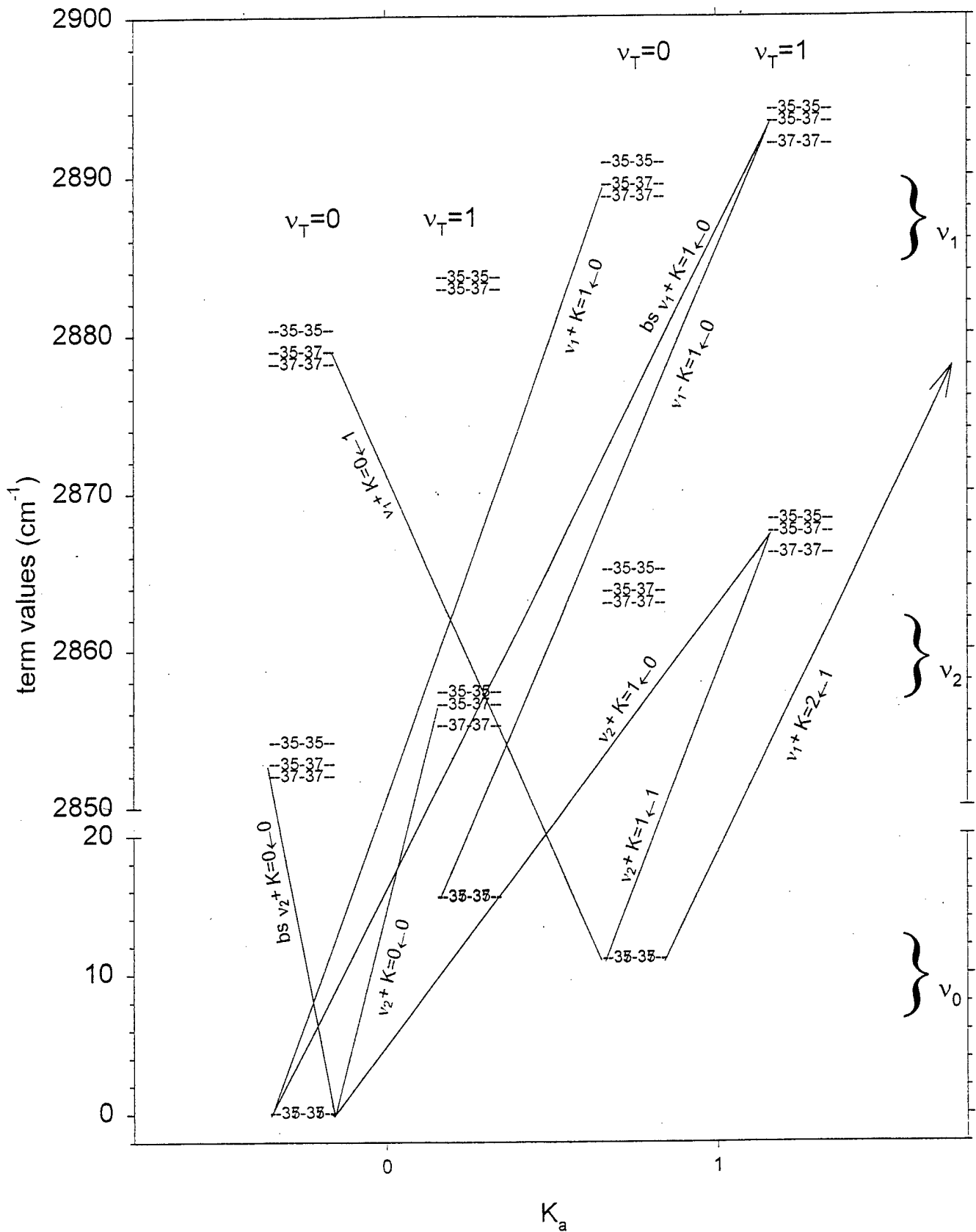

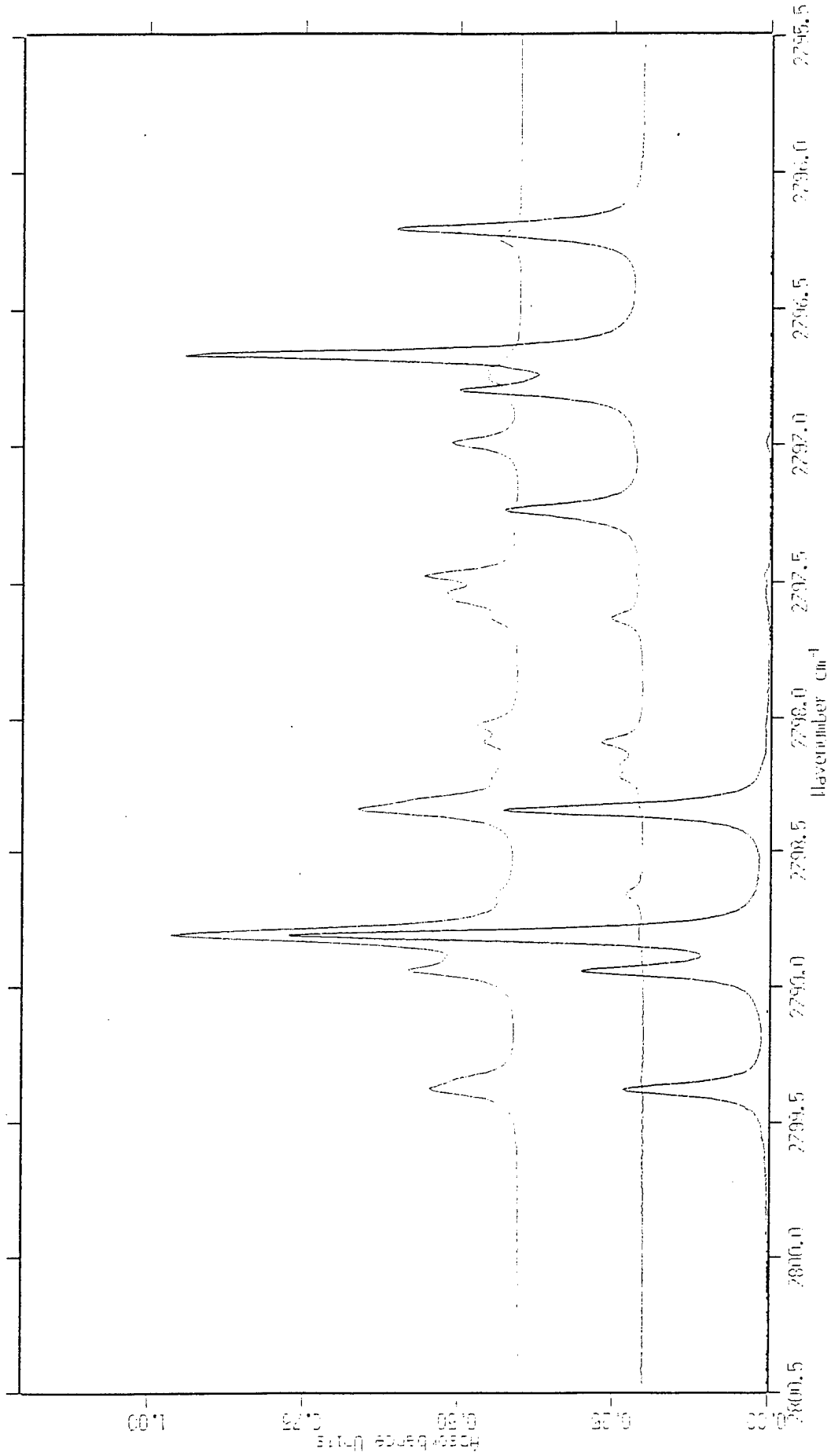

Sample ID	Condition	Temperature (K)	Isotope
st27061.11	annealed	T=2.4K	88 PPM HCl
st27103.6	annealed	T=2.4K	94 PPM H ³⁷ Cl
st27079.11	annealed	T=2.4K	90 PPM H ³⁵ Cl

123 PPM HF/pH₂ d≈3mm

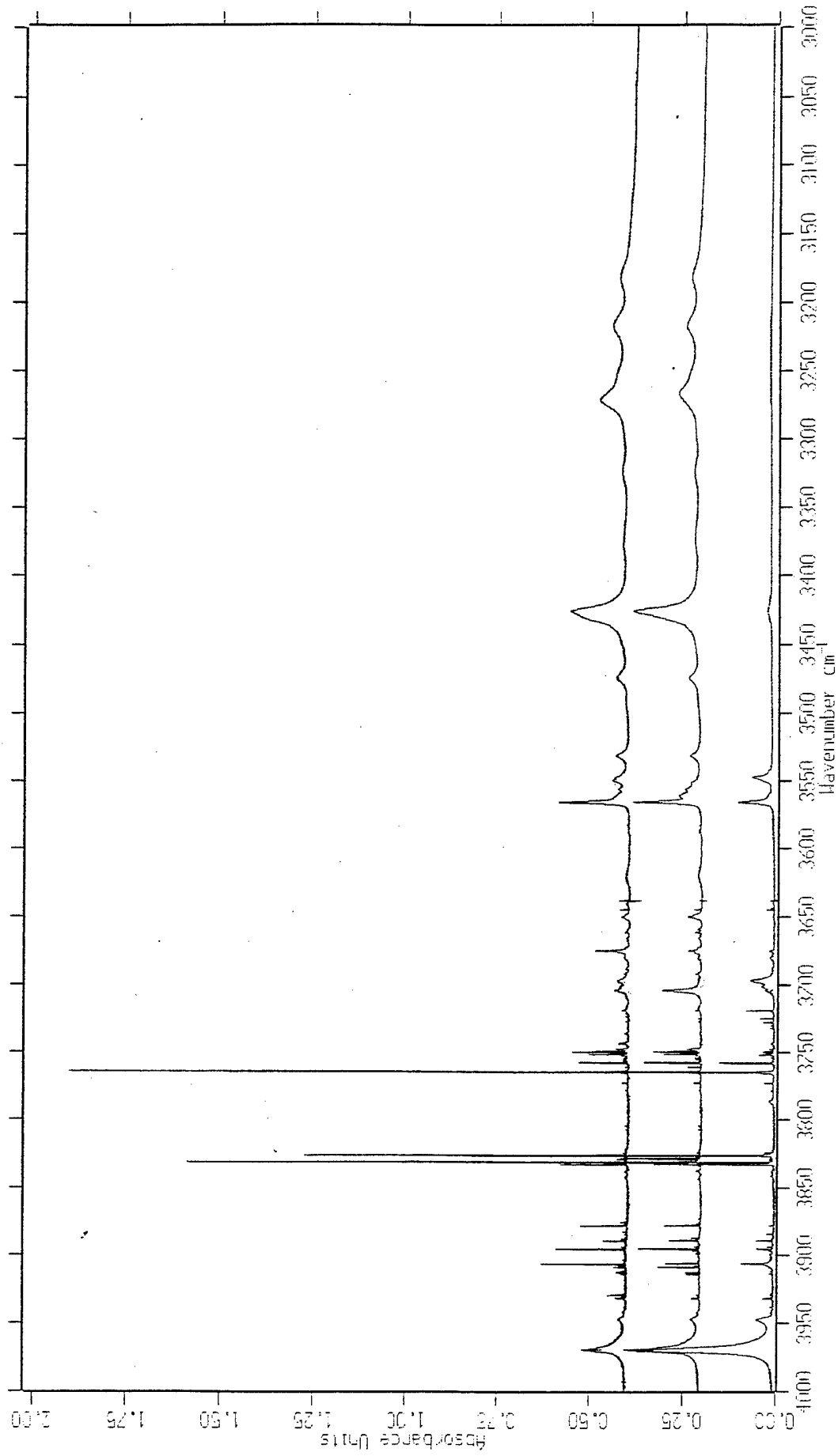

st27115.15 annealed T=2.4K
st27115.13 annealing T=4.8K
st271215.9 as deposited T=2.4K

resolution = 0.005 cm⁻¹

260 PPM HBr/pH₂ d≈3mm

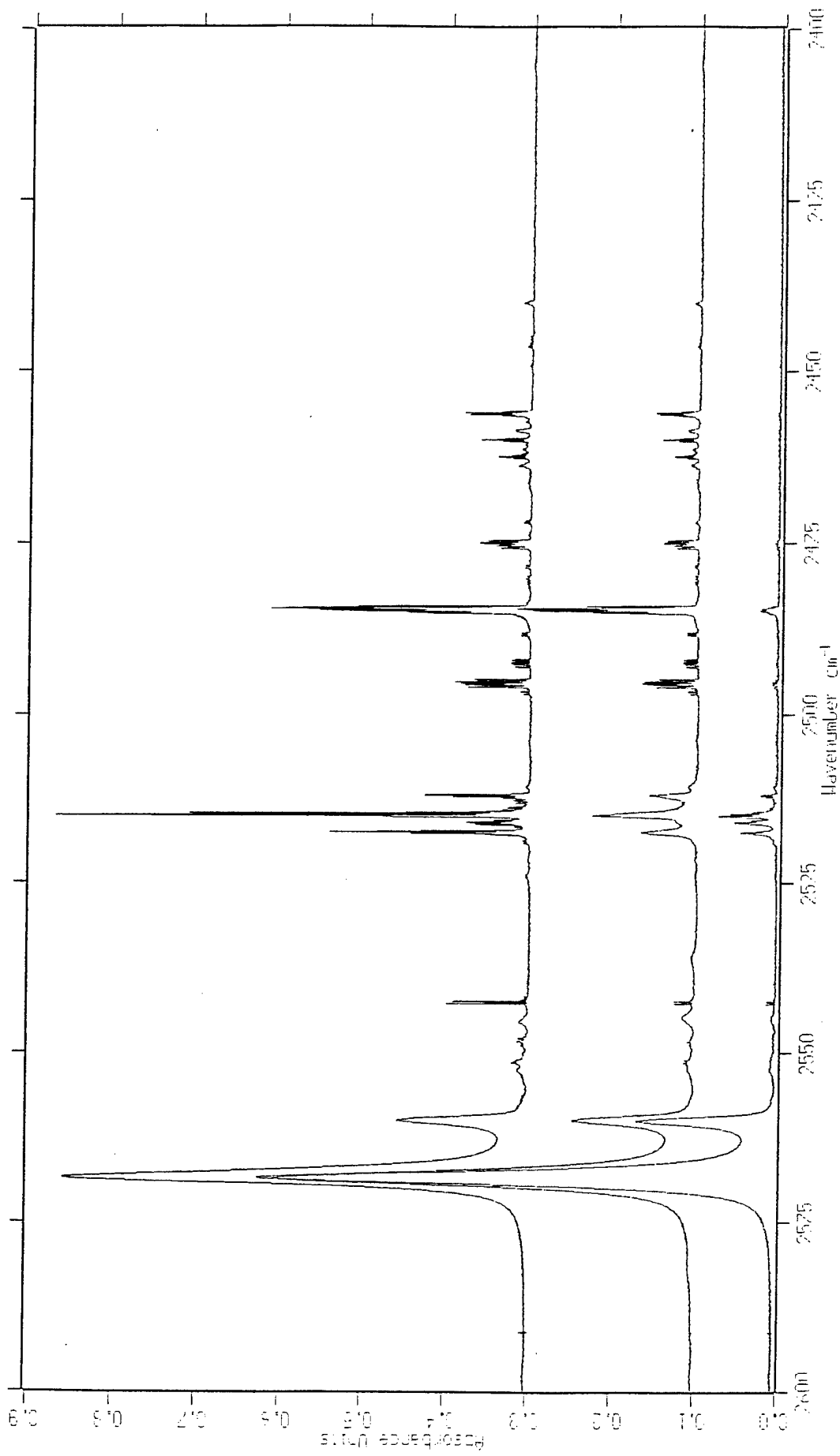

st27145.9

st27145.7

st27145.5

annealed T=2.4K

annealing T=4.8K

as deposited T=2.4K

resolution = 0.005 cm⁻¹

$(\text{HBr})_2/\text{pH}_2$

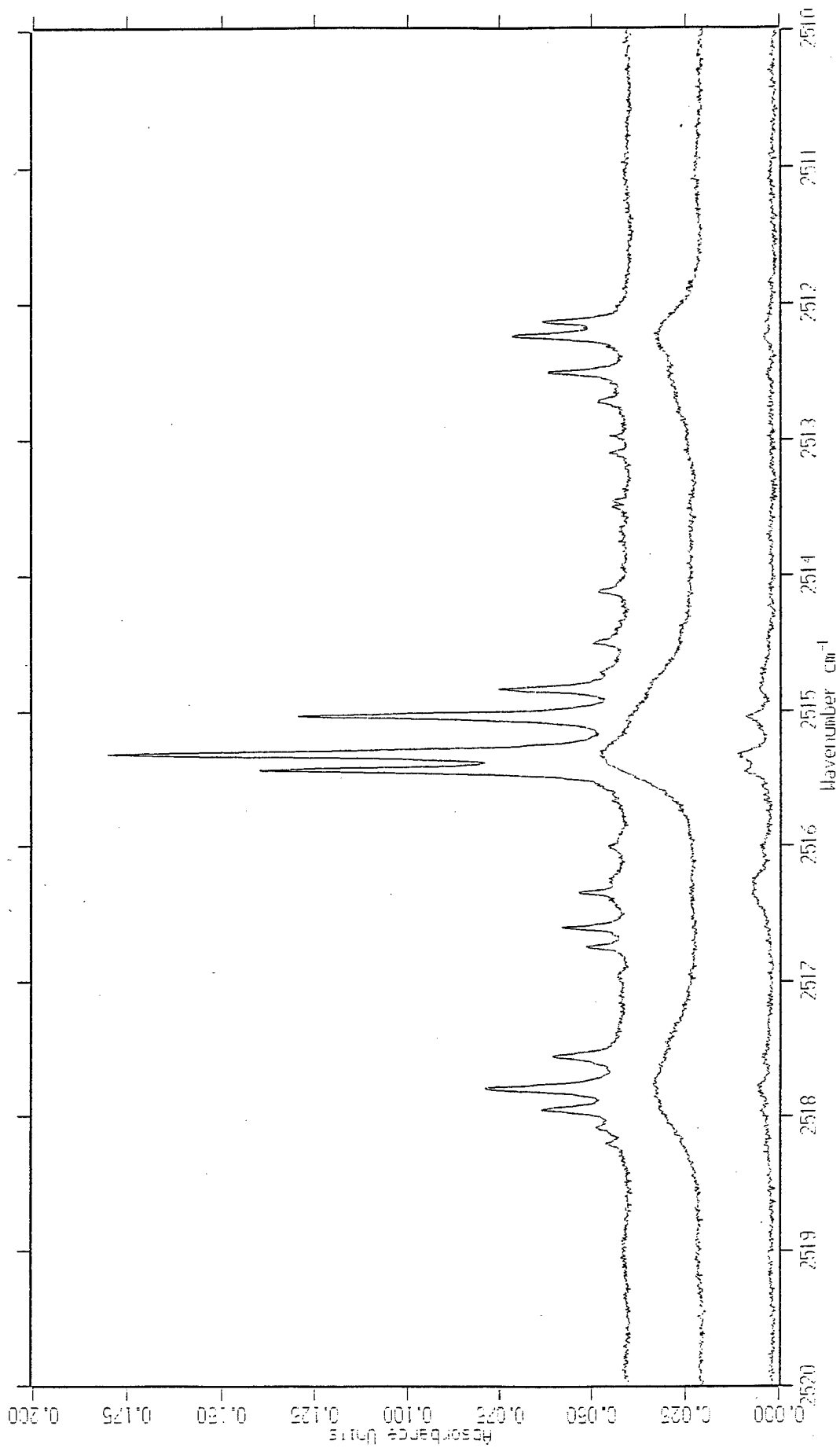

80 PPM HBr/pH_2 $d \approx 3\text{mm}$ resolution = 0.005 cm^{-1}

st27140.5

HCl-(HF, HCl, HBr)/pH₂

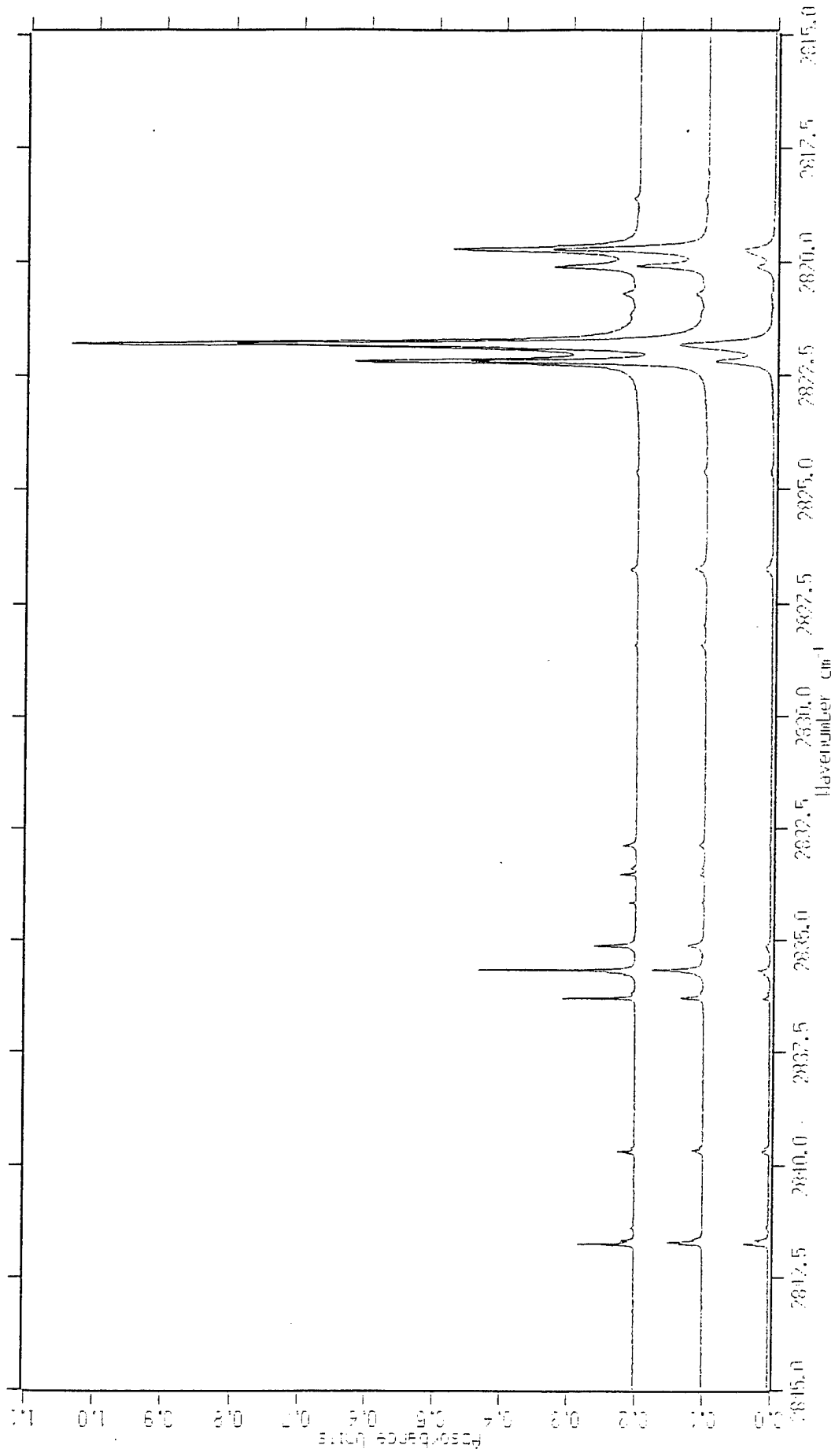

st27145.9

annealed T=2.4K

st27145.7

annealing T=4.8K

st27145.5

as deposited T=2.4K

260 PPM HBr/pH₂ d≈3mm

resolution = 0.005 cm⁻¹

1 PPM CO₂/pH₂ d≈3mm

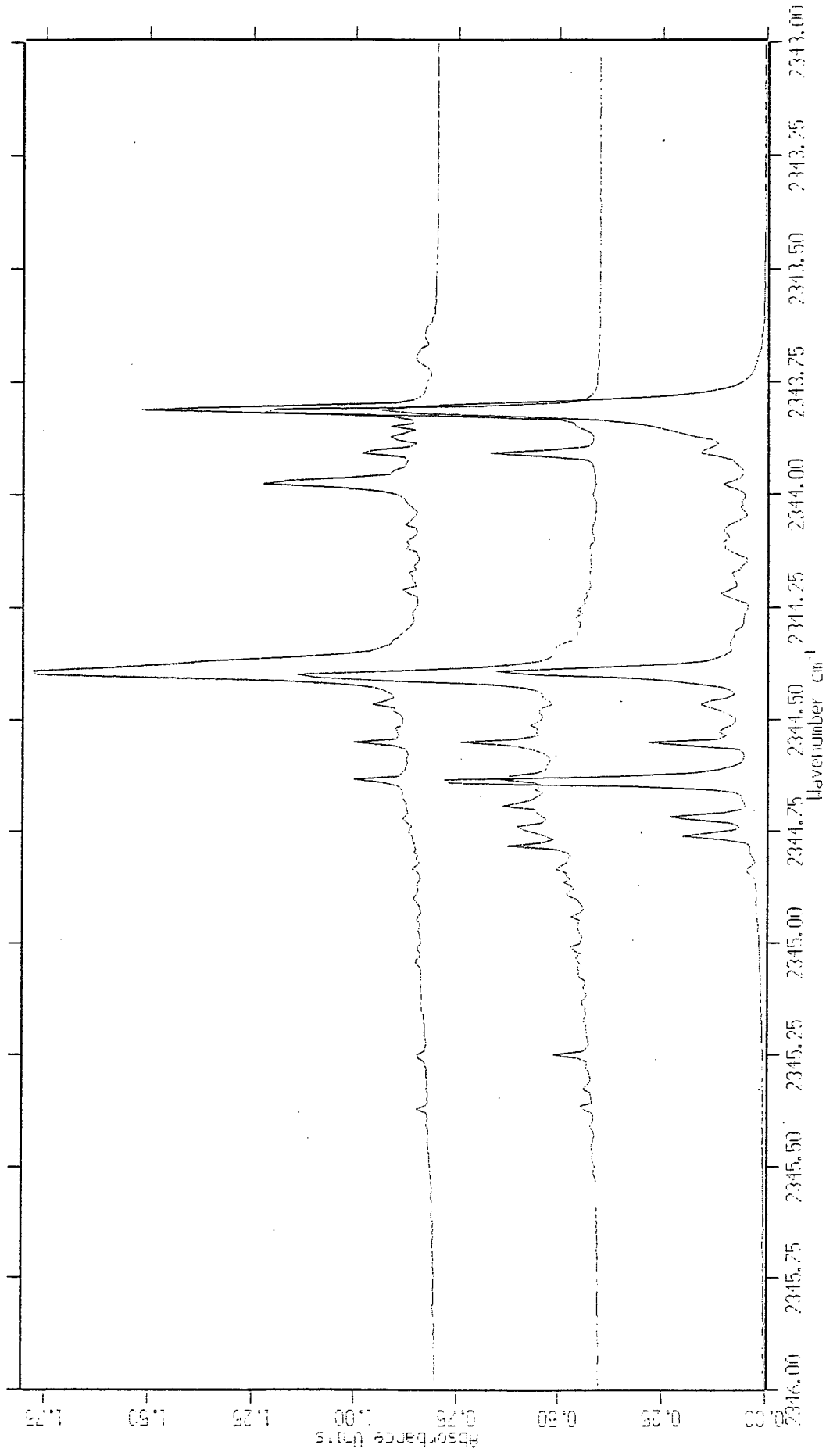

st27025.11 annealed T=2.4K
st27025.9 annealing T=4.8K
st27025.7 as deposited T=2.4K

resolution = 0.005 cm⁻¹

$V_3 \text{CO}_2/(\text{HCl})_n$ clusters

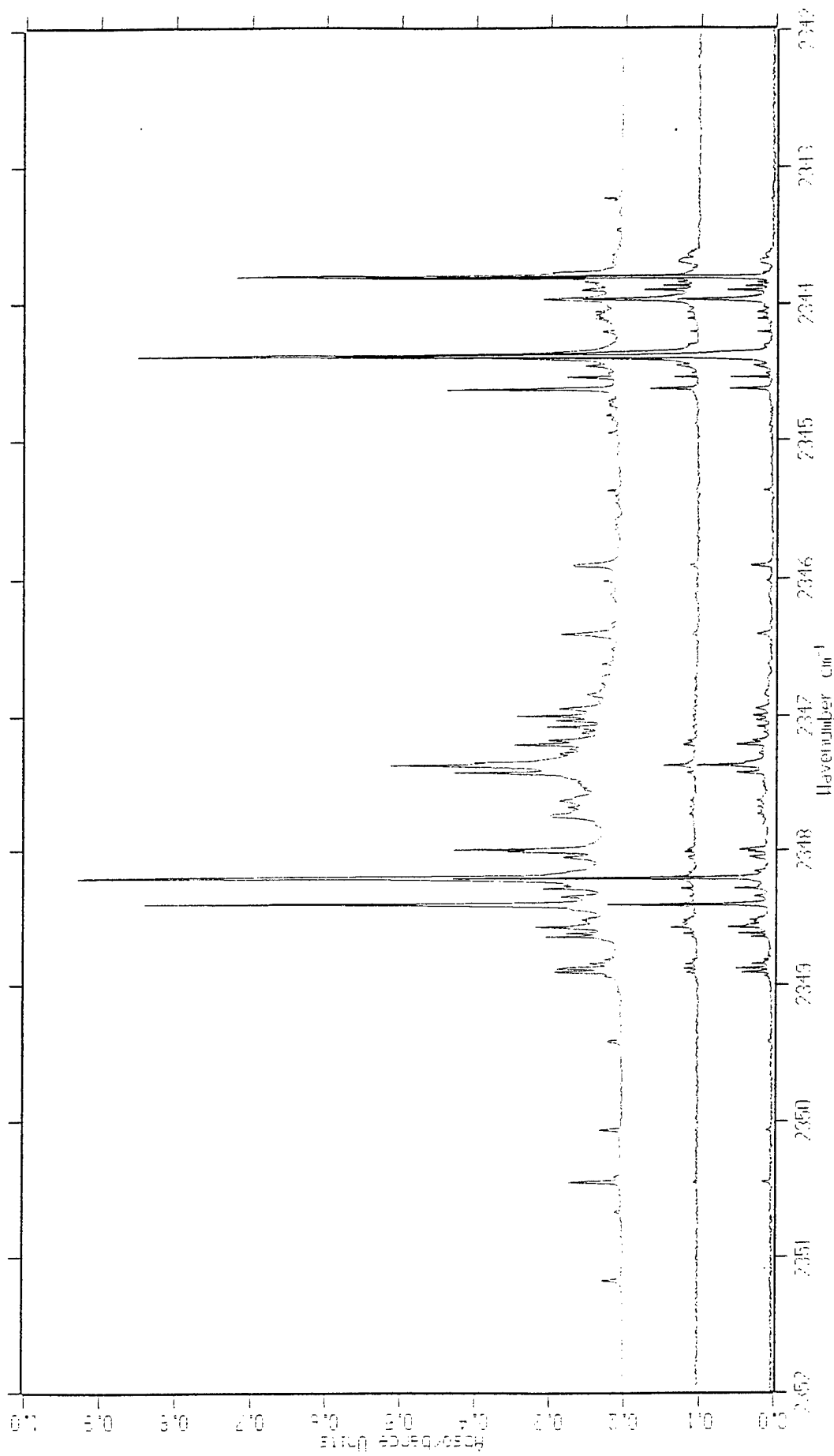

Sample ID	Preparation	Temperature (K)	Peak 1 (cm⁻¹)	Peak 2 (cm⁻¹)	Peak 3 (cm⁻¹)
st27067.10	annealed	T=2.4K	494	94	284
st27103.6	annealed	T=2.4K	494	94	284
st27085.9	annealed	T=2.4K	494	94	284

HEDM Cryosolids Accomplishments

(a list of “things that’ll never work.”)

- * Trapped Li, B, Na, Mg, Al atoms in solid hydrogen.
- * Demonstrated production of gram-scale transparent pH₂ solids by rapid vapor deposition.
- * Demonstrated that vapor deposited pH₂ solids are densest close-packed solids, NOT amorphous.
- * Generalized phenomenon of dopant induced IR activity in pH₂ host; diagnostic for thick, concentrated samples.

Summary and Future Directions

- * Demonstrated suitability of rapid vapor deposited pH₂ solids as hosts for high-resolution IR MIS.
CH₄/pH₂(fcc) & CH₄/pH₂(hcp) [w/T. Momose]
HCl monomers nearly free rotors,
 $B_{\text{HCl/pH}_2} \approx 10.4 \text{ cm}^{-1}$ (vs. 10.6 cm^{-1} gas phase)
HCl dimer does not rotate end-over-end
(?) for H³⁵Cl-H³⁷Cl dimer, $\nu_2=1$ interconversion splitting $\approx 2.3 \text{ cm}^{-1}$ (vs. 3.732 cm^{-1} gas phase)
- * Evaluate/develop theoretical absorption models
crystal field theory
rotation-translation coupling (RTC) model
spectroscopy of “pendular” states
quantum Monte Carlo spectral simulations