

REPORT DOCUMENTATION PAGE

Form Approved
OMB No. 0704-0188

Public reporting burden for this collection of information is estimated to average 1 hour per response, including the time for reviewing instructions, searching existing data sources, gathering and maintaining the data needed, and completing and reviewing this collection of information. Send comments regarding this burden estimate or any other aspect of this collection of information, including suggestions for reducing this burden to Department of Defense, Washington Headquarters Services, Directorate for Information Operations and Reports (0704-0188), 1215 Jefferson Davis Highway, Suite 1204, Arlington, VA 22202-4302. Respondents should be aware that notwithstanding any other provision of law, no person shall be subject to any penalty for failing to comply with a collection of information if it does not display a currently valid OMB control number. PLEASE DO NOT RETURN YOUR FORM TO THE ABOVE ADDRESS.

1. REPORT DATE (DD-MM-YYYY)		2. REPORT TYPE Technical Papers		3. DATES COVERED (From - To)	
4. TITLE AND SUBTITLE				5a. CONTRACT NUMBER	
				5b. GRANT NUMBER	
				5c. PROGRAM ELEMENT NUMBER	
6. AUTHOR(S)				5d. PROJECT NUMBER 2302	
				5e. TASK NUMBER MIG2	
				5f. WORK UNIT NUMBER	
7. PERFORMING ORGANIZATION NAME(S) AND ADDRESS(ES) Air Force Research Laboratory (AFMC) AFRL/PRS 5 Pollux Drive Edwards AFB CA 93524-7048				8. PERFORMING ORGANIZATION REPORT	
9. SPONSORING / MONITORING AGENCY NAME(S) AND ADDRESS(ES) Air Force Research Laboratory (AFMC) AFRL/PRS 5 Pollux Drive Edwards AFB CA 93524-7048				10. SPONSOR/MONITOR'S ACRONYM(S)	
				11. SPONSOR/MONITOR'S NUMBER(S)	
12. DISTRIBUTION / AVAILABILITY STATEMENT Approved for public release; distribution unlimited.					
13. SUPPLEMENTARY NOTES					
14. ABSTRACT					
15. SUBJECT TERMS					
16. SECURITY CLASSIFICATION OF:			17. LIMITATION OF ABSTRACT A	18. NUMBER OF PAGES	19a. NAME OF RESPONSIBLE PERSON Leilani Richardson
a. REPORT Unclassified	b. ABSTRACT Unclassified	c. THIS PAGE Unclassified			19b. TELEPHONE NUMBER (include area code) (661) 275-5015

Standard Form 298 (Rev. 8-98)
Prescribed by ANSI Std. Z39.18

36 separate items are enclosed
122 039

G2

MEMORANDUM FOR PRS (In-House Publication) Propulsion Science and Advanced Concepts Division

FROM: PROI (TI) (STINFO)

30 Nov 2000

SUBJECT: Authorization for Release of Technical Information, Control Number: AFRL-PR-ED-TP-2000-227
Miller, T. C., "Fracture Mechanics Research at Air Force Research Laboratory"

Visit by Swedish Diplomats to AFRL
(AFRL/Edwards, 05 Dec 2000)

(Statement A)

1. This request has been reviewed by the Foreign Disclosure Office for: a.) appropriateness of distribution statement, b.) military/national critical technology, c.) export controls or distribution restrictions, d.) appropriateness for release to a foreign nation, and e.) technical sensitivity and/or economic sensitivity.

Comments: _____

Signature _____ Date _____

2. This request has been reviewed by the Public Affairs Office for: a.) appropriateness for public release and/or b) possible higher headquarters review.

Comments: _____

Signature _____ Date _____

3. This request has been reviewed by the STINFO for: a.) changes if approved as amended, b) appropriateness of references, if applicable; and c.) format and completion of meeting clearance form if required

Comments: _____

Signature _____ Date _____

4. This request has been reviewed by PR for: a.) technical accuracy, b.) appropriateness for audience, c.) appropriateness of distribution statement, d.) technical sensitivity and economic sensitivity, e.) military/national critical technology, and f.) data rights and patentability

Comments: _____

APPROVED/APPROVED AS AMENDED/DISAPPROVED

PHILIP A. KESSEL Date
Technical Advisor
Propulsion Science and Advanced Concepts Division

Cleared (PA) _____
Logged (PA) _____
Notified (PA) _____
Copied & Distributed (STINFO) _____
This original is for PA files

Fracture Mechanics Research at Air Force Research Laboratory

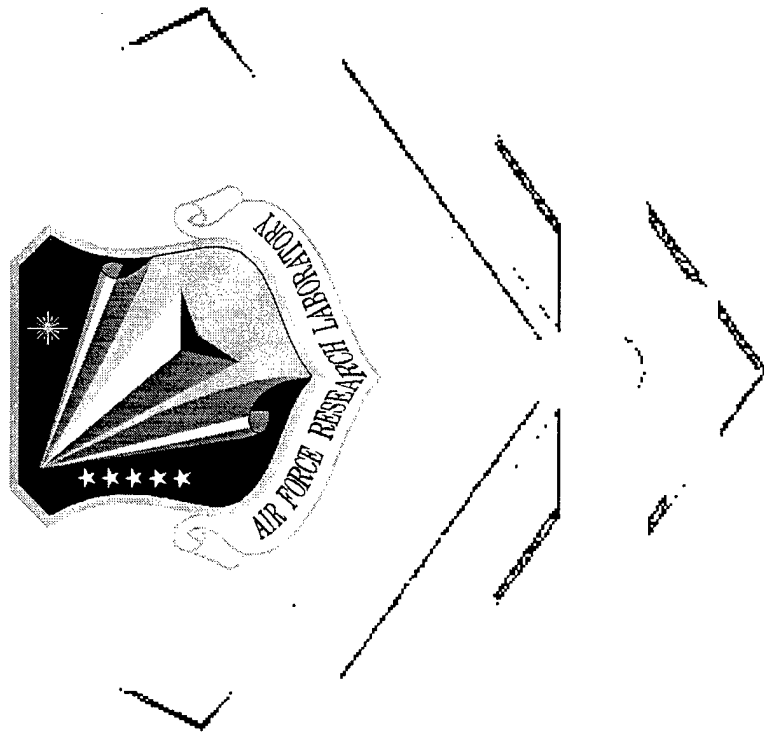

December 5, 2000

20021122 039



Two Crack Failure Modes in Solid Rocket Motors

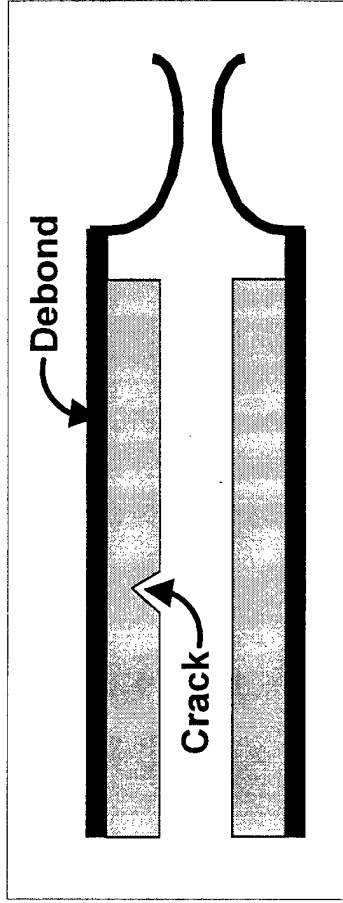

- Does Crack Propagate Under Service Loads?
- If the Crack Propagates, How Does it Propagate?

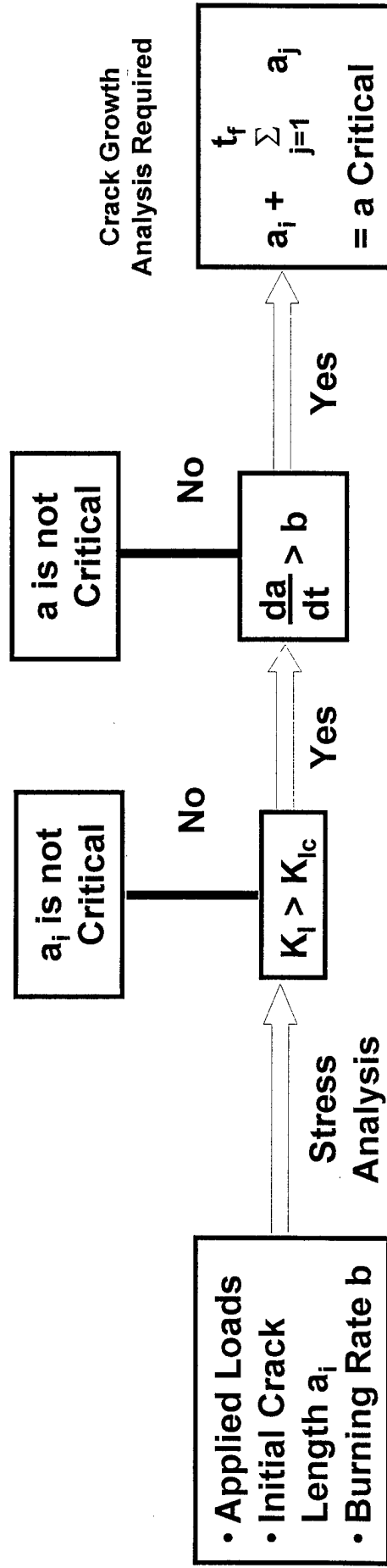



Good Correlation Exists Between the Predicted and the Measured Crack Initiation Load and the Initial Crack Length

- Based on a Micro-Macromechanical Model and a Stress Instability Criterion, the Predicted and Measured Average Initial Crack Lengths are 1.2 mm and 1.0 mm for $D = 0.25$ inch Hole and 1.5 mm and 1.3 mm for $D = 0.5$ inch Hole.

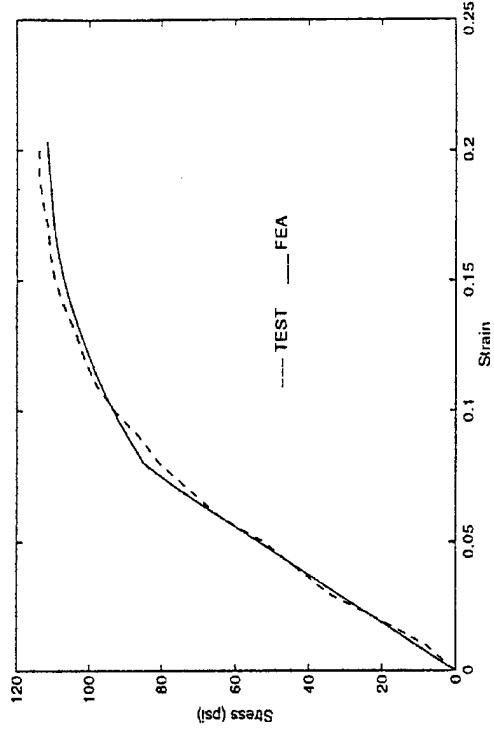
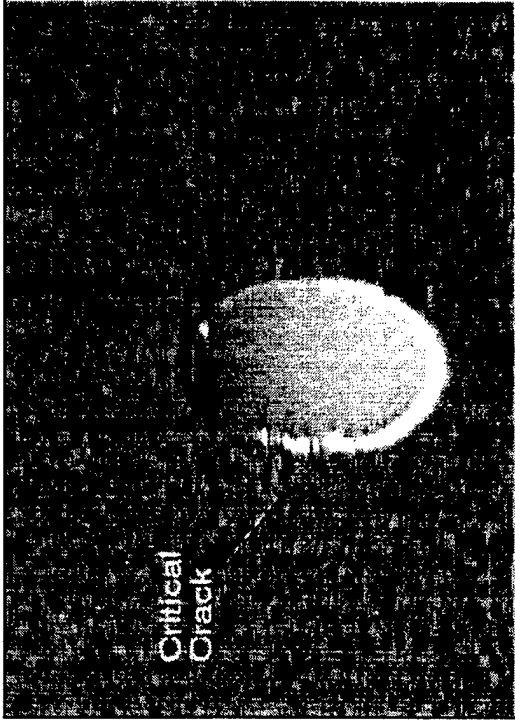

Stress-Strain Curve at Strain Rate 0.02/min

There Exists a Representative Area for a Valid Continuum Assumption of Solid Propellant



- Based on micro-measurements, the representative area is 2 mm x 2 mm.
- The existence of the representative area provides a basis for conducting stress analysis of solid rocket motors from nondestructive testing data.

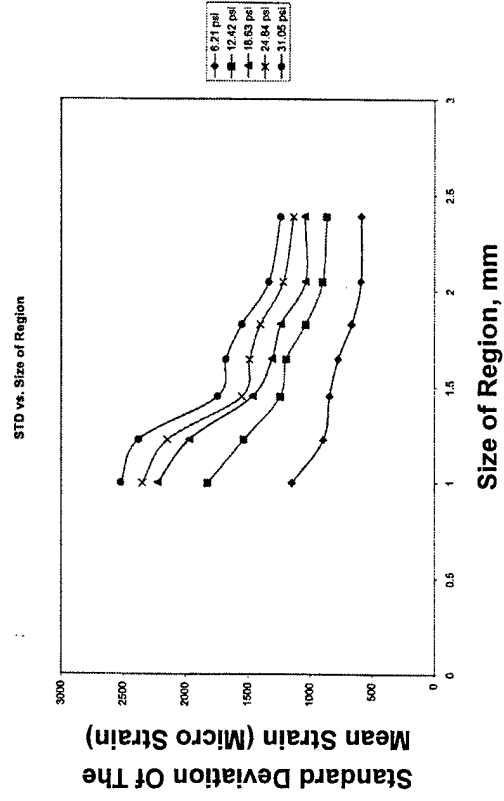
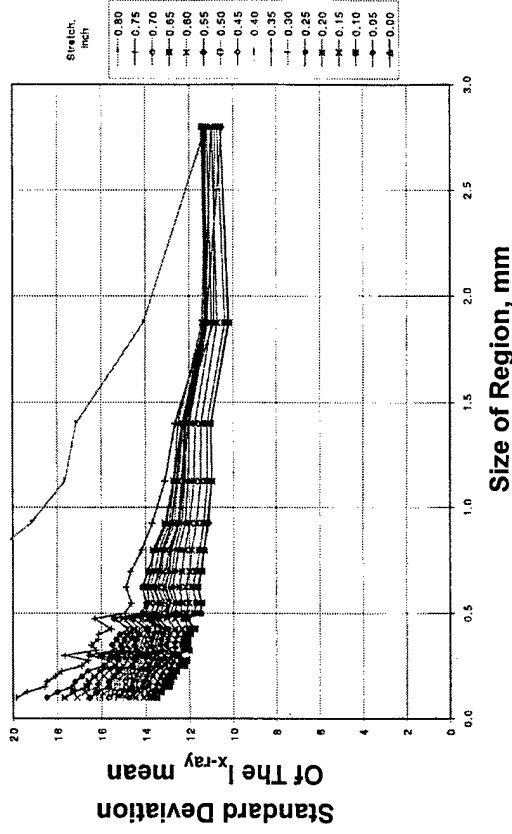



A Technique is Developed to Predict the Initial Crack Length in Solid Propellants

- Based on fracture mechanics and fracture data, the predicted and the estimated initial crack lengths are 3.3 mm and 2.5 mm, respectively.
- The initial crack size follows the second asymptotic distribution of the maximum value.
- The determination of the statistical distribution function of the initial crack makes statistical analysis of crack growth feasible.

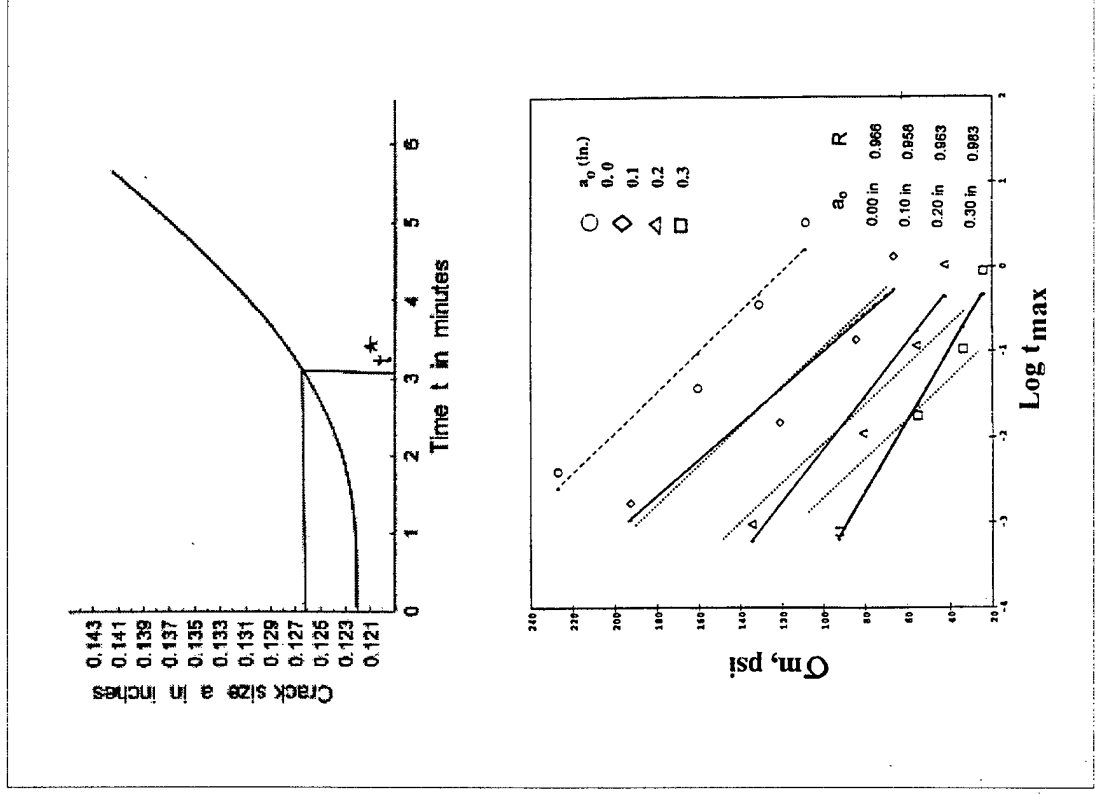

The Inhomogeneity of Microstructure Plays a Key Role in Crack Initiation and Growth



- Non-propagating cracks are formed in weak regions with a mean crack length of 1.5 mm
- In general, a critical crack is formed by the coalescence of small non-propagating cracks with an average critical crack length of 3.15 mm

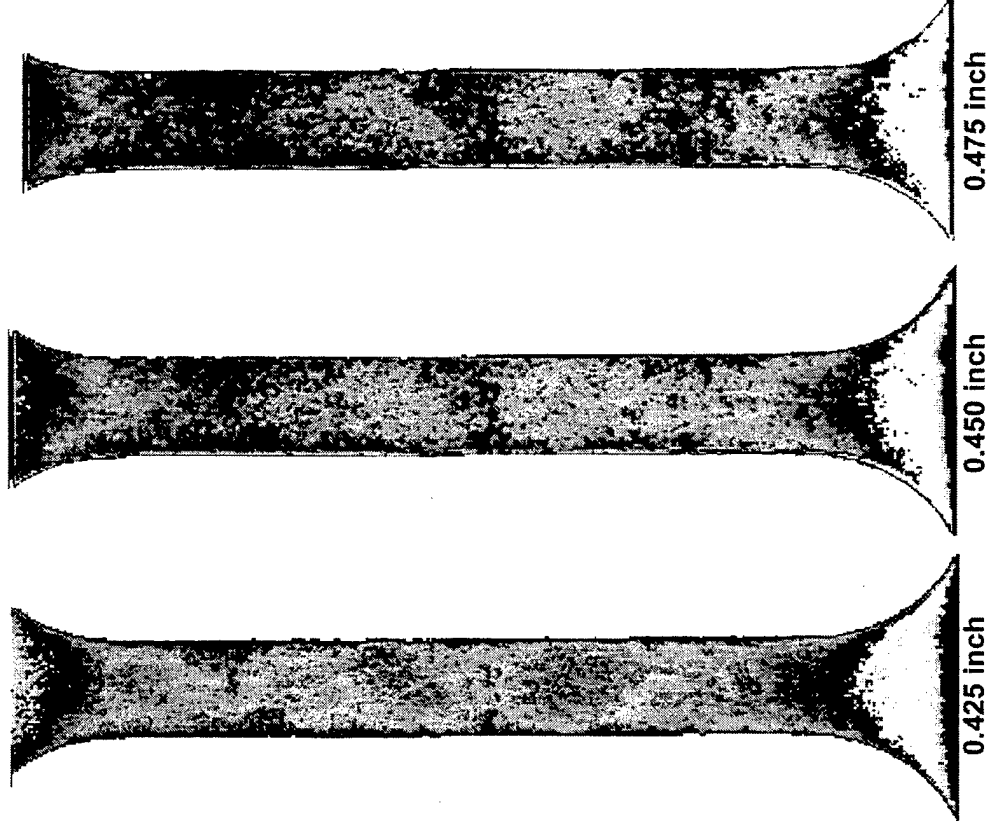

Microstructure Induces a Large Inhomogeneous Variation in the Strain Field Near the Crack Tip

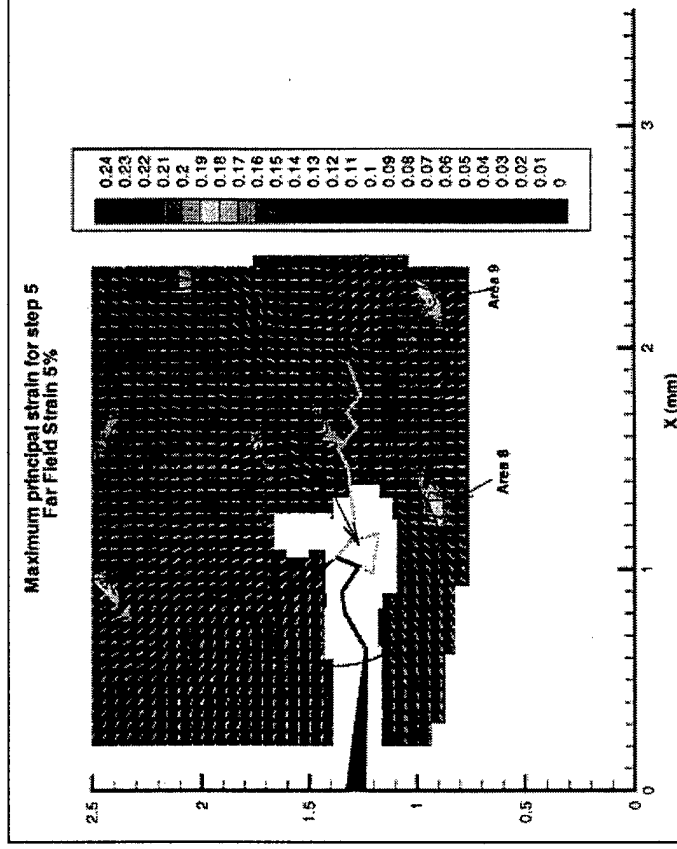
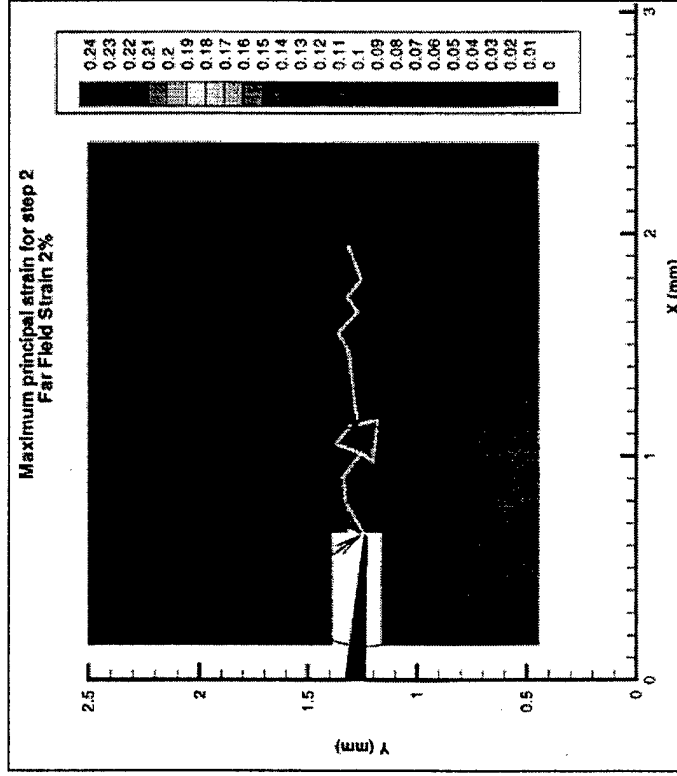

- The Interaction Between Large Deformation and Crack Propagation Process Localizes around The Crack Tip Regions

The Predicted Crack Growth Behavior Compares Well with Experimental Observation



- The variation of the strain rate near the crack tip was included in computer simulations of crack growth.
- The realistic modeling of crack growth can be a useful tool in predicting service life of solid rocket motors

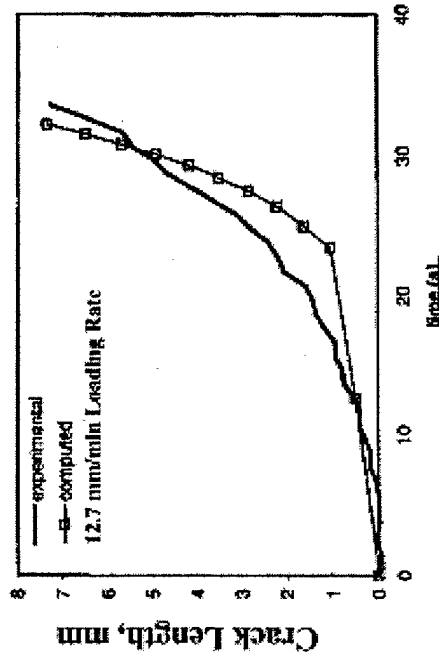
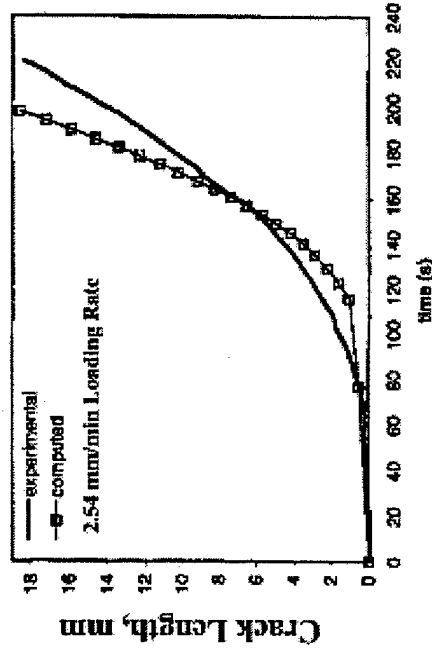



Critical Defect Assessment (CDA) Program Introductory Information



Objectives:

Enhance the capabilities of the existing service life prediction methods of the Structural/Ballistic Analysis System (SBAS) in three areas:

- Fracture mechanics**
- Coupled analyses between structural mechanics and Computational Fluid Dynamics (CFD) codes**
- Automated geometric modeling of known flaws using non-destructive evaluation (NDE) data**



CDA Task 1: Fracture Mechanics



Objectives:

Conduct exploratory development effort to enhance existing fracture mechanics models of:

- Development of the initial crack - its geometry and size (continuum failure)
- Growth initiation threshold
- Fracture growth propagation -- the direction and speed of propagation

Develop algorithms for building fracture modules into existing capabilities, such as SBAS



CDA Task 1.1: Initial Crack Development



Analytical Methods:

- **Coalescence of local load-induced damage zones forms a crack**
 - **Continuum failure criterion will be used to determine when local material elements will fail**
 - **Experimental data will show the contour of the damage zone formed by coalesced failed elements**
 - **The coalesced damage zone represents the initial crack**
- **When possible, the micromechanics model in the SLPT program will be employed**

CDA Task 1.2: Crack Growth Initiation Threshold or Onset



Crack Growth Initiation Threshold or Onset

- The predictive method on this subject is reasonably developed (e.g. NASA SPIP, AF S/BRAM programs)
- The analysis method is built upon a linear elastic model. Exploratory effort on using non-linear viscoelastic (NLVE) models are also being examined
- Fracture mechanics parameters, stress intensity factor (K), strain energy release rate (G), and the J-integral, are interchangeably used
- Satisfactory predictions of crack and debond growth onsets have been made (e.g. CPIA publications)

CDA Task 1.3: Crack Growth Propagation



Characteristic Relationship Between Crack Speed and Stress Intensity Factor "K"

