

Mechanical System Simulations for Seismic Signature Modeling

October 2001

J. Lacombe, M. Moran, D. Harjes

US Army Corps of Engineers, ERDC-CRREL
72 Lyme Rd., Hanover NH 03755
jlaco@crrel.usace.army.mil
603-646-4341

ABSTRACT

In this paper we present seismic signature simulations using ground vibration inputs from high-fidelity 3-D mechanical system models. Results for an M1A1 and T72 are discussed. By analyzing the simulated seismic signature data in conjunction with the spectral features associated with the vibrations of specific vehicle sprung and un-sprung components we are able to make unambiguous associations of seismic signal features with suspension elements, offering valuable insight into target classification.

The development of a utility ("Tankmod") to streamline creation of DADS¹ tracked vehicle dynamic models for generating seismic signals was reported in 2000.² A model of an M1A1 tank created using Tankmod was described. During the past year, two new models were created: a T72 tank and a BMP-2 armored personnel carrier. In addition, an improved vehicle speed/steer controller was developed. The new controller maintains realistic vehicle behavior by properly limiting drive sprocket torques and sprocket rotation for skid steering. Model inputs used in seismic signature modeling are in the form of time series of ground reaction force and absolute position for each track block.

Seismic signatures are given for an M1A1 vehicle operating over a 230 m x 280 m terrain grid with vertical relief. To emphasize the signature aspects of the results, we use a homogeneous subsurface consistent with a glaciated soil. Seismic signatures are also given for M1A1 and T72 vehicles following similar straight-ahead path and speed profiles. Seismic spectrograms in the 20-60 Hz band clearly demonstrate harmonic families associated with the fundamental track-block passage rate and the target speed profile. Lower frequency seismic signal spectral peaks (below 5 Hz) are demonstrated in standard PSD spectra. We tentatively associate these low frequency peaks with the low frequency resonances observed in the vertical and pitch motions of the vehicle sprung mass (hull and turret). Spectral peaks in this frequency band will propagate for 10's of kilometers and may serve as important target classification features.

¹ Dynamic Analysis Design System (DADS), LMS International, CAE Division, Coralville, Iowa.

² Lacombe, J., Moran, M. and S. Happel, "A 3-Dimensional Dynamics Model For Generating Tracked Vehicle Seismic Signals", Proceedings, 2000 Meeting of the MSS Specialty Group on Battlefield Acoustic and Seismic Sensing, 440000-195-X (I), pp 377-383, Jan. 2001.

Report Documentation Page

Report Date 00 Oct 2001	Report Type N/A	Dates Covered (from... to) -
Title and Subtitle Mechanical System Simulations for Seismic Signature Modeling	Contract Number	
	Grant Number	
	Program Element Number	
Author(s)	Project Number	
	Task Number	
	Work Unit Number	
Performing Organization Name(s) and Address(es) US Army Corps of Engineers, ERDC-CRREL 72 Lyme Rd. Hanover, NH 03755	Performing Organization Report Number	
Sponsoring/Monitoring Agency Name(s) and Address(es) Department of the Army, CECOM RDEC Night Vision & Electronic Sensors Directorate AMSEL-RD-NV-D 10221 Burbeck Road Ft. Belvoir, VA 22060-5806	Sponsor/Monitor's Acronym(s)	
	Sponsor/Monitor's Report Number(s)	
Distribution/Availability Statement Approved for public release, distribution unlimited		
Supplementary Notes See also ADM201471, Papers from the Meeting of the MSS Specialty Group on Battlefield Acoustic and Seismic Sensing, Magnetic and Electric Field Sensors (2001) Held in Applied Physics Lab, Johns Hopkins Univ, Laurel, MD on 24-26 Oct 2001. Volume 2 (Also includes 1999 and 2000 Meetings), The original document contains color images.		
Abstract		
Subject Terms		
Report Classification unclassified	Classification of this page unclassified	
Classification of Abstract unclassified	Limitation of Abstract UU	
Number of Pages 10		

1. Introduction

High-fidelity models of tracked armored vehicles are currently being developed using DADS¹ dynamic analysis software to support the U.S. Army Engineer Research and Development Center (ERDC) seismic/acoustic research program. Ground force outputs from these models serve as target signal excitation to ERDC seismic propagation simulations.³ During the past year, improvements were made to a previously built model of an M1A1 tank, and two new vehicle models were created (T72 and BMP-2). Moving vehicle simulations were conducted using the M1A1 and T72 models, and the resulting ground force data used as input to seismic propagation simulations. Seismic spectrograms for fixed terrain locations were generated from simulation results, and dominant seismic spectral features have been associated with specific vehicle characteristics.

2. Vehicle Model Development

2.1. M1A1 Model

A general description of the M1A1 vehicle model is provided in the 2000 MSS Symposium proceedings². This model and others developed for the seismic program emphasize the suspension elements on the vehicle (Figure 1). The hull and turret (including contents) are treated as simple rigid bodies. One major improvement was made to the M1A1 model this past year. It involved the replacement of the original vehicle controller that had been created using Tankmod. The original controller consisted of a simple proportional speed amplifier and steer control element that corrected for speed/steer errors through application of proportional torques at both drive sprockets. It didn't represent skid steering adequately and it generated excessive traction sprocket torques during cornering. The original controller was replaced with a design that mimics skid steering properly by monitoring sprocket rotation and restricting it to the "forward" direction. Sprocket rotation rate is also monitored to limit applied sprocket torque to "available engine horsepower" divided by "sprocket rotation rate". A schematic of the new controller is shown in Figure 2.

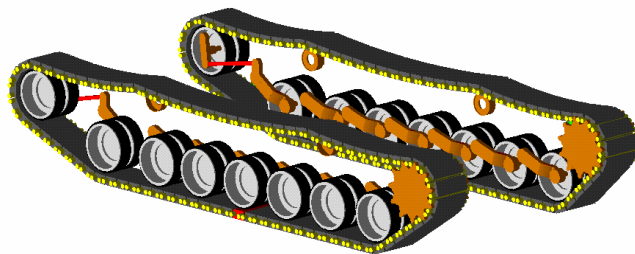

Figure 1. M1A1 model suspension elements.

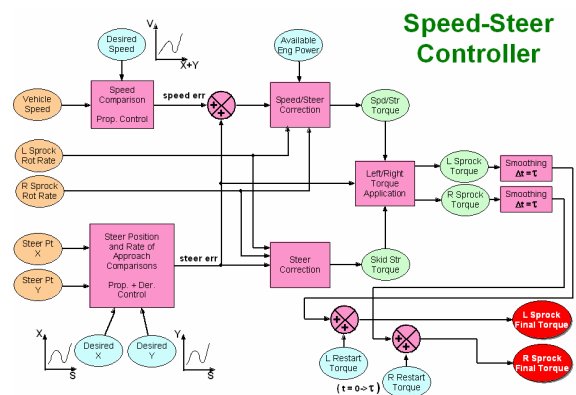

Figure 2. Improved speed/steer controller.

³ Moran, M., Ketcham, S., and Greenfield, R., "Three Dimensional Finite-Difference Seismic Signal Propagation", Proceedings of the 1999 Meeting of the MSS Specialty Group on Battlefield Acoustics and Seismics, 1999.

2.2. T72 and BMP-2 Models

Two new armored vehicle DADS models were developed this past year using Tankmod. A model of a T72 tank was successfully completed (Figure 3) and a model of a BMP-2 armored personnel carrier is nearly complete (Figure 4). Completion of the latter was delayed by a programming error in Tankmod dealing with initial positioning of individual track blocks in each track assembly. The problem impacts model configurations with drive sprockets at the front of the vehicle, rather than at the rear, which is the case for the BMP-2. Corrections have been made to Tankmod however, and a completed BMP-2 model will soon be available.



Figure 3. T72 tank – Actual photo and DADS model.



Figure 4. BMP-2 – Actual photo and in-progress DADS model.

2.3. Ground Force Output

A binary output record of the motion and forces at every body in the vehicle model is generated during a DADS dynamic simulation. This includes the ground forces acting at each track block, which as discussed in Reference 2, are calculated using multiple DADS “point-ground” contact elements. The point-ground contact element includes a routine based on a modified set of Bekker⁴ soil equations that is used to calculate normal and tangential ground forces. Six such elements are deployed per track block, although the option will soon exist in Tankmod to increase this number so that complex track block grouser geometries can be more accurately represented.

For the purpose of generating vehicular input data for seismic propagation modeling, track/ground interaction forces and positions are extracted from the DADS binary output file. This is accomplished using a set of Unix scripts and the DADSGRAPH utility in DADS. DADSGRAPH is a convenient

⁴ Bekker, M.G., Introduction to Terrain-Vehicle Systems, Ann Arbor, MI, University of Michigan Press, 1969.

feature for reading DADS binary output and either plotting or archiving results for later analyses. A data file is created for each track block. It contains time histories of the absolute coordinates of the track block and the sum of all its force vectors into the ground. Each track block is in-effect treated as a separate signal source for the seismic propagation model. The number of input source files therefore equals the number of vehicle track blocks. The latter number is 156 for the M1A1, 192 for the T72 and 168 for the BMP-2. The reporting time interval for track block data is currently 0.005 seconds.

Figure 5 shows a plot of a short segment of modeled ground force data for a single track block on an M1A1 moving at 28 km/hr. A “positive” vertical force acts into the ground while a “positive” shear force acts in the direction opposite to vehicle forward motion. The passage of each of the seven vehicle road wheels is clearly discernable. It is interesting to note that the shear force alternates between positive and negative values as each road wheel passes. The magnitudes of this sign reversal are great enough during passage of some of the inner road wheels (Numbers 2-6) to result in a net resistive, rather than tractive force during passage of a road wheel. The Bekker soil parameters used in this and other simulations discussed in this paper characterize a firm sandy loam.

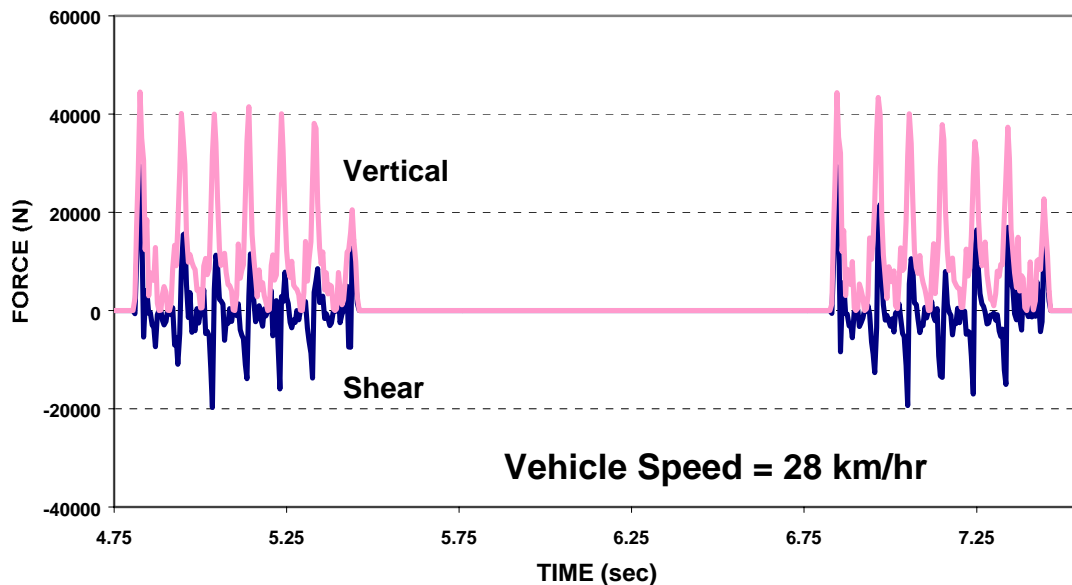

Figure 5. Sample of modeled ground forces generated by an M1A1 track block.

3. Vehicle Simulations

3.1. M1A1 and T72

Moving vehicle simulations were conducted this past year using the M1A1 and T72 models. One simulation was designed to troubleshoot the new speed/steer controller previously discussed. It involved a series of simple vehicular maneuvers. An M1A1 was accelerated from rest to 15 kph, driven up a 20% grade to a flat plateau, turned right, driven down another 20% slope, turned left and finally braked to a stop. The simulation was run several times to evaluate design modifications to the controller. Smooth and stable vehicle behavior was eventually achieved over the entire length of the simulation. Figure 6 shows the overall layout of the simulation including the path that the vehicle followed.

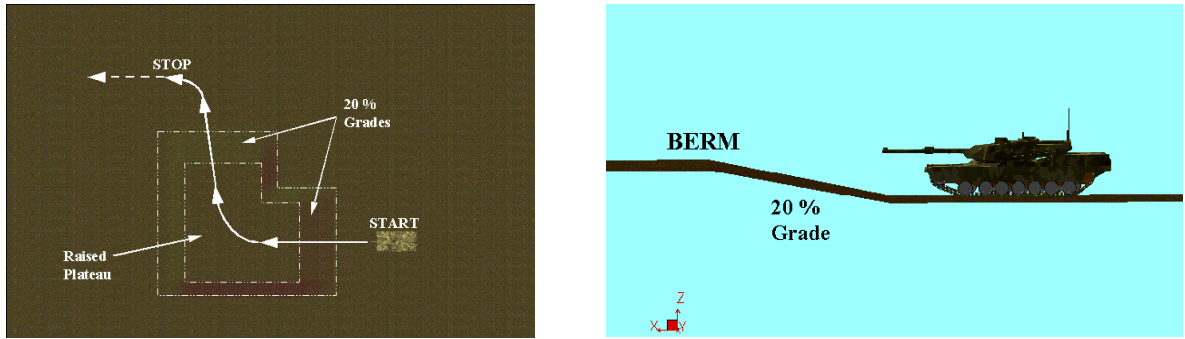
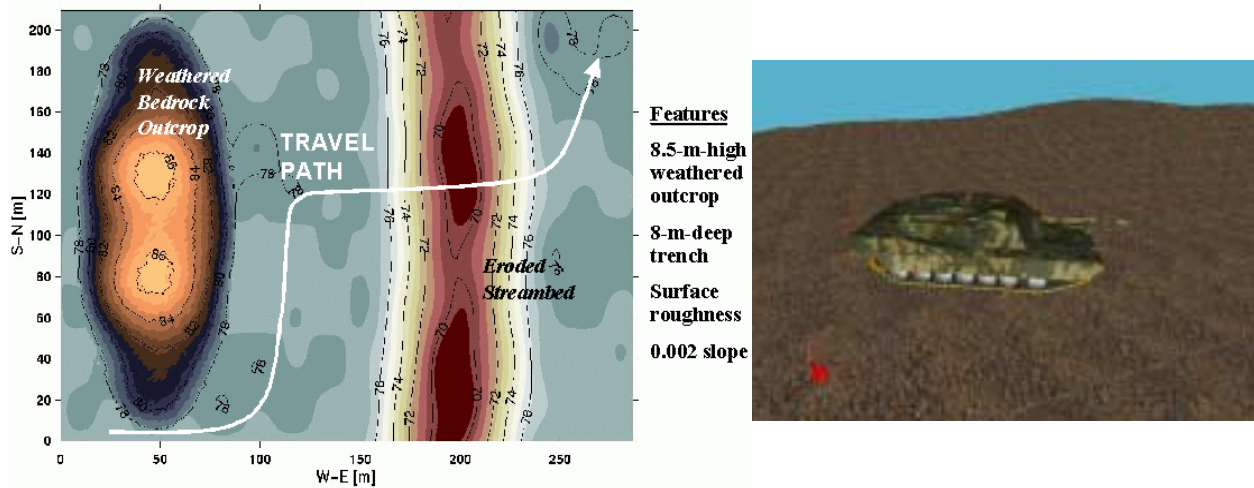

Figure 6. Layout and travel path of M1A1 simulation to troubleshoot speed/steer controller.

Another simulation involved moving an M1A1 over an imaginary 230 m x 280 m terrain grid with vertical relief and complex near-surface geologic features. This terrain is referred to as “TP1E.” Its topography is detailed in Reference 6. The TP1E simulation was done to demonstrate long duration FDTD seismic signatures. The seismic simulations used a homogeneous earth with material properties of density = 1900 kg/m³, $v_p = 1000$ m/s, $v_s = 577$ m/s, $Q_p = 40$, and $Q_s = 20$ with three mechanisms. The methods of Q attenuation are also given in Reference 6.

Figure 7 shows a plan view of the TP1E terrain. The travel path of the M1A1 vehicle is overlaid on it. Vehicle speed was varied during the simulation.



⁶ Ketcham, S.A., Greenfield R.J., Moran M.L., Anderson, T.A., Hestholm S., 2001, Soil attenuation in seismic simulations; implications for vehicle tracking, Proceedings of MSS Specialty Group on Acoustic, Seismic and Magnetic Sensing. Johns Hopkins University, MD. Oct. 2001.

Figure 7. M1A1 travel path on TP1E terrain grid. Image from simulation is shown on the right.

Several straight-ahead driving vehicle simulations were also accomplished: three with the M1A1 model and one with the T72 model (Figure 8). Each of the M1A1 simulations involved accelerating the vehicle to a constant speed (16, 32 and 48 kph) and then running over a 4 inch high bump to excite the vehicle suspension. A similar simulation was performed using the T72 model, with that vehicle being accelerated to 32 kph.

The results from the TP1E and straight-ahead driving simulations were post-processed to create vehicle track block ground force data files. These data were then used as input to the seismic propagation simulation.

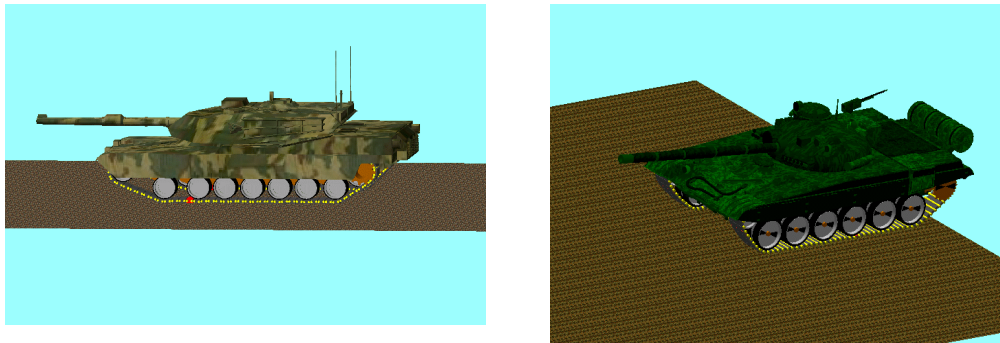

Figure 8. Straight-ahead driving simulations: M1A1 (left) and T72 (right).

4. Seismic Propagation Simulations

Seismic waves are propagated using the FDTD model described in Reference 3. Reference 7 discusses the FDTD algorithm used to describe a moving source. In this paper we discuss our implementation of mechanical system ground forces in the seismic simulations and give a few results illustrating the improvements and limitations of our current methods.

To propagate seismic waves through an FDTD grid an unbalanced force is applied at a single node or cluster of nodes⁷. For most geologic models the, FDTD grid nodes have a spacing on the order of 30 to 150 cm. In our MA1 and T72 tracked vehicle models we collect ground force time histories for each track block (Figure 5). In the case of the M1A1, the pin-to-pin track block spacing is roughly 19 cm (13 cm in the case of the T72). Given the generally much larger FDTD node spacing relative to the block size, we sequentially decimate the set of track blocks by an evenly divisible number of blocks such that no two track blocks have force time histories that overlap on the same node. The process is illustrated in Figure 9.

The decimation process avoids destructive overlay of multiple track block forces on the same FDTD node. However, as will be discussed later, it adds harmonic signal components that are directly

⁷ Ketcham, S.A., M.L. Moran, R.J. Greenfield, 2000, FDTD Seismic Simulation of Moving Tracked Vehicle, Military Sensing Symposium (formally IRIS), Battlefield Acoustic and Seismic Sensing, Johns Hopkins University, Columbia MD.

related to the decimation interval and are not real. Possible improvements to our current approach are the distribution of each track pad's force history over the nearest 3 FDTD nodes using a static equilibrium force balance approach. In principle, this would allow a finer representation of the net track block forces. An additional approach may be to “propagate” the track block forces to the nearest three nodes including near-field decay rates and delays calculated from the seismic body wave speeds in the ground. This would maintain appropriate relative alignments of force time history pulses and concatenation of multiple track block force histories on a single FDTD node.

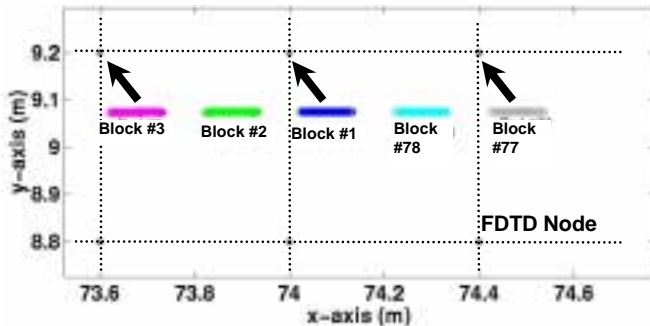

Figure 9. Assignment of M1A1 track block forces to FDTD nodes using a decimation interval of 2. Only track blocks numbered 1,3,5,...,77 are used.

4.1. Analyses of Results

In Figure 10, a simulated vertical seismic spectrum from the TP1E M1A1 mechanical model is compared with a the notional tracked vehicle spectrum reported in Reference 7. The vehicle speed profiles are given directly above the signal spectra. Both results demonstrate signal magnitudes that are in general agreement with field data⁸. The spectra also show the necessary harmonic variation in proportion to the vehicle speed. Qualitatively, the M1A1 spectrum is considerably more realistic and detailed than the notional vehicle data. It is clearly a step in the right direction. With the improved FDTD node forcing, we expect to be able to compare favorably with field data in the near future.

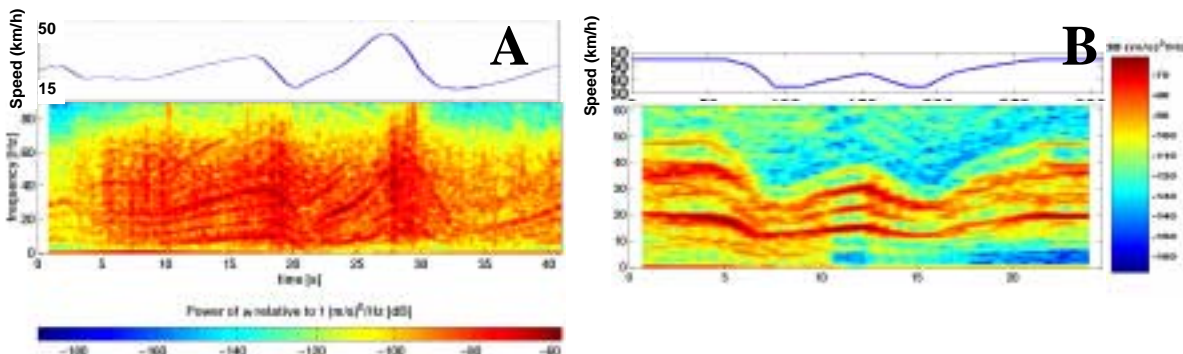

Figure 10. Simulated seismic signatures. A) M1A1 mechanical system model traversing the TP1E terrain. B) Notional vehicle simulation given in Reference 7. The M1A1 spectrum is considerably more realistic and complex than the spectrum for the notional vehicle.

⁸ Moran, M., Greenfield, R., Prado, G., Turpening, R., Peck, L., Kadtke, J., Carnes, B., Bass, H., Detsch, R., Hawley, B., and Ketcham, S., 1998b, Seismic Feasibility Study in Support of Hornet, Final report of PM-MCD Seismic Eagle Team, U.S. Army ARDEC, AMSTA-DSA-MCD, Picatinny Arsenal, NJ.

Figure 11 displays another particle velocity spectrogram that describes the ground excitation produced by every fifth track block on the T72 vehicle during the straight-ahead driving simulation discussed in the previous section. Spectral energy bands associated with movement of the road wheels from one track block to the next are clearly visible in this figure. Equation 1 defines the fundamental causal forcing frequency.

$$F_{tb} = \frac{V}{L_{tb}} \quad (1)$$

where: F_{tb} = track block forcing frequency

V = vehicle velocity

L_{tb} = spacing between adjacent track blocks

Equation 1 is plotted in Figure 11 using the DADS record for vehicle velocity, and the known distance between each track block. The first harmonic of this curve is also shown.

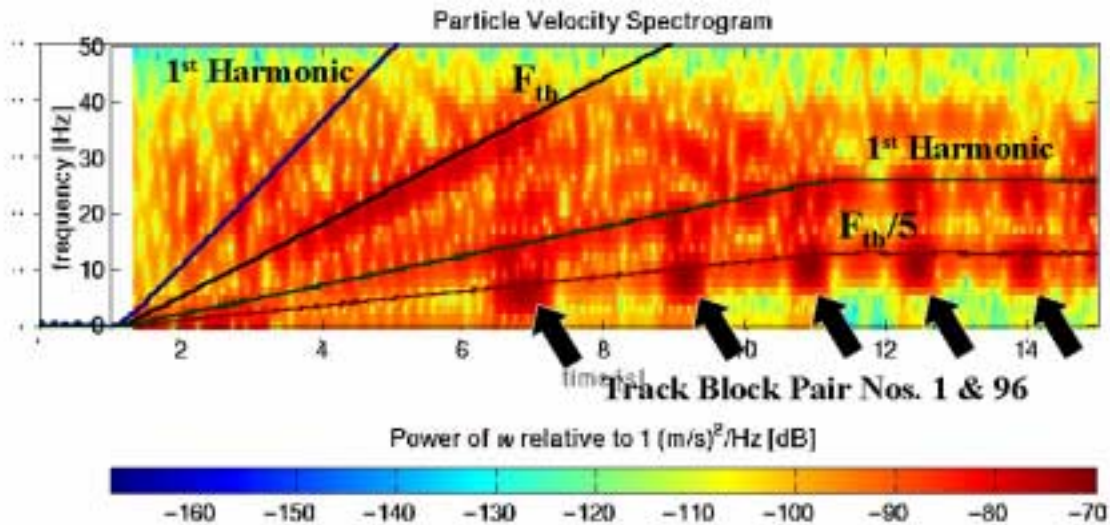

Figure 11. Simulated T72 seismic signature with specific spectral features highlighted.

Two features in Figure 11 are artifacts of the seismic simulation itself. An artificial harmonic component is associated with the choice of every fifth track block as a signal source in the simulation. Its frequency equals the track block forcing frequency (F_{tb}) divided by the selected track block “decimation value”, which in this case is 5 (i.e., every fifth track block). This F_{tb} related harmonic and its higher order harmonics are overlaid in Figure 11. The direct correlation of the F_{tb} frequency with prominent spectral harmonics seen in the seismic simulation indicate that the track block decimation is introducing high levels of unwanted energy. Additionally, the widely spaced large amplitude transients (highlighted by

arrows) are related to the decimation value. In this example, the decimation interval of 5 results in the FDTD nodes being forced with Track Block numbers 1,6,11,..., and 96, with Track Blocks 96 and 1 being directly connected. The passage interval of the contiguous Block 96 – Block 1 pair, correlates directly with the time spacing of the observed transients. Whenever these two track blocks simultaneously contact the ground, more energy is imparted to the simulation.

Low frequency seismic energy (between .1 and 5 Hz) could prove to be very important for classifying targets. Seismic energy in this frequency band readily propagates to long ranges with very little attenuation⁹ (10's to 100's of km). In moving vehicles, the low frequency seismic signal components result from cyclic vertical and pitch motions of the vehicle's sprung mass (hull and turret) in response to road-bumps or rapid changes in vehicle speed or direction. We have yet to demonstrate the presence of these signal features in our simulated data, nor have such features been observed in field data. The principle reasons are the long duration signals required to resolve several cycles of a low frequency process (e.g. 20 s of data may be needed to observe 0.1 Hz signal) and secondly, in field experiments, instruments sensitive to these low frequency components are expensive and (to our knowledge) have not been deployed during operational tests.

The spectra shown in Figures 10 and 11 do not resolve energy below 5 Hz because the data block-lengths used in the FFTs are only 0.5 s. However, we do observe causal body vibrations in our DADS simulations. Figure 12 shows sprung mass pitch data reduced from the straight-ahead 32 kph M1A1 and T72 DADS simulations. Noel Perkins, University of Michigan Mechanical Engineering Dept, has demonstrated similar whole-suspension resonant oscillations in these bands (personal communications and presentation materials, 2000).

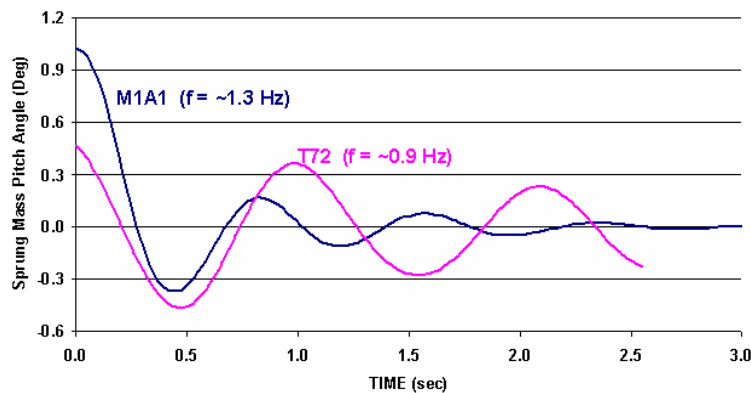

Figure 12. Sprung mass pitch angle oscillation decay for M1A1 and T72 at 32 kph.

5. Summary and Conclusions

Dynamic models of armored tracked vehicles are being developed that contain detailed representations of track and suspension elements. Vehicle simulations are being conducted to generate

⁹ Aki, K., Richards, P.G., 1980, Quantitative Seismology Theory and Methods, vol.1, W.H. Freeman Inc. N.Y., pp. 932

time histories of the absolute position and force vector (into the ground) of every track block. These data are serving as inputs to a recently developed 3-D seismic propagation model.

To date, models of the following vehicles have been created: M1A1 tank, T72 tank and BMP-2 armored personnel carrier. Preliminary vehicle simulations involving the M1A1 and T72 models have been conducted and ground force data have been extracted from the results. These data have been used as input to large-scale (230 m x 280 m) seismic propagation simulations to define ground vibrations at any fixed location. Ground particle spectrograms from these seismic simulations reveal strong harmonic associations with vehicle speed and track block spacing. Low frequency vibrations (< 5 Hz) of the vehicle sprung mass (hull and turret) are identified as important signature features for vehicle classification. Spurious artifacts from the seismic simulation methods and corrective action is being taken to eliminate their occurrence.

6. Acknowledgements

This work was supported by the US Army Office of the Program Manager for Mines, Countermines, and Demolitions in support of Hornet, Raptor, and Rattler-Track3 under MIPR1FPIC00544 and MIPR1APIC0051. Computations on massively parallel systems are supported under DoD's HPC Challenge Grant C-765. Additional funding was provided by the US Army Corps of Engineers, Engineering Research and Development Center, Cold Regions Research and Engineering Laboratory (ERDC-CRREL) under PE62784/AT42. Work at Pennsylvania State University was supported by contract DACA89-99-C-0001 with ERDC-CRREL.