

AFRL-ML-TY-TR-2003-4517



GA SCWO Development Summary Report

J.P Elliott, D.A. Hazlebeck, K.W. Downey
General Atomics
3550 General Atomics Court
San Diego, CA 92121

Approved for Public Release; Distribution Unlimited

**AIR FORCE RESEARCH LABORATORY
MATERIALS & MANUFACTURING DIRECTORATE
AIR EXPEDITIONARY FORCES TECHNOLOGIES DIVISION
139 BARNES DRIVE, STE 2
TYNDALL AFB FL 32403-5323**

20030303 042

NOTICES

USING GOVERNMENT DRAWINGS, SPECIFICATIONS, OR OTHER DATA INCLUDED IN THIS DOCUMENT FOR ANY PURPOSE OTHER THAN GOVERNMENT PROCUREMENT DOES NOT IN ANY WAY OBLIGATE THE US GOVERNMENT. THE FACT THAT THE GOVERNMENT FORMULATED OR SUPPLIED THE DRAWINGS, SPECIFICATIONS, OR OTHER DATA DOES NOT LICENSE THE HOLDER OR ANY OTHER PERSON OR CORPORATION; OR CONVEY ANY RIGHTS OR PERMISSION TO MANUFACTURE, USE, OR SELL ANY PATENTED INVENTION THAT MAY RELATE TO THEM.

THIS REPORT IS RELEASABLE TO THE NATIONAL TECHNICAL INFORMATION SERVICE
5285 PORT ROYAL RD.

SPRINGFIELD VA 22 161

TELEPHONE 703 487 4650; 703 4874639 (TDD for the hearing-impaired)

E-MAIL orders@ntis.fedworld.gov

WWW <http://www.ntis.gov/index.html>

AT NTIS, IT WILL BE AVAILABLE TO THE GENERAL PUBLIC, INCLUDING FOREIGN NATIONS.

THIS TECHNICAL REPORT HAS BEEN REVIEWED AND IS APPROVED FOR PUBLICATION.

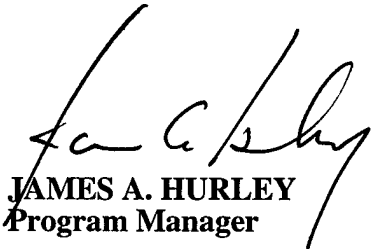

JAMES A. HURLEY
Program Manager



GLEN T. SHEN, Ph.D.
Chief, Weapons Systems Logistics Branch



DONALD R. HUCKLE, JR., Colonel, USAF
Chief, Airbase Technologies Division

Do not return copies of this report unless contractual obligations or notice on a specific document requires its return.

AQM03-05-0975

REPORT DOCUMENTATION PAGE

Form Approved
OMB No. 0704-0188

Public reporting burden for this collection of information is estimated to average 1 hour per response, including the time for reviewing instructions, searching existing data sources, gathering and maintaining the data needed, and completing and reviewing the collection of information. Send comments regarding this burden estimate or any other aspect of this collection of information, including suggestions for reducing this burden, to Washington Headquarters Services, Directorate for Information Operations and Reports, 1215 Jefferson Davis Highway, Suite 1204, Arlington, VA 22202-4302, and to the Office of Management and Budget, Paperwork Reduction Project (0704-0188), Washington, DC 20503.

1. AGENCY USE ONLY (Leave blank)	2. REPORT DATE 26 SEP 2002	3. REPORT TYPE AND DATES COVERED FINAL REPORT 28 Aug 92 - 30 Dec 02
----------------------------------	-------------------------------	--

4. TITLE AND SUBTITLE GA SCWO Development Summary Report	5. FUNDING NUMBERS JON: 2103S504 PE:
6. AUTHORS J.P. ELLIOTT, D.A. HAZLEBECK, K.W. DOWNEY	

7. PERFORMING ORGANIZATION NAME(S) AND ADDRESS(ES) GENERAL ATOMICS PO BOX 85608 SAN DIEGO, CA 92186-5608	8. PERFORMING ORGANIZATION REPORT NUMBER AFRL ML-TY-TR-2003- 4517
---	--

9. SPONSORING/MONITORING AGENCY NAME(S) AND ADDRESS(ES) AIR FORCE RESEARCH LAB/MLQL 136 BARNES DRIVE, SUITE 2 TYNDALL AFB, FL 32403	10. SPONSORING/MONITORING AGENCY REPORT NUMBER N/A
--	---

11. SUPPLEMENTARY NOTES

12a. DISTRIBUTION/AVAILABILITY STATEMENT Distribution Unlimited; Approved for Public Release	12b. DISTRIBUTION CODE A
---	-----------------------------

13. ABSTRACT (Maximum 200 words)

THIS SUMMARY REPORT COVERS THE DEVELOPMENT OF SUPERCRITICAL WATER BY GENERAL ATOMICS OVER THE LAST 10 YEARS. IT DOES NOT COVER WORK DONE BY OTHERS AND IS LIMITED TO THE WORK PERFORMED UNDER CONTRACT WITH THE US AIR FORCE.

14. SUBJECT TERMS SUPERCRITICAL WATER OXIDATION, HAZARDOUS MATERIALS DISPOSAL	15. NUMBER OF PAGES 54
	16. PRICE CODE

17. SECURITY CLASSIFICATION OF REPORT UNCLASSIFIED	18. SECURITY CLASSIFICATION OF THIS PAGE UNCLASSIFIED	19. SECURITY CLASSIFICATION OF ABSTRACT UNCLASSIFIED	20. LIMITATION OF ABSTRACT UL
---	--	---	----------------------------------

NSN 7540-01-280-5500

Computer Generated

STANDARD FORM 298 (Rev 2-89)
Prescribed by ANSI Std 239-18
298-102

LIST OF ACRONYMS

ACWA	Assembled Chemical Weapons Assessment
AF	Air Force
BAA	Broad Agency Announcement
CDHX	cooldown heat exchanger
DARPA	Defense Advanced Research Projects Agency
DNT	dinitrotoluene
DOD	Department of Defense
DPT	differential pressure transmitter
DRE	destruction and removal efficiency
EST	Engineering Scale Test
E-stop	emergency stop
GA	General Atomics
GB	nerve agent GB
GLS	gas-liquid separation
HD	distilled mustard
HRHX	feed inlet regenerative heat exchanger
HTO	hydrothermal oxidation
ID	inner diameter
I/O	input/output
JDT	Joint Development Testing
L/D	length to diameter
LOX	liquid oxygen
NECDF	Newport Chemical Agent Disposal Facility
NPSH	net positive suction head
NOX	nitrous oxide
OD	outer diameter
PID	proportional integral derivative (controller)
PLC	programmable logic controller
PMACWA	Program Manager for Assembled Chemical Weapons Assessment
PMATA	Program Manager for Alternative Technologies and Approaches
R ³	recycle, reuse, and recovery
ROK	Republic of Korea
SCW	supercritical water
SCWG	supercritical water gasification
SCWO	supercritical water oxidation
SRMD	Solid Rocket Motor Disposal
TNT	trinitrotoluene
VFD	variable frequency drive
VX	nerve agent

TABLE OF CONTENTS

LIST OF ACRONYMS.....	iii
1. SUMMARY AND INTRODUCTION	1
2. TEST PROGRAM SUMMARIES.....	3
2.1 SRMD.....	9
2.1.1 AF Lab-Scale Test Unit	9
2.1.2 AF Pilot Plant	9
2.2 BAA Project.....	10
2.2.1 HTO Development Testing	10
2.2.2 JDT Demonstration Unit Testing	11
2.2.3 EST System Testing.....	12
2.2.4 ACWA System Testing.....	13
2.3 ROK SCWO Project.....	14
3. PROCESS DEVELOPMENT.....	16
3.1 Feed Preparation	16
3.1.1 Feed Preparation Objective.....	16
3.1.2 Feed Preparation Evolution	17
3.1.3 Feed Preparation Future	18
3.2 Pumping.....	19
3.2.1 Pumping Objective.....	19
3.2.2 Pumping Evolution	19
3.2.3 Pumping Future	23
3.3 Preheat.....	23
3.3.1 Preheat Objective	23
3.3.2 Preheat Evolution	23
3.3.3 Preheat Future	24
3.4 Heat Exchanger	24
3.4.1 Heat Exchanger Objective	24
3.4.2 Heat Exchanger Evolution	25
3.4.3 Heat Exchanger Future	25
3.5 Reactor Design.....	25
3.5.1 Reactor Design Objective.....	30
3.5.2 Reactor Design Evolution	31
3.5.3 Reactor Design Future	32
3.6 Corrosion and Salt Handling	32
3.6.1 Corrosion and Salt Handling Objective	32
3.6.2 Corrosion and Salt Handling Evolution	32
3.6.3 Corrosion and Salt Handling Future	33
3.7 Gas-Liquid Separation	33
3.7.1 Gas-Liquid Separation Objective.....	33
3.7.2 Gas-Liquid Separation Evolution	33
3.7.3 Gas-Liquid Separation Future	34
3.8 Pressure Letdown.....	34

3.8.1	Pressure Letdown Objective.....	34
3.8.2	Pressure Letdown Evolution.....	35
3.8.3	Pressure Letdown Future	36
3.9	Solids Separation	36
3.9.1	Solids Separation Objective	36
3.9.2	Solids Separation Evolution.....	36
3.9.3	Solids Separation Future	37
3.10	Controls.....	37
3.10.1	Control Objective.....	37
3.10.2	Controls Evolution	38
3.10.3	Controls Future.....	39
4.	FUTURE MILITARY AND INDUSTRIAL APPLICATIONS	41
5.	REFERENCES.....	42
APPENDIX A – SUPERCRITICAL WATER OXIDATION FOR THE NEWPORT CHEMICAL AGENT DISPOSAL FACILITY – A STATUS REPORT.....		A-1

LIST OF TABLES

Table 2-1	HTO Systems and Waste Materials Treated Under SRMD and BAA Projects	4
Table 2-2	Major Developments in HTO Systems	7
Table 3-1	Common Fluids Used in SCWO Applications	20
Table 3-2	Summary of Slurry Fluid Handling Challenges	21
Table 3-3	Pipe Reactor Advantages and Disadvantages.....	27
Table 3-4	Reversing Flow Vessel Reactor Advantages and Disadvantages	28
Table 3-5	Downflow Vessel Reactor Advantages and Disadvantages	29
Table 3-6	Tube-in-Tube Reversing Flow Reactor Advantages and Disadvantages	29

LIST OF FIGURES

2-1	Timeline for major test programs	3
2-2	Air Force pilot plant (Thiokol, UT).....	10
2-3	HTO development plant (GA, CA)	11
2-4	JDT demonstration unit (GA, CA).....	12
2-5	EST system (Corpus Christi, TX).....	13
2-6	ACWA system (Dugway, UT).....	14
2-7	ROK SCWO system (McAlester, OK)	15
3-1	HTO process block flow diagram	17
3-2	Four types of reactors	26
3-3	Alarms and interlocks screen.....	39

1. SUMMARY AND INTRODUCTION

For the past 8 years the Air Force Research Laboratory at Tyndall Air Force Base has contracted hydrothermal oxidation projects with General Atomics. These projects were initially focused on large rocket motor disposal, then more generally on energetics, DOD wastes, and most recently on resource recovery.

Each project has documentation tailored to the specific project requirements and objectives; however, none of the documentation fully conveyed the technology evolution which occurred or communicated the rationale for that evolution. That is the purpose of this report.

In it we describe briefly the results of the projects (Section 2) and the way in which the elements of each major component or subsystem evolved (Section 3) – including the false steps taken along the way. Section 4 then presents our summary of where we believe the technology stands today and how it might best contribute to future DOD requirements.

It should be emphasized that this is not a full state-of-the-art report or assessment because it does not address any work performed by others. It would have been impossible for us to have included the logic paths of other companies in Section 3, the main section of the report. In that vein, it should be noted that other companies have adopted other approaches for certain subsystems and have reported success.

Rather, the scope of this report is limited to: (a) the projects funded by the Air Force at GA; (b) two Army funded projects that the Air Force established cooperative agreements for and; (c) certain privately funded work performed by GA that was judged very relevant to the above work.

This report specifically addresses the work performed during the Solid Rocket Motor Disposal (SRMD) and Air Force (AF) Broad Agency Announcement (BAA) projects (contracts F08635-92-C-0075 and F08637-97-C-6023, respectively). Included in this presentation is additional related data from the Republic of Korea (ROK) SCWO demilitarization waste treatment system (contract F08637-98-C-6002 from the Air Force, Tyndall AFB, FL), the Program Manager for Assembled Chemical Weapons Assessment (PMACWA) demonstrations and the Program Manager for Alternative Technologies and Approaches (PMATA) demonstrations (contracts DAAM01-98-D-0003 and Parsons subcontract 735361-30002, respectively), as well as efforts funded by General Atomics (GA).

A summary of these projects is as follows:

- Pilot-scale operation with propellants, other DOD wastes, and surrogates – 330 hours
- Demonstration tests with the JDT Demonstration Unit – 800 hours
- Operation with chemical-agent hydrolysate, propellants, dunnage, and surrogates by ACWA using pilot-scale equipment developed under these contracts – 6,200 hours

- Operation with chemical-agent hydrolysate and surrogates by the PMATA using pilot-scale equipment owned and partially developed under these contracts – 1260 hours
- Gasification of propellants and other DOD wastes – 130 hours to date
- Pink water destruction in the ROK SCWO system – 150 hours to date

The work led to significant progress in a number of aspects of the HTO process:

- Pumping of extremely thick sludge
- Compact preheater without the need for natural gas or large electric service
- Cold-feed injection and well-defined operational stability envelope
- Reactors that achieve high destruction with as little as one-tenth of the volume of prior reactor systems
- Low-cost, cold-wall reactors
- Transport of a wide variety of salts through the systems
- Fully automatic, single-button process control
- Corrosion-resistant lined tubing, heat exchangers, and reactors
- Corrosion-resistant replaceable reactor liners
- Corrosion-resistant plasma spray coatings
- Corrosion-resistant materials for acid and salt environments

The following sections provide additional detail.

2. TEST PROGRAM SUMMARIES

A total of ~12,000 hours of testing has been conducted on HTO systems ranging from initial testing on a small lab-scale test unit that had a flow rate of 0.1 liter per minute to the JDT demonstration unit that has a flow rate of 8 liters per minute. Figure 2-1 presents the timeline for the major test programs.

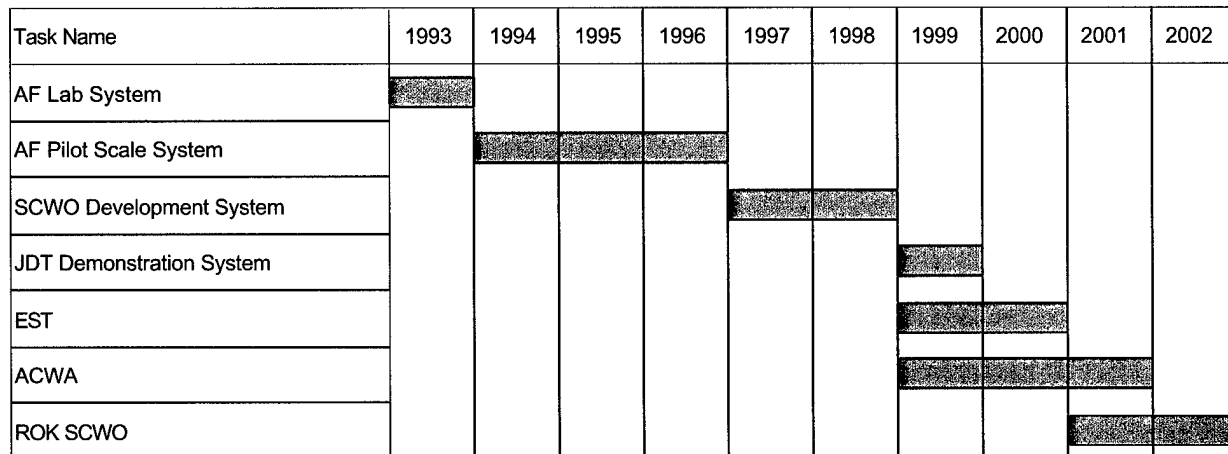

Fig. 2-1. Timeline for major test programs

Table 2-1 presents a list of the waste materials treated in HTO systems that were used or supported under the SRMD and BAA projects. These programs have significantly extended the list of materials treated by HTO at GA. Table 2-2 lists developments that resulted from the various program tests.

**Table 2-1
HTO Systems and Waste Materials Treated Under SRMD and BAA Projects**

HTO System/ Location/ Date of Operation	Testing Hours	Materials Treated
AF lab-scale test unit/ GA, Bldg 35/ 1993	250	Class 1.1 propellant hydrolysate Ammonium perchlorate Unsymmetrical dimethyl hydrazine
AF pilot plant/ Thiokol, Utah/ 1995-1996	330	Class 1.1 propellant hydrolysate Ammonium perchlorate Aluminum
HTO development/ GA, Bldg 36/ 1997-1998	270	Liquids Acetic acid Cresol Ethanol Kerosene Methyl acetate T-butyl alcohol Xylene Salts/acids Ammonium picrate H_3PO_4 , Na_2HPO_4 , NaH_2PO_4 , Na_3PO_4 KCl K_2SO_4 $MgSO_4 \cdot (7H_2O)$ NaCl Na_2CO_3 , $NaHCO_3$ NaF Na_2SO_4 , Na_2SO_3 $(NH_4)_2HPO_4$ Other Plastic beads (blasting media) Sawdust

Table 2-1 (Cont'd)
HTO Systems and Waste Materials Treated Under SRMD and BAA Projects

HTO System/ Location/ Date of Operation	Testing Hours	Materials Treated
JDT Demonstration Unit/ GA, Bldg 37/ 1997-1999	800	Pure liquids Antifreeze Brake fluid Ethanol Hydraulic fluid Kerosene Molybdenum disulfide oil Motor oil Polytrifluorochloroethylene Trichloroethane Trifluoro acetic acid Mixed liquids Black water Gray water Municipal sludge Paint, paint sludge Mixed solvent waste Photographic solution: (NH ₄) ₂ SO ₃ K ₂ SO ₃ Na ₂ SO ₃ Acetic acid Pentanol
EST MOC/ Dugway Proving Grounds, Utah/ 1999	600	VX hydrolysate VX hydrolysate surrogate Dimethyl methyl phosphonate Sodium isethionate Sodium hydroxide Isopropanol DI water
EST System/ GNI, Texas/ 2000-2001	660	VX hydrolysate VX hydrolysate surrogate Dimethyl methyl phosphonate Sodium isethionate Sodium hydroxide Isopropanol DI water (Na ₂ SO ₄ , NaH ₂ PO ₄)

Table 2-1 (Cont'd)
HTO Systems and Waste Materials Treated Under SRMD and BAA Projects

HTO System/ Location/ Date of Operation	Testing Hours	Materials Treated
ACWA/ Dugway Proving Grounds, Utah/ 1999-2001	5800	Explosive hydrolysate M28 rocket propellant hydrolysate Cyclotol explosive hydrolysate Tetrytol explosive hydrolysate GB hydrolysate GB hydrolysate simulant Dimethyl methyl phosphonate NaF Tributylamine IPA NaOH HD hydrolysate HD hydrolysate simulant Thiodiglycol NaCl NaOH VX hydrolysate simulant Dimethyl methyl phosphonate Sodium isoethionate Sodium hydroxide Isopropanol DI water Other Activated carbon Size-reduced wood Size-reduced plastics Size-reduced rubber
ROK SCWO/ McAlester, OK 2001-2002	70	Pink Water TNT RDX DNT

**Table 2-2
Major Developments in HTO Systems**

Technology Area	AF Lab-scale	AF Pilot Plant	SCWO Development	JDT Demo	EST System	ACWA System
Feed Preparation		Hydrolysis of propellant; cryowashout of propellant		In-line grinder		Grinding of wood and plastics; rotary hydrolyzer
Pumping	Hydrogen peroxide	Moderate solids loading slurry		High solids loading slurries		Dual syringe pump
Preheat	Resistance heaters	Lined preheater		Igniter		
Corrosion		High-temp, high-pressure lined tubing, reactor, and heat exchangers	Lined tubing repair	Electroless-plated coatings; neutralize reactor effluent; thermocouple protection tubes	Magneform liner; platinum to C276 bimetallic welds; confirmation of platinum corrosion rates	Plasma spray coatings; spot weld liner; sacrificial liner
Solids and Salts Handling		Downflow reactor	Additives for salt transport	Mechanical salt transport; quenched reactor effluent		Additional additives for salt transport; modified quench introduction
Controls		Programmable logic controller (PLC) temperature and pressure control		Fully automated, single-button operation	Improved PLC pressure control	
Reactor		Cold-feed injection; fixed and floating liners; downflow reactor	Nozzle design; stability and scaling; low pressure	Lined reactor with a side exit and entrance	Easily replaceable liner; low-temperature reactor wall capability; confirmation of scale-up methodology	Easily replaceable liner; low-temperature reactor wall capability

Table 2-2 (Cont'd)

Technology Area	AF Lab-scale	AF Pilot Plant	SCWO Development	JDT Demo	EST System	ACWA System
Heat Exchanger		Lined heat exchanger		Coiled heat exchanger; Quenched effluent		
Solids Filtration	Dual filter prior to letdown			Hot-solids filter; heavy metals removal system	Hydroclone	
Pressure Letdown	Two-phase through control valve	Two-phase through capillary tubes	Capillary and valve combination	Separate gas and liquid letdown; hot letdown		
Oxidant	H ₂ O ₂	Liquid oxygen (LOX)	Air	Air	Air and LOX	Air and LOX
Safety	Hardwired interlocks on pressure and temperature			Safety shield, software 3-level safe shutdown protection system		
Reactor Materials	C-276			I-625 and I-617		
System Reliability/Availability				High reliability demonstrated for core HTO technology over multiple 30-hr tests		Demonstration of high (~80%) overall SCWO system availability over 2700 hr test period

2.1 SRMD

The SRMD program was focused on the removal and the destruction of solid rocket motor propellant. Propellant hydrolysis and HTO technology were advanced from lab-scale to full-scale for this application. A number of advancements were made during this development, including the first downflow reactor with a corrosion-resistant liner and the first demonstration of cold-feed injection. Additional accomplishments are noted below. Test results are documented in Refs. 1, 2, and 3.

2.1.1 AF Lab-Scale Test Unit

The purpose of the test program with the lab-scale unit was to determine the residence time and temperature required for high-efficiency destruction of propellant and to identify and gather data on operational challenges such as pressure letdown, solids handling, plugging, and pumping. Major accomplishments included:

- Destruction of class 1.1 energetic hydrolysate
- Pumping hydrogen peroxide
- Demonstration of two-phase pressure letdown with dual filters upstream of the control valve
- Identification of sodium aluminates plugging problem

2.1.2 AF Pilot Plant

The purpose of the test program was to demonstrate hydrolysis and SCWO of Hazard Class 1.1 propellant. The system shown in Fig. 2-2 was installed at a propellant manufacturing and disposal subcontractor's site in Utah. The system was operated from 1994 to 1996. Major accomplishments included:

- Hydrolysis and destruction of class 1.1 propellant
- Development and demonstration of a downflow reactor
- Development and demonstration of lined high-temperature, high-pressure piping with instrument ports
- Development and demonstration of lined high-temperature, high-pressure heat exchangers
- Development and demonstration of capillary pressure letdown for control of high-solids, three-phase effluent
- Development and demonstration of reactor cold-feed injection
- Demonstration of pumping a moderately loaded solids slurry
- Obtained an RD&D permit for HTO operation in record time from the State of Utah
- Operation with LOX as oxidant



Fig. 2-2. Air Force pilot plant (Thiokol, UT)

2.2 BAA PROJECT

The proof-of-concept work conducted under the SRMD project provided the foundation for the BAA contract. Under the BAA contract, most difficult technical challenges were overcome, including corrosion and salts handling. The BAA contract supported two test programs, HTO development and the JDT demonstration, followed by lending of the equipment acquired under the BAA contract for completion of two additional test programs, the PMATA Engineering Scale Test (EST) and the ACWA Engineering Design Study tests.

HTO development testing was performed in 1997 and 1998. The JDT demonstration testing was performed in 1999. The EST utilized the HTO development pilot plant for destruction of VX hydrolysate in 2001. The ACWA testing utilized the AF pilot plant for destruction of VX, GB, and HD hydrolysates and surrogates, and energetics hydrolysates and dunnage from 1999 through 2001. There were a number of technological advances in these programs:

- Fully automated HTO operation
- Cold-wall reactors
- Dual-syringe feed pump
- Reliable salt handling
- Greatly improved corrosion-resistance techniques

Additional advancements are noted below in the sections for each test program.

2.2.1 HTO Development Testing

One of the major test programs performed under the BAA contract was the HTO Development Test. The testing was done in 1997 and 1998 using the Defense Advanced Research Projects Agency (DARPA) SCWO pilot plant installed at GA. This system is shown in

Fig. 2-3. This work focused on advancing the cold-feed injection downflow reactor technology that had been demonstrated under the SRMD project. Limited data had been collected that demonstrated feasibility, but there were large information gaps such as nozzle size and type, operational stability regime, waste type dependence, and scale-up methodology.

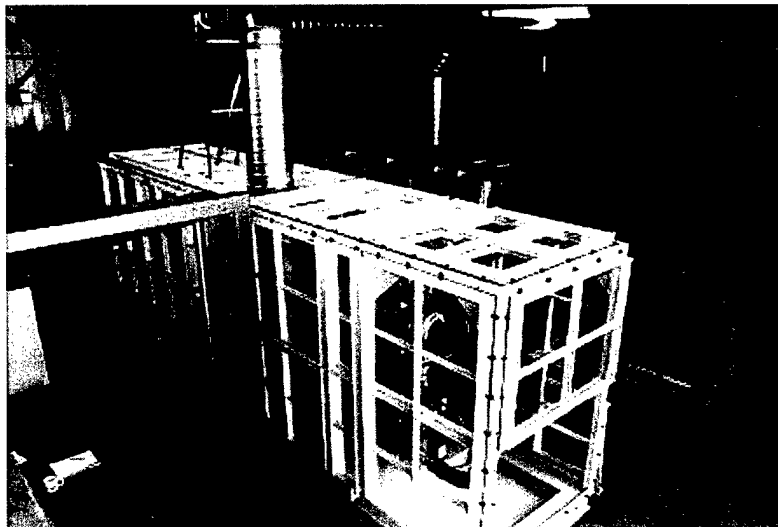

Fig. 2-3. HTO development plant (GA, San Diego, CA)

In addition, the previous SRMD work had focused on acid-producing feeds. The HTO development testing extended the downflow reactor to treatment of salt-producing feeds. Major accomplishments included:

- Scaling and stability methodology for cold-feed injection downflow reactors with a wide variety of feeds was developed
- Design and scaling for cold-feed injection nozzles was defined
- Additives that enabled transport of all sodium salts were discovered
- Baseline data on salt plugging for a wide variety of salts were collected

2.2.2 JDT Demonstration Unit Testing

The BAA acquired the DARPA Navy Demonstration Unit installed at GA. The system shown in Fig. 2-4 was used to demonstrate destruction of a wide range of military wastes. All wastes were destroyed with very high destruction efficiency. The test results are documented in Ref. 4. Major accomplishments included:

- Single-button control (full automation from start-up through shutdown)
- Compact, fast response igniter preheater
- Hot solids filter with hot pressure letdown
- Heavy metals removal system
- Gas-liquid separator to reduce letdown system erosion

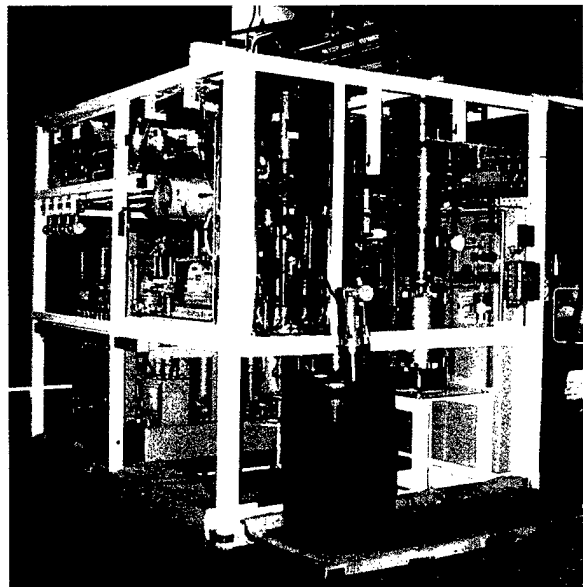

Reactor End

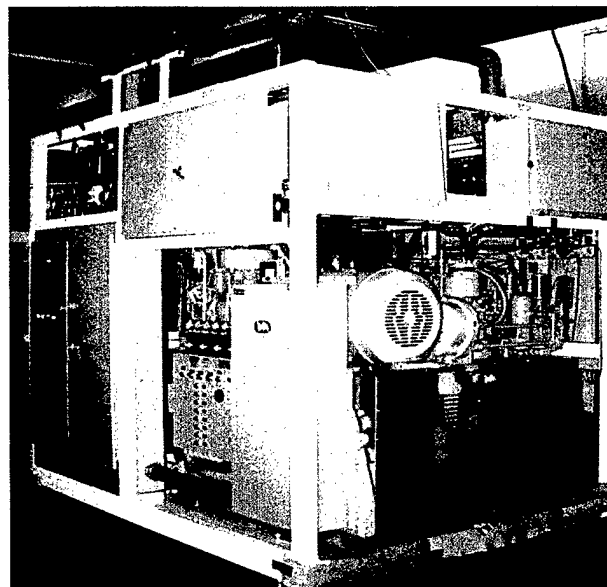

Compressor End

Fig. 2-4. JDT demonstration unit (GA, San Diego, CA)

2.2.3 EST System Testing

The SCWO development pilot plant was loaned to the Army to conduct the EST on VX-hydrolysate. The 1/10th-scale EST was to provide data in support of the full-scale SCWO system design for NECDF. The equipment was installed at the GNI site in Corpus Christi, Texas, as shown in Fig. 2-5. The reactor incorporated an easily removable platinum liner assembly with an air purge provided in the annulus between the removable liner and the pressure-bearing wall. In addition to rapid change-out of the reactor liner, the removable liner assembly facilitates the use of lower-temperature reactor vessels for reduced cost. Destruction efficiency, salts transport, pressure letdown, and corrosion resistance were demonstrated for VX-hydrolysate. The test results are documented in Refs. 5 and 6, and the major accomplishments include:

- Development and demonstration of removable liners
- Demonstration of corrosion resistance with a platinum liner
- Demonstration of effective salts transport at high salt loadings with a platinum liner
- Confirmation of reactor scale-up methodology

In several areas of the EST program, the results fell short of expectations. These areas included partial buckling of the platinum liner and generally low system availability. Since the conclusion of the EST in early 2001, significant SCWO testing and development have been performed in support of the Army programs to resolve the deficiencies observed during the EST. These issues are discussed further in Appendix A.

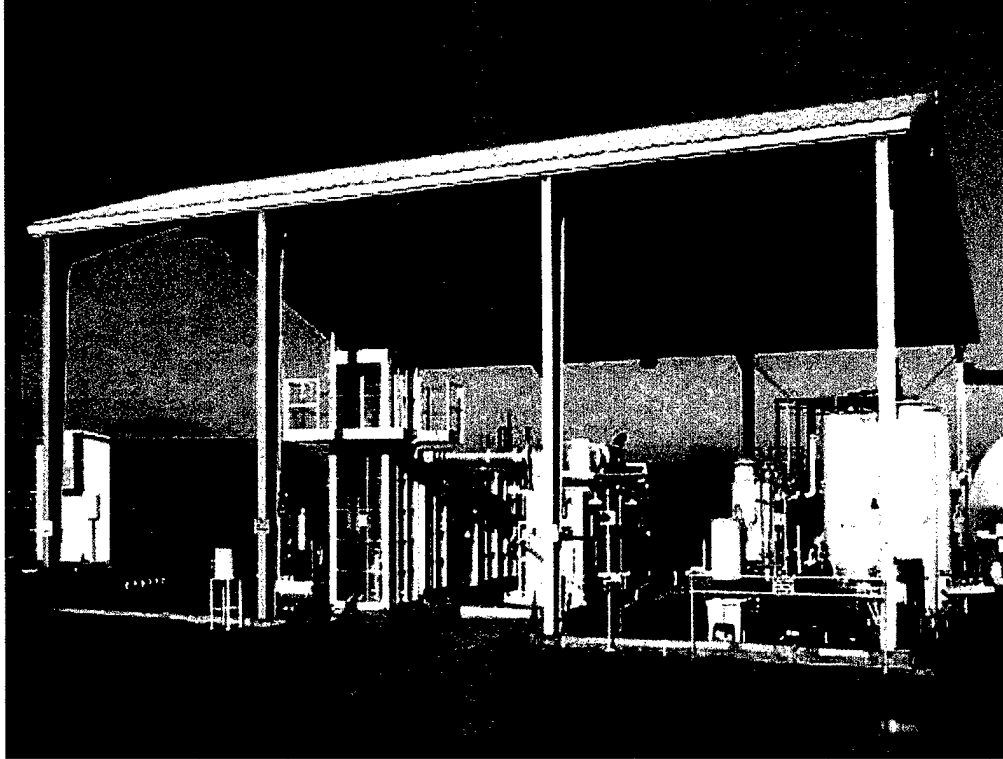

Fig. 2-5. EST system (Corpus Christi, TX)

2.2.4 ACWA System Testing

The BAA loaned the propellant pilot plant to the Army for testing with chemical agent hydrolysates, energetics hydrolysates, and size-reduced dunnage (wood, plastic, and rubber). The system was installed at the Dugway, UT, test site (see Fig. 2-6). The reactor was modified to incorporate an easily removable liner. Long-term testing was conducted on each of five separate feeds to generate a large availability database. Formal 500-hour tests were performed for HD hydrolysate and hydrolysate surrogate, GB hydrolysate and GB hydrolysate surrogate, tetrytol hydrolysate/dunnage, and M28 propellant hydrolysate/dunnage. Separate 500-hour and 200-hour tests were performed for VX hydrolysate surrogate. The total test time for the program was in excess of 6,200 hours. Test results are documented in the ACWA Engineering Studies Final Test Report, GA-C23966. The major accomplishments included:

- Demonstration of high SCWO system availability
- Demonstration of sacrificial liners for corrosion resistance
- Demonstration of additives to improve salts transport for a variety of salt matrices
- Long-term operation of a dual syringe pump with very thick slurries
- Pre-feed grinding and size reduction for wood, plastics, and other dunnage
- Development of a rotary hydrolyzer for energetics hydrolysis

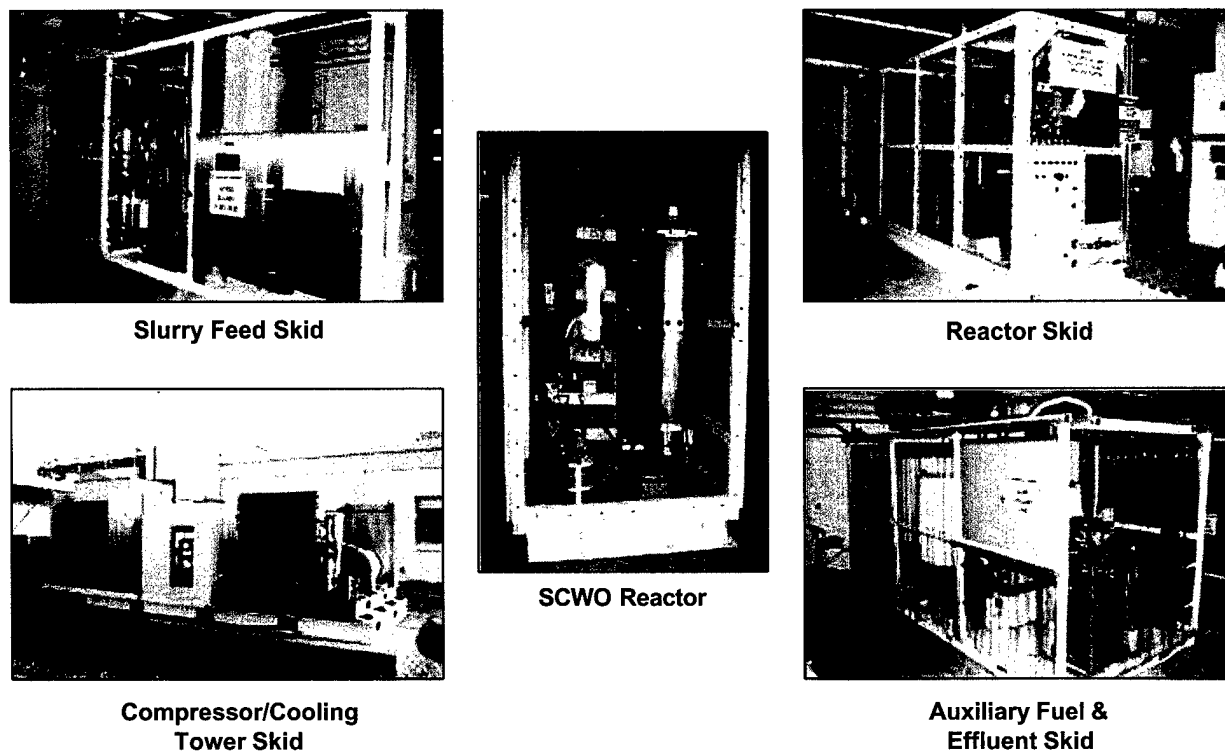

Fig. 2-6. ACWA system (Dugway, UT)

The extensive ACWA test data established a firm basis for a SCWO system availability of ~80%. This high availability resolved one of the major deficiencies observed during the EST (see Section 2.2.3). The results of the ACWA testing, relative to application to the NECDF, are discussed in Appendix A.

2.3 ROK SCWO PROJECT

A SCWO system to destroy "pink water" in the Republic of Korea (ROK) was designed and built under Subcontract S-4470.6 from Applied Research Associates, Inc. (ARA) under prime contract F08637-98-C-6002 from the Air Force (Tyndall AFB, FL). The system is designed to destroy pink water containing TNT up to the solubility of TNT in water at ambient conditions. The system can also process RDX and HMX in like concentrations. Pink water is generated by operations associated with demilitarization of conventional munitions containing TNT and Composition B that contains TNT, RDX, and HMX. The ROK SCWO system is designed to oxidize the organic materials in the pink water with air and water at temperatures in the range of 635 to 650°C and pressures of 2500 to 3400 psig. The organic materials in the pink water are oxidized to produce water, carbon dioxide, N_2O and nitrogen, which are directly releasable to the environment without further treatment. This system is shown in Fig. 2-7.

The liquid effluent from the SCWO system will be used as boiler feed water for demil operations. Demonstration tests have shown that the liquid effluent meets all requirements for

boiler feed water. The control system is fully automated, and Government personnel at McAlester currently operate the system.

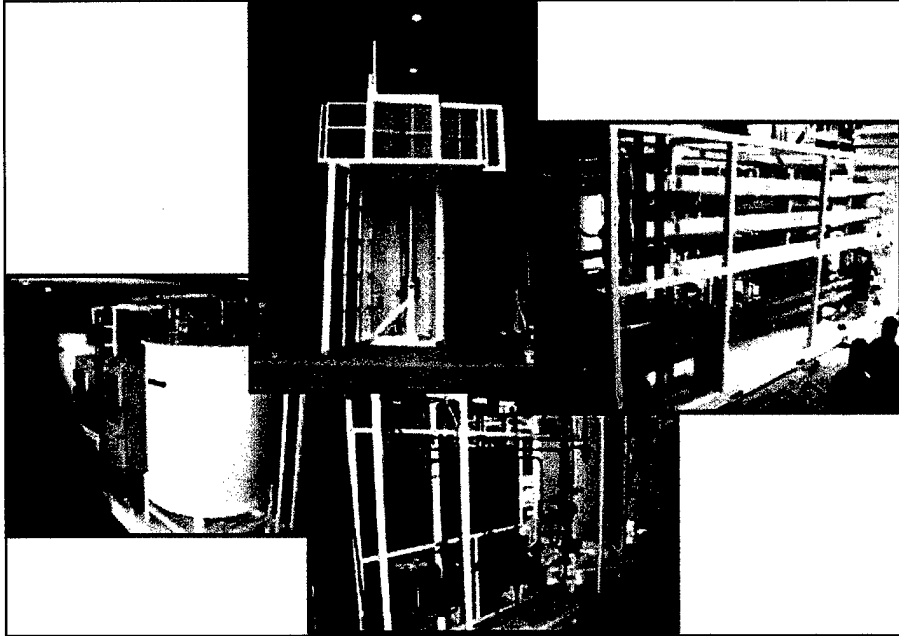

Fig. 2-7. ROK SCWO system (McAlester, OK)

3. PROCESS DEVELOPMENT

Typical HTO systems oxidize wastes in an aqueous environment at a temperature range of 600 to 700°C and a pressure range of 3200 to 4000 psig. Figure 3-1 presents a process flow diagram for a typical HTO process. If necessary, the feed is preprocessed to prepare it for pressurization. It is then pressurized and fed to a heat exchanger or directly to the reactor. In the reactor, the waste is combined with an oxidant and completely oxidized to carbon dioxide, water, nitrogen, nitrous oxide, salts and metal oxides. Preheat, dilution water, and/or fuel addition are varied to control the reactor temperature. Once the reaction is complete, the reactor effluent may be quenched with a cooler aqueous stream to help prevent fouling and corrosion downstream of the reactor. The reactor effluent is cooled in a heat exchanger and then depressurized. The letdown rate is adjusted to control the reactor pressure. Gas-liquid separation and solids separation can be performed at high or low pressure and high or low temperature. The unique operating environment of the SCWO system leads to a number of advantages over other destruction technologies:

- The gas-like diffusion, viscosity, and surface tension combined with liquid-like density allow a compact system with high-destruction efficiency.
- The aqueous environment naturally scrubs out acid-gases and particulates.
- The lower operating temperature precludes the formation of nitric acid gases.
- The lower operating temperature also avoids the formation of hazardous compounds generated in other processes during the cooldown from higher temperatures, e.g. dioxins.
- The aqueous high-pressure environment favors hydrolysis, which tends to inhibit formation of hazardous condensation products
- The moderate residence times result in increased process stability relative to short residence time processes such as incineration and plasma pyrolysis

The following sections provide a discussion of the development of various process steps as well as process improvements in controls, salts plugging, corrosion, and solids handling developed during the projects noted in Section 2 above.

3.1 FEED PREPARATION

3.1.1 Feed Preparation Objective

An important aspect of feed preparation is creating appropriate feed mixing procedures. Feed-mixing procedures are created by researching the mixture components. For example, if a

specific slurry solid content is desired, the moisture content of the raw feed material must be known.

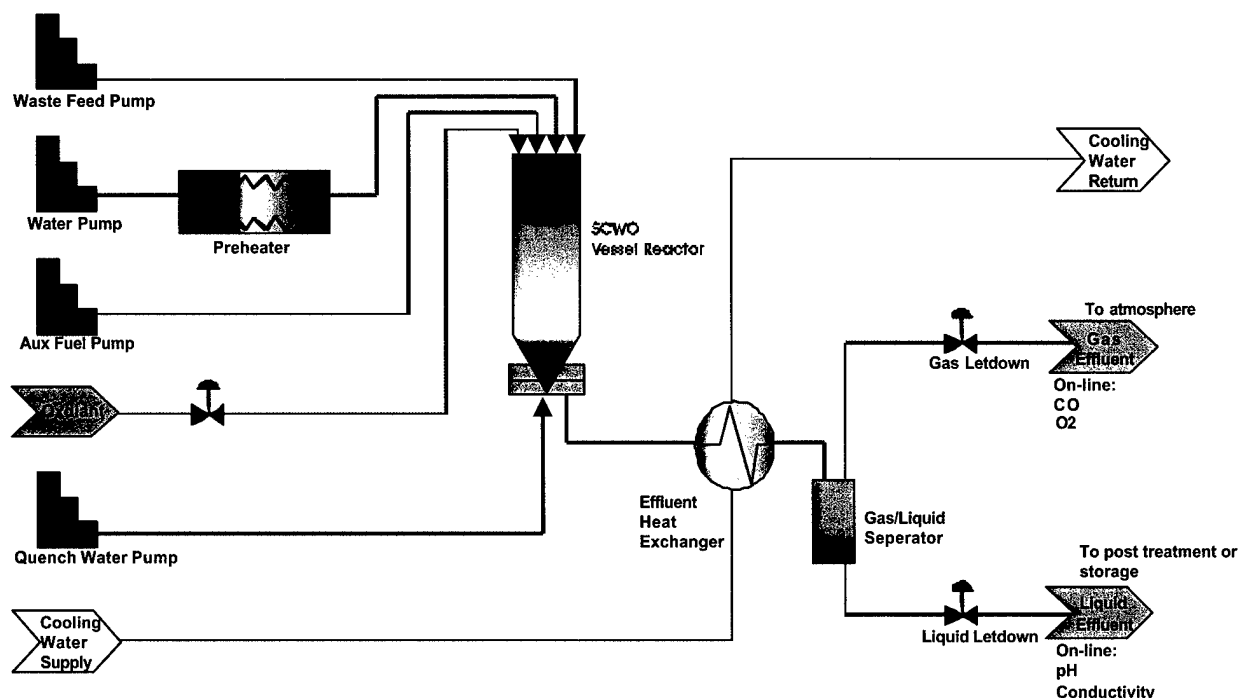

Fig. 3-1. HTO process block flow diagram

. Feeds and feed surrogates may also need to be mixed in a specific order to prevent formation of precipitates or exothermic reactions. In some cases a beaker test is used to confirm the mixture order. The results of the beaker test are scaled up to a plant-sized batch and defined in written mixing procedures.

The process and process equipment are designed to handle well-mixed and finely sized particles in the feed. Because of this requirement some feeds must be ground as part of the preparation.

Some waste feeds are inherently hazardous, such as energetic materials or chemical warfare agents. These wastes often require chemical treatment such as hydrolysis, or slurring in water, to reduce the sensitivity or toxicity of the waste feed.

3.1.2 Feed Preparation Evolution

The SRMD program focused on treatment of Hazard Class 1.1 propellants. The sensitive energetics was hydrolyzed to avoid the cost associated with designing and building an energetics-compatible SCWO system. Two hot-caustic batch hydrolysis processes were developed, one using sodium hydroxide and the other using ammonium hydroxide. Ammonium hydroxide hydrolysis was selected for full-scale demonstration because the end product from

SCWO would have a lower total solids loading. A full-scale system was built and a batch of Hazard Class 1.1 propellant was hydrolyzed and fed to the SCWO system.

The ACWA program desired higher throughputs and continuous feed of the energetic material. A sodium hydroxide hydrolysis system was developed that incorporated a rotary hydrolyzer for continuous feed of the energetic material. The rotary hydrolyzer is similar to a rotary kiln for low-temperature operation ($\sim 100^{\circ}\text{C}$) with flights that contain the feed and caustic solution. The rotary action mixes the solution and provides the necessary residence time for hydrolysis.

The JDT program required treatment of gray and black water. An in-line, continuous-grinding process was developed and demonstrated for pretreatment of these types of sludge. The ACWA program extended the development of the grinding processes for wood, plastics and carbon. Equipment for size reduction of wood pallets, plastic suits and granular activated carbon was developed and demonstrated. The plastic presented unique challenges because it plugged mixer/grinder pumps by flowing around or smearing on the cutting blades. Two methods were developed for plastic materials: (1) cryogenic grinding of the plastics and (2) cofeeding the plastics with a more abrasive material to clean the blades. The cryogenic process was demonstrated with large quantities of plastic. The large initial size of the wood required several steps of size reduction prior to entering the final mixer/grinder pump system.

In addition to the small particle size (~ 1 mm) required for SCWO feed, the settling rate, segregation and wettability of the materials affect the ability to produce well mixed, high-concentration slurry. Feed recipes were developed with various additives to enable consistent production of high-solids-loading, well-mixed slurries.

3.1.3 Feed Preparation Future

Most organic-based solids can now be acceptably prepared for treatment in SCWO systems using the processes developed as part of the JDT and ACWA programs. However, higher concentrations of organic material are desirable for advanced SCWO and SCWG applications. The next generation of pretreatment methods will focus on freeing bound water and enabling feed of nearly dry materials to supercritical water (SCW) systems.

Sodium hydroxide hydrolysis of energetics is well developed. However, the addition of sodium hydroxide is costly and it creates additional solids in the system effluent. The next generation of pretreatment methods for energetics will be hydrolysis without caustic additives and preparation of stable energetics slurries that are not detonatable.

3.2 PUMPING

3.2.1 Pumping Objective

Reliable fluid pumping systems are essential for effective SCW system operation. During feed transitions, smooth metering of the reactor feed materials must occur over a wide range of flow rates (typically a 10:1 turndown ratio).

Typical SCW systems operate at pressures between 2000 and 4000 psig. These pressure ranges necessitate, in most cases, the use of reciprocating, positive displacement, high-pressure pumps that are normally fitted with check valves of various design and high-pressure packing or isolation diaphragms.

The specific fluids to be pumped will depend on the actual SCW application and will cover a broad range of fluid properties. Table 3-1 provides an overview of the most common fluids and their uses in typical SCW applications.

Given the requirements for smooth and controllable delivery of a variety of fluids to the SCW system, numerous challenges exist. Pumping methods to overcome the challenges are described below.

3.2.2 Pumping Evolution

3.2.2.1 Clean Water. Clearly, clean water is the least challenging of the previously described generic SCW feed streams. The critical issues associated with the pumping of a clean water stream are flow control and smooth delivery to the SCW system. Stable reactor temperatures require smooth, nonsurging water delivery to assure a homogeneous, constant-heating value stream to the reactor inlet. The same requirements apply for properly quenched effluent temperature control. These requirements are most critical during initiation of reaction that occurs typically at a flow rate of approximately one-tenth the desired final flow rate.

Homogeneity is achieved by using multihead pump designs. Multihead designs avoid surging by spreading out the average flow rate over multiple delivery elements. Triplex designs are most commonly used; however, duplex designs have also worked effectively. Additionally, pulsation dampers are often used at both the suction and the discharge ends of the pump to further smooth out the delivery of the fluid.

Flow rate control is accomplished by varying the pump stroke length and/or the motor speed. Pump motor speed is adjusted by variable frequency drive (VFD) electronics. Applications that require extremely high turndown ratios (e.g., research SCW units) use independent pump head stroke length adjustment in conjunction with variable-speed-drive electronics.

**Table 3-1
Common Fluids Used in SCWO Applications**

Fluid	Examples	Applications	Comments
Clean water	DI water Tap water "Softened" water	Reactor temperature control Reactor preheating Reactor effluent quench Reactor cooldown Seal purging Pressure precharge	May be recycled process effluent water for certain applications
Clean fuels	Kerosene Diesel fuel Alcohols	Reactor temperature control Reaction initiation	Utilized fuels dependent on availability and oxidant type; some fuels may be mixed with water depending on the SCW application
Organic waste	Solvents Oils and greases Hydraulic fluids	Waste feed	Fluids classified as organic wastes typically have heating values that exceed 2000 Btu/lb; wastes are often complex mixtures of numerous chemical species and constituents
Aqueous waste	Salts Acids Caustics Metallics Water soluble organics	Waste feed	Fluids classified as aqueous wastes typically have heating values below 2000 Btu/lb; wastes are often complex mixtures of numerous chemical species and constituents
Slurries	Municipal sludge Plastics Sewage Coal Explosives Propellants Pharmaceutical Biological Soil Oxides	Waste feed	Slurry wastes are typically complex mixtures of numerous chemical species and constituents
Neutralizers/Additives	Caustic Acid Salts	Solids control pH control Corrosion control	These materials are typically added to the waste feed stream and/or the quench water stream

The standard SCW clean water pump is a motor-driven, reciprocating, horizontal, single-acting, multiheaded, packed-plunger design. Cost and the desired turndown ratio will dictate the selection.

3.2.2.2 Clean Fuels and Liquid Wastes. The requirements for the delivery of clean fuels and liquid wastes are nearly identical to those of the clean water feeds. Considerations for controllability, smoothness of flow and turndown ratio are made, and the solutions are implemented in similar fashion.

Clean fuel and liquid waste pumping differs from clean water with regard to environmental controls. Typical SCW fuels are flammable liquids often with moderate-to-high vapor pressures. Uncontrolled releases and emissions from the pumping system are undesirable from safety and environmental perspectives. Typical packed plunger pumps and their associated packing leakage are not favored for these fluids in SCW applications. Leak-free, hydraulically driven diaphragm pumps are preferred and have provided excellent service for this application in SCW systems.

Slurries. The presence of suspended particulate matter in the fluid stream presents significant challenges to effective pumping. A broad range of particulate sizes, concentrations, and consistencies are encountered within this generic class of fluids. Each combination of characteristics requires careful analysis to assure that the pumping system is adequately designed to meet the SCW system requirements.

Table 3-2 presents a synopsis of the most common challenges faced in pumping slurries to SCW systems. Typical failures resulting from inadequate attention to these issues are also included. A brief discussion of each challenge follows.

Table 3-2
Summary of Slurry Fluid Handling Challenges

Challenge	Failure Mode	Comments
Solids settling	Plugging/pump failure	May occur in low-pressure lines and equipment supplying slurry to the high-pressure pump, the pump head and check valve assemblies, and high-pressure discharge lines
Solids agglomeration	Plugging/pump failure	Same as above
High-slurry viscosity	Inadequate net positive suction head (NPSH)/ pump failure	Extreme cases may cause inward rupture of polymeric-style diaphragm elements
Abrasive solids	Check valve wear/pump failure	High-pressure pump equipment is prone to erosive wear and failure
Fibrous solids	Check valve fouling/ pump failure	Fouling reduces pump efficiency and may lead to failure

A key design element to prevent solids settling is assuring that the fluid line velocity is adequate to keep solid particles suspended and the slurry feed stream homogeneous. This velocity analysis must include internal pump components (e.g., check valve housings, perforated diaphragm support plates, etc). Additionally, reciprocating pump sinusoidal flow characteristics must be considered in the analysis. During the SRMD and BAA programs, modifications to pumps and other pumping system components were made to assure these minimum velocities were maintained.

The agglomeration of solids in the pumping system often presents significant challenges. Feed processing measures (e.g., grinding) may produce adequately sized particles, but some solids have a strong tendency to adhere to each other and/or the processing equipment. If unchecked, the agglomerations can cause plugging in the fluid system. The areas most prone to this failure mode are the low-clearance passages within the pump head and check valve assemblies. Additives have been used successfully to prevent agglomeration problems in pumping systems.

The presence of high-viscosity slurries can lead to inadequate pump NPSH and cavitation. Increasing fluid viscosity helps to prevent solids settling, but the resulting high-friction factors lead to line size selections to reduce velocities and pump suction side pressure losses in order to maintain adequate NPSH. With very high concentration/viscosity slurries, the use of typical reciprocating pumping methods may not be practical.

Abrasive solid particles in waste slurries lead, over time, to significant wear and ultimately failure of the pump check valves. Additionally, abrasive solids tend to be much denser than the bulk fluid and more prone to rapid settling. Abrasive attack of feed processing equipment (e.g., low-pressure recirculation pumps, grinding equipment) is a problem when processing these materials for extended periods of time.

Fibrous, solid particles are common in SCW slurry feed streams. String, hair, adhesive tape strands and wood all have a tendency to form agglomeration "mats" that act as a screen in process piping and equipment. These agglomerations accelerate the accumulation of particulates causing rapid plugging failures of the pumping system. Particle-size reduction of these materials is difficult as thin fibers often sneak through traditional particle-size reduction equipment.

While the modified reciprocating pumping systems were improved throughout the programs to extend the range of slurry pumping, there were many types of slurry still outside the pumpable range. Dual-syringe pumps were developed to feed these more difficult slurries. The reliability and effectiveness of dual-syringe pumps were demonstrated in long-duration tests (500 hours). With the development of these pumps, very high concentration/viscosity slurries can now be pumped into SCW systems.

3.2.3 Pumping Future

Larger and less expensive syringe pump systems need to be developed for full-scale SCW plants. The range of alternative reciprocating pumps (e.g., cylindrical diaphragm pumps and progressive cavity pumps) should be investigated. An effective means to test both syringe pump systems and improved reciprocating pump systems is needed to enable long-term testing without running a complete SCW system or using large amounts of feed material. A reverse syringe pump or letdown engine could be used for this application. Such a system will allow testing of both reciprocating systems and syringe systems to (1) provide better definition of the range of slurries that can be pumped; (2) establish the reliability of pumping new feeds; (3) develop further improvements in the systems; and (4) demonstrate the use of new, less expensive components.

3.3 PREHEAT

3.3.1 Preheat Objective

Heaters are used in the SCWO process to provide hot water for reactor start-up and to preheat waste feed, if necessary. If the waste feed is high energy (mostly organic), the heaters are used only for start-up and shutdown; however, low-energy waste feeds (mostly aqueous) require that the heaters provide enough energy to control the reactor temperature throughout the process. Ideally the heaters should provide a high watt density in order to remain compact and minimize the high-pressure, high-temperature piping. Generally, both on/off and proportional controls are provided for the heaters; and, depending on the size of the system, the heaters may be grouped into banks that operate at different power levels.

3.3.2 Preheat Evolution

3.3.2.1 Radiant Heaters. In many installations, ceramic heaters are installed around a high pressure tube. However, the materials of construction for the tube as well as the tube thickness required for high-pressure operation result in poor heat transfer to the fluid; and the preheater tubes must operate at a relatively high temperature to adequately heat the fluid. One problem with the high temperature is that if the SCWO process is shut down due to an alarm, residual heat can continue to heat the system after the heaters are shut off. Ceramic heaters also have a relatively slow response, so fine temperature control is difficult.

3.3.2.2 Ohmic Heaters. A more efficient ohmic heater has also been used. The ohmic heater uses the resistance of the process tube to generate heat when a voltage is applied. This method is more compact and responsive to control inputs than an array of ceramic heaters of the same wattage. It has become the preferred water preheater design; however, because the process tube is not easily maintained, this type of heater is not used to heat scaling and/or corrosive feeds directly. Instead, it is used to provide hot water to a preheat heat exchanger to indirectly heat such feeds.

3.3.2.3 Gas-Fired Heaters. Heat may also be supplied by a gas-fired heater. This method may be less expensive to operate because natural gas is less expensive than electricity. In general, the heat transfer to the fluid is poor because of the large, thick pipe required and because heat transfer from the gas to the tube is usually low.

3.3.2.4 Igniter. A very compact and efficient way to preheat the SCWO process is through use of an igniter. A small quantity of clean hydrocarbon is ignited in air and provides hot air to heat the reactor. Temperature in the igniter is controlled by the flow of secondary air. Once the reactor is preheated to ignition temperature, fuel is introduced directly to the reactor; and the igniter is cooled. The controls for the igniter are more complex than other heaters because airflow, fuel flow, and the firing of the glow plug must be precisely controlled; but the design is very efficient and has the advantage over heaters that when fuel is stopped to the igniter, the device cools immediately.

3.3.3 Preheat Future

Many methods of preheating for start-up have been demonstrated. The choice is primarily based on economics and compatibility with the installation requirements. Methods for preheating wastes to below the critical temperature point are relatively straightforward. Preheating wastes to higher temperatures without plugging the preheater, as needed in SCWG, requires further development.

3.4 HEAT EXCHANGER

Effective and reliable heat exchange unit operations are required for successful SCW system operation. Typical SCW heat exchanger operating temperatures vary from room temperature to as high as 700°C. Economic pressures often place a premium on the recovery of usable energy from SCW systems. This further challenges the design and implementation of effective heat transfer equipment. The two main heat exchanger types are the process cooldown heat exchanger (CDHX) and the process feed inlet heat recovery heat exchanger (HRHX).

3.4.1 Heat Exchanger Objective

The CDHX is located downstream of the reactor and upstream of the gas/liquid separator. It functions as the final temperature control element in the SCW process. Reacted feed materials are directed from the reactor to the inlet of the CDHX. These materials are often quenched within the reactor for salt dissolution, corrosion control or to mitigate thermal stresses on the discharge plumbing. CDHX inlet temperatures vary from 250 to 600°C. The pressure of the reactor effluent is typically at the operating pressure (nominally 3400 psig) while the pressure of the cooling medium is usually below 100 psig. The cooling medium is typically tap water or a glycol/water mixture. The heat is ultimately dissipated by either an evaporative type cooling

tower or through a closed-loop, air-cooled, fin-fan-type arrangement. Other heat dissipation methods may be used depending on the specific SCW application and installation location.

The HRHX is located upstream of the reactor. Its purpose is to preheat the cold feed materials by heat exchange with the hot reactor effluent. The desired temperature of the feed material exiting the HRHX (250 to 600°C) is dependent on the specific SCW application and is often limited by the type of feed material being processed. The feed and effluent sides of this heat exchanger are usually at the system operating pressure, nominally 3400 psig. The preheated feed material is directed to the reactor. A trim heater may also be used to boost the temperature of the feed material prior to its entering the reactor. The cooled reactor effluent is delivered to the process letdown system and, ultimately, discharged or collected for other uses.

The design of both types of heat exchangers must account for mechanical and thermal stresses, resistances to heat transfer, corrosion/erosion, solids handling, fouling, boiling, thermal shock, cleaning and maintainability.

3.4.2 Heat Exchanger Evolution

Tube-in-tube designs have been used for most of the heat exchangers on SCWO systems. Several alternatives have been used to handle the thermal expansion stresses generated because the inner and outer tubes are different temperatures. These include coiled designs, u-tube designs and straight designs with large welds to withstand the stress. In a few cases, coil and shell designs (a single high-pressure tubing coil inside a shell) have been used.

3.4.3 Heat Exchanger Future

Regenerative heat exchangers can improve SCWO economics for some feeds. Pressure-balanced tubes or tubes made of very-high-strength materials could greatly improve the performance of heat exchangers because conduction across the thick-walled tubes usually limits the overall heat transfer coefficient. Designs that are inexpensive to build and easily maintained and cleaned also need to be developed. Alternative methods to clean a coiled tube would allow maintenance of current inexpensive designs. For SCWG, improvement in heat exchanger design is crucial because heat exchangers are one of the most important components.

3.5 REACTOR DESIGN

In the SCWO reactor the wastes are oxidized to carbon dioxide, water, nitrogen, and mineral acids or salts of mineral acids. Figure 3-2 illustrates the four main generic types of reactors. The first is a pipe reactor that typically has a length-to-diameter (L/D) ratio greater than 25:1.

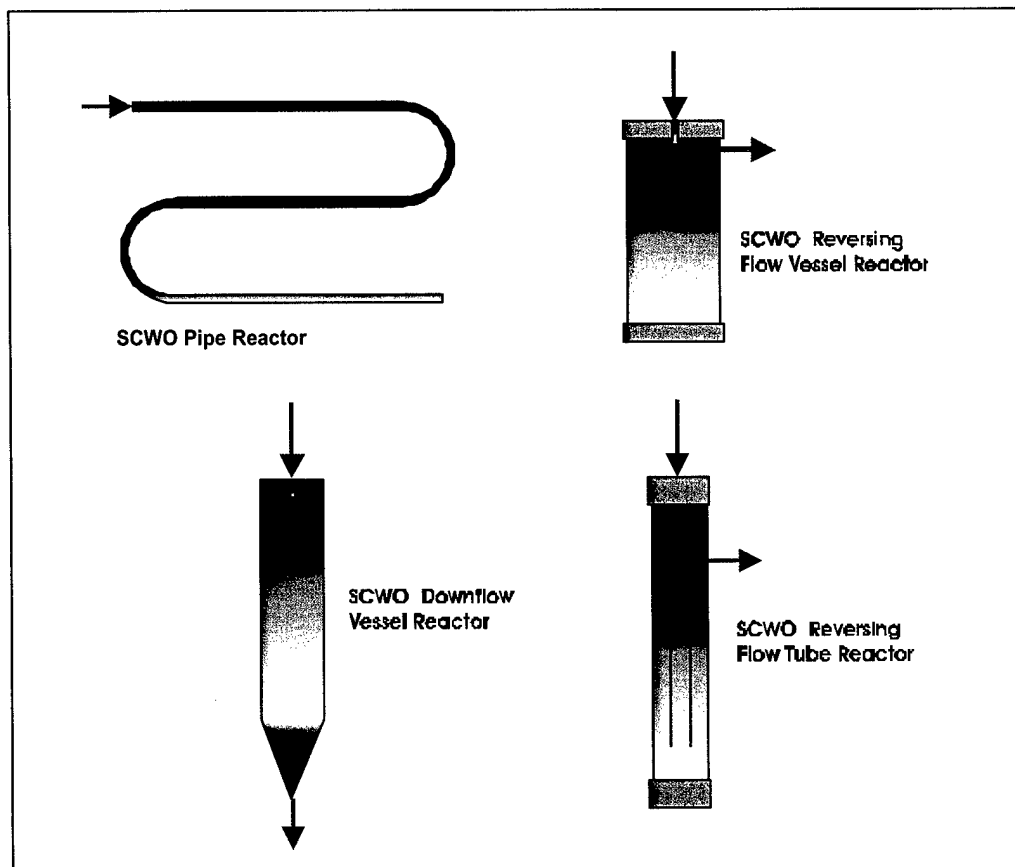

Fig. 3-2. Four types of reactors

The second is a reversing flow vessel reactor that typically has an L/D ratio of less than 6:1 and the inlet and outlet are at the same end of the reactor. The third is a downflow vessel reactor that typically has an L/D ratio of between 6:1 and 25:1. The fourth is a tube-in-tube reversing flow reactor that has the inlet and outlet at the same end with the flow in each direction separated by a tube wall.

A pipe reactor is fabricated by connecting lengths of piping via welds or flanges to attain a reactor with adequate residence time for destruction of the organic materials. Typically the pipes are configured in a coil; however, long straight lengths are sometimes preferred because they can be more easily cleaned by using standard technology. The oxidant and the feeds are typically mixed at the beginning of the reactor. One or more of the feeds must be preheated to a high temperature so that the mixture will spontaneously react with the oxidant after the oxidant injection point. The heat of reaction typically provides the energy to bring the mixture to the final reaction temperature. The reactor behaves as a plug flow reactor with little back mixing, so high destruction efficiency can be obtained with lower residence times (for a given reaction temperature) compared to well-mixed reactors. The advantages and disadvantages of this type of reactor are summarized in Table 3-3.

**Table 3-3
Pipe Reactor Advantages and Disadvantages**

Advantages	Disadvantages
<ul style="list-style-type: none"> • High surface area to add heat (useful if the reaction does not release enough heat) • Plug flow reaction leads to lower residence time (at a given temperature) for high destruction and removal efficiencies (DRE) • High velocity helps keep solids moving • Easy to fabricate by welding pipes together; flanges are less expensive than larger diameter vessel flanges 	<ul style="list-style-type: none"> • High surface area results in higher heat losses and greater insulation requirements • High surface area is more difficult to protect from corrosion • Rapid equilibration of wall and fluid temperature leads to higher wall design temperature to accommodate fluid temperature fluctuations and may limit the maximum allowed reaction temperature • Little or no back-mixing to help initiate the reaction, so higher preheat temperatures are required • Small cross-sectional area is easily plugged and harder to protect from plugging

Because the reactor is the plug-flow-type with little back-mixing to anchor the reaction initiation, the maximum temperature point can move due to changes in the inlet mix temperature or the organic composition. A higher preheat temperature can be used to anchor the reaction initiation; but as the preheat temperature is increased, less heat can be released from the reaction for the same maximum fluid temperature. Thus, higher preheat temperatures require lower organic concentration in the feed. To partially overcome this problem, multiple injection points for oxygen and water can be used to treat higher concentrations of organic material.

Pipe reactors have a high surface area to volume ratio. This makes adding external heat easy; however, it also creates some problems. Providing corrosion protection and salt handling capability are more difficult because of the larger surface area and the relatively small cross-sectional areas. Additionally, the wall temperature tends to rapidly equilibrate with the fluid temperature, so higher pipe design limits are required to accommodate fluctuations in the fluid temperature and may limit the maximum achievable reaction temperature. Heat losses in a pipe reactor are large and more insulation is required.

Unlike the pipe reactor, the reversing flow reactor has a very small surface-area-to-volume ratio. In fact, the reversing flow reactor L/D is limited to approximately 3 to 4 because the flow will turn around at this point regardless of the vessel length. The feeds are typically supplied through a nozzle on the centerline of the reactor. The forced recirculation helps initiate the reaction, so less preheating is required. The main flow then exits from the same end of the reactor as the inlet nozzle. Subcritical brine is often maintained at the bottom of the reactor, and most of the salts and inert solids are captured in the brine rather than exiting with the main flow. Unlike pipe reactors, the reversing flow reactor tends to behave as a well-mixed reactor, so longer residence times are required for high destruction efficiency at a given reaction

temperature. The advantages and disadvantages of the reversing flow vessel reactor are discussed below and summarized in Table 3-4.

Table 3-4
Reversing Flow Vessel Reactor Advantages and Disadvantages

Advantages	Disadvantages
<ul style="list-style-type: none"> • Forced recirculation helps initiate the reaction • Small surface area to protect from corrosion • Relatively low heat losses • Can use mechanical solid and salt handling equipment • Can separate most salts and solids into brine at bottom of the reactor 	<ul style="list-style-type: none"> • Achieving high DRE requires longer residence time or a downstream pipe reactor because there is no plug flow region • Limited to approximately 3 diameters before flow turns, so large diameter vessels and flanges are required • Larger flanges are more expensive than small pipe reactor flanges • Difficult to add heat externally • Corrosion and heat loss associated with maintaining a brine in the reactor

The biggest advantage of the reversing flow reactor is its salt- and solids-handling capability. There is a potential to separate many of the salts and solids in the brine before they come in contact with the reactor wall. The relatively large cross-sectional area and short length facilitates use of a mechanical device to protect the wall from any salts or solids that are not captured in the brine. A relatively clean overhead stream can be produced, facilitating recovery of heat and/or power.

The low surface-area-to-volume ratio also minimizes the heat losses and makes protecting the wall from corrosion relatively straightforward. However, if a brine zone is used, it tends to offset these advantages by creating higher heat losses and a high corrosion zone along the wall at the transition from supercritical to subcritical temperature. Also, the low surface-to-volume ratio limits the capability to add heat externally.

The biggest disadvantage of the reversing flow reactor is that the longer required residence time and limited L/D combine to make the required volume and diameter much larger than other reactor designs. Thus, the reversing flow reactor is more expensive than other reactors.

In the downflow vessel reactor, the effluent exits at the opposite end of the reactor from the inlet. Because the flow does not turn around, as in the reversing flow reactor, the L/D of the downflow reactor is not limited. The downflow reactor retains the advantages and disadvantages associated with a small surface-area-to-volume ratio (Table 3-5). The main differences from the reversing flow reactor are elimination of advantages and disadvantages associated with the brine and elimination of disadvantages associated the limited L/D of the reversing flow reactor.

**Table 3-5
Downflow Vessel Reactor Advantages and Disadvantages**

Advantages	Disadvantages
<ul style="list-style-type: none"> • Recirculation helps initiate the reaction • Small surface area to protect from corrosion • Can use higher L/D than reversing flow, so the diameter does not have to be as large • Higher L/D allows a plug flow region, so high destruction efficiency can be attained with a lower residence time • Relatively low heat losses • Can use mechanical solid- and salt-handling equipment 	<ul style="list-style-type: none"> • Larger flanges are more expensive than small pipe reactor flanges • Difficult to add heat in the reactor

The tube-in-tube reversing flow reactor was primarily developed to recover heat internally within the reactor. Basically it is a reversing flow reactor with the reversed flow separated from the downflow by a wall. This allows high L/D and plug flow, while including recovery of heat from the effluent to initiate the reaction. Thus, it has the advantage of lower residence time and heat recovery to initiate the reaction. Using a pipe reactor with a heat recovery heat exchanger can attain similar benefits. The tube-in-tube reversing flow reactor can accommodate mechanical salt removal equipment and corrosion resistant liners. The disadvantages are the requirement for a larger vessel, three internal surfaces to protect in the reactor, lack of control over the amount of heat recovered, and accumulation of solids in the bottom of the reactor. The lack of control of heat recovery can be partially overcome by having more than one exit from the outer tube to control how much fluid exchanges heat with the feed. Table 3-6 summarizes the advantages and disadvantages of the tube-in-tube reversing flow reactor.

**Table 3-6
Tube-in-Tube Reversing Flow Reactor Advantages and Disadvantages**

Advantages	Disadvantages
<ul style="list-style-type: none"> • Conserves heat by recovering heat from the effluent • Can accommodate mechanical salt removal equipment • Plug flow reaction leads to lower residence time for high DREs 	<ul style="list-style-type: none"> • Larger flanges are more expensive than small pipe reactor flanges • Difficult to add heat in the reactor • Solids can accumulate at the turn-around point • Three internal surfaces to protect from corrosion and salt buildup • Difficult to control the maximum temperature location

3.5.1 Reactor Design Objective

Regardless of the configuration, the reactor must provide for:

- Containment of the reacting fluid at a typical pressure of greater than 3000 psig and temperature of 550 to 700°C
- Enough residence time to achieve the desired destruction efficiency
- Initiation of the reaction
- Mixing of the oxidant, water, and waste
- Temperature control
- Corrosion resistance
- Salt and solids handling

There are three basic approaches to the containment of the reacting fluid. One is to design the pipe or vessel reactor for operation at high pressure and temperature. This approach typically requires the use of high nickel alloys for the pressure vessel. A second approach is to design and operate the reactor at the low end of the temperature range for SCWO reactors. This approach enables the use of lower cost high-strength steels or stainless steels for the pressure vessel wall but requires longer residence time. The third approach is to isolate the pressure boundary from the high internal temperatures so that the containment design temperature can be much lower than the internal operating temperature. This approach enables the use of lower cost steels for the pressure vessel wall without lowering the operating temperature.

The residence time required to achieve the desired destruction efficiency is dependent on the waste material, oxidant, axial mixing, radial mixing, and temperature of the reaction. Reactors that tend toward high-radial mixing with low-axial mixing relative to the overall length (i.e., plug flow reactors) require less residence time than those with higher-axial mixing or inadequate radial mixing.

Initiation of the reaction can always be accomplished by heating one or more of the feeds so that the feed mixture is at the kindling temperature of the waste. The preheating temperature can be reduced by axial back-mixing of the high-temperature-reaction products with the incoming feed materials. Unlike incinerators or other systems with a rapidly moving flame front, the "reaction front" in a SCWO system moves much too slowly to maintain the reaction. Therefore, physical back-mixing of the reacted material is required. Reactors with a higher degree of back-mixing can be operated with lower feed inlet temperatures.

Mixing of the waste, oxidant, and water is very important for efficient oxidation as well as temperature control. Water provides the primary heat sink to absorb the heat of reaction in most SCWO processes. If the water is not adequately dispersed in the waste or oxidant,

extreme local hot spots can occur. If the oxidant is not adequately mixed with the waste and water prior to heating the waste to high temperatures, the waste material can char. The charred material can create several problems. First, it often reacts much more slowly than the feed material so it may pass through the reactor without being fully oxidized. Second, it can stick to the walls or internal reactor components and then cause a local hot spot when it oxidizes, or lead to a plug in the reactor.

The temperature control scheme employed will be dependent on the energy content of the feed. The primary control schemes are based on controlling the preheat temperature prior to the reaction, adding a diluent to absorb the heat, adding fuel to provide more heat, or adding heat externally after the reaction. SCWO reactions are exothermic, so temperature control for cases other than adding heat externally after the reaction typically requires measurement of the fluid temperature in the reactor. A more detailed discussion of controls is presented in Section 3.10.

The impact of corrosion and salt-handling challenges on the reactor, as well as on other equipment, are discussed below in Section 3.6.

3.5.2 Reactor Design Evolution

The primary progress in reactor design during these projects came on the downflow reactor. Design improvements led to reactors that have high-destruction efficiency and low-residence time, can operate without any preheated feeds, incorporate a replaceable liner for corrosion resistance, use reliable O-ring seals, and operate with a cold containment wall so that inexpensive materials can be used for the reactor.

The reduction in residence time while maintaining high destruction efficiency was attained by combining a back-mixed zone and a plug-flow zone in one reactor. Experimental studies with a high-energy nozzle showed that the downflow reactor has extensive back mixing up to an L/D of 5. If a longer reactor is used, the region below an L/D of 5 has much less back-mixing, so it behaves more like a plug-flow reactor. Thus downflow reactors with an L/D of greater than 6 maintain the benefits of a vessel-type design for corrosion, salts handling, and reaction initiation while adding the benefit of the low-residence time for high-destruction efficiency typical of a pipe reactor. As a result, downflow reactors have attained equivalent destruction at one-fourth the residence time of a reversing-flow-type reactor.

Extensive experimental work was performed to determine the upper limit of the stability range for cold feed injection. As the flow is increased, the reaction will eventually be extinguished because it does not produce heat fast enough to heat the incoming feed. The scaling and magnitude of the stability limit were established and found to be in good agreement with the theoretically predicted form and values.

A floating liner was incorporated that allows the wall of the reactor to operate at a much lower temperature than the internal fluid. This design feature has two benefits that greatly

improve the economics of reactors. First, higher internal temperatures can be used, so the required reactor volume and residence time is greatly reduced. Second, a cold-wall vessel can be made with less expensive materials and a much thinner wall than a hot-wall vessel.

Reactor temperature measurement was also improved. Thermocouples for measuring internal reactor fluid temperature were provided with corrosion resistant sheaths of titanium or platinum, and additional corrosion and mechanical protective tubes were added to improve the reliability of temperature measurement. For the reactor wall temperature measurement, the attachment method to ensure good contact with the wall was improved, and in some cases the thermocouple tips were embedded into the reactor wall.

3.5.3 Reactor Design Future

Future work will focus primarily on development of reactors for SCWG and low-cost reactors for SCWO. SCWG presents some new and unique challenges in reactor design because the reaction is not highly exothermic, and the environment is reducing instead of oxidizing.

3.6 CORROSION AND SALT HANDLING

3.6.1 Corrosion and Salt Handling Objective

Corrosion and salt handling have been considered the two most important challenges in many SCWO systems. Hetero-atoms in the waste such as Cl, F, S, and P are converted to mineral acids or salts of mineral acids. The mineral acids are extremely corrosive in the high-temperature, high-density, aqueous SCWO environment. The high-corrosion rates observed at reaction conditions (550 to 700°C) are often even higher during transitions from supercritical to subcritical conditions, 350 to 450°C. In order to combat this corrosion, cations are often supplied to form salts instead of acids. However, this creates a problem of salt transport because salts above ~50 to 100 ppm precipitate at the reaction conditions and plug reactors or piping. Also, the salts themselves can be corrosive in the SCW environment. Thus, there is often a choice of developing a system that can handle the corrosion from the mineral acids or neutralizing the acids and developing a system that transports the salt.

Reactor walls use steels or high nickel alloys for their strength at temperature. However, steels and high nickel alloys are often rapidly corroded in the SCWO environment. Therefore, liners or coatings are used to provide corrosion resistance, and a resultant challenge is the development of techniques for incorporating liners into the SCWO system. The liners must accommodate instrumentation and in some cases must be sealed against the high reactor pressure.

3.6.2 Corrosion and Salt Handling Evolution

Corrosion-resistant materials have been identified for all mineral acids, principally platinum alloys and titanium alloys. Liners and coatings of these materials have been developed and

used in HTO reactors. Downflow reactor liners have included floating liners, fixed liners, and bonded liners. The floating liners are easily replaced. Coatings have been applied using plasma spray and electroless plating. Safety concerns associated with the use of titanium in HTO systems have been addressed. Methods for introducing and protecting instrumentation in lined reactors have also been developed and demonstrated.

In addition to downflow reactor liners, corrosion protection of tubular reactors and heat exchangers has been achieved through development of techniques for lining tubular reactors, making lined joints, and repairing lined tubes.

A number of methods have been developed to prevent salt plugging. Mechanical salt transport has been demonstrated using a rotating scraper acting against a stationary scraper bar. Many types of salt constituents have also been transported through reactors by the use of additives. Cold-feed injection eliminates concerns about salt precipitation upstream of the reactor. Quench systems have been demonstrated to successfully re-entrain or redissolve salts that are transported through the reaction zone.

3.6.3 Corrosion and Salt Handling Future

Like reactor design, good progress has been made in the areas of corrosion and salt handling during these programs. While there are some specific cases where salt transport is still a concern, the majority of salts can now be acceptably transported. The future work will focus on nonsodium salts such as aluminum salts generated from energetics hydrolysate or calcium salts from nonsoftened water.

Like salts, most corrosive feeds can now be treated in platinum- or titanium-lined reactors. The technical problems associated with the use of liners have been largely resolved. There are now only a few specific cases where corrosion is a concern. One example is wastes that include phosphate in conjunction with chloride.

3.7 GAS-LIQUID SEPARATION

3.7.1 Gas-Liquid Separation Objective

This step separates the liquid and gaseous effluent streams. A separation vessel sized to give an adequate liquid dropout length fitted with a demister is used for this task. Surge volumes are estimated and incorporated into the vessel-sizing calculations. The separation typically takes place at an elevated pressure (1500 to 3400 psi). The high pressure of the gas-liquid separation (GLS) vessel requires that the vessel be code stamped.

3.7.2 Gas-Liquid Separation Evolution

The primary difficulty with high-pressure gas-liquid separators has been the measurement of the liquid level to provide input to the process control of the liquid level. Differential pressure

transmitters (DPTs) are typically used. Capacitance and magnetized floats have also been used. Each method has shortcomings that can cause erroneous readings.

The DPT-to-GLS configuration consists of a connection at the top and bottom of the GLS to the low- and high-pressure ports on the DPT sensor. Problems arise with this configuration when these pressure impulse lines are not isolated from the process fluids. Solids in the liquid effluent can infiltrate and plug pressure impulse lines, and surges in flow can result in flooding of the low-pressure impulse line; both of these situations give rise to an erroneous level measurement. Sometimes gas is bubbled through the ports to prevent plugging, but surges in gas flow from changes in system pressure can lead to erroneous readings.

Another method employed to measure liquid level involves the use of magnetic fields. The top and bottom of a small diameter vessel the same length as the GLS is connected to the same upper and lower ports that would be used by the DPT. A magnetized float installed in the indicator vessel activates switches mounted to the outside of its wall as it rises and falls with the changing liquid level. The resolution of this method of level measurement is limited to the spacing between the magnetic switches. This method is also vulnerable to solids plugging the lines connecting it to the GLS. Solids in the effluent can sometimes cause the float to stick.

A capacitance-level indicator has been used that is not susceptible to solids plugging or flooding. However, erroneous readings have still been observed during rapid system changes. The origin of the error has not yet been determined.

Ultrasonic level indicators used in low-pressure tanks are difficult to find for the high pressure in the GLS and have not yet been utilized.

3.7.3 Gas-Liquid Separation Future

As a general rule, gas-liquid separators have worked well. However, for applications with widely varying feed streams, obtaining a reliable liquid level measurement sometimes requires tuning of the system with the new feeds. A liquid level measurement that is less susceptible to feed variations and is not susceptible to flooding is desirable. Several options are available to achieve this objective, such as (1) use a standard differential pressure transmitter with sealed impulse lines or (2) modify the capacitance level indicator to provide more reliable measurements during transitions.

3.8 PRESSURE LETDOWN

3.8.1 Pressure Letdown Objective

Typically the gaseous, liquid, and solid effluents must be reduced in pressure from 3000–4000 psig down to ambient in a controlled manner. Often the control elements experience excessive wear requiring frequent maintenance. Ideally, a letdown system that provides good control with robust components is desired.

3.8.2 Pressure Letdown Evolution

In early SCWO systems, gases, liquids, and solids were let down together through series of capillaries, control valves, or a combination of both. This works well for many feeds. However, erosion from the liquid and solid fractions is exacerbated by the rapid expansion and high velocity of the gaseous fraction. Therefore, gas-liquid separation was added to allow separate liquid and gaseous pressure letdown reducing the wear on the letdown system. Multiple stages of letdown and gas-liquid separation further reduce wear because dissolved gases that evolve at lower pressures can be removed at the intermediate stage or stages.

If gas-liquid separation is used, then liquid letdown is typically used to control the GLS level. Solids handling problems can still hamper the liquid letdown system. Large particles can plug control valves and capillaries, while fine particulates can cause erosion damage to these components. Improvements in valve selection and materials have been made throughout the programs. Capillaries are often used in combination with control valves to reduce the load on the primary control valves.

The gaseous effluent pressure letdown control valves typically consist of two valves in series. The primary valves (first in the series) are used to control system pressure. There is usually a 50% drop in system pressure across these valves. The secondary valves complete the depressurization of the gas stream. Moisture in the gas stream can freeze due to the depressurization of the gaseous effluent at the valve. The particulates of ice can then plug the control valve and block the system's gaseous effluent flow. This situation is particularly undesirable since the system's pressure control typically utilizes these valves to maintain the desired operating pressure. Sizing the CDHX to produce effluent temperatures just high enough to keep the gaseous effluent above freezing after going through decompression is a demonstrated method of dealing with this problem. When the desired CDHX sizing is not possible, heat tape and block heaters have been used to increase the temperature of the effluent gas prior to depressurization in order to avoid freezing any moisture in the gas steam.

Moisture condensation on the outside diameter of the effluent piping is another difficulty related to the temperature reduction experienced during the depressurization of the gaseous effluent. The condensate on the letdown system has the same appearance as a system leak and can be misinterpreted. To avoid the condensation of atmospheric moisture on the piping system, insulation is typically wrapped around the letdown system to isolate it from any moisture.

Combined effluent pressure letdown prior to the GLS alleviates some of the aforementioned pressure letdown concerns. This type of pressure letdown system has been implemented using a pressure control pump and a capillary with an inside diameter large enough to allow particles in the SCWO effluent to pass through it without plugging. Effluent from the SCWO process joins a stream of water before entering the capillary tube. Water flow to the capillary is varied to provide a constant upstream pressure to the capillary. The outlet of the capillary is unobstructed and flows to the GLS, which operates at less than 50 psi. This method of pressure control can

require a significant quantity of water or recycled effluent and a high-pressure pump capable of delivering the needed volume of water.

3.8.3 Pressure Letdown Future

Improvements in valve design and letdown configurations are desirable to reduce the maintenance associated with the letdown system. Typically, dual sets of letdown components are required at this time to allow operation to continue while repairs are made on the alternate letdown components.

A letdown engine similar to the dual-syringe feed pump could eliminate the problems of erosion and plugging. Furthermore, it would allow testing of slurry feed pumps without operating the SCWO system because it could accept any type of fluid.

The ideal system would recover energy from the effluent during pressure letdown. The next step after a simple letdown engine would be an energy recovery letdown engine.

3.9 SOLIDS SEPARATION

3.9.1 Solids Separation Objective

Often solids need to be separated from the effluent for disposal or to protect the letdown components. Protecting the letdown system requires high-pressure solids separation. Separation for disposal can be done at high or low pressure.

3.9.2 Solids Separation Evolution

The initial approach for SCWO solids separation was simply to use duplex filters to protect the letdown system. One filter is on-line, while the other one is cleaned and later placed back in service. High-pressure hydrocyclones have also been tested. These provided the best particle separation if they were operated at high temperature where the density difference between the solids and fluid was greater. Hydrocyclones require an underflow that may need additional separation if the solids must be disposed of separately.

Later, high-temperature, high-pressure filters were employed to achieve separation of both soluble and insoluble solids from the effluent. These were operated with a blow-back system to clean the filters on-line. Although built and partially tested, this type of filter was not fully systematized because of funding limitations and priority on JDT demonstration tests.

Low-pressure solids separation has been done using SpinTek filters to remove the insoluble solids as a thick paste. The water phase is then subjected to ion-exchange to remove the soluble metal ions. The SpinTek filters experienced significant wear during testing with high solids loading feeds.

A low-pressure solids separation using a rotary filter with a diatomaceous earth pre-coat was designed and specified. However, the system has not yet been built and utilized in SCWO systems.

3.9.3 Solids Separation Future

Effluent solids separation has not been a significant concern in HTO programs to date because the solids generated are typically non-hazardous or are in small enough quantities that simple duplex filter can be used. If additional solids separation is desirable, then one of improved designs for high-pressure or low-pressure solids filtration systems should be implemented. The designs for these improved filtrations systems are complete, but they have not been demonstrated.

3.10 CONTROLS

3.10.1 Control Objective

SCWO requires control of temperature, pressure, and flows for proper operation of the process. Full automation of the process controls is desired to reduce operator requirements and the associated labor cost. The technical challenges include ensuring personnel safety in all modes of operation, controlling temperature and pressure, controlling influent and effluent flows, providing a straightforward user interface, and recording the process variables for archive. The process requires that the control system be capable of detecting and responding to a high-pressure or high-temperature event in <200 mS; however, most changes to outputs need to be controlled slowly and steadily to move the process seamlessly through startup, ignition, steady state, and shutdown.

In the event of an emergency, an emergency stop pushbutton (E-stop) is provided. The E-stop will terminate all electrical control power to the feed pumps and valves so that all pumps will stop and valves will either open or close as predetermined by their fail position. In general the waste, fuel, and process air valves will close and water and effluent valves will open so that the system will vent in an E-stop condition. Additionally, hardwired interlocks are provided for high-temperature and high-pressure event protection. These devices have the same system effect as the E-stop button and provide an extra level of temperature and pressure safety independently from the normal control system.

The equipment used in SCWO operation consists of the following items.

- Tanks
- Piping and fittings
- Pumps
- Valves
- Filters

- Preheater
- Reactor
- Cooldown heat exchanger
- Gas/liquid separator
- Pressure reduction equipment
- Gas analysis equipment
- Instrumentation

Control of this equipment can be divided into the following categories.

- Feed-tank levels
- Oxidant supply pressure
- Liquid feeds and oxidant flows
- Preheat temperature
- Reactor temperature
- Reactor pressure
- Quench temperature
- Cooldown temperature
- GLS liquid level
- Effluent pH

3.10.2 Controls Evolution

The SCWO process has been implemented in various sized units ranging from small units with about 10 input/output (I/O) points to medium-sized units with about 200 I/O points. All systems have had alarms and interlocks that monitor and enforce safe processing conditions. Fast processing speed (<100 mS) is essential to collect information, control the equipment, and enforce alarms and interlocks. The interface that delivers operator setpoints and on/off controls can run at a slower rate (3-second round-trip).

The systems typically provide proportional integral derivative (PID) loops for control of process pressure, temperature, flow, level, and pH. All parameters related to each loop (the process variable, the actual output, the requested output, setpoint, and the Manual/Auto toggle button) are located together near the device on the detailed operator screens. These groups all work in a similar fashion no matter where they occur in the system. In some cases more complex control schemes, such as cascading PID loops, have been used to improve process stability.

The control system typically tracks many conditions that indicate a process upset or equipment failure. Most alarms have two or three levels of severity. The lowest-level alarm

brings the condition to the attention of the operator. At this point, the operator should take some corrective action. If the condition continues and exceeds the interlock setpoint, the system will take automatic action in an attempt to eliminate the problem or shut down the system. A portion of a typical alarms and interlocks screen is illustrated in Fig. 3-3.

Alarms			
L1	L2	L3	Description
666	671	676	1 Wall/tube temperature HI - RX region
638	643	648	2 Temperature HI - Ignitor region
639	644	649	3 Temperature HI - RX effluent region
190	190	195	4 Temperature HI - low temperature region
801	826	876	5 Internal temperature HI - RX region
5000	5100	5200	6 Pressure HI - compressor region
4200	4400	4500	7 Pressure HI - feed region
3700	3800	3900	8 Pressure HI - RX region
125	145	150	9 Pressure HI - low pressure region
03	01	00	10 Process water flow 0

Fig. 3-3. Alarms and interlocks screen

Steady-state operation requires relatively few control actions; however, start-up and shutdown involve many steps. Some, if not all, of the steps are repetitious and require timed ramps that are difficult for an operator to accomplish in a perfectly consistent manner from run to run. Additionally, most military and commercial users would prefer a system that will be capable of "one-button" (fully automated) operation. To accomplish this level of automation, the SCWO process control is divided into seven distinct modes of operation.

1. Initialization – system checks and start pressure control
2. Preheat or ignition in igniter – ignite and preheat the reactor
3. Ignition in reactor – feed fuel directly into reactor, turn off igniter/preheater, adjust airflow, pressure and temperature
4. Start waste feed to reactor – slowly start waste feed, adjust fuel as necessary, control temperature with water or fuel
5. Steady-state operation – continue operation until signaled to either idle or shut down
6. Transition to idle – reduce waste feed until off, adjust fuel as necessary
7. Shutdown – turn off fuel, cool reactor, depressurize

These modes are then broken down into a series of steps and checks that allow the software to sequence through the SCWO process. Several test programs have now been run with single-button operation.

3.10.3 Controls Future

Now that full automation has been demonstrated, the systems need to be enhanced to provide support for maintenance. Ideally the control systems would notify the operators when maintenance is required, diagnose any system failures, and provide guidance on any necessary

repairs. Determining maintenance will require tracking equipment performance to catch signs of impending failure as well as monitoring operating hours for comparison to routine maintenance requirements. Implementation will require information on operating data that changes when equipment needs maintenance and on original equipment manufacturer maintenance schedules. Diagnosing system failures will require development of a database of anticipated failure modes for the system and how to diagnose the failure from the available instrument data.

4. FUTURE MILITARY AND INDUSTRIAL APPLICATIONS

The inherent environmental advantages of SCWO are well known. The operational performance testing and technological advances achieved during the SRMD and BAA contracts have overcome many of the important challenges that originally faced SCWO systems. Widespread use of SCWO now depends on improvements in capital and operating costs plus R³ of valuable components contained in the waste streams. These improvements to SCWO will lead the way to the future military applications such as:

- Demil of energetics and chemical agents
- Treatment of production wastes (e.g., red water from TNT manufacturing)
- Mobile systems for forward bases and shipboard installation
- Power generation from military waste (e.g. smokes and dyes, propellants, energetic materials, contaminated fuel, waste paints and solvents)
- Gasification of military wastes to hydrogen and/or natural gas
- Chemical production via selective partial oxidation or hydrolysis of waste materials

5. REFERENCES

1. Air Force SRMD Project Status Meeting, September 29, 1993.
2. Air Force SRMD Project Status Meeting, December 15, 1993.
3. SRMD Program – Supplemental HTO Development Test, 629017 Rev. A, September 1998.
4. JDT on HTO Final Technology Validation Test Report, 109003 Rev. A, November 2001.
5. EST Materials of Construction (MOC) Final Report, 309513 Rev. N/C, February 2000.
6. Engineering Scale Test of Supercritical Water Oxidation of VX/NaOH Hydrolysate, Stone and Webster R07V-04 Rev. 1, April 2001.

APPENDIX A

SUPERCRITICAL WATER OXIDATION FOR THE NEWPORT CHEMICAL AGENT DISPOSAL FACILITY – A STATUS REPORT

**SUPERCRITICAL WATER OXIDATION
FOR THE
NEWPORT CHEMICAL AGENT DISPOSAL FACILITY**

A STATUS REPORT

**PREPARED IN SUPPORT OF THE
U.S. AIR FORCE**

September 2002

TABLE OF CONTENTS

A-1. SUMMARY/INTRODUCTION	A-4
A-2. THE ENGINEERING SCALE TEST (EST).....	A-4
A-2.1 Results of the EST.....	A-6
A-2.2 EST SCWO System Deficiencies	A-7
A-3. RECENT SCWO TEST/DEVELOPMENT EFFORTS.....	A-8
A-3.1 Bonded Platinum Liner Development.....	A-8
A-3.2 ACWA Testing	A-9
A-3.3 Joint PMATA/PMACWA Testing	A-10
A-4. CONCLUSIONS	A-11
A-5. REFERENCES	A-12

FIGURES

Fig. A-1	EST SCWO Facility in Corpus Christi, Texas	A-5
Fig. A-2	Residual Salt Remaining in Reactor after ~12-hr Duration.....	A-6
Fig. A-3	Two Bonded Platinum Liner Bend Test Samples Showing Bends in Two Axes	A-9
Fig. A-4	Full-Scale Bonded Platinum Liner Test Article	A-9
Fig. A-5	Bonded Platinum Removable Wrap-Around Liner Design.....	A-10
Fig. A-6	Platinum Test Article	A-10
Fig. A-7	High Availabilities Achieved During ACWA Demonstration Testing.....	A-11

A-1. SUMMARY/INTRODUCTION

General Atomics (GA) has been developing supercritical water oxidation (SCWO) technology for the past 10 years. From 1996–97, GA successfully demonstrated SCWO of VX hydrolysate, which ultimately led to the selection of SCWO as the post-treatment technology for the Newport Chemical Agent Disposal Facility (NECDF). This document summarizes recent SCWO design and test efforts and presents an overall evaluation of the status of SCWO as applied to the NECDF.

In the 1998 review of the application of SCWO for the treatment of VX hydrolysate at the NECDF, the National Research Council (NRC) recommended construction and operation of a pilot-scale SCWO process “with the critical characteristics of the full-scale design” (Ref. 1). This gave rise to the Engineering-Scale Test (EST). The EST confirmed excellent VX hydrolysate destruction efficiency, salt transport, pressure letdown control, platinum liner corrosion resistance, and design margin. The NRC, however, recognized that the EST would likely not provide all of the data necessary for successful implementation of the technology at the NECDF. They therefore recommended that the Army “make provisions for targeted research and development to resolve problems identified during the pilot-scale testing.” Two primary deficiencies surfaced during pilot-scale testing in the EST: (1) deformation of the platinum liner and (2) generally low plant availability. Through the additional SCWO testing and development performed by GA in support of the Program Manager for Assembled Chemical Weapons Assessment (PMACWA) and the Program Manager for Alternative Technologies and Approaches (PMATA), this targeted research has been completed, and the major issues raised during conduct of the EST have been resolved. The completion of approximately 6,000 hours of ACWA testing has provided a firm basis for SCWO system availability assumptions. The development of a bonded platinum liner has eliminated the platinum liner failure mechanism that led to the deformation of the EST liner. The validation of C-276 as a viable reactor liner for VX hydrolysate provides a backup liner option to platinum.

Section A-2 presents the results of the EST. Section A-3 presents the results of SCWO development and testing performed since completion of the EST. Section A-4 presents the conclusions.

A-2. THE ENGINEERING SCALE TEST (EST)

Following completion of SCWO demonstration testing of VX hydrolysate from 1996–97 (Refs. 2, 3) and an evaluation of the results, the Army selected SCWO for post-treatment (i.e., hydrolysate destruction) at the NECDF. The NRC performed an assessment in 1998 of the use of SCWO for this application and provided recommendations for pilot-scale testing, materials of construction testing, and provisions for additional SCWO research following the completion of pilot-scale testing. These recommendations led to the creation of the EST (Ref. 1). The Army then defined a program for fabrication and testing of a SCWO unit with a throughput of 1/10th that of the full-scale NECDF unit (i.e., an engineering-scale unit). The unit was designed, fabricated, and then delivered to the planned site (Corpus Christi, Texas) for testing in 2000. Testing of the EST unit was performed from 2000–2001. Figure A-1 shows a photograph of the EST test facility.

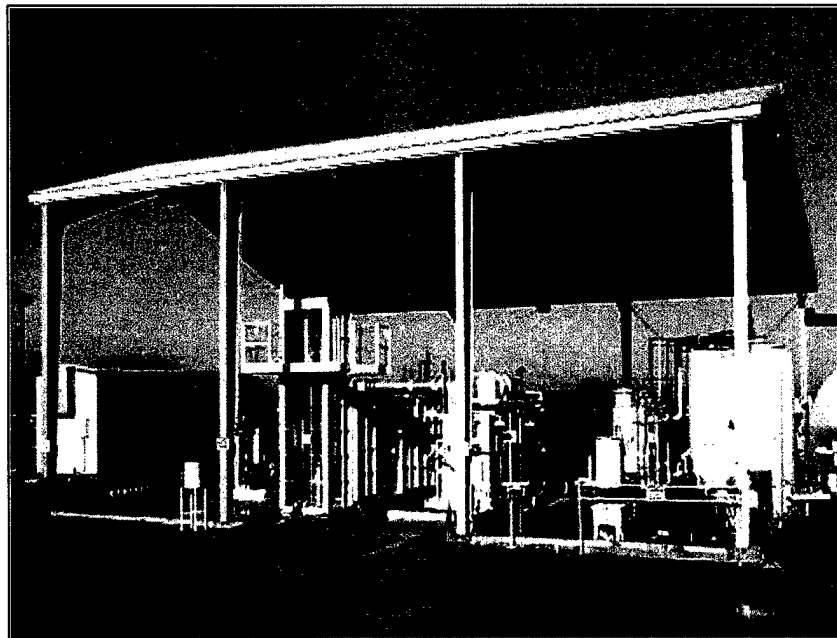

Fig. A-1 – EST SCWO Facility in Corpus Christi, Texas

Typical operating conditions in the EST reactor were 3400 psi and 650°C. The system utilized oxygen as the oxidant and a platinum liner for reactor corrosion protection. The nominal hydrolysate throughput was specified as 225 lb/hr (~1/10th the full-scale throughput). The hydrolysate was made by the Army to the same recipe planned for the NECDF. Hydrolysate surrogate was also used and matched the actual hydrolysate with regard to all significant composition criteria.

The EST was a fast-paced, ambitious test program. Strict procedural controls were instituted for personnel training and certification, document control, equipment inspection, maintenance, and parts tracking, materials certifications, and test plan modification. These controls, along with information resulting from implementation of these controls, provided valuable data for use in the full-scale design and were in many respects identical to the requirements for a full-scale operating facility. Due to funding and schedule limitations, however, not all planned activities were completed.

A-2.1 RESULTS OF THE EST

Testing was performed in four separate phases: (1) workup testing, (2) scale-up testing, (3) performance demonstration testing, and (4) sacrificial liner testing. The initial workup testing was designed to not only verify readiness of the SCWO system but to provide useful design data in the areas of oxygen stoichiometry requirements, salt accumulation rate within the reactor, reactor rinse frequency and rinse effectiveness, and consistency between hydrolysate surrogate and actual hydrolysate. Test data showed that the EST system, as fitted with a platinum reactor liner, reliably and continuously transported salts through the reactor and downstream components. Further, it was shown that 25% excess oxygen was sufficient for effective organic destruction; and, other than the two liquid phases present in the hydrolysate (versus a single phase for the surrogate), no significant differences between the hydrolysate surrogate and actual hydrolysate were observed. During the workup test phase, an inspection of the platinum liner showed a deformation at the lower end where the platinum had pulled away from the support sleeve. The deformation did not affect SCWO system performance, salts transport, or hydrolysate destruction. Follow-on testing was completed with no additional platinum liner deformation observed. In total, 42,104 pounds of VX hydrolysate and 51,634 pounds of hydrolysate surrogate were processed during the EST.

Scale-up testing was designed to confirm the basis for process scale-up of the EST data to the full-scale NECDF SCWO system size, principally in the areas of reaction stability, organic destruction, and salt transport. Testing was performed at 30%, 100%, and 150% of nominal system throughput. The 150% test was performed to provide an estimate of the minimum margin on reactor stability or salt transport that may be present. The 30% test was performed to demonstrate system turndown capability and to provide a better trending profile from which to extrapolate to higher flows. Test data confirmed that over the range of hydrolysate throughputs investigated, reactor conditions were stable and salt transport was effective with no signs of deleterious salt buildup. Salt accumulation within the reactor typically reached a low, steady-state value that decreased with increasing throughput. Figure A-2 shows a salt transport profile indicating a reduction in salt accumulation within the reactor with increasing system throughput (or velocity).

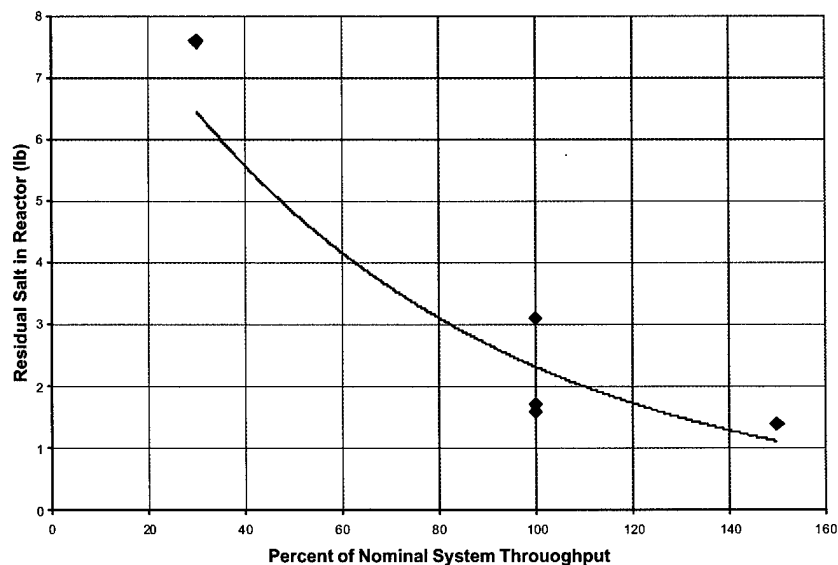

Fig. A-2 – Residual Salt Remaining in Reactor after ~12-hr Duration

Performance demonstration testing was conducted to help evaluate the operational maturity of the SCWO system at 1/10th scale. It was originally intended to run for a total of 360 hours, but time constraints and the addition of sacrificial liner testing necessitated limiting the testing to about 122 hours. Testing started on December 6, 2000, and concluded on February 12, 2001. On December 14, a reactor rupture disk burst due to a plugged preheater nozzle. Subsequent analyses, approvals, and parts procurement activities delayed restart of the testing until February 4, 2001. Neglecting the administrative down time, the overall availability of the SCWO system was approximately 71%, a reasonable availability for a development test, but still less than the target of 80% established prior to the start of testing.¹

The deformation of the EST platinum liner observed during the workup test phase indicated that additional design and/or development work was required before fabrication of a full-scale platinum liner should proceed. Validation of a backup material of construction for the reactor liner was also desired. Toward this end, testing of a C-276 sacrificial liner was added to the scope of the EST. Testing was primarily aimed at: (1) determining whether the rate of corrosion of a C-276 liner was acceptable and (2) determining whether the corrosion product/salt buildup within the reactor could be removed via a reactor rinse. After a total of about 104 hours of processing at the nominal hydrolysate throughput of 225 lb/hr, corrosion product plugging occurred in the reactor that was sufficient to necessitate termination of the test. Based on these results, a C-276 sacrificial liner in the tested configuration was judged not to be a viable option for a backup liner material of construction. During later joint PMATA/ACWA testing, a variety of parameters were investigated, and conditions were identified where C-276 was acceptable as a backup liner material of construction for the NECDF (see Section A-3.3). Based on these data, C-276 was selected as the primary liner for ACWA VX hydrolysate testing.

A-2.2 EST SCWO SYSTEM DEFICIENCIES

A number of deficiencies were encountered and overcome during conduct of the EST, and extensive development and pilot testing over the past two years has been specifically devoted to resolving these issues. Some of the problems were specific to the EST such as cold weather encountered in the outdoor facility, issues associated with the liquid oxygen feed system, and several computer failures. Several of the observed problems are considered general maintenance items, including periodic replacement of internal thermocouples, feed nozzles, or reactor inserts. The discussion to follow focuses on the two significant issues observed during the EST: (1) removable platinum liner mechanical integrity and (2) overall SCWO system reliability and availability.

The first-of-a-kind platinum liner design utilized during the EST consisted of a 0.030-inch platinum liner contained within a C-276 support sleeve, with an annular gap between the two of only about 0.001 inch. The platinum was attached to the support sleeve via circumferential welds only at the top and bottom of the liner to prevent process fluid from entering the annular space. Thus, over the majority of the axial length of the liner, the platinum was not attached to the support sleeve. An inspection of the liner performed during the workup test phase revealed corrosion of the C-276 sleeve in and around the lower bimetallic weld and significant deformation of the platinum liner. The corrosion at the lower C-276 liner end allowed process fluid to enter the annulus between the platinum and the C-276. Upon depressurization of the reactor, the fluid in the annulus expanded, and it was sufficiently confined such that a pressure

¹ The EST availability is defined as 100% minus the percentage of time required for unscheduled shutdowns.

differential developed across the platinum liner. The platinum liner partially buckled to relieve the pressure differential. Following an evaluation of the liner, the remainder of the lower bimetallic weld was removed, and the gap at the end of the platinum liner was manually increased to provide a larger vent path for any fluids potentially present in the annular space. Testing then continued for several hundred more hours, and no additional deformation of the platinum liner was observed. Following post-test inspection and analysis of the liner, platinum was shown to provide excellent corrosion resistance under actual operational conditions. A robust platinum liner design has subsequently been developed which is expected to resolve the issues encountered during the EST (see Section A-3.1).

With the exception of the down time associated with the reactor rupture disk failure, the overall SCWO system availability during the performance demonstration run was approximately 71%. This falls short of the initial availability goal of 80%. Additionally, the maximum continuous run time during this test was 78.5 hours, as compared to an initial goal of 120 hours. Therefore, the performance demonstration testing of the EST did not meet the established pretest criteria with regard to overall system availability and continuous operating duration. This shortfall in performance is believed to be largely due to inadequate systemization and checkout of the SCWO system. During ACWA testing where extensive systemization and checkout of the SCWO system was performed prior to the start of demonstration testing, availabilities of ~80% were achieved in over 2500 hours of testing (see Section A-3.2).

A-3. RECENT SCWO TEST/DEVELOPMENT EFFORTS

Applicable SCWO development and testing since completion of the EST has been performed in three primary areas: (1) development of a bonded platinum liner using the Hot Isostatic Press (HIP) fabrication method, (2) ACWA performance demonstration testing, and (3) Joint PMATA/ACWA testing to validate a backup reactor liner material. These areas, discussed further below, appear to resolve the major deficiencies observed during conduct of the EST.

A-3.1 BONDED PLATINUM LINER DEVELOPMENT

The HIP process was selected for final development for the NECDF, and the development efforts are documented in Refs. 5 and 6. The HIP process utilizes high pressures and high temperatures to create a diffusion bond between the platinum and the C-276 support sleeve. Validation testing of the HIP bonding process began with preparation of small-scale test coupons. Metallographic examinations showed a uniform bond between the platinum and the C-276. The coupons were then subjected to a three-point bend test that showed no indication of delamination or tearing of the platinum (see Fig. A-3). The coupons were later placed in a furnace and subjected to thermal cycling (simulating the cycling of a SCWO reactor) to determine if thermal cycling would lead to delamination of the platinum. Following completion of 20 thermal cycles, the coupons were metallographically examined, and no changes from the as-bonded condition were observed.

A larger diameter test article was then fabricated (see Fig. A-4). The test article was the same inner diameter as that planned for use in the full-scale SCWO reactor (10.2 inches). The length of the test article was limited by the available platinum to about 8 inches. Following completion of the HIP process, a ring was removed from the center of the article to allow

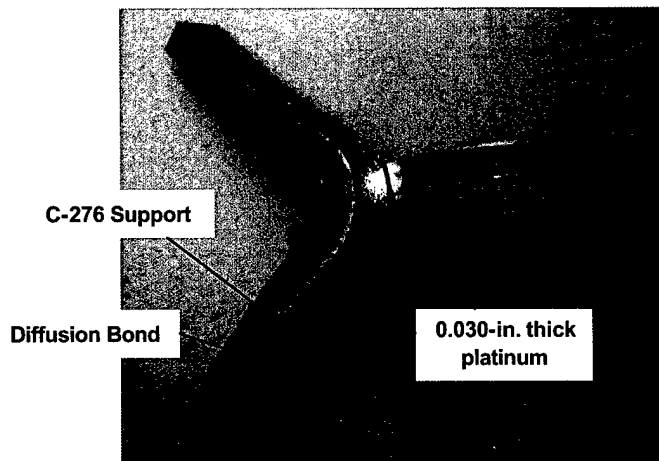

Fig. A-3 – Two Bonded Platinum Liner Bend Test Samples Showing Bends In Two Axes

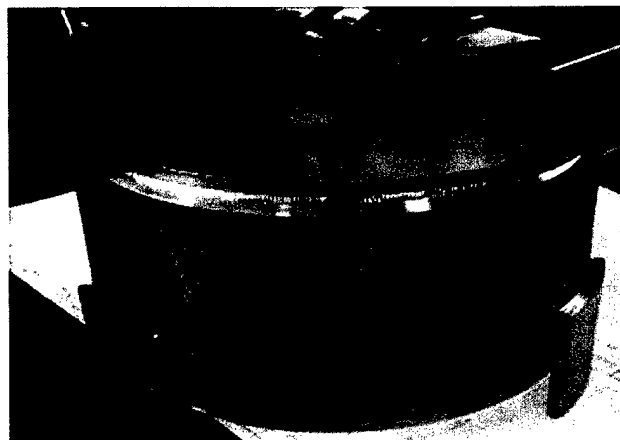

Fig. A-4 – Full-Scale Bonded Platinum Liner Test Article

metallographic and bend analyses to be performed. As with the small-scale test coupons, metallographic analyses showed a uniform bond, and the bend tests showed no signs of delamination or tearing. This test article was then subjected to the same thermal cycling as described above for the test coupons. Again, following completion of the thermal cycling, the test article was metallographically examined, and no changes from the as-bonded condition were observed.

During conduct of the EST, corrosion of the lower end of the C-276 support sleeve was observed. Additional protection of this area has been provided in the bonded removable liner design through the addition of a platinum “wrap-around.” As shown in Figs. A-5 and A-6, platinum protection is provided along the entire inner diameter of the liner, the extreme bottom, and up the back side of the platinum for 8–10 inches, where some process fluid may at times be present. The fabrication methodology for this wrap-around design has also been demonstrated in a full-scale diameter test specimen (10.2 inches).

A-3.2 ACWA TESTING

The SCWO feeds of interest to the ACWA program include agent hydrolysates [mustard, GB, and VX], energetics hydrolysates (explosives and propellants), and size-reduced dunnage (wood, rubber, and plastics). Thus, the range of feeds processed via SCWO in support of the ACWA program was significantly more complex than for the NECDF where only VX hydrolysate required processing.

Separate 500-hour SCWO demonstration tests were performed for each of the five ACWA feeds to confirm the maturity of the SCWO process and the planned operating scenario. The results of the test program are documented in Refs. 7 through 11. Air oxidant was used for all tests. The five target feeds were: (1) mustard hydrolysate (HD), (2) GB hydrolysate (GB), (3) VX hydrolysate (VX), (4) tetrytol hydrolysate/shredded dunnage (TD), and (5) M28 propellant hydrolysate/shredded dunnage (MD). Prior to the start of each of these demonstration tests,

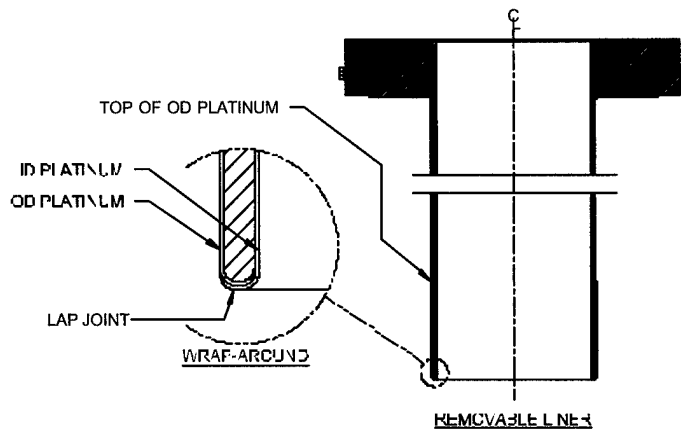

Fig. A-5 – Bonded Platinum Removable Wrap-Around Liner Design

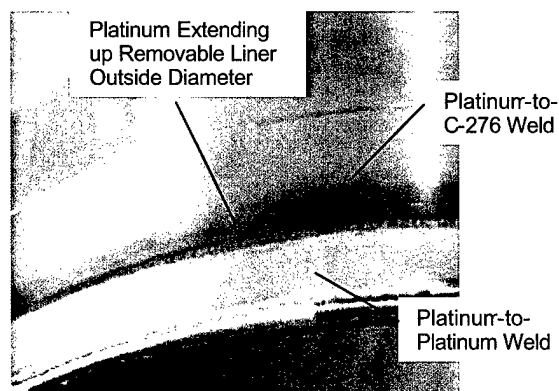

Fig. A-6 – Platinum Test Article

significant workup and systemization testing was performed to ensure that the SCWO equipment and procedures were ready. In total, approximately 6000 hours of SCWO testing was performed in support of the ACWA program. The ACWA processing scenario incorporated scheduled reactor flushes (about once per day) and liner replacements to ensure continued operability.

The primary goals of the ACWA testing were to achieve complete destruction of all organic species and to achieve a high overall SCWO system availability. Each of these goals was met. In all demonstration testing, regardless of feed type, the total organic carbon (TOC) in the effluent, the primary gauge of organic destruction, was less than the allowable 10 ppm. Typically, TOC concentrations were less than the detection limit of 1 ppm. Reactor flushing and occasional sacrificial liner replacement were routine and typically required only a few hours time. The overall SCWO system availability for the total of 1700 hr of agent hydrolysate processing (including a 200-hour test jointly sponsored by PMATA and ACWA) was 80.7% (see Fig. A-7). Including the 1000 hours of energetics hydrolysate/dunnage demonstration testing, the availability over the 2700 hours of demonstration testing averaged 77.9%.

A-3.3 JOINT PMATA/PMACWA TESTING

The GA ACWA program originally planned to perform four 500-hour tests to establish a database for all feed types except VX hydrolysate. The VX hydrolysate data were expected to come from the EST but that data fell short of expectations. At the end of the originally planned ACWA tests, PMACWA and PMATA jointly funded additional VX hydrolysate testing in the ACWA test unit. The testing focused on validation of a liner material as a backup to platinum. Workup testing showed titanium to be unacceptable, but resolved the problems with C-276 initially observed during the EST. The results of the test program are documented in Refs. 12 and 13.

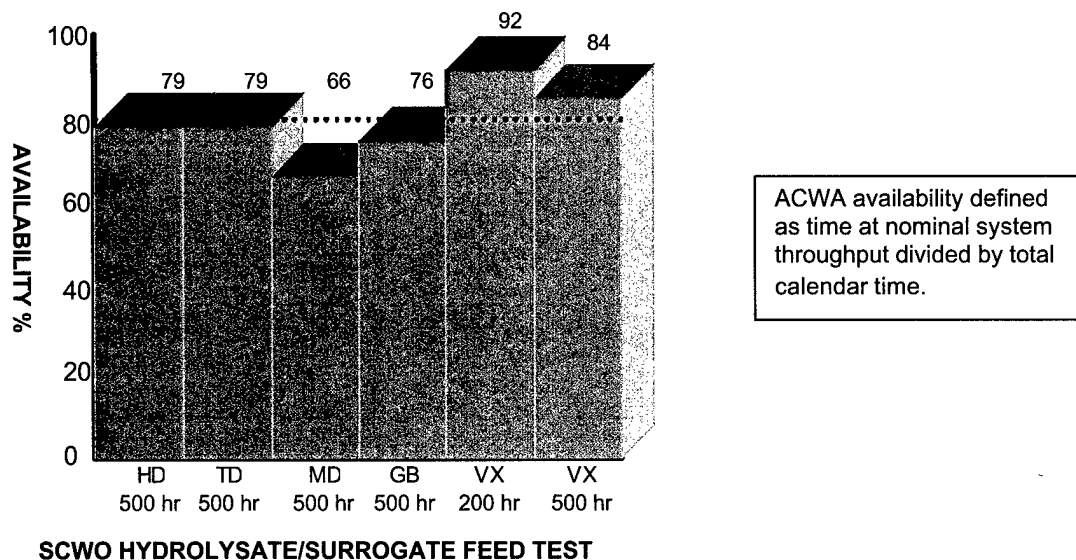

Fig. A-7 – High Availabilities Achieved During ACWA Demonstration Testing

Testing showed that salts/corrosion product transport in the ACWA system with a C-276 liner was significantly better than that observed during the prior EST testing, although the observed overall corrosion rate was essentially the same (~0.2–0.4 mil/hr). Further investigation identified several process improvements that contributed to the favorable results. Earlier ACWA testing had determined that the combination of an improved quench design and a lower quench temperature significantly improved salts/corrosion product transport from the reactor. This combination of conditions was used in an ~200-hour VX hydrolysate demonstration test using PMATA protocols. In this test, a SCWO system overall availability of 92% was achieved. As a result, C-276 was validated as a viable backup liner material of construction for the NECDF; and C-276 was selected as the primary liner material for the ACWA 500-hour VX hydrolysate demonstration test, which subsequently achieved an overall SCWO system availability of 84%. This joint test effort validated C-276 as a viable alternative liner to platinum for VX hydrolysate. The testing also demonstrated that with adequate systemization, SCWO technology could achieve an overall availability of ~80%.

A-4. CONCLUSIONS

Through the additional SCWO testing and development performed by GA in support of ACWA and PMATA, the major issues raised during conduct of the EST have been resolved. The completion of approximately 6,000 hours of ACWA testing provides a firm basis for an overall availability of 80% for GA's SCWO systems. The development of a bonded platinum liner has eliminated the platinum liner failure mechanism that led to the deformation of the EST liner. The identification of C-276 as a viable alternative to the platinum liner further reduces risk associated with the reactor liner.

A-5. REFERENCES

1. "Using Supercritical Water Oxidation to Treat Hydrolysate from VX Neutralization," National Research Council Committee on Review and Evaluation of the Army Chemical Stockpile Disposal Program, 1998.
2. "Test Report: Treatability Study – Supercritical Water Oxidation of VX Hydrolysate," General Atomics Doc. No. 229003, Revision N/C, September 1996.
3. "Test Report – Confirmatory Testing Using Supercritical Water Oxidation to Destroy VX/NaOH Hydrolysate," General Atomics Doc. No. 499002, Revision N/C, April 1997.
4. "Engineering Scale Test of Supercritical Water Oxidation of VX/NaOH," prepared by Stone & Webster Engineering Corporation for the Program Manager for Alternate Technologies and Approaches, Doc. No. R07V-04, March 2001.
5. "Hot Isostatic Pressing Platinum Bonding Test," General Atomics Doc. No. 049040, Revision N/C, December 2001.
6. "Hot Isostatic Pressing (HIP) Platinum Bonding Test Follow-up Work," General Atomics Memorandum No. 30043:475:PNC:02, May 9, 2002.
7. "Engineering Design Studies Interim Test Report," General Atomics Doc. No. GA-C23626, October 2001.
8. "Engineering Design Studies Interim Test Report, Supercritical Water Oxidation of Tetrytol Hydrolysate/Dunnage Slurry," General Atomics Doc. No. GA-C23787, August 2001.
9. "Engineering Design Studies Interim Test Report, Supercritical Water Oxidation of M28 Hydrolysate/Cyclotol Hydrolysate/Dunnage Slurry," General Atomics Doc. No. GA-C23825, September 2001.
10. "Engineering Design Studies Interim Test Report, Supercritical Water Oxidation of GB Hydrolysate and GB Hydrolysate Simulant," General Atomics Doc. No. GA-C23868, November 2001.
11. "Engineering Design Studies Interim Test Report, Supercritical Water Oxidation of VX Hydrolysate Simulant," General Atomics Doc. No. GA-C23888, December 2001.
12. "Supercritical Water Oxidation (SCWO Back-Up Liner Testing)," prepared by Parsons in support of the Program Manager for Alternative Technologies and Approaches, November 2001.
13. "Engineering Design Studies Draft Interim Test Report, Supercritical Water Oxidation of VX Hydrolysate Simulant: Workup and Corrosion Tests," General Atomics Doc. No. GA-C23893, November 2001.
14. "Speedy New SCWO for NECDF," GA Proposal No. GACP 113-133, November 2001.