

NAVAL POSTGRADUATE SCHOOL Monterey, California



THESIS

**PERFORMANCE EVALUATION OF
VOICE OVER INTERNET PROTOCOL**

by

Chaiporn Dechjaroen

December 2002

Thesis Advisor:
Second Reader:

Geoffrey Xie
Burt Lundy

Approved for public release; distribution is unlimited.

THIS PAGE INTENTIONALLY LEFT BLANK

REPORT DOCUMENTATION PAGE			<i>Form Approved OMB No. 0704-0188</i>	
Public reporting burden for this collection of information is estimated to average 1 hour per response, including the time for reviewing instruction, searching existing data sources, gathering and maintaining the data needed, and completing and reviewing the collection of information. Send comments regarding this burden estimate or any other aspect of this collection of information, including suggestions for reducing this burden, to Washington headquarters Services, Directorate for Information Operations and Reports, 1215 Jefferson Davis Highway, Suite 1204, Arlington, VA 22202-4302, and to the Office of Management and Budget, Paperwork Reduction Project (0704-0188) Washington DC 20503.				
1. AGENCY USE ONLY (Leave blank)		2. REPORT DATE December 2002	3. REPORT TYPE AND DATES COVERED Master's Thesis	
4. TITLE AND SUBTITLE: Performance Evaluation of Voice over Internet Protocol			5. FUNDING NUMBERS	
6. AUTHOR(S) Chaiporn Dechjaroen				
7. PERFORMING ORGANIZATION NAME(S) AND ADDRESS(ES) Naval Postgraduate School Monterey, CA 93943-5000			8. PERFORMING ORGANIZATION REPORT NUMBER	
9. SPONSORING /MONITORING AGENCY NAME(S) AND ADDRESS(ES) N/A			10. SPONSORING/MONITORING AGENCY REPORT NUMBER	
11. SUPPLEMENTARY NOTES The views expressed in this thesis are those of the author and do not reflect the official policy or position of the Department of Defense or the U.S. Government.				
12a. DISTRIBUTION / AVAILABILITY STATEMENT Approved for public release; distribution is unlimited.			12b. DISTRIBUTION CODE	
13. ABSTRACT Voice over Internet Protocol (VoIP) was developed to emulate toll services with lower communication cost. In VoIP applications, voices are digitized and packetized into small blocks. These voice blocks are encapsulated in a sequence of voice packets using the Real-time Transport Protocol (RTP) and delivered by the User Datagram Protocol (UDP). To help VoIP applications deal with unpredictable network performance, the Real-time Transport Control Protocol (RTCP) is developed to monitor the performance of RTP packets and provide feedback to the VoIP applications. The feedback on packet delay, jitter, and loss rate enables the applications to adapt to network conditions to maintain a certain level of voice quality. With this architecture, the quality of service of VoIP relies on the effectiveness of the RTCP network performance report mechanism. This research collects RTCP performance reports from live traffic over real networks and compares their values with the statistics derived from direct measurements of RTP packets to evaluate the effectiveness of RTCP. The live experiments were conducted on networks resembling respectively, Local Area Network (LAN), Wide Area Network (WAN), campus network, and encrypted wireless LAN. Results from these experiments show that RTCP is effective for low delay networks but RTCP performance reports can be inaccurate for networks with large, volatile delays.				
14. SUBJECT TERMS VoIP, RTCP, MOS, Telephony, Performance Evaluation			15. NUMBER OF PAGES 97	
			16. PRICE CODE	
17. SECURITY CLASSIFICATION OF REPORT Unclassified	18. SECURITY CLASSIFICATION OF THIS PAGE Unclassified	19. SECURITY CLASSIFICATION OF ABSTRACT Unclassified	20. LIMITATION OF ABSTRACT UL	

THIS PAGE INTENTIONALLY LEFT BLANK

Approved for public released; distribution is unlimited.

**PERFORMANCE EVALUATION OF
VOICE OVER INTERNET PROTOCOL**

Chaiporn Dechjaroen
Major, Royal Thai Army
B.S., Chulachomklao Royal Military Academy, Thailand, 1993
M.S., University of Illinois, 1996

Submitted in partial fulfillment of the
requirements for the degree of

MASTER OF SCIENCE IN COMPUTER SCIENCE

from the

**NAVAL POSTGRADUATE SCHOOL
December 2002**

Author: Chaiporn Dechjaroen

Approved by: Geoffrey Xie
Thesis Advisor

Burt Lundy
Second Reader

Peter J. Denning
Chairman, Department of Computer Science

THIS PAGE INTENTIONALLY LEFT BLANK

ABSTRACT

Voice over Internet Protocol (VoIP) was developed to emulate toll services with lower communication cost. In VoIP applications, voices are digitized and packetized into small blocks. These voice blocks are encapsulated in a sequence of voice packets using the Real-time Transport Protocol (RTP) and delivered by the User Datagram Protocol (UDP). To help VoIP applications deal with unpredictable network performance, the Real-time Transport Control Protocol (RTCP) is developed to monitor the performance of RTP packets and provide feedback to the VoIP applications. The feedback on packet delay, jitter, and loss rate enables the applications to adapt to network conditions to maintain a certain level of voice quality. With this architecture, the quality of service of VoIP relies on the effectiveness of the RTCP network performance report mechanism.

This research collects RTCP performance reports from live traffic over real networks and compares their values with the statistics derived from direct measurements of RTP packets to evaluate the effectiveness of RTCP. The live experiments were conducted on networks resembling respectively, Local Area Network (LAN), Wide Area Network (WAN), campus network, and encrypted wireless LAN. Results from these experiments show that RTCP is effective for low delay networks but RTCP performance reports can be inaccurate for networks with large, volatile delays.

THIS PAGE INTENTIONALLY LEFT BLANK

TABLE OF CONTENTS

I.	INTRODUCTION.....	1
A.	INTERNET TELEPHONY BACKGROUND	1
B.	TELEPHONY AND VOIP.....	2
C.	IP TELEPHONY APPLICATIONS	3
D.	QUALITY OF SERVICE.....	3
E.	RESEARCH ON VOIP PERFORMANCE ANALYSIS.....	4
F.	SCOPE OF THIS THESIS.....	4
G.	THESIS ORGANIZATION	5
II.	IP TELEPHONY OVERVIEW.....	7
A.	TELEPHONY STANDARDIZATION	7
B.	H.323.....	7
C.	H.323 COMPONENTS	8
1.	Terminal.....	8
2.	Gateway.....	9
3.	Gatekeeper.....	10
4.	Multipoint Control Unit (MCU)	10
D.	H.323 SPECIFICATION	10
1.	Audio Codec.....	10
2.	Video Codec.....	11
3.	H.225 Registration, Admission, and Status (RAS).....	11
4.	H.225 Call Signaling	11
5.	H.245 Control Signaling	11
E.	PROTOCOL STACK.....	11
F.	CALL SEQUENCE	12
G.	VOIP IMPLEMENTATION	13
III.	VOIP ARCHITECTURE.....	15
A.	BASIC VOICE FLOW.....	15
B.	VOICE COMPRESSION	16
C.	VOICE PACKET FORMAT	17
D.	REAL-TIME TRANSPORT PROTOCOL (RTP).....	17
E.	REAL-TIME TRANSPORT CONTROL PROTOCOL (RTCP)	19
F.	RTP AND RTCP PORT NUMBER	22
G.	TRANSMISSION PRIORITY.....	22
H.	ERROR CONTROL TECHNIQUE	24
1.	Automatic Repeat reQuest (ARQ).....	24
2.	Forward Error Correction (FEC).....	24
IV.	VOIP PERFORMANCE	25
A.	VOICE QUALITY.....	25
B.	DELAY.....	27
1.	Coder or Processing Delay	28

2.	Algorithmic Delay	29
3.	Packetization or Accumulation Delay	30
4.	Serialization Delay	31
5.	Queuing/Buffering Delay.....	31
6.	Network Switching Delay	32
C.	CLARITY	32
1.	Packet Loss	32
2.	Jitter	33
3.	Codec.....	34
4.	Noise	34
5.	Voice Activity Detector.....	34
6.	Environment	35
D.	ECHO	35
E.	PERFORMANCE CONTROL MECHANISM.....	36
1.	Congestion.....	36
2.	Packet Residency	36
3.	Bandwidth Consumption.....	36
4.	WAN Traffic Inconsistency.....	36
V.	PERFORMANCE MEASUREMENT	37
A.	VQ MEASUREMENT.....	37
1.	Measuring Clarity	37
2.	Measuring Delay	38
3.	Measuring Echo	38
B.	MEASUREMENT METHODS	39
1.	Measurement with Virtual Voice	39
a.	<i>Model Simulation.....</i>	40
b.	<i>Direct Measurement.....</i>	40
c.	<i>Agent-based Measurement</i>	40
2.	Measurement with actual voice	41
a.	<i>Pre-recorded Voice.....</i>	41
b.	<i>Live Conversation.....</i>	42
3.	Comparison of Performance Measurement Methods	42
C.	MEASUREMENT OF DELAY.....	43
1.	RTCP Time Information.....	43
2.	Clock Synchronization.....	44
3.	Sampling Delay.....	44
4.	Per-packet Delay	46
D.	MEASUREMENT OF JITTER.....	48
E.	MEASUREMENT OF PACKET LOSS	50
F.	MEAN OPINION SCORE	50
G.	E-MODEL.....	51
1.	R-Value	52
2.	Mapping Objective Score to Subjective Score	52
H.	PREVIOUS RESEARCHES ON MOS AND E-MODEL	53
1.	Codec.....	54

2.	Packet Loss	54
3.	Delay.....	55
4.	Combination of All Factors	55
VI.	EXPERIMENT DESIGN	59
A.	TEST MATRIX.....	59
B.	TOOLS USED	60
C.	TEST DESCRIPTION.....	60
D.	OVERALL TEST SCHEMA.....	62
E.	WAN TEST CONFIGURATION.....	63
1.	WAN Test.....	63
2.	NPS Firewall Issues.....	64
3.	Test Configuration.....	64
F.	DATA ANALYSIS METHOD	66
VII.	TEST RESULTS	67
A.	TEST RECORD	67
B.	TEST SUMMARY	67
C.	LAN TEST.....	67
D.	CAMPUS TEST	71
E.	WAN TEST.....	74
F.	WIRELESS TEST	78
G.	MOS RESULT	79
VIII.	DATA ANALYSIS	81
A.	GENERAL.....	81
B.	CLOCK.....	81
C.	LAN TEST.....	82
D.	CAMPUS TEST	82
E.	WAN TEST.....	82
F.	WIRELESS TEST	84
G.	MOS.....	84
H.	RATIO OF RTP AND RTCP PACKETS	85
IX.	SUMMARY.....	87
A.	TEST SUMMARY	87
B.	FUTURE WORK	87
	GLOSSARY.....	89
	LIST OF REFERENCES	91
	BIBLIOGRAPHY	95
	INITIAL DISTRIBUTION LIST	97

THIS PAGE INTENTIONALLY LEFT BLANK

LIST OF FIGURES

Figure 1.	H.323 Terminals on Packet Network. (From: Ref 8).....	8
Figure 2.	H.323 Components (From: Ref 8)	9
Figure 3.	Gateway (From: Ref 8).....	9
Figure 4.	H.323 interoperates with other H.32X Networks (From: Ref 8)	10
Figure 5.	H.323 Call Sequence (From: Ref 9)	12
Figure 6.	Branch Office Application (From : Ref 10).....	13
Figure 7.	Interoffice Trunking Application (From: Ref 10).....	14
Figure 8.	Cellular Network Interoperability (From: Ref 10).....	14
Figure 9.	Voice Flow (From: Ref 11).....	15
Figure 10.	Codec Function in Router (From: Ref 11).....	15
Figure 11.	Codec Function in PBX (From: Ref 11)	15
Figure 12.	Voice Packet	17
Figure 13.	RTP Packet.....	18
Figure 14.	RTCP Sender Report.....	20
Figure 15.	RTCP Receiver Report.....	20
Figure 16.	Layer 2 Priority Setting (From: Ref 14)	23
Figure 17.	Layer 3 Priority Setting (From: Ref 14)	23
Figure 18.	FEC Data Stream Pattern.....	24
Figure 19.	Relationship of VQ Components (From: Ref 15).....	26
Figure 20.	Delay Effect (From: Ref15)	28
Figure 21.	Voice Compression (From: Ref 11).....	29
Figure 22.	Pipelining Nature (From: Ref 11)	31
Figure 23.	De-jitter Buffer Operation (From: Ref 11)	33
Figure 24.	VAD Behavior (From: Ref 15)	34
Figure 25.	Relationship between Echo Level, Delay, and Perception (From: Ref15)	35
Figure 26.	RTP and NTP Timestamp	44
Figure 27.	DLSR and Roundtrip Time	45
Figure 28.	Clock Drift and Time Recorded.....	47
Figure 29.	Jitter Calculation.....	49
Figure 30.	Mapping of R-value to MOS (From: Ref 28)	53
Figure 31.	R-value and MOS with User Satisfaction (From: Ref 28).....	53
Figure 32.	R-value as Function of Consecutive Loss (From: Ref 31)	54
Figure 33.	R-value as Function of One-way Delay (From: Ref 31).....	55
Figure 34.	R-values as Function of Delay and Packet Loss (From: Ref 31).....	56
Figure 35.	R-values as Function of Delay and Codec (From: Ref 31).....	56
Figure 36.	R-values as Function of Delay and Echo (From: Ref 32).....	57
Figure 37.	Test Schema	62
Figure 38.	WAN Test Schema	63
Figure 39.	LAN Test Result (1).....	68
Figure 40.	LAN Test Result (2).....	68
Figure 41.	LAN Test Result (3).....	69

Figure 42.	LAN Test Result (4).....	69
Figure 43.	LAN Test Result (5).....	70
Figure 44.	LAN Test Result (6).....	70
Figure 45.	Campus Test Result (1).....	71
Figure 46.	Campus Test Result (2).....	72
Figure 47.	Campus Test Result (3).....	72
Figure 48.	Campus Test Result (4).....	73
Figure 49.	Campus Test Result (5).....	73
Figure 50.	WAN Test Result (1)	74
Figure 51.	WAN Test Result (2)	75
Figure 52.	WAN Test Result (3)	75
Figure 53.	WAN Test Result (4)	76
Figure 54.	WAN Test Result (5)	76
Figure 55.	WAN Test Result (6)	77
Figure 56.	WAN Test Result (7)	77
Figure 57.	Wireless Test Result (1).....	78
Figure 58.	Wireless Test Result (2).....	78
Figure 59.	RTCP Consistency	83
Figure 60.	RTCP Accuracy	84

LIST OF TABLES

Table 1.	Codec Comparison.....	17
Table 2.	VoIP Packet Priority Classification (After: Ref 14)	23
Table 3.	VQ Components (From: Ref 15)	26
Table 4.	Delay Specifications (From: Ref 11)	28
Table 5.	Coder or Processing Delay (After: Ref 11).....	29
Table 6.	Algorithmic Delay (From: Ref 11)	30
Table 7.	Packetization Delay.....	30
Table 8.	Serialization Delay.....	31
Table 9.	Comparison of VoIP Performance Measurement	42
Table 10.	Mean Opinion Score	51
Table 11.	Codecs' MOS and R-Value (After: Ref 30)	54
Table 12.	Network Ports used by NetMeeting (After: Ref 33).....	64
Table 13.	Test MOS	79

THIS PAGE INTENTIONALLY LEFT BLANK

ACKNOWLEDGMENTS

I would like to appreciate Professor Geoffrey Xie for his advice and all equipments used in this research. I also thank the following students in the SAAM research group for helping me conduct the tests: Valter Monterio and Matt Braun. Finally, I appreciate the assist from the Casanova Team to allow me to perform a test with the Linux server: Phuwadol Udomsilp, Thoetsak Jaiaree, and Seksrit Siripala.

THIS PAGE INTENTIONALLY LEFT BLANK

I. INTRODUCTION

During the last half decade, the computer communication business has been in an era of a technological revolution. Numerous new network applications were invented as a result of the explosive growth of the Internet, especially those designed based on the Internet Protocol (IP). The vast popularity of the Internet causes the total volume of packet-based network traffic to exceed that of the traditional, circuit-switched voice traffic [Ref 1]. To take advantage of the more efficient packet-switching technology, the service providers have also been developing products to provide voice transmission service over data networks like the Internet.

A. INTERNET TELEPHONY BACKGROUND

The first IP Telephony software was introduced in 1995. VocalTec Inc. [Ref. 2] launched its multimedia PC-based product, the Internet Phone, to allow users to speak into PC microphones and listen on PC speakers. It was a significant development in computer technology to transport voice over packet networks. The PC-to-PC Internet Phone software worked very well.

After entering the market, IP telephony has rapidly attracted global attention. This technology has been improved to make the inter-networking conversation process easier with better quality. Many Information Technology (IT) and telecommunication companies have developed their own products to participate in this new market. With the ability of these products to send all voice data over packet switching networks, a new era of low-cost long distance voice communication has been started.

In 1996, the first IP telephony gateway was produced [Ref.2]. The emergence of gateway servers was the key to bringing IP telephony to widespread uses. These gateways act as an interface between Public Switching Telephone Networks (PSTN) and the Internet. They facilitate the integration of the two types of networks, allowing voice and data to travel on the same path of an integrated network. With the gateways, the users can use standard phones for IP telephony. Other components that were developed are gatekeepers, voice servers, trunking networks, and billing managers. Nowadays, numerous IP telephony-related products are available in the marketplace.

Since IP telephony is in its infancy with a lot of room to grow, it is expected to have an amazing future. According to an Allied Business Intelligence study in 2001, the industry value of world telephony networks will be tripled by 2006 [Ref 3]. Voice communication is expected to have a tremendous market size. The estimated global voice market was already approximately 600 billion US dollars in 2000 [Ref 4]. The key consideration is that VoIP is approximately 27 times cheaper than PSTN service [Ref 4]. Most service providers and large organizations move into VoIP to realize the cost benefit and the opportunity for deployment of multimedia applications that integrate audio, video and data. This integration cannot be offered by PSTN as efficiently. Some industry analysts estimate that VoIP represents roughly 13 percent of the global voice traffic for 2002. This echoes a Department of Commerce report which puts the VoIP global market scale at \$63 billion [Ref 4].

Even though the market is heading towards the implementation of IP telephony, this technology has not achieved the same quality criteria as the regular telephony. Many problems in the areas of interoperability and standardization still exist. Thus, IP telephony has a long journey before it reaches maturity.

B. TELEPHONY AND VOIP

The previously mentioned terminology “IP Telephony” sometimes is called “Internet Telephony” because it can be deployed on the Internet by using IP protocol stack. Most people use these terms interchangeably with “VoIP”, short for Voice over Internet Protocol. However, their underlying technologies are not exactly the same. They can be operated in different types of networks and provided at different service levels.

Internet Telephony consists of three types of voice services operated over the public Internet: PC-to-PC, PC-to-Phone, and Phone-to-Phone. Telephony can integrate other multimedia modes such as video and data into the specific applications. The protocol, VoIP, is mentioned most frequently when the voice traffic is communicated over managed intranet and extranets of enterprises, and from these enterprise networks to the Internet as quality of service improves [Ref 5]. Based on these slightly different definitions, VoIP seems to provide the better voice quality since it is typically deployed on a dedicated and controllable network. However, both terms are currently used interchangeably in general academic papers.

C. IP TELEPHONY APPLICATIONS

With the ability to converge voice network and data network to form a single multimedia network, VoIP technology minimizes the distinction between voice and data transfer. This technology is designed to run on many networks but the IP-based networks, especially the Internet, are quite popular for most applications. Today VoIP has become an accepted and proven technical solution for voice transmission in the commercial environment. The ability to integrate voice, fax, and data into a single communication pipeline offers a tremendous opportunity for most organizations to reduce their communication expenses. Moreover, the integration of voice and data allows users to talk and control multimedia applications, i.e., exchanging data and images in the same session.

In the current market, there are many telephony applications for business enterprises. It can be used to automate the access to information and process the applications, e.g., audio-text, fax on demand, interactive voice response, interactive fax response, and simultaneous voice and data. Moreover, telephony can increase the efficiency of customer service in a message handling system, e.g., voice mail, fax server, paging, unified messaging, and email reader.

Telephony can also automate the connection services among business entities. These applications include contact center and help desk automation, call back services, operator services, conferencing, telemarketing, and predictive/auto dialing. The interesting products used in telephone companies consist of cellular telephony, voice dialing, directory assistance, reverse yellow pages, payphone message forwarding, fax mailbox, line conversion, and alternate operator services. These products can also be adapted for uses in military applications.

D. QUALITY OF SERVICE

Network administrators face a new challenge with VoIP because they need to deploy and manage a solution to find and allocate network capacity to VoIP applications. Some of the networks that VoIP can be deployed are broadband, WAN, Intranet, Internet, and even wireless networks. Currently, due to congestions caused by heavy contentions for the Internet bandwidth, the benefit of VoIP on public networks is not fully realized as in a corporate network. Some performance degradation can be expected especially during

a network congestion period. However, this cost-free communication is still gaining popularity.

In VoIP applications, voices are digitized by voice-processing cards and encoded into a bit stream format. Voice data then are wrapped up into a sequence of packets using the Real-time Transport Protocol (RTP) and delivered using the User Datagram Protocol (UDP) in the transport layer. Each voice packet is routed through the network using IP until it reaches the destination terminal. The terminal detects voice packets, decodes the bit stream into waveforms, and sends the waveforms to the speakers or other devices.

With this architecture, the QoS of a VoIP application therefore largely depends on the quality of the underlying network service. In particular, network congestions may cause large packet delays and a high packet loss rate, resulting in voice distortion, such as error voice tone, clipping speech, and artificial silence gap.

E. RESEARCH ON VOIP PERFORMANCE ANALYSIS

The early research on VoIP focused on the development of a protocol architecture to integrate with PSTN and mobile/cellular networks, and interoperability between different vendors and QoS capabilities. Many VoIP quality studies were to test voice models on network simulators while others used simulated voice on an actual network. However, not much research has been done with real data collected from public data networks.

The performance results of VoIP on existing data networks were compared with voice quality on circuit-switched system to determine the feasibility of voice application development for those networks.

F. SCOPE OF THIS THESIS

This thesis measures and evaluates the performance of the Real-time Transport Control Protocol (RTCP), which is used to control VoIP applications on public data networks. Microsoft NetMeeting is used in this experiment to generate voice traffic. Tests are conducted on the NPS campus network and the public Internet.

Moreover, this research discusses the suitability of the NPS backbone for VoIP deployment, which may be considered in the future to reduce communication cost and

promote multimedia communication in an academic environment. A VoIP performance measurement on a local Ethernet is used as the baseline for performance comparison.

Furthermore, this research evaluates the delay effect of data encryption when VoIP is used on laptops via a mobile network. The Wired Equivalent Privacy (WEP) option of IEEE 802.11 is used in the study.

In all tests, public-domain tools such as Ethereal and WinPCap are used to capture voice packets. Performance statistics are calculated and analyzed using Microsoft Excel macros.

G. THESIS ORGANIZATION

This thesis is divided into several chapters.

- Chapter II describes the overview of IP Telephony.
- Chapter III explains the design of voice packet.
- Chapter IV discusses the performance factors
- Chapter V discusses the performance measurement of VoIP.
- Chapter VI explains the experiment.
- Chapter VII illustrates the results of data collection.
- Chapter VIII analyzes the data
- Chapter IX summarizes the results obtained and provides some recommendations for future work.

THIS PAGE INTENTIONALLY LEFT BLANK

II. IP TELEPHONY OVERVIEW

The primary function of IP Telephony is to record and packetize speech into series of voice packets, then transmit them through the networks and release the entire speech to the listener with acceptable delays. This chapter explains the architecture of this technology and the relevant technical standards.

A. TELEPHONY STANDARDIZATION

As previously mentioned, IP telephony technology is still immature. Several organizations are developing their own standards to serve the industry requirements and some vendors are still using their proprietary design. However, most vendors tend to support the approved standards to allow interoperability.

Currently, the first and most commonly-adopted standard of telephony is the International Telecommunication Union - Telecommunication Standardization Sector (ITU-T) Recommendation H.323 [Ref 6]. This standard is designed for multimedia communication systems including voice applications. This standard of telephony, H.323, was originally created in 1996, and the complete standard on version 4 was released in November 2000. The advantages of this standard are that it is now completely open-source with GUI and that it can operate on any operating systems [Ref 7].

A standard developed by the Internet Engineering Task Force (IETF) is the Session Initiation Protocol (SIP). It addresses some drawbacks of H.323. The SIP offers less complexity and provides more flexibility. The latest SIP standard is released in RFC 3261 posted in July, 2002. All new VoIP application designs support H.323 or both H.323 and SIP. As SIP is a relatively new standard, in this chapter, H.323 is presented as the main telephony architecture.

B. H.323

The ITU-T designed H.323 to be part of the H.32X recommendation family [Ref 8], so it can work with other standards for different networks as following:

- H.324 over switched circuit network (SCN) and wireless network
- H.320 over integrated services digital networks (ISDN)

- H.321 and H.310 over broadband ISDN (B-ISDN)
- H.322 over LAN with guaranteed QoS

The H.323 standard specifies the technical requirements - such as components, protocols, and procedures - for packet-based multimedia communication systems, including real-time audio, video, and data communications. It covers all applications deployed on IP-based and IPX-based (Internet packet exchange) networks, i.e., local area networks (LAN), enterprise networks (EN), wide area networks (WAN), metropolitan area networks (MAN), and Internets. The H.323 is designed for different mixes of data types: audio only (IP telephony), audio-video (video-telephony), audio-data, and audio-video-data. This design also supports multipoint multimedia communications.

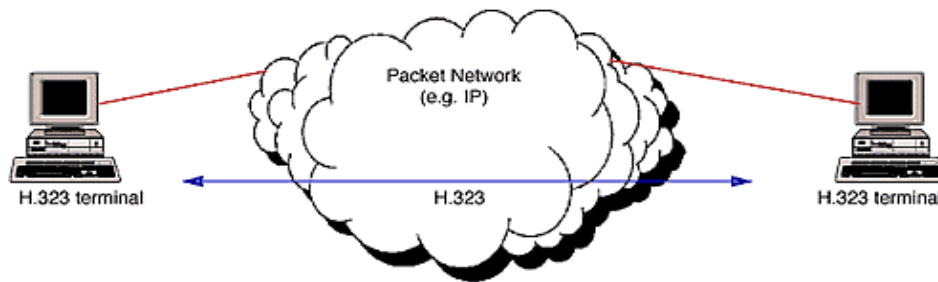

Figure 1. H.323 Terminals on Packet Network. (From: Ref 8)

C. H.323 COMPONENTS

The H.323 incorporates four main components: terminal, gateway, gatekeeper, and a multipoint control unit (MCU) [Ref 8]. Their interaction is illustrated in Figure 2. If all components are located in the same area, with only one gatekeeper, they are considered to be in the same H.323 zone.

1. Terminal

An H.323 terminal can be either a personal computer or any standalone device running an H.323 protocol stack and multimedia applications. The required basic service is audio communications, while video or data service is optional. Since the primary goal of this standard is to interoperate with other multimedia terminals, the H.323 terminal can

talk to all terminals in the H.32X family. The terminal also supports multipoint conferences.

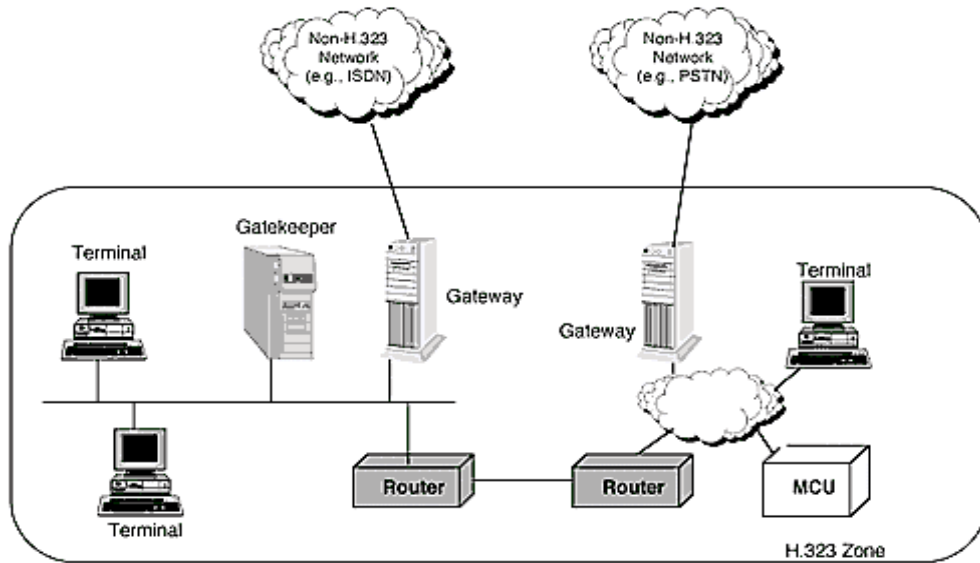

Figure 2. H.323 Components (From: Ref 8)

2. Gateway

To interconnect heterogeneous systems, a gateway is introduced for binding H.323 networks and non-H.323 networks. Normally the gateway is used to link H.323 terminals to PSTN. It also provides translating protocols for call setup and release, converts media format, and transfers information. However, a gateway is not always required within an H.323 region.

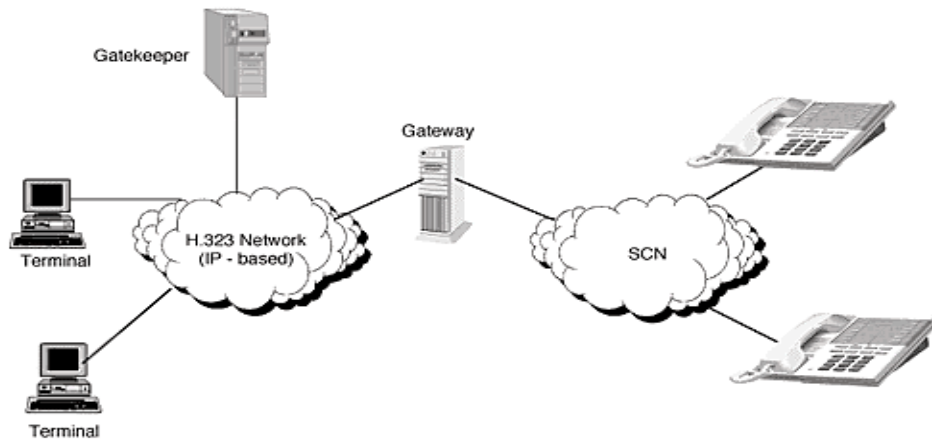

Figure 3. Gateway (From: Ref 8)

3. Gatekeeper

The gatekeeper is designed to be a control center of all calls in an H.323 network. It performs many important tasks such as addressing, authorizing and authenticating of terminals and gateways, bandwidth management, accounting, billing, charging, and call-routing services. A gatekeeper is not required if these services are not needed.

4. Multipoint Control Unit (MCU)

For multi-party communication with at least three terminals, the MCU is required. All terminals connect with the MCU, which serves as a central point of the conference. It checks and manages the conference resources, negotiates between terminals to determine codec type, and handles the media streams.

All four components are logically separate, but they can be implemented on the same device.

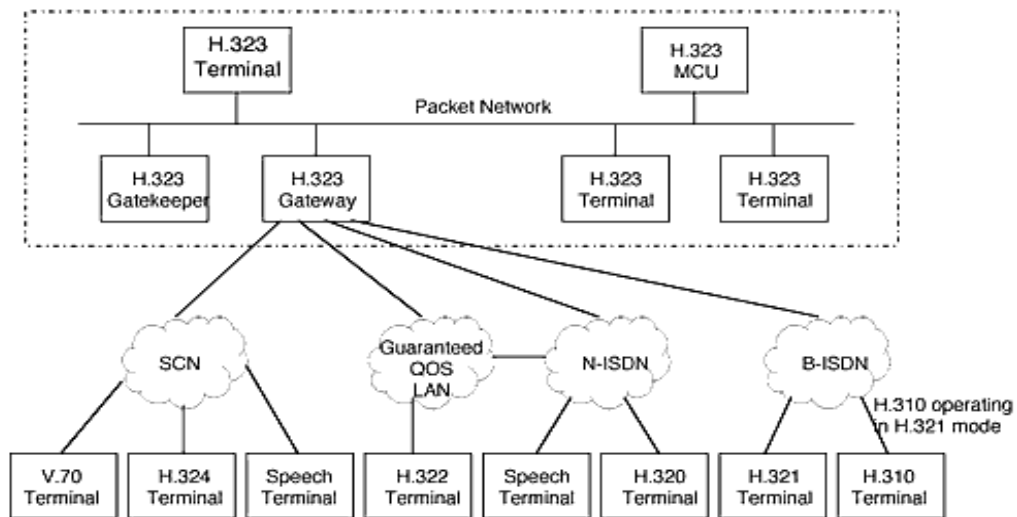

Figure 4. H.323 interoperates with other H.32X Networks (From: Ref 8)

D. H.323 SPECIFICATION

The H.323 recommendation specifies several protocols for multimedia communication processing and controlling. [Ref 8]

1. Audio Codec

The audio codec encodes voice signals from the sender's microphone into packets and at the receiver decodes these packets to reproduce the voice signals for playback by the

receiver's speakers. Each terminal must support at least one default audio codec, G.711. Additional codecs like G.722, G.723.1, G.728, and G.729 may be provided.

2. Video Codec

The video codec encodes video signals from the sender's camera into packets and at the receiver decodes these packets to reproduce the video signals for display on the receiver's monitor. In H.323, this codec is optional. The video codec specification is defined in the H.261 recommendation.

3. H.225 Registration, Admission, and Status (RAS)

In H.225, RAS is used to establish some management functions between endpoints (terminals and gateways). Its responsibilities include registration, admission control, bandwidth change, status, and a disengage procedure between endpoints and gatekeepers. The messages of RAS are exchanged via an RAS channel which is the signaling channel connecting between endpoints.

4. H.225 Call Signaling

A connection between two H.323 endpoints is established by exchanging H.225 messages on the call signaling channel. This channel is opened between an endpoint and the gatekeeper.

5. H.245 Control Signaling

The end-to-end control messages managing the operation of all endpoints are exchanged with H.245 control signaling. The control messages encapsulate the information on capability exchange, logical channel opening and closing, flow control, and command and indication.

E. PROTOCOL STACK

The voice protocol suit is designed to support packet transmission behavior requirement. Since VoIP tries to emulate regular speech communication on PSTN, the interactive communication quality is the key consideration that distinguishes voice from data packet. On a traditional data network, data packets are loss-sensitive and delay-tolerant. On the other hand, voice packets are loss-tolerant and delay-sensitive. As a result, the transport layer in the VoIP protocol stack is implemented with UDP to carry voice instead of TCP. However, TCP is still used to carry signaling messages, such as call establishment and capability exchange.

Moreover, as voice communication requires real-time interactions, RTP is used on top of UDP to deliver end-to-end services. The RTP is designed for real-time applications and to provide payload type identification, sequence numbering, timestamp, and delivery monitoring.

Real-time Transport Control Protocol (RTCP) serves as a control counterpart of the RTP operation. This protocol reports the data distribution quality periodically in the form of sender and receiver reports. The RTP source can also use RTCP to help its receiver synchronize audio and video input.

In addition, Resource reSerVation Protocol (RSVP) is implemented in routing devices to set up and maintain a suitable transmission path for each communication. This can improve the transmission quality by avoiding congested links.

F. CALL SEQUENCE

The ITU incorporates H.323 with its T.120 data-conferencing standard. The call sequence consists of three steps and messages that are delivered over two transport layer protocols. The TCP is first used to setup call establishment with Q.931 and to exchange capability with H.245 messages. Then UDP is used to carry RTP and RTCP payloads after the communication pipeline is opened between the endpoints. The call sequence is illustrated in the following figure.

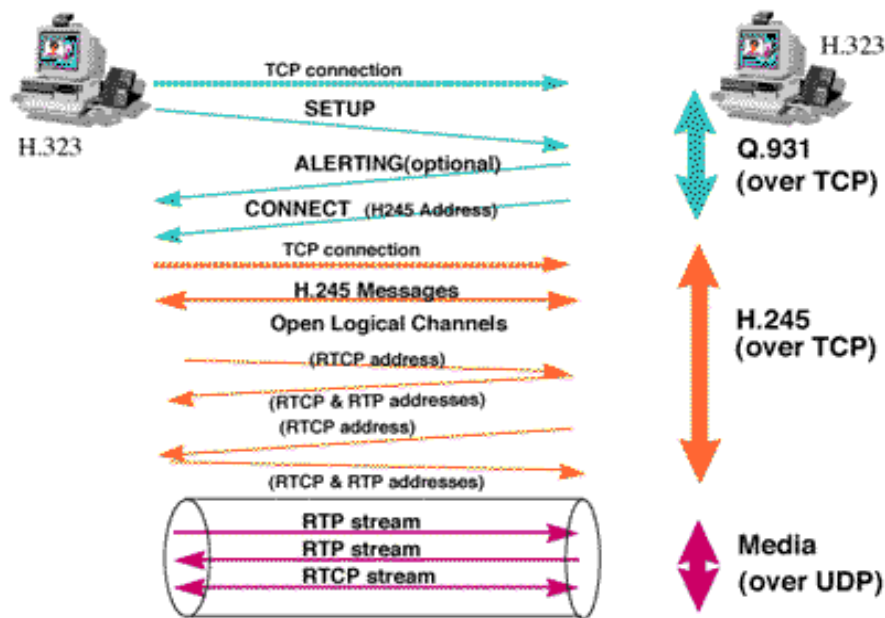

Figure 5. H.323 Call Sequence (From: Ref 9)

G. VOIP IMPLEMENTATION

A wide variety of IP Telephony applications used in the corporate networks is normally called VoIP. Some of these applications are discussed here to give a general idea of how voice packets practically move around corporate units located in different areas. [Ref 10]

The first application is for large companies with many branch offices. The packet network used for standard data transmission is enhanced to carry voice traffic along with data. Voice traffic should be compressed to save bandwidth. The inter-working function (IWF), which is the physical implementation of hardware and software, allows the mixed voice-data traffic to access the packet network. In this case, the IWF must support analog interfaces that directly connect to telephones. The IWF has two responsibilities; it works as a private branch exchange (PBX) at branches and it behaves like a telephony terminal at home office as demonstrated in this architecture.

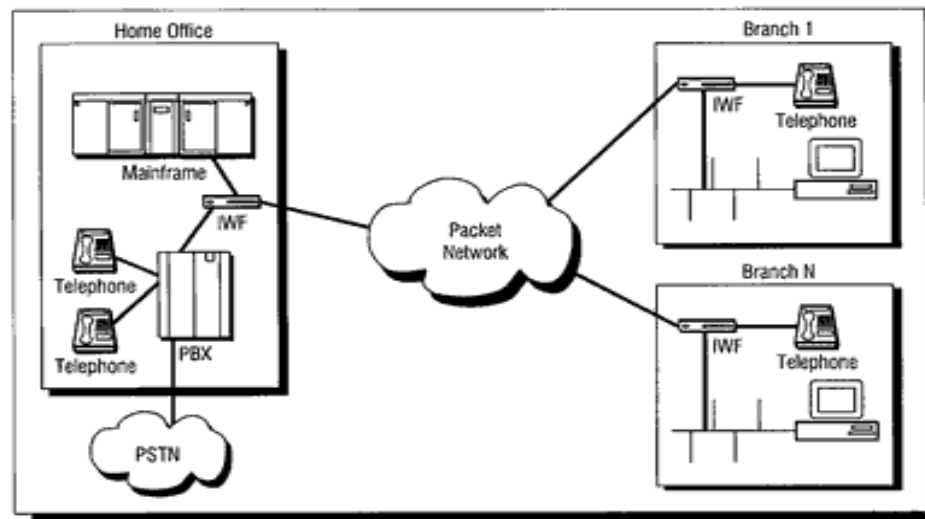

Figure 6. Branch Office Application (From : Ref 10)

The next usage of VoIP is a trunking application. The packet network, installed between remote offices, completely replaces the original telephone lines being used to link the PBXs. Voice and data traffic volume is higher than the branch office scenario; therefore, the IWF must support a larger capacity digital channel, such as T1/E1

interfaces. The IWF also emulates the PBX signaling responsibilities. Figure 7 displays this scenario.

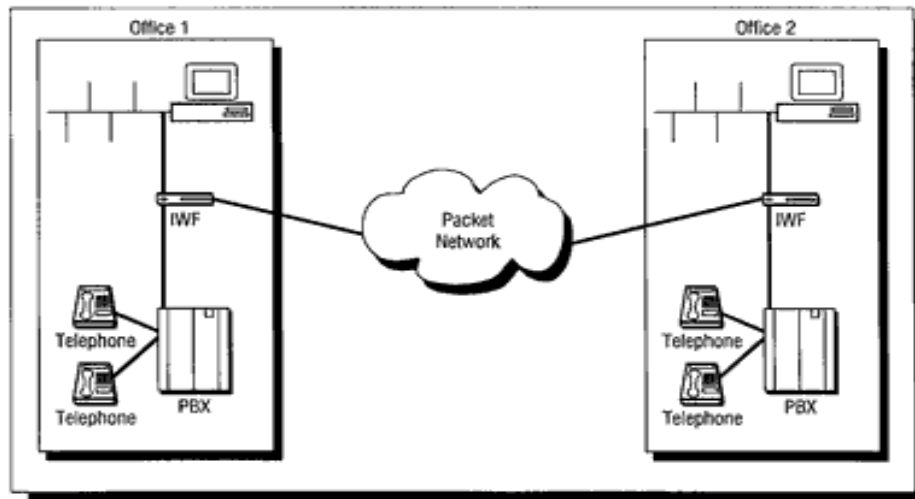

Figure 7. Interoffice Trunking Application (From: Ref 10)

Furthermore, VoIP can interoperate with cellular networks as shown in Figure 8. In a digital cellular network, voice is already compressed and packetized by the cellular phones. The voice network then transmits these packets to destinations. Finally, IWF performs the transcoding to convert the cellular voice data to PSTN voice format.

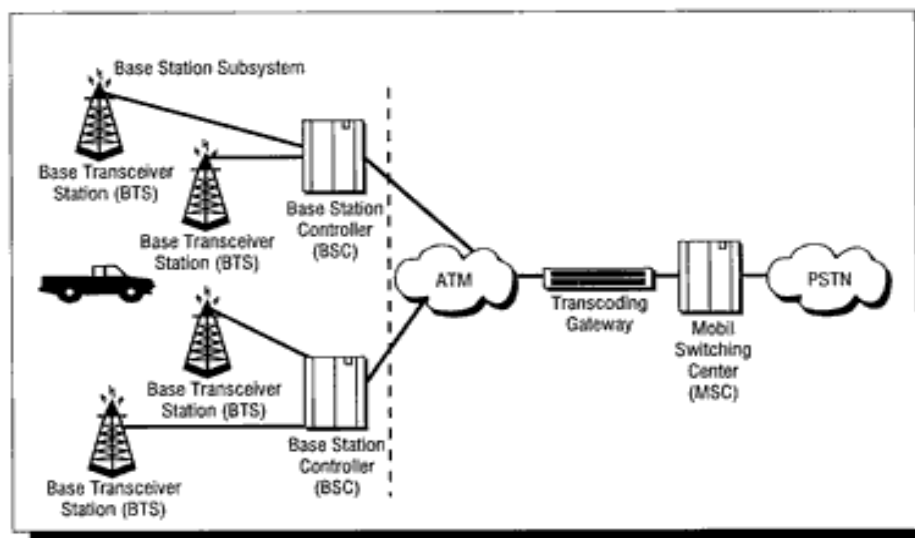

Figure 8. Cellular Network Interoperability (From: Ref 10)

III. VOIP ARCHITECTURE

A. BASIC VOICE FLOW

Based on the current VoIP architecture, voice is digitized using pulse code modulation (PCM) by a voice codec. Then the PCM samples are compressed and packed into IP packets for transmission. The number of samples packed into one packet can be customized. At the receiver side, the samples are decompressed and converted back to analog signal in the reverse order. This flow of voice data is illustrated in Figure 9. [Ref 11]

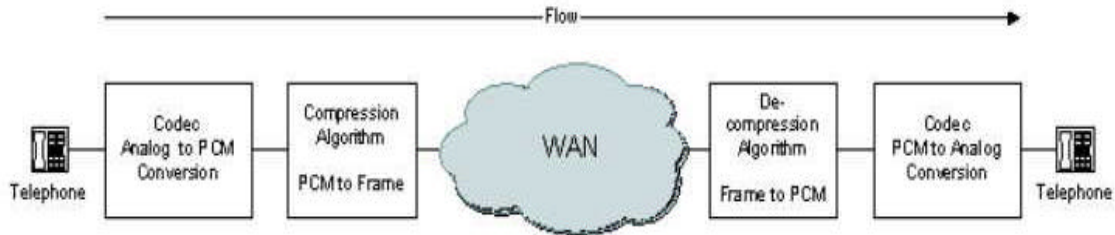

Figure 9. Voice Flow (From: Ref 11)

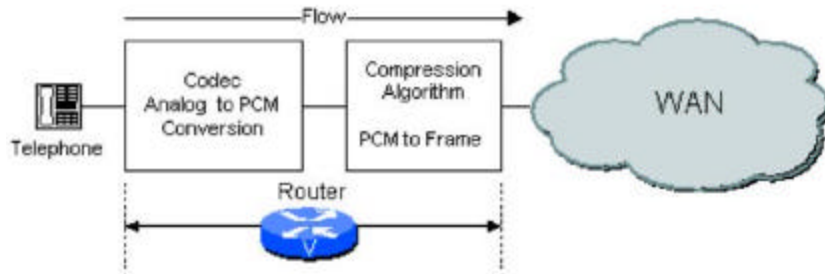

Figure 10. Codec Function in Router (From: Ref 11)

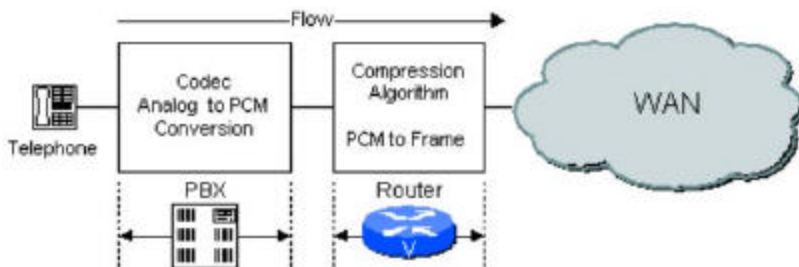

Figure 11. Codec Function in PBX (From: Ref 11)

In an analog voice system without a digital PBX, a router serves as codec and compressor as shown in Figure 10. If a digital PBX is installed, the PBX is responsible for codec function and the router processes only the compressor task as shown in Figure 11.

B. VOICE COMPRESSION

The router can use a variety of compression algorithms depending on the network capacity and application specifics. Some prevailing compression techniques, standardized for telephony and voice packets by ITU-T G.-series, are listed below: [Ref 12]

- G.711 Pulse Code Modulation (PCM)
- G.723.1 Multi Purpose Maximum Likelihood Quantization (MP-MLQ) and Multi Purpose Algebraic Code Excited Linear Prediction (MP-ACELP)
- G.726 Adaptive Differential Pulse Code Modulation (AD-PCM)
- G.728 Low Delay Code Excited Linear Prediction (LD-CELP)
- G.729 Conjugate Structure Code Excited Linear Prediction (CS-ACELP)

The group of voice samples carried in each packet is called a block. The size of each block period is measured by the amount of time it takes to collect all samples for one block. The typical block periods are 10, 20, or 30 milliseconds. Meanwhile, the byte size of each voice block depends on the coding used and varies from 80 to 240 bytes.

The collected voice block in PCM signaling format is sampled at 8 kHz with 8 bits per sample. This results in a data rate of 64 kbps. However, each codec collects voice blocks with different time intervals, so the pre-compressed block size is different. Moreover, each algorithm uses a different compression ratio for different voice quality. This results in a different bandwidth requirement. Table 1 presents the characteristics of each compression technique. The detail of compression characteristic such as block size and block interval is discussed in Chapter 4.

Table 1. Codec Comparison

Coder		Voice Block Size (bytes)	Compression Ratio	Bit Rate (kbps)
G.711		80	1:1	64.0
G.723.1	MP-MLQ	240	10:1	6.3
	MP-ACELP	240	12:1	5.3
G.726		80	2:1	32.0
G.728		80	4:1	16.0
G.729A		80	8:1	8.0

Among various compression algorithms, ITU, in 1995, recommended G.729 for audio codecs. However, in 1997, the VoIP Forum voted to recommend the G.723.1 specification as the industry standard. Moreover, the industry consortium, led by Intel and Microsoft, agreed to use G.723.1. They decided to lower voice quality to gain more bandwidth efficiency (G.723.1 requires 6.3 kbps, while G.729 requires 7.9 kbps) [Ref 9]. Currently G.723.1 is the most adopted codec in VoIP applications.

C. VOICE PACKET FORMAT

After being compressed, voice samples are ready for transmission. They are encapsulated with the RTP header, UDP header, and IP header, before passed down to the link layer. The link layer header size varies according to the media type. The size of a typical IP-UDP-RTP header combo is 40 bytes as shown in the format shown in Figure 12.

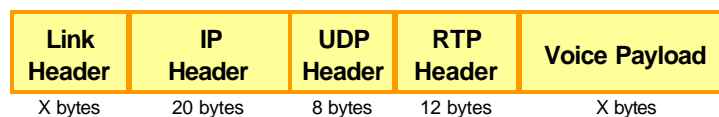
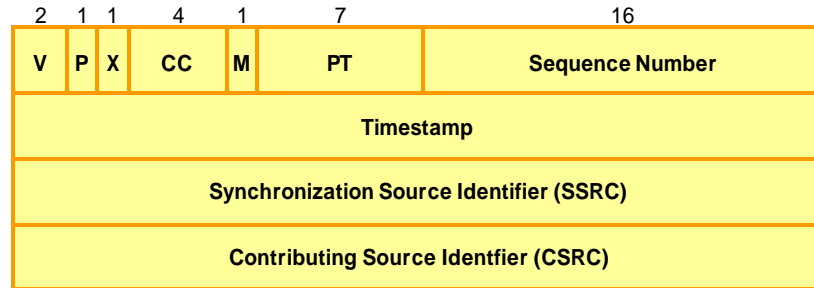

Figure 12. Voice Packet

D. REAL-TIME TRANSPORT PROTOCOL (RTP)

RTP, as defined in RFC 1889 [Ref 13], is designed to support the transport of real-time media over packet networks. According to its intrinsic behavior, some packets can be lost, delayed, and reordered. For loss detection, RTP provides timing information so that the receiver can understand the original voice pattern and correctly handle jitter.

However, RTP does not reserve resources in the network to avoid packet loss and jitter. As a result, RSVP is often used by an RTP application. The RTP packet format is shown in Figure 13.



- V** Version 2
- P** Padding
- X** Extension
- CC** CRSC Count
- M** Marker
- PT** Payload Type (voice, video, compression, etc)

Figure 13. RTP Packet

This packet format is designed for any multimedia payload. In IP telephony application, the following parameters are used:

- “Payload type” identifies the media application (mode) since each mode uses different coding and delay threshold.
- “Sequence number” is initially assigned with a random positive integer value and incremented by one for each RTP data packet sent. Thus this field may be used by the receiver to detect packet loss and reordering in the data stream.
- “Timestamp” represents the sampling instant of the first octet in the RTP data packet. It can be used by the receiver to measure delay and jitter and adaptively determine the playout buffer size. Typically, the RTP timestamp is assigned a random value initially and incremented by one after each sampling period.

- “Synchronized Source ID” (SSRC) is useful when the communication is for a multiparty conference, in which it uniquely represents the persistent indicator of each participant.

E. REAL-TIME TRANSPORT CONTROL PROTOCOL (RTCP)

Also being defined in RFC 1889 [Ref 13], RTCP is a counterpart control protocol of RTP. It provides the network traffic status information to all participants in session. The transmission mechanism of RTCP is different from that of RTP. Since RTP packets are sent out every block interval. For example, An VoIP source using G.723.1 standard sends out voice packets every 30 milliseconds. On the other hand, RTCP packets are sent approximately every 5 seconds. While RTP messages can be sent either unicast or multicast, RTCP messages are sent from each participant (sender or receiver) in the communication session to all other hosts in that particular session. Hosts can recognize each other based on the source identifier (SSRC).

The information provided inside RTCP messages can be used to evaluate the performance of the associated real-time continuous media application because RTCP indirectly reports the quality of service in the network. Each report block is sent with the collective management information, such as the latest sequence number received, the number of missing packets, and jitter. However, RFC 1889 does not specify how to use these values.

The specification of RTCP defines five message types to carry the control information: sender report, receiver report, source description, ending, and application specific function. Two most likely used messages are sender report (SR) and receiver report (RR). The SR message is sent from a transmission source, while RR is sent from a receiver in an RTP session. These two RTCP packet formats are displayed in the Figure 14 and 15.

- “NTP timestamp” represents the local time when the SR message was sent. This timestamp uses the format of the Network Time Protocol (NTP).
- “Sender’s packet count” gives the total cumulative number of RTP packets sent from this host since the session starts. It counts until this SR is written. Therefore, the difference of this number in two SR messages is the expected number of RTP packets that the destination terminal should receive during the time period between the SR generations.
- “Sender’s octet count” indicates the total cumulative number of RTP payload bytes sent since the session began.
- “RTP timestamp” corresponds to the same time as the NTP timestamp described above, but it is in the unit of sampling count.

The receiver report section provides these following values for each source (SSRC_1, SSRC_2, etc.):

- “Highest sequence number received” is derived from all arrived packets. The difference of this number in two RRs equals the total number of packets received from the source during the time period between the RR generations.
- “Cumulative number of packet lost” is determined from the total number of successfully arrived packets since the start of that session. However, this total does not exclude late or duplicated packets. The total number of transmitted packets (equaling highest sequence number received less initial sequence number) subtracted by the total number of received packets gives the cumulative number of packet losses for the source. If the number is negative, this field is set to zero.
- “Inter-arrival jitter” is reported in RTP timestamp unit. This is not the pure jitter but formulated with the cumulative jitter value.

- “Last SR timestamp” is extracted from the middle 32 bits of NTP timestamp (total 64 bits) in the last SR packet sent by the source.
- “Delay since last LSR” is the calculated elapsed time since the last SR message is received from the source. This value can be used by the source to determine a roundtrip delay sample.

F. RTP AND RTCP PORT NUMBER

As stated in RFC 1889, RTP and RTCP use the random contiguous port number scheme. Both use UDP as transport. Each media type separately uses a pair of adjacent UDP ports ($2n$, $2n+1$). The RTP occupies the lower even number ($2n$) while RTCP uses the higher odd number ($2n+1$).

G. TRANSMISSION PRIORITY

In the current IP-based network, traffic by default is routed with a best-effort scheme. To expedite the transmission, VoIP packets should be prioritized for a higher level of service in layers 2 and 3. Currently, classification tools may be used to mark a packet or flow with a specific treatment at the network switching device.

Cisco VoIP design [Ref 14] puts the traffic classification at the network edge, normally at the wiring closet or within the IP phone or voice endpoint. Two packet-classifications in separate layers are implemented in Cisco equipment.

- Layer 2 Class of Service (CoS) : Use the priority bit of the 802.1p portion in 802.1Q header as illustrated in the Figure 16.
- Layer 3 Type of Service (ToS) : Use the IP precedence of Differentiate Service Code Point (DSCP) inside Type of Service field in the IPv4 header as shown in Figure 17.

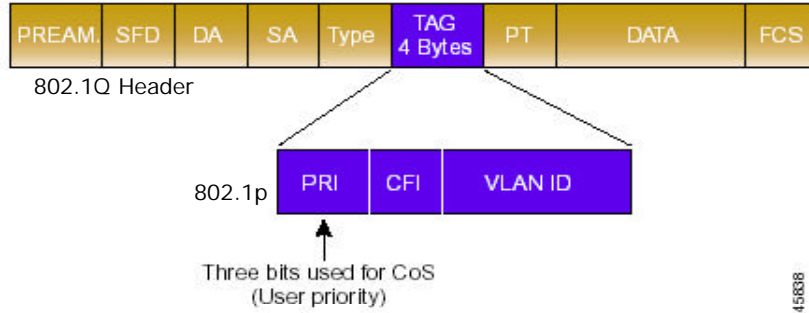

Figure 16. Layer 2 Priority Setting (From: Ref 14)

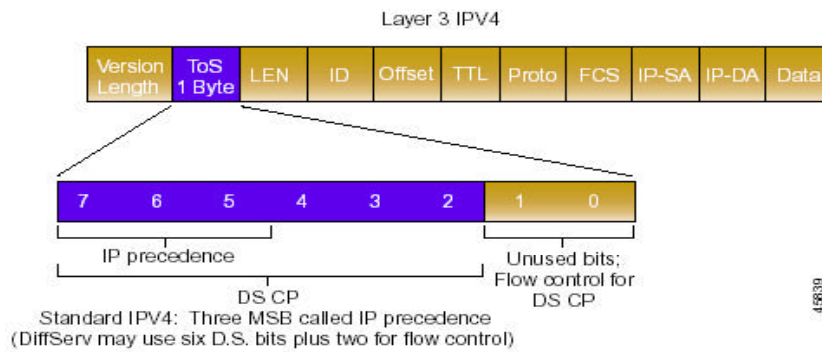

Figure 17. Layer 3 Priority Setting (From: Ref 14)

All IP phone RTP and RTCP packets are tagged with separate values summarized in Table 2. However for this method to work, the on-route IP devices must support DSCP priority scheme.

Table 2. VoIP Packet Priority Classification (After: Ref 14)

Layer 2 CoS	Packet Condition	Layer 3 ToS			Cisco Recommend
		IP Precedence	ToS Bits	DSCP	
CoS 0	Routine	0	000 xxx 00	0-7	
CoS 1	Priority	1	001 xxx 00	8-15	
CoS 2	Immediate	2	010 xxx 00	16-23	
CoS 3	Flash	3	011 xxx 00	24-31	RTCP
CoS 4	Flash-override	4	100 xxx 00	32-39	
CoS 5	Critical	5	101 xxx 00	40-47	RTP
CoS 6	Internet	6	110 xxx 00	48-55	
CoS 7	Network	7	111 xxx 00	56-63	

Cisco plans to use the DSCP value of Expedited Forwarding (EF) for voice packets and DSCP value of Assured Forwarding 31 (AF31) for control traffic.

H. ERROR CONTROL TECHNIQUE

When transmitting voice packets over the network, the transmissions may suffer from packet loss, delay, jitter, bit error, and burst error. These problems may be addressed with packet loss control and/or error control. Packet loss control methods like RSVP cannot guarantee complete loss-free delivery, but they try to manage the routing devices to anticipate and serve the needs of the designated flow as much as possible. On the other hand, an error control method reacts to packet loss and error and attempts to recover at the receiver. [Ref 17]

Error control methods can be categorized into two types: ARQ and FEC.

1. Automatic Repeat reQuest (ARQ)

This technique automatically retransmits lost or impaired packets when the receiver discovers such problems in the data stream. Therefore the error control is transparent to the application layer. However, if voice packets are retransmitted, the delay and jitter might increase significantly. Thus, it is not appropriate for interactive real-time applications.

2. Forward Error Correction (FEC)

This method sends enough redundant information so that the application can reconstruct the original data even if some packets are lost. For example, multiple copies of voice packet “n” can be duplicated and sent along with packet n+1, n+1, ..., and n+k, where k is the total number of redundant packets, no retransmission is required. The packet loss rate, delay, and jitter are lower than ARQ. However, the bandwidth efficiency is lower. Figure 18 shows the frame pattern. [Ref 17]

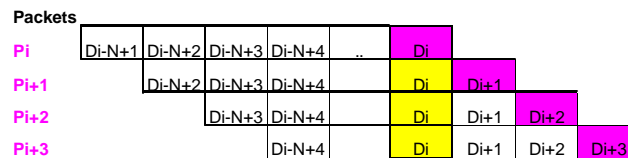

Figure 18. FEC Data Stream Pattern

IV. VOIP PERFORMANCE

Since VoIP is designed to emulate the toll services, the quality of packetized voice is the key concern. In the existing environment, the public networks cannot guarantee VoIP reliability and sound quality like the PSTN communication due to the limitation on network bandwidth. To determine the performance of VoIP, several factors should be considered. - especially delay, jitter, packet loss, and echo. This chapter discusses these factors and the source of voice degradation.

A. VOICE QUALITY

The quality of speech can be considered as a measure for fidelity of speech, intelligibility of speech, or the reliability of designed transport mechanism. The International Engineering Consortium (IEC) [Ref 15] defines Voice Quality (VQ) as the qualitative and quantitative measures of the sound and conversation quality of a telephone call. Its technical papers also discuss some characteristics of VQ which are summarized in this chapter.

The quality of voice should be evaluated from the perspective of end-to-end users. The interactive partners should report their experience without dealing with hardware equipment and transmission method. However, this perceptive quality is based on the users' expectation, context, physiology, and mood. These factors then make VQ highly subjective and difficult to evaluate. As a result, IEC explains the evaluation of VQ by comparing VoIP with the PSTN in order to cover all aspects in toll systems.

In any communication systems, the voice transmission is characterized by three basic quality components - service, sound, and conversation - in which each component somewhat relates to others. Service quality depends on the service provider's business strategy and slightly involves the technical aspect of network performance including network device operation. The other two components, sound and conversation quality, relate to the network deployment performance. These components are summarized in Table 3.

Table 3. VQ Components (From: Ref 15)

Service Quality	Sound Quality	Conversation Quality
<ul style="list-style-type: none"> • offered services • availability in any area • network availability - no downtime, busy signal • reliability • price 	<ul style="list-style-type: none"> • loudness • distortion • noise • fading • crosstalk 	<ul style="list-style-type: none"> • loudness distortion noise • fading • crosstalk • echo • end-to-end delay • silence suppression performance • echo cancellation performance

According to the definition of VQ, there are three primary factors influencing VQ of VoIP application. The first factor is the clarity which is normally interpreted as the fidelity, clearness, lack of distortion, and intelligibility of voice signal. The next factor is the end-to-end delay and the last factor is echo. The integration of these three quality aspects represents the entire VQ as shown in the three-dimensional graph in Figure 19. The relationship among each component presents the vector of VQ. As can be seen from this graph, VQ increases when the plot is closer to the coordinate origin.

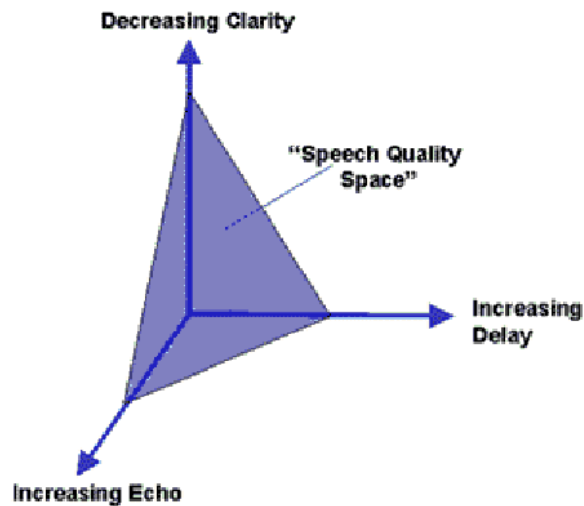

Figure 19. Relationship of VQ Components (From: Ref 15)

In overall, these three quality components are somehow related. The main components of voice clarity - such as distortion and fidelity - are independent from delay; for instance, voice may be clear during the long delay or may be unrecognizable during the short transmission time. Contrary, the echo depends on the delay and also affects the clarity of voice. The echo in network cannot be detected under the low delay threshold because it is not long enough to be distinguished from the original speech phrase. However, the clarity is degraded with large echo. The IEC uses this three dimensional graph to represent only the conceptual model of VQ and there is no mathematical formula used to explain the relative vector of VQ.

According to typical human sensitivity, if only one of these components is detected, user cannot understand the real behavior and then normally reports the overall VQ as undesirable. Listener just simply concludes it as bad or good VQ, on the other hand, the service provider and the network equipment manufacturer can address the difference between the distortion and echo. So in order to conduct the detail analysis, each component must be considered separately.

B. DELAY

The most challenge in the development of VoIP is the delay because it causes two problems: echo and talker overlap. Echo deteriorates the communication quality when the roundtrip delay exceeds 50 milliseconds. To cope with this problem, the echo cancellation system should be implemented. Another problem, talker overlap, which is the situation that a talker speaks while the other side's speech just arrives, also interrupts the conversation.

The following figure displays the conversation quality affected from user experience according to voice delay time. This graph indicates that the reasonable acceptable delay ranges from 100 to 250 milliseconds.

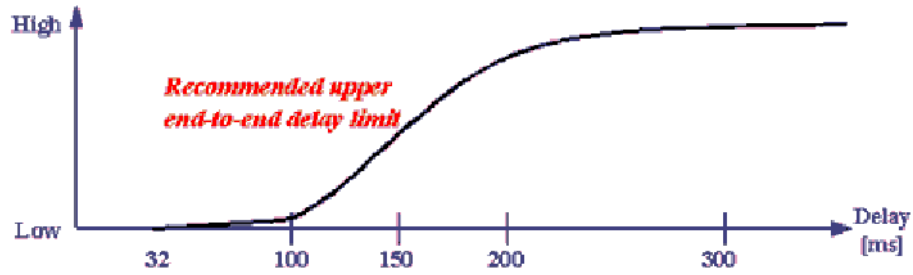

Figure 20. Delay Effect (From: Ref15)

At the point that the one-way delay exceeds 250 milliseconds, the significant problem is detected. As a result, it can be said that the end-to-end delay is the major constraint on voice quality. On private network, 200 ms delay is a reasonable goal and 250 ms is a limit. [Ref 10] The network administrators should configure the system to minimize voice delay as possible. The ITU-T recommendation G.114 summarizes three ranges of one-way delay as shown in the following table:

Table 4. Delay Specifications (From: Ref 11)

Delay (ms)	Description
0-150	Acceptable for most user applications
150-400	Acceptable provided that administrators are aware of the transmission time and it's impact on the transmission quality of user applications.
Above 400	Unacceptable for general network planning purposes, however, it is recognized that in some exceptional cases this limit will be exceeded.

Note: These recommendations are for connections with echo adequately controlled by echo cancellers. Echo cancellers are required when one-way delay exceeds 25 ms.(G.131)

The analysis of voice packet delay categorizes each delay component in several types such as coder, accumulation, processing, packetization, serialization, queuing, network switching, propagation, and de-jitter delay. Cisco explains these delays in its technical paper and are summarized as following. [Ref 11]

1. Coder or Processing Delay

Coder delay is the time taken by a digital signal processor (DSP) to compress a block of PCM samples. This delay depends on a voice coding algorithm and a processor speed. Generally, the coding/compressing time depends on the momentary loading of the

DSP. The example of G.729 voice coding interval (basic block size 10 ms) is illustrated in the Figure 21.

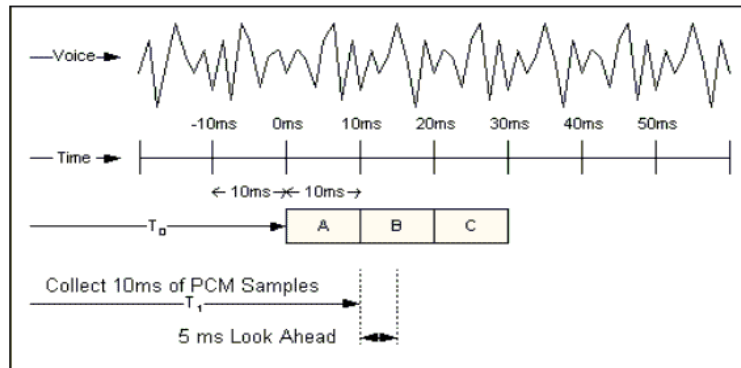

Figure 21. Voice Compression (From: Ref 11)

If assume that there are total four voice channels on one DSP, the following table displays the worst case compression time which is fourfold of the best case. Cisco uses this worst case scenario in its router design for conservative purpose. [Ref 11]

Table 5. Coder or Processing Delay (After: Ref 11)

Coder	Sample Block Size (ms)	Coder Delay (ms)	
		Best Case (1VC)	Worst Case (4 VC)
G.723.1 6.3 kbps	30	5	20
5.3 kbps	30	5	20
G.726	10	2.5	10
G.729A	10	2.5	10

Notes: VC is Voice Channel on DSP

In addition, the decompression time is approximately 10% of the compression time on each block. It is also proportional to the number of samples per frame.

2. Algorithmic Delay

During the coding period, some algorithm requires the coder to look ahead into the next voice block “n+1” to gain some knowledge before processing sample block “n”. This algorithmic time increases the overall delay. Since the algorithmic time occurs repetitively on every block, it is a constant value as listed in Table 6.

Table 6. Algorithmic Delay (From: Ref 11)

Coder	Algorithmic Delay (ms)
G.723.1	7.5
G.726	0
G.729A	5.0

3. Packetization or Accumulation Delay

This delay is the time taken by vocoder to fill a packet payload with encoded/compressed speech. It depends on the number of voice blocks accumulated in each single voice frame. Cisco recommends to keep the packetization delay less than 30 milliseconds. In general, the G.729A coder puts two or three voice blocks into one frame, while G.723.1 puts only one block. The following table calculates the accumulation delay based on the payload size and number of voice block.

Table 7. Packetization Delay

Coder	Number of Block per Frame	Payload Size (bytes)	Packetization Delay (ms)
G.711	2	160	20
	3	240	30
G.723.1	6.3 kbps	1	24
		2	48
	5.3 kbps	1	20
		2	40
G.726	2	80	20
	3	120	30
G.729A	2	20	20
	3	30	30

As previously mentioned, the voice samples require the processing time, algorithmic time, and packetization time. However, these delays overlap like a pipelining nature and must be deducted. The calculation example shown in Figure 22 scenario assumes that there is no algorithmic delay, and uses the best case processing delay. Obviously, the result shows that the main component of pipelining delay is the packetization time.

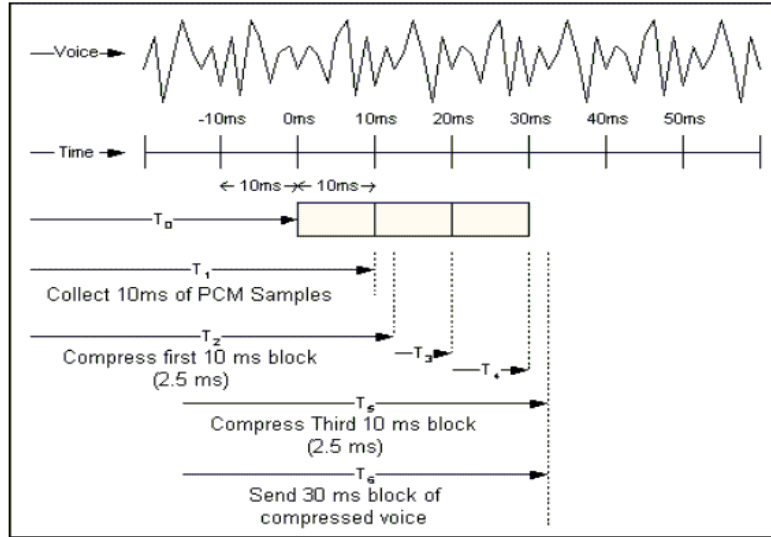

Figure 22. Pipelining Nature (From: Ref 11)

4. Serialization Delay

The serialization delay is a fixed number of time to send voice or data frame to the network interface. This value directly relates to the clock rate of trunk. The following table displays the serialization time.

Table 8. Serialization Delay

(unit: milliseconds)

Frame Size (bytes)	Line Speed				
	64 kbps	256 kbps	512 kbps	1 Mbps	10 Mbps
64	8	2	1	0.5	0.05
256	32	8	4	2	0.2

5. Queuing/Buffering Delay

The queuing delay varies since it depends on a trunk speed and a queue state. It is a time taken when voice frame is waiting in a buffer before being transmitted to the network. Since it has the highest priority, voice packet must wait only for either the on-transmitting data frame or a pending voice frame ahead in queue. The estimated buffer delay can be calculated by adding the serialization time of one voice frame with the multiplication of probability of waiting data frame and the serialization time of one data frame.

6. Network Switching Delay

The network switching delay in the public network is the largest delay portion of Internet Telephony. It is not easy to compute since there are many factors involved. This delay consists of the fixed component such as propagation time, and the variable component such as switch queuing time. The G.114 recommends to use the approximate propagation time at 10 microseconds per mile or 6 microseconds per km. In typical US carrier network, the frame relay connection delay is approximately 40 ms fixed and 25 ms variable for a total worst case of 65 ms.

The delay quantity in router depends on its configuration, performance, capacity, and load. There is a rule of thumb to use 10 ms delay on each router [Ref 16].

C. CLARITY

The second component of VQ, voice clarity, is characterized with the level of perceptual fidelity, clearness, non-distortion, and intelligibility. These meanings are subjective and vague; for example, even though the voice signal is highly distorted, it is possible to understand the entire conversation context due to the common sense in human interactive conversation.

The quantification of voice clarity is quite complex and dependent on many factors. For example, the frequency band is sensitive to speech content recognition, human ears are more sensitive to the distortion at 1000 to 1200 Hz than 250 to 800 Hz band, the complete sentence is more intelligible than the series of unrelated words.

Among the various subjective concerns, the clarity of voice packet transmission depends on the packet loss, jitter, codec, noise, voice activity detector, and external environment.

1. Packet Loss

Since the IP network does not guarantee the level of service and the UDP transmission mechanism does not promise the completion on delivery, the packet loss is normally found in voice traffic, especially under the peak loads and congestion period. If packet loss is higher than 5%, it significantly degrades the quality of conversation [Ref 16].

In order to mitigate the impact of voice frame loss, the following three mechanisms are used. [Ref 10] The first method is to interpolate the lost speech packets by replaying the last received frame before lost. This method is simple and appropriate for the infrequent loss. However it is not good for the burst loss. The next method is to send the redundant information along with regular traffic. This approach is called forward error correction (FEC) scheme, discussed later. However, it consumes more bandwidth. The voice frame “n” is duplicated and sent along with frame “n+1, n+2,...” depending on window size. This method can solve the loss problem effectively but can cause greater delay. The last method is to use the hybrid approach of the above. It requires less bandwidth than the FEC approach. However, the delay problem remains.

2. Jitter

The jitter is a variable inter-packet arrival time introduced in the network. The de-jitter buffer is allocated in the far-end routers to smooth speech signal before it leaves the network. This buffer transforms the variable delay into a constant value by accumulately holding the first received sample for a certain period before sending out. This period is called the initial playout delay.

If the buffer is underrun, it causes speech gap. If the buffer is overrun, it causes packet drop which also generates silence gap. So, the optimal initial playout time equals to the total variable delay along the connection path.

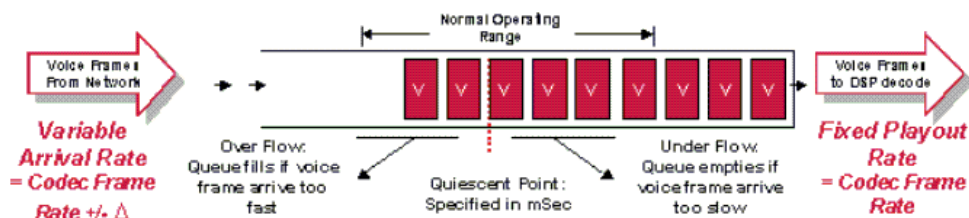

Figure 23. De-jitter Buffer Operation (From: Ref 11)

To optimize the buffer size, the jitter buffer must be adjustable. The first adaptive approach is to measure the variation of packet number stored in the jitter buffer over a period of time and incrementally adapt it. This method is appropriate to the consistent network such as ATM. The second approach is to calculate the adjusting ratio and use

this number to adjust buffer size. It needs some mechanism to count the number of late-arrival packets and divide it with the number of successfully processed packets. This approach suits the high inter-arrival jitter environment like IP networks. [Ref 10]

3. Codec

Codec, as explained in the previous chapter, performs compression and packetization function. The compression algorithms implemented in different codecs offer the different speech distortion since they do not equally preserve the perceptual importance of audio signal. This perceptual importance is sensitive to human physiology and cognitive psychology. As a result, different codecs generate different waveform to the listener. Among various coding algorithm, the linear codec, G.711, is rarely used due to the high bandwidth consumption. On the other hand, the most popular non-linear codec, G.723.1, cannot completely reproduce the original speech, and this cause voice distortion in most VoIP applications. As the different compression techniques require the different computing power and computing time, the codec selection also affects the delay.

4. Noise

Noise is generated from bit error on data transmission lines or analog lines. Since noise exists before speech is digitized, it is always included by codec into the signal and causes clarity distortion.

5. Voice Activity Detector

Voice activity detector (VAD) or silence suppression is used to optimize the connection bandwidth. It operates at the sender side and can adapt to different noise and voice level. As human conversation is normally half-duplex, VAD can save 50% of bandwidth requirement. Its behavior is shown in the following figures.

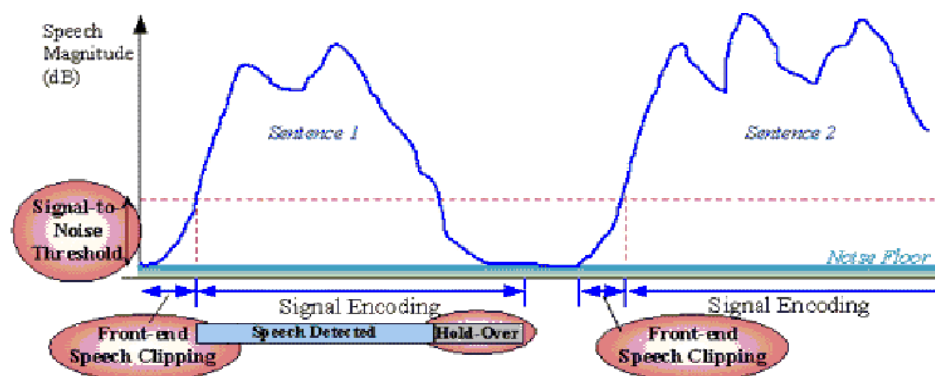

Figure 24. VAD Behavior (From: Ref 15)

VAD checks the speech pattern and removes the unimportant portion from the decompressed signal. So, it may inadvertently eliminate the speech content and decrease the intelligibility of conversation. Too much front-end clipping (FEC) makes signal hard to understand. Too much holdover time (HOT) deducts network efficiency while too small holdover time causes chopping speech. Finally, the comfort noise generator (CNG) is used to provide the signal during a silence periods. CNG must be matched with true noise background to properly produce VQ.

6. Environment

Some environmental factors may make listener feel uncomfortable with voice conversation even though the audio quality is pretty good. These factors are room noise, user mood, and user expectations.

D. ECHO

Echo results from the signaling reflections of telephone speaker's voice back into telephone microphone. It is generated from the heterogeneous link especially from four-wire link (digital cable) to two-wire link (telephone). This connection is normally arranged at the local switch. If the impedance between each section does not exactly match, the incoming signal is fed back in the outgoing signal. Generally signals keep looping between two amplifiers and produce echo if the one-way delay is approximately 20-25 milliseconds [Ref 16]. Echo can also be created from the acoustic problem between the speaker and microphone. It is called acoustic echo. If the echo level is lower than -25 dB, it may not be detected.

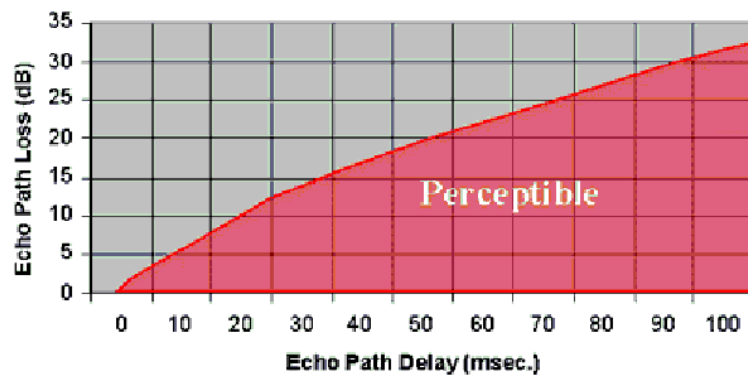

Figure 25. Relationship between Echo Level, Delay, and Perception (From: Ref15)

Thus, echo in packet switching network usually causes a problem because the roundtrip time is always higher than 50 ms. To eliminate this echo, the application requires a special type of echo cancellation, called the far-end or tail-end echo cancellation, otherwise, the speech cannot be understood. ITU G.165 standard explains the requirement for echo canceller.

Echo canceller is provided at VoIP gateway or terminal, usually closed to the tail-end host. It uses a mathematical model to estimate the expected echo and eliminate it out from the transmitted voice signal. It can adapt to signal and circuit conditions.

E. PERFORMANCE CONTROL MECHANISM

As previously mentioned, VoIP performance depends mainly on the network bandwidth. It works very well on private network but not on the public environment. Moreover, the configuration of network switching device can eliminate the bottleneck on some area. To solve the problem on low speed link, Cisco introduces the control mechanism as following: [Ref 14]

1. Congestion

Congestion causes delay and jitter. It can be minimized by using intelligent queuing which incorporates weighted fair queuing (WFQ), IP precedence, RSVP, adaptive jitter buffer, and priority queue.

2. Packet Residency

If large packets are queued, the freeze-out is slow. So, it is better to use interleaving technique, IP MTU size reduction, and adaptive jitter buffer.

3. Bandwidth Consumption

This situation is a problem when too large header size is used on low link. It can be solved by compression technique applicable for codec and RTP header.

4. WAN Traffic Inconsistency

This is a problem of oversubscription and bursting. To minimize the problem, network administrator has to use traffic management such as router traffic shaping, high priority private virtual channel, link fragmentation, and data discard eligibility.

All solutions must be carefully considered and tailored to suit each network. The performance evaluation is required after the VoIP design is implemented.

V. PERFORMANCE MEASUREMENT

Many researchers have conducted measurement studies on VoIP performance during last few years. It is important to know the capability of network infrastructure before deploying a VoIP application; otherwise, the application might not offer benefits as expected. To evaluate the service level, all performance factors discussed previously must be determined.

A. VQ MEASUREMENT

To measure VQ, the following quality components must be analyzed - clarity, delay, and echo. The IEC [Ref 15] summarizes the evaluation of VQ in the following guideline.

1. Measuring Clarity

A good method to quantify VQ is to use a large group of testers in a controlled environment. The clarity is determined directly from the user hearing. However, this method is time consuming and not flexible.

Another method called perceptual speech-quality measurement (PSQM) is recommended in ITU-T P.861. The PSQM method is designed to be an automated human listener that can objectively evaluate the speech quality in the bandwidth range of 300 to 3400 Hz. This measurement method focuses on the distortion, noise effect, and overall perceptual fidelity. The newer version, called PSQM+, correlates the distortion to the Mean Opinion Score (MOS) values.

The third method is called perceptual analysis measurement system (PAMS). It is developed based on the PSQM model but provides test repeatability. Its signal processing algorithm is more effective. PAMS generates listening quality score and listening effort score, both of which can correlate to MOS.

Furthermore, VAD can be measured directly by using a simulated test signal. The FEC, HOT, and CNG matches must be evaluated. This test is quite complicated because it deals with the voice band signals in different tracer dyne tones.

2. Measuring Delay

To analyze the quality of voice, the end-to-end delay can be evaluated separately from clarity because the delay does not affect the sound of voice conversation; it just disrupts the rhythm and irritates the feel of communication. The IEC publishes two methods to measure delay: Acoustic PING and MLSNCC.

Acoustic Packet Internet Groper (Acoustic PING) is the measurement technique using a narrow audio spike to represent voice packet. This spike is pinged to the destination to measure the end-to-end delay. However, it may be interfered by noise, attenuation, and packet loss. So, acoustic PING should be used along with other method to make the result more accurate.

Maximum length sequence normalized cross-correlation (MLSNCC) is the technique used to verify the Acoustic PING. It uses DSP to send a special test signal, similar to white noise, through the network. MLS noise is repeatable and predictable. Then a received and original signals are analyzed to calculate the end-to-end delay. The result from this method is more accurate than PING.

In this study, two more delay measurements are introduced by performing the calculation directly from RTP and RTCP transmission times. The details are explained in section C.

3. Measuring Echo

To determine echo, it is necessary to understand the echo level and echo return time. The echo return loss (ERL) is the attenuating amount before echo arrives at the receiver. The design of echo cancellation requires the value of ERL and echo delay. So, the echo cancelling performance must be evaluated. It can be tested with these parameters: convergence time, cancellation depth, and doubletalk robustness.

One way to test echo is to use a subjective measurement called Perceived Annoyance Caused by Echo (PACE). The users report how much echo harms the conversation. The ITU-T explains two algorithms to evaluate echo: the first one is to test with white noise in G.165 recommendation, and the other is to test with signal frequency in G.168. However, these methods are only appropriate for laboratory environment with a

linear codec. On the other hand, PSQM and PAMS algorithms can be applied to measure echo in the real networks.

B. MEASUREMENT METHODS

Generally, the performance of voice packets can be determined by objective and subjective tests. The subjective measurement involves the human feeling. Each evaluator listens to a live or recorded speech communication and gives a satisfactory score. Since the performance value is directly given by people, it is acceptable to measure a telephony system. However, it is time-consuming and expensive since a lot of resources must be allocated to produce an accurate result. On the other hand, the objective measurement is used to evaluate the speech quality by computing the quantitative distortion between the original and the received signals. [Ref 18]

As the evaluation can be performed with either an objective or a subjective approach, the best practice is to integrate both factors because the main design goal of IP Telephony is to support time-sensitive and interactive communications. However, such a combined approach is not easy to implement.

To measure the performance of VoIP, tests can be done with the actual voice or with virtual (simulated) voice. Each approach has a different advantage and can be explained as following.

1. Measurement with Virtual Voice

The approach to test the performance of IP telephony with simulated voice is basic and simple. It is mostly adopted in the early researches in this area. Since no human direct-participation is required during the test, it is flexible to any network environment.

The virtual speech is generated by computer using network programming in which the payload portion in voice packet can be any bit stream. The important contents - RTP, UDP, and IP header - carries network performance information, such as delay, jitter, and packet loss.

This approach is categorized in three methods: model simulation, direct measurement, and agent-based measurement.

a. *Model Simulation*

This method simulates all terminals and switching devices on modeling software. Each node property and behavior can be configured to suit the test scenario. The accuracy of application relies on the design of queue and finite state machine. The example of this model is OPNET..

b. *Direct Measurement*

In order to measure the performance directly, voice packet is generated and transmitted on the real network or on dedicated channel simulator. Test may include a central office switch, gateway, and gatekeeper. Since voice packet can be manipulated at a source, it is quite flexible to derive the output from a header info. After evaluation, the analytical data collected at a receiver is compared to the source data. Finally, the performance parameters - such as delay, jitter, packet loss, and packet unordered - can be determined.

The major drawback of this method is that it can measure only the objective parameters, not the subjective ones. Consequently, it is normally used to measure the network performance, not for the VoIP performance. However, the correlation of E-model, discussed later, can solve this problem.

c. *Agent-based Measurement*

This method uses similar concept with the direct measurement but using the agent-based software to conduct the autonomous testing. Normally, it can test on the large-scale network like WAN. To perform a test, an accessor software is written to behave like an endpoint and assessor console. Then several endpoint agents are installed on the designated computers at different test sites. As the software is autonomous, each agent can emulate the codec behavior and form the virtual voice packets. It is also capable to generate multiple calls according to the predefined call schedule. At the server location, an assessor console serves as the coordinator of all endpoint agents. It incorporates the assessor database which contains the codec script, the schedule of call, and the result of test run.

When the test starts, the assessor console established connection with all endpoint agents via TCP. It sends a call script indicating a codec, call group, and call schedule to other endpoints. Then each endpoint starts generating the connection to the

other endpoints with RTP. The endpoint also detects the incoming call and measures the performance parameters. These computed parameters are sent via TCP to the assessor console and store in the assessor database. The example of this measurement method is NetIQ assessor. [Ref 19]

With this approach, the delay, jitter, and packet loss can be determined from the database. However, the subjective parameters cannot be assessed directly. It relies on the translation method using E-model.

2. Measurement with actual voice

To test with actual voice, the human-generated speeches are digitized into voice packets for performance evaluation. The evaluation yields us the performance of network, encoding scheme, and some communication behaviors. Both subjective and objective factor can be derived. The actual voice is categorized as the pre-recorded speech and live conversation.

a. Pre-recorded Voice

The actual speeches are recorded in dedicated environment before being compressed with different encoder. The background noises such as car, wind, hall echo, or people chat may be included into a test. This test is designed to measure some performance parameters, so each voice packet may be modified with different bit error rate, burst error rate, signal to noise ratio, and silence period. Consequently, the test scenarios are formed based on the combination of these factors. After each voice is transmitted and the listeners evaluate, the results are compared with the baseline.

The benefit of this approach is that it can measure the subjective performance such as the Mean Opinion Score (MOS) of that network status. Moreover, it can test the objective parameters; for instance, the encoding, bit error rate, burst error rate, s/n ratio, voice background percentage, silence period, link error, link load level, data rate, echo cancellation, silence suppression, and bandwidth efficiency. This method is appropriate to analyze a real-time application; not a real-time “interactive” one.

This evaluation should be conducted on the closed environment to limit the number of parameters. If test is run on the opened public network to incorporate the

real environment, the delay will be large and not consistent due to the fluctuation of traffic.

b. Live Conversation

Test with live communication extends the benefits of test on pre-recorded speech with the interactive score. Each participant evaluates the conversation based on continuity of speech, quick response, silence gap, echo, and noisy. The qualitative service score is estimated under the designated numeric range. The average score of all subjects represents the performance value of VoIP. The most acceptable test is MOS.

Measurement in real communication can also be used for objective test. It requires some computation on packet header contents. Delay, jitter, and packet loss can be determined from RTCP packet. Then all parameters can be converse to MOS by using E-model.

3. Comparison of Performance Measurement Methods

The following table compares five measurement approaches.

Table 9. Comparison of VoIP Performance Measurement

Performance Measurement	Virtual Voice			Actual Voice	
	Model Simulation	Direct Measure	Agent Based	Pre-recorded	Live Conversation
Test Control Variable					
Encoding	N	Y	Y	Y	Y
Error Rate	Y	Y	N	Y	N
Silence Compression	Y	N	N	Y	N
Data Rate	Y	Y	Y	Y	Y
Echo Cancellation	Y	N	N	N	Y
Link Loading Level	Y	Y	N	Y	N
Voice Background	N	N	N	Y	N
Test Type					
Objective Measurement					
Delay	Y	Y	Y	Y	Y
Jitter	Y	Y	Y	Y	Y
Packet Loss	Y	Y	Y	Y	Y
Subjective Measurement					
MOS	N	N	N	Y	Y
R-Value	N	Y	Y	Y	Y

C. MEASUREMENT OF DELAY

As discussed in the previous chapter, there are several delay components involved VoIP application. Some components are constant like a encoding type, while some varie such as a link speed, queuing buffer, or other factors. However, to measure the performance, all delay elements must be aggegrated to a single delay parameter. The main delay portion that most researchers pay attention to is a propagation delay between terminals. This latency is expected to be lower than 250 milliseconds, otherwise voice quality is poor. To measure this delay, RFC 1889 explains a simple calculation method to determine a roundtrip delay by using the contents inside RTCP message.

1. RTCP Time Information

To measure the roundtrip time, RTCP, as a control companion of RTP, is the appropriate tool to provide the sampling delay information. According to RFC 1889, RTCP messages are sent from each host to all other participants in the same session. The control packets are sent out with a slightly different interval. Each time, the interval is randomized at the minimum of 5 seconds to avoid burst RTCP packets and unintended synchronization from all participants. Every time a message is went, the source timestamp is determined and recorded into a packet header. In the sender report, two timestamp values are provided, the NTP and RTP timestamp.

The RTP timestamp cannot be used to derive delay time because it is recorded in a sampling instant format. However, it is used to maintain the synchronization and calculate a jitter. [Ref 20]

On the other hand, the NTP timestamp which is the wall clock time formatted in 64 bit unsigned fixed point number can be used to derive delay. As stated in RFC 1305 [Ref 21], it is a relative time to 0h on 1 January 1900 recorded in total 64 bits format. The most significant word 32 bits in sender report is the integer number and the fraction part is contained in the least significant word 32 bits. So, the time precision of this format is about 200 picoseconds.

Figure 26 illustrates the incremental behavior of RTP and NTP timestamp. While NTP always increases, RTP may stall during the silence gap or non-sampling period. As a result, there is no direct relationship between both numbers.

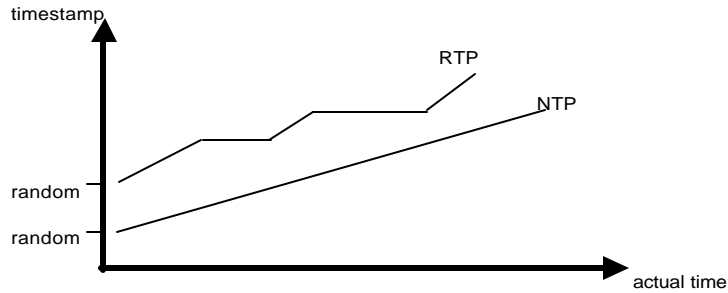

Figure 26. RTP and NTP Timestamp

2. Clock Synchronization

Before start calculating a delay by using a NTP timestamp, all terminal clocks must be synchronized. This can achieve by synchronizing them with one of them or the standard time server. The time synchronization normally proceeds with one of these two standard protocols, NTP and SNTP.

The Simple Network Time Protocol (SNTP), as explained in RFC 1769 [Ref 22], is a simplified version of Network Time Protocol (NTP) with less degree of accuracy but in acceptable level. As it requires less complicated calculation, SNTP is implemented in the system time module of Windows 2000 Server, W32Time. The main reason that Windows platform does not use the NTP is it does not require such high precision. How well a time protocol can synchronize depends on the hardware and the design of operating system. The clock granularity of Windows 2000 system ticks approximately every 10 milliseconds. Then no matter what time protocol is used on Windows platform, it cannot be accurate more than 10 milliseconds. In its design, W32Time uses loose synchronization by controlling time on all clocks in the enterprise within 20 seconds range, and all clock in a site within 2 seconds range. [Ref 23]

3. Sampling Delay

As explained in RFC 1889 [Ref 13], after all terminal clocks are synchronized, the round trip delay can be calculated from the LSR and DLSR field.

The first field, Last sender report (LSR) timestamp, as the middle 32 bits of NTP timestamp (total 64 bits) is derived, at the receiver, from the most recently received SR and placed into the SSRC corresponding message. Since, the LSR is unique in each

session for each SR due to the time precision in NTP format, the LSR can be used to identify the SR packet [Ref 20].

The second field, Delay since last SR (DLSR), is the elapsed time between the last SR packet from SSRC is received and the subsequent RR message is returned. This elapse time is reported in 1/65536 seconds format, so it offers a time granularity at approximate 15 microseconds [Ref 20]. This number accounts to the duration between RTCP SR and RR.

Figure 27 illustrates a DLSR between SR1 and RR1. The sender A sends RTCP SR1 message, containing T1 in NTP timestamp field, to all participants in its session. When the receiver B receives the message at time T2, it memorizes T1 value until the moment that RR1 is generated. So, the reort message RR1 is sent out with middle bits of T1 in LSR field and the time duration between T2 to T3 in DLSR field. Sender A receives the RR1 messages at T4. It checks SSRC to find the report section and LSR with its own memory recorded since SR1 is sent out.

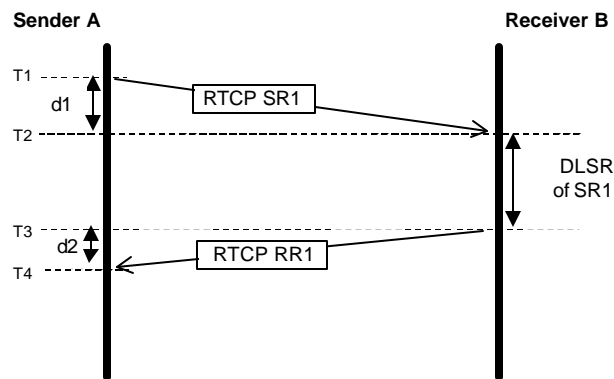

Figure 27. DLSR and Roundtrip Time

In RFC 1889, a sample computation is presented, when RTCP message places the actual operating system clock into message, the roundtrip delay can be derived by this equation. [Ref 13]

$$\text{roundtrip time} = T4 - \text{LSR} - \text{DLSR}$$

However if RTP does not use a standard NTP clock, it may cause the error because LSR is not equal to T1. So, without clock synchronization, the sender A can still compute the roundtrip time between A-B-A by using another simple offset calculation [Ref 24].

$$\text{round trip time} = d1 + d2 = T4 - T1 - DLSR$$

To use this formula, T1 and T4 must be obtained at the sender by using a packet analyzer. However this number is an approximate value as it only represents the sampling roundtrip delay in every 5 seconds, not the continuous delay. The one-way delay is assumed to be half of this value with the symmetric link. This method uses RTCP roundtrip time as RTP packet roundtrip delay.

Nevertheless, the actual delay on voice transmission is the delay on RTP packets, not the RTCP packets. In G.723.1 encoding, RTP packet is sent every 30 milliseconds while RTCP message is sent every approximate 5 seconds. This means that one control message is sent out for every 166 voice messages. So, RTCP can statistically represent only 0.6 percent of the entire actual sample space. Moreover, the delay of RTCP does not necessarily equal to the one of RTP because a voice packet and a control packet may use different IP Precedence and DSCP. On the network that supports DiffServ implementation, the buffer size is allocated differently for each codepoint and the queuing time might be slightly different. So, another method to calculate delay on each RTP packet is introduced next.

4. Per-packet Delay

In order to calculate the propagation delay on RTP message, it is better to synchronize system clocks among all participants. Then each RTP packet must be recorded the sending time and receiving time. The different between two values of the same packet sequence number is one-way delay between hosts.

If the system clock is synchronized with GPS, all clocks are run with the lowest stratum which offers the highest accuracy [Ref 25]. However the flexible approach is to

synchronize clock with any network time-servers provided by trusted organizations. After system clock is synchronized by time protocol application, there is still a small drift among all participants. This may happen from clock frequency, clock resolution, and network latency during synchronization process between host and time-server. It is important to determine this clock drift to adjust the system clocks. As the calculation of the absolute drift between time-server and hosts is quite complicated, it is easier to calculate the relative drift between source and destination hosts.

The relative drift can be determined by using two tools, a packet analyzer and time-server synchronization application, the experiment is discussed in the following chapter. A Packet analyzer is used to record an arrival time and departure time of RTP messages. Time-syn application is used to minimize the error gap between hosts.

Figure 28 illustrates a time series and drift, assuming that both clocks are running with the same clocking cycle speed and the clock on terminal B is a little bit ahead terminal A. The protocol analyzers installed on both terminals can record packet timestamps at T1a, T2b, T3b, and T4a. The notation d12 means the propagation delay of packet between departure time T1a to the arrival time T2d.

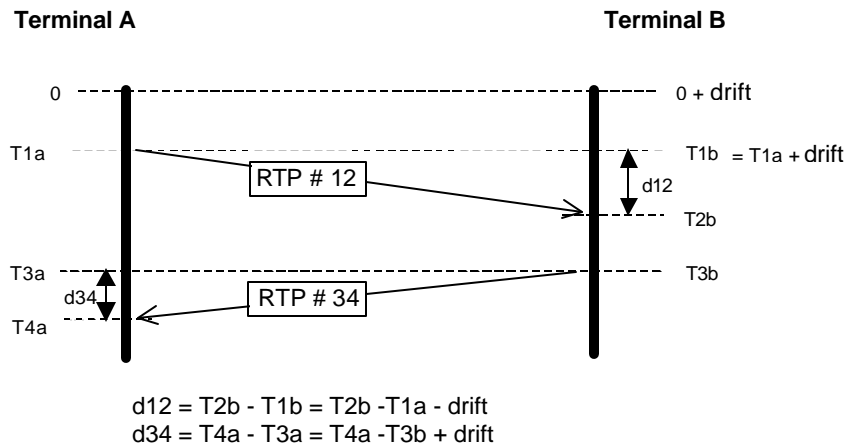

Figure 28. Clock Drift and Time Recorded.

If T1a and T1b are known, the calculation of drift is very easy but it is impossible to get value of T1b. However, with the knowledge that T1b equals to T1a plus drift, the following equation is used to derive time drift.

$$\begin{aligned}d34 - d12 &= T4a - T3b + \text{drift} - (T2b - T1a - \text{drift}) \\ \text{drift} &= 0.5 \times ((d34 - d12) - (T2b - T1a) - (T4a - T3b))\end{aligned}$$

All parameters above are read directly from a packet analyzer except d12 and d34. Base on the assumption that network is symmetric, a number d12 equals d34 and then cancel each other.

In real environment, delay on each direction does not exactly equal. However, the difference on both side is not significant when comparing to 200-250 milliseconds delay budget that VoIP can absorb. So, the assumption of symmetric link is reasonable and is widely accepted in other researches.

After a clock drift is computed, the sending time T1b and T3a can be calculated. Finally a one-way delay on each RTP packet can be determined.

D. MEASUREMENT OF JITTER

To optimize the buffer performance, it is necessary to adapt the buffer length of jitter buffer. This value is required continuously while the communication is being processed. RFC 1889 [Ref 13] explains the jitter information reported in RTCP packet. It is computed as a statistical variance of the RTP data packet interarrival time. This number is measures in RTP timestamp units and formatted as an unsigned integer.

To determine jitter, this RFC uses the concept of relative transit time. The relative transit time is the difference between RTP timestamp and the arrival time recorded by receiver clock in the same unit. First, the difference in relative transmit time is computed as D. Interarrival jitter J then is calculated by using mean deviation of D. Figure 29 displays a time sequence and delay on each RTP packet.

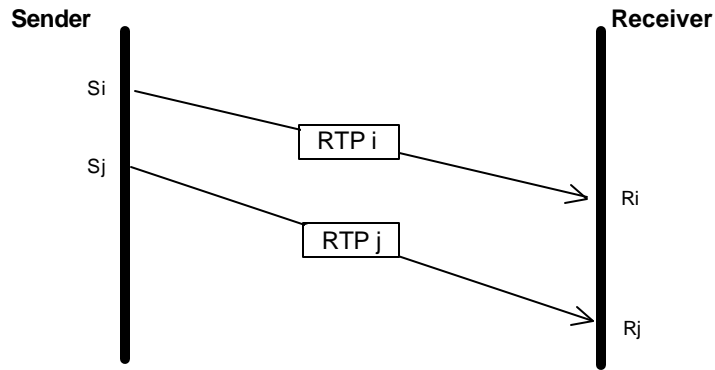

S is sending time (RTP timestamp)
 R is receiving time (time of arrival in RTP timestamp units)

Figure 29. Jitter Calculation

According to the definition of D, this pure jitter is calculated as

$$\begin{aligned}
 D(i,j) &= (R_j - R_i) - (S_j - S_i) \\
 &= (R_j - S_j) - (R_i - S_i) && \text{pure jitter}
 \end{aligned}$$

This equation simplifies the computation because we don't have to know the real S_i and S_j but only to check the difference between S_j and S_i . So, this jitter can be explained as the difference between signal spacing at sender and at receiver. [Ref 20]

After D is determined for each successive packet pair, the interarrival jitter J is calculated for each particular source identified by SSRC. RFC 1889 determine J with the following formula.

$$J = J + (|D(i-1, I) - J|) / 16$$

This formula uses the optimal first-order estimator algorithm in which the gain parameter $1/16$ is used for noise reduction ratio in order to preserve the convergence rate [Ref 13].

The interarrival jitter is continuously computed and instantly reported with that moment value when RTCP RR message is constructed.

E. MEASUREMENT OF PACKET LOSS

Since this research focuses on the regular voice packet model without using an error control technique, no FEC is implemented in the tested VoIP application. So each packet loss represents one actual loss. The information on packet loss is also provided in RTCP RR message in these two fields: fraction loss and cumulative number of packet loss.

The fraction loss is the ratio of RTP packets lost since the previous SR or RR was sent. It is the number of packet loss divided by the number of packet expected. The original loss ratio is computed and multiplied with 256. Then the integer part of this result is put in the fraction loss field.

The cumulative number of packet lost, on the other hand, reports the actual loss amount since the beginning of session. It treats each packet as one arrival message. The difference of this parameter in two successive RR messages is the number of RTP packet loss counted during the transmission interval.

However, the RFC 1889 report mechanism counts only the number of packets arrived at receiver, it does not consider the packet content whether it is duplicated or late-arrival. This is one drawback of RTCP since the late packet is dropped at destination, but it is not reported. To determine the real loss excluding playout error, all packets must be check with sequence number with the playout threshold.

F. MEAN OPINION SCORE

As described in ITU-T P.800 [Ref 26], Mean Opinion Score (MOS) is the mostly adopted subjective measurement. It reflects the voice quality by a group of listeners. The normal test sentences and free conversations are evaluate with the listening impression. The large group of listeners have to rate the impression on subjective scale such as intelligibility, acceptability, quality, naturalness, etc.

Test requires a lot of time and effort to arrange huge group of listeners. Tens or hundreds of evaluators must enter the testbed in same environment and in every rotation of changing to new VQ parameters. The experimental must be strictly controlled on every rotation. The results must be carefully analyzed. So, this is not an efficient method.

To determine the quality of voice communication system, MOS uses the Absolute Category Rating (ACR) method. Each evaluator is required to rate the audio in five rating scale corresponding to numerical points assigned. The score interpretation is shown in the following table. [Ref 27]

Table 10. Mean Opinion Score

MOS	Quality Rating	Quality Equivalent	Speech Quality
5	Excellent	Face-to-face conversation, or listen to CD	Complete relaxation
4	Good	Telephone grade	Attention necessary
3	Fair		Moderate Effort
2	Poor		Considerable effort
1	Bad		No meaning understood

Many voice samples are sufficiently used at each source to justify the accurate score. All individual rating values are averaged to yield the final score on each voice source. Test can be used to evaluate coding rate, language effect, link speed, etc. MOS at 4 or higher is generally considered toll quality. MOS below 3.6 means many users are not satisfied with call quality.

As MOS is a subjective test, the actual score of same test may vary on different listener groups. Moreover, the test environment can influent the listening evaluation. So, score on different test should not be compared to others. Normally MOS score of ADPCM is used as baseline for toll quality, the standard of PSTN call. [Ref 26]

G. E-MODEL

As previously mentioned, voice clarity can be objectively tested with PSQM or PAMS. However both methods are originally designed for PSTN call quality evaluation and only appropriate for testing in laboratory. These models are not effective for conversation on data network because they can't map back to the pertinent network

parameters such as delay, jitter, and packet loss. Moreover, the call quality is shown in one direction at a time, different from real interactive conversation. So, these methods are not the good candidates for VoIP evaluation on real network. [Ref 28]

In order to use the network parameters - such as delay, jitter, and packet loss - to tune the data networks, these objective numbers must be mapped to the subjective value such as MOS. The most acceptable conversion model called “E-model” is recommended in ITU G.107 [Ref 29]. It is used by NetIQ [Ref 28] for VoIP performance testing application. This model requires two mechanisms: calculating the R-Value and mapping to MOS.

1. R-Value

E-model is developed to include some data network impairment parameters in its single objective scalar R-value. This model is tested with varying degrees of impairments to determine the subjective score. The maximum R-value is 100 and minimum number is 0. The higher the value, the better the voice quality is detected. The statistic from empirical testing yields the following R-value formula.

$$R = R_0 - I_s - I_d - I_e + A$$

where:

- R₀ maximum value in perfect quality
- I_s simultaneous impairments to the signal
- I_d delays introduced from end-to-end
- I_e impairments introduced by the equipment, including packet loss
- A advantage factor e.g. mobile user may tolerate the lower quality because of the convenience.

This model includes these factors: one-way delay, packet loss percentage, packet loss burstiness, jitter buffer delay, data loss due to jitter buffer overrun, and codec behavior.

2. Mapping Objective Score to Subjective Score

After the R-value is calculated, it can be directly mapped to an estimated MOS. Since the inevitable degradation from voice conversion on packetization reduces the theoretical maximum R-value, the derived R-value is adjusted to range from 0 to 93.2

corresponding to possible MOS from 1 to 4.4. The mapping is shown in the Figure 30. The detailed calculation of this model can be found in the ITU G.107 Recommendation.

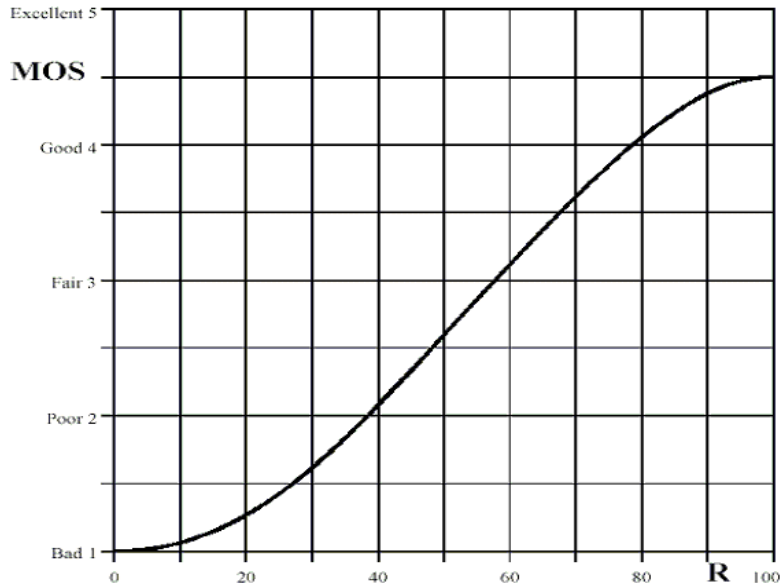

Figure 30. Mapping of R-value to MOS (From: Ref 28)

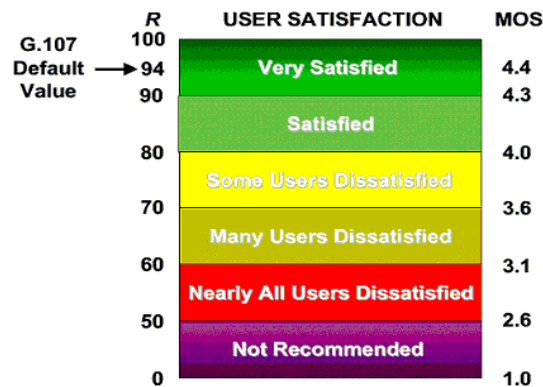

Figure 31. R-value and MOS with User Satisfaction (From: Ref 28)

H. PREVIOUS RESEARCHES ON MOS AND E-MODEL

Many researches are conducted to provide the relation between each pertinent VoIP performance factor and the subjective performance especially MOS and R-Value. The studies from different organizations yield different result because all tests are

established in various environments. Some relationships on performance factor - such as codec, loss rate, delay, and echo - provide the expected value of satisfactory quantification.

1. Codec

Cisco [Ref 30] tests the speech quality produced by several codecs and reports in its technical paper. The evaluation uses MOS as shown in the following table. In addition, NetPredict [Ref 31] provides the compatible R-Value on each compression technique. The standard G.711, using original signal without compression, is considered to be a benchmark on toll quality.

Table 11. Codecs' MOS and R-Value (After: Ref 30)

Codec	MOS	R-Value
G.711	4.10	83
G.726	3.85	76
G.728	3.61	70
G.729A	3.70	73
G.723.1 (6.3 mbps)	3.90	77
G.723.1 (5.3 mbps)	3.65	71

2. Packet Loss

Generally packet loss is found at the edge routers between LAN and WAN, where the packets are cumulatively queued on different buffer for transmission. The distributed loss is tolerably handled by voice reconstruction but the burst loss always causes content alteration. The following figure displays the effect of consecutive loss on R-value.

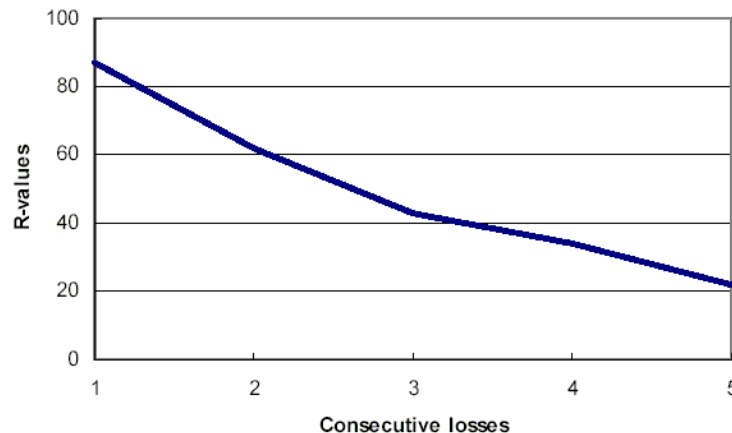

Figure 32. R-value as Function of Consecutive Loss (From: Ref 31)

3. Delay

In order to compare the delay effect on voice quality, the G.711 is again used to represent the perfect phone-graded signal before the different media delays are imposed. Effect of delay variation on R-value is illustrated in the following figure. The acceptable delay should be no more than 200-250 milliseconds corresponding to R-value of 80 as shown on graph.



Figure 33. R-value as Function of One-way Delay (From: Ref 31)

4. Combination of All Factors

The following figures present the reduction on R-value according to pairs of performance factors: delay - packet loss, delay - codec, and delay - echo. TELR (talker echo loudness rating) is used to differentiate echo level. The standard TELR at 65 dB is used as echo baseline.

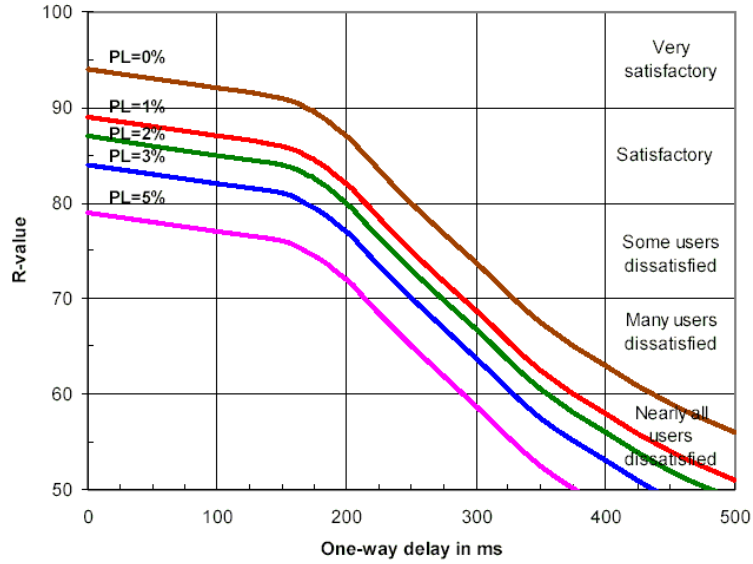

Figure 34. R-values as Function of Delay and Packet Loss (From: Ref 31)

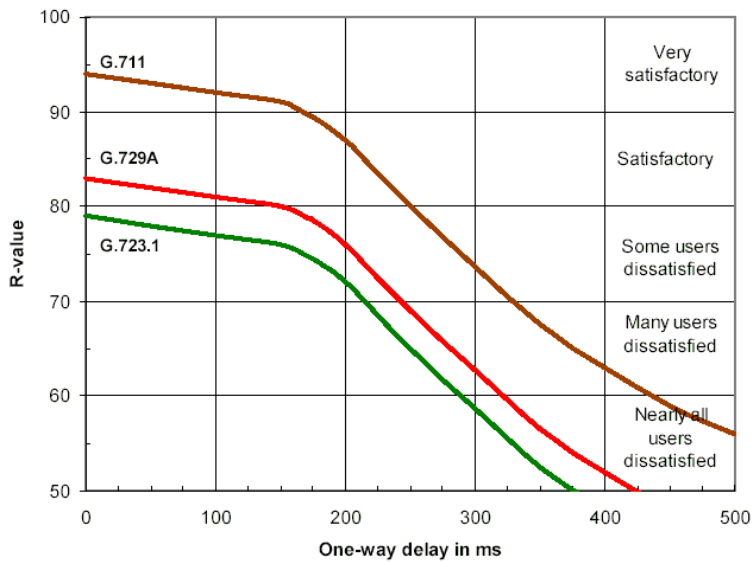

Figure 35. R-values as Function of Delay and Codec (From: Ref 31)

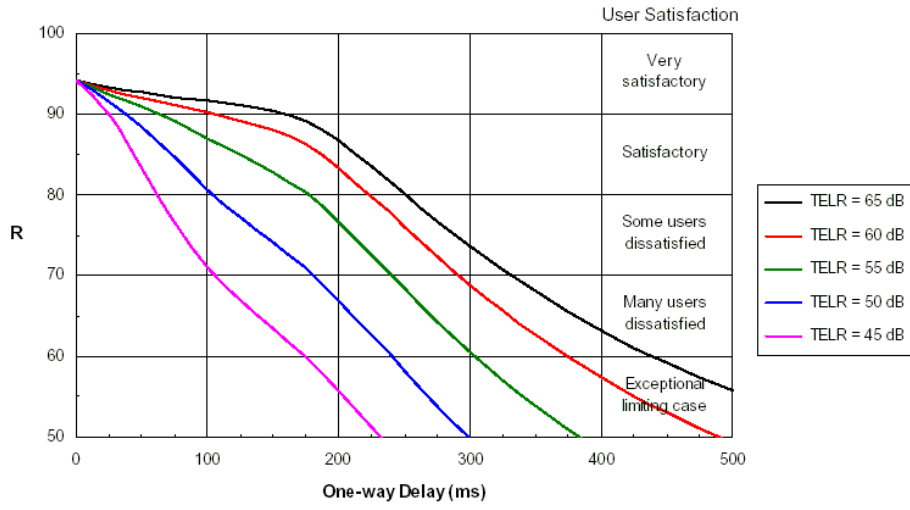

Figure 36. R-values as Function of Delay and Echo (From: Ref 32)

THIS PAGE INTENTIONALLY LEFT BLANK

VI. EXPERIMENT DESIGN

Using the correlation between subjective and objective scores as discussed in the previous chapter, MOS of a VoIP session can be derived from the E-Model by using the R-value conversion. The accuracy of the score relies on the fidelity of this model. For a public network, the inherent complexity of its uncontrollable, volatile environments makes the direct MOS measurement more appropriate. However, direct measurement requires a lot of resources to conduct. The simplicity of E-model makes it widely adopted in commercial VoIP quality monitoring applications.

A. TEST MATRIX

Voice quality (VQ) composes of three main components: clarity, delay, and echo. Clarity and echo are independent while echo relies on delay threshold. The proportional contribution that each factor affects VQ is pretty fuzzy since the subjective test can be interpreted in different ways. To easily manage the evaluation, only some most significant parameters should be strictly used on evaluation. However, the tested parameters must encompass all VQ characteristics.

To practically measure VQ, it is possible to discard some unnecessary variables. Four primary parameters sufficiently representing voice performance factors are delay, jitter, loss rate, and codec.

The first and most recognizable component, clarity, is measured by loss rate, jitter, and codec. However, since G.723.1 is the best codec choice selected by the industry, the codec war eventually disappears and this codec is supported by most applications. A test restricted by using this codec decreases the maximum MOS value as discussed in the previous chapter. So in this study, the codec variable is discarded from the tested parameter list. Only jitter and loss rate are evaluated for VQ clarity.

The next component, delay, is measured by the propagation time between hosts. In addition, the compression and packetization times are included in the overall delay.

The last component, echo, should be measured by TELR (Talker Echo Loudness Rating) and the end-to-end transmission time. According to the current VoIP application design, the echo canceller on the tail-end host performs effectively and diminishes the

echo amplitude to lower than -25 dB, which is unrecognizable by human. Moreover, echo presents a negative impact only when the end-to-end transmission time is beyond a certain threshold. So TELR is ignored and only the transmission time is measured in this study.

Therefore, the tests of this study are designed to measure delay, jitter, and loss rate. These objective parameters are also used in E-model and many VoIP performance measurement applications.

B. TOOLS USED

Microsoft NetMeeting 3.0 is selected due to its popularity and user-friendly interface. It supports the H.323 standards with capability to communicate via voice, video, chat, and whiteboard features. All call control, chat, and whiteboard use TCP connections whereas voice and video use UDP on randomly selected ports. NetMeeting is available at <http://www.microsoft.com>.

To collect all voice traffic, an open sourced protocol analyzer, Ethereal, is used. As the time of this study, the software is released with version 0.9.7. This release supports VoIP application protocols such as RTP, RTCP, TCP, UDP, and Q.931. Before Ethereal can be used, a Windows-platform packet capture driver, WinPcap, which offers the same functionality as TcpDump, must be installed. This test uses WinPcap 2.3 for Windows 2000 and WindowsXP. Both tools are available at <http://www.ethereal.com> and <http://winpcap.polito.it>.

The last tool used is a time synchronization application to manage system clocks before testing. NetTime 2.0 is used which runs the Simple Network Time Protocol (SNTP) on port 123. The standard NPS time server located on campus is referred from every host used in the test. This tool is available at <http://nettime.sourceforge.net/>.

C. TEST DESCRIPTION

The purpose of this research is to study the behavior of live VoIP traffic on real networks. Three objective performance parameters, delay, jitter, and loss rate, of the RTP data streams are measured. The measurements are used to determine the accuracy of the RTCP performance sampling method. Subjective VQ scores are also collected simultaneously. Since the tests are conducted on actual networks, the subjective

satisfaction score directly correlates to the three objective parameters. This score can be used to evaluate the accuracy of the E-model.

In all tests, NetMeeting with G.723.1 codec was used as the VoIP application. The baseline configuration is set up on a LAN in the Advanced Network research Lab of the Computer Science Department. The lab is located in Spanagel Hall room 238. No router is required in the baseline test. All test systems' clocks were synchronized to the same time server "time1.nps.navy.mil". No voice gateway or gatekeeper was installed. Calls were established across the network with live conversation. Voice background in the lab and external car noise were present during the test. Ethereal were installed on both NetMeeting host machines and set in promiscuous mode to record all voice packets with designated source and destination IP addresses. Echo cancellation and silence suppression were used during the test. The experiment was carried out by two NPS students who were already familiar with each other's speech rhythm. Before testing, all evaluators are briefed with test objective and score interpretation. Voice is recorded by using the headset and headphone with microphone. During the test, some lab machines generated HTTP traffic as in normal operation. Each test was conducted for 4-5 minutes.

The second test was conducted over WAN between NPS and an external commercial ISP operated by AAHawk Net. One side is a notebook connected on a dedicated personal LAN with a Linux gateway that has dial-up link to the ISP. The remote notebook is a Dell Latitude C600 with 1 GHz CPU, 1 GB RAM, and an ESS Maestro audio card. The gateway was running a NAT server. The other side is a desktop in the Advanced Network Research lab. This desktop is a Dell Precision 330 with 1.5 GHz CPU, 1 GB RAM, and a Turtle Beach Santa Cruz audio card. According to some preliminary evaluation, the desktop soundcard performs much better than the one on notebook. Test configuration is the same as the baseline test. During the test the remote gateway also generated FTP cross traffic to simulate bandwidth variation in a true WAN. More details on this test are presented in Section E below.

The third scenario was developed to test the NPS campus network after the recent backbone upgrade. The host in the Advanced Network Research Lab and another

machine in Root Hall were used in the test. The machines were connected via some switches and routers.

The fourth test was run over a wireless LAN with 64-bits encryption. The access point is installed in the Advanced Network Research Lab. One participant is a notebook equipped with D-Link Air DWL-650 adapters and capable to transmit messages using 802.11b protocol. The other node is a desktop in the same lab. During the test, the laptop is located approximately 40 meters away from the access point.

D. OVERALL TEST SCHEMA

All four test scenarios are illustrated in the following schema.

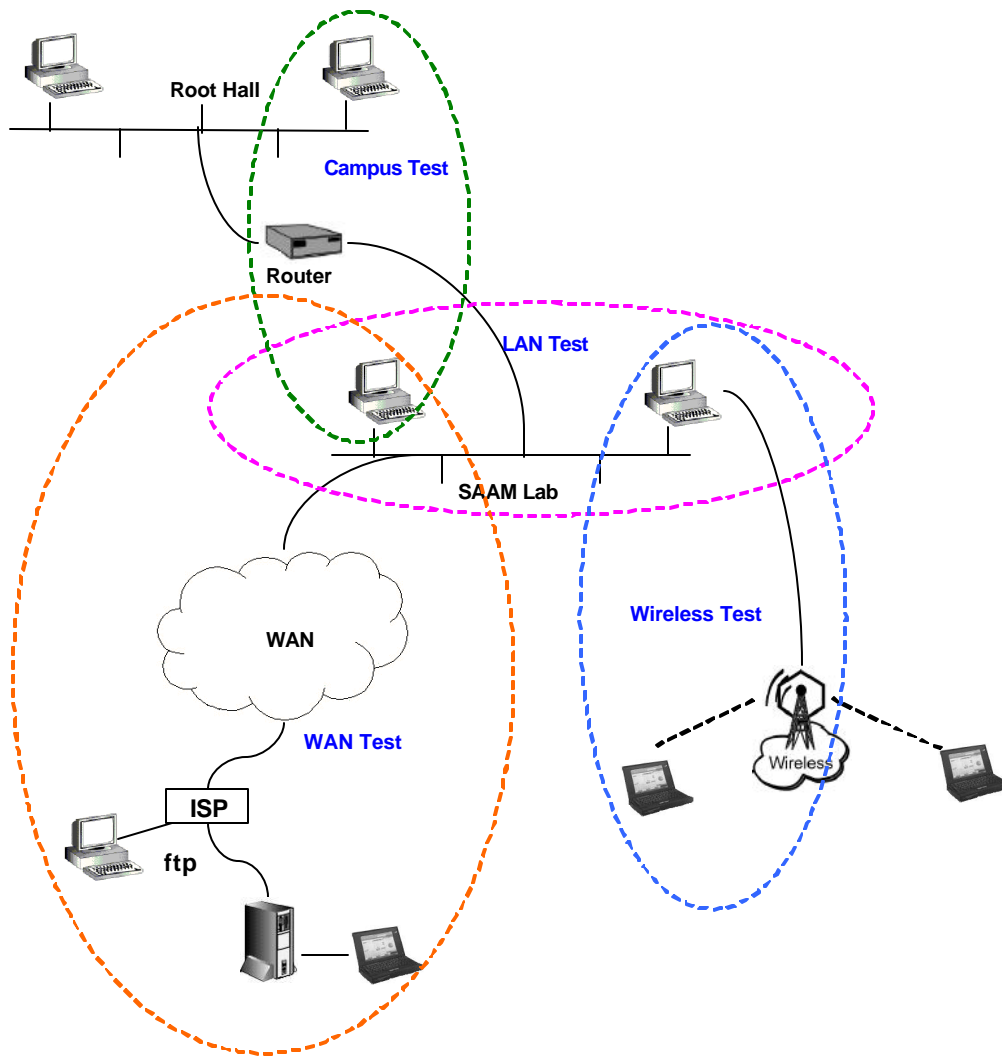

Figure 37. Test Schema

E. WAN TEST CONFIGURATION

1. WAN Test

Testing on WAN was conducted by setting up a NetMeeting session between an external laptop (berry) and a machine (cherry or magma) inside the NPS campus over a dial-up link, as shown below. Two test configurations were used and they are labeled case A and B in the diagram.

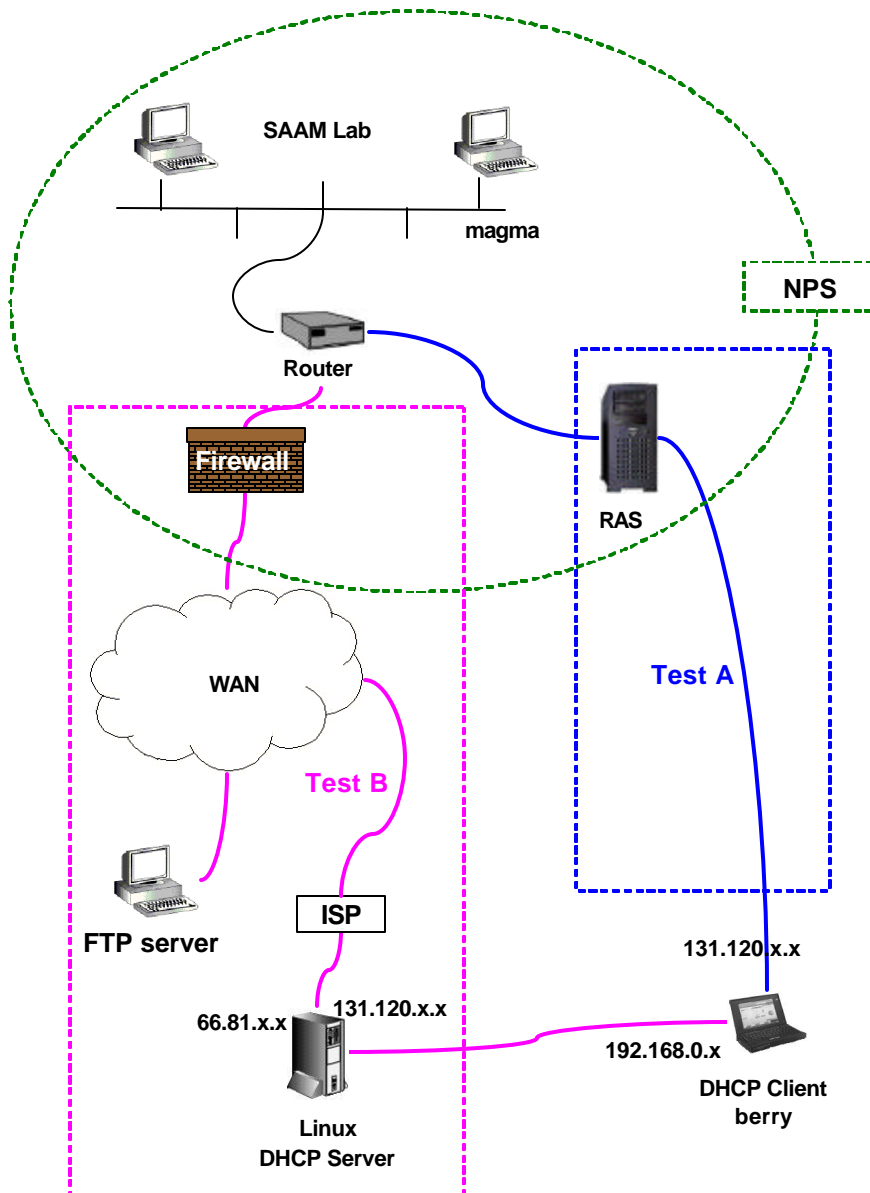

Figure 38. WAN Test Schema

2. NPS Firewall Issues

The ultimate goal of this test is to evaluate RTCP under large, fluctuating network delays. However, running MS NetMeeting crossing the NPS firewall is quite difficult because the NPS firewall rejects all external high-port (>1024) traffic. The NetMeeting application requires some of these ports as listed in the following table.

Table 12. Network Ports used by NetMeeting (After: Ref 33)

Port	Protocol	Type	Standard	NetMeeting Use
389	TCP	static	LDAP	Internet Locator Server (ILS)
522	TCP	static	ULP	User Location Service (deprecated, use ILS)
1503	TCP	static	imtc-mcs	T.120
1720	TCP	static	H323hostcall	H.323 call setup
1731	TCP	static	msiccp	Audio call control
1024-65535	TCP	dynamic	H.245	H.323 call control
1024-65535	UDP	dynamic	RTP/RTCP	H.323 streaming (RTP)

3. Test Configuration

The first test linked two VoIP nodes (berry and magma) via NPS's modem bank and Remote Access Server (RAS). This test is shown as Test A. Everything worked fine because the laptop (berry) was directly allocated an NPS internal IP address (131.120.x.x). Voice packets were able to communicate in both directions. Ethereal at magma (131.120.8.749) was able to record incoming voice packets and detect the source host IP address. However, Ethereal at berry did not work. Further inspections confirmed that Ethereal does not support dial-up links.

To address this limitation of Ethereal, a private LAN was created for the laptop client and a Linux machine added as a router between the voice client and the dial-up link. The Linux machine also performed as DHCP server and dynamically allocated its clients with the IP addresses ranging from 198.168.0.2 to 198.168.0.254. This new test setup is shown as Test B. During the test, the laptop communicated with the router via Ethernet, which allowed Ethereal to capture its outgoing voice packets. Moreover, to test on the larger delay and fluctuated environment, a commercial ISP was used instead of NPS RAS. However, voice packets were able to flow only one way, from the laptop to the

NPS machine magma. According to the captured information on berry, the client application was putting magma's address in the destination field and its own address (192.168.0.x) in the source field of its outgoing voice packets. Consequently, the outgoing voice packets from magma were assigned "192.168.0.x" in the destination field. This address is not part of the NPS address space so all voice packets from magma were blocked due to the NPS firewall policy. Thus, the client cannot hear any voice from the school machine. However, other applications such as text chat or whiteboard worked in both directions since all TCP high ports were opened, by firewall administrator after special request for this particular test, to allow H.323 call control establishment as listed in the previous port table. During the test, RTP-RTCP/UDP is used to convey voice packets while TCP is used to establish the communication channel and exchange the capability.

This problem was solved by installing a Network Address Translation (NAT) with masquerading service to the DHCP server running on the Linux router. The software, called e-smith, is available at <http://www.e-smith.org>. After installation of e-smith, the server was able to provide dynamic IP addresses to all clients. Moreover, it was configured to load the ip_masq_h323 module in order to map the inflow and outflow addresses of VoIP streams.

This test also connected two nodes through the Internet via a local commercial ISP. Before voice packets can be communicated, the NPS firewall must allow all high port UDP traffic for RTP/RTCP and allow all high port TCP traffic for H.323 call control. Configuring the NPS firewall proxy to permit these ports did not succeed in allowing such traffic either. The experiment was able to proceed after directly adjusting the NPS firewall filter. Finally, additional FTP traffic was added to the test environment to introduce variations of communication channel capacity at the Linux server. An FTP connection was established to download a large data file from an FTP server at www.freedrive.com and this file transfer required approximate 30 minutes to complete. This duration was long enough to cover the entire VoIP test which lasted for about 5 minutes. Furthermore, some HTTP traffic was generated by using a web browser. Before the real experiment data was collected, a few pre-tests were conducted to determine the effect of cross traffic. With one FTP connection, NetMeeting was able to establish the

communication. With one FTP and one HTTP connection, the VoIP communication was still possible. However, with one FTP and two HTTP connections, NetMeeting was not able to setup the connection. So, the experiment on WAN was conducted with one FTP and one HTTP connection as traffic.

As this configuration posed a security risk for the NPS network, an ad hoc IP address (cherry - 131.120.8.143) was temporarily used for the internal machine during the experiment. This address has been registered with the school DNS as a member of the SAAM domain. After the test, the machine's address was switched back to "magma". Moreover, Adware was used after each test to scan all memory, registry, and hard drive to discover and deal with potential intrusions. Adware is available to download at www.lavasoft.com.

F. DATA ANALYSIS METHOD

The captured packets were first loaded to Ethereal as UDP or TCP packets. Then the decode option of Ethereal was used to instantiate RTP or RTCP packets based on port numbers. Finally, the display filter was used to discard other types of packets.. Some pertinent information was then gathered and written to text files by using the print option available in Ethereal. The results were imported into MS Excel to determine RTP packet delay and jitter statistics. Excel macros were written to allow repetitive calculation. Analysis of data from the WAN test was quite difficult because, among more than ten thousand RTP packets, there were many instances of packet reordering and packet loss. Their detections required checking the RTP sequence number of each packet. Similar to RTP, derivation of RTCP information required matching one packet's LSR timestamp with another packet's MSW/LSW NTP timestamp. These processes are time-consuming when analyzing without automatic tools.

VII. TEST RESULTS

A. TEST RECORD

After the tests were completed, the raw transmission time of each individual RTP packet was determined. The clock drift was then estimated and the RTP packet delay was adjusted accordingly. This RTP delay was also used to calculate the inter-arrival jitter. Moreover, RTCP messages were analyzed to obtain the RTP delay and jitter samples. These values were then plotted in the same graph for comparison purpose.

B. TEST SUMMARY

Tests on LAN were conducted twice, to compare the model accuracy. The campus test, wireless test, and WAN test were performed once. For the wireless test, traffic in only one direction (from laptop to desktop) could be recorded by Ethereal. To determine the clock drift between the laptop and desktop, they were temporarily connected using a crossover cable and a series of pings were sent from one host to the other. Ethereal captured the departure and arrival times of these ping messages at the hosts. Since the communication delay in this setup was negligible, the difference of the departure and arrival times of a ping message was used as one sample for clock drift.

In all graphs presented below, the names of test computers are abbreviated in the following way: m for magma (desktop), c for cherry (desktop), and b for berry (laptop).

According to the results from the LAN and campus tests, the transmission delay of RTP packet in such environments is very low. For the wireless LAN test, the average delay was a little bit longer. The WAN test produced the largest delays. Every test was first evaluated based on the assumption of symmetric delay. Only for the WAN test, asymmetric delays were also considered.

C. LAN TEST

Test Code : Test 101, 102
Description : VoIP on LAN
Location : SAAM Research Lab, SP-238

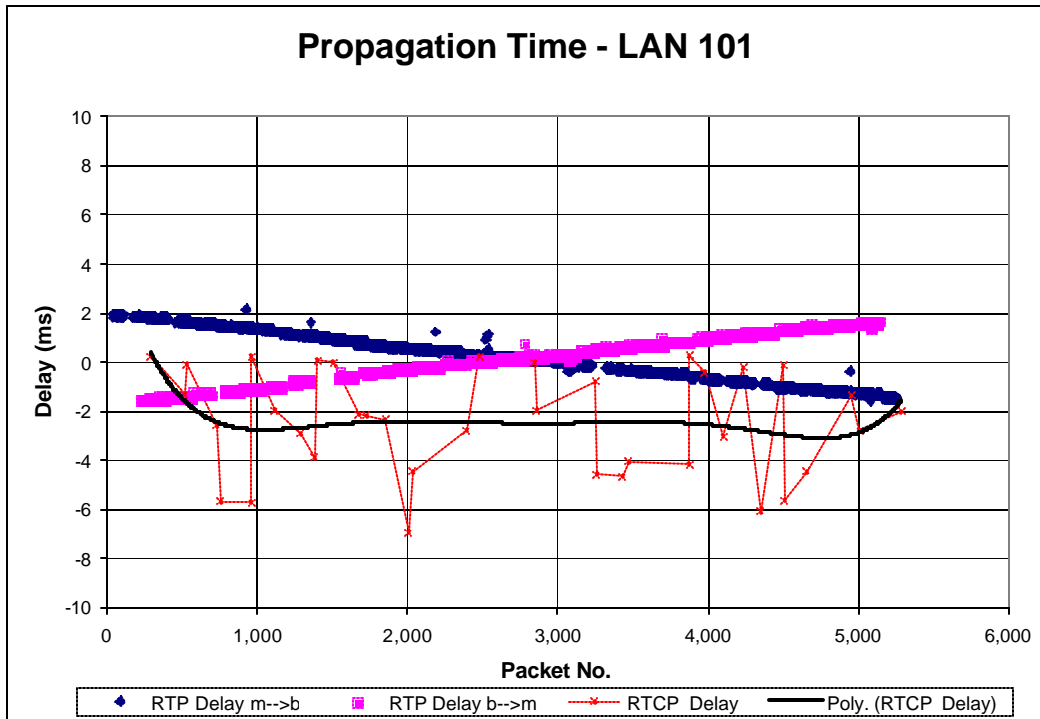

Figure 39. LAN Test Result (1)

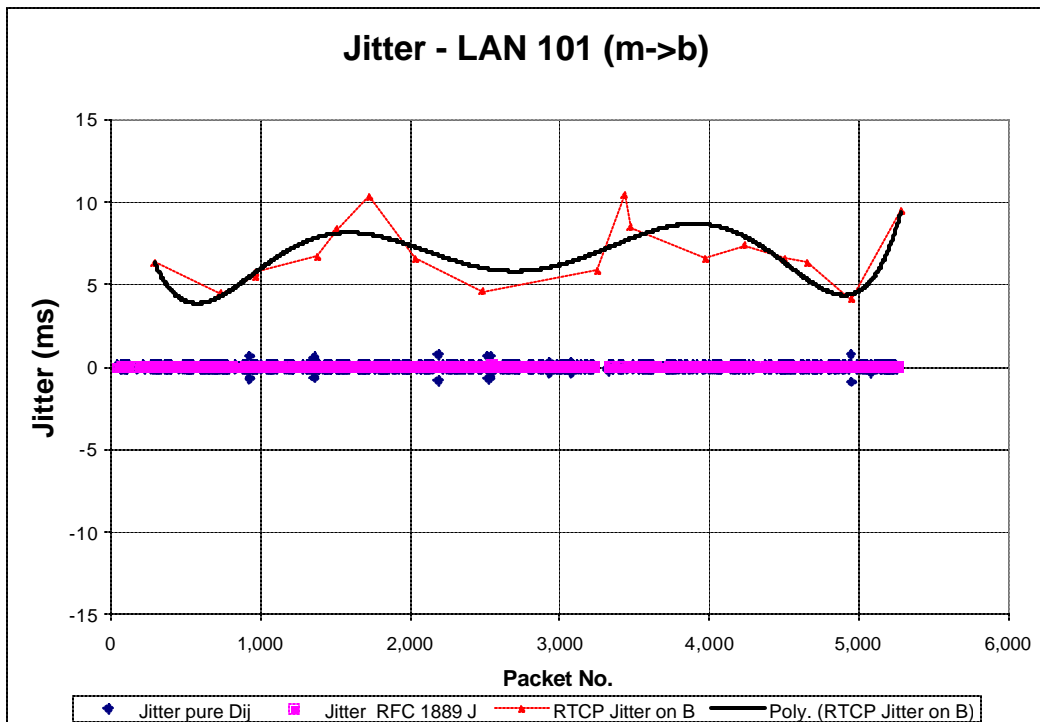

Figure 40. LAN Test Result (2)

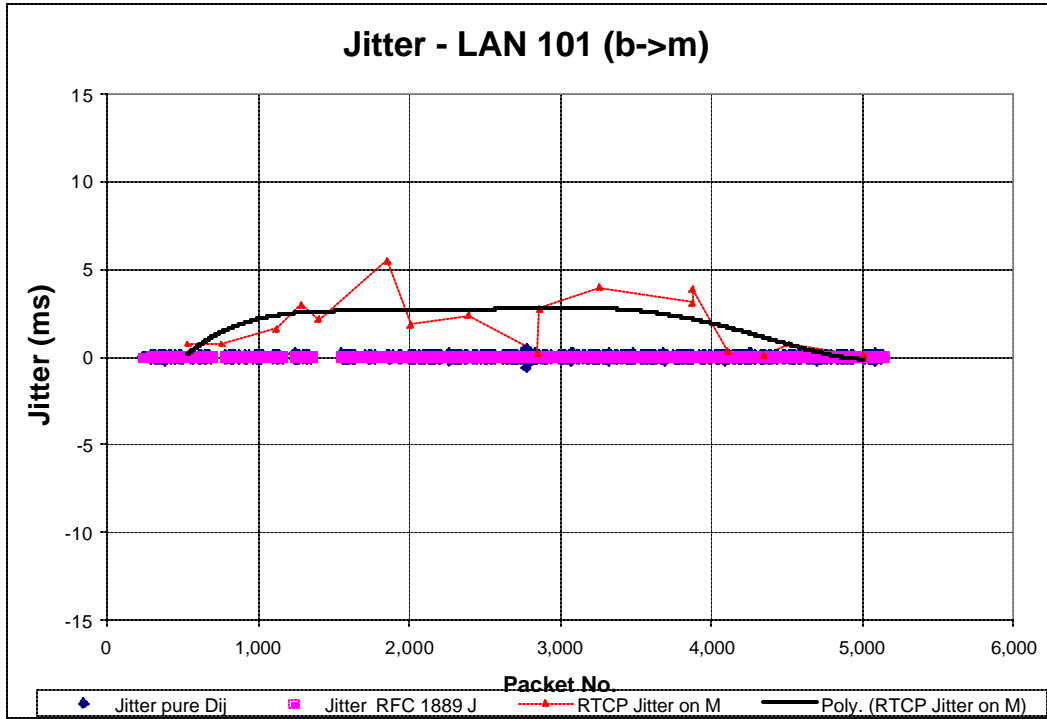

Figure 41. LAN Test Result (3)

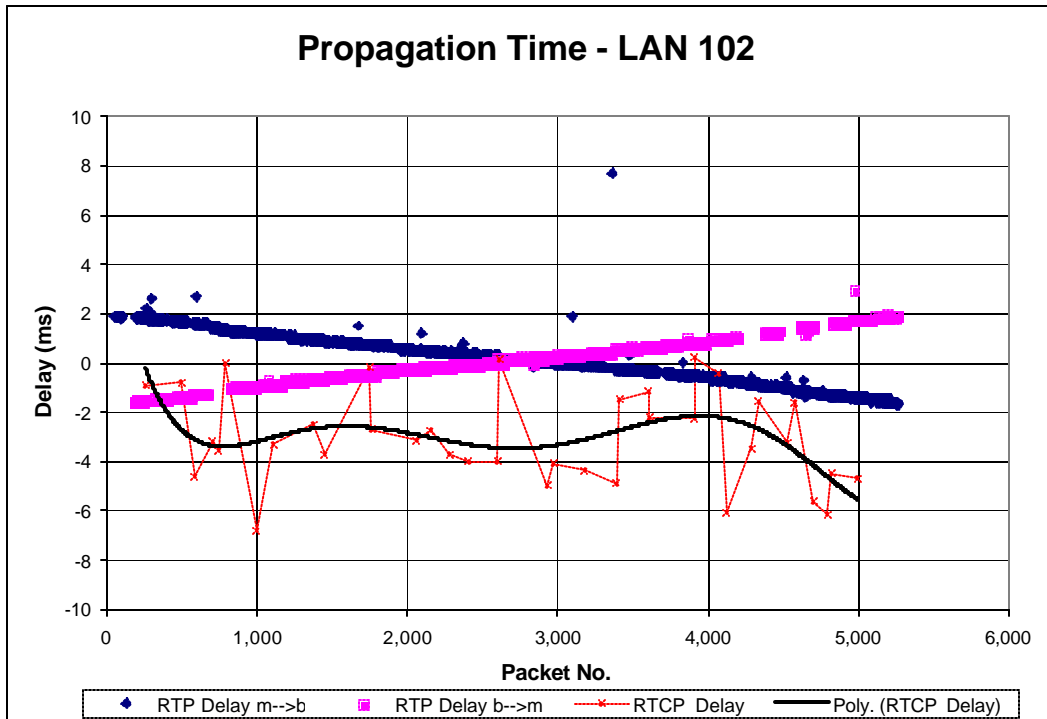

Figure 42. LAN Test Result (4)

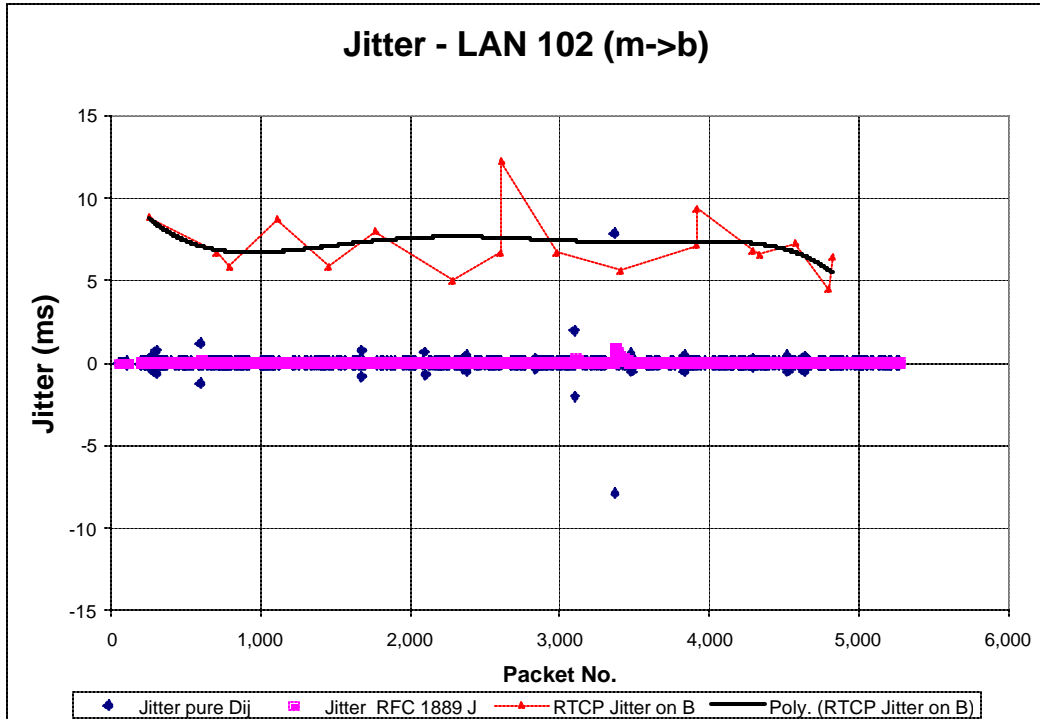

Figure 43. LAN Test Result (5)

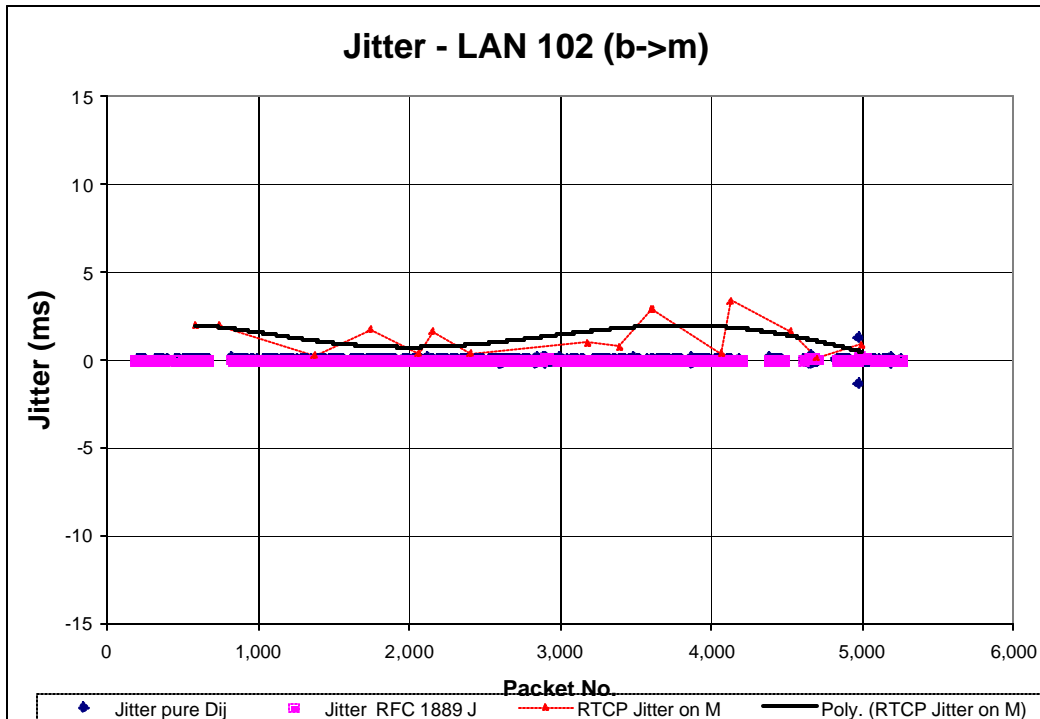

Figure 44. LAN Test Result (6)

D. CAMPUS TEST

Test Code : Test 301

Description : VoIP on NPS Campus

Location : School network between Root Hall and Spanegel Hall

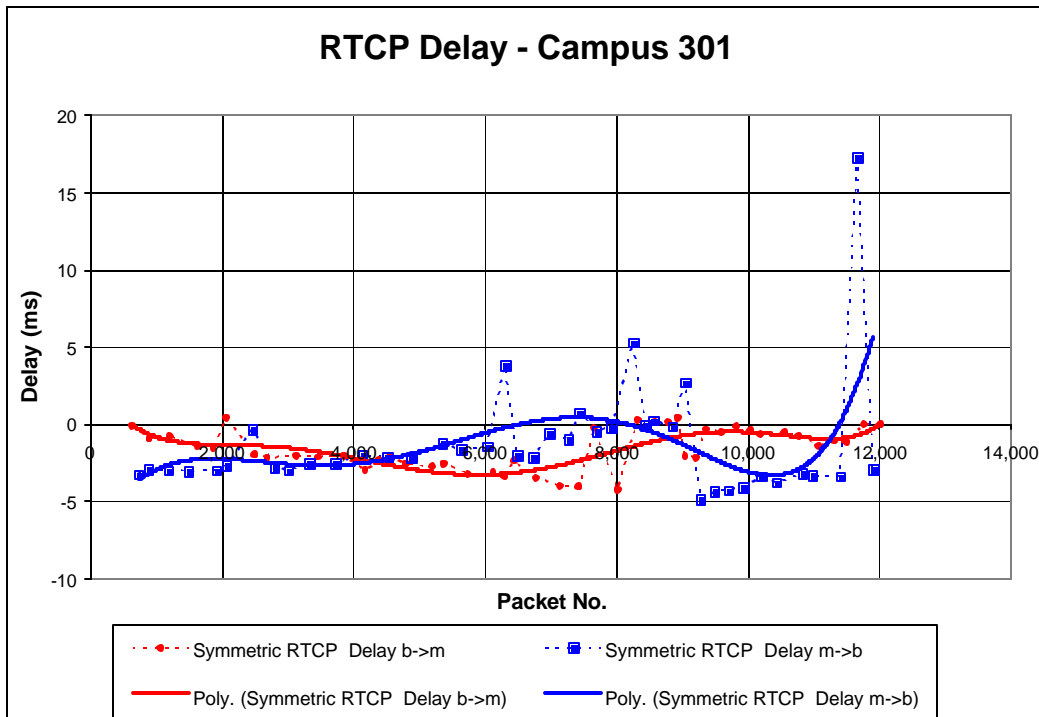

Figure 45. Campus Test Result (1)

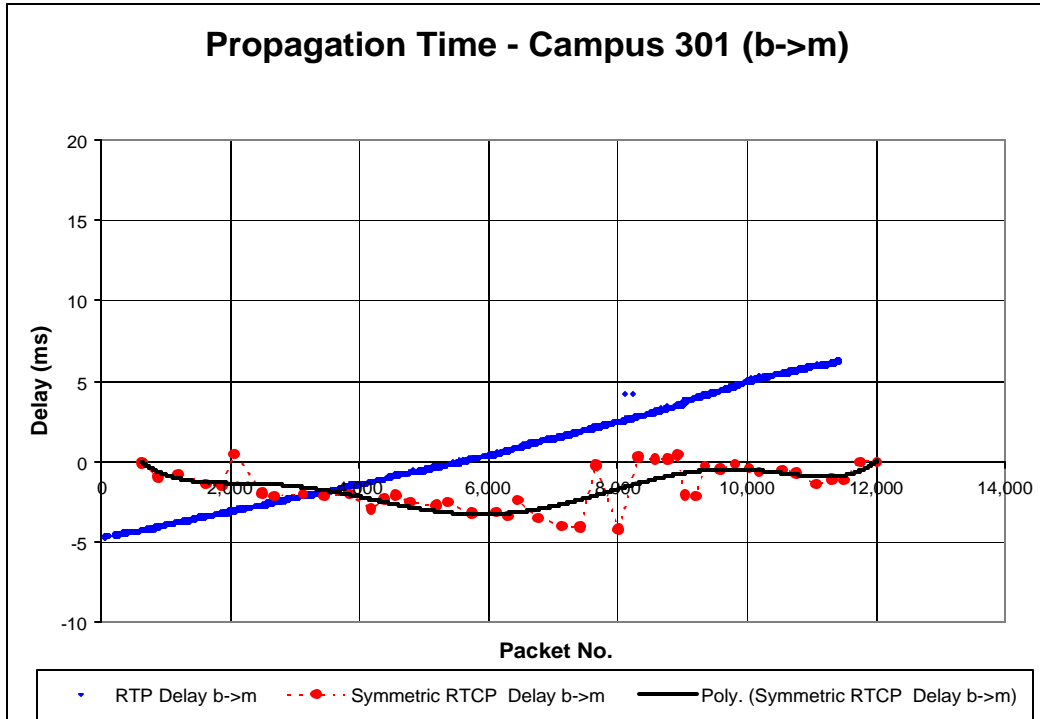

Figure 46. Campus Test Result (2)

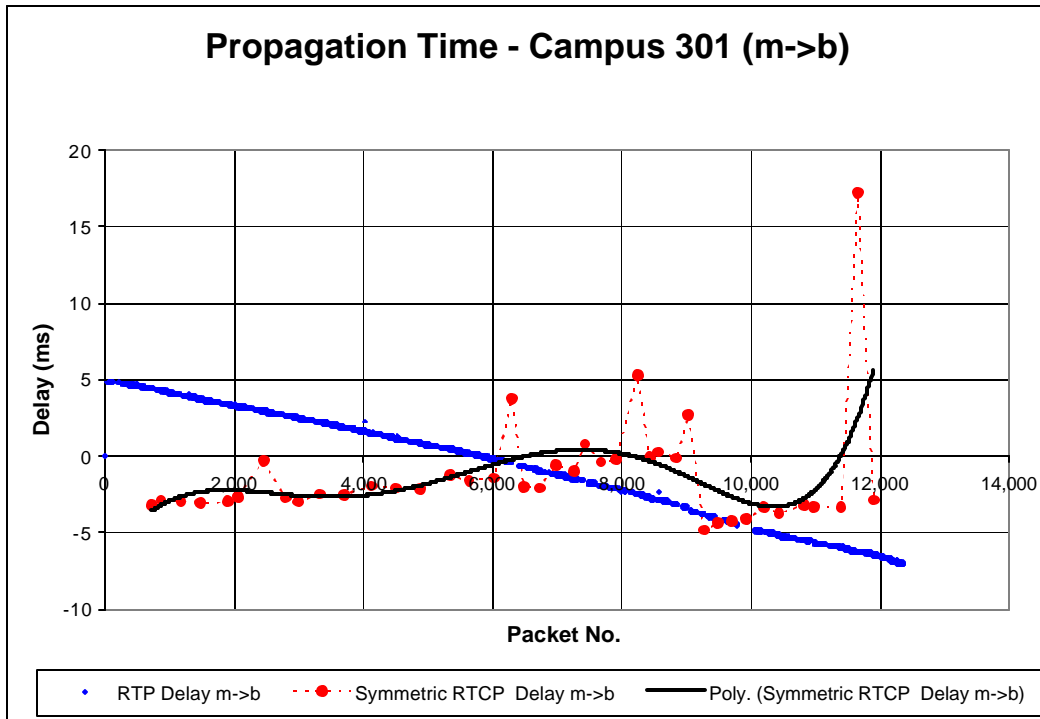

Figure 47. Campus Test Result (3)

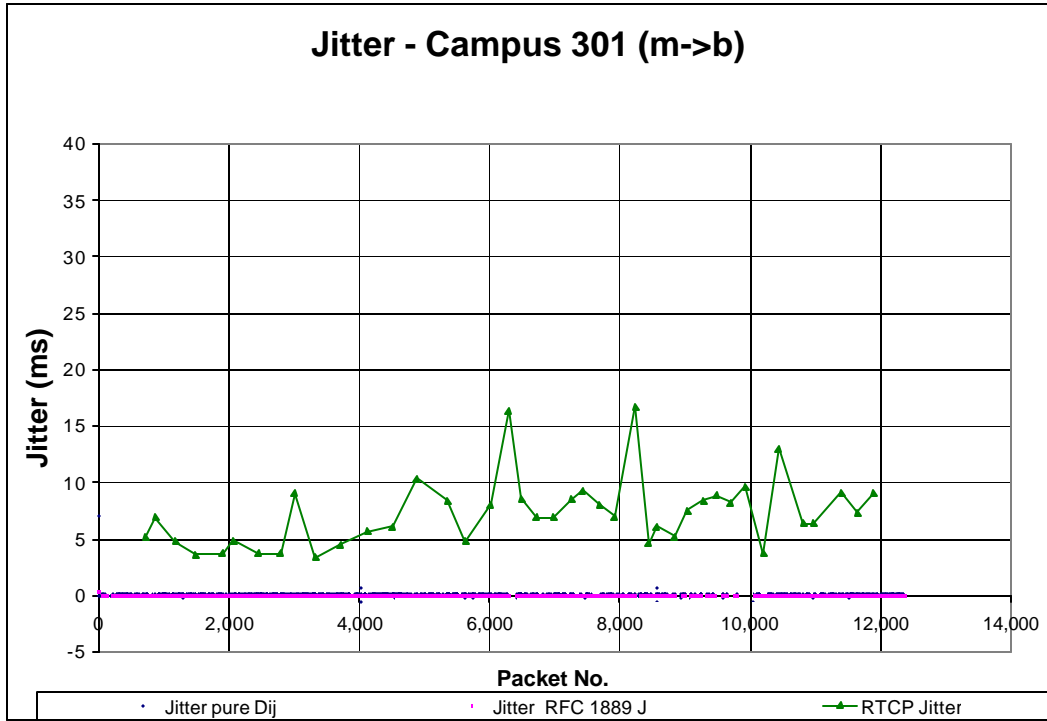

Figure 48. Campus Test Result (4)

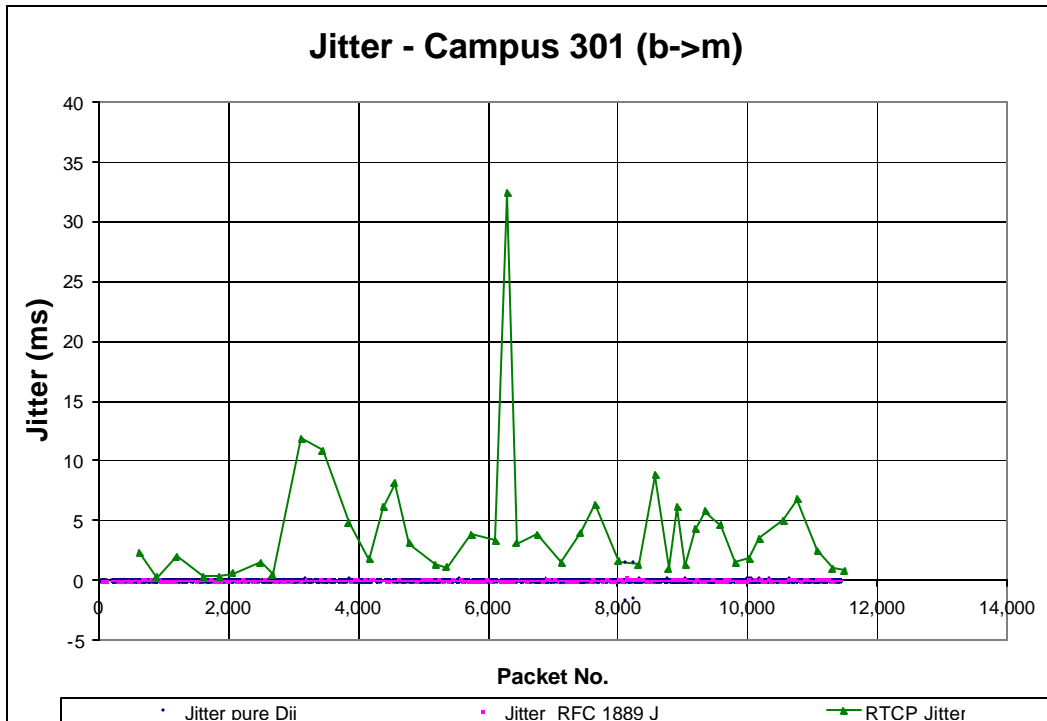

Figure 49. Campus Test Result (5)

E. WAN TEST

Test Code : Test 201

Description : VoIP on WAN

Location : Link between computer in NPS network lab in Spanagel Hall and remote home computer using regular dial-in to commercial ISP

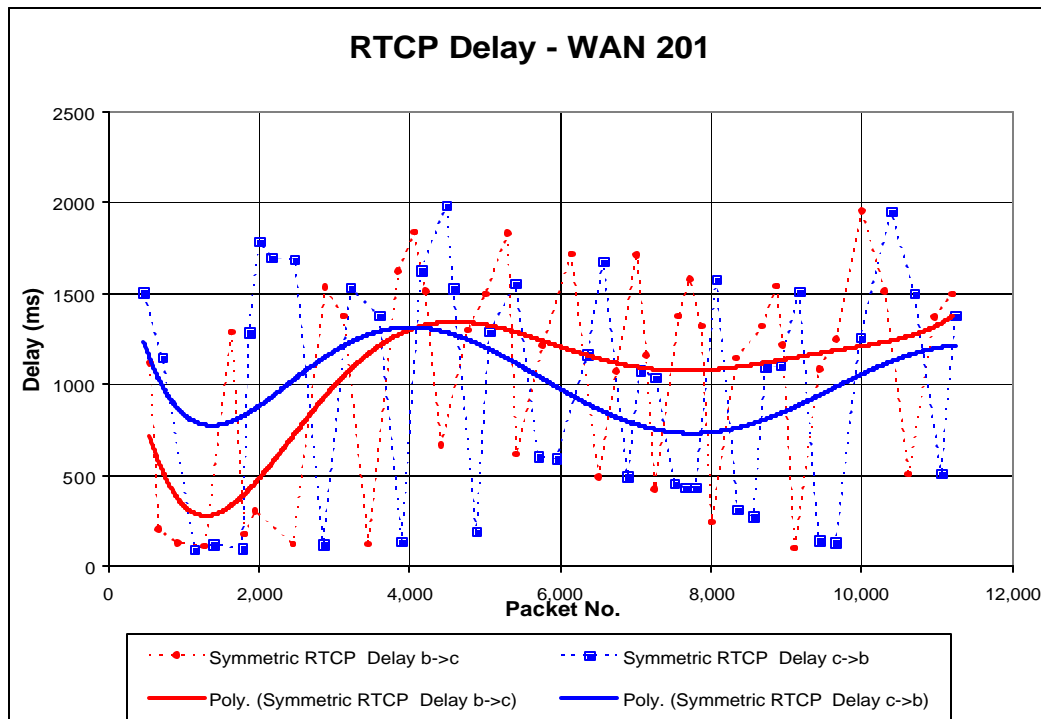

Figure 50. WAN Test Result (1)

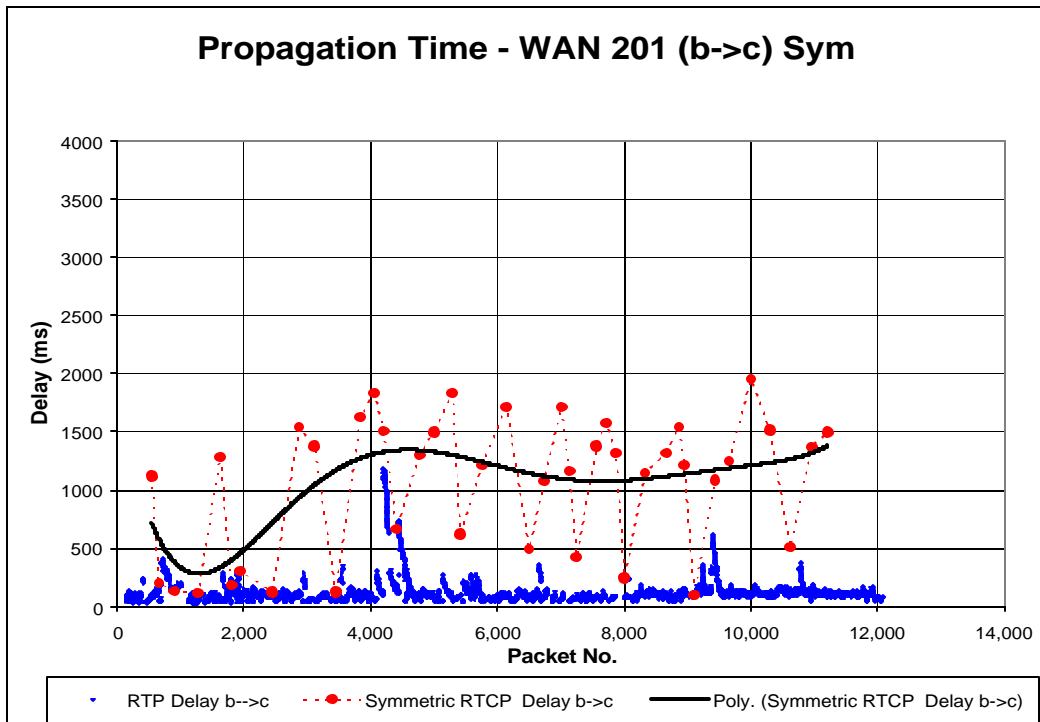

Figure 51. WAN Test Result (2)

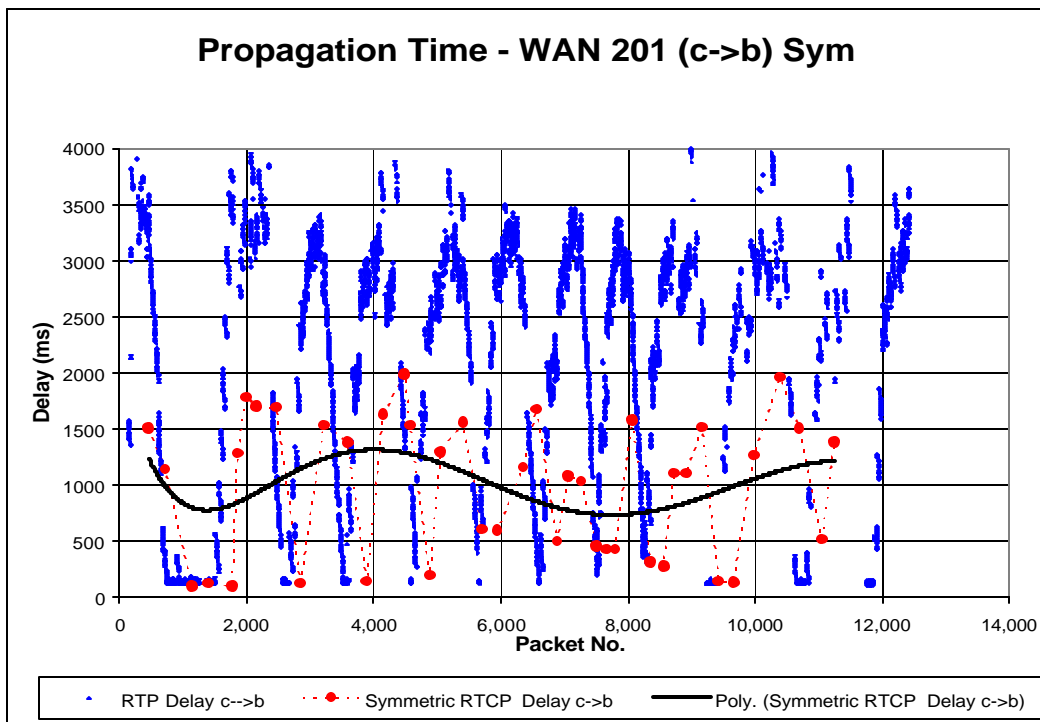

Figure 52. WAN Test Result (3)

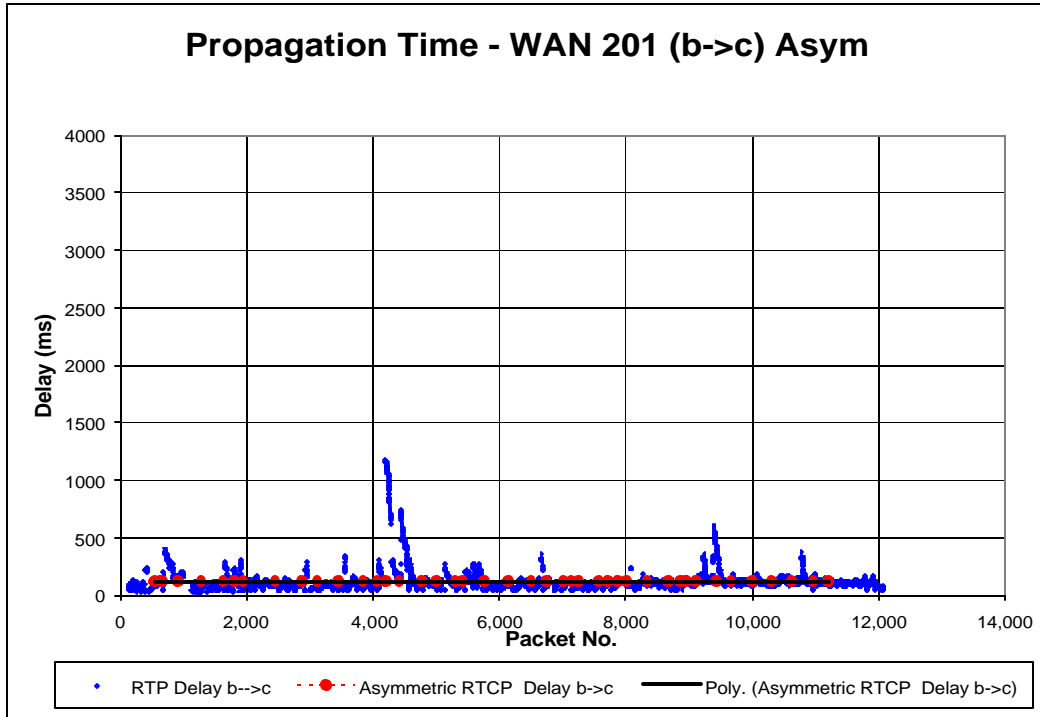

Figure 53. WAN Test Result (4)

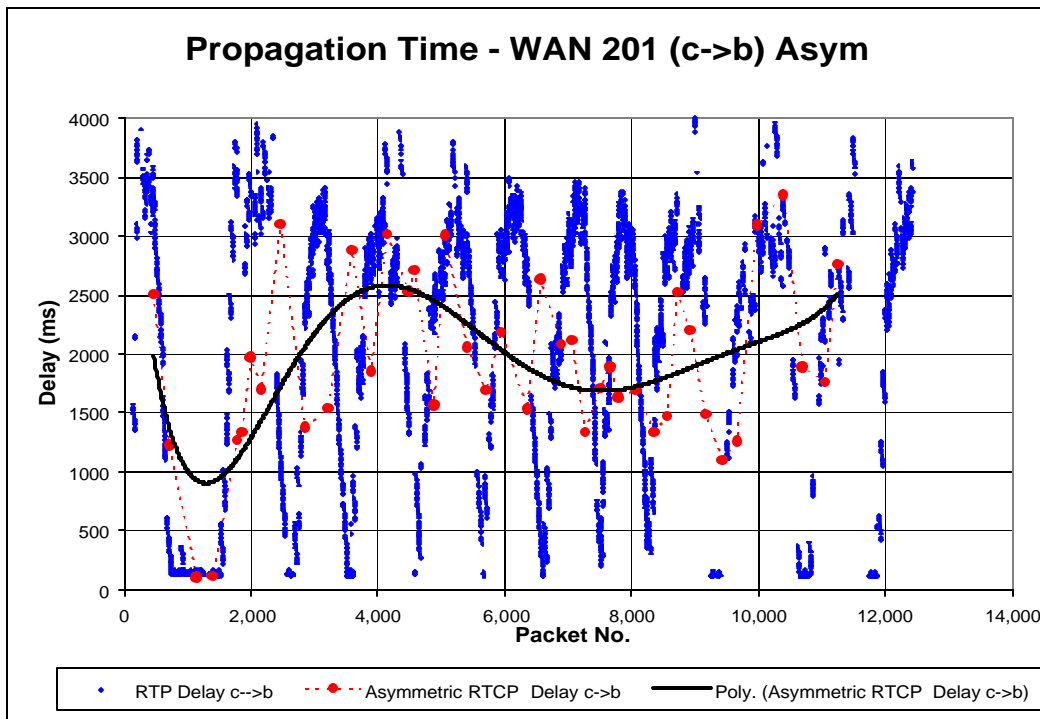

Figure 54. WAN Test Result (5)

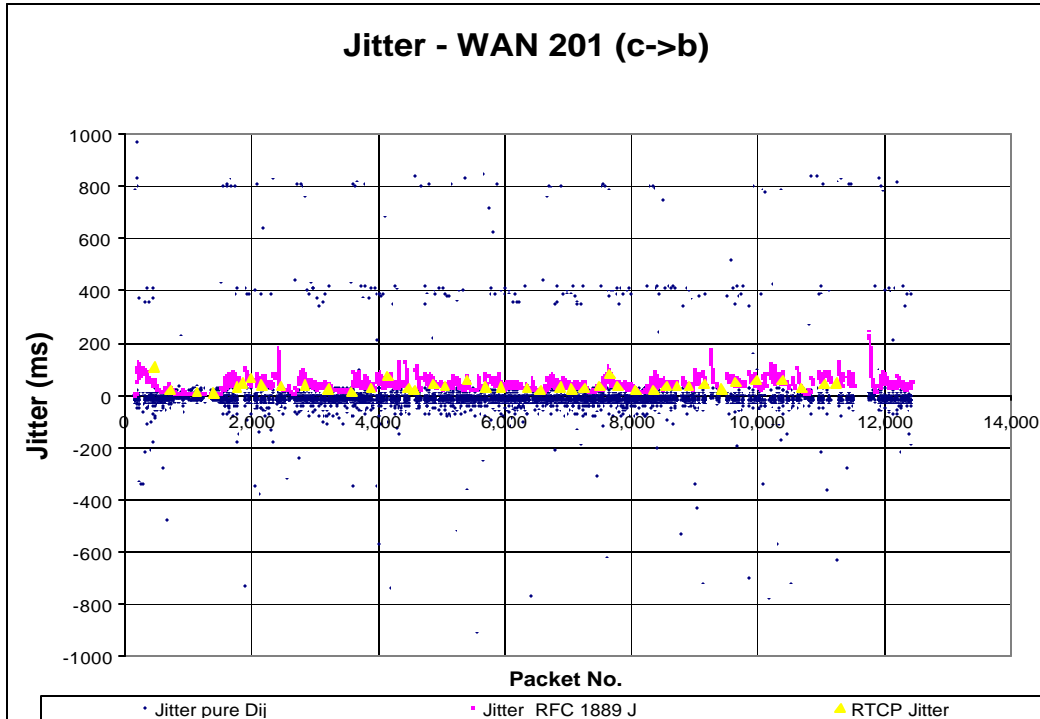

Figure 55. WAN Test Result (6)

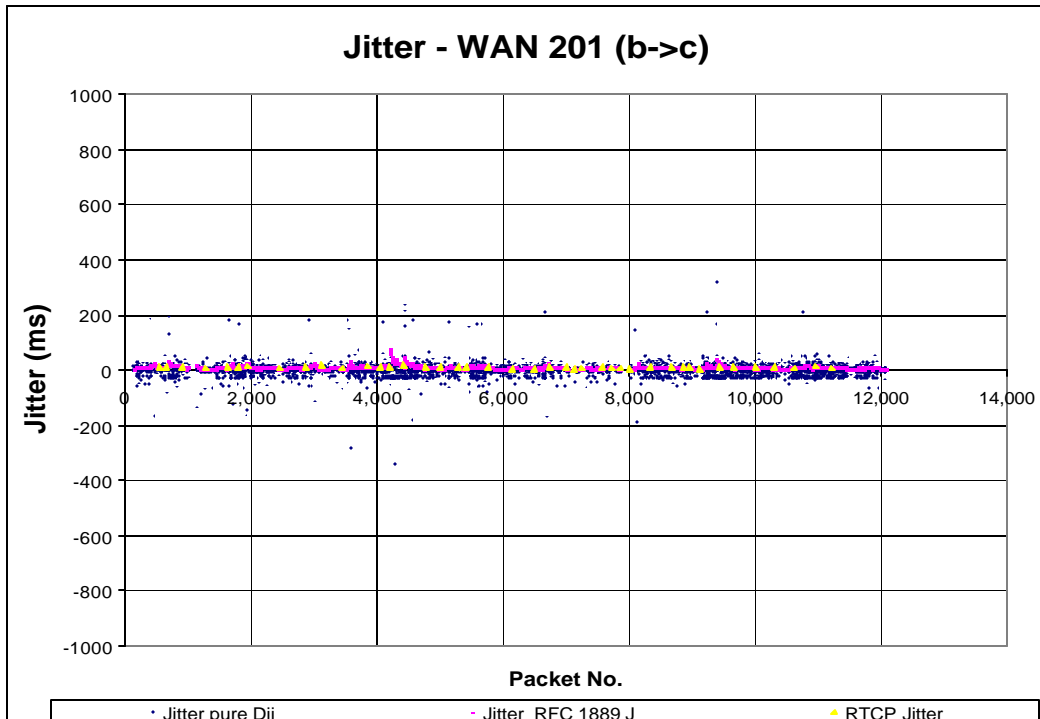

Figure 56. WAN Test Result (7)

F. WIRELESS TEST

Test Code : Test 401

Description : VoIP on Wireless LAN

Location : SAAM wireless LAN in Spanagel Hall

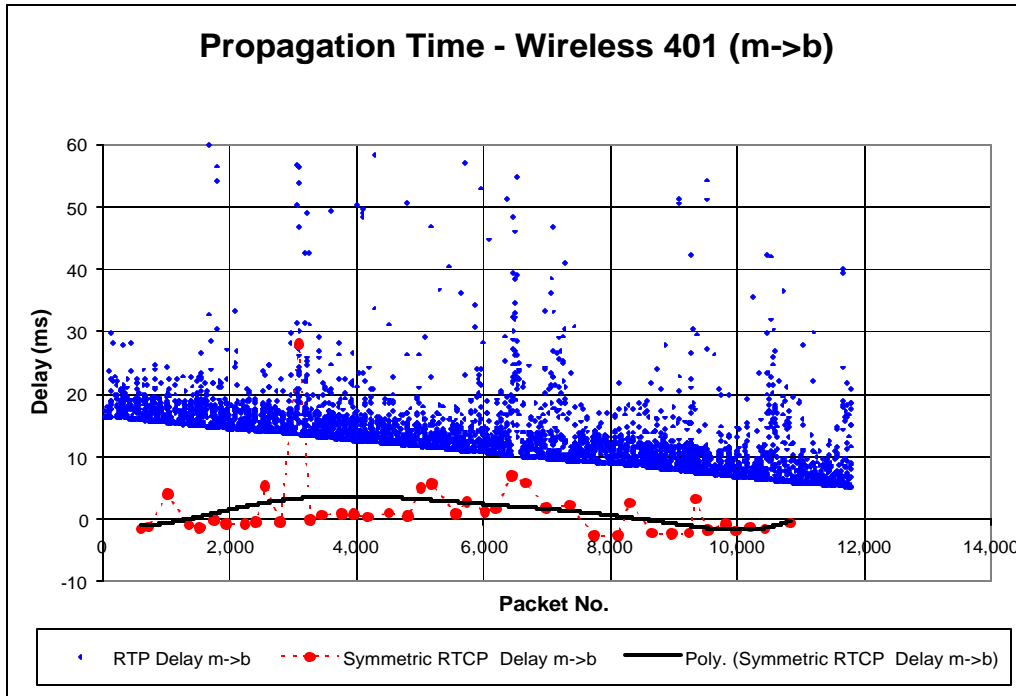

Figure 57. Wireless Test Result (1)

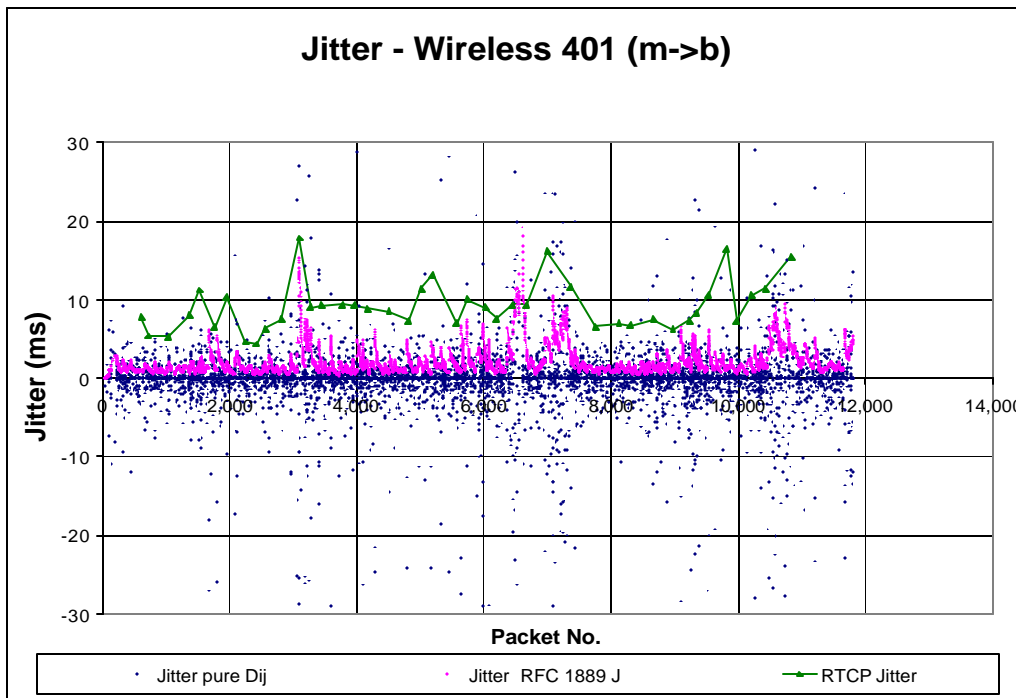

Figure 58. Wireless Test Result (2)

G. MOS RESULT

The following table summarizes the average score of the test result.

Table 13. Test MOS

Test	MOS	
	Magma to Berry	Berry to Magma
LAN	2.7	2.7
Campus	2.2	3.5
WAN	2.7	3.2
Wireless	3.2	3.5

THIS PAGE INTENTIONALLY LEFT BLANK

VIII. DATA ANALYSIS

A. GENERAL

The collected data shows that all RTP packets are 78 bytes long while the RTCP packet sizes range from 86 to 130 bytes depending on the type of report appended. NetMeeting was configured to run with G.723.1 at 6.3 kbps data rate for audio using the default silence suppression algorithm. The voice payload is 24 bytes long. The absence of redundant voice blocks implies that NetMeeting did not use FEC mechanism.

In the 14 bytes of IP header, the TOS field had all zeros, corresponding to the following priority:

0000 00	DSCP (Differentiate Service Code Point)	Default 0
0	ECT (ECN-Capable Transport)	Default 0
0	ECN-CE	

The default code point indicates that no expedite request mechanism was turned on for all voice packets. The UDP header is 8 bytes long while the RTP header has a regular length of 12 bytes. In other words, no header compression was used during the tests.

Some RSVP messages were generated to reserve path for voice packets but they have little impact since no WFQ, MPLS, and TOS mechanisms were set up on the routers. The FTP cross traffic seemed to cause the delay to fluctuate in only one direction.

B. CLOCK

Some RTP packets have negative delay value as a result of Microsoft Windows' low clock granularity at 10 ms. These negative numbers are acceptable since they are minimal. Testing on clock drift with a crossover cable shows that two different computers may run on different clock speed. The system clock on the desktop with 1.5 GHz CPU always runs slightly faster than the one on the notebook with 1 GHz CPU. The phenomena makes clock drift between the two systems grow larger as time goes by. Moreover, after restarting the system, the clock drift jumps significantly unlike the linear drift increase during normal operation. The inconsistent drift makes all delay values on each packet constantly deviate from the fixed number and shown as slant line in the propagation time graphs of LAN, Campus, and Wireless tests.

C. LAN TEST

The average RTP propagation time during the LAN test is approximate 1 ms while RTCP reports small negative delay values due to coarse clock granularity. The average pure jitter and the RFC 1889 jitter have the same value while RTCP reports a little higher number. This difference can be considered negligible. The packet loss is reported as 0, consistent with the real RTP packet count. So, RTCP is accurate in a LAN environment.

D. CAMPUS TEST

The test on NPS campus was conducted after a major infrastructure upgrade. All results are very similar to those in the LAN environment. RTCP still reports small negative delays while RTP propagation times are about 1 ms. Moreover, the jitter level is small with an average of less than 10 ms. RTCP reports zero packet loss while the actual loss rate is in the range of 0.01%. Therefore in this environment, RTCP is reliable to report RTP behaviors.

The small delay and loss rate values indicate that NPS backbone is appropriate for VoIP applications. However, audio card quality is found to be a major factor affecting VQ. With a low-grade soundcard, testers can experience echo and voice distortion though the voice was fully intelligible.

E. WAN TEST

Data collected from the WAN test shows that the FTP cross traffic causes large delay fluctuations for RTP packets, ranging from 120 to 3900 ms. On the other direction without FTP data traffic, the delay is pretty stable at approximate 121 ms. This value is not exactly accurate due to clock drift, however, it lies within reasonable delay range. A separate test with ping reported an average roundtrip time of 140 ms.

With the assumption that the propagation times are symmetric, the half value of RTCP sample delays cannot represent the actual delay pattern of all RTP packets. When asymmetric delays are considered by using a constant delay at 121 ms in one direction, RTCP delay trend seems to be more realistic but is still not close to the real delay. For the direction with large delay fluctuations, RTCP reports a packet loss rate of 4.7% while the real loss rate is at 5.1%. So the difference is small. The other direction has 0 packet loss rate, matching the 0 loss rate reported by RTCP in this direction.

The following graph shows the consistency of RTCP report of roundtrip time in each direction. Both provide the similar trend on roundtrip time except for small differences in some reports. Overall RTCP reports consistent information about roundtrip time.

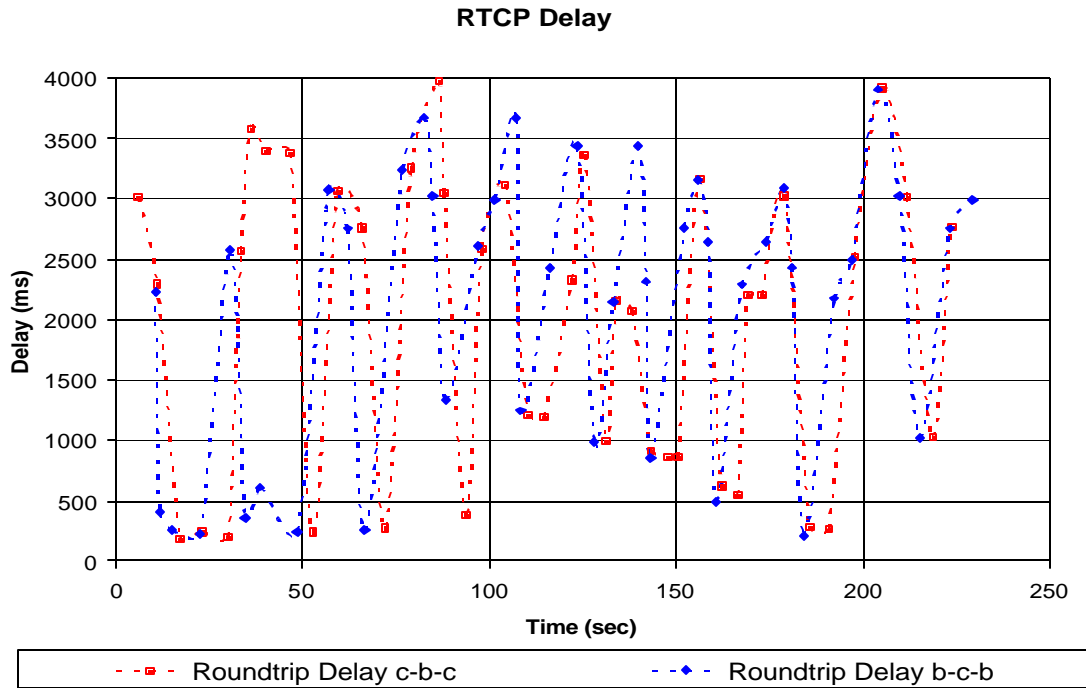

Figure 59. RTCP Consistency

The accuracy of RTCP delay samples is also evaluated. All RTP one-way delay values of both directions between RTCP pairs are averaged and summed up to form the average RTP roundtrip delay. This number is compared with the derived RTCP roundtrip delay samples in the following graph. Even their trends are the same but RTCP mostly overestimate and underestimate the RTP by a significant amount. The root mean square error is 1,003 ms. The average absolute error is 750 ms.

Comparison of Roundtrip Time

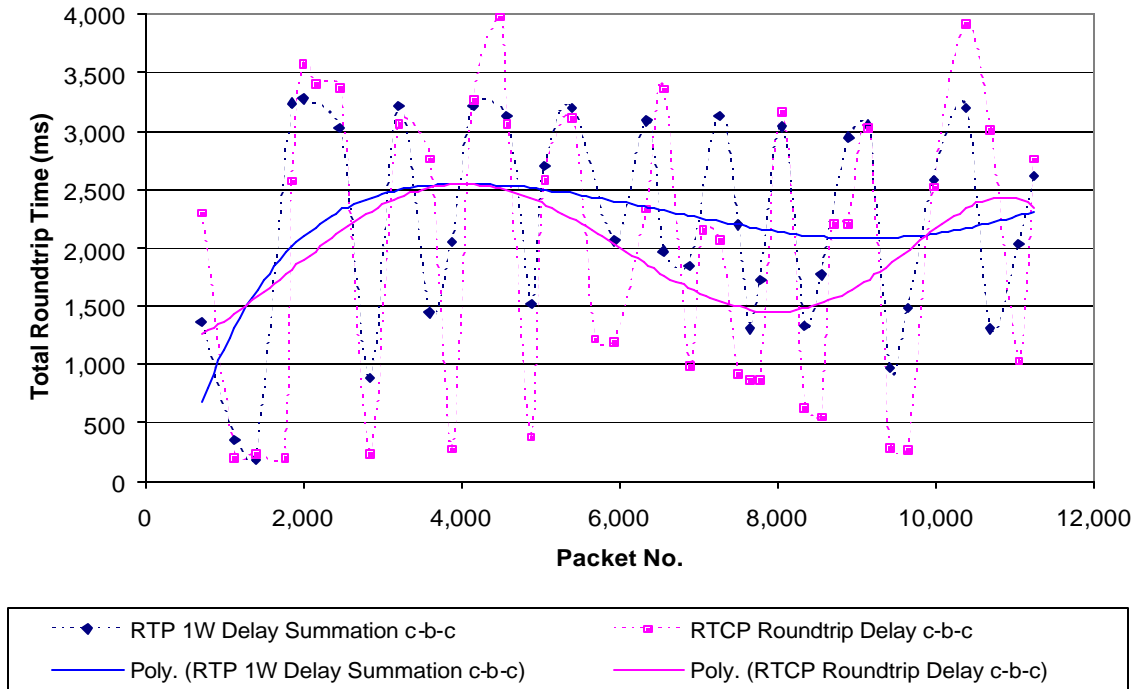

Figure 60. RTCP Accuracy

F. WIRELESS TEST

Data collected from the encrypted wireless LAN test indicates that the average RTP packet delay is approximately 10 ms. This test was conducted in a worst case scenario where the test node was far away from the access point and the signal strength indicator turned yellow. The raw capacity was approximate 2 Mbps. RTCP works consistently with RTP on reporting the delay. The jitter is minimal and there is no packet loss.

G. MOS

Voice traffic with delay over 250 ms was still intelligible but a user must temporarily wait before responding. Without echo, the VQ was considered acceptable because the users already expect the quality to be less than the traditional telephone grade. The quality of headphone is another issue to be considered since it affects a lot of hearing satisfaction. Anyway, it is not suitable to use the test values to evaluate the E

model because of the ad hoc selections of test environments and tester group. This may be a good area for further study.

H. RATIO OF RTP AND RTCP PACKETS

The protocol analyzer collected a total of 84 RTCP packets and a total of 11,738 RTP packets. Thus the SR generation rate is approximate 0.72 % of that of RTP message generation.

THIS PAGE INTENTIONALLY LEFT BLANK

IX. SUMMARY

A. TEST SUMMARY

To estimate the performance of a VoIP application, the most popular method is to monitor the RTCP packets. Testing on low delay networks – such as LAN, campus backbone, and wireless LAN – has demonstrated high reliability of the RTCP performance sampling method even though there are small distortions due to coarse host clock granularity. However, testing on a public network with large delay variations has indicated a low accuracy for the RTCP report mechanism. This deficiency may be caused by the low sampling rate of the RTCP method.

In a session with few participants, typically RTCP messages are sent approximately every 5 seconds. However, in a multi-party conference, RTCP messages may be sent out every 30 seconds because this protocol is designed to be scalable to accommodate thousands of users. According to this design, the more participants in the conference, the less frequently each terminal sends RTCP packets. As RTCP is designed to provide feedback information on the quality of data distribution, the corresponding VoIP application will use this data to diagnose faults and control how RTP packets might be sent. Therefore, reliability of RTCP may become a major issue for large multi-party conferences.

The WAN test shows that the symmetric delay approach that has been often used in prior research may not be suitable. It is more appropriate to determine the delay in each direction because each user may experience different VQ.

Finally, the test results indicate that NPS infrastructure is ready for deployment of VoIP, even with encrypted wireless LAN extensions. The voice transport delay is found to be very low and does not affect VQ. However, the network administrator should configure routers to support DiffServ and RSVP to give voice data precedence over relatively delay-insensitive traffic (Web, email, etc.).

B. FUTURE WORK

This study has discovered that the RTCP mechanism of estimating VoIP performance may be ineffective over networks with large, volatile delays. Despite some

drawbacks, RTCP is widely used to determine the performance of real-time multimedia applications. Therefore, RTCP should be enhanced to provide more accurate information. It might be possible to adapt the RTCP report interval to suit such a requirement. This implementation can be evaluated on the same WAN test environment used by this research.

Another interesting area for future work is the E-model. Since E-model was developed in a controlled environment and tested with one individual performance factor at a time, there might be some redundancy when all factors are integrated to one model. Testing on real environments can further validate this model but a lot of resources are required.

Finally, it will be interesting to test the performance of video phone applications. The integration of voice and video media may further test the reliability of RTCP since the media frame size is much larger and more bandwidth is required.

GLOSSARY

ACR	Absolute Category Rating
ARQ	Automatic Repeat reQuest
CNG	Comfort Noise Generator
DSP	Digital Signal Processor
EN	Enterprise Network
ERL	Echo Return Loss
FEC	Forward Error Correction
FEC	Front-End Clipping
HOT	Holdover Time
IETF	Internet Engineering Task Force
IEC	International Engineering Consortium
IP	Internet Protocol
IPX	Internet Packet Exchange
ISDN	Integrated Services Digital Network
IT	Information Technology
IWF	Inter-Working Function
LAN	Local Area Network
LSR	Last Sender Report
MAN	Metropolitan Area Network
MCU	Multipoint Control Unit
MLSNCC	Maximum Length Sequence Normalized Cross-Correlation
MOS	Mean Opinion Score
NTP	Network Time Protocol
PAMS	Perceptual Analysis Measurement System
PBX	Private Branch Exchange
PCM	Pulse Code Modulation
PING	Packet Internet Groper
PSQM	Perceptual Speech-Quality Measurement
PSTN	Public Switching Telephone Network
RAS	Registration, Admission, and Status
RAS	Remote Authentication Service
RR	Receiver Report

RSVP	Resource Reservation Protocol
RTCP	Real-time Transport Control Protocol
RTP	Real-time Transport Protocol
SCN	Switched-Circuit Network
SIP	Session Initiation Protocol
SNTP	Simple Network Time Protocol
SR	Sender Report
TCP	Transmission Control Protocol
TELR	Talker Echo Loudness Rating
UDP	User Datagram Protocol
VAD	Voice Activity Detector
VoIP	Voice over Internet Protocol
VPN	Virtual Private Network
VQ	Voice Quality
WAN	Wide Area Network
WEP	Wired Equivalent Privacy
WFQ	Weighted Fair Queuing

LIST OF REFERENCES

- [1] Lucent Technologies, “MultiVoice VoIP Solutions, Revenue Opportunities for Service Providers”, whitepaper, [<http://www.lucent.com>], 2000.
- [2] Intel Corporation, “IP Telephony Basics”, [http://www.intel.com/network/csp/resources/white_papers/4070web.htm], 1999.
- [3] Elachi, Joanna, “VoIP Market Growing Rapidly”, [<http://www.commweb.com/article/COM2001040S0006>], 2001.
- [4] Lucent Technologies, “Voice over IP Profit Guide for Service Providers”, white paper, [<http://www.lucent.com>], 1999.
- [5] TIA, Telecommunication Industry Association, “Market Development: VoIP Market Positioned for Sustained Robust Growth”, *Pulse Online*, Volume 2, Issue 9, [<http://pulse.tiaonline.org>], July 2001.
- [6] ITU-T Recommendation H.323, *Packet-Based Multimedia Communication Systems*, 1999.
- [7] Equivalence, “H.323 Standards”, [<http://www.openh323.org>], 2002.
- [8] The Internet Engineering Consortium, “H. 323”, Web ProForum Tutorials, [<http://www.iec.org>], June 2002.
- [9] The Internet Engineering Consortium, “Internet Telephony”, Web ProForum Tutorials, [<http://www.iec.org>], June 2001.
- [10] The Internet Engineering Consortium, “Voice and Fax over Internet Protocol (V/FoIP)”, Web ProForum Tutorials, [<http://www.iec.org>], March 2002.
- [11] Cisco System, “Understanding Delay in Packet Voice Networks”, white paper, [<http://www.cisco.com>], July 2002.
- [12] Tom Sheldon and Big Sur Multimedia, “Compression Techniques”, [<http://www.linktionary.com/c/compression.html>], August 2002.
- [13] RFC 1889, *RTP: A Transport Protocol for Real-Time Applications*, Schulzrinne, H., et al., January 1996.
- [14] Cisco System, “Cisco IP Telephony QoS Design Guide”, white paper, [<http://www.cisco.com>], July 2002.
- [15] The Internet Engineering Consortium, “Voice Quality (VQ) in Converging Telephony and IP Networks”, Web ProForum Tutorials, [<http://www.iec.org>], July 2002.

- [16] Mockingbird Networks, “Transporting Voice over IP : The Issues of Quality, Echo, and Latency”, white paper, [http://www.mockingbirdnetworks.com/pdfs/wp_transportvoice.pdf], June 2002.
- [17] Miyata, T., Fukuda, H., and Ono, S., “New Network QoS Measures for FEC-based Audio Applications on the Internet”, IEEE 1998, pp 355-362.
- [18] Hall, Timothy A., “Objective Speech Quality Measures for Internet Telephony”, National Institute of Standards and Technology, April 2000.
- [19] Pearsall, Susan, and Waller, John Q., “Doing a VoIP Assessment with Chariot VoIP Assessor”, white paper, [www.netiq.com], May 2002.
- [20] Meeting conversation between Xie, Geoffrey, Naval Postgraduate School and the author, April- August 2002.
- [21] RFC 1305, *Network Time Protocol (version 3): Specification, Implementation, and Analysis*, Mill, David L., March 1992.
- [22] RFC 1769, *Simple Network Time Protocol (SNTP)*, Mills, D., March 1995.
- [23] Brandolini, Shala, and Green, Darin, “The Windows Time Service”, Microsoft Windows 2000 Server Technical Article, [www.microsoft.com/windows2000/server], April 2000.
- [24] Fonseca, Jose and Stanton, Michael, “A Methodology for Performance Analysis of Real-Time Continuous Media Applications”, paper presented at the 12th International Workshop on Distributed Systems: Operations and Management (DSOM 2001), Nancy, France, 15 October 2001.
- [25] GPS Clock, “GPS Clock for Time Synchronization”, [www.gpsclock.com], 2001.
- [26] ITU-T Recommendation P.800, *Methods for Subjective Determination of Transmission Quality*.
- [27] net.com, “The Mean Opinion Score”, white paper, [www.net.com/products/narrowband/repository/white_papers/mos_wp], March 2002.
- [28] Walker, John Q., and Hicks, Jeffrey T., “Planning for VoIP”, Net IQ Corporation white paper, [www.netiq.com], April 2002.
- [29] ITU-T Recommendation G.107, *The E-Model, a computational model for use in transmission planning*.
- [30] Cisco System, “VoIP - Understanding Codecs: Complexity, Support, MOS, and Negotiation”, white paper, [http://www.cisco.com/warp/public/788/voip/codec_complexity.html], May 2002.

- [31] NetPredict, “Assess the Ability of Your Network To Handle VoIP Before You Commit”, white paper, [www.netpredict.com], April 2002.
- [32] Telecommunications Industry Association, “PN-4689 Voice Quality Recommendations for IP Telephony”, [http://ftp.tiaonline.org/tr-41/Tr4112/Public/Latest_Revision_of_PN-4689/PN4689.pdf], June 2002.
- [33] Shenton, Chris, “Netmeeting Security Concerns and Deployment Issues”, [<http://www.shenton.org/~chris/nasa-hq/netmeeting/>], October 1998.

THIS PAGE INTENTIONALLY LEFT BLANK

BIBLIOGRAPHY

Nguyen, T., et.al, "Voice over IP Service and Performance in Satellite Networks", IEEE Communications Magazine, pp. 164-171, March 2001.

THIS PAGE INTENTIONALLY LEFT BLANK

INITIAL DISTRIBUTION LIST

1. Defense Technical Information Center
Ft. Belvoir, Virginia
2. Dudley Knox Library
Naval Postgraduate School
Monterey, California
3. Professor Peter J. Denning, Code CS
Naval Postgraduate School
Monterey, CA 93943-5100
4. Professor Geoffry Xie, code CS/XI
Naval Postgraduate School
Monterey, CA 93943-5100
5. Professor Burt Lundy, code CS/LN
Naval Postgraduate School
Monterey, CA 93943-5100