



# Efficiency of High-Speed Helical Gear Trains

Robert F. Handschuh  
U.S. Army Research Laboratory, Glenn Research Center, Cleveland, Ohio

Charles J. Kilmain  
Bell Helicopter Textron Inc., Fort Worth, Texas

**DISTRIBUTION STATEMENT A**  
Approved for Public Release  
Distribution Unlimited

20030523 088

## The NASA STI Program Office . . . in Profile

Since its founding, NASA has been dedicated to the advancement of aeronautics and space science. The NASA Scientific and Technical Information (STI) Program Office plays a key part in helping NASA maintain this important role.

The NASA STI Program Office is operated by Langley Research Center, the Lead Center for NASA's scientific and technical information. The NASA STI Program Office provides access to the NASA STI Database, the largest collection of aeronautical and space science STI in the world. The Program Office is also NASA's institutional mechanism for disseminating the results of its research and development activities. These results are published by NASA in the NASA STI Report Series, which includes the following report types:

- **TECHNICAL PUBLICATION.** Reports of completed research or a major significant phase of research that present the results of NASA programs and include extensive data or theoretical analysis. Includes compilations of significant scientific and technical data and information deemed to be of continuing reference value. NASA's counterpart of peer-reviewed formal professional papers but has less stringent limitations on manuscript length and extent of graphic presentations.
- **TECHNICAL MEMORANDUM.** Scientific and technical findings that are preliminary or of specialized interest, e.g., quick release reports, working papers, and bibliographies that contain minimal annotation. Does not contain extensive analysis.
- **CONTRACTOR REPORT.** Scientific and technical findings by NASA-sponsored contractors and grantees.
- **CONFERENCE PUBLICATION.** Collected papers from scientific and technical conferences, symposia, seminars, or other meetings sponsored or cosponsored by NASA.
- **SPECIAL PUBLICATION.** Scientific, technical, or historical information from NASA programs, projects, and missions, often concerned with subjects having substantial public interest.
- **TECHNICAL TRANSLATION.** English-language translations of foreign scientific and technical material pertinent to NASA's mission.

Specialized services that complement the STI Program Office's diverse offerings include creating custom thesauri, building customized databases, organizing and publishing research results . . . even providing videos.

For more information about the NASA STI Program Office, see the following:

- Access the NASA STI Program Home Page at <http://www.sti.nasa.gov>
- E-mail your question via the Internet to [help@sti.nasa.gov](mailto:help@sti.nasa.gov)
- Fax your question to the NASA Access Help Desk at 301-621-0134
- Telephone the NASA Access Help Desk at 301-621-0390
- Write to:  
NASA Access Help Desk  
NASA Center for Aerospace Information  
7121 Standard Drive  
Hanover, MD 21076



# Efficiency of High-Speed Helical Gear Trains

Robert F. Handschuh  
U.S. Army Research Laboratory, Glenn Research Center, Cleveland, Ohio

Charles J. Kilmain  
Bell Helicopter Textron Inc., Fort Worth, Texas

Prepared for the  
59th Annual Forum and Technology Display  
sponsored by the American Helicopter Society  
Phoenix, Arizona, May 6-8, 2003

National Aeronautics and  
Space Administration

Glenn Research Center

The Propulsion and Power Program at  
NASA Glenn Research Center sponsored this work.

Available from

NASA Center for Aerospace Information  
7121 Standard Drive  
Hanover, MD 21076

National Technical Information Service  
5285 Port Royal Road  
Springfield, VA 22100

Available electronically at <http://gltrs.grc.nasa.gov>

# Efficiency of High-Speed Helical Gear Trains

Robert F. Handschuh  
U.S. Army Research Laboratory  
Glenn Research Center  
Cleveland, Ohio 44135

Charles J. Kilmain  
Bell Helicopter  
Textron, Inc.  
Fort Worth, Texas 76101

## Abstract

An experimental and analytical comparison of the efficiency of high-speed helical gear trains is presented. An analysis of the gearing losses was conducted and was used as a comparison to the measured losses. Test data from a helical gear train at varying speeds and loads (to 3730 KW (5000 hp) and 15000 RPM) was collected. A comparison of the results indicated that drive system rotational speed had the most detrimental effect to the efficiency of the gear system at light load and windage losses approached or exceeded the gear meshing losses at high speed and load conditions.

## Introduction

A tiltrotor rotorcraft can takeoff like a helicopter and fly like an airplane. The aircraft, shown in figure 1, has tilting nacelles at each end of the wing to facilitate both helicopter and airplane mode operation. During helicopter operation, the nacelles are vertical allowing vertical takeoffs and landings and hover mode operation. While in flight, the nacelles can tilt forward, to airplane mode, allowing forward "airplane mode" flight.

The configuration of the aircraft presents interesting challenges to the drive system configuration and design. The basic configuration of the drive system is shown in figures 2 and 3 (ref. 1). Each nacelle contains an engine, proprotor gearbox (PRGB) and a tiltaxis gearbox (TAGB). There is a cross shafting system, interconnect shafting system (ISS), along the back of the wing that mechanically locks the two rotors together. The ISS also drives a mid-wing gearbox (MWGB) in the center on the wing. Each PRGB and TAGB operates through 120° of aircraft nacelle attitude, 20° nose down (airplane mode) to 10° back tilt (10° past vertical in

helicopter mode). The engine drives the PRGB which transfers the power and reduces the speed to the mast. The PRGB also drives the TAGB. The aircraft configuration dictated that the engine and mast not have common centerlines (thus making the nacelle shorter in helicopter mode, during landing) requiring the PRGB to have a gear train to transfer the power from the centerline of the engine to the centerline of the mast. This is accomplished with a set of high pitch-line velocity helical gears. To maintain weight efficiency, the speed of the gears is maximized to reduce the transmitted torque, thus reducing the gear and bearing sizes.

The high-speed design presents a challenge in meeting the aircraft's 30 minute "Run-dry" capability for the PRGB. A complete understanding of the sources, magnitudes, and influences of the heat generated and having an accurate method of prediction will greatly improve the efficiency, accuracy, and quality of the product during the design and analysis phases.

## Performance Issues

Many factors can affect the efficient performance of a drive system. For the gears there are two sources of losses that are the result of the sliding and rolling action of the gearing. The type of lubrication system also can seriously alter the performance of a given gearing system. In aerospace gearing systems, a great deal of emphasis is placed on the proper application as well as scavenging of the lubricant after use.

Each of these loss mechanisms has operational condition ranges where it can dominate the efficient performance of the gearing system. In the case of low-speed operation, the gear mesh losses will dominate the overall performance of the gear system. In high speed gearing systems, this type of loss, while contributing to the system performance degradation, can be a greatly reduced percentage of the losses when compared to the windage losses.

The performance of the high speed helical gear train system was measured in a test facility capable of operating to 15000 rpm and to 3730 KW (5000 hp) of power.

Experiments were conducted to vary the shaft speed and torque applied to the system. These effects will also be investigated analytically using techniques to predict the performance of the gearing components.

#### **Test Facility/Test Hardware/Data Acquisition/Test Procedure**

A description of the test facility was given in an earlier study, but will be repeated here for clarity (ref. 2).

#### **Test Facility**

The test facility used in this study is shown in figure 4. The facility is a closed-loop, torque-regenerative testing system. There is a test gearbox and slave gearbox that are basically mirror images of each other. Each gearbox has an input gear, three idlers, and one bull gear. The gearboxes are joined together through the input gears and bull gears via shafting.

Within the slave gearbox there is an additional speed increaser section at the first idler. This is the method through which the drive system is rotated and facility power is provided. In this type of facility, only the closed-loop losses (friction losses) are necessary to overcome, therefore a drive motor of considerably less power can drive the entire facility. Also within the slave gearbox is a rotating torque actuator that is used to rotate the bull gear in the slave gearbox relative to the shafting from the test gearbox. This ability to rotate the bull gear relative to the shaft permits adjustable loop torque during operation.

The facility is powered by a 373 kW (500 hp) DC drive motor and its output speed is increased using a speed-increasing gearbox. The output of the speed-increasing gearbox then passes through a torque and speed sensor before connecting to the slave gearbox. The entire test stand configuration is shown in figure 5.

Each gearbox has separate supply and scavenge pumps and reservoirs. Lubrication system flow rate is controlled by the supply pressure. Temperature is controlled via immersion heaters in the reservoir and heat exchangers that cool the lubricant returned from the gearboxes. Each lubrication system has 3-micron

filtration. The lubricant used in the tests to be described was a synthetic turbine engine lubricant (DoD-L-85734). This lubricant is used in gas turbine engines as well as some drive systems for rotorcraft.

#### **Test Hardware**

The test hardware used in the tests to be described is aerospace quality hardware. All components are made of the latest high, hot, hardness gear steels and final ground after heat treatment. The basic gear design information is contained in table 1. A photograph of the test hardware with the gearbox partially disassembled is shown in figure 6. Shrouds for the gears were used to minimize the windage losses.

#### **Data Acquisition**

The test facility data system monitors many important facility parameters during operation. Speed, torque (supplied torque and loop torque), and temperature measurements were made during all the testing conducted. The measurement for the supplied torque to the facility is accomplished via a commercially available torque meter. The test system loop torque is measured on the bull gear connect shaft using a telemetry system.

The data recording system used in this study has the capability of taking data from all parameters at a rate of one sample per second. The data is displayed to the test operator in real time. Data is stored in a spreadsheet format and each sensor can be viewed at any time during a test or when post processing the results.

#### **Test Procedure**

The test procedure that was followed for collecting the data to be presented was the following. For a given set of conditions the facility was operated at those conditions for at least 5 minutes or until the temperatures of interest had stabilized.

#### **Experimental Results**

As was shown in the earlier sketches of the test facility, the drive motor power not only supplies the losses for the test gearbox, but it also supplies the losses from the slave gearbox, rotating torque actuator, and an internal speed increaser within the slave gearbox. The amount of power supplied is measured just prior to the going into the slave gearbox. The drive motor power supplied at two light torque levels and varying speed is shown in figure 7.

As can be seen from this figure, doubling the torque had little effect in comparison to the changing the system rotational speed.

Another interesting result is the effect of torque at high levels when the operational speed is also very significant. The results of changing the load from approximately 33 to 100 percent of full torque at two levels of constant speed is presented in figure 8. This figure shows that changing the torque had a linearly increasing effect but much less of an effect when compared to increasing the shaft rotational speed.

In both figures 7 and 8, the total losses for the slave gearbox and test gearbox are shown.

Using the data collected during this study, efficiency of the system as a function of conditions can be calculated. The efficiency was calculated using the following measured parameters: loop torque, difference in lubricant temperature from the inlet and outlet locations and jet pressure. The flow rate was established based on the jet pressure provided to 20 jets that lubricate the gears and bearings of the test gearbox. The power losses were the combined effects of the heat rejected to the lubricant and the heat convected to the ambient environment. The test gearbox was modeled as flat plates in a free convection environment. The heat rejected to the oil was typically much, much greater than that rejected via convection. Only at very low loading and speed conditions did the convection portion approach 10 percent of the heat rejection. At the higher loading conditions typically of interest the convection part was no more than 1 to 2 percent of the total heat rejection.

The first efficiency comparison that will be made is that of the system operating at relatively light load and varying the speed. The data used for this comparison was that shown for 9 percent of maximum load.

From figure 9, shaft speed had a detrimental effect on the efficiency of the system for nearly constant load.

The next efficiency effect to be investigated was the effect on efficiency of the helical gear train at higher speeds and varying amounts of substantial load. The effect of load (33, 67, and 100 percent of full torque) and two high-speed conditions (83 and 100 percent of full speed is shown in figure 10.

This figure shows that the speed change from 12,500 rpm to 15,000 rpm has a detrimental effect on the high speed helical gear train performance.

The last comparison that was made was to examine all the data that had been previously taken

and analyzed and determine how well our current method of efficiency performance prediction compares to the power being supplied to the entire geared system. The results of 29 different test points (speed, load, and oil inlet temperature variations) are shown in figure 11.

In this figure, results below the line indicate an under prediction and results above the line indicate an over prediction when compared to the power supplied. Most of the results were under the line. Therefore, the prediction method used in this study may be under estimating the power loss. This can be due to experimental accuracy.

Another way to predict the power loss would be to use the input power required to drive the system and determine how the total power would be split between test and slave gearbox. While not addressed in this paper, this was done on the results. If the power loss was assumed to be related to the amount of heat rejected by each gearbox, and the input power split using this assumption, the results given in figure 10 were nearly identical to each other. A comparison of the results shown in figure 9 to the splitting method discussed above shows the same trend was followed but with slightly lower values.

### Analytical Predictions

The prediction of gear losses (sliding, rolling, and windage) have been studied by several researchers (refs. 3 to 5 for example). For the system under study a brief description of the gear member losses will be described.

In any type of gearing there are two main loss mechanisms that occur during tooth meshing. There are the sliding and rolling loss components associated with the relative velocity and loading between the pinion and driven gear. During the meshing action these values vary depending on the location of the line of contact on the profile. Methods have been developed that take into account the gear geometry, speed, and load sharing to predict the losses from the gear mesh.

At relatively low pitch line velocities, gear windage is not much of an issue. At higher rotational speeds, as those conducted in this study, the windage component of the gear losses can be substantial. Pitch line velocity at the highest speed condition in these tests was approximately 120m/s (24,000 ft/min.).

In the open literature, methods to predict the windage losses from a gear have shown that losses are dependent on the shaft speed to the 3rd power and gearing size (diameter) to the 5th power (ref. 6). Using this as a basis other researchers have included the effects of gear design (i.e., diameter to face width ratio, helix angle) and have done some limited research on how the environment can

also effect the losses associated with the gear mesh rotating through an oil-air environment (refs. 7 and 8).

In this paper, the results pertaining only to the gearing components were analyzed for the same conditions as are shown in figures 9 and 10. In the gear train considered in this study, there are a total of four different gear meshes. The layout of the gearing arrangement is shown in figure 12. In a gear train such as this, the idlers each are involved in two meshing actions.

Therefore, the gear meshing losses were calculated for the 50 tooth-51 tooth mesh twice and the two other meshing arrangements (51 tooth-50 tooth, and 51 tooth-139 tooth). The sliding and rolling losses for each of the four meshes and the windage losses from each of the five gears were combined in the analytical results shown in figures 13 and 14.

In figure 13 the efficiency of the gear system is shown at light and constant load. As the speed is increased, the efficiency decays due to the drastic effect of windage at the light load condition.

In figure 14 the effect of varying the level of load at two high speed conditions is shown. Increasing the speed at the constant torque levels lowered the gear train efficiency.

### Discussion of Results

In both the experimental and analytical results presented, the high speed helical gear train efficiency was adversely effected by the rotational speed of the gearing system. At the higher speeds and loads the windage power loss can nearly equal or exceed that due to the gear meshing action. Therefore, substantial improvements in the gear system performance can be made if the windage losses could be reduced. Gear design changes may slightly affect the windage loss and can have an effect on the gear meshing losses, but techniques that would reduce this power loss component would be beneficial whatever the high speed gear design.

For the highest speed and load conditions, the gear mesh and windage losses were predicted to be 80 hp (at 15,000 rpm, 20,935 in.-lb torque). The experimentally measured losses for the same conditions were approximately 98 hp. An improved simulation is possible, but requires assessing the shafting windage and the bearing losses (not included in this report). However, the analysis appears to

produce similar trends as that of the actual tested performance.

The extremely difficult portion of the analysis is the windage prediction. There are so many parameters such as gear design, housing arrangement, shrouding, and lubrication system effects that a concise analytical representation may not be possible. One way to continue performance improvements is to conduct additional experimental comparisons where one variable at a time is studied. This will lead to trends for improved performance and windage reduction.

### Conclusions

Based on the testing and analysis that was conducted in this study the following conclusions can be drawn:

1. High gearing system rotational speed has a drastic effect on the efficiency of high speed helical gear trains.
2. Both experimental results and analytical predictions demonstrated that windage losses will dominate the performance when light loads and high speed are applied to the gear meshing system.
3. When the gear system was operated in the range of 33 to 100 percent of full load and at 83 and 100 percent of full speed, the losses and therefore the efficiency were drastically effected by the windage to the point where the losses due to this component was nearly equal to or exceeded that of the gear meshing (rolling and sliding) losses.

### References

1. Kilmain, C., Murray, R., and Huffman, C.: V-22 Drive System Description and Design Technologies, American Helicopter Society 51st Annual Forum, May 1995.
2. Handschuh, R. and Kilmain, D.: "Preliminary Investigation of the Thermal Behavior of High-Speed Helical Gear Trains," NASA/TM-2002-211336, ARL-TR-2661, March 2002.
3. Anderson, N. and Loewenthal, S.: "Spur Gear System Efficiency at Part and Full Load," NASA TP-1622, 1980.
4. Handschuh, R. and Rohn, D.: "Efficiency Testing of a Helicopter Transmission Planetary Reduction Stage," NASA TP-2795, AVSCOM TR 87-C-28, February 1988.
5. Krantz, T. and Handschuh, R.: "Efficiency Study Comparing Two Helicopter Planetary Reduction Stages," NASA TM-103106, AVSCOM TM 90-C-005, July 1990.
6. Dudley, D.: Gear Handbook, 1st Edition, McGraw-Hill, Inc., 1962.
7. Dawson, P.: Windage Loss in Larger High-Speed Gears, Proc. Inst. Mech. Eng., Vol. 198A, No.1, pp. 51-59, 1984.
8. Dawson, P.: High-Speed Gear Windage, GEC Review, Vol. 4, No. 3, pp. 164-167, 1988.

Table 1: Basic Gear Design Data

Number of teeth, Input/1 <sup>st</sup> and 3 <sup>rd</sup> Idler/ Bull Gear	50/51/139
Module (mm), (Diametral Pitch (1/in.))	3.033 (8.375)
Face Width, mm (in.)	67.2 (2.625)
Helix Angle, deg	12
Gear Material	Pyrowear EX-53

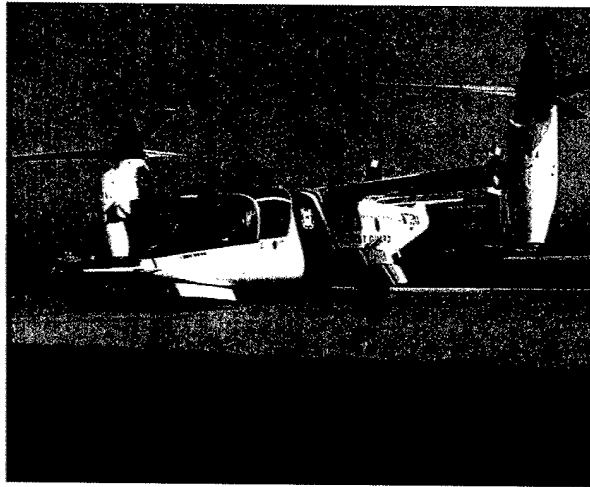

Figure 1.—Tiltrotor aircraft.

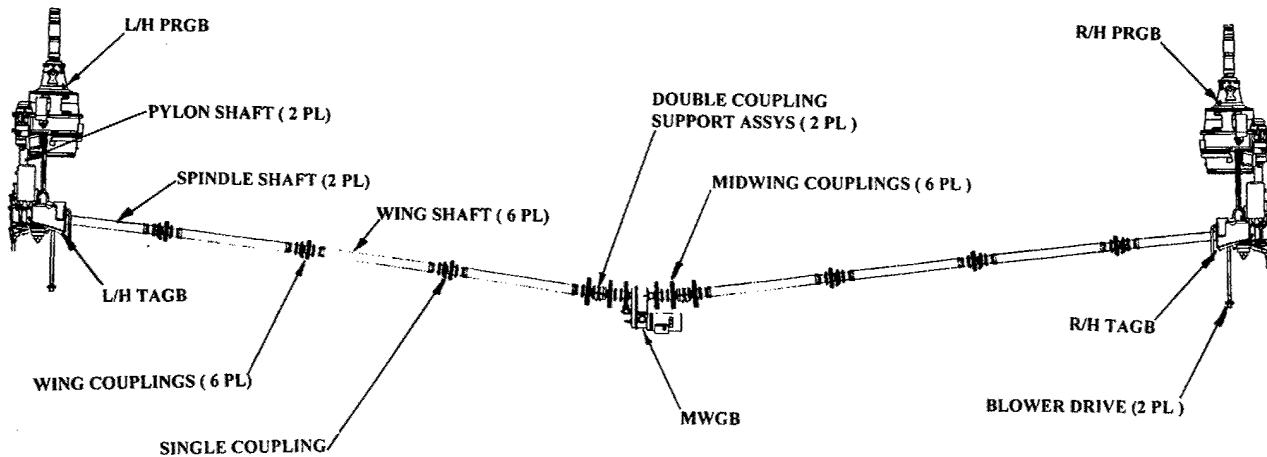

Figure 2.—Typical tiltrotor drive system arrangement.

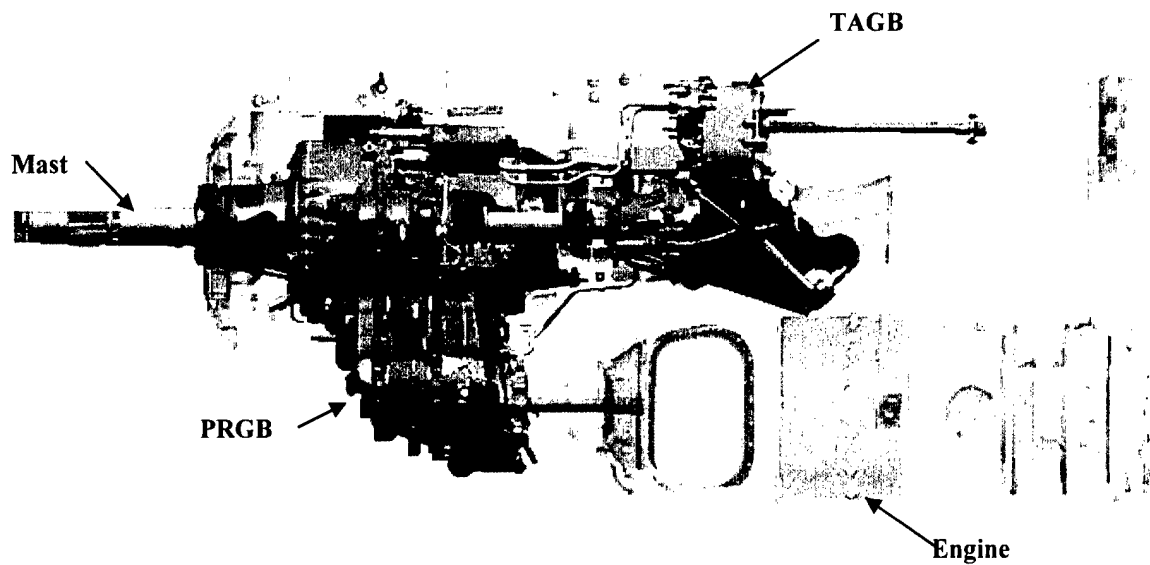

Figure 3.—Layout view of typical tiltrotor nacelle (airplane mode).

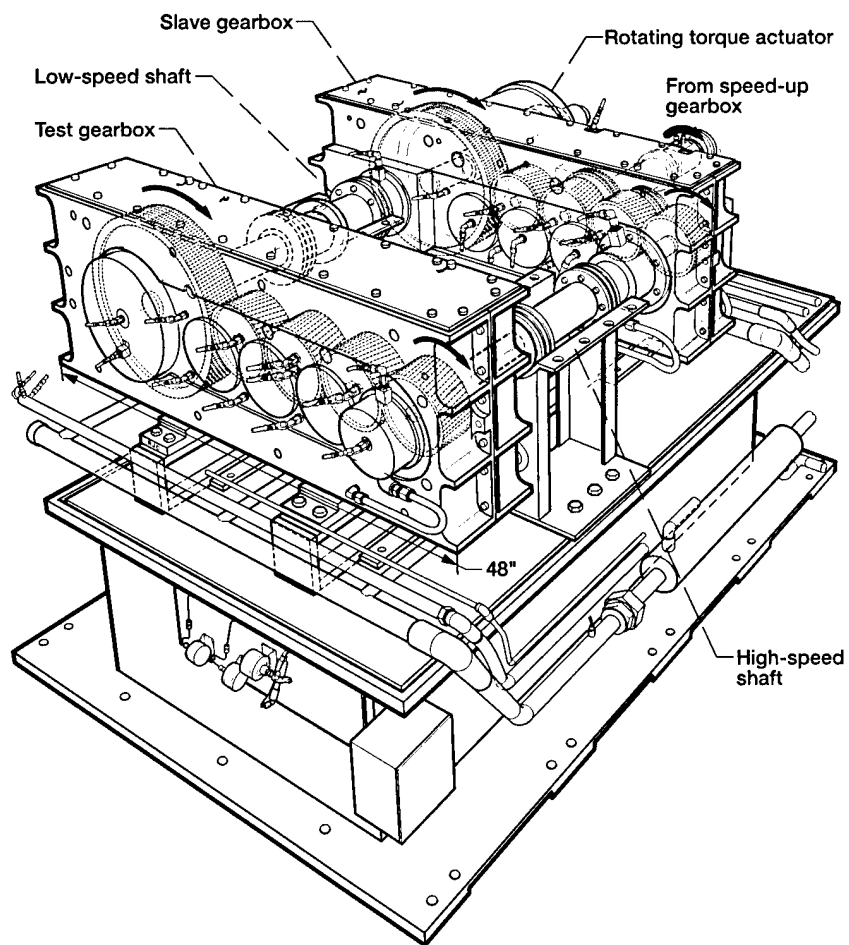

Figure 4.—NASA High-Speed Helical Gear Train Test Facility.

## Test Facility Arrangement

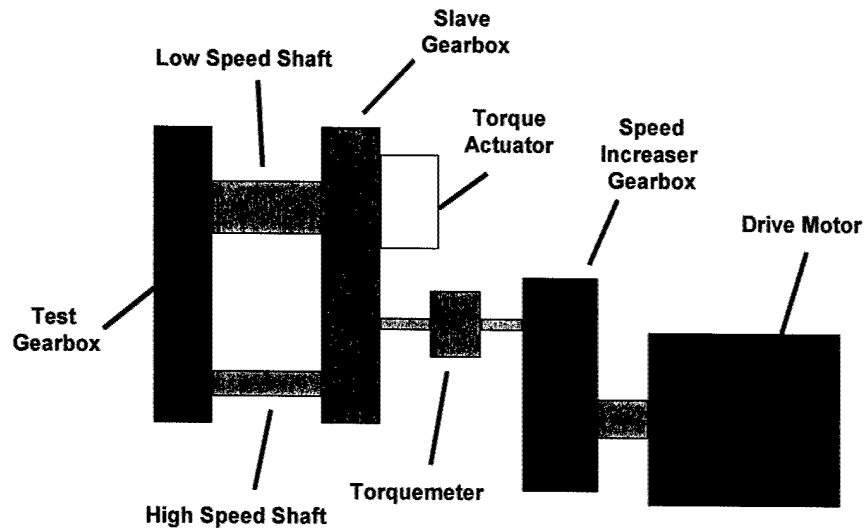

Figure 5.—Layout of NASA High-Speed Helical Gear Train Test Facility.

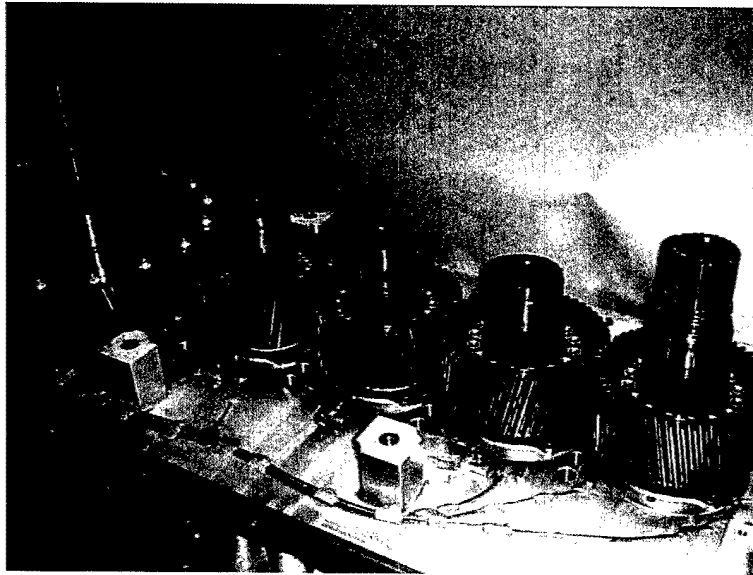
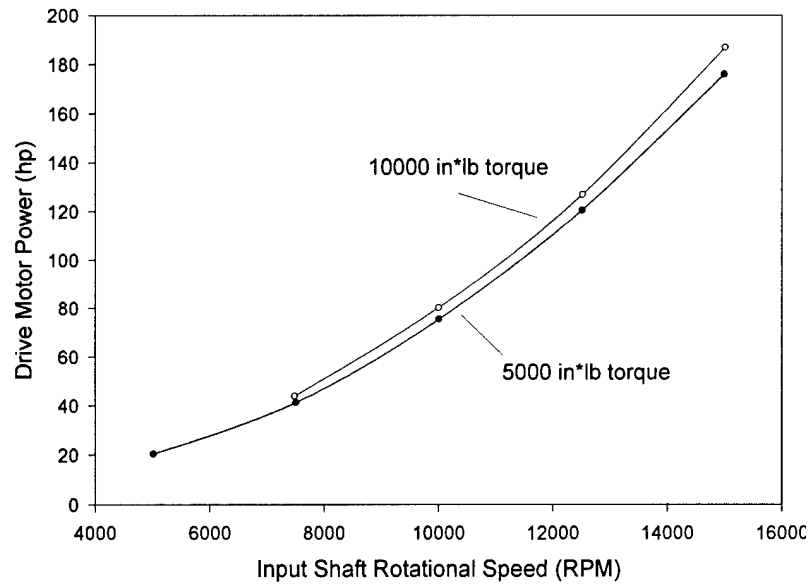
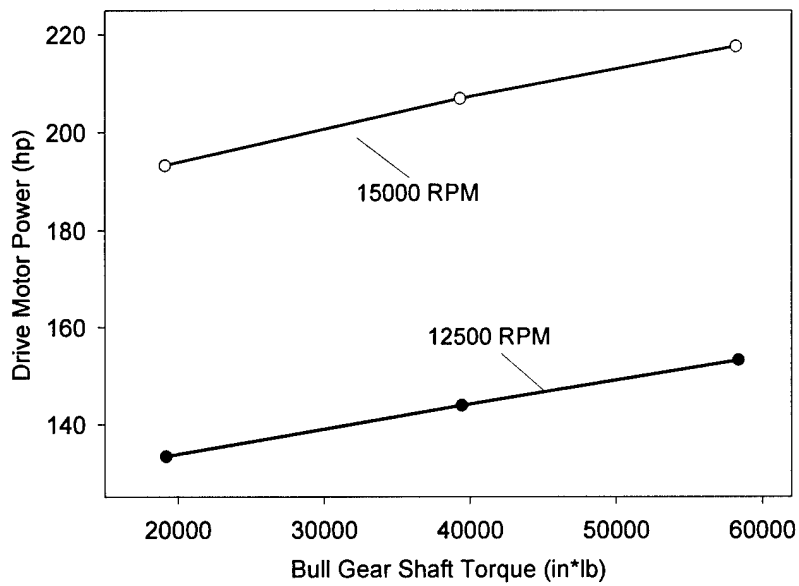

Figure 6.—NASA High-Speed Helical Gear Train Test Facility Components.



**Figure 7.—Drive motor power required to rotate the entire test facility as a function of input shaft speed (bull gear shaft torque shown).**



**Figure 8.—Drive motor power required at high speed and load.**

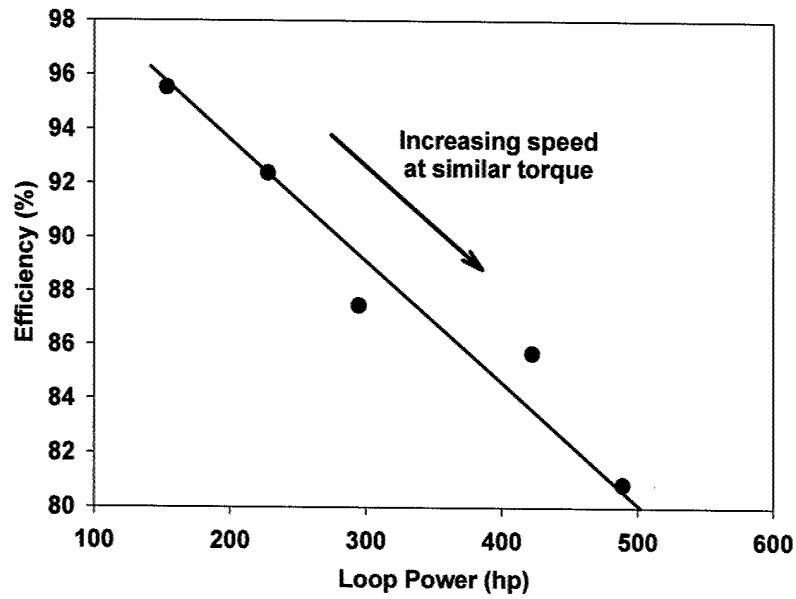

Figure 9.—Effect of shaft speed (input shaft speed: 5,000 to 15,000 rpm) at similar light load.

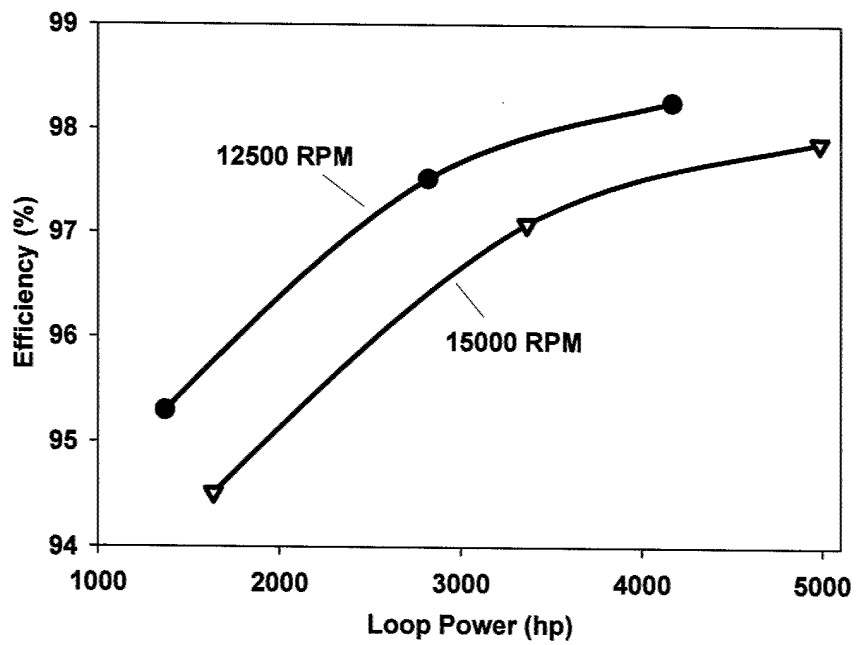

Figure 10.—Effect of high speed and load on helical gear train performance.

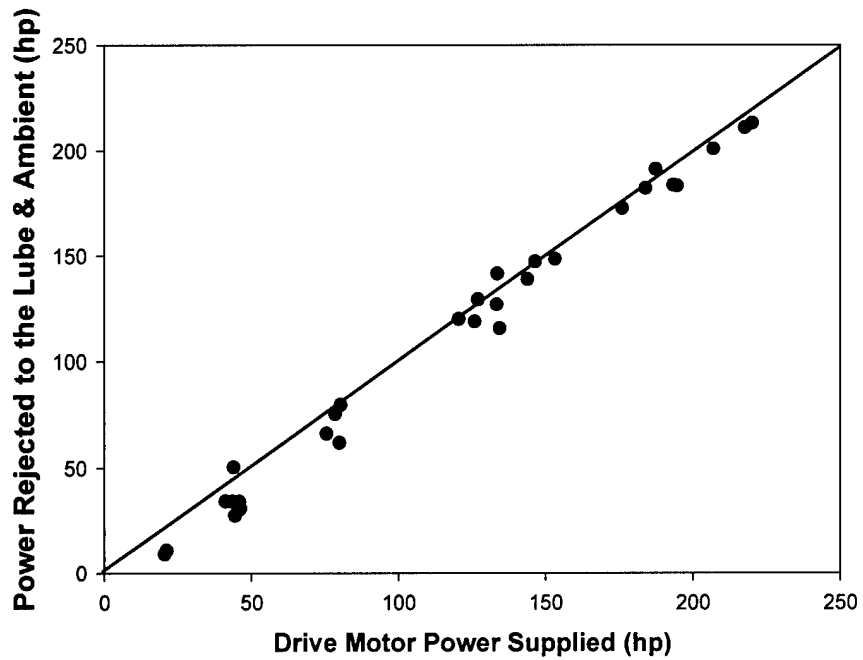

Figure 11.—Comparison of supplied power versus calculated power rejected for both the test and slave gearboxes.

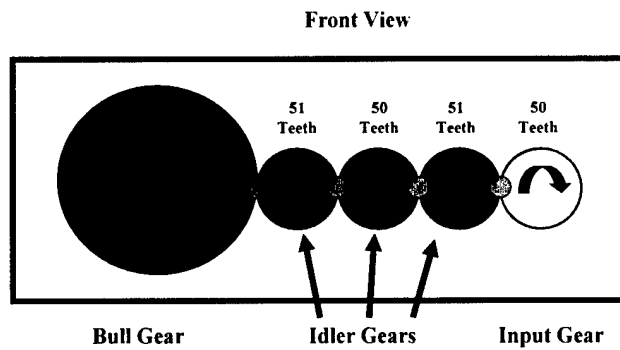

Figure 12.—Layout of helical gear train arrangement.

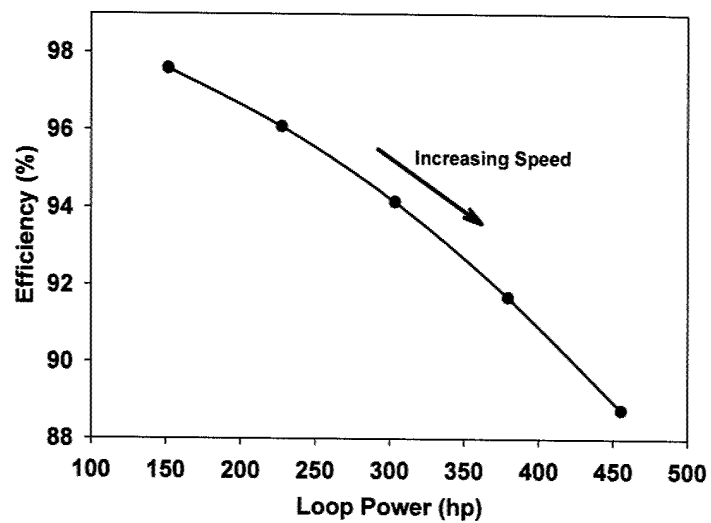

Figure 13.—Analytical prediction of the high speed helical gear train efficiency.

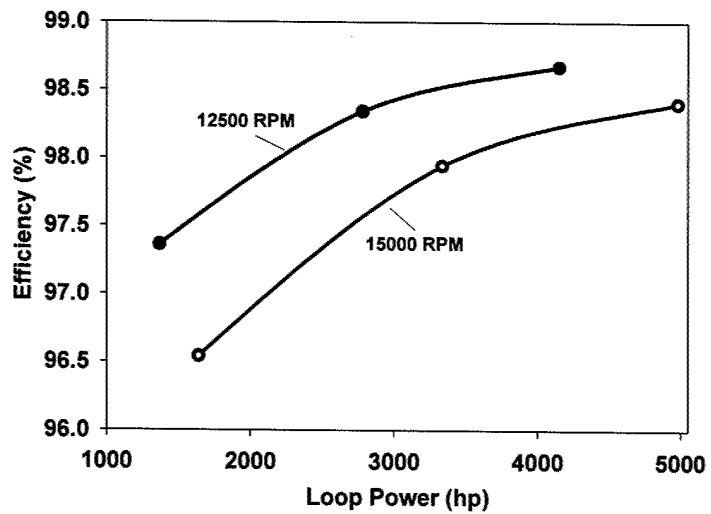

Figure 14.—Analytical prediction of high speed helical gear train efficiency at high speed and load.

# REPORT DOCUMENTATION PAGE

*Form Approved*  
*OMB No. 0704-0188*

Public reporting burden for this collection of information is estimated to average 1 hour per response, including the time for reviewing instructions, searching existing data sources, gathering and maintaining the data needed, and completing and reviewing the collection of information. Send comments regarding this burden estimate or any other aspect of this collection of information, including suggestions for reducing this burden, to Washington Headquarters Services, Directorate for Information Operations and Reports, 1215 Jefferson Davis Highway, Suite 1204, Arlington, VA 22202-4302, and to the Office of Management and Budget, Paperwork Reduction Project (0704-0188), Washington, DC 20503.

<b>1. AGENCY USE ONLY</b> ( <i>Leave blank</i> )	<b>2. REPORT DATE</b> April 2003	<b>3. REPORT TYPE AND DATES COVERED</b> Technical Memorandum	
<b>4. TITLE AND SUBTITLE</b>  Efficiency of High-Speed Helical Gear Trains		<b>5. FUNDING NUMBERS</b>  WBS-22-708-28-02 1L162211A47A	
<b>6. AUTHOR(S)</b>  Robert F. Handschuh and Charles J. Kilmain		<b>8. PERFORMING ORGANIZATION REPORT NUMBER</b>  E-13841	
<b>7. PERFORMING ORGANIZATION NAME(S) AND ADDRESS(ES)</b>  National Aeronautics and Space Administration John H. Glenn Research Center at Lewis Field Cleveland, Ohio 44135-3191		<b>10. SPONSORING/MONITORING AGENCY REPORT NUMBER</b>  NASA TM-2003-212222 ARL-TR-2968	
<b>9. SPONSORING/MONITORING AGENCY NAME(S) AND ADDRESS(ES)</b>  National Aeronautics and Space Administration Washington, DC 20546-0001 and U.S. Army Research Laboratory Adelphi, Maryland 20783-1145		<b>11. SUPPLEMENTARY NOTES</b>  Prepared for the 59th Annual Forum and Technology Display sponsored by the American Helicopter Society, Phoenix, Arizona, May 6-8, 2003. Robert F. Handschuh, U.S. Army Research Laboratory, NASA Glenn Research Center; Charles J. Kilmain Bell Helicopter Textron Inc., Fort Worth, Texas 76101. Responsible person, Robert F. Handschuh, organization code 0300, 216-433-3969.	
<b>12a. DISTRIBUTION/AVAILABILITY STATEMENT</b>  Unclassified - Unlimited Subject Category: 37  Available electronically at <a href="http://gltrs.grc.nasa.gov">http://gltrs.grc.nasa.gov</a> This publication is available from the NASA Center for AeroSpace Information, 301-621-0390.		<b>12b. DISTRIBUTION CODE</b>	
<b>13. ABSTRACT</b> ( <i>Maximum 200 words</i> )  An experimental and analytical comparison of the efficiency of high-speed helical gear trains is presented. An analysis of the gearing losses was conducted and was used as a comparison to the measured losses. Test data from a helical gear train at varying speeds and loads (to 3730 KW (5000 hp) and 15000 RPM) was collected. A comparison of the results indicated that drive system rotational speed had the most detrimental effect to the efficiency of the gear system at light load and windage losses approached or exceeded the gear meshing losses at high speed and load conditions.			
<b>14. SUBJECT TERMS</b>  Gears; Transmissions		<b>15. NUMBER OF PAGES</b>  17	
		<b>16. PRICE CODE</b>	
<b>17. SECURITY CLASSIFICATION OF REPORT</b>  Unclassified	<b>18. SECURITY CLASSIFICATION OF THIS PAGE</b>  Unclassified	<b>19. SECURITY CLASSIFICATION OF ABSTRACT</b>  Unclassified	<b>20. LIMITATION OF ABSTRACT</b>