



NAVAL
POSTGRADUATE
SCHOOL

MONTEREY, CALIFORNIA

THESIS

AN EVALUATION OF THE NETWORK EFFICIENCY
REQUIRED IN ORDER TO SUPPORT MULTICAST AND
SYNCHRONOUS DISTRIBUTED LEARNING NETWORK
TRAFFIC

by

Christopher V. Quick

September 2003

Thesis Advisor:

Geoffrey Xie

Co-Advisor:

John H. Gibson

Approved for public release; distribution is unlimited

THIS PAGE INTENTIONALLY LEFT BLANK

REPORT DOCUMENTATION PAGE			Form Approved OMB No. 0704-0188
Public reporting burden for this collection of information is estimated to average 1 hour per response, including the time for reviewing instruction, searching existing data sources, gathering and maintaining the data needed, and completing and reviewing the collection of information. Send comments regarding this burden estimate or any other aspect of this collection of information, including suggestions for reducing this burden, to Washington headquarters Services, Directorate for Information Operations and Reports, 1215 Jefferson Davis Highway, Suite 1204, Arlington, VA 22202-4302, and to the Office of Management and Budget, Paperwork Reduction Project (0704-0188) Washington DC 20503.			
1. AGENCY USE ONLY (Leave blank)	2. REPORT DATE September 2003	3. REPORT TYPE AND DATES COVERED Master's Thesis	
4. TITLE AND SUBTITLE An Evaluation of the Network Efficiency Required in Order to Support Multicast and Synchronous Distributed Learning Network Traffic		5. FUNDING NUMBERS	
6. AUTHOR (S) Quick, Christopher V.		8. PERFORMING ORGANIZATION REPORT NUMBER	
7. PERFORMING ORGANIZATION NAME(S) AND ADDRESS(ES) Naval Postgraduate School Monterey, CA 93943-5000		10. SPONSORING/MONITORING AGENCY REPORT NUMBER	
9. SPONSORING / MONITORING AGENCY NAME(S) AND ADDRESS(ES)		11. SUPPLEMENTARY NOTES The views expressed in this thesis are those of the author and do not reflect the official policy or position of the U.S. Department of Defense or the U.S. Government.	
12a. DISTRIBUTION / AVAILABILITY STATEMENT Approved for public release; distribution is unlimited.		12b. DISTRIBUTION CODE	
13. ABSTRACT (maximum 200 words) The United States military has had and will continue to have a legacy of comparatively short tours and long deployments in locations where the availability of all forms of education and training may be limited. This not only limits the potential of military members but can have a detrimental effect on moral and retention. Distributed Learning is one way to combat this ever increasing dilemma. With the proliferation of computer technology and Internet access throughout the Department of Defense (DoD), Distributed Learning can put education and training at the finger tips of most military members. It can even bring education to the field limited only by the networks, data delivery methods, and bandwidth provided military units. This thesis examines the network requirements needed to provide a good quality of service (QoS) to sailors and solders, and provides guidelines for implementing Distributed Learning over multicast on DoD networks. Multicast is a very efficient method of delivering data to multiple recipients and is the underlying technology which can allow interactive Distributed Learning. It is therefore the primary focus of this thesis.			
14. SUBJECT TERMS Multicast, Multicasting, Distributed Learning, Network Protocol, PIM, DVMRP, IGMP, SAP/SDP, IGMP Snooping, Dense Mode, Sparse Mode		15. NUMBER OF PAGES 173	
17. SECURITY CLASSIFICATION OF REPORT Unclassified		18. SECURITY CLASSIFICATION OF THIS PAGE Unclassified	19. SECURITY CLASSIFICATION OF ABSTRACT Unclassified
			16. PRICE CODE
			20. LIMITATION OF ABSTRACT UL

NSN 7540-01-280-5500

Standard Form 298 (Rev. 2-89)
Prescribed by ANSI Std. Z39-18

THIS PAGE INTENTIONALLY LEFT BLANK

Approved for public release; distribution is unlimited

**AN EVALUATION OF THE NETWORK EFFICIENCY REQUIRED IN ORDER
TO SUPPORT MULTICAST AND DISTRIBUTED LEARNING NETWORK
TRAFFIC**

Christopher Verald Quick
Lieutenant, United States Navy
B.S., Strayer University, 1996

Submitted in partial fulfillment of the
requirements for the degree of

MASTER OF SCIENCE IN COMPUTER SCIENCE

from the

**NAVAL POSTGRADUATE SCHOOL
September 2003**

Author: Christopher V. Quick

Approved by: Geoffrey Xie
Thesis Advisor

John H. Gibson
Co-Advisor

Peter Denning
Chairman, Department of Computer Science

THIS PAGE INTENTIONALLY LEFT BLANK

ABSTRACT

The United States military has had and will continue to have a legacy of comparatively short tours and long deployments in locations where the availability of all forms of education and training may be limited. This not only limits the potential of military members but can have a detrimental effect on morale and retention. Distributed Learning is one way to combat this ever increasing dilemma.

With the proliferation of computer technology and Internet access throughout the Department of Defense (DoD), Distributed Learning can put education and training at the finger tips of most military members. It can even bring education to the field limited only by the networks, data delivery methods, and bandwidth provided military units.

This thesis examines the network requirements needed to provide a good quality of service (QoS) to sailors and soldiers, and provides guidelines for implementing Distributed Learning over multicast on DoD networks. Multicast is a very efficient method of delivering data to multiple recipients and is the underlying technology which can allow interactive Distributed Learning. It is therefore the primary focus of this thesis.

THIS PAGE INTENTIONALLY LEFT BLANK

TABLE OF CONTENTS

I.	INTRODUCTION	1
II.	BACKGROUND	7
A.	DISTRIBUTED LEARNING	7
1.	Distance Learning vs. Distributed Learning	8
2.	Some Distributed Learning History	8
3.	Why Employ Distance and Distributed Learning .	10
B.	MULTICAST	11
1.	So, What is Broadcast?	12
2.	Then What's Multicast?	14
3.	The Multicast IP Address Space	16
4.	Types of Multicast	19
(a)	Link-Layer Multicast	19
(b)	Any Source Multicast (ASM)	20
(c)	Source Specific Multicast (SSM)	21
C.	MULTICAST DISTRIBUTED LEARNING	22
III.	MULTICAST ROUTING PROTOCOLS USED ON NPS NETWORK	25
A.	ANNOUNCEMENT AND DESCRIPTION PROTOCOLS	27
1.	Session Announcement Protocol (SAP)	28
2.	Session Description Protocol (SDP)	30
B.	INTERNET GROUP MANAGEMENT PROTOCOL (IGMP)	31
1.	Version 1 (IGMPv1)	33
2.	Version 2 (IGMPv2)	35
3.	Version 3 (IGMPv3)	38
4.	IGMP Snooping	40
C.	DISTANCE VECTOR MULTICASTING ROUTING PROTOCOL (DVMRP)	41
D.	PROTOCOL INDEPENDENT MULTICASTING (PIM)	46
1.	Sparse Mode (PIM-SM)	47
2.	Dense Mode (PIM-DM)	49
E.	IP MULTICAST PROTOCOL COMPARISON	51
F.	NETWORK HARDWARE AND MULTICAST	53
IV.	LABORATORY TESTING, DATA ANALYSIS, AND RESULTS	55
A.	EVALUATION OF MULTICAST APPLICATIONS	56
1.	Ethereal	57
2.	TETHEREAL	57
3.	EtherPeek	58
4.	SolarWinds Professional Plus Edition	58
5.	Iperf	59
6.	Multi-Generator Toolset	60
7.	Mbone Applications	60

8.	QuickTime Streaming Server	61
9.	QuickTime Player	62
10.	VBrick StreamPump	63
11.	VBrick StreamPlayer	63
B.	VBRICK 3200 CONFIGURATION AND TEST	64
C.	SWITCH CONFIGURATION AND TEST	69
1.	3COM Super Stack II 3300	69
2.	Foundry FastIron Edge 4802	74
D.	ROUTER IGMP TEST	77
V.	NETWORK TESTING, DATA ANALYSIS, AND RESULTS	81
A.	PROCEDURE FOR NETWORK DATA ANALYSIS	81
1.	Packet Capture Analysis	82
2.	SolarWinds Data Analysis	83
B.	INITIAL TEST	83
1.	Test Description	83
2.	Problems Encountered	86
3.	Data Analysis	88
4.	Test Results	91
a.	<i>Equipment Configuration</i>	91
b.	<i>Findings</i>	92
C.	CLARIFICATION/LOAD TEST	93
1.	Test Description	93
2.	Problems Encountered	97
3.	Data Analysis	99
4.	Test Results	103
D.	STRESS TEST	104
1.	Test Description	105
2.	Problems Encountered	108
3.	Data Analysis	109
4.	Test Results	112
VI.	CONCLUSION	115
A.	SUMMARY OF THESIS FINDINGS	117
B.	RECOMMENDATIONS FOR IMPLEMENTING MULTICAST NETWORK SERVICES IN SUPPORT OF DOD DISTRIBUTED LEARNING	121
C.	FUTURE WORK	123
APPENDIX A:	LABORATORY TEST PLANS	125
A.	MULTICAST APPLICATION USE ANALYSIS	125
1.	Introduction	125
2.	Service Needed	126
3.	Software Criteria	126
4.	Materials List	126
5.	Test Procedure	127
6.	Desired Outcome	127
B.	LABORATORY TEST PLAN FOR NETWORK SWITCHES	127

1.	Introduction	128
2.	Questions	129
3.	Test Plan Schedule	129
4.	Materials List	129
5.	Test Procedure	130
6.	Desired Outcome	131
APPENDIX B: NETWORK TEST PLANS		133
A.	MULTICAST NETWORK TEST PLAN (INITIAL)	133
1.	Introduction	133
2.	Questions	134
3.	Test Plan Schedule	135
4.	Participants	135
5.	Materials List	135
6.	Test Procedure	136
	<i>a. Preparation steps</i>	136
	<i>b. Test Steps</i>	137
	<i>c. Wrap-up</i>	138
7.	Desired Outcome	138
B.	MULTICAST NETWORK TEST PLAN (FINAL)	138
1.	Test Plan Introduction	139
2.	Questions	139
3.	Test Plan Schedule	139
4.	Materials List	140
5.	Test Procedure	140
	<i>a. Preparation Steps</i>	141
	<i>b. Test Steps</i>	141
	<i>c. Wrap-up</i>	142
6.	Desired Outcome	142
APPENDIX C: AUTOMATED PACKET CAPTURE		145
LIST OF REFERENCES		149
INITIAL DISTRIBUTION LIST		153

THIS PAGE INTENTIONALLY LEFT BLANK

LIST OF FIGURES

Figure 1.	One-to-one Unicast Network Traffic	12
Figure 2.	One-to-Many Broadcast Network Traffic	13
Figure 3.	One-to-Many Multicast Network Traffic	15
Figure 4.	Many-to-Many Multicast Network Traffic	16
Figure 5.	IP Address Classes [10]	17
Figure 6.	AS Multicast IP Address Conversion	19
Figure 7.	Network Diagram for Protocol Discussion	26
Figure 8.	SAP Message Format [12]	29
Figure 9.	Network Diagram for IGMP Discussion	32
Figure 10.	IGMPv1 Message Format [14]	33
Figure 11.	IGMPv2 Message Format [15]	36
Figure 12.	VBrick 3200 Encoder/Decoder	64
Figure 13.	VAdmin Administrator Utility: Comms	65
Figure 14.	VAdmin Administrator Utility: Encoder Video	66
Figure 15.	VAdmin Administrator Utility: Encoder Audio	66
Figure 16.	VAdmin Administrator Utility: Network	67
Figure 17.	VAdmin Administrator Utility: SAP	67
Figure 18.	VAdmin Administrator Utility: RTP	68
Figure 19.	Network Diagram of Initial Lab Configuration	70
Figure 20.	12 Port 3COM Switch Multicast Configuration	72
Figure 21.	24 Port 3COM Switch Multicast Configuration	72
Figure 22.	Network Diagram of Final Lab Configuration	74
Figure 23.	48 Port Foundry Switch Multicast Configuration	76
Figure 24.	Foundry Router Multicast Configuration	78
Figure 25.	Network Diagram for the Initial Test	84
Figure 26.	Switch 4 Initial Test Bandwidth Usage Chart	91
Figure 27.	Router 1 Initial Test Bandwidth Usage Chart	91
Figure 28.	Network Diagram for the Clarification Test	94
Figure 29.	VBrick StreamPlayer Used in Network Tests	96
Figure 30.	Switch 4 Clarification/Load Test Bandwidth Usage Chart	98
Figure 31.	Switch 4 Clarification/Load Test Bandwidth Usage Chart	101
Figure 32.	Router 1 Clarification/Load Test Bandwidth Usage Charts	102
Figure 33.	Core Switch 1 Clarification/Load Test Bandwidth Usage Charts	102
Figure 34.	Router 2 Clarification /Load Test Bandwidth Usage Chart	103
Figure 35.	Network Diagram for the Stress Test	106
Figure 36.	Stress Test Bandwidth Usage Charts	111
Figure 37.	Stress Test Bandwidth Usage Charts	112
Figure 38.	Network Diagram for the Initial Test	134

THIS PAGE INTENTIONALLY LEFT BLANK

LIST OF TABLES

Table 1.	Assigned Multicast Addresses	18
Table 2.	DVMRP TTL to Scope	45
Table 3.	IP-Multicast Protocol Timing [18]	52

THIS PAGE INTENTIONALLY LEFT BLANK

LIST OF ABBREVIATIONS AND ACRONYMS

(* ,G)	- (All source, Group) multicast group
(S,G)	- (Source, Group) multicast routing table
ASM	- Any Source Multicast
ATM	- Asynchronous Transfer Mode
BGP	- Border Gateway Protocol
CAM	- Content Addressable Memory
DoD	- Department of Defense
DR	- Designated router
DVMRP	- Distance Vector Multicasting Routing Protocol
GARP	- Generic Attribute Registration protocol
GB	- Gigabyte
Gbps	- Gigabit per second
GMRP	- GARP Multicast Registration Protocol
HTML	- HyperText Markup Language
IANA	- Internet Assigned Number Authority
ICMP	- Internet Control Message Protocol
IDRM	- Inter-Domain Multicast Routing
IETF	- Internet Engineering Task Force
IGMP	- Internet Group Management Protocol
IP	- Internet Protocol (IPv# - version number (#))
LAN	- Local Area Network
MB	- Megabyte
MBGP	- Multicast BGP
Mbone	- Multicast backbone
Mbps	- Megabit per second
MDL	- Multicast Distributed Learning
MFT	- Multicast Forwarding Table
MGEN	- Multi-Generator
MOVES	- Modeling, Virtual Environments and Simulation
MRT	- Multicast Routing Table
MTU	- Maximum Transfer Unit
NLANR	- National Laboratory for Applied Network Research
NOC	- Network Operations Center
NPS	- Naval Postgraduate School
NRL	- Naval Research Laboratory
NTE	- Network Text Edit tool
PIM-DM	- Protocol Independent Multicasting-Dense Mode
PIM-SM	- Protocol Independent Multicasting-Sparse Mode
QoS	- Quality of Service
RAM	- Random Access Memory
RAT	- Robust Audio Tool
RIPv2	- Routing Information Protocol version 2
RP	- Rendezvous point

RPF - Reverse Path Forwarding
TCP - Transmission Control Protocol
TTL - Time-to-live field in an IP packet.
SAP - Session Announcement Protocol
SDP - Session Description Protocol
SDR - Session Directory tool
SMDS - Switched Multimegabit Data Service
Sniffer - A PC with some packet capture software (Ethereal)
SPT - shortest path tree
SSM - Source Specific Multicast
UDP - User Data Protocol
VIC - Videoconferencing tool
VLSM - Variable Length Subnet Masking
WAN - Wide Area Network
WBD - Whiteboard tool
WWW - World Wide Web

ACKNOWLEDGEMENTS

The author would like to acknowledge the Lonna Sherwin and JP Pierson from the NPS Network Operation Center and Lary Moore and Mike Nichols from the NPS Code 05 department for their support during the research for this thesis.

He would like to extend his sincere gratitude to his thesis advisors, Professor Geoffrey Xie and Research Associate John H. Gibson for their insight and patience. He would like to thank his wife, Kimberly Quick, for her love and support during the entire thesis process. Furthermore, he would like to thank his parents, V. R. and Eleanor Quick, without whose love and sacrifice allow him the opportunities he enjoys today.

Finally, he would like to dedicate this thesis to his children, Ashley, Christopher, and Aaron Quick, for their unconditional love.

THIS PAGE INTENTIONALLY LEFT BLANK

I. INTRODUCTION

The United States military is currently in an educational quandary. With the substantial force and resource reductions following both the Cold and Gulf Wars, skilled manpower is at a premium. Concurrent with downsizing, the Services have been increasingly deployed on short notice to execute diverse operational missions. These comparatively short tours and long deployments, in locations where traditional forms of education and training are limited, are compounding the educational issue. This combination of events and circumstances has put a spotlight on the need to adjust the military's current training systems to meet changing mission requirements. [01]

The military's current training systems are, by and large, classroom oriented. All students are required to be at the facility in which training occurs and are, for all practical purposes, removed from operational status for the duration of the training. So, how can commands, which are already undermanned, release personnel for training and higher education opportunities? On top of this, the resource issues faced by most commands are making more education possibilities less and less cost effective. This not only has the potential to limit our military member's technical development but can have a detrimental effect on morale and retention. So, how will it be possible to maintain a sailors or soldiers technical competence in this continuing "do-more-with-less" era? [01]

The short answer is: if the student can not go to the classroom then the classroom needs to come to the student.

Distributed Learning utilizing multicast can bring the classroom to nearly any Department of Defense (DoD) computer terminal, providing improved training and increased learning opportunities for just about every military member. [02]

With the proliferation of computer technology and Internet access throughout the DoD, Distributed Learning can put education and training at the finger tips of most military members. It can even bring education to the field. It is only limited by the networks, data delivery methods, and bandwidth provided military units. Providing multicast and Distributed Learning sources on DoD networks is the next logical step forward regarding information dissemination and training for all DoD employees. [02]

Of further consideration, DoD and other government personnel lose productive time walking to and from a meeting hall or conference room to view briefs or attend seminars or project meetings. In large organizations, this may mean traveling to another building where parking may be limited. For seminars or project meetings, the participants may be traveling from many geographical locations consuming both travel funds and time. With multicast and the current information technology (IT) infrastructure, personnel should be able to participate in these same events on their desktop workstations or at local distributed locations, potentially increasing worker productivity and reducing time away from primary tasks. Can current Government, and DoD networks in particular, support these applications while continuing to support their current quality of service (QoS) to other network traffic? To answer this

question, a hard look must be taken at current multicast routing protocols and the network in which they are used.

Furthermore, a set of metrics that can illustrate the current efficiency and QoS of a given network, without multicast and distributed learning applications, will need to be defined. Then tests to provide data for these metrics will need to be designed and performed. Once the current or baseline state of a network is determined, then multicast and distributed learning traffic should be introduced into the network and the tests performed again. The contrast between these two data points will provide a good view of the impact of multicast and distributed learning traffic on the network.

This thesis provides insight into the capabilities that a network requires in order to provide a sufficient QoS to sailors and soldiers in support of Distributed Learning via multicast. Multicast being a very efficient method of delivering data to multiple recipients and is the underlying technology that can allow interactive Distributed Learning. Thus, multicast is the primary focus of this thesis.

Curiosity is and always has been the driving force behind humanity's ingenuity and its need to know. So, the questions that an entity is willing to ask, define its reality and perception of the world. The harder the question, the greater the reward once the answer is found. Thus, it follows that if an organization is unwilling or unable to ask a question, then the truth of the answer can not be part of that entity's paradigm. At present, the NPS Network Operations Center (NOC) does not believe that

multicast is viable or needed on the NPS network. It is not asking why multicast does not work, can it work, or how it can be made to work on its network. This thesis was developed in order to answer these hard questions and is the driving force behind it. But to answer them, the following questions have to be answered first:

1. Exactly, what is multicast and how is it used in distributed learning applications?
2. What network architectures and topologies best support multicasts, and does it matter?
3. What are the most used multicast routing algorithms on commercial and educational networks today?
4. What requirements for multicast applications does the NPS network documentation include?
5. What multicast network services are currently available on the NPS network? Were any implemented with the new Foundry Network?
6. Will the current NPS network support multicast?

Questions, the pursuit of knowledge, and discovery of truths are what make a thesis. So finding the answers to these questions is the value of this thesis. The experiments in chapter four were thus conducted, using the networks laboratory equipment and the current NPS network, in order to answer these questions. The data collected during these experiments was analyzed to assess the impact of multicast traffic on the NPS network, determine the current state of the NPS network as it relates to multicast transmissions, and provide insight into its multicast

capability. This information was then used to develop the suggested guidelines for implementing multicast on DoD networks in Chapter VI.

The rest of this thesis is broken down into chapters and appendices. Chapter II contains background information on distributed learning and multicast. It also answers question 1 above. Chapter III is a description of the multicast routing protocols utilized at NPS and answers questions 2 and 3 above. Chapter IV describes the experiments conducted in support of this thesis. Chapter 5 contains the results of the experiments and an analysis of the data collected during them. The sixth chapter holds the recommendations and suggestions developed from this thesis and chapter 7 is the conclusion. Finally, Appendix A is the initial test plan used during the research for this thesis. Now, in order to better understand the concepts presented later in this document, a firm understanding of the background of both distributed learning and multicast is needed.

THIS PAGE INTENTIONALLY LEFT BLANK

II. BACKGROUND

This thesis examines the role of multicast traffic supporting distributed learning in networks utilized for production. Such networks are extremely sensitive to traffic delays. Thus, if multicast is to be used for distributed learning, the effect of multicast traffic on the underlying network's efficiency is of critical importance. To better understand the terminology and information provided in later chapters, the following background information is provided. Even if the reader is knowledgeable of both distributed learning and multicast, skimming this chapter is recommended to ensure a common point of reference for the material subsequently presented.

A. DISTRIBUTED LEARNING

The insertion of technology into teaching has blurred the lines between traditional and non-traditional instruction. A traditional course that heavily uses a Web site and audiovisual content lends itself well to distance learning. The large numbers of video teleconferencing facilities allow students in distant locations to take residence courses via streamed video. The Internet transformed the methods of delivering most conventional distance learning courses and gave birth to Distributed Learning. Within this context of rapid change, the definitions of distance learning and distributed learning continue to evolve. So, for the purpose of this thesis, the following definitions and distinctions apply.

1. Distance Learning vs. Distributed Learning

Throughout the educational community and the Internet, the phrases "distance learning" and "distributed learning" seem to be used interchangeably, their primary characteristic being a physical separation of student and instructor. For the purpose of this thesis, a distinction will be drawn between the two. Distance learning is defined as "education in which students take academic courses by accessing information and communicating with the instructor asynchronously, either over an electronic medium or through postal exchange." [03] Distributed learning can then be defined as "the education of students taking academic courses by accessing information and communicating with the instructor and each other, synchronously or asynchronously over a computer network." Thus, distributed learning can be considered an extension of distance learning. That said, courses utilizing both asynchronous and synchronous communications over a network will be, in fact, both distance and distributed learning classes.

2. Some Distributed Learning History

Distance learning began as early as the 1700's, when institutions and individuals began to offer correspondence courses. One of the earliest known examples was found in the March 20, 1728 Boston Globe, where Mr. Caleb Phillips advertised "Teaching of the New Method of Short Hand," which boasted any "person[s] in the Country desirous to Learn this Art, may by having the several Lessons sent weekly to them, be as perfectly instructed as those that live in Boston." [04]

In 1873, the daughter of a Harvard University professor, Ms. Anna Elliot Ticknor, founded the Society to Encourage Study at Home. This Boston-based Society served as a primarily female student body and provided courses founded in guided readings with frequent tests. In 1933, the State University of Iowa broadcast the world's first educational television programs on subjects ranging from oral hygiene to identifying star constellations. Then in 1967, the British Open University was established to serve students around the world. It is currently the United Kingdom's largest university of any kind and its distance education courses are considered to be among the world's best. [04]

With the advent of HTML and the World Wide Web (WWW) the Internet went mainstream in the early 1990's. Its explosion onto the scene provided distance learning with new inroads into the average persons schedule and it eagerly began to utilize this new communications medium. New online schools began to develop and established distance learning schools started to migrate to the new technology. By the late 1990's, teleconferencing and instant text messaging software launched a whole new world of distance learning. These synchronous communications media allowed distance learning to merge with some aspects of tradition education, thus causing the birth of distributed learning. Students can now remain at home and participate in classes being held half way around the world.

3. Why Employ Distance and Distributed Learning

Distance and Distributed learning provide many benefits to students, instructors, and educational institutions. Students gain both flexibility and convenience, as they can choose the time and location of their study, as long as the appropriate delivery mode is used. Classes and sessions can be recorded if the learner cannot be present or for later study. For example, any worker with access to a computer could do class work during a lunch break and full-time students can access on-line subject materials from just about any computer as time avails. On top of this, people with families may find it easier to study during late evening hours, when distractions caused by television or children are less.

Convenience seems to be one of the primary factors that move a person to utilize distributed learning. But other factors that influence its use include mitigating the impact of foul weather in harsh climates (no commuting when roads are impassable), lack of facilities (limited budgets in rural communities or over crowding in urban institutions), highly mobile student populations (military members receiving TAD or PCS orders or migrant workers), or presentation methods more conducive to student learning capabilities (interaction, animation, etc.).

Distributed learning opens up a myriad of options for instructors. Instructors now have the option to record lectures for future use or to distribute the recordings to the class. Students from around the world can participate in a traditional class as if they were on campus. Through the use of electronic tests and automatic grading,

instructors have the potential to decrease preparatory time while increasing time available for educational material development and research.

Educational institutions now have the ability to reach a much larger student base. Through the use of electronic delivery of content for general education classes, which in the past were often filled to capacity, can now be even larger. The ability to perform student testing and anonymous instructor assessments online have eliminated just about every barrier to the distribute classroom. This new technology not only increases the revenue that an institution brings in, but also decreases the individual cost currently required to support students.

B. MULTICAST

Streaming audio and video data across a computer network or the Internet can be done in three basic ways, either unicast, broadcast, or multicast. All of these techniques involve the use of User Datagram Protocol/Internet Protocol (UDP/IP) to transmit enormous amounts of data from source to destination, via a continuous stream of relatively small UDP packets. The difference lies in the session type. Unicast is a one-to-one relationship. This means that the server must instantiate a new session (i.e., process thread) for every system that requests a data stream, and each session uses more host system and network resources. This means that a streaming server connected to a 100 Mbps shared access network, such as Ethernet II or an IEEE 802.3 based network, can support a maximum of 28 multimedia clients if

each client's stream requires 3.5 Mbps of bandwidth. Figure 1 illustrates this problem. The depicted connection from the Streaming Server to the Edge Router would be utilizing 35% of the total bandwidth for that link while the connections from the Edge Router to the Clients would only be using 3.5% of their links. This is the case if every client has a 100 Mbps connection, if a client has a 10 Mbps connection, 35% of its bandwidth is eaten up. From this example it can be seen that unicast can be very inefficient and could potentially consume all the bandwidth on the ingress of the Edge Router. Broadcast and multicast both reduces this impact on the router ingress bandwidth.

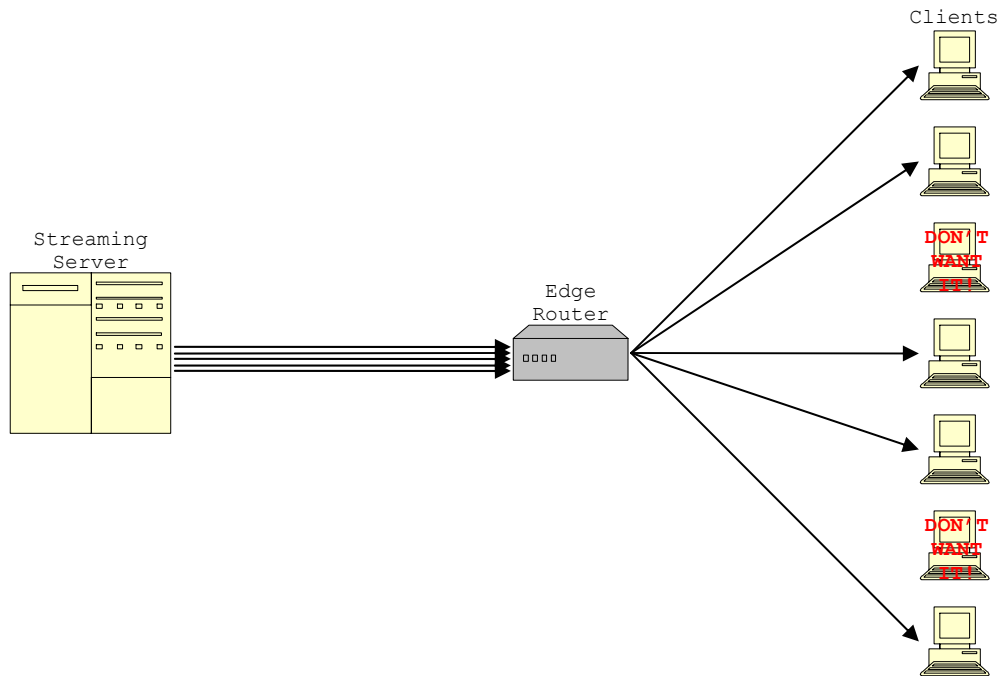

Figure 1. One-to-one Unicast Network Traffic

1. So, What is Broadcast?

In a network since, broadcast a means of transmitting data to every member of that LAN, using a standard

broadcast address. This address is used for all network broadcasts for that subnet and every member of that network segment utilizes it. Now, utilizing broadcast for streaming media would reduce the overhead on the server but there are several problems with using this method. First of all, everyone gets it weather they want it or not. This means, as can be seen in Figure 2, hosts that do not want to view the data stream still have to give up their bandwidth to it. Second, hosts already utilize this address for regular network administration, so the stream would interfere with this function. Third, since there is only one broadcast address per subnet, only one data stream at a time could be transmitted. Finally, all data sent to a subnet's broadcast address is restricted to that subnet (i.e.: not allowed past the network router or bridge). This restriction cannot be lifted to stream media between subnet because the administrative packet from different network would flow into the connecting networks and cause major problems.

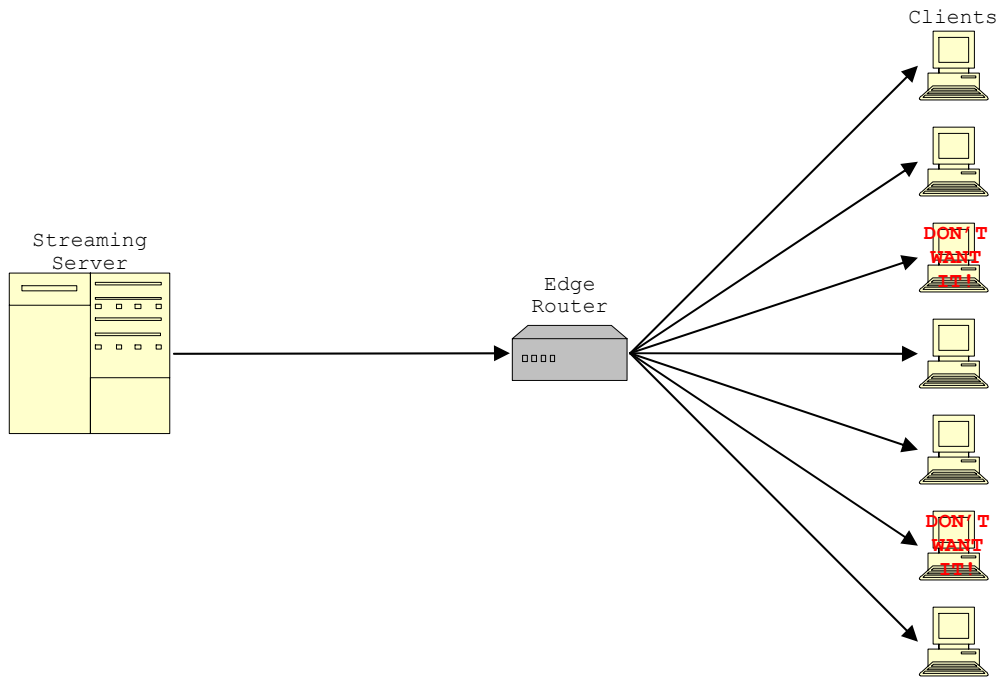

Figure 2. One-to-Many Broadcast Network Traffic

2. Then What's Multicast?

The origins of IP Multicast (multicast) can be traced to Mr. Steven Deering. As a Stanford University graduate student, in the late 1980's, he worked on a network-distributed operating system called "Vsystem". His primary goal was to develop a protocol mechanism to allow a broadcast data-stream to flow between IP sub-networks. In other words, the data-stream would have to be able to move through networked routers. His work was published in the premier IP-Multicasting Internet Engineering Task Force (IETF) document RFC-1112 ("Host Extensions for IP Multicasting" - August 1989). Subsequently it was published in his doctorate thesis on the subject ("*Multicast Routing in a Datagram Network*" - December 1991). [05]

Multicast is now defined as the sending of data from one originator to many recipients (one-to-many), or between many originators and many recipients (many-to-many). This means that one or more data streams may be sent to the same multicast IP address. All these data packets are duplicated by network and edge routers so that every system on the network can receive them, but only those systems that request to receive a particular stream will be provided with its data packets. Thus, if a network has no hosts which join a particular session, its bandwidth is not affected by the traffic generated for that session. Figure 3 depicts a multicast implementation of a one-to-many scenario in contrast to Figures 1 and 2. The primary feature of this multicast session, in contrast to the unicast version, is that only 3.5% of the overall bandwidth is required between the Server and Edge Router. In comparison to the broadcast version, the LAN clients that

are not interested in the session do not have to give up bandwidth on their network connection to it.

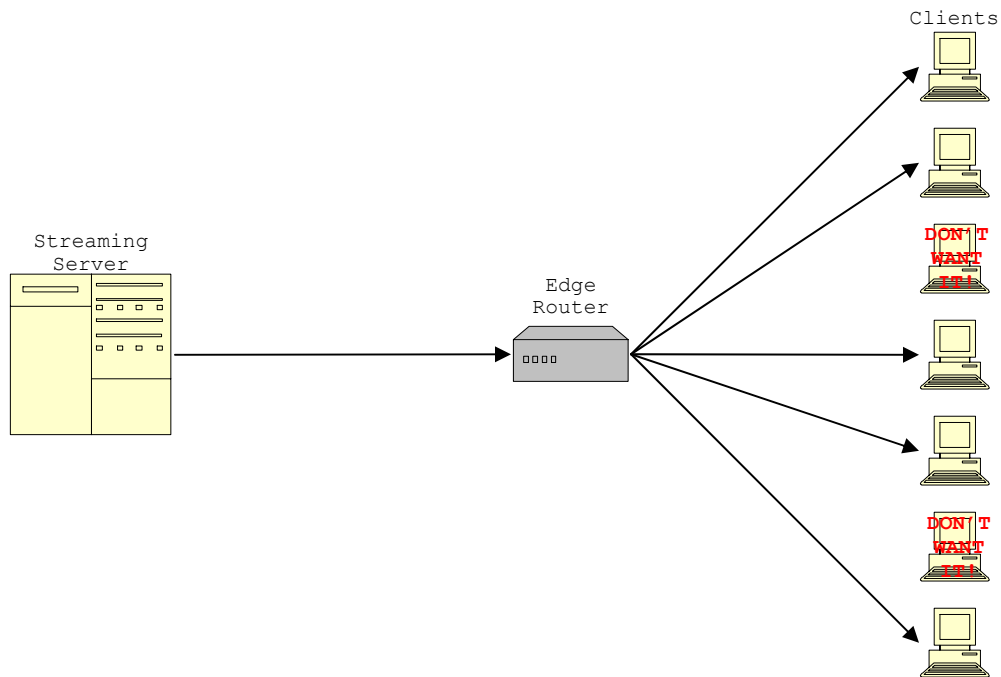

Figure 3. One-to-Many Multicast Network Traffic

Figure 4 provides a representation of a typical many-to-many multicast relationship. As can be seen, multiple originators provide input to the same multicast data stream by sending their relevant UDP packets to the same multicast IP address. All participants in the session receive those packets. In this figure, the computers with the double arrowed lines are both providing content to the stream and extracting data from it. The hosts with only unidirectional arrows are only receiving content from the stream. Those systems that are not participating in the session have the dotted lines and are not receiving any data from the

stream. The latter underscores the fact that not all hosts on a network will necessarily participate in a given multicast session.

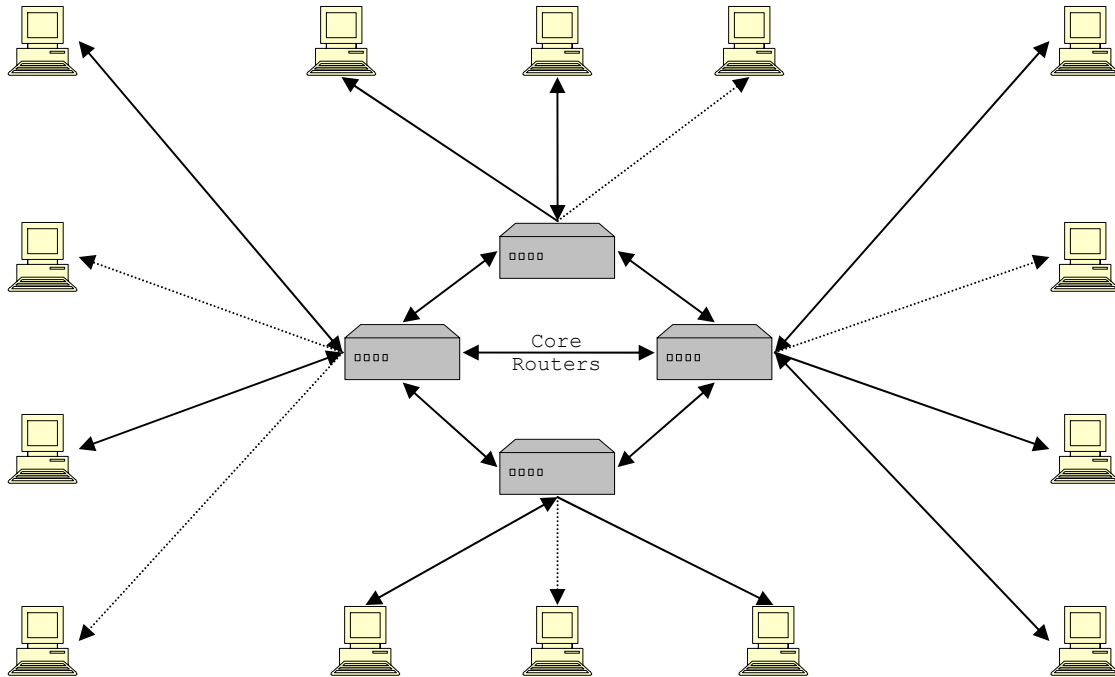

Figure 4. Many-to-Many Multicast Network Traffic

3. The Multicast IP Address Space

Multicast utilizes a different IP address range than the address space used for point-to-point (unicast) network communications. Point-to-point Internet sessions are conducted using Class A, B, and C IP address ranges. In contrast, multicast sessions are sent to a group address, which is part of an assigned Class D IP address space. This space occupies the range of addresses from 224.0.0.0 to 239.255.255.255. These addresses are also different in that they are only used on a session-by-session basis

while Class A, B, and C addresses are of a more semi-permanent nature. Figure 5 provides an example of how these address ranges relate.

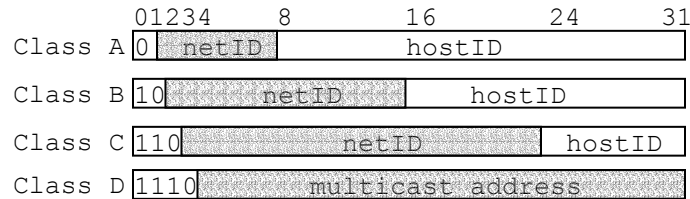

Figure 5. IP Address Classes [10]

The multicast address space is maintained by the Internet Assigned Number Authority (IANA), as are unicast addresses. The IANA maintains a list of multicast addresses that have been registered to users or assigned for certain functions. The 224.0.0.0 to 224.0.0.255 and 239.0.0.0 to 239.255.255.255 address ranges have been set aside for administrative purposes. The lower address range, 224.0.0.0 to 224.0.0.255, has been permanently assigned to various applications such as router protocols and subnet communications. Other permanently assigned multicast IP addresses are in the range, 224.0.1.0 through 224.0.23.11. See Table 1 below for a short list of some of the more notable applications and users. These addresses should not be used on a session-by-session basis by other users or functions. The IANA web site (<http://www.iana.org>) maintains a complete and up to date list of all reserved network addresses. [06]

The final entry in Table 1 is the multicast local scope address range. This address range is to be used for multicast within a LAN and routers are not supposed to forward packets addressed to this range outside the LAN.

This range fills the same purpose as the standard IP local scope address ranges, 10.0.0.0 through 10.255.255.255 and 192.186.0.0 through 192.168.255.255.

Applications	IP Address
All systems on the subnet	224.0.0.1
All routers on the subnet	224.0.0.2
All DVMRP routers	224.0.0.4
All RIP2 routers	224.0.0.9
All PIM routers	224.0.0.13
IGMP	224.0.0.22
Router-to-Switch	224.0.0.25
Microsoft and MSNBC	224.0.12.0 - 224.0.12.63
Hewlett Packard	224.0.15.0 - 224.0.15.255
Dow Jones	224.0.18.0 - 224.0.18.255
Walt Disney Company	224.0.19.0 - 224.0.19.63
SAPv1 Announcements	224.2.127.254
SAP Dynamic Assignments	224.2.128.0 - 224.2.255.255
Local Scope	239.255.0.0 - 239.255.255.255

Table 1. Assigned Multicast Addresses

Finally, the IANA has also set aside the 233.0.0.0 to 233.255.255.255 address range to provide every Autonomous System (AS) with its own multicast address range. To find out what the address range is for an AS, the AS number is converted into binary and padded with zeros on the left to sixteen digits. This 16 bit binary number is then used as

the middle 16 digits of the binary IP address. Figure 6 depicts this conversion. [07]

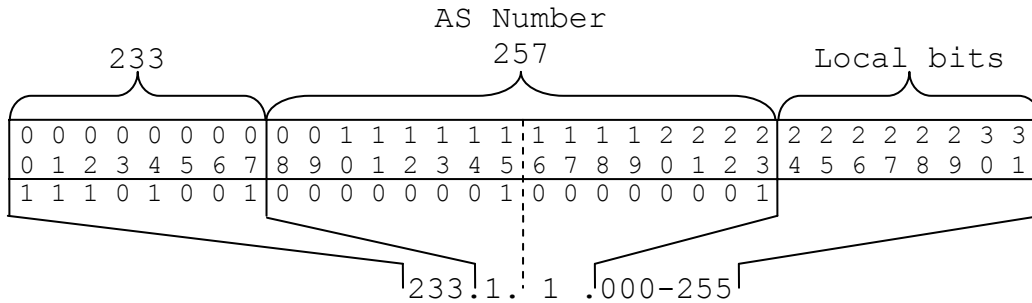

Figure 6. AS Multicast IP Address Conversion

The AS number utilized in Figure 6, 257, is assigned to the Naval Postgraduate School (NPS). Thus, the address range assigned to NPS for use on the open Internet is 233.1.1.0 to 233.1.1.255. Now that the multicast addressing schema has been defined a look at the types of multicast is in order. [08]

4. Types of Multicast

Link-layer and Network-layer Multicast are the two primary forms of multicast. Network-layer multicast, also known as IP Multicast, is further broken down into two classes, Any Source Multicast (ASM) and Source Specific Multicast (SSM). ASM was the initial type of multicast developed and is still the primary form of multicast in use today. Thus, following the discussion in this section, all references to multicast will signify ASM. All three of these schemas are expanded on below.

(a) Link-Layer Multicast

Common LAN's have always been considered a shared medium for applications utilizing connectionless

communications. This means that all stations on a LAN listen to all transmissions on the medium. Each of these stations must have a physical address, which is more commonly known as a global Medium Access Control (MAC) address (i.e., unique in the world). [09]

There are three types of MAC addresses; they are unicast, broadcast, and multicast. Unicast is used for point-to-point communication between specific hosts or endpoints on a link. A broadcast MAC address is all 1's and is usually not allowed to transcend bridges or routers. Multicast link layer addresses are used to map stations to IP-layer multicast addresses. There are a number of Link-layer multicast solutions that have been utilized. [09]

Frame Relay, Switched Multimegabit Data Service (SMDS), and Asynchronous Transfer Mode (ATM) multicast are all examples of link-layer multicast schemes. Frame Relay multicast was designed to function over Wide Area Network (WAN) connections between routers. It is connection-oriented and only its One-way multicast mode has ever had wide usage. SMDS is connectionless and is functional but has not gained the popularity of Frame Relay. ATM is similar to Frame Relay in functionality but at higher data rates. It is also an emerging technology and its maturity level is lower. This concludes the discussion on Link-layer multicast. It is not used as widely as IP multicast and will not be discussed further in this thesis. [10]

(b) Any Source Multicast (ASM)

Currently, the dominant Network-layer multicast protocol is Any Source Multicast, also known as Any-to-Any

Multicast or Internet Standard Multicast. In this model, multicast groups are identified by their multicast IP address. Senders use the multicast group address as the destination address for packets to that group. This allows members and non-members, possibly even malicious attackers, to send data to any multicast group address on a network. Since ASM allows this many-to-many relationship, it is very complicated to implement in routers. This ability for every node in a session to communicate with every other node comes at great cost to the router. The router must expend memory and processing power to maintain a dynamic routing table, where entries must be added and removed as nodes come and go in the session. Furthermore, the router must expend the processing power required to duplicate every packet transmitted for every node, whether they be the next hop router or switch or the end host, while ensuring that packets are not transmitted back to the originating node. This could quickly become a big problem if the number of participants in a session becomes very large. [11]

Fortunately, most routers purchased within the last several years come with multicast routing as a feature, although implementations vary from manufacturer to manufacturer. This variation can cause configuration and compatibility problems between routers, as well as switches, from different manufactures.

(c) Source Specific Multicast (SSM)

The Source Specific Multicast (SSM) protocol is also a Network-layer multicast type. It is a more recent development, designed to be more easily implemented in

routers and to require less router resources to maintain. Further, it is touted to scale better than ASM.

SSM provides multicast channels, which are identified by a group address as the destination in addition to the source address of the sender or senders. In this multicast model, only a few pre-specified nodes in a session are allowed to add content to the session. All other nodes in the session just receive the data stream. Traffic is only forwarded to receivers from those multicast sources with which the receivers have explicitly expressed interest. SSM is primarily targeted at one-to-many (broadcast style) or few-to-many applications. Further, SSM solves many problems that currently exist with the ASM model, like denial of service attacks and address allocation. [23]

This concludes the discussion on the different types of multicast. From this point on, every reference to multicast will mean ASM. Now, a look at how multicast and distributed learning can be combined to produce an optimal leaning environment.

C. MULTICAST DISTRIBUTED LEARNING

Distributed learning and multicast are an excellent pairing. With multicast's ability to reach multiple end-users with minimal network bandwidth utilization and distributed learning's goal to train and educate geographically separated student populations, they complement one another quite well. Thus, by applying distributed learning over a computer network utilizing a

multicast protocol, a Multicast Distributed Learning (MDL) capability is established.

MDL has the potential to be the classroom of the future, incorporating all of the benefits of both the traditional classroom and distance and distributed learning courses. It follows that multicast distributed learning has the potential to become very important in all facets of society. It remains to be shown whether or not current networks support it.

The following chapters will examine multicast routing algorithms, with an emphasis placed on those protocols utilized at NPS network. Following that, the step-by-step processes used to assess this network's ability to support and sustain multicast are presented. The data obtained during these tests helped to shed light on the requirements needed to implement multicast on both current and future networks in order to support multicast distance learning throughout the DoD.

THIS PAGE INTENTIONALLY LEFT BLANK

III. MULTICAST ROUTING PROTOCOLS USED ON NPS NETWORK

There are a multitude of different approaches to multicast routing and the protocols supporting them are often incompatible with each other. This is one reason the implementation of multicast routing in a network is complex. Router and switch manufactures have a tendency to implement the same standard protocols in different ways, adding proprietary components, which causes interoperability issues with equipment from other manufacturers. This is the difference between a manufacturer supporting a standard rather than complying with it. These inconsistencies then require translation processing steps or additional hardware or software to mitigate. They even have the potential to dramatically impact a network's efficiency and the QoS provided.

This chapter examines the multicast routing protocols used at NPS and others that provide useful background information. It is provided in order to promote a good understanding of the current multicast routing protocol versions and the standards upon which they are built. At this point a critical note must be emphasized: these protocols are only used to setup the routes from host-to-router, router-to-host, and router-to-router for the multicast groups. The actual data stream is sent in the form of UDP/IP packets. To emphasize this point the following example is provided.

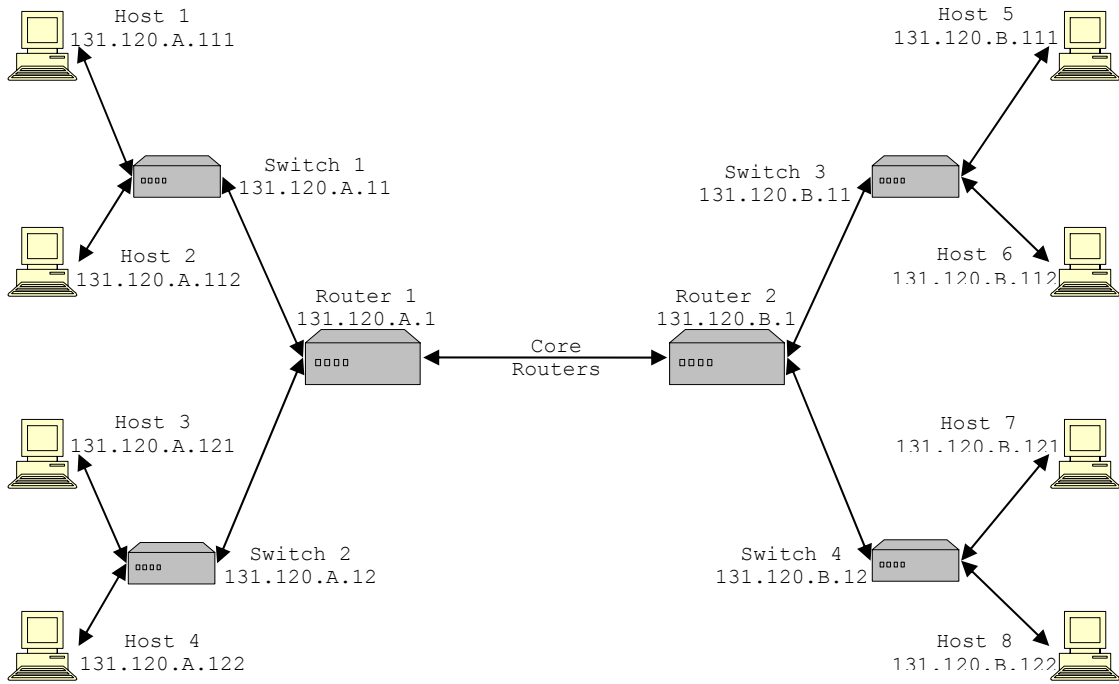

Figure 7. Network Diagram for Protocol Discussion

All of the components of the sample network depicted in Figure 7 are multicast enabled and Host 1 is the multicast stream source. When Host 1 initiates the multicast session, it sends two types of messages to the network, an IGMP Join message and a Session Announcement Protocol/Session Description Protocol (SAP/SDP) message. The first message is used to notify the router of the session and the second is to notify the network clients of the session. These packets are forwarded through Switch 1 to Router 1.

When Router 1 receives the IGMP message it adds the session to its (S,G) table, while it distributes the SAP/SDP message through all its multicast enabled ports. The (S,G) table is not part of the normal routing table, it is a multicast routing table used by IGMP. The router then sends multicast routing protocol specific messages to the other

routers in the network so that the group can be added to their tables, and it also sends IGMP queries to its hosts to determine membership preferences.

During this process Host 1 starts transmitting its UDP/IP data stream to the group and continues to send IGMP Group Membership messages to Router 1. All of these packets flow through Switch 1 and it is looking for the IGMP packets using IGMP Snooping. When it detects these IGMP packets on one of its port, it sets that port as a multicast recipient and sends all multicast related packets to that port as long as IGMP messages come from it.

Other hosts that desire group membership will also start by sending IGMP join messages to their multicast enabled router. This in turn will enable their switch ports to receive the multicast transmission and when the responsible routers see the join requests, they add their requesting hosts to their (S,G) table and start relaying the UDP/IP packet to them. The switches in the network will utilize IGMP Snooping to minimize multicast traffic on ports that do not join the session. Each of the protocols mentioned here will be described in greater detail below.

A. ANNOUNCEMENT AND DESCRIPTION PROTOCOLS

A multicast source uses a SAP/SDP message to announce and describe a multicast session to the network. The session source sends a SAP/SDP message when the session is started and then periodically to keep session information current (i.e., session modification or deletion). Announcement repetition also serves to notify dynamic hosts of the ongoing session.

1. Session Announcement Protocol (SAP)

SAP was designed as a means to publicize and distribute relevant setup-information about multicast sessions to a prospective audience. It also allows for session modification and deletion. SAP messages are distributed using a designated multicast address range that is not the same as the multicast session addresses it is publicizing. Furthermore, the SAP requirement does not contain a rendezvous mechanism and allows for no reliability above that offered by standard best-effort UDP/IP. This means that a SAP announcer will never be aware of the absence or presence of any listener (i.e., the source of the multicast traffic does not know if there are any clients for that traffic). In the context of the example above, while Host 1 periodically sends out SAP messages to keep the network informed of the session it is providing, the other hosts in the network join the session group but do not respond to the source of the SAP messages. Thus, Host 1 never knows who, if any, of the other hosts in the network are members of the session. [12]

Another feature of the SAP message is the SDP and authentication header. The SDP is carried in the payload segment of the SAP packet, see Figure 7 below. It will be described in greater detail in the next section. SAP authentication is not mandatory but can be used to prevent unapproved session modifications and deletions. The authentication header is provided for this purpose. See Figure 7 below for the layout of the header. The authentication data field is the primary security piece of the header. It is used by session clients to verify a

session's source and validate any changes to that session. The SAP standard does not specify a sole authentication mechanism to be used for the authentication header. An authentication header can be as simple as a hash of the header information signed by the SAP originator or as complex as a nonstandard, user-defined encryption algorithm. The header authentication data field is self-describing as the authentication mechanism used provides the precise format. [12]

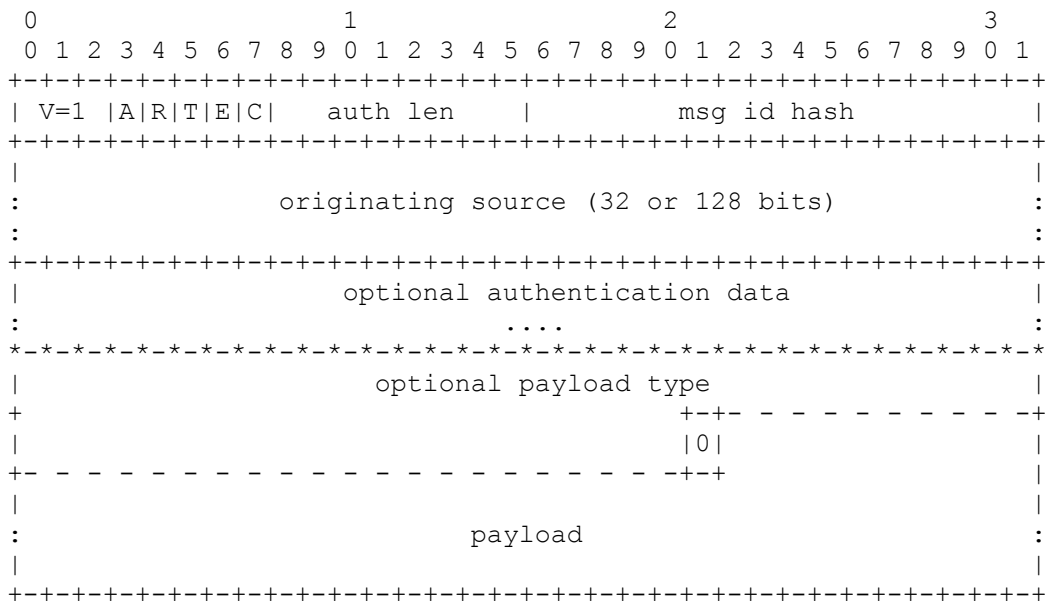

Figure 8. SAP Message Format [12]

As started above, the SAP announcer periodically sends out announcement packets to a multicast address and port in a designated range. The time period between SAP messages is chosen so that the total bandwidth used by all announcements for a single SAP group remains below a preconfigured limit. A bandwidth limit of 4000 bits per second is assumed if not otherwise specified. The address used for SAP announcements will be the highest one in the

multicast address scope selected. For instance, since NPS has the address range from 233.1.1.0 to 233.1.1.255, SAP messages should be sent to 233.1.1.255 on port 9875. This is the designated port number for SAP communications and all SAP messages should be sent to that port. The information contained in this section was taken from RFC-2974; see reference [12] for a more in-depth explanation of SAP.

2. Session Description Protocol (SDP)

Session directory assist applications help in the advertisement of multicast sessions and communicate the relevant conference setup information to prospective participants. SDP was designed as a conveyance for this information. This protocol does not incorporate a transport protocol. It was designed to be used as an add-on to other transport protocols such as SAP. In Figure 7 above, the SDP message is contained in the payload section on the packet. [13]

SDP provides the following basic information:

- Session name and purpose
- Time(s) the session is active
- The media comprising the session
- Configuration information to receive those media (addresses, ports, formats and so on)

This basic information is only a very small portion of the information that this protocol can convey. Each of these fields breaks down into many other fields so that a session can be described in great detail. All of the

information contained in this section was taken from RFC-2327; see reference [13] if a more detailed explanation of SDP is needed.

B. INTERNET GROUP MANAGEMENT PROTOCOL (IGMP)

IGMP is one of the primary LAN multicast routing protocols and version 2 is currently being utilized at NPS. It is a LAN-based signaling protocol used for the creation of transient multicast groups, the addition and deletion of members of those groups, and the periodic confirmation of group membership. In other words, its primary purpose is for end-systems (hosts) to declare their membership in a particular multicast group to the nearest multicast enabled router. IGMP can also be used for router to router multicast routing but it is not intended for that purpose and will not be discussed here.

The original version of IGMP (IGMPv0) was developed by a Stanford University graduate student, Mr. Steve Deering. It was first presented in July 1986 as Appendix I of RFC-988. This asymmetric protocol is similar to ICMP in that it must be an integral part of IP for multicast to function. So, for IGMP to work in full on a LAN segment the following two statements must be true. First, IGMP is required to be implemented in total by all hosts, conforming to level 2 of the IP multicasting specification. Second, that LAN segment needs to have one elected controller, a router, which periodically queries all hosts. This is the definition of an IGMP multicast enabled LAN. [14]

When multicast sessions are available on a LAN, the multicast routers send out IGMP queries intended to refresh

their group membership tables or (S,G) table (S = source address and G = group address), and to allow new members to join the groups. This is accomplished when the stations respond to the queries with a report for each group to which they want to belong. Now, since IGMP query and report messages are encapsulated in IP datagrams, with an IP protocol number of 2, the TTL fields on both queries and reports, for these exchanges, are set to 1. This limits the scope of the exchange to the local subnet. In Figure 8 below, IGMP will function only between the hosts (i.e., 131.120.A.###) and their router (i.e., 131.120.A.1). This figure will be used to facilitate discussion throughout the remainder of the IGMP section. [14]

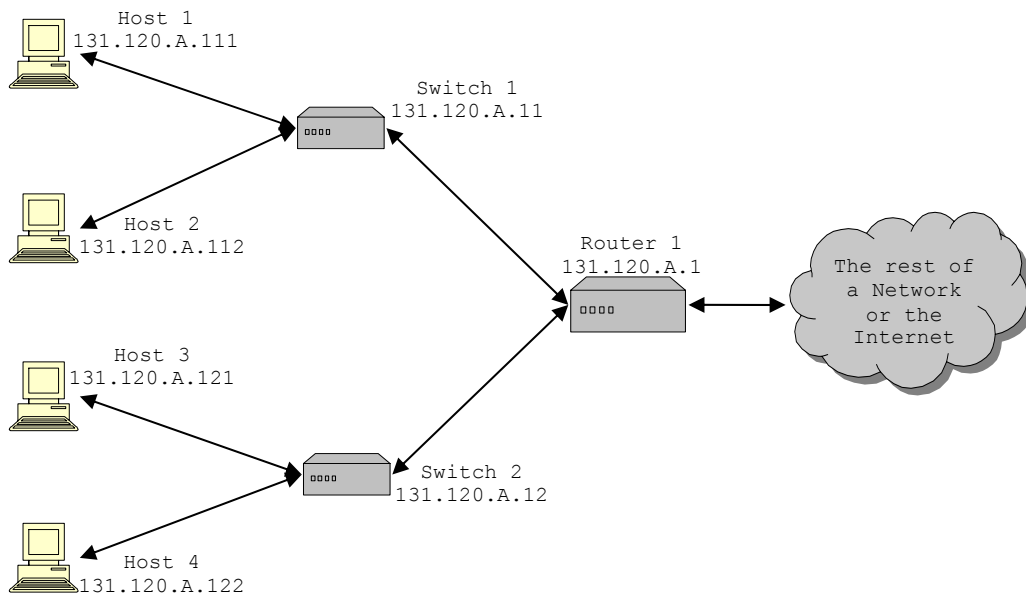

Figure 9. Network Diagram for IGMP Discussion

There are currently four versions of IGMP. The remainder of this section provides summaries of the relevant IGMP versions and of IGMP Snooping. Since IGMPv0

is no longer in use, it will not be discussed here. If more information on IGMPv0 is desired, refer to RFC-988.

1. Version 1 (IGMPv1)

Although IGMPv0 was the genesis of multicast on LAN segments, IGMPv1 was the first version to be widely accepted and implemented. This version was redesigned by Dr. Deering and published in August 1989 as Appendix I of RFC-1112. IGMPv1 is still found in use today, although it has been gradually replaced by IGMPv2 since 1997. The message format for IGMPv1 is provided in Figure 9. The type field in this message format provides for the two main types of IGMPv1 messages: reports and queries. An IGMPv1 report is used by a host to join a multicast group, with the type field set to 2. The IGMPv1 query is used by the router to maintain its group membership routing table, with the type field is set to 1. [14]

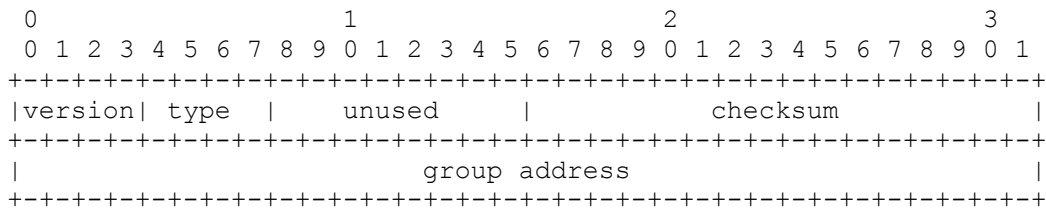

Figure 10. IGMPv1 Message Format [14]

IGMPv1 basically functions in the following manner. When a multicast source is introduced onto a network, that source will join the group by sending out an IGMP Join message. This can be to either a currently established session or the source can create a new session. It then starts sending its multicast data stream, in UPD/IP packets form, to the group address. At this time, either a

designated multicast router or the IGMP enabled router closest to the source will become the querying router. This router adds the entry to its (S,G) table and sends out an IGMPv1 query to see if any other hosts want to be part of the group. It will also periodically send out IGMP queries to update group membership and maintain its (S,G) routing table.

If there are multiple hosts on a subnet, when the router sends a periodic query for group membership to that subnet each host sets a random countdown timer. Each host will then listen for a reply on their subnet. The host whose random timer runs out first will send the IGMP reply. The other hosts, seeing this reply, will cancel their impending reply. This reduces the overhead generated by the routing protocol. If a more detailed description of the IGMPv1 message format is desired, see RFC-1112. [14]

Using Figure 8 above, the following example is offered to make the concept more concrete. Host 1 is the multicast source. It begins the transmission with an IGMPv1 report to the group address, 233.1.1.100, and starts the multicast stream to that address. Switch 1 forwards the packets to Router 1. Router 1 recognizes the IGMP report and, with the other routers on the LAN, utilizes a manufacturer specific election process that determines the multicast controller for the network segment. All the routers add the multicast group to their routing tables. The controller, Router 1, then sends out a group membership query to all the hosts on the network. Host 3 then joins the group by sending an IGMP report to the group address. Router 1 receives this report, adds the host to its group routing table, and starts

relaying the packet stream from Host 1 to Host 3. This exchange occurs for every host on a previously pruned port that joins the group. Periodically, the router will send the IGMP query to update its table. If Host 3 is the only member of the group and it fails to send an IGMP report in response to the periodic queries the router will assume no hosts desire group membership and will stop the data stream to that connection. The controller will continue to send the periodic IGMP queries to all the LAN hosts.

In summary, IGMPv1 provides for a host to join a group by sending an IGMP report message. To leave a group a host does nothing; it simply ignores the controller's queries. The IGMPv1 router will periodically poll all the hosts on its subnets using IGMP queries. Hosts on that subnet respond to the Queries in a randomized fashion to maintain membership in desired groups. See Appendix I of reference [14] for a more details explanation of IGMPv1.

2. Version 2 (IGMPv2)

IGMPv2 is currently the backbone of LAN segment multicast routing. It was defined by W. Fenner in RFC-2236, which was accepted by the IETF in November 1997. This action made IGMPv1 obsolete and brought IGMPv2 to the forefront of the multicast effort. This version of IGMP is backwards compatible with IGMPv1 and is, for the most part, just an enhancement to it. The primary improvement over IGMPv1 is the addition of a multicast controller election process, Leave Group messages, and Group Specific queries. These augmentations were predominantly made to improve the performance of the protocol. [15]

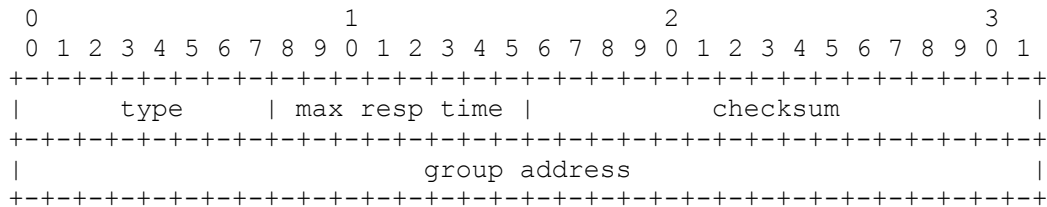

Figure 11. IGMPv2 Message Format [15]

Figure 10 is the message format for IGMPv2. In comparing this format with that of IGMPv1 note that the Version and Type fields are combined into a single Type field. Also note that the second field, previously unused, now contains the Maximum Response Time field. These changes were made so that routers on WANs where both IGMP versions are used can tell the difference between an IGMPv1 and IGMPv2 host report. Furthermore, new IGMP types have been assigned to the Version 2 Membership Report messages and the Leave Group message. A Leave Group message is used by a host who no longer wishes to be part of the multicast session. Now, instead of ignoring the router queries and waiting to be dropped from the group, the host sends a Leave Group message to the router and the router immediately removes the host from the session.

In IGMPv1, the controller election process was not part of the specification and thus, various implementations of the IGMPv1 had different mechanisms to perform the query function. This had the potential to result in more than one controller per network. IGMPv2 incorporated the election mechanism and made it part of the standard. In networks where IGMPv2 routers coexist with IGMPv1 routers, the potential problem of multiple controllers still exists. To mitigate this problem, an IGMPv2 router must be able to act

like an IGMPv1 router. To do this it utilizes the Version 1 type-field values, sets the Max Response Time field to 0 for all queries, and ignoring Leave Group messages.

If the network in Figure 8 employs Version2 and Host 1 is again the multicast source, Host 1 initiates the multicast session by sending an IGMPv2 report to the group address, again, 233.1.1.100, and starts transmitting the multicast stream to that address. Switch 1 forwards the packets to Router 1. Router 1 recognizes the IGMP report and, with the other routers on the LAN, utilizes the standard election process to determine the multicast controller for that network segment. All the participating routers add the multicast group to their (S,G) routing tables. The controller, Router 1, then sends out a group membership query to all the hosts on the network. Host 3 joins the group by sending an IGMP report to the group address in response. Router 1 receives this report, adds Host 3 to its (S,G) routing table, and starts relaying the packet stream from Host 1 to Host 3. The router will resend the IGMP query to update its table. To stop receiving the multicast stream, Host 3 sends a Leave Group report to the group address. When the controller receives this report it sends a group specific query to that port to check for any remaining members. If no reports are received it immediately removes that host from its (S,G) table and stops the data stream to that port since there are no longer any hosts desiring membership. It is key to remember that the (S,G) table is comprised of entries that specify the Source (i.e., host or subnet connected to that port on the router) and the Group to which it belongs. So, if a Source belongs to several multicast Groups, then each will

have an entry in the (S,G) table. The controller will continue to send the periodic IGMP queries throughout the LAN even though that branch has been pruned.

In summary, IGPMv2 is backwards compatible with IGMPv1. The primary differences being the addition of a standardized multicast controller election process, the Leave Group messages, and Group Specific queries. See Appendix I of reference [15] for more details of IGMPv2.

3. Version 3 (IGMPv3)

IGMPv3 was developed by the IETF Network Working Group and accepted as RFC-3376 in October of 2002. Since this protocol has been in use for such a short time, with only limited implementations thus far, only a brief summary will be provided here. The main additional feature of IGMPv3 is the inclusion of source filtering. This change allows IGMPv3 to accommodate SSM as well as ASM. This change was accomplished by modifying the format of membership reports and queries. The query message size has been increased and the ability to designate multiple specific sources for a particular group has been added. For Ethernet networks, the number of multicast sources that can be specified in a given query is limited to 366. This constraint is due to the maximum transfer unit (MTU) size. Membership report messages now have their own format which allows a host to join a group and specify a set of sources from that group from which it will receive data streams. The new format also has multiple sections to report membership in multiple groups, thus allowing report of a host's full current state

using fewer packets. Similarly, leave group messages have been enhanced to allow combined group source leave messages. [16]

Further enhancements were also included. Version 3 maintains the state as Group-plus-List-of-Sources and the IP Service Interface was changed to allow specification of source-lists. The controller includes its Robustness Variable and Query Interval in Query packets to allow synchronization of these variables on non-controller routers. The Maximum Response Time in Query messages has an exponential range, changing the maximum from 25.5 seconds to about 53 minutes, which helps when used on links with huge numbers of systems spread over a large area. Hosts retransmit state-change messages to increase robustness. Join Group messages and Leave Group messages are both considered state-change messages because they change the state of that port on the router. Additional data sections are defined in the message formats to allow later extensions. Report packets are sent to 224.0.0.22, this assists layer-2 switches with IGMP snooping. Hosts no longer perform report suppression, to simplify implementations and permit explicit membership tracking. Finally, the new "Suppress Router-Side Processing" flag in query messages fixes the robustness issues which are present in IGMPv2. [16]

IGMPv3 is backwards compatible with both IGMPv1 and IGMPv2 systems and interoperability with these systems is defined as operations on the IGMPv3 state diagram. This is accomplished in much the same manner as in IGMPv2, in that

the IGMPv3 router basically emulates an older router when placed on networks in which older routers still operate. [16]

In summary, IGMPv3 adds Group-Source Specific Queries, Reports, and Leaves messages to IGMPv2. It also adds Inclusion and Exclusion of sources. For a more in-depth description of the protocol refer to [16].

4. IGMP Snooping

An Ethernet switch floods multicast traffic within the broadcast domain by default and this can consume a lot of bandwidth if many multicast servers are sending streams to the segment. Multicast traffic is flooded because a switch usually learns MAC addresses by looking into the source address field of all the frames it receives. But, since a multicast group destination MAC address (i.e., 01:00:5E:XX:XX:XX) is never used as a source MAC address for a packet and since they do not appear in the MAC Filtering Database, the switch has no method for learning them. [17]

In switched LAN environments multicast flooding can be a major problem. A technique known as IGMP Snooping is used to reduce this effect. Essentially, this routing method turns on and off multicasting to switch ports, at layer 2, by promiscuously monitoring each port for IGMP traffic. On switch ports where IGMP traffic is found, IP multicast traffic is forwarded. This greatly reduces the impact of flooding by layer 2 switches and decreases the potential congestion that can lead to frame loss. [17]

IGMP was not designed to determine routing paths between LANs in a WAN topology (i.e.: router-to-router). It has too much overhead to work effectively on a large scale. This is an area where multicast routing protocols need to be efficient and are very important. The following section address the first protocol designed for this purpose. [17]

C. DISTANCE VECTOR MULTICASTING ROUTING PROTOCOL (DVMRP)

While the IGMP protocol is used to setup paths from router-to-host in the routing table of the multicast-enabled "designated router" (DR), DVMRP is used for router-to-router path discovery. It was described in RFC-1075 and was the first multicast routing protocol designed for this purpose. Most of the information in this section was taken from RFC-1075. While DVMRP is not used at NPS, it was the preeminent multicast routing protocol until 1997 and is the second most used one today. [18]

DVMRP was loosely based on the Routing Information Protocol, Version 2 (RIPv2) and uses a distance vector technique based on the Bellman-Ford routing algorithm. This protocol uses the concept of next-best-hop and does not maintain a total picture of the router mesh inside each DR. Furthermore, DVMRP and RIP both have the same 32 hops maximum router mesh width. This restriction limits the deployment to small and medium sized enterprises. The Internet cannot universally use DVMRP for this reason. In addition, DVMRP only uses the hop count metric in its best route determination, which means that metrics such as link cost and congestion are ignored. [05]

Another thing that makes DVMRP similar to RIPv2 is its support for classless IP addresses. In this approach, the subnet mask is sent along with the IP address. This is referred to as Variable Length Subnet Masking (VLSM) and is a characteristic trait of RIPv2. [19]

DVMRP does not use the IP unicast routing table in the router. It uses a separate Multicast Routing Table (MRT) and a Multicast Forwarding Table (MFT) for all multicast traffic. The MRT is used to store routes back to a given multicast source. Notice the use of multicast "source" here instead of "destination" as would be in the case of RIPv2. This is due to the fact that IP-Multicast looks at the spanning tree in reverse. All multicast packets traverse the tree backwards from the end-users back to the source, rather than source to end-users as is done in conventional routing. Since a multicast group address references a group of nodes instead of a specific node, this is the only way that routing makes sense in a multicast world. [05]

The MFT is a simple vector of (S,G) values with their associated incoming interface port, outgoing interface port(s) and prune status. It is used by the routers' routing logic to quickly forward multicast packets to the correct outgoing interface based on the source and group addresses. It must be noted that the prune status, which is discussed below, is included so that traffic is not forwarded out branches that have requested not to be part of the active tree for that group. [05]

A series of floods, prunes, and grafts are used to build a multicast spanning tree. In DVMRP, the term flood refers to a process in which all DVMRP multicast routers

transmit multicast packets to all outgoing interfaces. DVMRP's insistence on doing this is a bit extreme, since many of the DVMRP routers may not have end-user nodes that are interested in joining the group (i.e., their (S,G) tables, filled-in by IGMP, are empty). In these cases, the routers in question will send "prune" messages to the DR. This is also referred to as sending prune messages back "up the tree", or "upstream". These prune messages tell the DR that they are not interested in the multicast traffic and the DR then stops forwarding them to that router. But the effect of the pruning is only temporary, after a couple of minutes the pruned branches re-grow, offering every router another chance to either re-join the main tree, if a host has requested entry into the multicast group via IGMP, or to send another prune message. [19]

The last message in DVMRP to examine is the "graft" message. It is used when a router is ready to re-enter the tree immediately, without waiting for the "de-pruning" process. The router in question sends a graft message upstream and the DR immediately grafts that branch back onto the tree. In current implementations of DVMRP, the DR maintains all information on pruned branches in its MFT and never really deletes them. The high volume of prune, grow-back, and graft operations in a typical multicast network make deleting impractical. Just toggling the state field in the MFT for each entry saves the router CPU cycles. This, and the modest amount of memory required to track all branches is insignificant compared to what it would take to just do the delete and add processes in a dynamic network. [19]

The network tree structure that is created through the process above is called either a shortest path tree (SPT), a "dense mode source distribution tree", or a "truncated broadcast tree" in IP-Multicast literature. Here the term "dense mode" is very applicable since it refers to the fact that, in this protocol, multicast traffic deliberately penetrates most of the overall network and that this is a desirable effect. Of the three terms above, SPT is the one most commonly used. [05]

A DVMRP router learns about its adjacent neighbors by sending periodic "Hello" messages on all of its outgoing interface ports. This action is performed on the 224.0.0.4 multicast address. As shown in Table 1, this is the "All DVMRP Router" address used by DVMRP routers. When a Hello message is received, the DVMRP router checks to see if its address is in the "Neighbor List" field of the message. If not, it places the interface address of the sending router in its Hello message and sends it. When a router receives the "Hello" message from the same router and identifies its own interface address in the messages Neighbor List field, the router knows that a two-way multicast routing connection has been successfully formed between itself and the message source. [19]

A typical DVMRP MRT has the following entries: source network, source network subnet mask, administrative distance, number-of-hops metric, uptime, expiration timer, next hop address and interface going towards the source, and information about the neighbor that sent the DVMRP route message. Periodically, each router transmits its entire multicast routing table to all of its DVMRP

neighbors. This helps to keep all neighboring routers synchronized. As can be anticipated, convergence of a topology change (i.e., new link or down/up link changes) within the router mesh can take time, as is also the case with RIPv2. Also, occasionally, entries in the table are deleted due to the expiration timer and subsequently need to be re-learned from neighbor route updates. [19]

The TTL (time-to-live) field of the IP header is used by the DVMRP protocol to denote the width the router mesh. The width is the area over which a multicast group extends. The standard TTL values are:

TTL Value	Scope of DVMRP Packet
0	Restricted to the same host
1	Restricted to the same sub-network
32	Restricted to the same site
64	Restricted to the same region
128	Restricted to the same continent
255	Unrestricted in scope

Table 2. DVMRP TTL to Scope

A DVMRP router also performs the Reverse Path Forwarding (RPF) check. This check is done during normal operation of the multicast router and uses the MFT to ensure that a multicast packet received on a given interface corresponds to the route back to the source that owns the group. This check eliminates any packets that are received on other ports due to a non-convergent router mesh. This typically occurs when there has been a recent topology change. Once a packet passes the RPF check, it is forwarded out to all active downstream interfaces. It should be noted that prune messages may have greatly reduced the population of the active interface list. This

reduction is crucial in a dense mode protocol because without pruning multicast looks more like IP broadcasting until the final-hop, where IGMP handles the final packet delivery. [19]

As was previously noted, DVMRP does not scale well and tends to be quit verbose. In addition, DVMRP requires lots of router memory to maintain the separate multicast routing and forwarding tables. This protocol is, however, the easiest multicast routing protocol to understand and is viable for small-to-medium size networks. This is especially true if only LANs are involved and most end-users want to receive the majority of the transmitted multicast traffic. Finally, the DVMRP SPT approach, which uses a designated rendezvous point router, is in direct contrast to protocols that use the "shared tree" approach that is not based on the multicast source's router. PIM-SM uses this shared tree approach. [19]

D. PROTOCOL INDEPENDENT MULTICASTING (PIM)

The IETF's Inter-Domain Multicast Routing (IDRM) working group began development of a multicast routing protocol that would operate independent of the unicast routing protocol being used. One of the primary goals of this group's effort was to develop a protocol that can use existing routing and topology tables, and does not create multicast specific tables. This approach is in direct contrast to DVMRP and its use of the MRT and MFT. [05]

While the PIM protocol was designed to provide superior sparse mode operation, it supports a dense mode model as well. The decision by the committee to provide

both modes allows PIM to be a total solution for IP-Multicast without depending on DVMRP or other protocols for a dense mode solution. These modes, sparse and dense, operate quite differently and are discussed in detail in the next two subsections. [05]

1. Sparse Mode (PIM-SM)

Currently, the most popular IP-Multicast protocol is PIM-SM. [18] When the PIM protocol for IP-Multicasting is mentioned in multicast literature it is usually in reference to the sparse mode of its operation. PIM-SM is one of only a small number of IP-Multicast approaches that provides a more efficient method for multicasting when there is only a small number of end-users that want to receive the group traffic or when a WAN link is needed to access the multicast sources. PIM-SM uses a Rendezvous Point Tree (RPT) as its primary spanning tree. This means that a single "rendezvous" point (RP) is between sources and recipients. A multicast-enabled router specified by the network administrator functions as the RP and is typically the first-hop router from the multicast sources. Since the end-users are downstream from the RP-based distribution tree, the designation for a particular multicast group is (*,G). This implies that all multicast groups are sourced from the same RP. In reality, the existence of multiple RPs in a network is possible, each responsible for a subset of the multicast group addresses on that network. [05]

In order to make this shared tree approach work for multicast, some initial difficulties had to overcome. Since an RPT is unidirectional and packets can only flow from the

RP to the end-user, a discovery mechanism for RPs and other downstream routers was needed to enable new group users to be added. Furthermore, a means of providing a given last-hop router with the initial IP address of the RP needed to be established. [05]

The process used to discover a new group user involves sending a standard SPT from the last-hop router back to the RP. The router's standard unicast routing table is used and a "PIM Shared Tree Join" is performed. When this occurs, each router along the path back to the RP adds the (*,G) entry for the required multicast group. Remember, end-users will join a group using the standard IGMP protocol discussed above. When a last-hop router, using IGMP discovers that there are no subscribers to a given multicast group, a "Shared Tree Prune" message is sent back up the SPT to the RP so that it can stop the packet flow to that router. Using this technique, timeouts are not the primary means to prune branches. [05]

Currently, there are several methods used for a given last-hop router to gain initial knowledge of the RP's IP address. The most straightforward approach is to manually enter the RP's IP address into every router that might participate in multicast session. The fundamental problem with this method is its inability to scale. There are several proprietary methods used to automate this function, but they are neither widely excepted nor implemented and will not be discussed here. Version 2 of PIM-SM, which is currently in IETF draft, (<http://www.ietf.org>), offers another option. It outlines a bootstrap process what will be used to discover the addresses of all RPs on the

network. The method used depends on the PIM version implemented and the network equipment used. But it is crucial that the multicast routers know the RP's IP address, since standard unicast routing is used to implement a group join operation. [05]

PIM-SM has one feature that is not available in other sparse mode protocols. The ability for a last-hop router to request a direct SPT back to a multicast source, without requiring the source to link to the shared RP tree, was included in the protocol. This feature gives a source node the ability to provide service directly to a set of end-users without routing the multicast stream through an RP. [05]

A final note on the operation of PIM-SM: it uses a SPT from the RP back to the source so that the source can provide its packet stream to the RP. The source informs the RP of its existence by sending a special PIM message, called a "Source Registration", directly to the RP's IP address using a unicast packet. Once the RP receives the unicast packet, it then makes the reverse connection back to the sourcing node. This connection is not a standard TCP connection. It is more along the lines of a UDP message from the source to the RP and another from the RP to the source. Once this packet exchange, is made the two devices are in essence, connected and the source now has the required routing information. [05]

2. Dense Mode (PIM-DM)

PIM-DM is the core multicast routing protocol used at NPS. Like DVMRP, PIM-DM is a dense mode multicast protocol

using an SPT model. But unlike DVMRP, PIM-DM does not use the MRT and MFT to determine which interface ports from which to transmit multicast group packets for a given (S,G) combination. Its approach to multicast group packet routing is to blindly transmit multicast packets to all non-pruned interfaces. The overhead of this additional packet duplication is accepted in order for the protocol to operate independently of the IP unicast routing tables and the network topology. Recall that PIM is "protocol independent." This means it is independent of the underlying unicast routing protocol. A better description of this might be that it can interoperate with any underlying unicast routing protocol. Since PIM makes no assumptions about the underlying routing protocol, its reverse path forwarding algorithm is slightly simpler, albeit, slightly less efficient, than the one used in DVMRP. Additionally, no parent/child databases needs to be created. From this, it is valid to conclude that PIM-DM is a good choice for networks in which bandwidth is plentiful, a large percentage of the end-users require multicast traffic, and little or no users require WAN links to reach the multicast sources. [20]

Thus, it appears to be a good fit for NPS as long as multicasting is used only within the internal network. However, it could be a problem in the long run, if multicast is used for distributed learning outside of the NPS network. This protocol is currently being revised by the IETF's Inter-Domain Multicast Routing group and is in Internet draft form. It was due to be endorsed in August of 2003. To find out more about its current status, go to the IETF web site (<http://www.ietf.org>). [20] Now that the

basic function of the IP-Multicasting protocol that are relevant to NPS have been examined, their throughput and reliability need to be considered.

E. IP MULTICAST PROTOCOL COMPARISON

To determine whether or not an IP-Multicast protocol is effective, its timing requirements must be considered. The timing values for a given protocol are a key determining factor of its performance. It is not only critical to the IP-Multicast applications that use it but also to the network hardware that it traverses. Values such as timer size and timeout values, as well as table structure and sizing, are critical in judging a protocols overall performance and how it will integrate into a network. While selecting a particular protocol for use on a network is more complex than the simple tradeoff of speed versus reliability, it must be realized that currently no single multicast protocol meets all multicast requirements. [18]

The data in Table 3 below provides detailed timing information for the IP Multicasting protocols described in this chapter. It is provide in order to further distinguish between the protocols:

Protocol	Message	Timing
SAP/SDP	Announcement	Every 10 seconds
IGMPv1	Membership Query	Every 60 seconds (Query Interval)
	Membership Report	Random countdown from 0 to 10 seconds
	Leave Latency	(3*Query Interval)=180 seconds
IGMPv2	Membership Query	Every 125 seconds (Query Interval)
	Membership Report	Random countdown based on value specified in Membership Query (.1 increments) with default equal to 100 (10 seconds - as in version 1)
	Controller Election Timeout	(2 * Query Interval) = 250 seconds

Protocol	Message	Timing
IGMPv3	Same as for Version 2	Same as for Version 2
DVMRP	Neighbor Discovery Hello	Every 30 seconds
	Neighbor Adjacency Timeout	(3 * Neighbor Discovery Msg.) = 90 seconds (Nortel uses = 140 seconds)
	Multicast Routing Table Update	Every 60 seconds (similar to RIP)
	Route Expiration Timer	200 seconds
	Prune Reset	Every 120 seconds
	DVMRP Routing Table	Source Subnetwork & Subnet Mask, Incoming Interface, Outgoing Interface(s), Metric (Hop Count), TTL, and Status
	DVMRP Forwarding Table	(S,G), TTL, Incoming Interface, Outgoing Interface(s), Prune Status
PIM-DM	PIM Hello Message	30 seconds
	Neighbor Adjacency Timeout	(3.5 * PIM Hello Msg.) = 105 seconds
	PIM Neighbor Table Entry	Neighbor Address, Interface, Uptime, Expiration Timer, Mode (Dense, Sparse), Designated Router ("DR") Flag
	Prune Reset	Every 180 seconds
	Prune Delay Timer	3 seconds
PIM-SM	PIM-SM Forwarding State	Entries deleted every 180 seconds
	(*, G) Join Refresh Messages	Sent upstream every 60 seconds

Table 3. IP-Multicast Protocol Timing [18]

As discussed in the previous two sections, PIM-SM is the most popular IP-Multicast protocol for an enterprise network, with DVMRP a distant second, and PIM-DM an even-further-trailing third. The Multicast Backbone (MBone) is a multicast network set up in the late 1980's that was used primarily for research and educational purposes. It still extends mainly between educational institutions and extensively uses DVMRP. However, the MBone is largely a core Internet infrastructure and most enterprises do not implement it internally. Recently, an exterior Internet routing protocol, BGPv4, was extended to provide inter-Autonomous System multicast routing. It was designated

"MBGP" (Multicast BGP) and could give PIM-SM some competition. This protocol is relatively new and it will not be discussed further in this thesis. If more information is needed on this protocol, please go to the IETF web site (<http://www.ietf.org>). [18]

F. NETWORK HARDWARE AND MULTICAST

The hardware (i.e., the routers and switches) that makes up a network are the core technology of that infrastructure and their ability to handle the requirements placed on them by the communications protocols is critical to the QoS that a network provides. If a central router in a network does not support multicast effectively, then it not only degrades the network's ability to provide multicast support, but could severely degrade traditional network traffic if multicast traffic is introduced into the network.

Based on a poll conducted for reference [18], it was suggested that the number of active IP-Multicast groups, e.g. (S,G) count in DVMRP and (*,G) count in PIM-SM, be a minimum of approximately 256 for an organization. That said, many institutes have a typical active population closer to 2,000. The maximum number of active groups observed during the poll, on one corporate network was nearer to 10,000. It was also noted that military and defense contractors could require an even higher active group count than this. [18]

These statistics provide a very important insight into the importance of network hardware. The maximum number of active multicast groups that a vendor's routers and

switches can handle is critical in a network which intends to heavily utilize multicasting. But determining this maximum number is not a simple task since many protocols, supporting unicast or multicast traffic, share available Random Access Memory (RAM) and Content Addressable Memory (CAM) space. The only thing that is currently clear is that more router memory allows more sessions. The article in reference [18] stated that high-end Cisco and Nortel Networks routers were able to easily manage tens of thousands of simultaneous multicast groups while maintaining their QoS. [18]

In this chapter the pertinent multicast routing protocols used at NPS and the ones used extensively in the Internet environment were examined. This consisted of an appraisal and comparison of their properties and attributes. During this process PIM-DM was found to be the multicast routing protocol primarily used today. Furthermore, their relationship to each other was also reviewed. At this point it should be clear that SAP/SDP, IGMP, and PIM-DM are supposed to be in use at NPS, but whether or not that will hold up during testing will be determined next. The next two chapters detail the tests performed in the laboratory and on the NPS network in support of this thesis. These tests were developed by the author of this thesis in order to determine whether or not the hardware used in the NPS network was capable of supporting multicast traffic without reducing the QoS level provided to all users.

IV. LABORATORY TESTING, DATA ANALYSIS, AND RESULTS

Two categories of tests were performed to quantify the thesis' hypothesis that the NPS network can sustain the uses of multicast with little or no effect on the network current QoS; one in a lab environment and the other over the school's live network. The next two chapters describe the various tests that were performed during the network analysis phase of this thesis. This chapter describes the testing done in the laboratory. It provides the reasoning behind it, how it was done, any problems that were encountered, what data was collected, how the data was analyzed, and the results and conclusions drawn from it.

The test plans used for this chapter are located in Appendix A. It is realized that the information in this thesis will be outdated within the next year, but it is hoped that the test examples in this chapter and the next, along with the test plans in Appendices A and B, will provide future multicast implementers with a workable starting point for their effort. This information is also supplied to promote further exploration in the multicast research area and as a roadmap for anyone implementing multicast on a legacy network. In Sections A and B below, an evaluation of the network analysis applications and multicast software and equipment that were evaluated for inclusion in the test suite is provided. In Sections C and D, the switches and routers used at NPS are evaluated to ensure proper operation on multicast protocols. These sections and subsections provide an overview of the test plan and the motivation behind each test.

Laboratory testing was conducted in order to validate the multicast operation of current NPS network hardware and to evaluate the software to be utilized during testing without putting the live network at risk. These tests provided the author with insight into the operation of the multicast protocols discussed in Chapter III. It also led to a determination of the applications that would be used during the live network tests and to a multicast configuration for the two types of switches used at NPS.

A. EVALUATION OF MULTICAST APPLICATIONS

Prior to performing any tests in the laboratory, much less on the NPS production network, an evaluation of the applications and standalone units being considered for inclusion in the multicast test tool suit was performed. This was done in order to ensure that a standard set of tools was used for every test and to reduce the possibility of catastrophic network failure. The tools listed below were evaluated on cost; ease of installation, configuration, and use; effectiveness; and standard protocol use. This pre-testing of the tools set reduced the possibility of introducing errors into the core NPS network due to a tool behaving in a nonstandard or unexpected manner. The various data capture and analysis tools and multicast server and client applications listed below, were tested and only stable applications with standard implementations were included in the test tool suit. All the applications listed below were evaluated using the test plan in Section A of Appendix A.

1. Ethereal

One of the primary tools any network analyst uses is a network sniffer. A sniffer is made up of a computer with a network connection that is running software capable of capturing network traffic packets. Ethereal is an application that performs this function. It is a free network protocol analyzer for both UNIX and Windows that allows the user to capture and examine network packets from a live network or from a file on disk. Further, it allows interactive browsing of the captured data, and summary and detailed information for each packet. Ethereal also has several powerful features, which include a rich display filter language and the ability to view the reconstructed stream of a TCP session. After evaluating this tool against the criteria in the test plan, it was rated very high for the following reasons; it is a no cost tool that performs all of the functions needed to capture and analyze network traffic; it is easy to install, configure, and use; and it has the ability to open files created by other capture applications. Version 0.9.14 of this application was used throughout all of the tests conducted for this thesis; it was procured from <http://www.ethereal.com>.

2. TEthereal

This tool is a text version of Ethereal. It was considered for use for the same reasons as Ethereal, was accepted for the same reasons, and was used to complement Ethereal. Using the batch job feature of this tool allowed packet captures over a twenty-four hour period in an unsupervised environment and was a great success. This tool

is part of the Ethereal installation, thus it has the same version number and was procured from the same location.

3. EtherPeek

EtherPeek is a commercial tool from WildPacket, Inc., that is much like Ethereal. It was considered for the same reasons as Ethereal and was included in the tool suite due to a small amount of use while using NOC equipment. The primary deterrent to using this tool instead of Ethereal is its high cost. Due to the limited budget for this project, it was not a viable candidate. But as stated before, while testing the NPS network and utilizing NOC equipment, it was used for some minor packet capturing. The saved files were then analyzed using Ethereal. Version 2.0.0 of this application was used while using a NOC laptop; it was loaded on the laptop when borrowed.

4. SolarWinds Professional Plus Edition

This set of network management tools was developed by SolarWinds.net. It was evaluated for use in this project for its ability to monitor the bandwidth usage of every port on multiple hubs, switches, and routers. It uses the Simple Network Management Protocol (SNMP) to interface with the devices and collect data by monitoring both the send and receive traffic of each target port. It is extremely easy to install, configure, and use, and provides extensive network monitoring capability. Further, it provides an easy means to view and graph the data it collects. This tool set was also used throughout the tests documented in Sections C and D, and throughout Chapter V. All of the graphs in the

next chapter were created using it. Unfortunately, this tool is costly which may be a consideration in its adoption in a typical tool suite. The Bandwidth Monitor application, Version 5.0.93, was the primary tool out of the set used during testing. The SolarWinds.net web site (<http://www.solarwinds.net>) contains more information on this tool set.

5. Iperf

This is a free tool, supplied by the National Laboratory for Applied Network Research (NLANR). This tool was designed to measure TCP and UDP bandwidth performance and was considered for inclusion in the multicast test tool suite for this reason. It is easy to install, configure, and use. Furthermore, it can be configured to send UDP traffic to a multicast address and will report bandwidth, delay jitter, and datagram loss. Unfortunately, it does not utilize the required multicast routing protocol, IGMP, so it was not added to the multicast test suite. Without IGMP to configure the routers to properly relay multicast traffic, all switches and routers in the network treat the multicast traffic like broadcasts, sending it to every active interface. Over the core of a network, this could flood the network and could cause severe QoS problems. Version 1.7.0 of this application was tested and it can be downloaded from <http://dast.nlanr.net>. More information on this tool can be found at the Distributed Applications Support Team web site listed above.

6. Multi-Generator Toolset

The Multi-Generator (MGEN) tool set is open source software created by the Naval Research Laboratory (NRL) Protocol Engineering Advanced Networking (PROTEAN) Research Group. It's free and was considered due to its ability to perform IP network performance tests and measurements using UDP/IP traffic. This toolset transmits real-time traffic onto a network in order to simulate loading and it can also receive and log traffic for analysis. As with Iperf, the tool sends a UDP packet stream to a multicast address without the multicast routing protocol, IGMP. So the hubs, switches, and routers were flooded with broadcasted multicast packets. This tool set was not included in the test suite. Version 4.0 of this application was evaluated; it can be downloaded from <http://manimac.itd.nrl.navy.mil>. See the NRL web site for more information on the tool.

7. Mbone Applications

This is a free suite of applications developed at the University College of London by its Networked Multimedia Research Group. It was considered for inclusion in the multicast test suite due to its ability to send various types of data streams to multicast groups. It consists of a Session Directory (SDR) Tool, Robust Audio Tool (RAT), Videoconferencing (VIC) tool, Whiteboard (WBD) tool, and Network Text Edit (NTE) tool. All of these applications put together can provide a total multicast solution for a networked classroom or discussion group. They utilized the standard multicast routing protocol, IGMP. Additionally, the SDR tool uses SAP/SDP messages to relay session

information to other host running SDR or applications that support the SAP/SDP protocol.

Unfortunately, installation and configuration are difficult and would be beyond the average user. Once installed, they are relatively easy to use. Each tool must be downloaded and installed separately. Then modifications to the systems environmental variables need to be performed manually for them to work together. Configuring the multicast address scheme is complex, as each application listed above utilizes a different address for its service (i.e., voice, video, whiteboard, text edit). The final problem is that the output bandwidth was not stable. For example, every pause when using a microphone to input voice caused the data stream bandwidth to fluctuate.

For these reasons, this entire tool suite was not added to the test suite. The SDR tool was included, however, due to its use of SAP/SDP. SDR was used to check for sessions produced by the VBrick and VBrick StreamPump. See the UCL web site at <http://www-mice.cs.ucl.ac.uk/multimedia/software> for more information on these tools.

8. QuickTime Streaming Server

This application was developed by Apple Inc. and was considered due to its ability to stream video and audio via either unicast or multicast. Unfortunately, it only runs on Mac platforms, making cost a determining factor. While installation was simple, configuration and use was very difficult and left much to be desired when compared with the VBrick StreamPump. While QuickTime Streaming Server

implemented IGMP its use is not straightforward. The Streaming Server has to be setup to send a data stream to itself after which an application, called the Broadcaster, sends the stream out to a multicast address. An .sdp file, used by the player to get the data stream, must be generated during session creation. That file has to be manually changed to point to the multicast session and then is either posted to a web page or sent via e-mail to all clients. Finally, the server can only stream media files in the .mp4 format. Since most of the media stored at NPS are in MPEG 1 and 2 formats, another piece of software was required for conversion. It was all very time consuming and convoluted. This application was not added to the test suit and it was not impressive in performance, quality, or ease of use. Version 4.1.3 was evaluated for this effort and it is freely downloadable from the Apple web site. More information on this application can be found at the Apple web site (<http://www.apple.com>).

9. QuickTime Player

This free application was developed by Apple Inc. to play multimedia files and both unicast and multicast data streams. Its ability to view multicast data streams is why this application was considered for inclusion in the test suite. It is easy to install and use, runs on both Mac and Windows platforms, and utilizes IGMP while in a multicast session. But configuring it to view a multicast session is problematic. If the multicast server used does not create a .sdp file it will not work. Additionally, even when the .sdp files were created by the QuickTime Streaming Server, they had to be manually altered before they would point to

the multicast session and not generate a unicast stream, further discussion is beyond the scope of this thesis. For these reasons, this application was not added to the test suite. Version 6.1 of this application was evaluated for this project, it can be freely downloaded from the Apple web site. Additional information regarding this application can be found at the Apple web site (<http://www.apple.com>).

10. VBrick StreamPump

The StreamPump is a product of VBrick Systems and a demonstration version of it is freely available. The tool was easy to install, setup, and use. It was able to stream either MPEG 1 or 2 files. Multiple streams could be transmitted from the same computer, as well. It utilizes both IGMP and SAP/SDP, and works with the existing NPS video library. For all of these reasons, this tool was added to the multicast test suite for this thesis and was used throughout the testing. Version 2.1.0 of this application was evaluated for this project, it can be freely downloaded from the VBrick web site. For more information on this application, go to the VBrick web site (<http://www.vbrick.com>).

11. VBrick StreamPlayer

This application is also a product of VBrick Systems. A demonstration version of it is freely available, as well. It is web based and easy to install, setup, and use. It utilizes both IGMP and SAP/SDP, and works with both the VBrick StreamPump and the VBrick 3200 that the school already owns. This tool was included in the multicast test

suite for this thesis and used throughout the testing. Version 4.1 of this application was evaluated for this project, it can be freely downloaded from the VBrick web site. For more information on this application, go to the VBrick web site (<http://www.vbrick.com>).

B. VBRICK 3200 CONFIGURATION AND TEST

A few years ago, NPS Networks Management office procured a VBrick 3200 to provide a multicast channel to the NPS network. A product of VBrick Systems (<http://www.vbrick.com>), this device is a self-contained video and audio encoder/decoder. It turns the analog signals used in television into a data stream and can transmit the data stream over the host network using either multicast or unicast addressing. Figure 12 is a picture of the unit's front panel. For in-depth information on how it functions or its operation, see the VBrick web site.



Figure 12. VBrick 3200 Encoder/Decoder

To ensure proper operation and to make certain that it would not cause QoS problems on the NPS network, the unit was tested following the test plan in Appendix A. It was determined that the unit's firmware needed to be upgraded to ensure that it was using current multicast routing protocols. The firmware upgrade was also necessary so that the unit could be configured such that it would not cause

broadcast storms on the NPS network. It is worth noting that the VBrick 3200 firmware is password protected, so that in order to upgrade it the password must be known.

The VAdmin Administrator application, from VBrick, allows the system administrator to connect to the VBrick through either a serial or TCP/IP connection. Figures 13 through 18 illustrate the VBrick configuration process.

Figure 13 is the Communications page, which is used to configure connections from a remote computer to the VBrick.

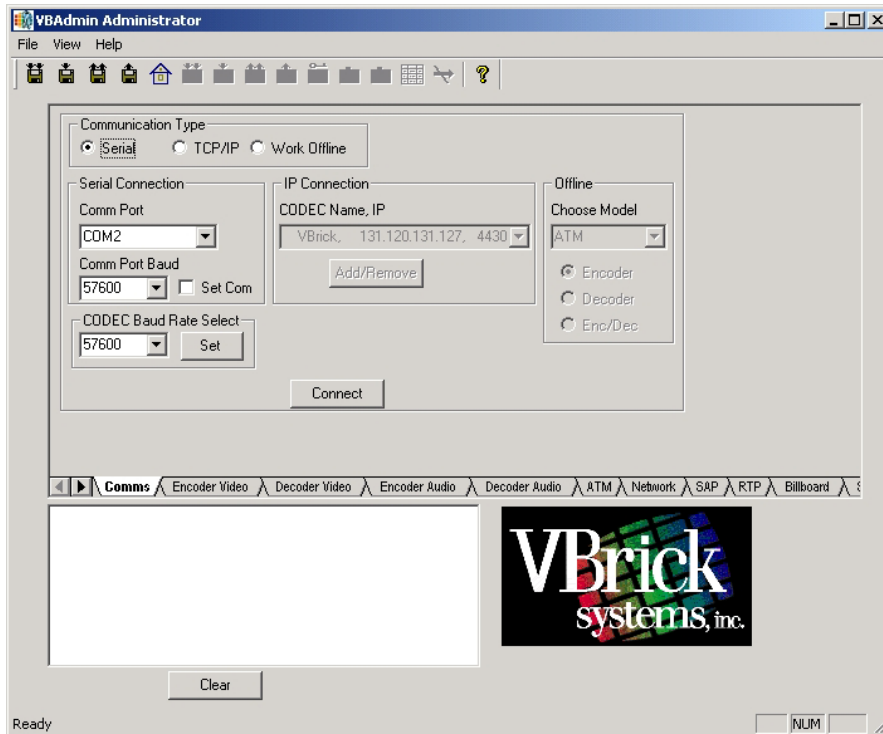

Figure 13. VAdmin Administrator Utility: Comms

Figure 14 is the Encoder Video page where the administrator can configure the encoding used to produce the video stream.

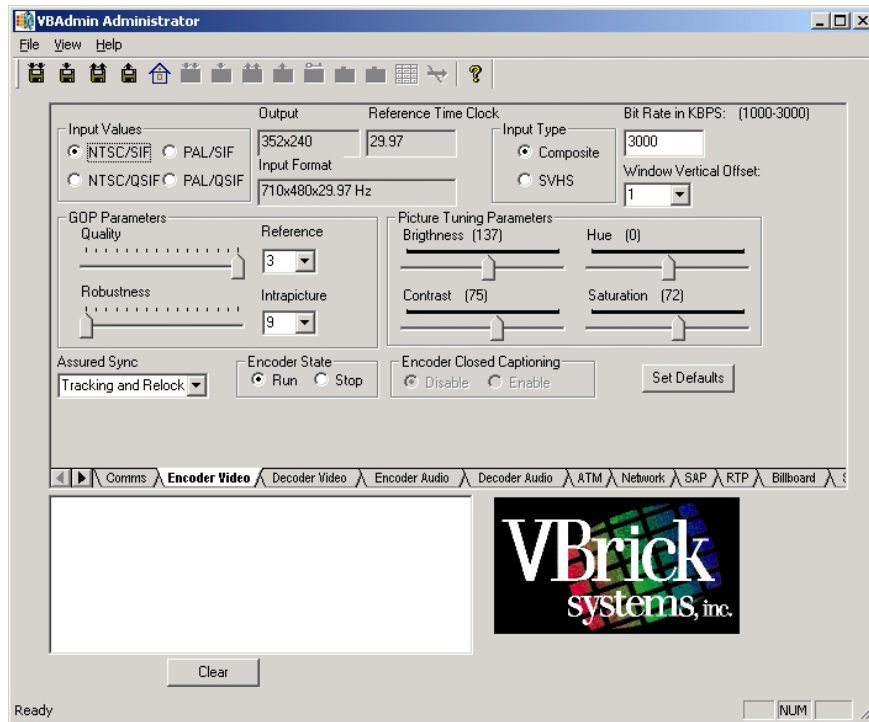

Figure 14. VAdmin Administrator Utility: Encoder Video

Figure 15 is the Encoder Audio Page, through which the administrator configures the audio encoding.

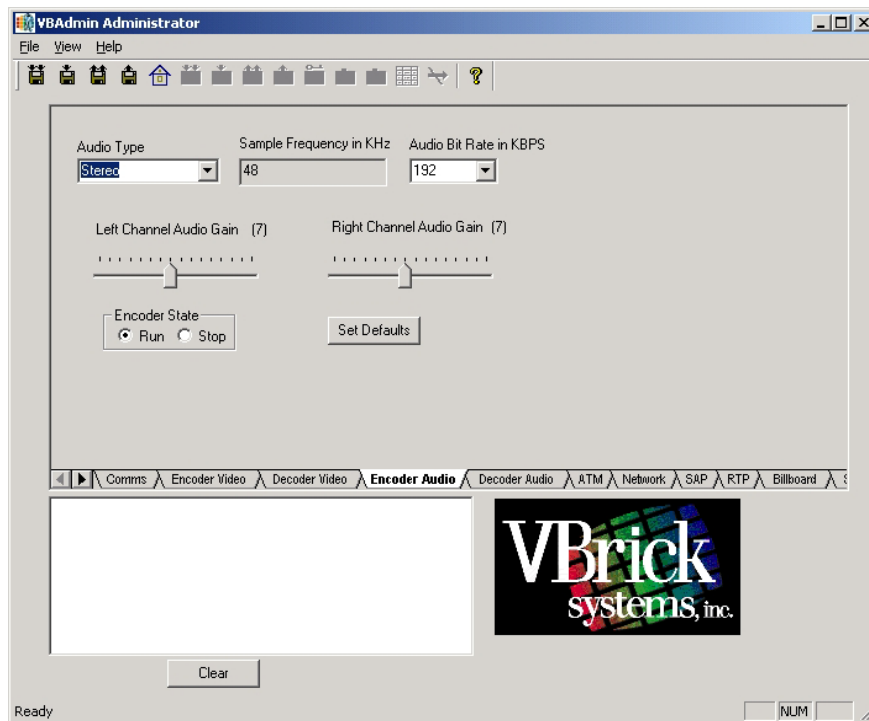

Figure 15. VAdmin Administrator Utility: Encoder Audio

Figure 16 is the Network page where all the network options are configured.

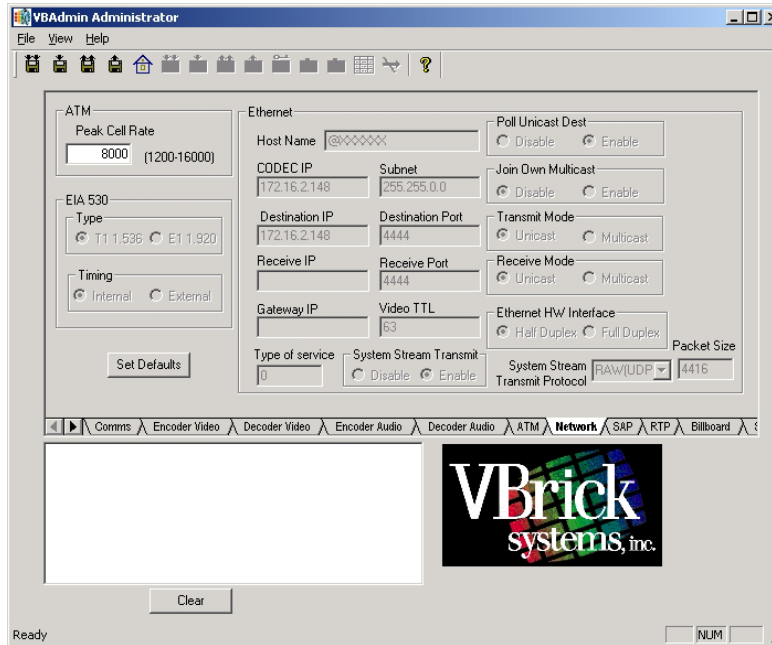

Figure 16. VAdmin Administrator Utility: Network

Figure 17 is the SAP configuration page, which allows the administrator to configure all of the options in the SAP messages that the unit sends out during a session.

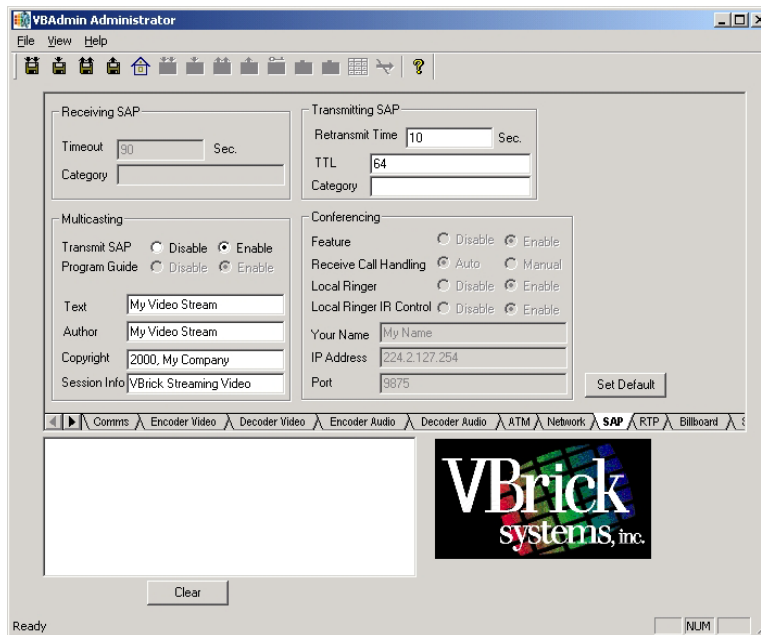

Figure 17. VAdmin Administrator Utility: SAP

Figure 18 is of the Real Time Protocol (RTP) configuration page where the transmission of separate audio and video streams is controlled.

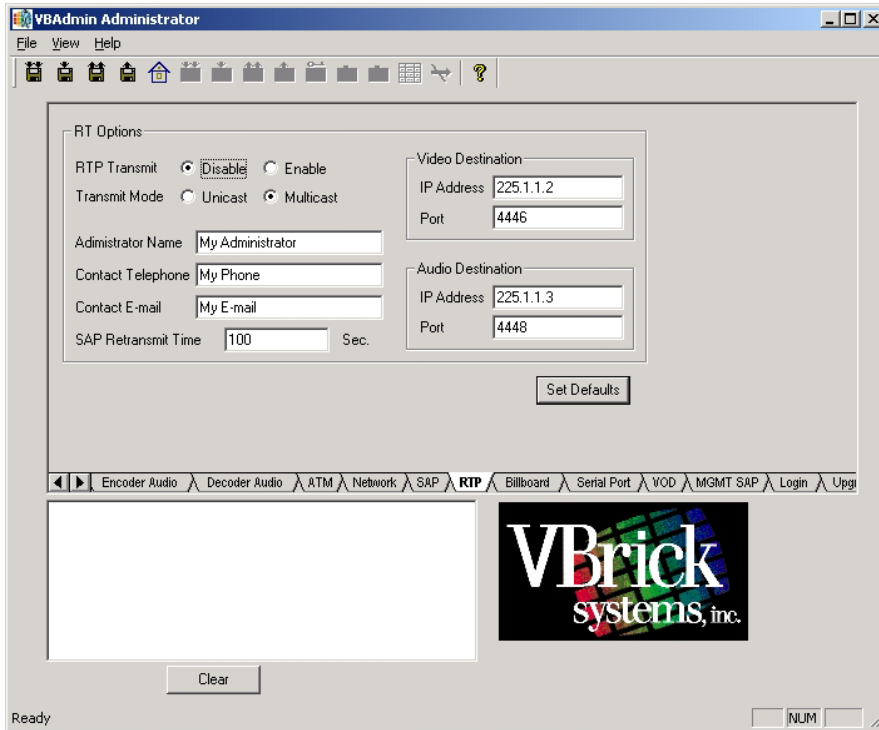

Figure 18. VAdmin Administrator Utility: RTP

All the options, and more, on these pages were modified and tested using Ethereal and SolarWinds to ensure that the most efficient and standard data stream possible was produced. During this process several problems were discovered and corrected. The unit went from utilizing 3.5 Mbps of bandwidth at the start of the test to only 1.8 Mbps at the end. The primary cause was the RTP configuration. The RTP transmit was enabled causing the unit to send out 3 simultaneous multicast streams; an audio/video composite stream, an audio stream, and a video stream. The composite stream was all that was used by the VBrick Player application so the other two streams were superfluous. Other problems that were corrected include the gateway IP

address configuration and a time-to-live (TTL) of 63 hops. The unit did not have a gateway IP address assigned, so it would not perform normally on the network. A TTL of 63 hops allowed packets to cycle around the network if a routing loop was encountered. The maximum hops for the NPS network should not be more than 4 so the TTL field on the VBrick was set to 4. Once configured and tested, the VBrick was used in every follow-on test.

C. SWITCH CONFIGURATION AND TEST

One of the primary limiting factors in a network is bandwidth. Server response time is an indicator for network performance. If multiple multicast channels are active on a network and the edge switches are not configured correctly, thereby broadcasting every multicast packet to network ports, then network performance could be severely affected as throughput is adversely impacted. So, correct switch configuration is essential to any network providing multicast. The subsections below provide a description of the steps taken to ensure proper configuration of the switches used at NPS.

1. 3COM Super Stack II 3300

This subsection is a brief overview of the execution of the test plan in Appendix A Section B with regard to the 3COM switches hosted at NPS. These switches were part of the previous NPS network equipment suite. They have a reputation at NPS of not being able to support multicast routing. The test plan was designed in order to make a definitive determination as to whether or not a properly

configured switch, implementing IGMP snooping, has the ability to support multicast routing. The test plan provides a good point of departure for testing other switches.

Figure 19 is a diagram of the lab network configuration supporting this test. Since the actual IP addresses of network components is considered sensitive information, so .A will be used instead of the actual subnet address. This labeling scheme is used throughout the rest of this chapter and in Appendix A.

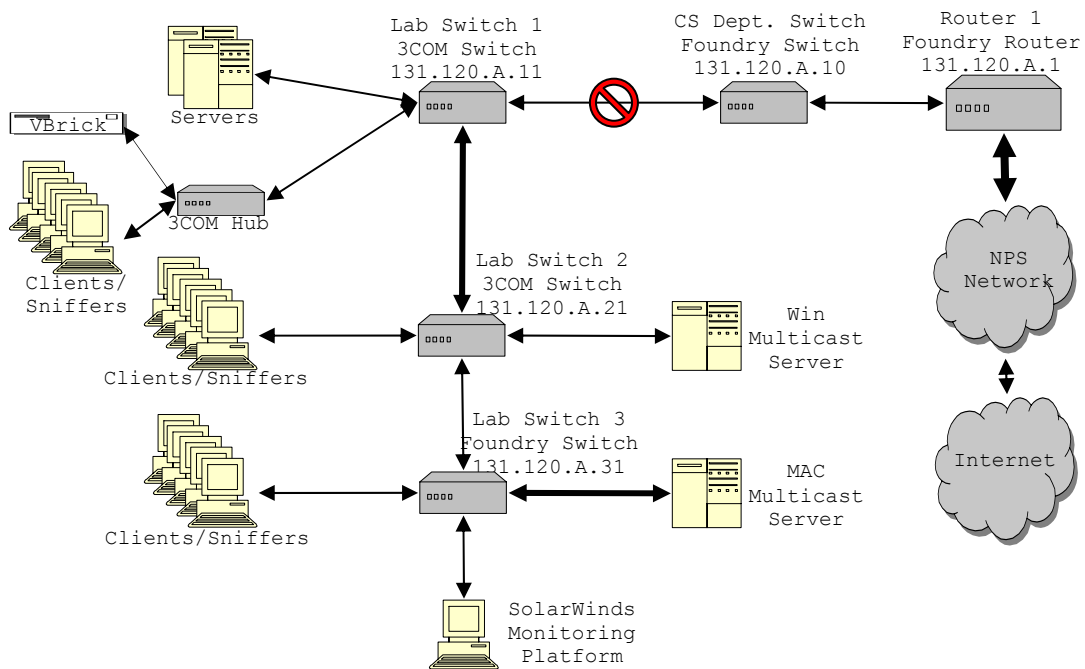

Figure 19. Network Diagram of Initial Lab Configuration

As can be seen from the diagram, Lab Switches 1 and 2 are both 3COM devices. Lab Switch 1 was the entry/exit point for the laboratory network onto the NPS network, so this external connection was disabled during the test. Again, this test was used to determine if the 3COM switches, Lab Switches 1 and 2, could be configured in such a way as to perform IGMP snooping correctly.

Prior to starting the test, SolarWinds was configured to connect to each switch, using SNMP. During the entire test, the bandwidth of each active port was monitored. The initial configuration of each switch was documented. Note that no multicast clients were established during initial testing. Then the switches were upgraded to the most current firmware versions available and all configuration options set back to factory default. Multicast traffic was then injected into the lab network by the VBrick. Each port was monitored, using SolarWinds, to see if bandwidth usage increased. The "interface active" LED indicators on the switches were observed to see if inordinate activity was occurring. Ethereal was used to see if multicast packets could be captured. All the data from these three checks was documented.

Following this, a client attached to the switch was connected to the multicast group and the three checks were repeated. After each series of checks the multicast session was closed and the configurations of the 3COM switches modified. This process continued until every possible option combination, both multicast and non-multicast, had been tested.

IGMP Snooping was performed over the gigabit connection linking Lab Switches 1 and 2. This link is indicated by the thick double arrowhead line. The gigabit connection was found to function with IGMP Snooping, just like the other interfaces.

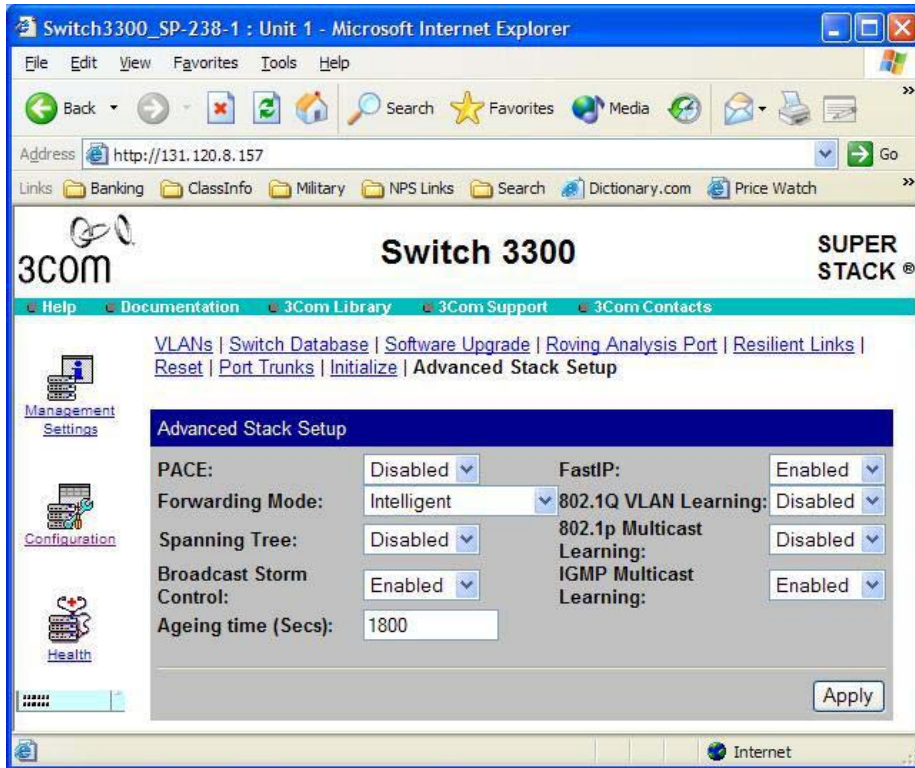

Figure 20. 12 Port 3COM Switch Multicast Configuration

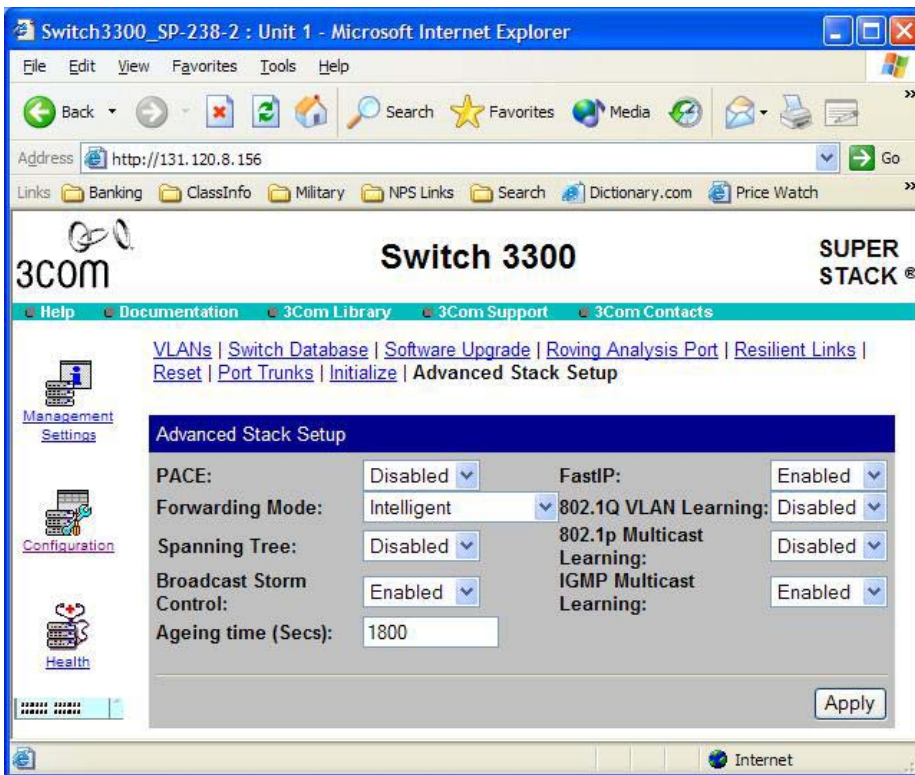

Figure 21. 24 Port 3COM Switch Multicast Configuration

Figures 20 and 21 above show the web interfaces for the 3COM switches used at NPS. The FastIP option has to be enabled on both switches so that the gigabit link will work properly and translate from gigabit speed to the 100 Mbps interfaces. The IEEE 802.1p Multicast Learning options enable the Generic Attribute Registration protocol (GARP) and GARP Multicast Registration Protocol (GMRP) to allow registration of end-stations with multicast groups. GMRP is protocol-independent, which means that it can be used on all LANs and VLANs that contain network devices and end-stations which conform to IEEE 802.1p. This type of multicast is not currently part of the NPS network and is thus not enabled. The IGMP Multicast Learning option enables IGMP Snooping to register end-stations with multicast groups through IP-supporting network devices. It should be used on all LANs and VLANs that contain an IP router and other network devices that support IP. This is the configuration of the NPS network, so the IGMP Multicast Learning option is enabled. [21]

The test determined that the configurations shown in Figures 20 and 21 functioned best for multicast on the NPS network. During testing a significant discovery occurred. It was found that the 3COM switches did work with multicast, but have a nonstandard implementation of IGMP Snooping. As was stated before, a switch utilizing IGMP Snooping should not relay multicast traffic to a port unless a client connected to the port is sending IGMP messages for a multicast group. In this case, the 3COM switches were broadcasting the multicast traffic to every port until a client joined the session and began sending IGMP messages. At that point the switch's IGMP Snooping

kicks in and the multicast traffic is sent to the client's port but not to non-participating ports. When the client leaves the group the switch resumes sending the multicast traffic to every port.

2. Foundry FastIron Edge 4802

The test plan in Appendix A Section B was executed to determine if one of the Foundry switches, replacing 3Com switches on the NPS network, if properly configured, could support multicast routing and IGMP Snooping. This switch is relatively new at NPS and its support of multicast had not been stress tested due to the very low volume of multicast traffic on the network.

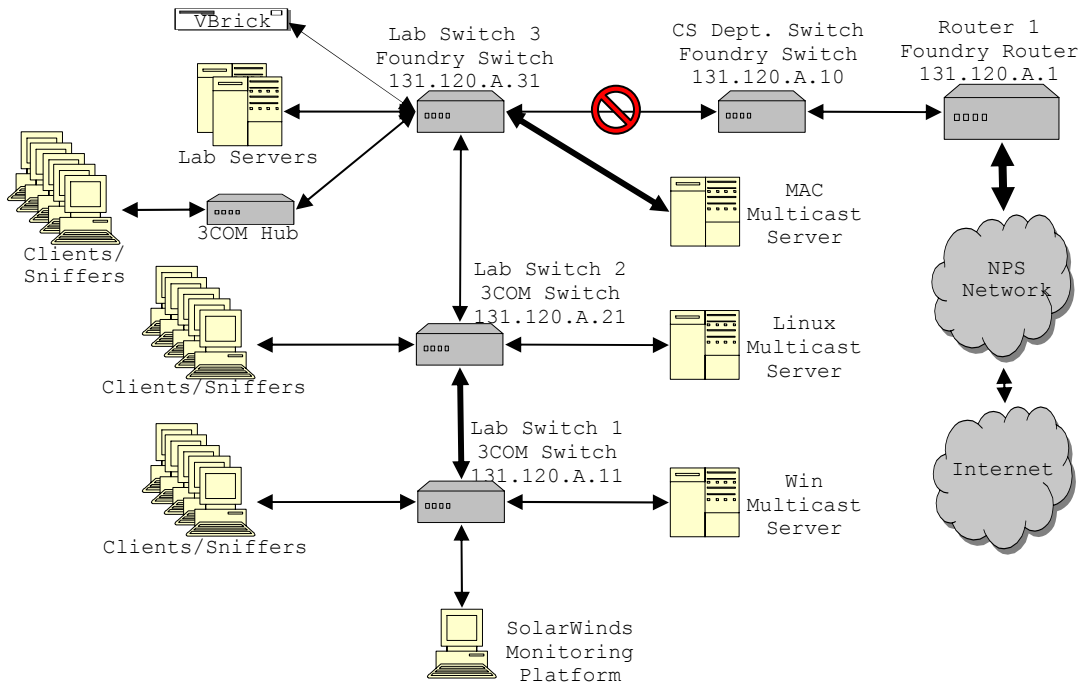

Figure 22. Network Diagram of Final Lab Configuration

Figure 22 is a diagram of the lab network configuration as it was for this test. Note that the positions of Lab Switches 1 and 3 have been reversed. Lab

Switch 3 is now the entry/exit point for the laboratory network to the NPS network, so this external connection was disabled during the test. An additional test objective was to determine whether or not the Foundry switch's IGMP Snooping would prevent downstream, non-IGMP enabled switches from being flooded.

Prior to starting the test, SolarWinds is configured to connect to each switch, using SNMP. The bandwidth of usage of each port was monitored throughout the test. As with the 3COM switches, the Foundry switch's original configuration was recorded and the switch was upgraded to the most current firmware versions available with all configuration options set back to the factory defaults. Multicast traffic was then injected into the lab network using the VBrick box. SolarWinds was used to monitor whether any port's bandwidth utilization increased after the multicast traffic was injected. The "interface active" LED indicators on the switch were observed to see if any inordinate activity was occurring. Ethereal was used to determine if multicast traffic could be captured. The data from these three checks was logged. A client attached to the switch was then connected to the multicast group and the three checks were repeated. The configuration of the Foundry switch was then modified and the process continued until every possible option combination had been tested, including both multicast and non-multicast options.

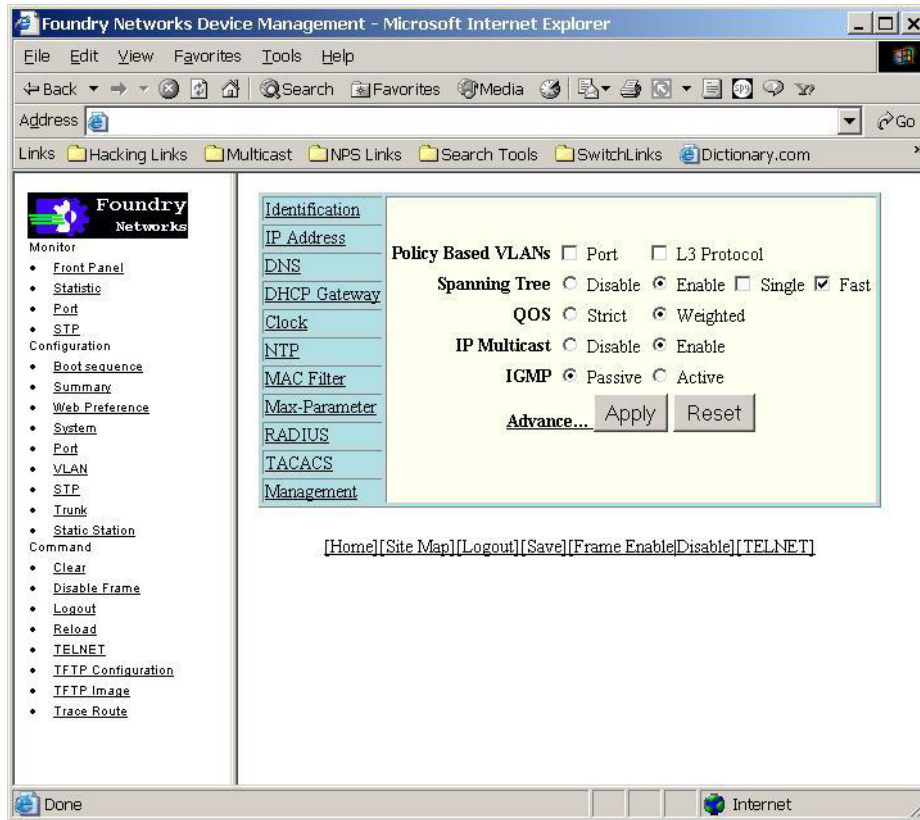

Figure 23. 48 Port Foundry Switch Multicast Configuration

Figure 23 above, is an example of the web-based configuration interface used for the Foundry switches at NPS. The IP Multicast option enables the switch's multicast traffic reduction capability. The IGMP option enables either active or passive IGMP Snooping to register end-stations, associated with multicast groups, with IP-supporting network devices. The active mode allows the switch to actively seek multicast groups to add to its (S,G) table. Necessary additions are identified by sending out IGMP messages. This operation mode should not be used in networks with routers, as they perform this function. The passive mode is used in networks with routers. In this case, the switch actively listens for multicast groups to

add to its (S,G) table but will not send any IGMP messages. The passive mode is the appropriate configuration for the NPS network. [22]

The test revealed that the configuration shown in Figure 23 functioned best for multicast on the NPS network. It was observed that the switch worked correctly with multicast and has a standard implementation of IGMP Snooping. During this test, Lab Switches 1 and 2 were monitored to see if an inordinate amount of traffic was observed on their ports, as none of their clients were members of a group. The Foundry switch protected the 3COM switches from the multicast traffic, eliminating the broadcasting of multicast traffic when no clients were multicast group members.

D. ROUTER IGMP TEST

The Foundry router is a primary component of the NPS network and proper operation in terms of multicast is essential if multicast routing is to be exploited on the network. For this reason, the router's ability to support multicast and IGMP required verification. Since a Foundry router could not be spared from the operational network, a short duration test on the operational computer science edge router was performed with minimal risk to the NPS network. The router configuration could not be altered while it was active, so it was tested using the configuration shown in Figure 24. A multicast server (VBrick), multicast client (VBrick Player), and sniffer (laptop with Ethereal) were each connected to a different port on the router. Then packet capture was initiated on

the sniffer. Shortly thereafter, a multicast data stream was inserted by the server.

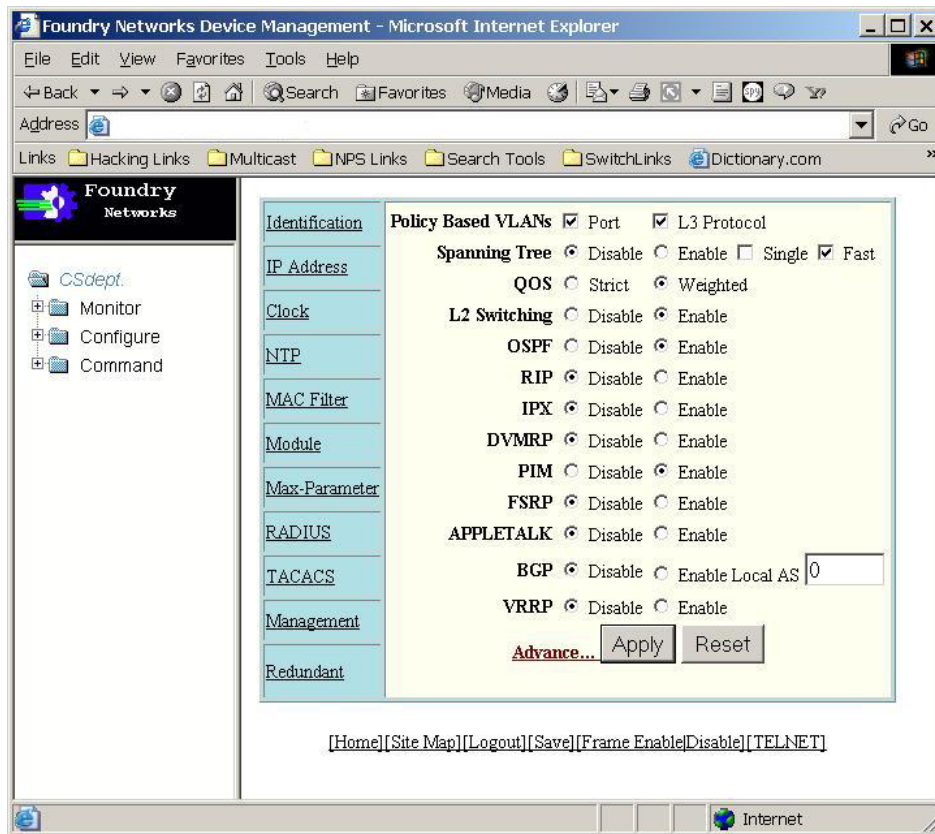

Figure 24. Foundry Router Multicast Configuration

It was possible to view the session by the client across the router's interfaces. The file captured by the sniffer was reviewed to see if multicast traffic had penetrated pruned branches, i.e., interfaces that had no group clients. This review revealed that the multicast data stream had not been forwarded to the pruned branches. Based on these observations, it was determined that the Foundry router correctly implemented IGMP.

This chapter provided a description of the tests performed within a laboratory environment to evaluate both 3Com switches and Foundry switch and router implementations

of IGMP Snooping. The tests demonstrated the worthiness of these network devices to limit default broadcasting of multicast traffic. Chapter V will provide a similar account of the testing performed on the NPS production network.

THIS PAGE INTENTIONALLY LEFT BLANK

V. NETWORK TESTING, DATA ANALYSIS, AND RESULTS

This chapter provides the rationale behind and an in-depth description of each of the three tests performed on the NPS production network. It also describes how data was collected, provides an analysis of that data, and presents the findings based on that analysis. The tests were performed on the operational NPS network and thus profuse precautions were taken to reduce the possibility of network failure. Each test was conducted to examine different factors regarding multicasting on the NPS network. It is believed that the test plans provided in Appendix B will be useful for pre-implementation testing of legacy networks where employment of multicast functionality is being considered. The information in this chapter will help to better explain how the test plans were implemented on the NPS network.

A. PROCEDURE FOR NETWORK DATA ANALYSIS

Analyzing the data collected during network testing quickly became a critical problem due to its huge quantity. During the Initial Test, approximately 2.33 GB of data was captured by six sniffers. In the Clarification/Load Test, about 2.29 GB of data was collected by one sniffer. In the final 24-hour test, over 5.05 GB of data was collected. On top of this, SolarWinds collected bandwidth usage data on every port of every hub, switch, and router directly involved in the test. In fact, SolarWinds was used to gather data on bandwidth utilization across the network throughout the test period, to ensure that a representative

collection was obtained during each test. As noted, the data gathered during these tests by the sniffers and SolarWinds was enormous. Thus, doing a complete, thorough analysis of the data could take years. So the following techniques and criteria were established to allow analysis of the data in the given timeframe.

1. Packet Capture Analysis

To analyze the enormous amount of data captured by the sniffers it was necessary to setup a specific procedure to analyze each file and the data as a whole. To begin with, each file was given a cursory examination to see what multicast protocols and data streams were present on the respective network segment. Any anomalous information in the capture files was then noted. Then the capture data files were merged using *mergecap*, an application that accompanied the Ethereal installation. This program can be used to combine two saved capture files, merging their packets in chronological order based on timestamp, into a single output file. Using this program, the multiple capture files from each test were combined into a single file for that test. From these huge files, the multicast data streams were then extracted and saved to another file. Then the multicast routing packets were extracted and saved to yet another file. Finally, everything that is not multicast related was saved to a separate file. These three files were then compared in order to evaluate the effect that a multicast load placed on a network. Since one of the main focuses of this thesis is to determine if the NPS network can support multicast, this load comparison is critical to the findings of this thesis.

2. SolarWinds Data Analysis

Since this application provides for data collection, analysis, and display, no procedure was required for the data it collected. But, since this application collects bandwidth usage data for every active port on every network component it monitors, this data must be limited to only relevant ports during test timeframes. Charts of this information will be used throughout this chapter. They should provide the reader with insight into each test's findings.

B. INITIAL TEST

This test's primary goal was to determine if the NPS network could support multicast traffic across its core backbone without causing the typical network traffic to experience QoS problems. Other goals for this test were to verify that no multicast loop in the network existed, PIM-DM worked correctly across the backbone, and subnets without PIM-DM enabled did not become flooded with multicast traffic. It was conducted between 1330 and 1430 on June 30, 2003. The test plan used for this initial test is in Section A of Appendix B.

1. Test Description

Figure 20 is the network diagram used during this test. It shows the applicable network components and their relationship to each other. As a reminder, the actual IP addresses of network components is considered sensitive information, so .A, .B, and .C will be used instead of the

real subnet addresses. This will be used throughout the rest of this chapter and in Appendix B.

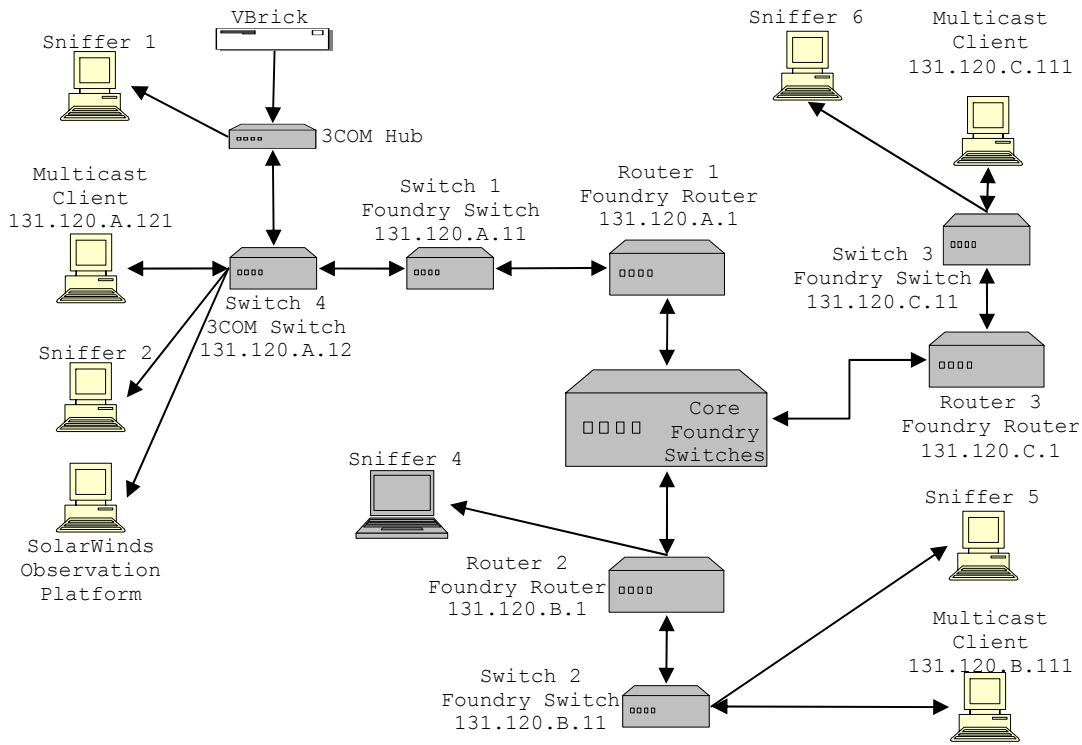

Figure 25. Network Diagram for the Initial Test

As can be seen from this diagram, sniffers were strategically placed around the network. While both subnets .A and .B were PIM-DM enabled, subnet .C was not. The multicast session was transmitted from subnet .A and there were session clients in each subnet. The clients in subnets .A and .B were expected to receive the session and the client on subnet .C was not.

All the preparatory steps listed in subsection 6a of the test plan in Section A of Appendix A were performed. This included setting up the VBrick and Video Cassette Recorder (VCR), loading the VBrick StreamPlayer on the client systems, and connecting the sniffer hardware to the network. But, to connect Sniffer 4 (the core sniffer), it

was necessary to setup a port on Router 2 to mirror all traffic from and to the core switches. Once the mirrored port was setup, the core sniffer was connected and configured to collect packets. After testing the core sniffer, it was determined that the sheer volume of data collected during a capture of an hour of the full core data stream might be too large to effectively analyze. So, the volume was reduced by adding a multicast filter in Ethereal. The filter string used was "ether[0] & 1 != 0". This reduced the packets collected to only those that were multicast in nature.

Next the test began packet capture by all sniffers. A multicast data stream was then injected into the network. This was done with the VBrick, which converted the signal from the VCR into UDP packets for injection into the network. For the first ten minutes following initial stream insertion, no clients were allowed to attempt connection to the multicast session. This portion of the sniffer capture provided a client-free multicast traffic pattern of the NPS network.

Ten minutes into the test the client computers attempted to connect to the multicast session using the VBrick StreamPlayer application. The .A subnet client could both see and join the session, while the client on the .B subnet was unable to see the session but could join it manually, and the .c subnet client could not see the session and attempts to connect manually failed. Thus, at this point it appears that the Foundry routers implement PIM-DM correctly; forwarding multicast packets to enabled routers and blocking them to disabled ones.

During the entire test NOC personnel monitored the network to ensure that its QoS did not degrade. This included monitoring the CPU usage of the .A, .B, and .C routers. All three routers maintained an average of four percent CPU usage throughout the test with dips to two percent and spikes to as much as six percent. The NOC does not currently maintain this data for any length of time but according to NOC personnel this average is normal for that time of day. No abnormally high readings were observed during the test and the system appeared to handle the multicast load without a problem.

After the hour ended, the VBrick StreamPlayers closed out the multicast session and the data stream from the VBrick was terminated. Packet capture by the sniffers was ended and the data files were saved using the format "*'NetData'-Date-Time-IPAddress.eth.*" The italicized words in the file names were replaced with the IP-address of the capture system and the date and time at which the test ended. The data in these capture files and the data gathered by SolarWinds, along with the observations made during the test are analyzed in Subsection 3 below.

2. Problems Encountered

This subsection describes the problems encountered before, during, and after the initial test. This information was integrated into the test plan where possible to enhance the revised test plan for follow-on tests. Appendix B contains both plan versions.

In the initial rough draft of the test plan, the multicast data stream from the VBrick was to come from a

fourth subnet. This subnet could not be used because its router did not have PIM enabled, and to enable it the router would have to be reinitialized. This could not be done on the operational network during the work day due to its adverse affects on non test traffic. To alleviate this problem, the VBrick was reconfigured to operate on the .A subnet and moved to that subnet. Thus, the network diagram above shows the final network configuration for the test.

The next problem encountered was connecting the core sniffer to the core. Initially, the sniffer was to be attached directly to the core, to capture packets directly from it. This proved to be impossible because the sniffer's network card was a standard Ethernet connection and only able to operate at 100 Mbps while the core switch operates at up to 8 Gbps. To overcome this, the core trunk into the .B subnet was mirrored to a 100 Mbps port on that subnet. The core sniffer was attached to this port and worked appropriately.

Another problem was locating a client on the .B subnet. A standard wired client could not be located in the timeframe required for this test so a laptop using a wireless connection was used. This wireless connection to the .B LAN is thought to be the reason behind this client not being able to see the session on the VBrick StreamPlayer (the SAP/SDP messages were not forwarded over the wireless connection). A manual connection was made but it was intermittent and very unreliable. Further research into this area is beyond the scope of this thesis.

The core switches are the nucleus of the NPS network and NOC personnel guard them accordingly. Until the initial

multicast test was proven to be harmless and the author trustworthy, the monitoring SNMP string and IP addresses was not provided. Thus, the Core Switches could not be connected to SolarWinds for monitoring. In both follow-on tests, the core was monitored by SolarWinds.

The final problem encountered during the Initial Test was an application error on the sniffer connected to the .B subnet. For some reason, the save operation in Ethereal failed while saving the capture file to disk. It is unknown exactly why the save failed but it is thought that limited hard-drive space on the system was the cause. This problem could not be mitigated but the core capture showed that multicast had been forwarded to this router.

3. Data Analysis

As was stated before, roughly 2.33 GB of data was captured during this test. Analysis of the individual capture files revealed some very interesting things. The capture file from the sniffer attached to the hub with the VBrick had some unexpected information in it. Since this test was performed before the VBrick was configured as described in the previous chapter, three multicast data streams were observed; the first was a video stream, the next was an audio stream, and the final one was a combined audio/video stream. All of these streams were accompanied by their IGMP and SAP/SDP routing messages. The VBrick was sending out IGMP messages approximately every 60 seconds and SAP/SDP messages about every 10 seconds. Further examination of the captured packets showed that every one generated by the VBrick had a TTL field value of 63. PIM-DM

hello messages from the .A router were also found in this capture. This capture file accounted for the majority of the data captured during this test.

The capture file from the client/sniffer attached to the 3COM switch on the .A segment only contained packets from the VBrick's combined stream. Examination of this capture file show that the client was also sending out IGMP messages approximately every 60 seconds and SAP/SDP messages were received about every 10 seconds. PIM-DM hello messages from the .A router were also captured here.

The core sniffer's capture file was relatively small due to the use of the multicast filter, described above, and the problems encountered with the .B subnet client. None-the-less, some interesting discoveries were made. The three multicast streams generated by the un-configured VBrick were present. These streams were periodically broadcast to the entire core network, as is done in PIM-DM routing when no clients are present. PIM, DVMRP, IGMP, and SAP/SDP routing messages were all present. The IGMP and DVMRP messages were not expected and accounted for the majority of the captured routing packets. This is irregular, since PIM-DM is the routing protocol used for router-to-router routing on the NPS network. Interestingly, the captured SAP/SDP messages were not for the test sessions. These messages appear to have come from the Modeling, Virtual Environments and Simulation (MOVES) Institute subnet. It is speculated that the absence of the test stream's SAP/SDP message was due to the configuration of the VBrick.

There was no capture from the .B subnet due to an application error. The .C network segment collection did have captured multicast packets in it, but they were all from within that subnet. No multicast packets from outside the .C subnet were present in the capture file.

The following diagrams were generated by SolarWinds using the data it collected during this test. Figure 26 is a graph of the bandwidth usage across the port on Switch 4, which was connected to the hub to which the VBrick was attached during the test. It shows that both the incoming and outgoing bandwidth across this port was very low until 13:30 when the test started. At that point, both send and receive traffic jumped to about 3.5 Mbps and remained there for the duration of the test. The received traffic reflects how IGMP Snooping works in that the switch is sending the data back to this port because of the IGMP messages being sent by the VBrick.

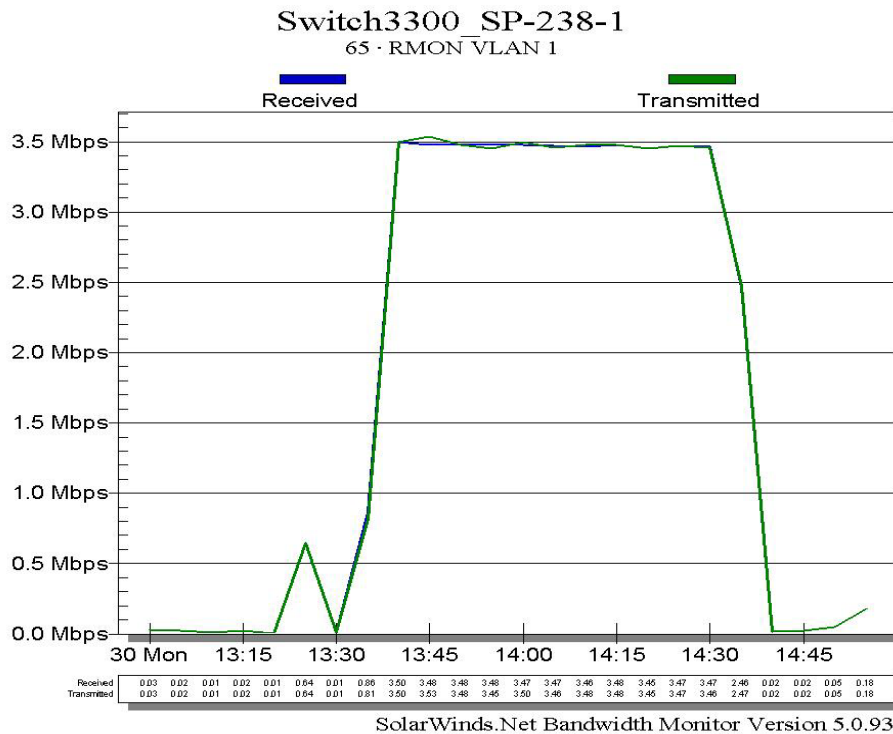

Figure 26. Switch 4 Initial Test Bandwidth Usage Chart

Figure 27 is a chart of the bandwidth usage on the router port for the laboratory connection. As you can see, this connection is only receiving the data stream. IGMP limits the return traffic as this is the stream's source.

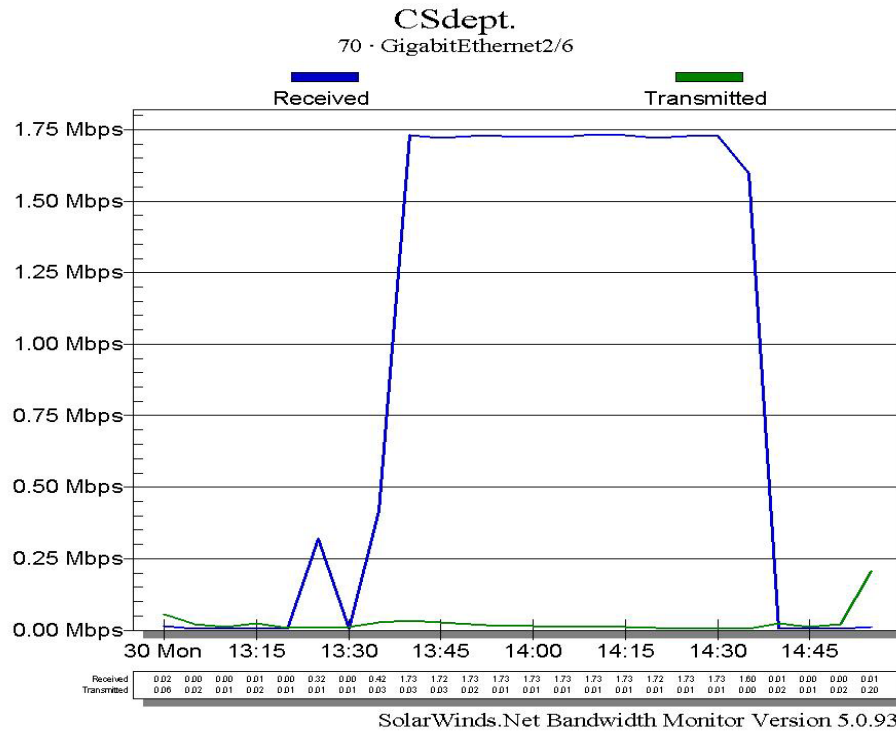

Figure 27. Router 1 Initial Test Bandwidth Usage Chart

4. Test Results

The results of this test can be broken into two categories; equipment configuration and findings. This test revealed several configuration problems with the equipment used for the test.

a. Equipment Configuration

This subsection contains the results of the configuration errors discovered during the test. By examining the data capture file from Sniffer 1 it was

determined that the VBrick was generating three multicast streams when it was only supposed to be generating the one combined data stream. So, the VBrick needed to be reconfigured.

The final configuration problem had to do with SolarWinds. In order for this application to provide a clearer picture of the bandwidth usage during the next test, SolarWinds had to be connected to all affected network components, including the core switches. Thus, SolarWinds needed to be connected into more of the network's switches and routers to increase its network coverage.

b. Findings

This subsection contains the finding from the test that relate to the NPS Network. Review of the TTL fields in the captured multicast packets from the core capture file showed that they were only decremented once as the packet traversed the .A router. This implies that there is **no** multicast loop in the NPS core network.

Next, the CPU usage rate on Router 1, Router 2, and Router 3, monitored by NOC personnel, showed no noticeable change from pretest levels. They maintained an average utilization level of four percent before, during, and after the test. This indicates that the introduced multicast streams had **no** noticeable impact on the NPS network's QoS level.

As for the network components, IGMP on the 131.120.A.1 Foundry router worked in accordance with IETF standards, as expected. IGMP Snooping on the Foundry

switches worked in accordance with IETF standards, as well. Finally, IGMP Snooping did not function as expected on the 3COM switches, as was also observed in the laboratory tests.

The multicast session generated on the 131.120.A.1 segment was visible, across the network backbone, at the multicast enabled 131.120.B.1 router but not on the multicast disabled 131.120.C.1 router. This indicates that PIM-DM functioned as per the IETF standards described in Chapter III. Subnets that were not PIM-DM enabled did not receive the multicast stream or the SAP/SDP messages. Further more, clients on these subnets were not able to force the router to forward these streams by joining them manually.

C. CLARIFICATION/LOAD TEST

The primary goal of the Clarification/Load Test was to clarify the results of the initial multicast test and determine the impact of multiple multicast streams on the NPS network's supported QoS level. The additional goal of this test was to ascertain if SAP/SDP packets could be used across the NPS network backbone. This test utilized the refined test plan located in Section B of Appendix B. It was conducted between 0530 and 1130 on July 18, 2003 with 0930 and 1030 as the actual test timeframe. The actual test procedure was as follows: 4 hours for section 5a (test preparation), 1 hour for section 5b (testing), and 1 hour for section 5c (test wrap-up).

1. Test Description

This test was accomplished by inserting seven data streams, totaling approximately 8 Mbps, into the network. This was done while monitoring the network traffic, using SolarWinds and the core sniffer, and monitoring the routers' CPU usage manually.

Figure 28 diagrams the test configuration. It shows the relevant network components and their relationship to each other.

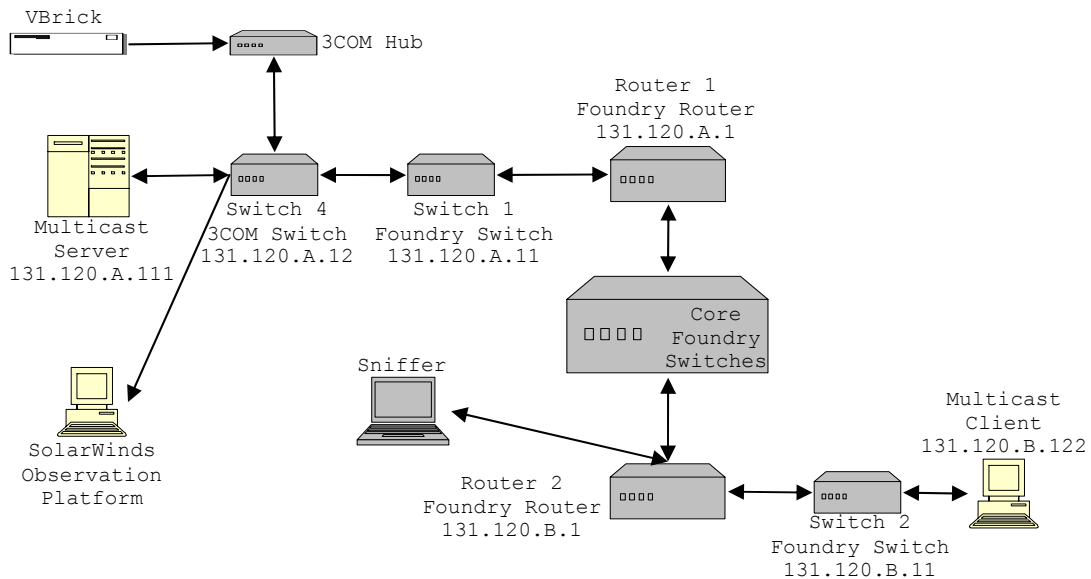

Figure 28. Network Diagram for the Clarification Test

As can be seen from this diagram, only the core sniffer was used for this test. Both routers on subnet .A and .B were PIM-DM enabled. Subnets that are not PIM-DM enabled were not included in this test based on the findings of the Initial Test. All multicast sessions were transmitted from subnet .A with the only pertinent session client on the .B subnet. Using the VBrick StreamPlayer, the client was expected to receive the session if entered manually, but it was unsure whether the SAP/SDP messages

could cross the network backbone to display the session information on the player.

All the preparatory steps listed in subsection 5a of the test plan were performed. These included setting up the VBrick and Video Cassette Recorder (VCR), as well as, loading the VBrick StreamPlayer on the client system. It was again necessary to setup a port on Router 2 to mirror all traffic from the router's core connection. Once the mirrored port was setup, the core sniffer was connected and configured to collect packets. To test the core sniffer and provide a data point for multicast free network traffic, a ten second capture of all the traffic on this core switch was collected and saved to file. From the sheer volume of data collected during this short period it was again determined that an hour capture of the full core traffic would be too large to effectively analyze and could potentially overload the sniffer when multiple multicast streams were introduced. So, to reduce the volume, the same multicast filter used in Ethereal during the Initial Test was used for this test. Here, again, it reduced the packets collected to only those that were multicast in nature.

Once data capture was activated on the sniffer, the multicast data stream from the VBrick was injected into the network. This done, the VBrick StreamPlayer application on the client was accessed to see if the session was visible and could be joined. It was visible and the client was able to join the session. For the first five minutes, the stream from the VBrick functioned alone, at that point a second stream was added using the VBrick StreamPump loaded on a Windows 2000 server. At the client, this stream was also

viewable and available, and changing between the two sessions was much like changing the channel on a television. Five minutes after the second stream was started, a third stream was initialized with the VBrick StreamPump. Again, this stream was viewable and joinable from the .B subnet client. The addition of streams continued until seven test streams were active on the NPS network. All of them were visible and viable to the client on the .B network segment. Figure 29 depicts a VBrick StreamPlayer with the sessions available. For the next thirty minutes, the client was used to switch between the sessions, ensuring that they remained both visible and viable.

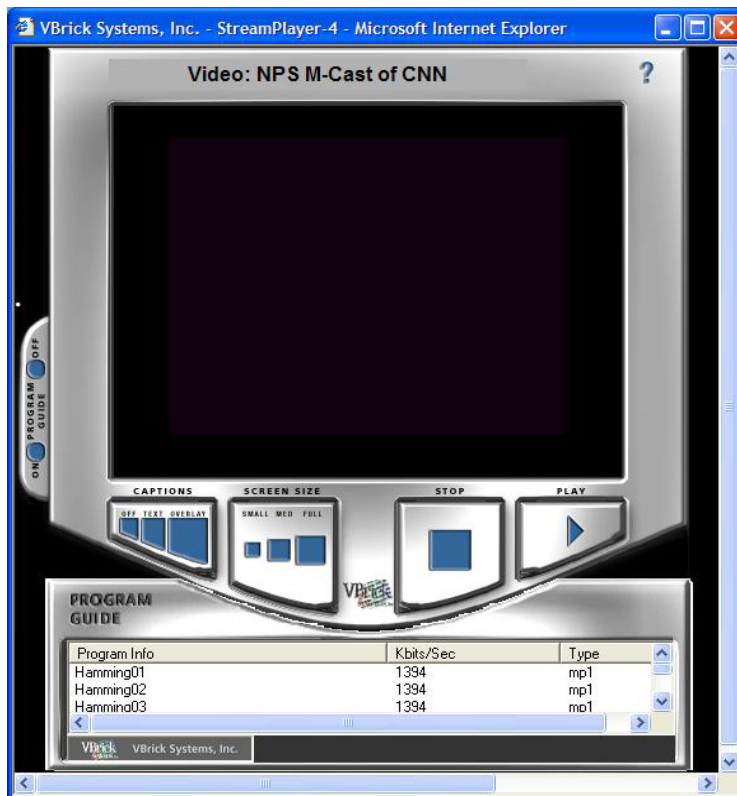

Figure 29. VBrick StreamPlayer Used in Network Tests

During the entire test NOC personnel monitored the network to ensure that it did not adversely impact the

supported level of QoS. This included monitoring all of the network components and the CPU usage of the .A and .B routers. No abnormal readings were observed during the test and the network handled the multicast load without a problem.

Upon completion of the capture period, it was noticed that Ethereal had experienced an error and had closed prematurely, without saving the capture file. This was the primary problem encountered during this test and is explained in greater detail in Subsection 2. All of the files from the other capture devices were available. The core sniffer was used to collect a "post-stream" data set. These files and the data gathered by SolarWinds, along with the observations made during the test, are analyzed in subsection 3 below.

2. Problems Encountered

In the preparatory and test stages this test ran relatively smoothly, with one minor problem. At the VBrick StreamPlayer on the client, the data stream from the VBrick began to experience more and more delay problems as new data streams were added to the network. After the test was complete, an investigation of the problem suggested that the hub to which the VBrick was connected had caused the problem. As more and more data streams were added to the network, the switch forwarded them to the hub, which it in turn forwarded to the 10 Mbps connection used by the VBrick, essentially overloaded the connection. This caused some of the UDP data stream packets to be lost as they collided with the other multicast data stream packets

entering the hub. Figure 30 is a chart of the collision domain of the hub to which the VBrick was connected. As can plainly be seen, the addition of each new data stream increased the traffic which with the hub had to deal. To test this theory, the VBrick was attached directly to the switch for the next test. The result was a reception with less interruptions and lags.

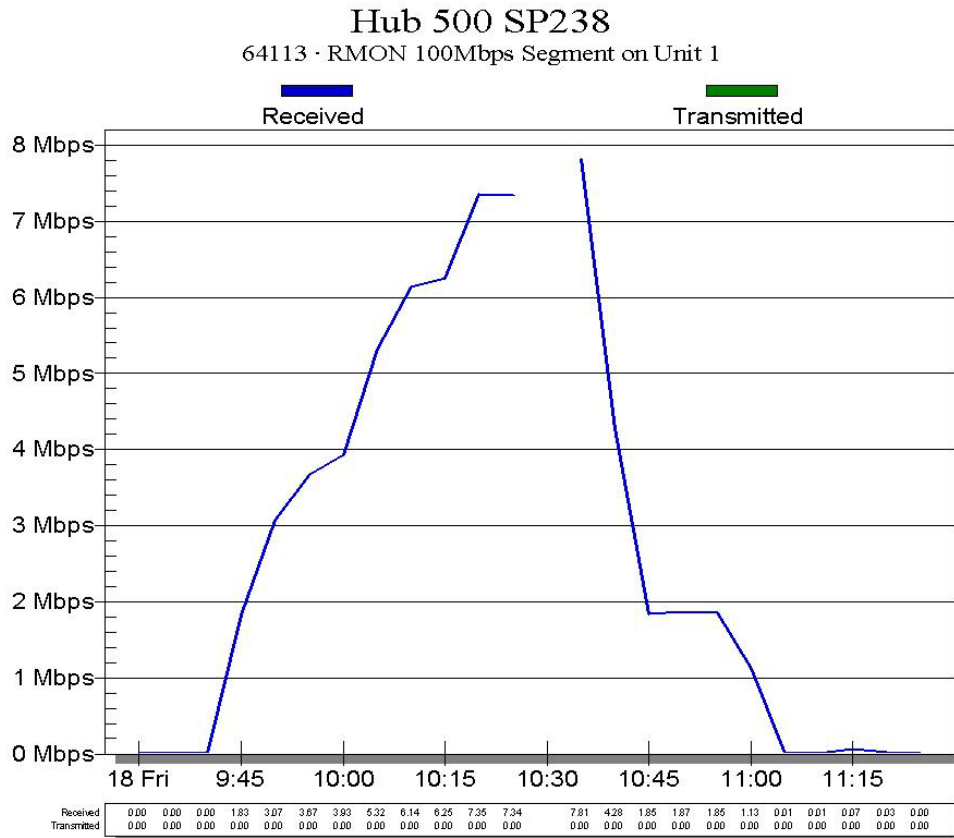

Figure 30. Switch 4 Clarification/Load Test Bandwidth Usage Chart

It was during the post-test that a major problem occurred. As stated above, the sniffer application crashed before the capture file could be saved. It was originally assumed that Ethereal's failure had lost the capture data from the test. But, after searching through the application cache, the raw capture file was found and saved using the

same naming format used in the Initial Test. The data in this capture file was partially corrupted, with an ending packet that exceeded the maximum limit. But it was possible to eliminate this error and view the file up to that point. The time stamps in the packets in this file were used to determine that capture had taken place for about 48 minutes of the test. After scrutinizing the sniffer, both hardware and software, lack of hard-drive space on the capture computer was deemed to be the most plausible cause of the failure. Under this assumption, extra disk space was procured in order to reduce the possibility of this occurring during the final network test.

3. Data Analysis

Analysis of the pretest packet capture from the core sniffer showed little multicast network traffic. Only the PIM routing "Hello" messages between multicast enabled routers were found in this capture file. But this is not a solid data point due to the short capture time. Some protocols may cycle at a rate larger than ten seconds, like IGMP traffic, and it is possible that they were missed.

The recovered packet capture from the core sniffer provided good insight into the network multicast structure. First of all, the PIM and SAP/SDP messages were present and working as expected. Next, the test data streams were present. As new streams were added, their routing messages and accompanying data packets were found. The IGMP messages from the .B router and the client on that subnet were also found. The latter was unexpected and could not be explained by NOC personnel, so a technical assistance call was placed

to Foundry, Inc., to request assistance. According to a technical representative for the company, the router interface will send IGMP queries to its downstream hosts to see if there is any client listening for the multicast session, and that this is normal. This makes sense if only IGMP messages from the router were found in the core captures, but this was not the case. In the core captures, IGMP messages from the client on the .B network were found. This indicates that this router is forwarding IGMP traffic, which should not occur. IGMP should not be on the backbone due to the possibility of creating redundant routing entries in host router (i.e., an entry for the same route in both the (S,G) table created by IGMP and an entry in the normal routing table created by PIM-DM).

Analysis of the post-test packet capture from the core sniffer revealed somewhat the same traffic patterns as the pretest capture, the only difference being the addition of a small amount of multicast traffic from the sessions as they were closed.

The 131.120.A.1 and 131.120.B.1 router both maintained an average of six percent CPU usage throughout the test, with dips to four percent and spikes to as much as eight percent. Currently, the NOC does not maintain this type of data for any length of time as a historical record but according to NOC personnel this average is only slightly above normal for that time of day.

Observation of the VBrick StreamPlayer application on the client during the test indicated that SAP/SDP packets were being transmitted across the NPS network backbone, as all seven sessions were seen and joinable on the client.

All of the following charts were generated by SolarWinds. Figure 31 is a chart of the bandwidth used on the laboratory switch port that serves as the lab's gateway to the NPS network. The "stair step" pattern shows how the bandwidth usage increased as new streams were added. The missing data point at 1035 was unexpected and is surmised to be the result of a lost packet.

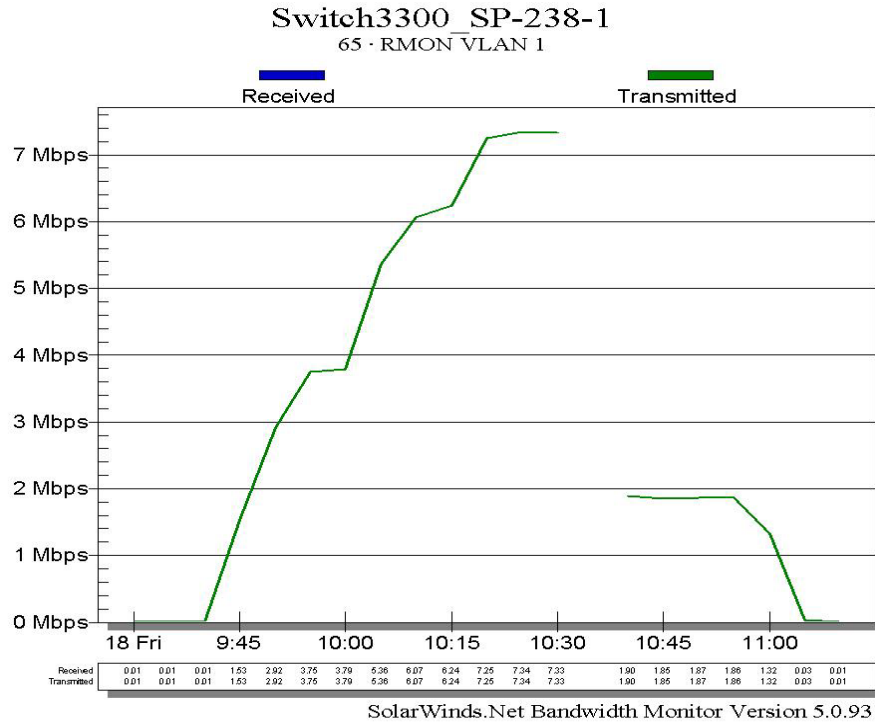

Figure 31. Switch 4 Clarification/Load Test Bandwidth Usage Chart

The left graph in Figure 32 shows the bandwidth usage of the port receiving data from Switch 1 and the graph on the right is the bandwidth usage of the port sending data to the Core Switch.

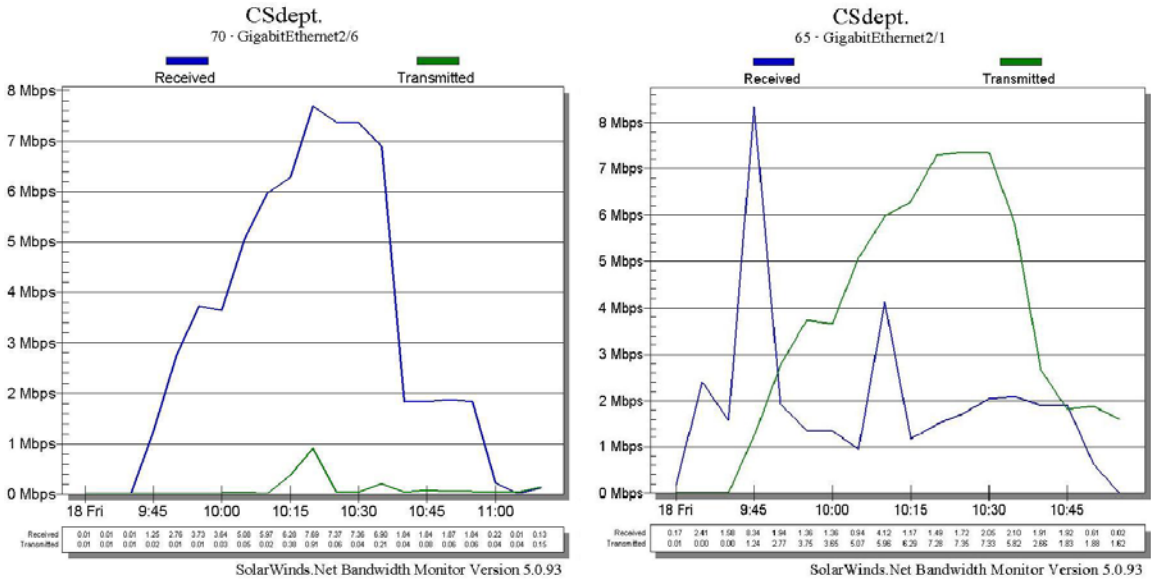

Figure 32. Router 1 Clarification/Load Test Bandwidth Usage Charts

Likewise, the left chart in Figure 33 is the bandwidth usage of the port connected to Router 1 while the chart on the right is for the port connected to Router 2. As a reminder, this test was performed on a live network and some fluctuation was expected. The large spike at the beginning of the test time frame is just such an event.

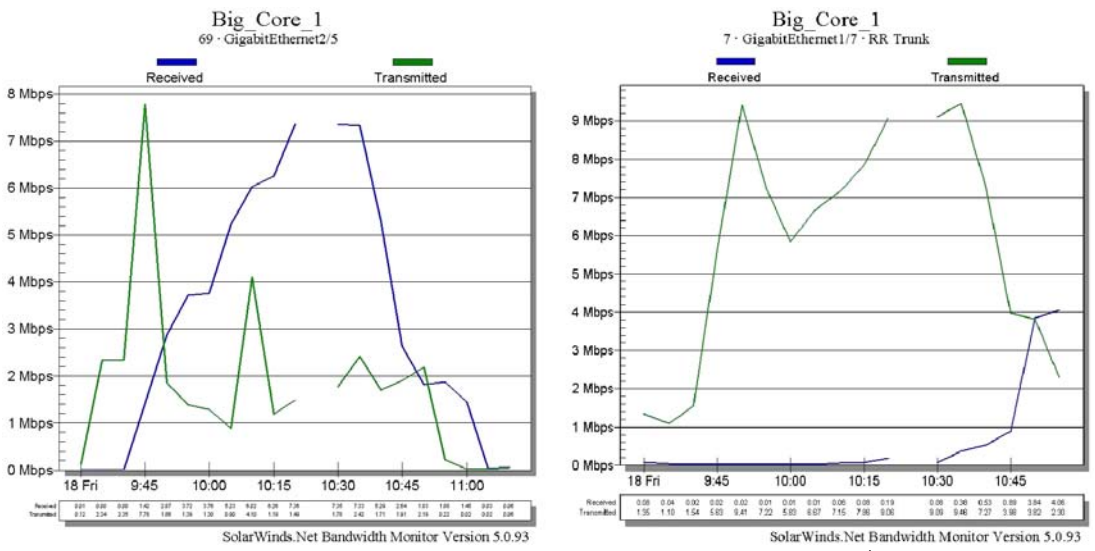

Figure 33. Core Switch 1 Clarification/Load Test Bandwidth Usage Charts

Figure 34 is a graph of the bandwidth usage for the Router 2 port connected to the Core Switch. It shows that the streams traversed the core network with just about the same bandwidth usage as was put into the network.

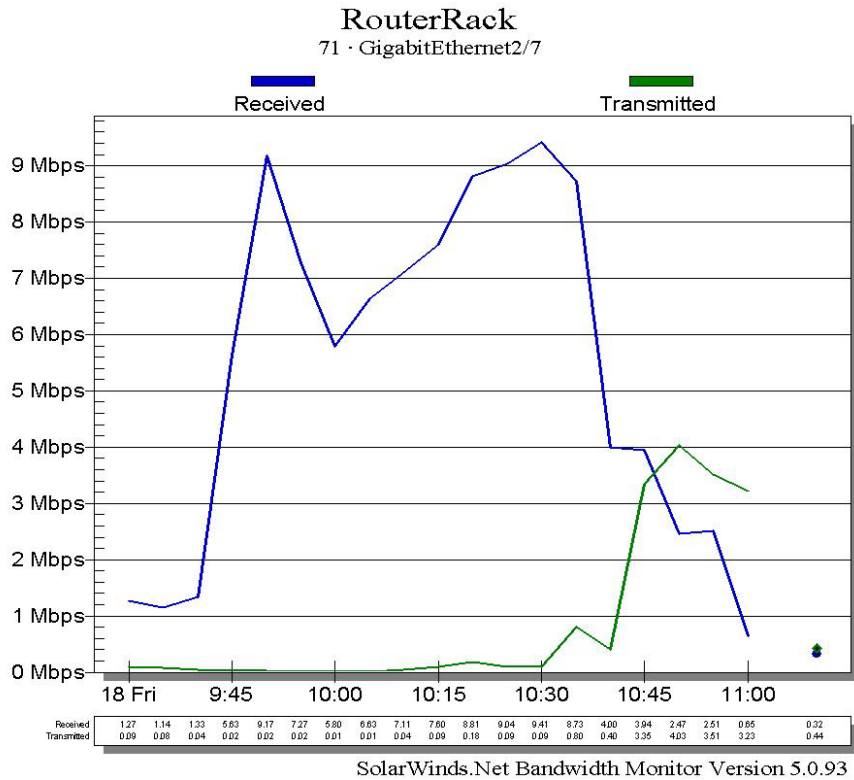

Figure 34. Router 2 Clarification /Load Test Bandwidth Usage Chart

These charts show the multicast bandwidth usage across the NPS network, from the point where it was introduced to the final destination router. This is relevant because it proves that there is **no** multicast loop in the NPS network. If there were, it would be plainly visible, since as packets were retransmitted, the bandwidth usage would grow exponentially for some time period.

4. Test Results

This test clarified and validated the results from the Initial Test. It confirmed that there is **no** multicast loop in the NPS network and that multicast data streams can be used on the NPS Network without causing QoS issues for normal network traffic.

Besides clarifying the first test's finding, it was determined that the NPS network can support multiple multicast data streams without taxing its network components. Furthermore, SAP/SDP messages can traverse the NPS Network and provide session information to clients on subnets with multicast enabled routers. All of these results indicate that the NPS network has the ability to not only support multicast, but support multiple sessions with minimal or no impact on the QoS provided to the normal network traffic. The Stress Test was used to validate this assumption.

D. STRESS TEST

The primary goal of this test was to determine if the NPS core network could handle multiple sustained multicast data streams without impacting the network's QoS. A further goal of this test was to obtain packet captures from the core during this extended time frame. This stress test utilized the refined test plan located in Section B of Appendix B with the exception of the time frame, and was conducted between 10:30 on August 11, 2003 and 10:30 on August 12, 2003. The actual timeframes for the test procedure were as follows: 4 hour for section 5a (test preparation), 24 hours for section 5b (testing), and 1 hour for section 5c (test wrap-up).

1. Test Description

To perform this test, ten data streams totaling approximately 15 Mbps, were initially inserted into the NPS network. During the test additional streams were added to the load and the maximum load on the network reached almost 24Mbps. This was done while autonomously monitoring the network using SolarWinds and the core sniffer. As with the other tests, NOC personnel manually monitored the network's components and the router's CPU utilization. The core sniffer accomplished a half hour capture of the network traffic filtering out everything but multicast related messages just after insertion of test traffic. During the test, two types of captures were conducted every half hour. The first type was a five-minute capture of the entire core traffic flow; it was performed on the hour and half hour. The second type was a five-minute multicast-filtered capture of the core traffic; it was conducted at five minutes past the hour and half hour. All of this data was saved to the extra hard-drive procured for this effort, using the naming convention described in the Initial Test.

Figure 35 depicts the applicable network components and their relationship to each other during this test. The primary difference between this diagram and the one used for the last test is the VBrick's connection to the network. It is now connected directly to Switch 4. Only a core sniffer was used. Both subnets .A and .B are PIM-DM enabled and subnets that are not PIM-DM enabled were not monitored during the test. Again, the multicast sessions were transmitted from subnet .A and the only pertinent session client was on the .B subnet. The VBrick

StreamPlayer on the client was expected to be able to both see and view all sessions.

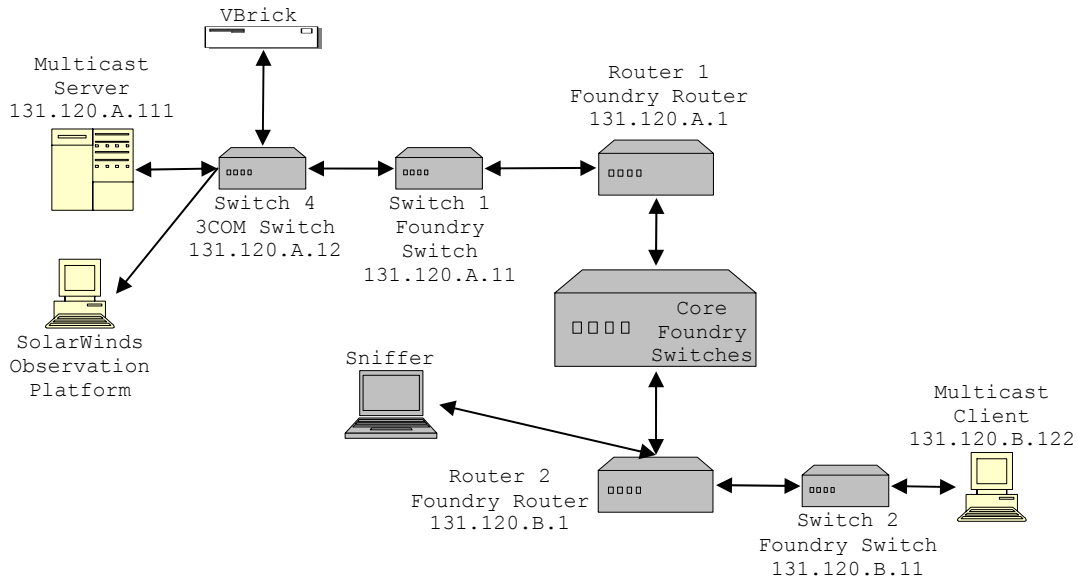

Figure 35. Network Diagram for the Stress Test

All the preparatory steps listed in Subsection 5a of the test plan were performed. This included setting up the VBrick and Video Cassette Recorder (VCR), and loading the VBrick StreamPlayer on the client system. It was again necessary to setup a port on Router 2 to mirror all traffic from the router's core connection. Once the mirrored port was setup, the core sniffer was connected and configured to collect packets. In this test Ethereal was not used to capture the network traffic. Instead, the Tethereal application was used by the .bat files listed in Appendix C and the window Task Scheduler, to perform automated capture over the twenty-four hour period. See Appendix C for an in-depth description of how this worked. The capture schedule was set up in advance to allow for initiation when the test started.

The test was started by initiating the capture on the core sniffer. With the sniffer capture enabled, the multicast data streams from the VBrick and VBrick StreamPump on the Windows 2000 Server were injected into the network. The VBrick StreamPlayer in the client was started and observed to see if the session was visible and could be joined. All ten sessions were visible and the client was able to join them. See Figure 29, in the last section, for an example of what the VBrick StreamPlayer looked like with the sessions available.

During this test period other multicast generation systems were tested across the NPS backbone by another thesis student. The other data streams account for the abnormally high reading from about 12:00 to 18:00 on the test day. The bandwidth usage diagram is shown in Subsection 3.

One half hour into the test, the thirty minute capture of the multicast filtered traffic flow ended. The resulting capture file was about 449 MB in size. At this point the periodic captures began. Initially, this appeared to be working correctly, but a problem was soon discovered; the five minute captures were stopping after only ten to twenty seconds. An in-depth description of the problem follows in the next subsection.

During the entire test, the NOC monitored the network to ensure that its QoS did not degrade. This included monitoring the CPU usage of the .A and .B routers. Both routers maintained an average of eight percent CPU usage throughout the test, with dips to four percent and spikes to as much as ten percent. No abnormally high readings were

observed during the test and the network handled this large multicast load without a problem.

After the twenty-four hour test period ended, packet capture on the core sniffer was stopped. The VBrick StreamPumps on the Windows 2000 server were closed out ending their data streams and the data stream from the VBrick was also stopped. Then the VBrick StreamPlayer in the client was closed out. The capture files and the data gathered by SolarWinds, along with the observations made during the test, are analyzed in Subsection 3, below.

2. Problems Encountered

The only problem encountered during this test was the premature termination of the capture application, Tethereal, during network collection. It appeared that Tethereal's function was unstable when higher numbers of streams were present on the backbone. The application's collection performance was sporadic. Often it would fail after running for only a second or less, other times it would capture the entire five minute period, and for majority of the times it would collect data for ten to twenty seconds before terminating the collection session. At first, it was assumed that this was caused by the massive amount of data being poured from an eight gigabits-per-second connection into a one-hundred megabits-per-second connection. But after examining the situation, it now appears that a combination of factors caused this problem. First, the funneling of a high-speed connection into a low-speed connection was not conducive to the capture. Second, the extra hard-drive space procured for

this test was attached through a 1.1 USB connection, which limited the throughput to the unit to about 1 Mbps. Since the capacity change was so dramatic, 8 Gbps to 1 Mbps, the capture system's memory probably filled to capacity and the application failed. Third, Ethereal and its accompanying applications might not have been designed to handle such a massive amount of data efficiently, which would have compounded the memory problem. Finally, the MSBlast virus may have also been part of the cause. The period during this test is when the virus was spreading across the NPS network, probing for systems to infiltrate. The lower left chart in Figure 36 shows a steady increase in the bandwidth utilization across the core during the test, even though the multicast streams bandwidth usage was stable, as shown by the upper right chart in the same figure. This gradual increase occurred throughout the test period and the morning of August 12, 2003 after the virus was discovered on the NPS network.

3. Data Analysis

Analysis of the initial half hour of collection of the multicast-filtered core traffic indicated that the network was handling the ten multicast data streams as expected. Again, IGMP messages were noted, as in the previous tests.

Both types of periodic core captures ranged, in size from as small as 92 KB to as large as 200 MB. Examination indicated the capture durations were anywhere from less than a second to the five minute limit. As for the content, the traffic pattern was in keeping with that of the half-hour capture.

Using *mergcap* all of the unfiltered captures were combined into one file totaling about 2.484 GB. An evaluation of this file provided the following information. First, the multicast data streams made up 1.744 GB of this file. This was the vast majority of the data present on this link for the duration of the test. Second, the multicast routing protocols made up only 4.536 MB of the capture packets. Finally, normal traffic on this connection made up 736 MB of the captured data. This indicates that the routing overhead needed to support multicast is low and will not affect QoS.

Network and router CPU observations performed by NOC personnel were relatively normal. No network components experienced QoS issues and the CPU usage of Routers 1 and 2 averaged about eight percent. This indicates that a network load that averages about 15 Mbps continuously, does not affect the QoS of the NPS network. With an eight gigabits-per-second backbone it would be safe to assume that a much larger multicast load could be placed on the core network without impacting its QoS, but this would not be the chokepoint of the network. The real bottleneck would be at the routers and switches where the bandwidth is only 100 Mbps. If multiple data streams using close to the capacity of the network segments bandwidth were requested by the various users on a network segment, QoS would suffer. The number of multicast sessions required to generate this bandwidth could be as small as ten or as large as sixty-five, depending on the stream sizes.

Figure 36 contains four graphs of the bandwidth utilized by key network components during this test. The

chart in the upper left corner is of Switch 4, upper right is Switch 1, lower left is the Core Switch, and lower right is from Router 2. From the pattern in all of these charts it can be seen when the extra multicast streams were introduced to, and removed from, the network. It is also easy to see that for the majority of the test, the bandwidth usage ran at about 15 Mbps.

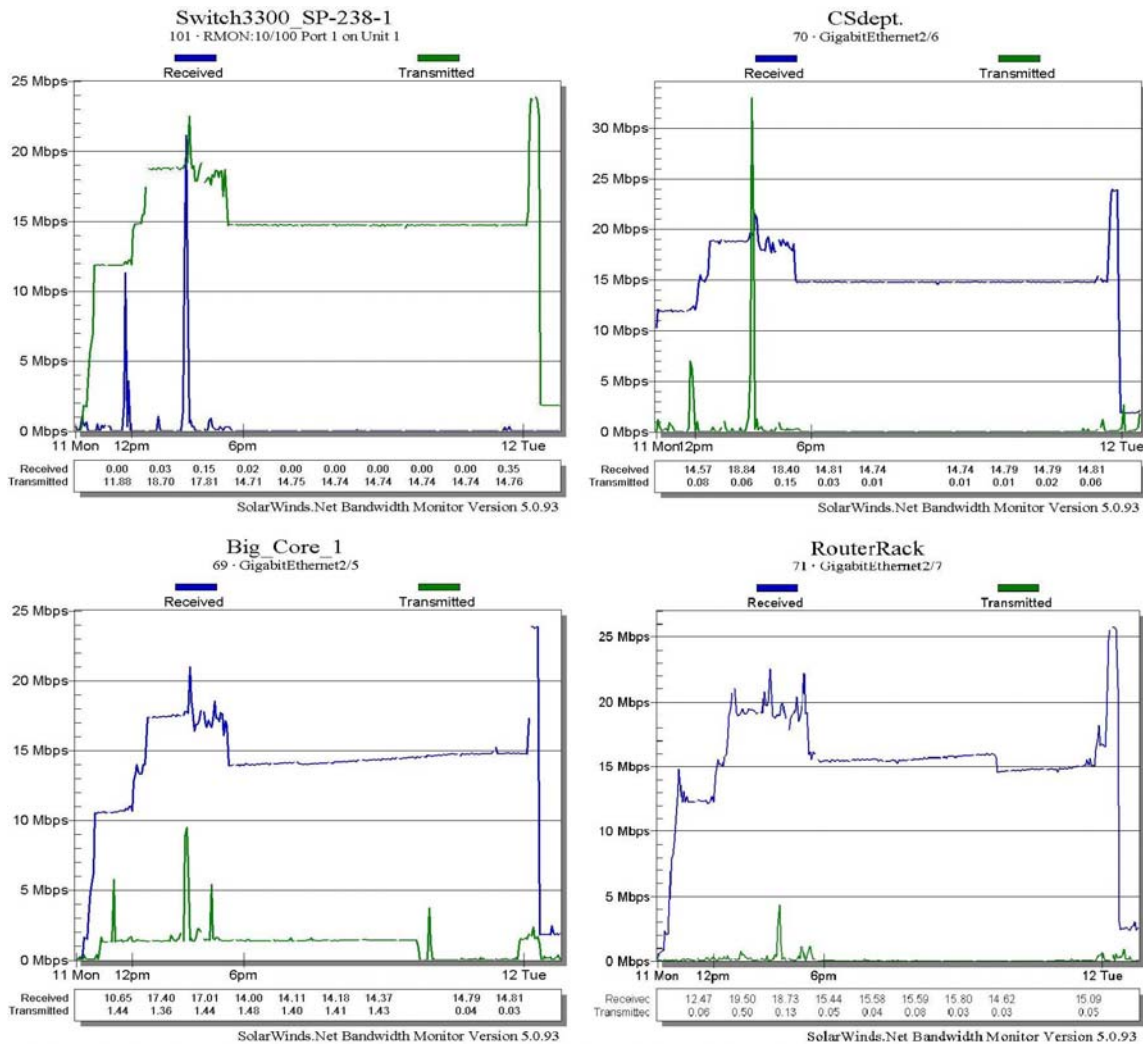

Figure 36. Stress Test Bandwidth Usage Charts

Figure 37 contains four graphs of the bandwidth utilization on four core switch ports that connect to network components that were not multicast enabled during

this test. As can be seen, they show the same utilization as the port with multicast enabled components. This confirms that the core switch broadcasts multicast traffic to every active port.

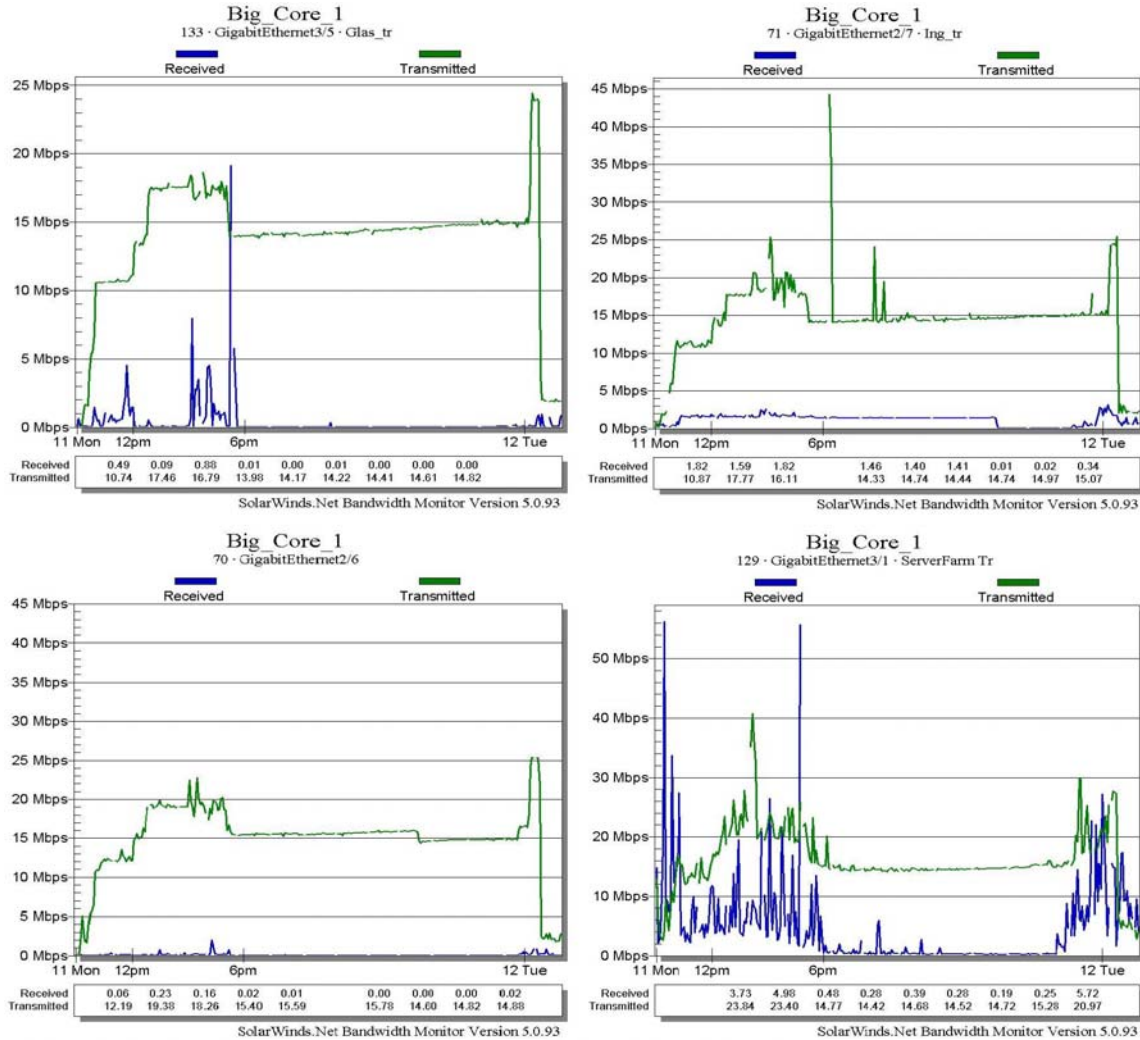

Figure 37. Stress Test Bandwidth Usage Charts

4. Test Results

The results of this test showed that the data stream from the VBrick experienced less interruption when attached directly to the switch, vice the hub. Additionally, it was determined that mass multicast is viable on the NPS network and does not cause QoS issues for normal network traffic. The final discovery made during this test concerns the core

switches. The ones used in the NPS network broadcast multicast traffic to every active port except the one from which it is received. Since this is a layer two switch and PIM-DM is the routing protocol used across the core, there is no current way to limit this behavior. Since the core network currently has a bandwidth glut, 8 Gbps, this does not presently pose a threat to the networks function or QoS. But, in the future, as bandwidth usage increases, this could become a problem.

In this chapter the network tests performed in support of this thesis were described. The problems encountered, analysis of the data, and results of the tests were provided. These findings showed that the majority of the NPS network components support standard multicast routing and that the network can easily support multiple multicast sessions.

THIS PAGE INTENTIONALLY LEFT BLANK

VI. CONCLUSION

Main stream educational systems are moving toward new ways of doing business. They are looking for ways to enroll and educate larger student populations and are even looking at ways of having global student populations. Synchronous distributed learning has the potential to fulfill this need and profoundly change the educational systems throughout the world. Some day soon, it will be possible for a student to sit down at a computer that is across the campus, town, state, country, or even the world, and participate in a class as if in the same room. Multicast is the enabling technology that can make this a reality. With a multicast enabled Internet and the right supporting software and hardware, classes will no longer have to be for just local students. In fact, instructors will no longer have to be local, they can be conduct class from anywhere in the world and students can participate as if they were there with them. All of this is Multicast Distributed Learning (MDL), and it will be the classroom of the future. This is the future of education and the United States military needs to be at its forefront in order to provide its personnel with essential training, at the diverse locations, within the required timeframe.

But, with the military's current training systems primarily classroom oriented, and computer networks that were not designed with multicast in mind, this educational future seems a long way off. To move toward this future, military training and education needs to start thinking in terms of electronic distribution. Classroom lectures,

educational materials, homework, and even testing, needs to be designed with this in mind. This will not only prime the military training system for distributed learning but could have the effect of making military training and education more enjoyable and less stressful on both instructors and students.

It should be noted that this may required a change in mindset for military supervisors, as well, in that students will need to be allowed the time to participate in these distributed learning opportunities. While this may seem to impact subordinate availability, the alternative of long absences while in training status, involving increasing travel costs, can be more adverse, often so much so that training opportunities are either indefinitely postponed or eliminated entirely. This can negatively impact both unit readiness and personnel morale.

The next step in the process is to ensure that current military networks are ready for this future. This is done by ensuring that multicast is viable on them. Here is where this thesis is relevant. Its findings will help identify areas of the NPS network which require attention in order to make the network ready for multicast applications. The test plans and insight will provide the reader with a place to start when testing their networks. Section A, below, provides the findings of this thesis as it applies to the NPS network. Section B contains recommendations for future DOD distributed learning and multicast network services. Finally, Section C is a list of follow-on work to this thesis that needs to be conducted.

A. SUMMARY OF THESIS FINDINGS

It is hoped that the finding in this thesis will allow all forms of multicast to benefit the faculty, staff, and students at NPS. Multicast networking is an enabling technology which can, if configured right, exponentially reduce the load placed on a network by streaming media. For example, during Operation Iraqi Freedom CNN was unicast to the students, staff, and faculty of NPS. Each person that tuned-in generated a new connection to the streaming server and received their own 1.8 Mbps data stream. Since the server was attached to the network via a 100 Mbps connection, a maximum of fifty-five people would have been able to get the show, and that's assuming there's no other traffic on the server's network connection. Another example would be if 20 students on the NPS network are all taking the same distributed learning class generating a multimedia stream 5 Mbps. If unicast addressing is used, the network load would be 100 Mbps, while using multicast addressing would only generate a load of 5 Mbps. As can be seen from these examples, multicast has the potential to be a great asset to institutions that plan to use any form of streaming data distribution. But, in order to make multicasting function properly on the NPS network, it has to be configured correctly.

The configuration of all hardware and software used to perform multicast on the NPS network should to be evaluated and setup by knowledgeable personnel. If these components are used without being properly configured, they can introduce problems into a network and eliminate the

advantages that multicast offers. For example, the VBrick, as configured by the factory, pumped out three streams onto the network which utilized 3.5 Mbps of bandwidth. When configured correctly, only the combined stream was produced, which reduced the stream to 1.8 Mbps. In a bandwidth limited network this could have caused severe QoS problems.

The switches used in the NPS network are another place that will require configuration. While the Foundry switches were found to implement IGMP Snooping in accordance with IETF standards. The 3COM switches that NPS uses were found to implement IGMP Snooping, but not in accordance with IETF standards. Both switch types will need to be configured as in Chapter IV in order get all of the benefits that multicast has to offer. Finally, the inability of 3COM switches to perform IGMP Snooping while none of their clients are members of a session can be overcome by connecting every 3COM switch via a Foundry Switch or by limiting multicast to those switches at the router.

The Foundry routers used on the NPS network were found to implement IGMP and PIM-DM as per the IETF standards. This was determined by examining these routing protocols in use via sniffer captures and by seeing that multicast sessions generated on one side of the network were viable across the network backbone on multicast-enabled subnets but not on multicast-disabled subnets. SAP/SDP messages can traverse the NPS Network and provide session information to clients on subnets with multicast-enabled routers. Furthermore, manually attempting to join multicast sessions

on subnets that are not PIM-DM enabled could not force multicast traffic past the router.

The final configuration of concern to multicasting on the NPS network is that of the core switches. Currently, they broadcast multicast traffic to every active port except for the one from which it was received. Since PIM-DM is used to route traffic across the core and this is a Layer-2 switch with only the ability to perform IGMP Snooping, there is currently no way to limit multicast traffic within the core. Since the bandwidth at the core is currently 8 Gbps, this unwanted traffic should have no affect on QoS. But if in the future it does, the only suggestion the writer can make is to upgrade the core to Layer-3 switches or routers with the ability to perform PIM-DM routing or shift the core multicast routing protocol to IGMP and turn on IGMP Snooping on the core switches. Since IGMP was designed for router-to-client routing, it may not be as efficient as PIM-DM in routing, even with the IGMP Snooping at the core switches. But, it could end up being a change that could improve performance or cause more problems than it solves. Only testing this proposed change would resolve this question.

When multicasting was originally attempted on the NPS network a sever problem was encountered that tainted the NOC personnel's view of multicasting. The network QoS declined as long as the VBrick pumped its streams into the network, eventually making the network very slow and unresponsive. The author believes this was due to two problems. First, the VBrick was not configured correctly, putting out three data streams with each data packet having

a TTL of 63. Second, the NPS network at that time was made up primarily of 3COM equipment and may have had a multicast loop. When combined with the TTL of 63, the loop could have caused the service degradation. Since the network had been upgraded this theory could not be tested. However, as stated in Chapter V, the primary goal of the Initial Test was to see if the problem still existed. Review of the packets captured during that test dispels this idea for the current network. The TTL fields in the captured multicast packets showed that they were only decremented once as the packet traversed the .A router. Since no multicast packet was found with its TTL decremented more than once, it can be declared there are NO multicast loops exist in the NPS core network. Furthermore, multicast data stream quantities greater than ten appear to have NO noticeable impact on the NPS network's QoS. Monitoring of the CPU usage rate on pertinent network routers by NOC personnel substantiate this assertion. From a pretest usage rate of four percent, ten multicast data streams only caused the utilization level to rise to an average of eight percent during the Stress Test.

In the Introduction of this thesis several questions were used to highlight the need for multicast research both at NPS and within DoD. In order to maintain cohesion within this thesis, those questions are restated here with their respective answers, or indicators to the answer's location in this thesis, in italics below them.

- What is multicast and how is it used in distributed learning applications? *This question is answered in Chapter II.*

- What network architectures and topologies best support multicasts, and does it matter? *The architecture and topology of a multicast network are not a primary factor in support of multicasting. The primary factors are equipment and bandwidth. The equipment has to support the multicast protocols used and the bandwidth needs to be great enough to support QoS for regular network traffic while allowing the quantity of data streams needed.*
- What are the most used multicast routing algorithms on commercial and educational networks today? *Among the most prevalent are PIM-SM, IGMP, and DVMRP. More detail can be found in Chapter III.*
- What requirements for multicast applications does the NPS network documentation include? *NPS has no current documented requirements for multicasting. The MOVES curriculum utilizes multicasting for their simulations, but that is usually limited to their LAN segment.*
- What multicast network services are currently available on the NPS network? Were any implemented with the new Foundry Network? *No multicast applications are currently available on the NPS network and none were implemented with the Foundry network. But, all routers on the NPS network are able to support multicasting. They implement the IGMPv2 and PIM-DM protocols, although these protocols are not enabled on the majority of the NPS network routers. See Chapter IV for more detail.*
- Will the current NPS network support multicast? *Yes, if properly configured the NPS network is sufficiently robust to support a large volume of multicast traffic. See Chapter V for more specifics.*

B. RECOMMENDATIONS FOR IMPLEMENTING MULTICAST NETWORK SERVICES IN SUPPORT OF DOD DISTRIBUTED LEARNING

The author's recommends that the NPS network be fully configured to use multicast and there by enabling it to

support synchronous distributed learning. To do this all switches need to be configured to use their IGMP Snooping as described in this thesis. Furthermore, all edge routers need to have their PIM-DM routing enabled. Finally, all 3COM switches still in use need to be connected to the network via a Foundry switch or their router connection port multicast disabled to eliminate flooding. Once these things are accomplished the NPS network will better support multicast and the applications that use it.

For the military in general to move into the educational future described above, several things need to occur. In researching this topic no DoD-wide standards or directives for the acceptance and deployment of multicast-supported applications were found. These need to be developed and adopted so that standard multicast related distributed learning can occur. These standards or directives should contain specifics so that standard multicast routing protocols and application are used throughout the DoD.

Standard guidelines for deploying multicasting in support of synchronous distributed learning are another area in which no guidelines there found. These will need to be developed, accepted, and implemented in order for standard distributed learning applications can be deployed. These guidelines should contain specific tests to perform on current network equipment and multicast-supported applications to certify proper multicast operation, in accordance with specified multicast standards.

Finally, new network equipment and multicast-enabled applications should be evaluated before procurement to

ensure that they are compatible with the multicast routing protocols defined in the standard implemented.

C. FUTURE WORK

This section lists topics that have the potential to become future theses. Each of the topics below should be considered for future research.

- Utilize the findings in this thesis to develop guides for implementing multicasting on DoD networks.
- Develop PIM Snooping to implement on core switches to eliminate multicast broadcast at the network's core.
- Examine the security issues with ASM and how they can be mitigated, perhaps with SSM.
- Investigate how multicasting is or may be implemented in IPv6.
- Evaluate packet capture applications, like Ethereal and EtherPeek, to see if excessively large packet or high data rates can cause the application to fail. During the research for this thesis it appeared that Ethereal might have been susceptible to an attack by a malicious user who injects large packets into the network.

THIS PAGE INTENTIONALLY LEFT BLANK

APPENDIX A: LABORATORY TEST PLANS

The information in this appendix is provided to promote further exploration in the multicast subject area. It should be used as a roadmap for anyone implementing multicast on a legacy network. It is understood that the findings of this thesis will be outdated within the next year. But these test plans should continue to provide a good starting point for multicast implementation research for several years. Anyone tasked with determining if an existing network with older hardware can sustain multicast should utilize these plans.

NOTE: It is advisable to update the firmware in all network hubs, switches, and routers before executing these test plans, if possible.

A. MULTICAST APPLICATION USE ANALYSIS

This test plan can be used to judge an application's viability for inclusion in tool suit used in multicast laboratory and network testing.

1. Introduction

This test plan was used to determine which tools, within the limits of this research area, would make up the tool test suit needed during multicast network testing. For an application, either software or a standalone unit, to be considered for this, it must provide a service listed in section 2 and meet the criteria set forth in section 3. The material in section 4 is used during the steps in section 5 to ensure compliance. All testing should take place in a

non-operational network environment to ensure that the results are not subjective by outside influences.

NOTE: Always ensure that the software application or the firmware of a standalone unit is up to date before testing.

2. Service Needed

For an application to be considered for the multicast test suit, it must perform one of the following services:

- Multicast data stream generation (Multicast Server)
- Multicast data stream receiver (Multicast Client)
- Network data collection (packet capture, bandwidth monitor, etc.)

3. Software Criteria

For an application to be added to the multicast test suit used in this thesis, it must meet all of the following criteria:

- Be within the budget of this project
- Use standard protocols
- Provide ease of installation and use
- Be configurable

4. Materials List

The materials here are required for this test plan:

- Two desktop or laptop computers with network connections
- A network hub or switch with three or more Ethernet ports
- Connecting hardware (i.e., Ethernet cables)
- Some type of sniffer for transmission software.

5. Test Procedure

Before the steps below are executed on a particular application of suit of application, ensure that the test network is operational. Connect the PC's to the hub/switch and ensure that they work and can communicate with each other.

- (a) Evaluate the application price and how easy it was to obtain.
- (b) Install the application on a PC or connect a standalone unit to the hub/switch. Note ease of installation.
- (c) Configure the application/unit to work as needed. Note ease of configuration.
- (d) Operate the application/unit. Note ease of operation.
- (e) If the application/unit is a multicast data stream server, uses a packet sniffer to ensure proper utilization of multicast protocols.
- (f) If application/unit requires a client, install the client on the second PC and use. Note its ease of installation, configuration, and use.
- (g) Evaluate the application/unit and determine its inclusion or exclusion from the multicast test suit.

6. Desired Outcome

The purpose of this test plan is to determine an application's suitability to be included as part of the tool suit used during laboratory and network test for this thesis. So, a definitive determination of include or not include is the desired outcome of this plan.

B. LABORATORY TEST PLAN FOR NETWORK SWITCHES

This test plan can be used for both switches and router. Although, in the case of routers the tester will be

testing its ability to use IGMP correctly, not the IGMP Snooping used in switches. Furthermore, the tester should look at the routers (S,G) table during the test to ensure entries are being made.

1. Introduction

This test plan is provided to facilitate an examination of a network switch's ability to handle IP-multicast traffic through IGMP Snooping. This test plan can be used on a single switch or switches linked in a test network. It should not be used on switches that are part of an operational network. A detailed diagram of the test network in which the switch(es) is/are located should be included as an appendix to this plan. This diagram will facilitate explanation throughout the test plan and provide test evaluators with a better understanding of the test situation. This plan utilizes the materials listed in section 4 to perform the procedures in section 5 and should be conducted by personnel with some familiarity to the switch(es) in question. This plan was developed in order to gather data to help evaluate a switch's ability to support IGMP Snooping. It does not evaluate a switch's ability to support Layer-2 multicasting.

NOTE: If this test is performed on a switch in an operational network, severe problems may occur. For example, the multicast data stream introduced into the network will cause network traffic QoS issues if the network's routers and switches are not or can not be configured to support them. There is even a possibility of a catastrophic network failure.

2. Questions

This test plan was designed in order to answer the following questions:

- Does the network switch perform IGMP Snooping?
- Does the network switch implement IGMP Snooping correctly?
- Can the network switch be used to support network switches that do not support IGMP snooping?

3. Test Plan Schedule

Since the switch(es) in question are standalone or part of a test network, the plan can be performed anytime.

4. Materials List

The following materials were used during this experiment:

- The switch or switches in the test network.
- Packet capture computer(s) (sniffer) connected into each switch in the test network (can be laptops or desktops with Ethereal, EtherPeek, etc. on them).
- A multicast server that uses IGMP and transmit a single multicast data stream (VBrick, VBrick StreamPump, etc.).
- Multicast client computer(s) with a stream player installed, connected into each switch to be tested (VBrick StreamPlayer, etc.).
- One computer running a network monitoring tool (SolarWinds, etc.), configured to monitor every switch in the test network.

5. Test Procedure

This test plan has been steps. Each step is to be performed in order and the loop that occurs between step (g) and step (z) is performed until every possible combination of configuration options has been tested. Test options that do not directly correspond to IGMP and multicast to determine if they have and affect on the multicast data stream. The actual test plan begins here.

- (a) Connect multicast server, multicast client(s), sniffer(s), network monitoring platform, and switch(es) together.
- (b) Ensure that everything is communicating and functioning properly (i.e., network address are assigned, computer see each other, etc.).
- (c) If the switch(es) is configured for use in an operational network, take a snapshot of the current configuration. If the switch(es) is new, get a current configuration of a standard switch in the network.
- (d) Upgrade switch(es) to the most current firmware version available, if necessary.
- (e) Reset the switch's configuration to factory default and ensure that communication between all components is still occurring.
- (f) Observe the activity indicators on the active port on switch(es), note activity level with no multicast present on the network.
- (g) Using the multicast server, start injecting a data stream into the switch.
- (h) Observe the activity indicators on the active port on switch(es), note activity level. If level is close to pre-multicast injection level, note the switch configuration and client receive state.
- (i) Utilize the sniffer(s) to see if stream packets can be captured. If no multicast data stream

packets are captured, note the switch configuration and client receive state.

- (j) Utilize the multicast client to receive the multicast session.
- (k) Repeat steps (h) and (i).
- (l) Stop Client.
- (m) Stop Server.
- (n) Change one configuration option in the switch(es) and save the configuration.
- (o) Repeat steps (g) through (n) until every combination of switch options have been tested.
- (p) If required, return switch(es) to its pretest configuration and return to active duty.
- (q) If switch is to be used in multicast network return to the configuration which best supported multicast.

6. Desired Outcome

It is expected that at the conclusion of this test plan, the tester will have determined if the network switch has ability to perform IGMP Snooping in support of multicast. If it does, the proper switch configuration to support multicast. Finally, if IGMP Snooping is supported, has it been implement correctly and can the switch be used to support hubs and switches without IGMP Snooping.

THIS PAGE INTENTIONALLY LEFT BLANK

APPENDIX B: NETWORK TEST PLANS

The information in this appendix is provided as aid for anyone implementing multicast on a legacy network. It is understood that the findings presented earlier in this thesis will be outdated in the next year. But these test plans should provide a good starting point for anyone tasked with determining if an existing network, with older hardware, can sustain multicast.

NOTE: It is advisable to update the firmware in all network hubs, switches, and routers before executing these test plans, if possible.

A. MULTICAST NETWORK TEST PLAN (INITIAL)

This test plan was the initial plan developed to test the ability of the NPS network to support multicast. It served its purpose and was included in this thesis a reference data. The test plan in section B is a refinement of this test plan. If using this thesis to evaluate an existing network, it would be advisable to use that test plan.

1. Introduction

This test plan is provided to facilitate an examination of the NPS networks ability to handle multicast traffic. This test will utilize the materials listed in section 5 to perform the procedures in section 6b and will be conducted by the personnel in section 4. This project was developed in order to gather data that will be evaluated by the author as part of his thesis project. The

network diagram in the figure below is provided in order to facilitate explanation throughout this test plan.

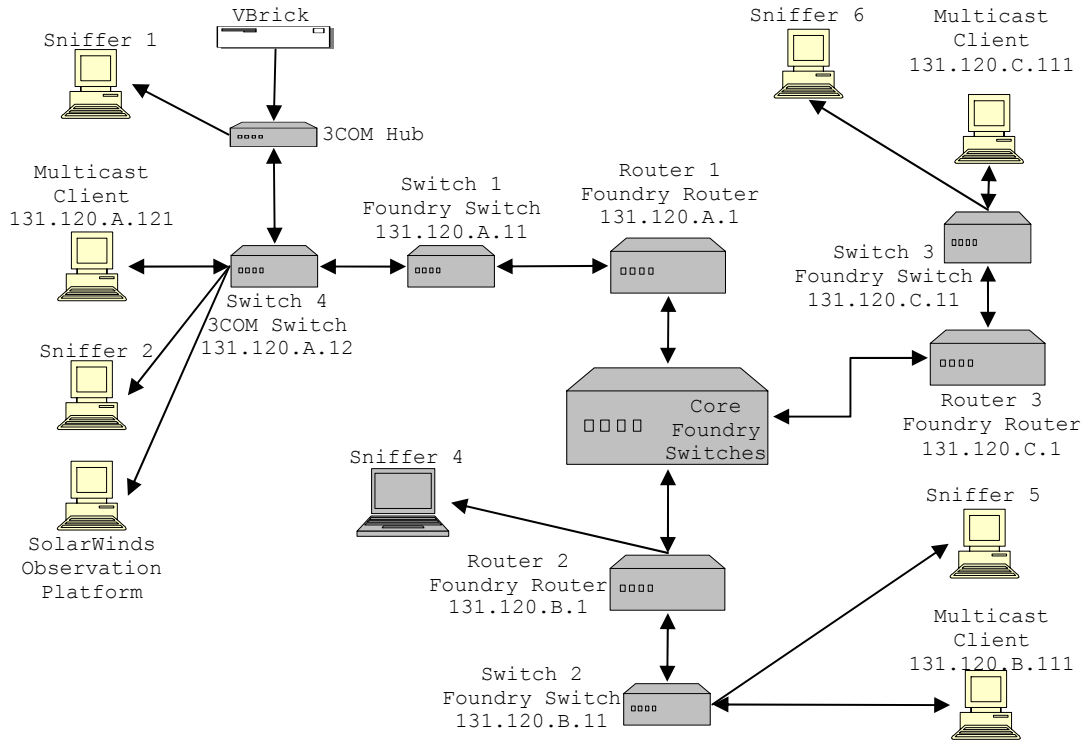

Figure 38. Network Diagram for the Initial Test

2. Questions

This test plan was designed in hopes of answering the following questions:

- Is there a multicast traffic loop in the NPS network?
- Can the NPS network support campus wide multicast traffic without degrading the network's current quality of service (QoS)?
- Will routers that are not PIM-DM enabled route using IGMP and forward multicast traffic onto other network segments through the core?
- What is the actual multicast traffic pattern currently like on the NPS network?

3. Test Plan Schedule

This project plan will be executed during the NPS two week summer break period, which starts on June 23, 2003 and ends on July 07, 2003. The exact test date is June 30, 2003 while the actual timeframes for the testing procedure are as follows: 4 hour (0800-1200) for test preparation - see section 6a, 2 hours (1300-1500) for testing (testing will only be conducted for 1 hour (1330-1430) during this 2 hour block - see section 6b), and 1 hour for test wrap-up - see section 6c.

4. Participants

- Lonna Sherwin (NPS NOC)
- JP Pierson (NPS NOC)
- Lary Moore and/or Mike Nichols (NPS Code 05)
- LT Christopher V. Quick (NPS Thesis Student)

5. Materials List

The following materials were used during this experiment:

- The NPS network (see the figure in section 1)
- Six packet capture computers (sniffers) connected into the NPS network at strategic locations (can be laptops or desktop with Ethereal, EtherPeek, etc. on them).
- The Code 05 VBrick - setup to capture video from a VCR and transmit a single multicast stream.
- One VCR to provide video capture content (a Microsoft Video) to the VBrick via an RCA connection.
- Three multicast client computer with VBrick's StreamPlayer installed - one in each designated

LAN segment (131.120.A.1, 131.120.B.1, and 131.120.C.1) to receive the multicast session.

- One computer running SolarWinds, configures to monitor all hub, switches, and routers in the network.

6. Test Procedure

This test plan has been broken down into three parts in order to ensure that the integrity of the network is not compromised. The Preparation section contains all the steps required to be completed before the tangible test is started, the Testing section contains the actual test procedure, and the Wrap-up section contains all steps needed to put the network back in its pre-test configuration.

a. Preparation steps

NOTE: These steps will be performed from 0800 to 1200 on 30 JUN 03.

- Install the VBrick StreamPlayer on computers in the 131.120.A.1 and 131.120.B.1 segments. It will also be installed on a machine in the 131.120.C.1 segment; this segment is not multicast enabled.
- Connect sniffers to the hub on the .A network segment and to a data port on the 131.120.A.11 switch.
- Setup a port on the 131.120.B.1 router to mirror all traffic from the core switch connection trunk.
- Connect the core sniffer to the mirrored data port on the 131.120.B.1 router.
- Change the IP address of the sniffer so that it is a member of the 131.120.B.1 segment.
- Configure the sniffer on the 131.120.B.1 router to capture all multicast traffic entering and exiting the router on the core trunk.

- Connect the VCR to the VBrick and setup the VBrick to multicast video captured from the VCR.
- Place the video tape into the VCR and ensure that it is rewound.

b. Test Steps

NOTE: The time period for this test is 1300-1500, actual testing is scheduled from 1330 to 1430. Completion of the fifth bullet in this section constituted the beginning of the 1 hour test period. It is important to note that if at any time the network begins to experience problems or QoS is severely impaired, the multicast sessions will be stopped at once and all data to that point will be evaluated to determine the problem.

- At time 1320 start packet capture on the core sniffer and capture ALL core traffic for 10 second. Save the capture to a file.
- At time 1325 start the VBrick StreamPlayer application on the client computer attached to the 131.120.A.1, 131.120.B.1, and 131.120.C.1 segments.
- At time 1330 restart packet capture on core sniffer with the multicast packet filter in place.
- At time 1330 start playing the tape in the VCR.
- At time 1330 connect the VBrick to the 131.120.A.1 network segment.
- At each client, see if the VBrick multicast group can be seen and join the session when/if a session announcement is received.
- Note CPU usage of the 131.120.A.1, 131.120.B.1, and 131.120.C.1 routers during the one hour time period.
- At all clients continue observing the session or attempting to get the session for one hour timeframe.

- When the 1 hour time frame is complete, disconnect the VBrick from the network.

c. *Wrap-up*

NOTE: At the conclusion of the 1 hour test ensure that the following events occur.

- Close the VBrick StreamPlayer application on all clients.
- Stop packet capture on all other sniffers and save all data files. Name them for the network segment the data was collected on.
- Stop packet capture on the core sniffer and save the data file named for the core.
- Disconnect sniffer from 131.120.B.1 router.
- Reconfigure the mirrored router port on the 131.120.B.1 router for normal operation.
- Reconfigure core sniffer's IP address for normal operation.
- Remove VBrick StreamPlayer software from systems where it is no longer needed.

7. Desired Outcome

It is hoped that this test will provide data that may enable multicast broadcast to become a reality at NPS. Finding that multicast works, without error, on the new backbone or to find a correctable problem is the primary goal of this test. All data and findings of this test will be provided to the NOC and Code 05 before being released for any other purposes.

B. MULTICAST NETWORK TEST PLAN (FINAL)

The Test Plan below was used during the Clarification/Load and Stress tests. Its purpose was to

coordinate the efforts of all personnel involved in the test, ensure that all necessary safety measures were followed, and all equipment was returned to its pretest state.

1. Test Plan Introduction

This test plan was developed to facilitate an examination of the NPS networks ability to handle multicast, various multicast protocols, and multiple multicast broadcast streams. The author of this thesis and personnel from the NOC utilized the materials listed in section 3 to perform the test procedure in section 4. This plan was developed in order to gather multicast routing traffic and stream data for evaluation and analysis as part of this thesis project. The network diagram in Figure 12 below is provided in order to facilitate explanation throughout this test plan.

2. Questions

Questions are the fundamental reason behind every test plan and this one was designed in order to answer the questions indicated in the subsections above. If this test plan is being used for further research in the area of multicast, the questions that need to be answer go here.

3. Test Plan Schedule

The execution of this test plan took place in the timeframe indicated in the subsections above. If this test plan is being used for further research in the area of

multicast, the actual timeframe of the test need to go here.

4. Materials List

The following materials were used during this experiment:

- The NPS network (see the figures in the subsections above)
- One packet capture computer (sniffer) connected to the core switches of the NPS network (a laptop running Ethereal)
- One computer running SolarWinds, configured to monitor all hub, switches, and routers in the network
- The Code 05 VBrick - setup to transmit a multicast stream from a VCR.
- One VCR to provide video capture content (a Microsoft Video) to the VBrick via an RCA connection.
- A Windows 2000 server running VBrick Systems, StreamPump version 2.1.0
- Multiple .mov files to stream via the server (one for each stream is required)
- One computer with VBrick's StreamPlayer installed.

5. Test Procedure

This test plan was broken down into three parts in order to ensure that the integrity of the network was not compromised. The Preparation section contains all the steps required to be completed before the tangible test was started. These steps were performed on July 17, 2003 from 1400 to 1500 and on July 18, 2003 from 0800 to 0900. The Test Steps section contains the actual steps for the test. Those steps were performed on July 18, 2003 from 0930 to

1030. The Wrap-up steps contain all the actions needed to put the network back in its pre-test configuration. Those steps were performed on July 18, 2003 from 1030 to 1130.

a. Preparation Steps

- Install the VBrick StreamPlayer on a computer connected to the 131.120.B.1 segment.
- Setup a port on the 131.120.B.1 router to mirror all traffic from the core switch.
- Connect the core sniffers to the mirrored data port on the 131.120.B.1 router.
- Change the IP address of the sniffer so that it is a member of the 131.120.B.1 segment.
- Connect the VCR to the VBrick and setup the VBrick to multicast video captured from the VCR.
- Configure a sniffer port on the 131.120.B.1 router to mirror all data entering and exiting the router on the core trunk.

b. Test Steps

Completion of the fifth bullet in this section constituted the beginning of the 1 hour test period. It is important to note that if at any time the network begins to experience problems or QoS is severely impaired, the multicast sessions will be stopped at once and all data to that point will be evaluated to determine the problem.

- Connect the sniffer to the sniffer port and use it to capture all core traffic for 10 second. Save the capture to a file.
- Restart packet capture on core sniffer with the multicast packet filter in place.
- Start the VBrick StreamPlayer application on the client computer attached to the 131.120.B.1 segment.
- Start playing the media in the VCR.

- Connect the VBrick to the 131.120.A.1 network segment.
- At the client, join the VBrick session when a channel announcement is received.
- At the multicast server, starts a new multicast stream every five minutes until a total of seven streams are being transmitted.
- Use the client to join each multicast session at they appear on the VBrick StreamPlayer application.
- Note CPU usage of the 131.120.A.1 and 131.120.B.1 Routers as the new session are introduced and monitor the network closely during this time period.
- At the client, periodically switch between each session for the remainder of the 1 hour timeframe.
- When the 1 hour time frame is complete shut down the multicast streams from the server one at a time.
- Disconnect the VBrick from the network.

c. Wrap-up

- Close the VBrick StreamPlayer application on the client.
- Stop packet capture on the core sniffer and save the data file.
- Disconnect sniffer from 131.120.B.1 router.
- Reconfigure the mirrored router port on the 131.120.B.1 router for normal operation.
- Reconfigure sniffer's IP address for normal operation.

6. Desired Outcome

It was hoped that multicast would work, without error, on the new network backbone or a correctable configuration

problem would be found. This test was designed to provide data that would allow multicast to be enable throughout the entire NPS network so that multicast media to become a reality at NPS. Finally, all the data and findings from this test have been provided to the NOC and Code 05 before being released in this document.

THIS PAGE INTENTIONALLY LEFT BLANK

APPENDIX C: AUTOMATED PACKET CAPTURE

Capturing network traffic over an extended period can be performed by Ethereal as long as it is a continuous capture session. Ethereal also allows the user to capture during a specific time period as long as the user is present to initial the process. But for the twenty-four hour test, captures were to be performed every half hour for five minute. A capture of the entire packet flow and after that a five minute capture of the network traffic with the multicast filter in place. This would not be possible with Ethereal unless it was done manually.

To get around this limitation in Ethereal, the Tethereal application, .bat files, and the Windows Task Scheduler were used. Tethereal is part of the Ethereal installation and is a text driven version of Ethereal's packet capture process. Using the .bat files to initiate the process allowed the capture file name to be altered every time a new capture was started. The three .bat files used during the Stress test are listed below. LongCaptureM-Cast.bat initiated a multicast filter network traffic capture for an hour, Capture.bat was used to initial an entire flow capture for five minutes, and CaptureM-Cast.bat initiated a five minute capture of the multicast filtered network traffic.

Using these .bat files, it was possible to setup tasks in the Windows Task Scheduler to execute them every thirty minutes. Thus providing an automated the periodic capture of network traffic throughout a twenty-four hour period.

```

@ECHO off
rem -----
rem  Filename: LongCaptureM-Cast.bat
rem  Date:      August 09, 2003
rem  Author:    Christopher V. Quick
rem  Purpose:   Uses Tethereal and Timestamp Code to capture
rem             filtered packets from Ethernet port for an
rem             hour.
rem -----

rem Create the date and time elements.
For /f "tokens=1-7 delims=:/-, " %i in ('echo exit^|cmd /q
/k"prompt $D $T"') do (
  For /f "tokens=2-4 delims=/-,() skip=1" %a in
    ('echo.^|date') do (
      set dow=%i
      set %%a=%j
      set %%b=%k
      set %%c=%l
      set hh=%m
      set min=%n
      set ss=%o
    )
  )

set timeval=MCapFile_%yy%-%mm%-%dd%_%hh%-%min%-%ss%.eth

ECHO File %timeval% being created.
tethereal -a duration:1800 -f "ether multicast and not
          ether proto \arp" -F libpcap -w F:\%timeval%
ECHO File %timeval% created.

```

```

@ECHO off
rem -----
rem  Filename: Capture.bat
rem  Date:      August 09, 2003
rem  Author:    Christopher V. Quick
rem  Purpose:   Uses Tethereal and Timestamp Code to capture
rem             entire packet flow on the Ethernet port for
rem             five minutes.
rem -----

rem Create the date and time elements.

```

```

For /f "tokens=1-7 delims=:/-, " %i in ('echo exit^|cmd /q
/k"prompt $D $T"') do (
    For /f "tokens=2-4 delims=:/-,() skip=1" %%a in
('echo.^|date') do (
        set dow=%i
        set %%a=%j
        set %%b=%k
        set %%c=%l
        set hh=%m
        set min=%n
        set ss=%o
    )
)

```

```

set timeval=CapFile_%yy%-%mm%-%dd%_%hh%-%min%-%ss%.eth

```

```

ECHO File %timeval% being created.
tethereal -a duration:300 -F libpcap -w F:\%timeval%
ECHO File %timeval% created.

```

```

@ECHO off
rem -----
rem Filename: CaptureM-Cast.bat
rem Date:      August 09, 2003
rem Author:    Christopher V. Quick
rem Purpose:   Uses Tethereal and Timestamp Code to capture
rem             filtered packets from Ethernet port for five
rem             minutes.
rem -----

```

```

rem Create the date and time elements.
For /f "tokens=1-7 delims=:/-, " %i in ('echo exit^|cmd /q
/k"prompt $D $T"') do (
    For /f "tokens=2-4 delims=:/-,() skip=1" %%a in
('echo.^|date') do (
        set dow=%i
        set %%a=%j
        set %%b=%k
        set %%c=%l
        set hh=%m
        set min=%n
        set ss=%o
    )
)

```

```
set timeval=MCapFile_%yy%-%mm%-%dd%_%hh%-%min%-%ss%.eth
```

```
ECHO File %timeval% being created.
```

```
tethereal -a duration:300 -f "ether multicast and not ether  
proto \arp" -F libpcap -w F:\%timeval%
```

```
ECHO File %timeval% created.
```

LIST OF REFERENCES

- [01] ODUSD(R), Readiness and Training, "Department of Defense Strategic Plan for Advanced Distributed Learning"
[<http://www.maxwell.af.mil/au/afiadl/plans&policy/pdfs/dodstratplan.pdf>] August 2003
- [02] Director of Naval Training (N7), "The Navy-Wide Distributed Learning Planning Strategy"
[https://www.cnet.navy.mil/cnet/Trn_tech/DL/finall.pdf]
] August 2003
- [03] Ko, Susan and Rossen, Steve, *College Teaching Series: Teaching Online-A Practical Guide*, Houghton Mufflin, 2001
- [04] Seneca College, "Distance Learning"
[<http://cdl.senecac.on.ca/Prospective/Intro/dl.html>]
June 2003
- [05] Intelligraphics Inc., "IP-Multicasting Technology Part 1: History and Overview"
[http://www.intelligraphics.com/articles/ipmulticasting1_article.html] August 2003
- [06] IANA, "INTERNET MULTICAST ADDRESSES"
[<http://www.iana.org/assignments/multicast-addresses>]
July 2003
- [07] Meyer D. and Lothberg P., "RFC-2770: GLOP Addressing in 233/8", [<http://www.faqs.org/rfcs/rfc2770.html>]
July 2003
- [08] Huston, Geoff, "Autonomous System Number-to-Name Mapping" [<http://bgp.potaroo.net/cidr/autnums.html>]
June 2003
- [09] Black, Darryl P., *Building Switched Networks*, pp. 193-209, Addison-Wesley, 1999
- [10] Miller, C. Kenneth, *Multicast Networking and Applications*, Addison-Wesley, 1998

- [11] Edwards, Brian M., Giuliano, Leonard A., Wright, Brian R., Interdomain Multicast Routing, pp. 109-120, Addison-Wesley, 2002
- [12] Handley, M. and Perkins, C. and Whelan, E., "RFC-2974: Session Announcement Protocol"
[<http://www.faqs.org/rfcs/rfc2974.html>] June 2003
- [13] Handley, M. and Jacobson, V., "RFC-2327: SDP: Session Description Protocol"
[<http://www.faqs.org/rfcs/rfc2327.html>] July 2003
- [14] Deering S., "RFC-1112: Host Extensions for IP Multicasting" [<http://www.faqs.org/rfcs/rfc1112.html>]
July 2003
- [15] Fenner, W., "RFC-2236: Internet Group Management Protocol, Version 2"
[<http://www.faqs.org/rfcs/rfc2236.html>] July 2003
- [16] Cain, B., Deering, S., Kouvelas, I., Fenner, B., Thyagarajan, A., "RFC-3376: Internet Group Management Protocol, Version 3"
[<http://www.faqs.org/rfcs/rfc3376.html>] June 2003
- [17] Tseng, Mickey, "IGMP Snooping"
[<http://www.zyxel.com/support/supportnote/ves1012/app/igmpsnoop.htm>] July 2003
- [18] Intelligraphics Inc., "IP-Multicasting Technology Part 3: Protocol Timing, Sizing and Decoding"
[http://www.intelligraphics.com/articles/ipmulticasting3_article.html] August 2003
- [19] Waitzman, D. and Partridge, C. and Deering S., "RFC-1075: Distance Vector Multicast Routing Protocol"
[<http://www.faqs.org/rfcs/rfc1075.html>] August 2003
- [20] Ross, Keith W. and Kurose, Jim "Computer Networking: A Top-Down Approach Featuring the Internet"
[<http://cosmos.kaist.ac.kr/cs441/text/Contents.htm>]
August 2003
- [21] Guzules, Amy, "SuperStack Switch Management Guide"
<http://support.3com.com/infodeli/tools/switches/ss3/management/ug/mlticast.htm> August 2003

- [22] Foundry Networks, *Foundry switch and Router Installation and Basic Configuration Guide*, May 2002
- [23] Bhattacharyya, S., "FRC-3569: An Overview of Source-Specific Multicast (SSM)"
[<http://www.fqs.org/rfcs/rfc3569.html>] June 2003

THIS PAGE INTENTIONALLY LEFT BLANK

INITIAL DISTRIBUTION LIST

Defense Technical Information Center
Ft. Belvoir, VA

Dudley Knox Library
Naval Postgraduate School
Monterey, CA

Chairman, Code 32
Naval Postgraduate School
Monterey, CA

Professor Geoffrey Xie, Code 32
Naval Postgraduate School
Monterey, CA

Lonna Sherwin, NOC
Naval Postgraduate School
Monterey, CA

Brian Steckler
Naval Postgraduate School
Monterey, CA

Joe Lopiccolo, Code 05
Naval Postgraduate School
Monterey, CA

Vince Darago
Naval Postgraduate School
Monterey, CA

Lary Moore, Code 05
Naval Postgraduate School
Monterey, CA

Mike Nichols, Code 05
Naval Postgraduate School
Monterey, CA

LT Christopher V. Quick
Naval Information Warfare Activity (NIWA)
Ft. George G. Meade, MD