



NAVAL
POSTGRADUATE
SCHOOL

MONTEREY, CALIFORNIA

**Centralized Control of Defense Acquisition Programs:
A Comparative Review of the Framework from 1987 – 2003**

29 September 2003

by

John T. Dillard

**Naval Postgraduate School
Monterey, California**

RADM. David Ellison
Superintendent

Richard S. Elster
Provost

The Acquisition Chair, Graduate School of Business & Public Policy, Naval Postgraduate School supported the funding of the research presented herein. Reproduction of all or part of this report is authorized.

The report was prepared by:

John T. Dillard
Graduate School of Business & Public Policy

Reviewed by:

Douglas A. Brook, Ph.D.
Dean, Graduate School of Business & Public Policy

Released by:

Leonard A. Ferrari, Ph.D.
Associate Provost and Dean of Research

REPORT DOCUMENTATION PAGEForm approved
OMB No 0704-0188

Public reporting burden for this collection of information is estimated to average 1 hour per response, including the time for reviewing instructions, searching existing data sources, gathering and maintaining the data needed, and completing and reviewing the collection of information. Send comments regarding this burden estimate or any other aspect of this collection of information, including suggestions for reducing this burden, to Washington Headquarters Services, Directorate for Information Operations and Reports, 1215 Jefferson Davis Highway, Suite 1204, Arlington, VA 22202-4302, and to the Office of Management and Budget, Paperwork Reduction Project (0704-0188), Washington, DC 20503.

1. AGENCY USE ONLY (Leave blank)		2. REPORT DATE 29 Sep 2003	3. REPORT TYPE AND DATES COVERED Final – 1 July – 29 Sep 2003	
4. TITLE AND SUBTITLE Centralized Control of Defense Acquisition Programs: A Comparative Review of the Framework from 1987 - 2003			5. FUNDING	
6. AUTHOR (S) John T. Dillard				
7. PERFORMING ORGANIZATION NAME (S) AND ADDRESS (ES) US Naval Postgraduate School, Code BP/Dj 555 Dyer Road, Monterey, CA 93943			8. PERFORMING ORGANIZATION REPORT NUMBER NPS-GSBPP-03-003	
9. SPONSORING/MONITORING AGENCY NAME (S) AND ADDRESS (ES)			10. SPONSORING/MONITORING AGENCY REPORT NUMBER	
11. SUPPLEMENTARY NOTES				
12a. DISTRIBUTION/AVAILABILITY STATEMENT Approved for public release; distribution unlimited			12b. DISTRIBUTION CODE	
13. ABSTRACT (Maximum 200 words.) <p>In the last three years, there has been a great deal of turbulence in defense acquisition policy. This has led to confusion within the acquisition workforce over the major policy thrusts, terminology, and unobvious implications of the changes. The new acquisition framework has added complexity, with more phases and delineations of activity -- and both the number and level of decision reviews have been increased. Decision reviews are typically used as top management level control gates, and are also a feature of centralized control within a bureaucracy. Although the current stated policy is to foster an environment supporting flexibility and innovation, the new framework will cause Program Managers to devote more time and other resources managing the decision bureaucracy. Moreover, the implicit aspects of the still new model have not been fully realized, and may result in policy that actually lengthens programs and delivers yesterday's technology tomorrow -- counter to goals of rapid transformation. The framework, and its associated requirements for senior level reviews, are opposed to the rapid and evolutionary policy espoused, and are counter to appropriate management strategies for a transformational era.</p>				
14. SUBJECT TERMS Acquisition policy, DoD 5000 series, centralization, control in organizations, decision making, models, framework			15. NUMBER OF PAGES 66	
			16. PRICE CODE	
17. SECURITY CLASSIFICATION OF REPORT: UNCLASSIFIED	18. SECURITY CLASSIFICATION OF THIS PAGE: UNCLASSIFIED	19. SECURITY CLASSIFICATION OF ABSTRACT: UNCLASSIFIED	20. LIMITATION OF ABSTRACT: UNLIMITED	

Abstract

In the last three years, there has been a great deal of turbulence in defense acquisition policy. This has led to confusion within the acquisition workforce over the major policy thrusts, terminology, and unobvious implications of the changes. The new acquisition framework has added complexity, with more phases and delineations of activity -- and both the number and level of decision reviews have been increased. Decision reviews are typically used as top management level control gates, and are also a feature of centralized control within a bureaucracy. Although the current stated policy is to foster an environment supporting flexibility and innovation, the new framework will cause Program Managers to devote more time and other resources managing the decision bureaucracy. Moreover, the implicit aspects of the still new model have not been fully realized, and may result in policy that actually lengthens programs and delivers yesterday's technology tomorrow -- counter to goals of rapid transformation. The framework, and its associated requirements for senior level reviews, are opposed to the rapid and evolutionary policy espoused, and are counter to appropriate management strategies for a transformational era.

Acknowledgements

Special thanks go to Erik Jansen, Ph.D., who introduced me to a conceptual framework of organizational theory, which made this comparative analysis for me one of growth and understanding. Too often in the field of acquisition, we ignore the theoretical basis and history of the ideas and changes we so readily adopt. Dr. Jansen's resources helped me balance my inquiry with what I thought I knew.

Thanks as well go to RADM (Ret) Jim Greene and Dr. David Lamm, who secured the sponsor funding to make this effort possible, and encouraging our faculty to continue their growth.

About the Author

John T. Dillard is a Senior Lecturer within the Acquisition Faculty of the Graduate School of Business and Public Policy at the U.S. Naval Postgraduate School. He joined the NPS faculty in the fall of 2000 upon his retirement from the U.S. Army at the rank of Colonel. He has extensive experience in the fields of systems development, procurement and acquisition education. His research focuses on defense acquisition policy changes and their implications, and he manages the Advanced Acquisition Program.

John began his career in program and contract management after attaining a Masters Degree in Systems Management from the University of Southern California in 1985. He was initially assigned as manager of Close Combat Systems at Picatinny Arsenal, New Jersey, and worked across a myriad of technologies and system concepts that have evolved into fielded products, such as the M-4 Carbine, 120mm Mortar, and Sniper Weapon. Subsequent positions were as Assistant Project Manager for Development of both the Army Tactical Missile System and later the JAVELIN Antitank Weapon System at Redstone Arsenal, Alabama. These systems incorporate state-of-the-art technologies, and are in sustained production and fielding. Both systems have also been proven to be highly effective in combat.

In 1992, he was selected to be the Product Manager for the Joint Advanced Special Operations Radio System, at Fort Monmouth, New Jersey and successfully completed a three-year prototyping effort on time and under budget. In 1998, he was appointed to head of all Defense Department contract administration in the New York metropolitan area. His organization won the President's Quality Award – the federal government's equivalent to the Malcolm Baldrige Award for Quality, and held the title for the next two years.

He has attended the Army's Command and General Staff College at Fort Leavenworth, KS, the Defense Systems Management College at Fort Belvoir, VA, and the U.S. Army War College at Carlisle, PA. He also served on the faculty of the U.S. Army War College, where he taught graduate-level courses in Systems Acquisition Management to U.S. government military and civilian personnel of all services and several agencies and allied nations.

He has consulted for the governments of Mexico and the Czech Republic, and lectured for the American Society for Quality on achieving excellence in the public sector. As an adjunct professor for the University of California at Santa Cruz, he teaches courses in project management to Silicon Valley public and private industry professionals.

Table of Contents

Introduction	1
The Challenges of Defense Program Management	6
Organizational Control Theory and Defense Acquisition	10
An Examination of Program Management Life Cycle Models	14
Project Management Institute	14
Construction Projects	16
Pharmaceutical Projects	18
Software Projects	20
Systems Engineering Within Development Projects	22
An Examination of The Evolving Defense Acquisition Framework	25
The 1987 Model	26
The 1991 Model	28
The 1996 Model	29
The 2000 Model	31
The Interim 2002 Model	34
The Current 2003 Model	36
Understanding the Implicit Aspects of the Post-2000-Era Models	38
Number and Level of Milestone and Program Decision Reviews	38
Program Initiation Moves Further to the Right	43
Technological Maturity before Program Commitment	45
Funding Implications	47
The Significance of Milestone C, and IOT&E after the LRIP Decision	49
Impact upon the Requirements Generation System	50
Centralized Control of Defense Acquisition Programs	53
Conclusions	58
List of References	61

**Centralized Control of Defense Acquisition Programs:
A Comparative Review of the Framework from 1987 - 2003**

29 September 2003

by

John T. Dillard

Disclaimer: The views represented in this report are those of the author and do not reflect the official policy position of the Navy, the Department of Defense, or the Federal Government.

Intentionally left blank

Introduction

The issuance of Department of Defense Directive 5000.1¹ and Instruction 5000.2² on May 12, 2003, is the third significant revision of acquisition policy in as many years. Looking further back, these three revisions of regulatory guidance had evolved from two previous versions in 1991³ and 1996⁴. Each had its major thrusts and tenets, and perhaps of most importance to Program Managers, modifications to the “Defense Systems Acquisition Management Process”⁵ or “Defense Acquisition Framework”⁶ which is the broad paradigm of phases and milestone reviews in the life of an acquisition program. The purpose of this research is to examine the evolution of this framework and draw attention to the explicit and implicit aspects of recent changes to the various models to better understand its current form.

This latest version of the 5000 series was actually drafted in the documents rescinding its predecessor. According to his memorandum signed on October 30, 2002, Deputy Secretary of Defense Paul Wolfowitz said the series required revision “to create an acquisition policy environment that fosters efficiency, flexibility, creativity and innovation.”⁷ Interim guidance was issued, along with the rescission of the series, as a temporary replacement, outlining principles and policies to govern the operation of the new Defense acquisition system. Among them:

3.1 Responsibility for acquisition of systems *shall be decentralized to the maximum extent practicable* (emphasis mine).

¹ USD(AT&L) Department of Defense Directive 5000.1, *The Defense Acquisition System*, May 12, 2003.

² USD(AT&L) Department of Defense Instruction 5000.2, *Operation of the Defense Acquisition System*, May 12, 2003.

³ USD(A) Department of Defense Directive 5000.1, *The Defense Acquisition System*, February 23, 1991.

⁴ USD(A&T) Department of Defense Directive 5000.1, *Defense Acquisition*, March 15, 1996.

⁵ Defense Systems Acquisition Management Process, Defense Systems Management College, January 1997.

⁶ Defense Acquisition Framework, Defense Systems Management College, 2001.

⁷ Wolfowitz, Paul, Memorandum for Director, Washington Headquarters Services, *Cancellation of DoD 5000 Defense Acquisition Policy Documents*, October 30, 2002.

3.18 The PM shall be *the single point of accountability* (emphasis mine). for accomplishment of program objectives for total life cycle systems management, including sustainment.

3.27 It shall be DoD policy to *minimize reporting requirements* (emphasis mine). Nevertheless, complete and current program information is essential to the acquisition process. Consistent with the tables of required regulatory and statutory information appearing in reference, decision authorities shall require PMs and other participants in the defense acquisition process to present only the *minimum information necessary* (emphasis mine). to understand program status and make informed decisions.⁸

During the period between rescission and re-issuance of the regulatory guidance, DoD officials said discussions revolved around changes to give program managers more latitude to be innovative in applying concepts like evolutionary acquisition, and relieving them of the constraints of an overly prescriptive policy:

Less prescriptive 5000-series documents could also enhance program managers' abilities to use their experience, best business practices and innovation "to structure and execute a program in a manner best suited to its particular circumstances....

...The old way of doing business 'was too focused on process vs. outcomes.' Instead of telling [program managers] they have to satisfy a requirement in a certain way, now we're [saying]: 'Here's the requirement; you know your program, do what best suits the particular conditions of your program but meet the requirement.' The new guidelines will put the full weight of OSD policy behind creative program managers who in the past likely would be constrained by the Pentagon bureaucracy by making them operate according to rules that may not be necessary to achieve a desired outcome...⁹

⁸ Secretary of Defense Memorandum, *Defense Acquisition*, Attachment 1, *The Defense Acquisition System*, October 30, 2002, (Interim Guidance 5000.1, p. 6).

⁹ Costa, Keith J., "5000.2 Changes Await Approval," *Inside The Pentagon*, January 16, 2003.

Paramount in the objectives of the new policy is improved warfighting capability from projects and programs that are well managed. A well managed project is generally considered to be one that is optimized for effectiveness in its planning phases but emphasizes efficiency in its implementation phases, that include commissioning, startup and close out.”¹⁰ To this could also be added “...and, in the eyes of the customer, is perceived as satisfactory in use,” or in defense terms--operational effectiveness and suitability.

Beyond the business aspects of program management, measurement of system effectiveness and suitability are the principal test objectives sought from full operational testing late in the life of most projects, and just before deployment of the program’s products to the warfighting force. Operational effectiveness and suitability are the key success indicators by which the product will ultimately be judged, if not against which decisions can be taken during the project. However, efficiency in cost and schedule still predominate as the more apparent and quantifiable measures of project success prior to full operational assessment.

The current policy makes clear that it is the Milestone Decision Authority – not the Program Manager – who is responsible for the overall program:

3.4 The Milestone Decision Authority (MDA) is the designated individual with *overall responsibility for a program* (emphasis mine). The MDA shall have the authority to approve entry of an acquisition program into the next phase of the acquisition process and shall be accountable for cost, schedule, and performance reporting to higher authority, including Congressional reporting.

3.5 The Program Manager (PM) is the designated individual with responsibility for and authority to accomplish program objectives for development, production, and sustainment to meet the user’s operational needs. *The PM shall be accountable for credible cost, schedule, and performance reporting to the MDA* (emphasis mine).

¹⁰ Project Management Guidelines (Private BC Corporation), 1995, Wideman Comparative Glossary of Project Management Terms v3.1, 2002.

4.3.5 Streamlined and Effective Management. Responsibility for the acquisition of systems shall be decentralized to the maximum extent practicable. The MDA shall provide *a single individual with sufficient authority* (emphasis mine) to accomplish MDA-approved program objectives for development, production, and sustainment. The MDA shall ensure accountability and maximize credibility in cost, schedule, and performance reporting.¹¹

It is also clear that together, the Program Manager and Milestone Decision Authority share responsibility for development and oversight of the program:

4.3.1 Flexibility. There is no *one* best way to structure an acquisition program to accomplish the objective of the Defense Acquisition System. MDAs and PMs shall tailor program strategies and oversight, including documentation of program information, acquisition phases, the timing and scope of decision reviews, and decision levels, to fit the particular conditions of that program, consistent with applicable laws and regulations and the time-sensitivity of the capability need.¹²

Though the 5000 series provides guidance for all levels, or Acquisition Categories (ACAT), of programs, its language is particularly applicable to the largest, ACAT I, Major Defense Acquisition Programs (MDAP). In such cases, the MDA is the Defense Acquisition Executive, who also chairs the Defense Acquisition Board (DAB) as a decision making body for program milestone reviews. And while the wording above might indicate that the MDA and PM jointly plan or collaborate in some way on program strategy, there are in fact both a Component Acquisition Executive and Program Executive Officer in the hierarchy between them, and direct communication between MDA and PM is infrequent. Other top management stakeholders are OSD staff principals who sit in membership on the Defense Acquisition Board, where milestone decision reviews are conducted. Communication between PM and OSD staff principals is more frequent, especially via the Overarching Integrated Product Team process.¹³

¹¹ USD(AT&L) Department of Defense Directive 5000.1, *The Defense Acquisition System*, May 12, 2003.

¹² Ibid.

¹³ Office of the Under Secretary of Defense (Acquisition and Technology) Washington, DC 20301-3000 DoD Integrated Product and Process Development Handbook, August 1998.

The very latest DoD 5000 policy changes have come during a time of DoD Transformation, which, while larger in scope than solely equipment and technology, is chiefly focused on changes to force structure and weapons employment capabilities. The DoD uses three Decision Support Systems to manage weapons modernization via requirements generation, resource allocation and acquisition of systems (The Joint Capabilities Integration and Development System, Planning, Programming Budgeting and Execution process, and the Defense Acquisition System, respectively). Change, to a greater and lesser degree, is occurring in all three systems to facilitate the transformational era. These process changes require re-education and adaptation by all involved in them for proper implementation, and are in all cases significant. This study considers only changes to the Defense Acquisition System *framework* and its use as a decision making tool.

The Challenges of Defense Program Management

Defense systems in particular, known for their size and technological pursuits, are seen as among the most challenging of projects. Gadeken, building upon previous studies at the Defense Systems Management College, et al., concluded that the Project Manager competency of systematic and innovative thinking were among the most needed and critical in order to accommodate growing complexities.¹⁴

Program Managers and policy makers have long realized that of these three Decision Support Systems available to the DoD, two of them are fittingly event-based, but one (PPBE) is calendar-driven by congressional authorization and appropriation. While any project requires the accurate estimation of costs and time to execute, the annual cycle of PPBE necessitates the total forecasting of annually incremented program resources for the near and far term, and across multiple “colors of money.” It is this same system that has long been blamed for instability in DoD programs, as high level adjustments are made each year that trickle down to programs in the form of decrements.¹⁵

Inherent difficulty in the management of any program is exacerbated for the DoD by several additional factors, which have become even more apparent in the last twenty years. Large defense systems are very complex systems, consisting of hardware and software, multiple suppliers, etc. and requiring design approaches that can alleviate complexity via decomposition into simpler subsets, etc. Rapid technology changes, yielding obsolescence, have become particularly problematic for very large systems with acquisition life cycles spanning a long period of time. Thus, it may not even be

¹⁴ Gadeken, Owen C., “Project Managers as Leaders – Competencies of Top Performers,” *RD&A*, January – February 1997.

¹⁵ Johnson, Stuart, Libicki, Martin C. and Treverton, Gregory F., *New Challenges New Tools for Defense Decisionmaking*, Rand, 2003.

feasible to fully define the operational capabilities and functional characteristics of the entire system before commencing advanced development.¹⁶

A series of influential GAO reports on defense acquisition from 1996 through 2002 concluded that the DoD had repeatedly spent more time and money than originally planned on weapon systems, and urged that the Department:

- Carefully assess technology¹⁷ and separate its development from product (advanced) development (i.e. mature the candidate technologies before commitment to advanced development)¹⁸
- Move to a “knowledge-based” approach, to learn more about a design’s capability to satisfy requirements and a prototype’s ability to be manufactured, earlier in the process.¹⁹
- Change the environment to allow PMs to identify unknowns as high risks without suffering criticism and loss of support.²⁰

The DoD 5000 series acknowledges these many complexities and difficulties facing MDAs and PMs in their management and oversight of large weapon system developments. An approach to mitigate these technological challenges, especially in the post-2000 series, is evolutionary acquisition, referred to by some outside of DoD as progressive acquisition. Also advocated by the General Accounting Office, it has evolved worldwide as a concept over the past two decades. It is an incremental development approach, using iterative development cycles versus a single grand design. Described succinctly by the Western European Armaments Group, the progressive acquisition approach is:

¹⁶ Pitette, Giles, “Progressive Acquisition and the RUP: Comparing and Combining Iterative Process for Acquisition and Software Development,” *The Rational Edge*, November 2001.

¹⁷ GAO, “Joint Strike Fighter Acquisition – Mature Technologies Needed to Reduce Risks,” 02-39, October 2001.

¹⁸ GAO, “Better Management of Technology Development Can Improve Weapon System Outcomes,” NSIAD-99-162, July 1999.

¹⁹ GAO, “Best Practices – Capturing Design and Manufacturing Knowledge Early Improves Acquisition Outcomes,” 02-701, July 2002.

a strategy to acquire a large and complex system, which is expected to change over its lifecycle. The final system is obtained by upgrades of system capability through a series of operational increments. (It) aims to minimize many of the risks associated with the length and size of the development, as well as requirements volatility and evolution of technology.²¹

Pittete explains further:

An essential goal of (progressive acquisition) is the rapid fielding of a usable system that not only addresses an initial and validated statement of needs, but also anticipates iterative upgrades of system capability as development progresses through a series of increments. Each successive increment yields an operational version of the system that meets a pre-specified subset of the overall system requirements.

Continuous user feedback based on previously fielded increments is an essential element of the approach. It may significantly influence the definition and development of later increments. In the same way, technology updates may be accommodated across increments, reflecting the evolution or obsolescence of hardware and software items, including commercial off-the-shelf products.

This approach continues *until the final system configuration is achieved*.²²

Very similar in description, DoD's adaptation of this approach as "evolutionary acquisition" is a major policy thrust in the series, and is the stated "preferred approach" toward all new system developments. It is described most fully in DoDI 5000.2:

3.3 Evolutionary Acquisition is the preferred DoD strategy for rapid acquisition of mature technology for the user. An evolutionary approach delivers capability in increments, recognizing, up front, the need for future capability improvements. The objective is to balance needs and available capability with resources, and to put capability into the hands of the user quickly. The success of the strategy depends on consistent and

²⁰ GAO, "Successful Application to Weapon Acquisitions Requires Changes in DoD's Environment," NSIAD-98-56, February 1998.

²¹ Western European Armaments Group WEAG TA-13 Acquisition Programme, Guidance on the Use of Progressive Acquisition, Version 2, November 2000.

²² Pitette, Giles, "Progressive Acquisition and the RUP: Comparing and Combining Iterative Process for Acquisition and Software Development," *The Rational Edge*, November 2001.

continuous definition of requirements, and the maturation of technologies that lead to disciplined development and production of systems that provide increasing capability towards a materiel concept.²³

This particular policy thrust is important to this study as it pertains to the framework of phases and decision reviews of a program moving toward completion. It is meant to change the way programs are structured and products delivered. – actually separating projects into smaller, less complex increments. It is, additionally, one of several aspects of the new policy that affect the framework and its use as a management control mechanism.

²³ USD(AT&L) Department of Defense Instruction 5000.2, *Operation of the Defense Acquisition System*, May 12, 2003.

Organizational Control Theory and Defense Acquisition

Sylvester and Ferrara provided an insightful view of the organizational struggle within OSD to adopt the evolutionary acquisition policy.²⁴ Evolutionary acquisition can even be viewed as analogous to these authors' iterative approach to policy implementation via "muddling through" – (i.e. successive limited comparisons) versus using a more comprehensive "grand design" approach.²⁵ Perhaps most impressive in this paper is the intra-organizational complexities and diverse interests that are revealed, and in the authors' assertions that policy ambiguity and organizational conflict are not necessarily counterproductive. They further describe in some detail the distribution of power affecting weapon system acquisitions among stakeholders outside of DoD (i.e. Congress and the defense industry) as well as within (i.e. Joint Requirements Oversight Council (JROC), and Director of Operational Test & Evaluation DOT&E), Comptroller, etc.). Vital to the interests of many is the need for bureaucratic control over the acquisition process. As others have observed through recent decades, each of these powerful stakeholders perceives and "exercises an oversight responsibility to ensure that laws and regulations are observed and programs pursued efficiently."²⁶

Wideman also advocated progressive (evolutionary) acquisition, and recognized senior management responsibility for financial accountability in private and public projects and their preference for central control. He noted three problems with senior management control over complex developments such as software enterprises like

²⁴ Sylvester, Richard K. and Ferrara, Joseph A., *Conflict And Ambiguity Implementing Evolutionary Acquisition*, Acquisition Review Quarterly - Winter 2003.

²⁵ Lindblom, C. E. (1959). The Science of Muddling Through, *Public Administration Review*, 19 (Spring), (Reprinted in *Perspectives on Public Bureaucracy* (2nd ed.), pp. 132-150, by F. A. Kramer (Ed.), 1977, Cambridge, Massachusetts: Winthrop Publishers).

²⁶ Fox, J. Ronald, *The Defense Management Challenge: Weapons Acquisition*, Harvard Business School Press, 1988.

Defense Information Systems, even when projects were not particularly large or lengthy. He suggested that the acquiring authority or sponsor:

- Has difficulty staying abreast of ongoing developmental efforts
- Is not technically prepared for the dynamics of project changes
- Has too large a span of control to effectively manage locally

Thus, he suggests that, as a minimum, better means of communicating are required to serve both the needs of developer and sponsor.²⁷

The above observations in large, complex programs align with classic contingency theory, which holds that organizational structures must change in response to contingencies of size, technology, and as external environments become more complex and dynamic. Indeed, it has long been accepted that when faced with uncertainty (a situation with less information than is needed) the management response must either be to redesign the organization for the task at hand, or improve communication flows and processing.²⁸ Van Creveld applies this same principle to command and control of combat elements in war, stating that the command structure must either create a greater demand for information (vertically, horizontally, or both) and increase the size and complexity of the directing organ, or enable the local forces to deal with the situation semi-independently. His central theme is that decentralized control is the superior method of dealing with uncertainty, whether with the task at hand or with transformation of the organization itself.²⁹

Research by Van de Ven and Delbecq has further shown that as complexity and uncertainty increase, hierarchical management control strategies are less favored than adaptation to less formal and horizontal communication channels, and the effectiveness

²⁷ Wideman, R. Max, *Progressive Acquisition and the RUP Part I: Defining the Problem and Common Terminology*, The Rational Edge, 2002.

²⁸ Galbraith, J. R., 1973, *Designing Complex Organization*, Reading, Massachusetts: Addison-Wesley.

²⁹ Van Creveld, Martin, *Command in War*, Harvard University Press, 1985.

of formal controls becomes less effective.³⁰ To continue discussion of management control as it might relate to defense acquisition, we should perhaps next consider organizations and their environments in very broad terms.

Gareth Morgan traced organizational theory through the past century and depicts organizations as a variety of images, or metaphors in his treatise, *Images of Organization*. He claims these “images” of organizations are actually metaphors, much like our graphic depictions of projects, and uses the machine, the organism, the brain, and others to illustrate approaches to organization. He describes many large and complex organizations structured as machine bureaucracies, with routinized processes of administration the way a machine routinizes production. He discusses at length how well the machine bureaucracy fit Western society organizations in the period of industrialization, particularly under conditions of straightforward tasks, a predictable and stable environment, and where precision, efficiency and compliance were desired. He also notes today’s transition from industrial age to information age, with its accompanying implications of rapid change and turbulence. He warns that large hierarchical, mechanistic organizational forms have difficulty adapting to change and are not designed for innovation:

The machine bureaucracy and the divisionalized form tend to be ineffective except under conditions where tasks and environment are simple and stable. Their highly centralized systems of control tend to make them slow and ineffective in dealing with changing circumstances. While appropriate for firms that are production driven, they are often inappropriate for firms that are market or environment driven.³¹

Another classical concept of organizational theory is Ashby’s Law of Requisite Variety, which states that the internal regulatory mechanisms of a system must be as diverse as its environment in order to cope with the variety of challenges imposed by it. Moreover, organizational evolution and survival are dependent upon it, and capacities

³⁰ Delbecq, André L., Van de Ven, Andrew and Gustafson, David, *Group Techniques for Program Planning*, 2nd edition, Greenbriar Press, Madison, Wisconsin, 1986.

³¹ Morgan, Gareth, 1997, *Images of Organization*, Sage Publications.

are enhanced when variety is built at the point of interaction with the environment.³² This too suggests that the organization's structure and control strategy must be matched to its environment to enhance performance, and that open and flexible styles and processes of management are required for dynamic market and technological conditions. Further research by Burrell and Morgan indicate that any incongruence among management processes and the organization's environment tend to reduce organizational effectiveness.³³

In their book, *The Intelligent Organization*, Gifford & Elizabeth Pinchot make an even stronger case for decentralized management in large complex organizations faced with transformational change. They suggest that as organizations today face increasing complexity, rapidity of change, distributed information, and new forms of competition, organizations must grow more intelligent to confront and defeat the diverse and simultaneous challenges. They posit that for an organization to be fully intelligent, it must use the intelligence of its members all the way down the hierarchy. They note that with distributed information there is distributed intelligence, and failure to render authority to those closest to the problem will yield lethargy, mediocre performance, or worse – paralysis. Control will be maintained, and anarchy will not occur -- but neither will success.³⁴

What the cumulative research appears to support is that, for large complex hierarchies such as the Department of Defense, decentralized control and empowerment should be an organizational strength, given today's environment of program complexity, evolving requirements, and rapidly changing technology.

³² Ashby, W. R., *An Introduction to Cybernetics*, London: Chapman & Hall, 1960.

³³ Morgan, Gareth, 1997, *Images of Organization*, Sage Publications.

³⁴ Pinchot, Gifford and Elizabeth, *The End of Bureaucracy and the Rise of the Intelligent Organization*. Berrett-Koehler Publishers, San Francisco, 1993.

An Examination of Project Management Life Cycle Models

Models have long been used to illustrate the integration of functional efforts across the timeline of a project or program. It is the successful integration of these diverse elements that is the very essence of project management. Models also help us to visualize the total scope of a project and “see” its division into phases and decision points. The interaction and overlapping of many and varied activities such as planning, engineering, test and evaluation, logistics, manufacturing, etc. must be adroitly managed for optimum attainment of project cost, schedule and technical performance outcomes.

Project Management Institute

The Project Management Institute’s Project Management Body of Knowledge (PMBOK®) provides generally accepted knowledge and practices in the broad field of project management.³⁵ Striving for commonality across diverse business areas and product commodities, it provides a generic framework as a structure for understanding the management of a project or program. In the figure below (Fig. 1.), a project life cycle is depicted as costs and staffing relative to time.

³⁵ Project Management Institute, *A Guide to the Project Management Body of Knowledge (PMBOK® Guide)*, 2000 Edition, Pennsylvania, 2000.

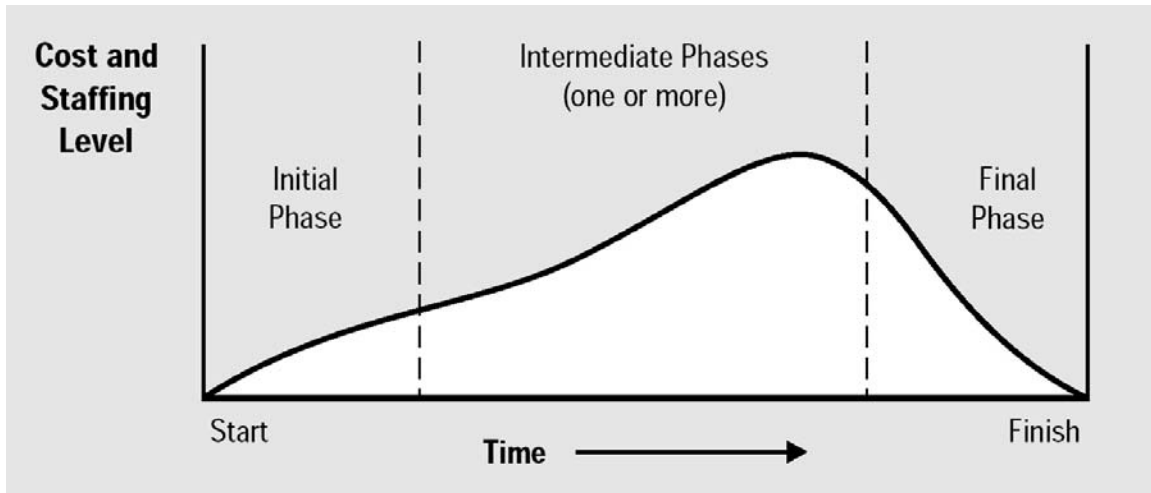

Fig. 1. Sample Generic Project Life Cycle, Adapted from PMBOK® 2000

Project Management difficulty climbs along the scale of system complexity and technological uncertainty, and is simplified by division of the effort into phases, with points between for management review and decision.

Because projects are unique undertakings, they involve a degree of uncertainty. Organizations performing projects will usually divide each project into several *project phases* to provide better management control and appropriate links to the ongoing operations of the performing organization. Collectively, the project phases are known as the *project life cycle*....

...Each project phase normally includes a set of defined work products designed to *establish the desired level of management control* (emphasis mine).

The conclusion of a project phase is generally marked by a review of both key deliverables and project performance in order to (a) determine if the project should continue into its next phase and (b) detect and correct errors cost effectively. These phase-end reviews are often called *phase exits, stage gates, or kill points*.³⁶

The institute acknowledges a variety of approaches to modeling project life cycles, with some so detailed that they actually become management methodologies.

³⁶ Project Management Institute, *A Guide to the Project Management Body of Knowledge (PMBOK® Guide)*, 2000 Edition, Pennsylvania, 2000.

Illustration of generic project management processes or activities across time are depicted thus (Fig.2.):

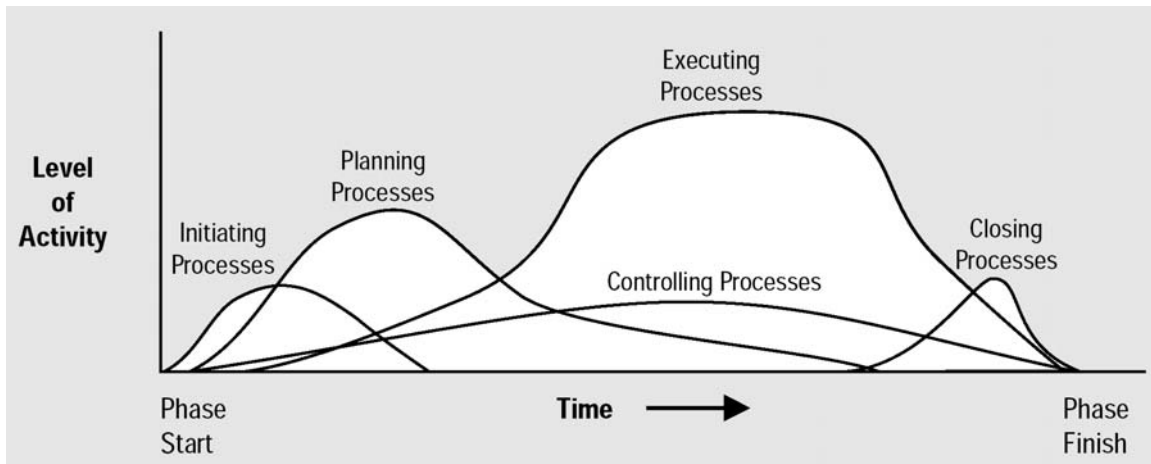

Fig. 2. Project Management Processes, Adapted from PMBOK® 2000³⁷

Of particular note in this model is the delineation of distinct yet overlapping processes, across a project or within phases, to initiate, plan, execute, control, and eventually close the phase or project. The PMBOK® provides examples of how various industry business areas model their “acquisition” process. A glimpse into the project models of other types of enterprises may serve for edification and to provide some other perspectives for viewing the continually evolving Department of Defense model.

Construction Projects

In the construction industry (Fig. 3.) a project is represented by four main phases (stages):

³⁷ Ibid.

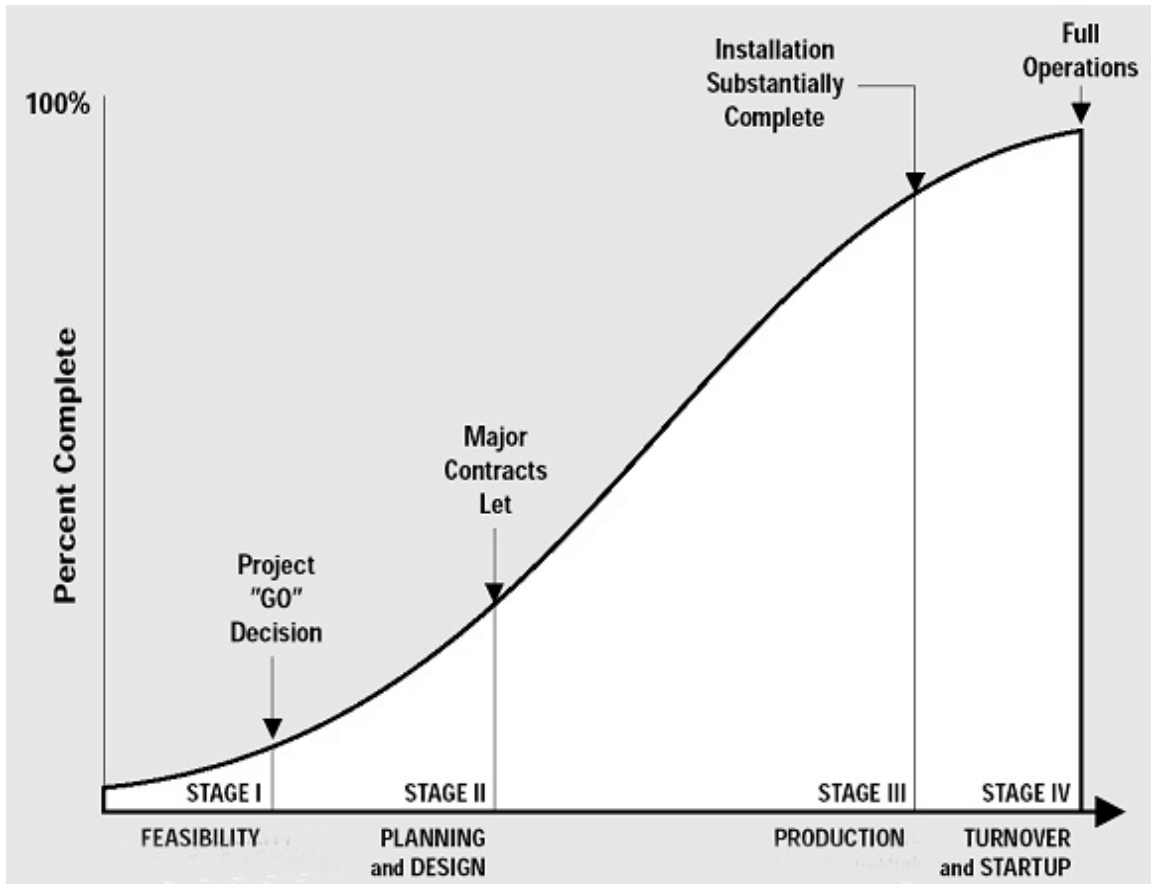

Fig. 3. Representative Construction Project Life Cycle, Adapted from PMBOK® 2000³⁸

Feasibility Stage – In this first phase, projects are formulated, feasibility studies are conducted, and an overall project strategy is designed and approved by a sponsor. Then, a go/no-go decision is made at the end of this phase to proceed.

Planning and Design Stage – The base (preliminary) design is completed, cost and schedule are fully estimated, contract terms and conditions are defined, and further detailed planning is conducted. Major contracts are awarded to performing organizations at the end of this phase.

Production Stage – The manufacturing, delivery, civil works, installation, and testing are conducted such that the facility is substantially complete at the end of this phase.

³⁸ Ibid.

Turnover and Start-up Stage - Final testing and maintenance occur in this phase. The facility becomes fully operational at the end of this phase.

Civil construction is typically viewed as being on the relatively low side of risk and complexity, though several building or highway projects have become highly profiled when large overruns have occurred. The Denver Airport and Boston Central Artery/Tunnel projects prove that underestimates of project difficulty are not peculiar to the Department of Defense. In fact, a study of almost 600 projects across twenty-five public and private business areas revealed that DoD weapon system project cost growth variances ranked in the lower half of the population sample.³⁹ Note that in this model, the planned work effort is actually quantified on the vertical axis of the model, similar to what would be found on an earned value management diagram as budgeted cost of work scheduled.

Pharmaceutical Projects

The Food and Drug Administration model is shown below to represent projects within the pharmaceutical industry. Pharmaceutical endeavor is actually believed by some to be more analogous to the DoD acquisition enterprise -- with its orientation upon emerging technology for new treatment options, graduated levels of testing, and strict regulatory requirements for approval. Human lives may actually be at stake as well. The magnitude of effort in terms of costs and time is similar to many DoD projects, with average time from applied research to market being about ten years and an average investment of \$897 million per new investigational drug.⁴⁰

The framework (Fig. 4.) also employs a highly controlled testing and approval process for prove-out of safety and efficacy (similar to DoD's operational suitability and effectiveness.) In both processes, government funded research contributes to advancement of the science through basic research. However, unlike today's weapon

³⁹ Blery, F., Cost Growth and the Use of Competitive Acquisition Strategies, Journal of the National Estimating Society, Vol. 6, No. 3, Fall 1985.

⁴⁰ Ezzell, Carol, *The Price of Pills*, Scientific American, July 2003.

system acquisition, it is primarily market forces that drive pharmaceutical industry investments and progress through applied research and advanced development.

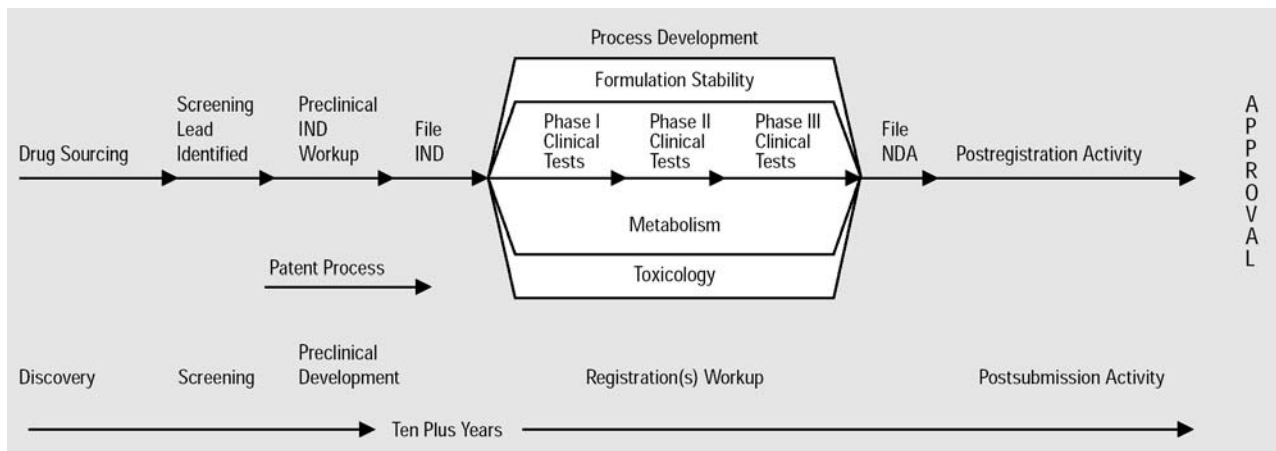

Fig. 4. Representative Pharmaceutical Project Life Cycle, Adapted from PMBOK® 2000

Discovery and Screening Phase - This phase includes basic and applied research to identify candidates for preclinical testing. Market needs are also compared to emerging technology.

Preclinical Development - Laboratory and animal testing is conducted to determine safety and efficacy of the new drug, as well as preparation and filing of an Investigational New Drug (IND) application.

Registration(s) Workup - This phase includes Clinical Phase I, II, and III tests with increasing numbers of human subjects in each sub-phase. Preparation and filing of a New Drug Application (NDA) completes the phase.

Postsubmission Activity - During this period additional work is conducted as required to support Food and Drug Administration review of the NDA to obtain approval. Time in this phase alone has averaged 20 months in the past decade.⁴¹

⁴¹ US Food and Drug Administration Center for Drug Evaluation and Research. <http://www.fda.gov/cder/rdmt/default.htm>, *Approval Times for Priority and Standard NMEs - Calendar Years 1993-2002*, (Updated through 12/31/2002, Posted 1/14/2003).

Post marketing studies (additional clinical research) can also be an extensive effort after FDA approval (similar to Operations and Support Phase in DoD). Recent FDA process reforms have led to fast-tracking initiatives and other rapid approval programs for priority medical needs, all in an effort to reduce the total cycle time of a new drug endeavor.

Software Projects

The software industry, which long used a linear “waterfall” model of development, later adopted a multiple-iteration paradigm of cyclical developments. Muench, et al. describe a spiral model for software development with four cycles and four quadrants (Fig 5.):

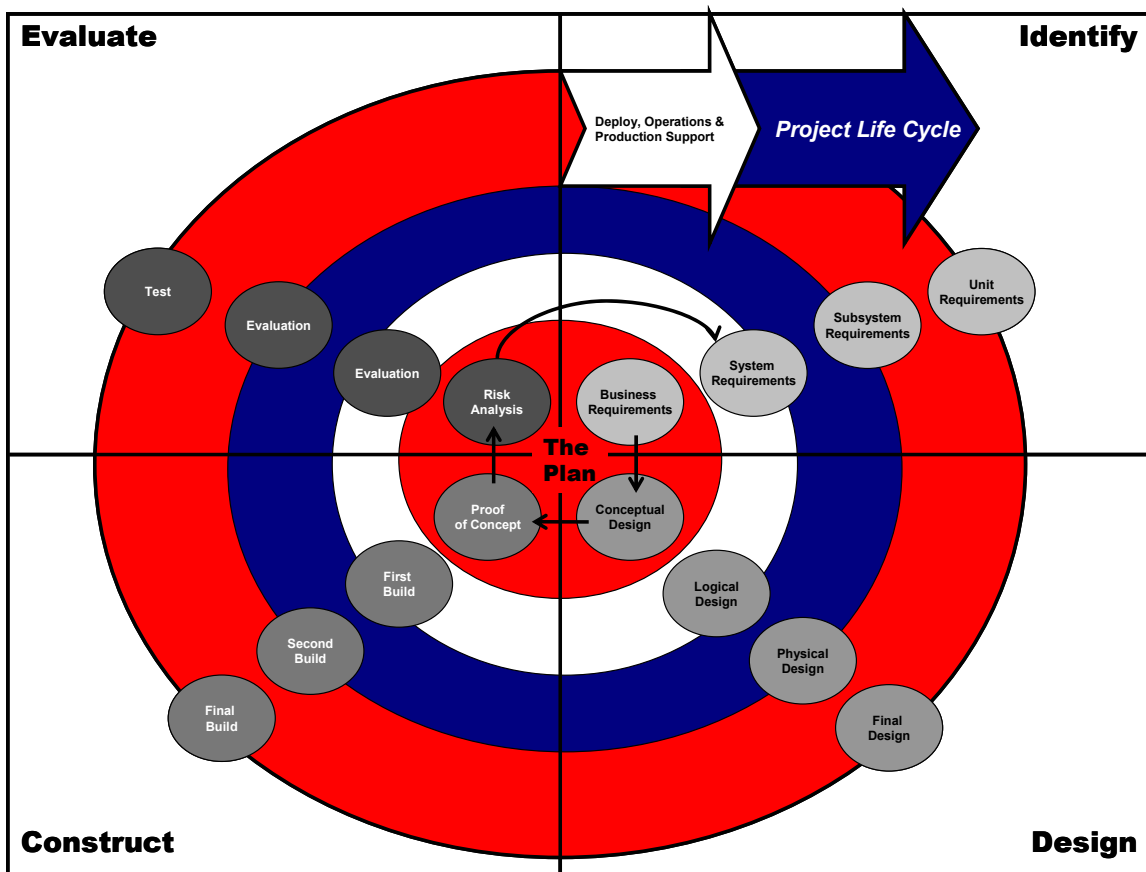

Fig. 5. Representative Software Development Life Cycle, Adapted from PMBOK® 2000

Proof-of-concept cycle – to capture business requirements, define goals for proof-of-concept, produce conceptual system design, design and construct the proof-of-concept, produce acceptance test plans, conduct risk analysis and make recommendations.

First build cycle - derive system requirements, define goals for first build, produce logical system design, design and construct the first build, produce system test plans, evaluate the first build, and make recommendations.

Second build cycle - derive subsystem requirements, define goals for second build, produce physical design, construct the second build, produce system test plans, evaluate the second build and make recommendations.

Final cycle - complete unit requirements, final design, construct final build, perform unit, subsystem, system, and acceptance tests.⁴²

Wideman states that, though the graphical representation of this spiral development does not clearly convey the process, it does convey progress throughout the project life span. And good features of this framework are the constant interplay with the end user, and the enabling of requirements discovery as initial work progresses. Note that in this model, full realization of requirements does not occur until the final build cycle. The process continues until the user is satisfied or until resources are exhausted. Cautions are for the need for discipline at the lowest levels to remain cost and scope conscious, lest cycles be added indefinitely.⁴³

Software has always been unique in that there are no manufacturing costs per se. This affords faster time periods between iterations of development and testing and at less cost than hardware tool-up, component procurement, fabrication and assembly, etc. The spiral software model helped developers to recognize that end users do not

⁴² Muench, Dean, *The Sybase Development Framework*, Sybase, CA, 1994.

⁴³ Wideman, R. Max, *Software Development and Linearity Part 1*, ICFAI PRESS, Projects & Profits, Vancouver, BC, Canada, March 2003.

always fully know their requirements until they see the product in use – something systems engineers have known for a long time.

Systems Engineering Within Development Projects

Defined by the International Council on Systems Engineering (INCOSE):

Systems Engineering is an interdisciplinary approach and means to enable the realization of successful systems. It focuses on defining customer needs and required functionality early in the development cycle, documenting requirements, then proceeding with design synthesis and system validation while considering the complete problem. Systems Engineering integrates all the disciplines and specialty groups into a team effort forming a structured development process that proceeds from concept to production to operation. Systems Engineering considers both the business and the technical needs of all customers with the goal of providing a quality product that meets the user needs.⁴⁴

After years in the defense and aerospace industry, authors Forsberg and Mooz saw developmental project management in a systems engineering sense, as a V-model, decomposing complexity and flowing down requirements on the left side, then integrating technologies and verifying attainment of customer requirements on the right side (Fig 6.).

⁴⁴ International Council on Systems Engineering, <http://www.incose.org/whatis.html>, June 1999.

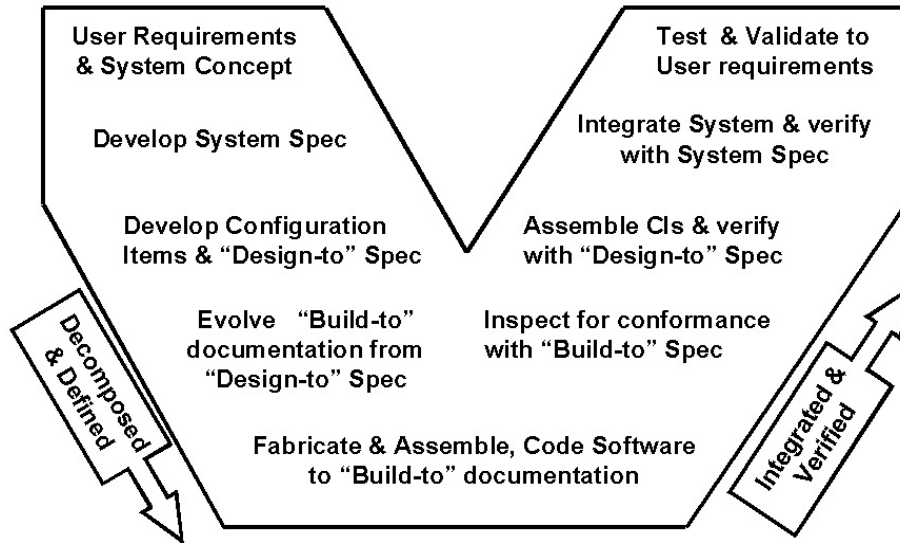

Fig. 6. The “Vee” Model, Adapted from *Visualizing Project Management*⁴⁵

Key in this paradigm or framework is the relationship between sides of the “Vee,” particularly with regard to requirements “traceability,” for functional and physical linkage and accountability throughout development. While most applicable to actual product or advanced development, the model does allow for concurrent activities to exploit the potential for schedule efficiency as well as development iterations for requirements definition and user feedback.

Projects seem to be better visualized with graphic representations or models. They help us reduce complexity and thereby understand it. They can be used, as we will see in the next group of models, to reduce investment risk via investment “exit points” (Mooz calls “control gates”) and to prevent progression beyond the appropriate stage. They help us to delineate and allocate our diverse project management efforts. There are similarities and differences between business areas, with potential for idea sharing. In fact, we have shared much from the spiral software model in order to embrace evolutionary acquisition as a preferred acquisition strategy for weapon systems.

⁴⁵ Forsberg, Kevin, Mooz, M. and Cotterham, H., *Visualizing Project Management*, 2nd Edition, Wiley, 2000.

With some context provided by these previous models we can now briefly examine the evolution of the DoD 5000 series framework with six versions of the project life cycle management model used by DoD over the last sixteen years.

An Examination of the Evolving Defense Acquisition Framework

Models of program structure are important to the Department of Defense in conveying the overall acquisition strategy. According to the Acquisition Strategy Guide, the structure and schedule portion of the acquisition strategy defines:

...the relationship among acquisition phases, decision milestones, solicitations, contract awards, system engineering design reviews, contract deliveries, T&E periods, production releases, and operational deployment objectives. It must describe the phase transitions and the degree of concurrency entailed. It is a visual overview and picture presentation of the acquisition strategy... depicted on an event-driven time line diagram...⁴⁶

Looking back sixteen years there have actually been two “families” of defense acquisition life cycle models or frameworks: Pre-2000-era and Post-2000-era. The first of the Pre-2000-era models to consider here is the *Life Cycle Systems Management Model* used from 1987 until 1991 (Fig. 7.).

⁴⁶ Defense Systems Management College Press, *Acquisition Strategy Guide* (4th Edition), December 1999.

The 1987 Model

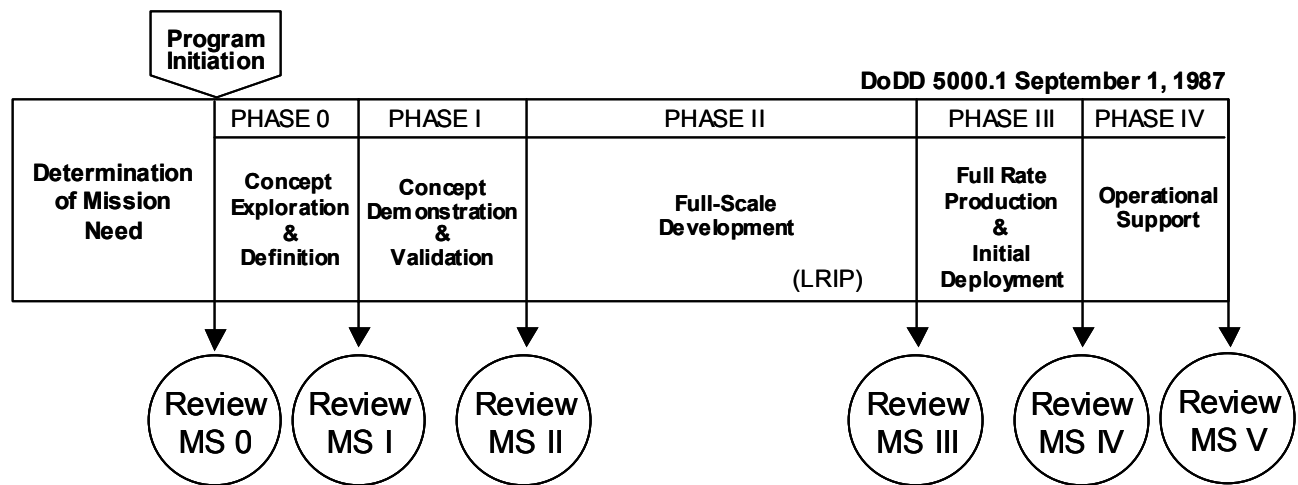

Fig. 7. Life Cycle Systems Management Model

This Life Cycle Systems Management Model consisted of six phases of pre-acquisition and acquisition activity, five key decision points, and an additional decision review optional for major modifications to a fielded system.⁴⁷ It is important to note that not all systems underwent the decision reviews described below:

Milestone 0 Decision - Approval of mission need and program initiation, authority to budget for a new program

Phase 0 - Concept Exploration & Definition Phase – development of an acquisition strategy, concepts to be carried further into the next phase for development, rationale for elimination of other concepts, cost, schedule and operational goals and thresholds established.

Milestone I Decision - Approval to proceed to Demonstration/Validation Phase – key areas of technical risk identified with plans to reduce them before Milestone II.

⁴⁷ Department of Defense Directive 5000.1, *Major and Non-Major Defense Acquisition Programs*, September 1, 1987.

Phase I – Concept Demonstration/Validation Phase – preliminary designs evaluated, experimentation, life cycle cost estimates, formalization of requirements, trade-off analyses, validation of concept for next phase with hardware prototypes, re-assessment of performance risks and plans for thorough testing and evaluation.

Milestone II Decision - Approval to proceed to Full-scale Development – all significant risks have been resolved, technology is in hand to conduct engineering efforts

Phase II - Full-Scale Development Phase – engineering, fabrication and full testing of the system. Low Rate Initial Production usually is shown to occur in this phase.

Milestone III Decision - Approval to proceed to production and initial deployment. In practice, this decision was often divided into IIIA (Low Rate Initial Production) and IIIB (Full Rate Production) reviews, with IIIA frequently delegated to the individual service Secretary.

Phase III – Full Rate Production and Initial Deployment Phase – production and distribution of equipment, and providing of logistical support; product improvements may be introduced.

Milestone IV Decision - A review several years after initial deployment to ensure that operational readiness and support objectives are being achieved.⁴⁸

Phase IV – Operational Support Phase – during which the system is continually operated by end users and logistically supported.

Milestone V Decision – Major upgrade or system replacement as needs might dictate.

⁴⁸ Fox, J. Ronald, The Defense Management Challenge: Weapons Acquisition, Harvard Business School Press, 1988.

The policy provided that systems undergoing this process could be structured by tailoring, with combined phases or exempted from phases of the entire process as appropriate.

The 1991 Model

In 1991, a major revision of the DoD 5000 series was released, with changes to the Life Cycle Systems Management Model.⁴⁹ It simplified its predecessor by lessening reviews and combining phases (Fig. 8.).

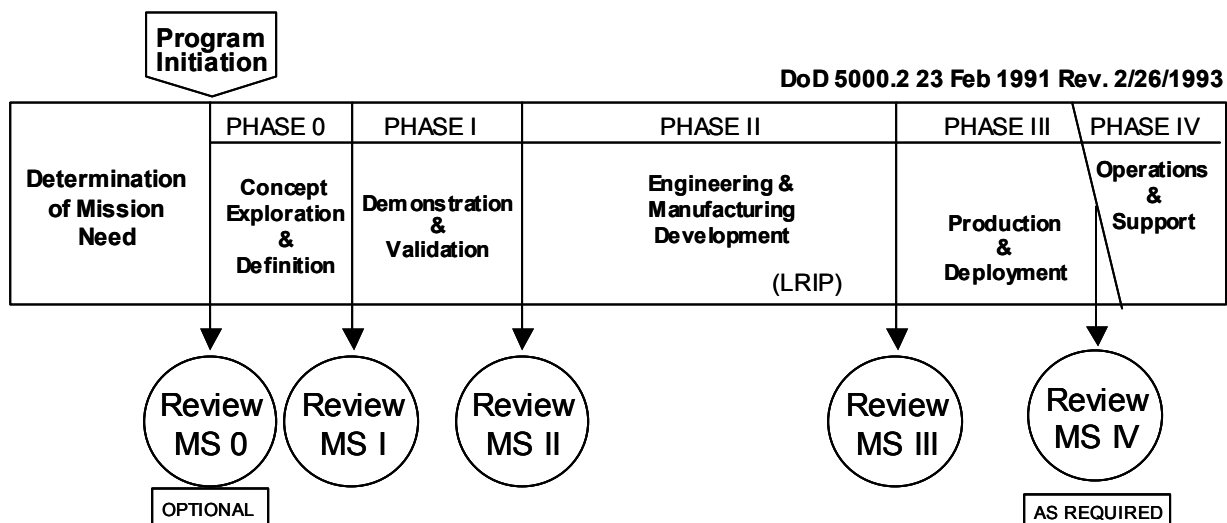

Fig. 8. Defense Acquisition Milestones and Phases

This revision of the framework was not a radical departure from its predecessor. But the “Full-Scale Development” phase was changed to Engineering and Manufacturing Development. Phase IV Operations and Support was shown as an additional, yet not distinctly separate phase.⁵⁰

Determination of Mission Need – not a phase of acquisition but a period of need analysis activities ending with Milestone 0 - Concept Studies Approval and Program Initiation.

⁴⁹ DoD Directive 5000.1, “Defense Acquisition,” February 23, 1991.

⁵⁰ USD(A) Department of Defense Instruction 5000.2, *Defense Acquisition Management Policies and Procedures*, February 23, 1991.

Concept Exploration and Definition Phase – ending with Milestone I - Concept Demonstration Approval.

Demonstration and Validation Phase - ending with Milestone II - Development Approval.

Engineering and Manufacturing Development Phase - ending with Milestone III - Production Approval.

Production and Deployment Phase - overlaps ongoing Operations and Support, and may include Milestone IV decision reviews for Major Modification Approval as required.

The 1996 Model

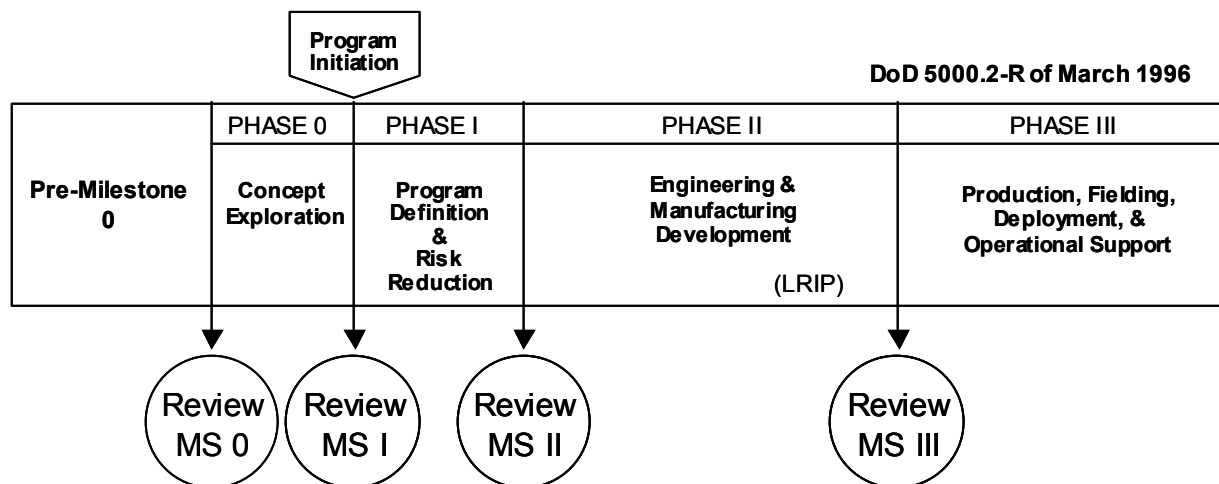

Fig. 9. Defense Systems Acquisition Management Process⁵¹

The 1996 revision of the 5000 series was published after a rigorous effort to reform the defense acquisition system during the first half of the Clinton administration. The model (Fig. 9.) is streamlined and simplified to depict only four phases and four decision reviews. LRIP could occur on either side of Milestone III and frequently did

⁵¹ Department of Defense 5000.2-R, Mandatory Procedures for Major Defense, *Acquisition Programs and Major Automated Information Systems*, 1996.

occur in EMD phase as a service Secretary decision. Demonstration and Validation Phase was renamed Program Definition and Risk Reduction.

Another key change was the very deliberate change in the declaration of Program Initiation moving from Milestone 0 to Milestone I. Program Initiation in this series would mean that a JROC-validated, CAIV-based Operational Requirements Document (ORD) existed, and that cost schedule and performance objectives were defined in an Acquisition Program Baseline, a current threat assessment was conducted, Analysis of Alternatives (AOA) was performed, supportability analysis completed, sufficient life-cycle resources programmed, and that an acquisition strategy was in place. Program Initiation also served as a benchmark of OSD interest in annually reporting to Congress, per 10 USC § 2220(b), the average time period between program initiation and Initial Operational Capability (across all ACAT I programs of any commodity). In 1994, the average was 115 months.⁵²

While the same basic kinds of activities were occurring in each phase of this model as its predecessor (i.e. concept formulation, prototyping, modeling and simulation, advanced development, LRIP, operational testing, etc.), major policy thrusts towards reform were: Integrated Product Process Development (IPPD), program stability, risk assessment and management, total system approach, total ownership costs (TOC), cost as an independent variable (CAIV), program objectives & thresholds, non-traditional acquisition, tailoring, continuous improvement, performance (versus military) standards and specifications, electronic commerce, environmental management, and a host of others.

The 1996 5000 policy series only consisted of DoDD 5000.1 (14 pages) and DoD 5000.2-R (114 pages) as the DODI 5000.2 was eliminated. Regarding program reviews or decision points, the PM in this series was allowed to propose the number and level of decision reviews:

⁵² Ibid.

At program initiation, and after consideration of the views of the Working-Level Integrated Product Team (IPT) and Overarching IPT members, the PM shall propose, and the MDA shall consider for approval, the appropriate milestones, the level of decision for each milestone, and the documentation needed for each milestone. This proposal shall consider the size, complexity, and risk of the program. The determinations made at program initiation shall be reexamined at each milestone in light of then-current program conditions.⁵³

In October of 2000, drafts of an entirely new model began to circulate.

The 2000 Model

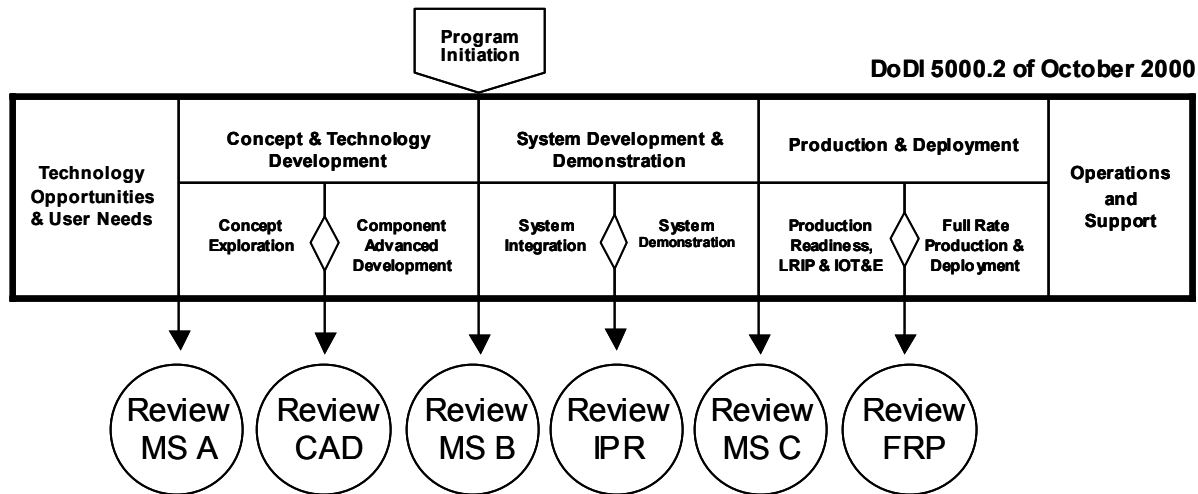

Fig. 10. Defense Acquisition Management Framework⁵⁴

As the Clinton administration was transitioning out in late 2000, the current model appeared (Fig. 10.), along with a revision of the 5000 series. There were major changes from the previous three, largely similar, Pre-2000-era models. Described as “three milestones, four phases,” there are actually eight distinct program activity periods depicted, including the pre-acquisition activities, and a total of six reviews. In addition to the three major milestone reviews usually seen, interim decision and progress reviews had been added within each of the major phases of a program.

⁵³ Ibid.

⁵⁴ USD(AT&L) Department of Defense Instruction 5000.2, *Operation of the Defense Acquisition System*, October 23, 2000.

4.7.3.2.5. Interim Progress Review. The purpose of an interim progress review is to confirm that the program is progressing within the phase as planned or to adjust the plan to better accommodate progress made to date, changed circumstances, or both. If the adjustment involves changing the acquisition strategy, the change must be approved by the MDA. There is no required information necessary for this review other than the information specifically requested by the decision-maker.⁵⁵

However, there was an indication that all of the reviews were not necessary, depending on where a program might enter the model. DoDD 5000.1 said, "Tailoring shall be applied to various aspects of the acquisition system, including program documentation, acquisition phases, the timing and scope of decision reviews, and decision levels. Milestone decision authorities shall promote flexible, tailored approaches to oversight and review based on mutual trust and a program's dollar value, risk, and complexity."⁵⁶

As well, each of the six "work efforts" had its own entrance and exit criteria.⁵⁷

Brief descriptions of each were:

Concept & Technology Development Phase:

Concept Exploration - Paper studies of alternative concepts for meeting a mission need.

Component Advanced Development - Development of subsystems/components that must be demonstrated before integration into a system, and concept/technological demonstration of new system concepts

System Development & Demonstration Phase: to develop a system, reduce program risk, ensure operational supportability, design for producibility, ensure affordability, and demonstrate system integration, interoperability, and utility.

⁵⁵ Ibid.

⁵⁶ USD(AT&L) Department of Defense Directive 5000.1, *The Defense Acquisition System*, October 23, 2000.

⁵⁷ Defense Acquisition University, *DAU Faculty Brief Presentation*, November 2000.

System Integration – for reduction of integration riskThe architecture is complete, now system integration is applied to demonstrated subsystems and components.

System Demonstration – to complete development and demonstrate engineering development models with combined Development and Operational testing.

Production and Deployment Phase:

Production Readiness, LRIP & IOT&E– for Initial Operational Test & Evaluation and Live Fire Test & Evaluation of production representative articles. Manufacturing capability will be verified as LRIP Proceeds.

Full Rate Production & Deployment - where a Beyond LRIP Report may be submitted to Congress and review can take place for Full Rate production. Receiving units will attain full operational capability as deployment of the system continues in this phase.

Operations and Support Phase: operation and support of the system, and possibly block improvements as required.

The first acquisition phase, Concept and Technology Development, appeared to be a combination of the first two phases of the older acquisition model. Or perhaps the Program Definition and Risk Reduction activities were to be split between Concept and Technology Development and System Development and Demonstration phases, depending upon activities planned.

The DoDD 5000.1 iterated strongly that formal recognition of Program Initiation was shifting to the right in this new model, “4.7.2.4.2.2. A favorable Milestone A decision DOES NOT yet mean that a new acquisition program has been initiated.”⁵⁸ Program Initiation was definitely now shown at Milestone B, with status of operational requirement documentation, technological maturity, and resource programming, etc.

⁵⁸ USD(AT&L) Department of Defense Instruction 5000.2, *Operation of the Defense Acquisition System*, October 23, 2000.

commensurate with what had been Milestone I in the 1996 Model. Rationale was provided for this as, “The practical result of a preference for more mature technology is initiation of individual programs at later stages of development, after determination of technology maturity.”⁵⁹

The policy of this series emphasized: science & technology, interoperability, time-phased requirements for evolutionary acquisition, integrated test & evaluation, logistics, transformation, cost as a military requirement, simulation based acquisition and other tenets. With re-emergence of DoD Instruction 5000.2 (46 pages), and the revised DoD Directive 5000.1 (12 pages) and DoD Regulation 5000.2-R (194 pages), the total amount of mandatory guidance totaled 252 pages. However, this new series was to be short-lived, as abrupt cancellation of the series occurred on 30 October 2002.

The Interim 2002 Model

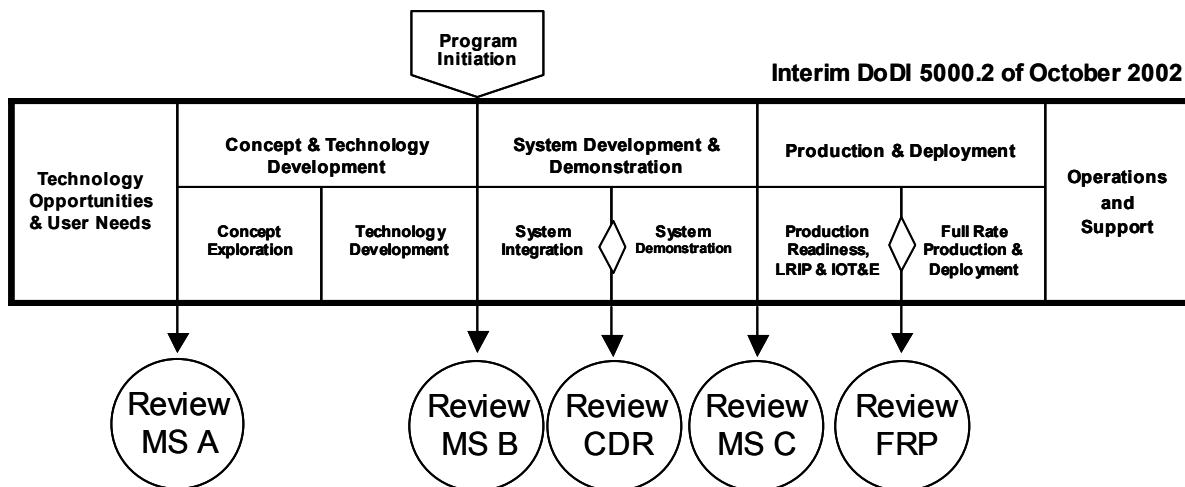

Fig. 11. Defense Acquisition Management Framework⁶⁰

The Deputy Secretary of Defense published a cancellation memorandum that sounded critical of current acquisition policy:

⁵⁹ Ibid.

⁶⁰ Secretary of Defense Memorandum, *Defense Acquisition*, Attachment 2, *Operation of the Defense Acquisition System*, October 30, 2002 (Interim Guidance 5000.2, p. 34).

I have determined that the current DoD Directive 5000.1, “The Defense Acquisition System,” DoD Instruction 5000.2, “The Operation of the Defense Acquisition System,” and DoD 5000.2-R, “Mandatory Procedures for Major Defense Acquisition Programs(MDAPs) and Major Automated Information System (MAIS) Acquisition Programs,” require revision to create an acquisition policy environment that fosters efficiency, flexibility, creativity, and innovation. Therefore, by separate memorandum, I have cancelled these documents effective immediately.

The interim guidance attached to the cancellation memorandum reduced the DoDD 5000.1 document from 12 to 6 pages and the DoDI 5000.2 from 46 to 34 pages. A new set of policy directives and instructions was to be published within 120 days (actually arriving 193 days later).

However, the acquisition model was to a large extent the same as in the 2000 series. The most apparent changes to it were (see Fig. 11.):

- The name of the Component Advanced Development work effort was changed to Technology Development.
- The in-phase decision review between Concept Exploration work effort and Technology Development work effort, both of the Concept & Technology Development Phase, was eliminated.
- The in-phase review in SDD was now defined as the CDR, one of several systems engineering technical reviews normally conducted by the Program Manager – and roundly criticized by the DODIG and GAO for occurring too soon.⁶¹

The cancelled DoD 5000.2-R was also reissued as the Interim Defense Acquisition Guidebook dated Oct 30, 2002, and became discretionary guidance.⁶²

⁶¹ Office of the DoD Inspector General, *The Critical Design Review Process for Major Defense Acquisition Programs*, Audit Report Number 93-017, November 5, 1992.

⁶² Interim Defense Acquisition Guidebook October 30, 2002 (Formerly the DoD 5000.2-R, Dated April 5, 2002).

The Current 2003 Model

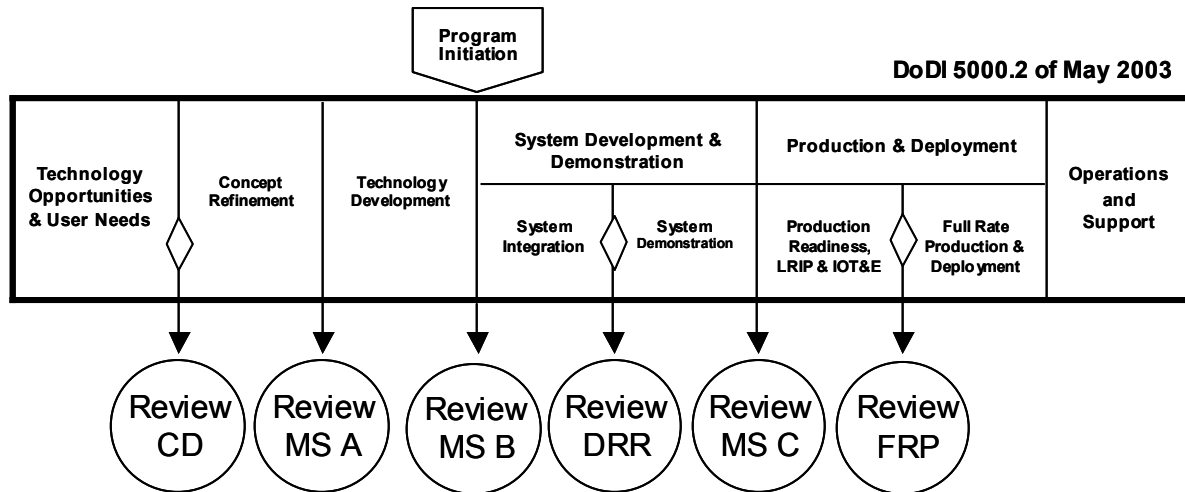

Fig. 12. Defense Acquisition Management Framework⁶³

The current 2003 model (Fig. 12.) has five phases and six potential decision reviews. Eight total distinct activity periods exist in the model, including pre-acquisition activity. The separation of Concept & Technology Development Phase into two phases: Concept Refinement (previously a work effort called Concept Exploration) and Technology Development, also reintroduces a decision review. This time, however, Milestone A shifts to the right between the new phases -- at the entry to the Technology Development phase. And where Milestone A was before is now the point of Concept Decision (CD), which is required for entrance into the Concept Refinement phase.

The entrance and exit criteria for each phase and work effort now incorporate the introduction of new requirements documents from the Joint Capabilities Integration and Development System (which has been evolving in parallel to the acquisition system): the Initial Capabilities Document (ICD), the Capabilities Development Document (CDD), and the Capabilities Production Document (CPD). Interestingly, there has been a large state of flux within this Decision Support System, replete with changes in terminology

⁶³ USD(AT&L) Department of Defense Instruction 5000.2, *Operation of the Defense Acquisition System*, May 12, 2003.

and decision models. The overarching series of instructions governing that requirements generation process has also seen two major revisions in the past three years.⁶⁴

The current 5000 series also includes language on evolutionary acquisition and spiral development taken from the National Defense Authorization Act of 2003. A new requirement for a Technology Development Strategy has been introduced to satisfy Section 803, Public Law 107-314, National Defense Authorization Act for fiscal year 2003. The ICD is a requirement to enter the Concept Refinement Phase and a Technology Development Strategy (TDS) principal output from this phase.

⁶⁴ CJCSM 3170.01 Operation of the Joint Capabilities Integration and Development System, June 24, 2003.

Understanding the Implicit Aspects of the Post-2000-Era Models

Many of the changes from the straightforward Pre-2000-era framework have yet to be realized across the DoD acquisition workforce. Of over 250 students at the GS-13 through 15 level that we have surveyed across two services and four major acquisition commands, the vast majority have been unfamiliar with the most significant changes. Most cannot name from memory the latest phases and milestones.⁶⁵ The shift between the gradually changing 1987-1996 models and the three rapidly changing 2000-era versions has been dramatic. Even without the succeeding adjustments in 2002 and 2003, there are many explicit and implicit aspects to this model that are particularly noteworthy for discussion because of their significant consequences for acquisition managers. The 2000-era and forward DoD 5000 series has promulgated a program framework with more phases, more decision reviews, and with some of those reviews elevated to a higher level. The relative placement of milestone reviews with other program activities is also significant.

Number and Level of Milestone and Program Decision Reviews:

The most apparent, and perhaps least significant, change between eras was from numerical to alphabetical designation of major milestone reviews. A more subtle and important change was the appearance of divided phases and within-phase decision and progress reviews. With the latest release of the regulatory series, these additional sub-phases or “work efforts,” along with “pre-acquisition activities” have brought the total number of distinct activity intervals to eight, with as many as five phases and six decision reviews – more than at any time past. The work efforts are not called “phases” however. Each of these efforts has its own entrance and exit criteria, making them more in practice like a distinct phase of acquisition.

⁶⁵ Author’s unpublished results of student surveys taken during the course: MN4366 *Program Management and Leadership* as part of the Advanced Acquisition Program, Graduate School of Business and Public Policy, Naval Postgraduate School, Monterey, California, 2001-2003.

Reviews are described in the current policy to be decision points where decision makers can either stop, extend or grant permission to proceed into the next phase. Program reviews of any kind at the OSD level have a significant impact on program offices. Much documentation must be prepared and many preparatory meetings are conducted enroute to the ultimate review. And while non-milestone reviews are generally considered to be lesser in scope of effort to prepare for, a considerable amount of effort managing the decision process is still expended. Documentation required for various milestone and decision reviews is shown below (Fig. 13.):

INFORMATION FOR DECISION REVIEWS

Required Information	Milestone/Review				
	CD	A	B	C	FRP
Acquisition Decision Memorandum (ADM) (Note 6)	X	X	X	X	X
Acquisition Program Baseline (APB) (Note 6)			X	X	X
Acquisition Strategy (See page 5) (Note 6)			X	X	X
Affordability Assessment			X	X	
Analysis of Alternatives (AOA) (Note 4 & 6)		X	X	X	X
AOA Plan	X				
Benefit Analysis & Determination (Note 7)			X	X	
Beyond LRIP Report (note 2)					X
Capabilities Development Document (CDD) (Note 3 & 6)			X		
Capabilities Production Document (CPD) (Note 3)				X	
Certification of Compliance with Clinger-Cohen (MAIS only)		X	X	X	X
Certification of Compliance with Financial Management Enterprise Architecture (FM MAIS only)		X	X	X	X
C4I Support Plan (Notes 1 & 6)			X	X	
C4I Supportability Certification					X
Clinger-Cohen Act Compliance (MAIS) (Note 6)		X	X	X	X
Competition Analysis (depot-level maintenance rule) (Notes 1 & 5)			X		
Compliance with Strategic Plan			X	X	
Component Cost Analysis (MAIS; optional MDAP) (Note 6)			X	X	X
Consideration of Technology Issues		X	X	X	
Cooperative Opportunities (Note 1)			X	X	
Core Logistics/Source of Repair Analysis (Note 1)			X	X	
Cost Analysis Requirements Description (MDAP & MAIS) (Note 6)			X	X	X
Economic Analysis (MAIS)		X	X		X
Exit Criteria		X	X	X	
Industrial Capabilities (n/a AIS) (Note 1)			X	X	
Independent Cost & Manpower Estimate (MDAPs; n/a MAIS)			X	X	X
Independent Technology Assessment (ACAT ID only)			X	X	
Initial Capabilities Document (ICD) (Note 6)	X	X	X	X	
Interoperability Certification					X
IT Certification (MAIS)			X	X	X
Live Fire T&E Waiver (covered systems)(note 2)			X		
Live Fire T&E Report (covered systems)(note 2)					X
LRIP Quantities (n/a AIS)			X		
Market Research		X	X		
Operational Test & Evaluation Results			X	X	X
Post Deployment Performance Review					X
Program Protection Plan (Note 1)			X	X	
Pgm Environ, Safety & Ocup Health (w/NEPA schedule) (Note 6)			X	X	X
Registration of Msn Critical & Msn Essential Info Sys (Note 6)			X	X	
Spectrum Certification Compliance (Note 4)			X		
System Threat Assessment (Note 6)		X	X	X	
Technology Development Strategy		X	X	X	
Selected Acquisition Report (MDAPs)(Note 6)			X	X	X
Technology Readiness Assessment (Note 6)			X	X	
Test & Evaluation Master Plan (eval strategy due MSA)			X	X	X

Note 1. Also summarized in acquisition strategy
 Note 2. OSD T&E Oversight programs only
 Note 3. ICD, CDD & CPD replace MNS & ORD
 Note 4. For MDAP A, B, C; For MAIS A, B & FRP
 Note 5. Milestone C if program initiation
 Note 6. Program Initiation for ships
 Note 7. If no Milestone B, submit at Milestone C

Fig. 13. Documentation for Decision Reviews⁶⁶

⁶⁶ Defense Acquisition University, Program Managers Toolkit, 13th edition (Ver 1.0), June 2003.

The latest edition of the Program Managers Toolkit shows a figure that has long been familiar to Program Managers, showing a six-month timeline of activities leading to a review. This same six-month timeframe for preparation of an OSD-level review has been unchanged for many years (Fig. 14.).

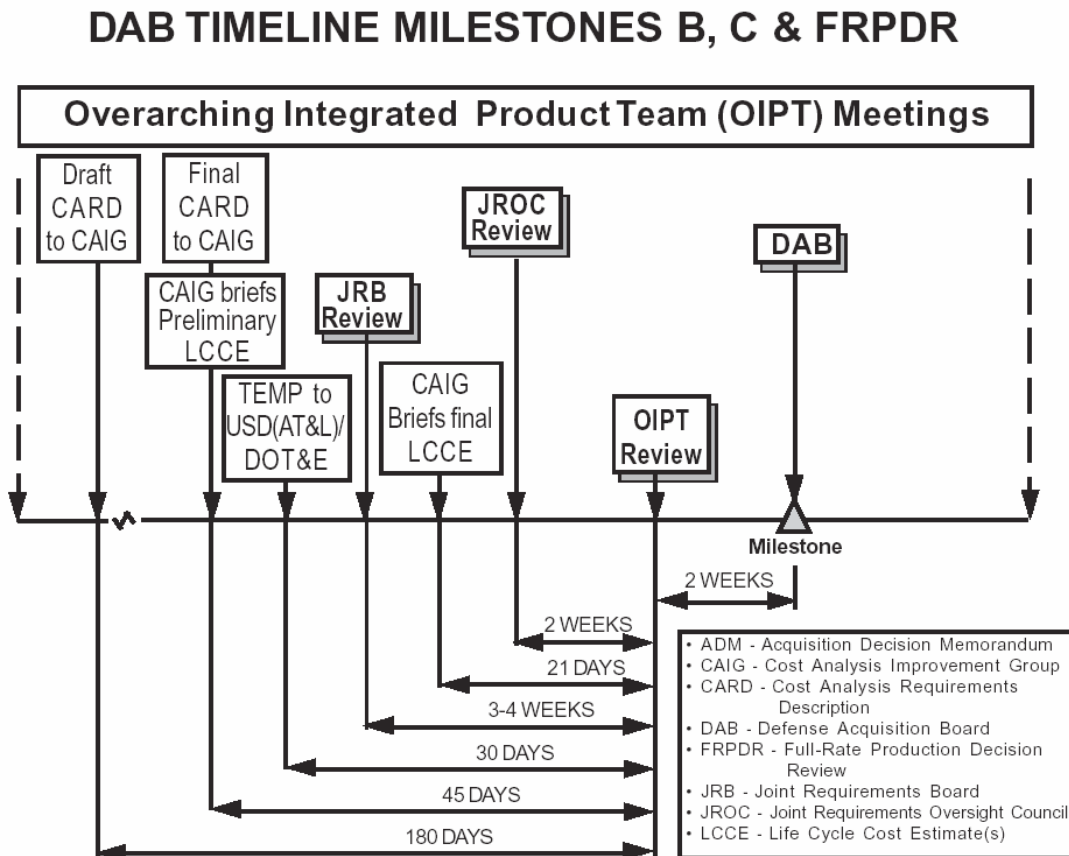

Fig. 14. Timelines for a Defense Acquisition Board Review⁶⁷

What this simple schematic cannot fully convey is the amount of meetings and preparatory briefings to staff members and committees. Some representatives from program management offices keep an accounting of travel and labor costs associated with a milestone reviews for an MDAP system. While only anecdotal data was available for this research, it is easy to surmise that a substantial amount of program office funding would be expended on support contractor assistance with supporting analyses

⁶⁷ Ibid.

and documentation, as well as frequent travel to the Pentagon, and other associated expenses in preparation for high-level reviews.⁶⁸ As of this writing, there are a total of 25 MDAP programs in the Department of Defense.

And though little written guidance yet exists for the new Design Readiness Review (DRR) in the midst of the SDD phase, it can be presumed to be an extensive effort. This review evolved from an in-phase IPR in the 2000 series to a Critical Design Review in the 2002 Interim Guidance model to its current name. Such a review at OSD-level is in keeping with the increased emphasis now being placed on technological assessment mentioned earlier. What is significant to PMs is that such a review, at least in the name of Critical Design Review, was previously one of several program-level technical reviews – chaired by the PM – within a disciplined systems engineering effort. It is an extensive review that can span days in length. How this review will be conducted remains to be seen, as of this writing, but it seems to be an entirely new approach to elevate a technical review to service or OSD level.

With Evolutionary Acquisition as the preferred strategy, notional systems are now shown as shorter developments (in SDD) with iterative Milestone B-to-C cycles. The new DoDI 5000.2 prescribes that, “In an evolutionary acquisition program, the development of each increment shall begin with a Milestone B, and production resulting from that increment shall begin with a Milestone C.”⁶⁹ Thus, program managers can expect to undergo the reviews determined appropriate for the initial increment of development in their program, as well as reviews specified for the follow-on increments.

The most recent published guidance shows one example of a system with no less than *fourteen reviews in its first eleven years from Concept Decision* (see Fig. 15.).

⁶⁸ Author’s unpublished interview with an anonymous representative from a major program office going through a milestone review, Naval Postgraduate School, Monterey, California, February 19, 2003.

⁶⁹ USD(AT&L) Department of Defense Instruction 5000.2, *Operation of the Defense Acquisition System*. May 12, 2003.

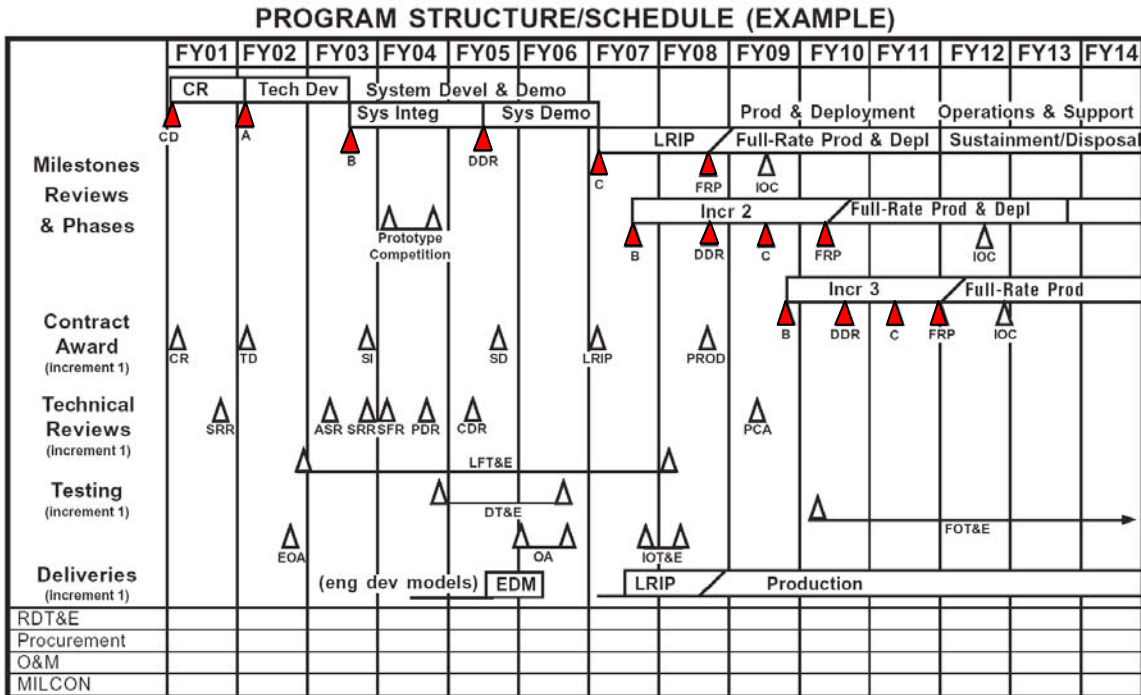

Fig. 15. Example of Program Structure Showing Two Successive Development Increments and Their Associated Reviews⁷⁰

Program Initiation Moves Further to the Right:

In all three Post-2000-era models, Milestone B is now the point of “program initiation,” and although some early graphic depictions⁷¹ of the new model showed a correlation to Milestone I of the 1996 version, this milestone actually correlates more closely to the old Milestone II in terms of system technical maturity (and other program events) under this latest era of models.

For transition of programs already underway, the following guidance was given in October of 2000:

4.5. Programs planned in accordance with the 1996 version of DoDD 5000.1 (reference (g)) and DoD 5000.2-R (reference (h)) shall be executed in accordance with approved program documentation. That documentation shall not be updated solely to satisfy the requirements of this Instruction. Programs already approved to enter Engineering and

⁷⁰ Defense Acquisition University, Program Managers Toolkit, 13th edition (Ver 1.0), June 2003.

⁷¹ Defense Acquisition University, DAU Faculty Brief Presentation, November 2000.

Manufacturing Development shall continue to follow the sequence of milestones established in their program documentation. The new policies in this Instruction, including the new decision points and phases, shall be applied to efforts that have not yet been approved as acquisition programs (usually pre-Milestone I) unless otherwise directed by the MDA. The new policies in this Instruction, including the new decision points and phases, shall be applied to programs that are post-Milestone I but that are not yet in Engineering and Manufacturing Development at the discretion of the MDA. For purposes of complying with applicable laws, Milestone A will serve as Milestone 0; Program Initiation, when it occurs at or during Component Advanced Development, will serve as Milestone I; Milestone B will serve as Milestone II; Milestone C will serve as the Low-Rate Initial Production decision point; and the Full-Rate Production Decision Review will serve as Milestone III. In addition, System Development and Demonstration will serve as Engineering and Manufacturing Development.⁷²

This passage communicates some degree of resultant complexity involved with changing terminology and sequencing of milestones and reviews, and of programs proceeding under multiple sets of rules and lexicon. At least one service published explanatory guidance for its programs to help delineate which set of rules would apply to particular programs,⁷³ resulting in the use of two acquisition models for a time.

Moving program initiation “further to the right” in program terminology allows for more time to be spent firming requirements, assuring that funding is in place, and development of an acquisition strategy before declaration as a formal program. Perhaps the thinking is that a later *official start* of a program will assure an earlier finish, as it were. But to not acknowledge (via “program initiation”) that a program is underway in two successive acquisition periods beyond need analysis period seems to this author somewhat illogical or disingenuous.

⁷² USD(AT&L) Department of Defense Instruction 5000.2, *Operation of the Defense Acquisition System*, October 23, 2000.

⁷³ Assistant Secretary of the Army, Acquisition, Technology, and Logistics, *The New Defense Acquisition Policies and Army Positions*, December 2000.

Technological Maturity before Program Commitment:

The Milestone B distinction was (and still is) important because it places program initiation at the point where the commencement of *advanced development*, not prototyping, will occur. The 1996-era policy designated program initiation at Milestone I, the onset of PDRR, and in the 1991-era policy it was even earlier -- at Milestone 0. This deferral of formal program recognition until a later stage of technical maturity is an explicit delay of departmental commitment. The formal declaration of product (versus technology) development likely stems from two GAO Reports (reports number 02-39 and 99-162) that recommended increased product knowledge prior to business commitment. And recall as well the reporting requirement to congress on the development time between program initiation and initial operational capability. Again, a delay in declaration of program initiation will at least appear to shorten cycle time if advanced development and production timelines remain unchanged.

As with previous policy throughout multiple versions of the DoD 5000 series on tailoring of acquisition programs, it is emphasized again that, appropriate to their concept and technology maturity, programs can enter the process at various points in the new model. Language in DoD 5000.2 supports the policy thrust that technical assessment will be an important part of program assessment:

3.7.2.2. Technology developed in S&T or procured from industry or other sources shall have been demonstrated in a relevant environment or, preferably, in an operational environment to be considered mature enough to use for product development in systems integration. Technology readiness assessments, and where necessary, independent assessments, shall be conducted. If technology is not mature, the DoD Component shall use alternative technology that is mature and that can meet the user's needs.⁷⁴

The interim guidebook prescribes the use of definitive Technology Readiness Levels or other measuring tools to be assigned to critical technologies of the developing

⁷⁴ USD(AT&L) Department of Defense Instruction 5000.2, *Operation of the Defense Acquisition System*, May 12, 2003.

system by Component S&T Executive and passed up the chain. These too had been emphasized earlier by the GAO (see report number 02-39).

Clearly, a frustration of the past has been the setbacks and resultant lengthening of advanced development phases from efforts to employ the very latest in emerging technology. But it can be argued that time saved in a shorter advanced development (SDD) phase can only result from more time spent in the preceding phases of Concept Refinement and Technology Development, with uncertainty of any genuine program cycle time reduction.

In the past, technology development during the advanced development (EMD) phase was blamed for undue costs and lengthening of this phase. But a very real concern may now be that -- unless SDD is greatly shortened -- attaining technological maturity at Milestone B instead of C guarantees the fielding of “yesterday’s technology tomorrow.”

In other words, there is a very real but somewhat understated distinction between what was Milestone III under the 1996 model and what is now Milestone C under the Post-2000 era models, beyond that of LRIP and Full Rate Production. Evolutionary acquisition under the new model prescribes the initiation of low-rate production of an 80% solution at Milestone C as the preferred approach. In order to achieve the 100% capability solution desired in the same time frame as would be planned under the single-step acquisition strategy, the model is perhaps more accurately depicted as below (Fig. 16):

1996 and 2003 DoD 5000 Models

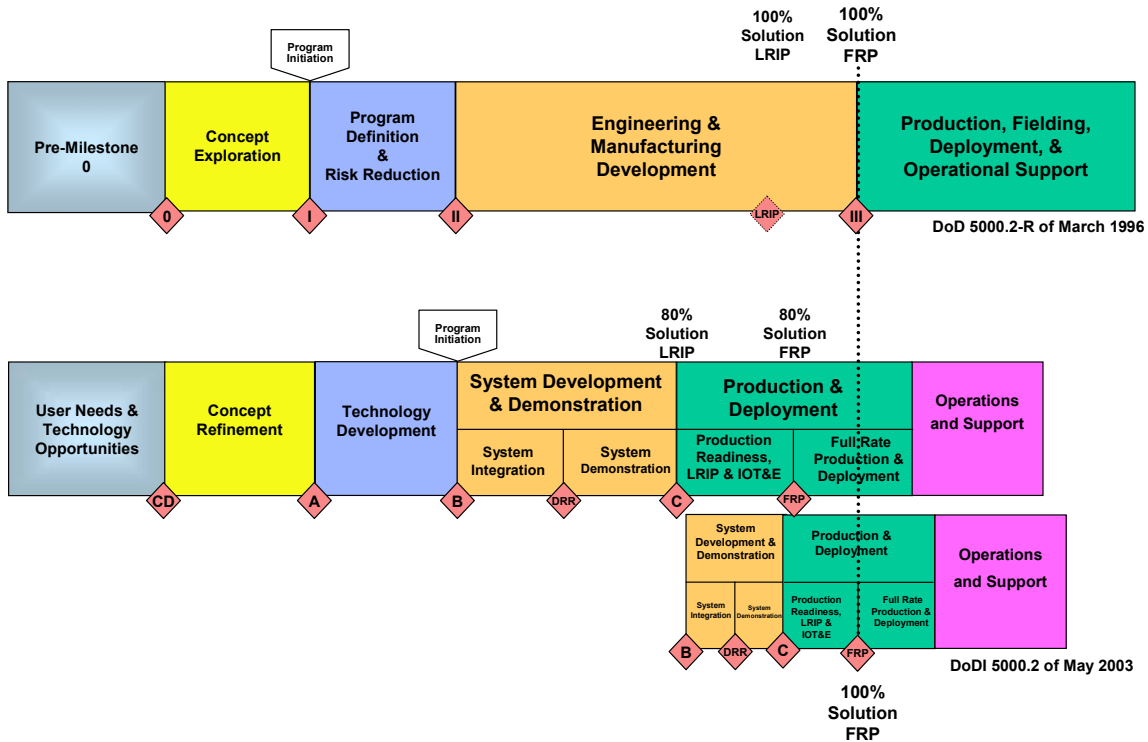

Fig. 16. Actual Comparison of 1996 and Post-2000-era Acquisition Framework Models

Again, what is most apparent here is the increased number of decision reviews, as well as the concurrent activities involved in managing the follow-on development increment and its requisite reviews as well. Assuming advanced development (SDD) is indeed shortened, and further assuming that concept and early prototyping phases are no longer than before, the time and effort on control activities appears almost certainly excessive within the same system delivery timeline.

Funding Implications:

Post-2000-era policy requires full funding for programs no later than Milestone B, and transition funding is needed to support any later entry into the acquisition process. The long held definition of “full funding” (pertaining to the total cost associated with an authorized quantity of militarily usable end items for a procurement within the fiscal year) was expanded to have a second meaning:

A requirement for formal program initiation of an acquisition program. In this sense, full funding means having an approved current (and projected) resource stream to execute the program, i.e., program funding is included both in the budget and in the out-years of the FYDP *sufficient to cover the current and future efforts described in the acquisition strategy* (emphasis mine). Funding requirements will be adjusted at least annually as the program advances through its life cycle.⁷⁵

This expansion of this term may serve as some assurance to OSD that programs will be less likely to exceed program estimates if only initiated when all forecasted resources are in place. DoDI 5000.2 states that:

Transition into SDD also requires full funding (i.e., inclusion of the dollars and manpower needed *for all current and future efforts* (emphasis mine) to carry out the acquisition strategy in the budget and out-year program), which shall be programmed when a system concept and design have been selected, a PM has been assigned, requirements have been approved, and system-level development is ready to begin.⁷⁶

However, with regard to Evolutionary Acquisition as the preferred approach to satisfying operational needs, there are two development processes that may be implemented: (a) Incremental Development – where the end-state requirement is known, and requirement will be met over time in several increments, and (b) Spiral Development – where desired capability is identified, but end-state requirements are not known at program initiation, and requirements for future increments are dependent upon technology maturation and user feedback from initial increments. Of these two processes, Spiral Development shall be the preferred process.

If we recall Wideman's caution about indefinite numbers of spirals, a special challenge is presented for obtaining realistic full funding estimates for programs with uncertain requirements and numbers of increments. If indeed, shorter cycles are facilitated by evolutionary acquisition, skillful financial management (programming and

⁷⁵ Defense Acquisition University, *Glossary – Defense Acquisition Acronyms and Terms*, 10th Edition, January 2001.

⁷⁶ USD(AT&L) Department of Defense Instruction 5000.2, *Operation of the Defense Acquisition System*, May 12, 2003.

budgeting) will be required to effectively enable the availability of funding as requirements for successive blocks are realized.

The Significance of Milestone C, and IOT&E after the LRIP

Decision:

The designation of LRIP now as an OSD decision for MDAPs in many cases heightens the level of this review (and the associated effort for same discussed earlier). As mentioned before, Low Rate Initial Production was often delegated to service Secretaries and was a concurrent activity within the advanced development phase. The advanced development paradigm is now changed: there will continue to be development activity after the initiation of production, but all production is now viewed as a separate phase of the system's life cycle. Production has traditionally been the phase where larger portions of program funds are spent, with the following Operations and Support phase even larger.

Also, while not specifically stated, the placement of IOT&E after the Milestone C decision might imply to some that only LRIP articles are to be used in Initial Operational Test and Evaluation. But the DoD 5000.2 states that production or production representative articles may be used, so there is no apparent preclusion from using SDD articles. The Operational Test and Evaluation community has long attempted to require only production representative articles to be used in operational testing. However, the concurrency of engineering activities to exploit task lead-lag times for schedule reduction has often thwarted this objective. IOT&E was previously conducted during the advanced development phase. It was viewed as an event that proved out development by testing the completed system in an operational environment with end users. Programs had sometimes transitioned into Low Rate Initial Production, and had simultaneously gone into operational test with engineering articles from the advanced development phase.

LRIP is now part of the production phase. And if LRIP articles are to be used as test items for IOT&E, program managers will have to intensively manage (in order to

minimize) the time period between permission to award the production contract, produce, and receive deliverables to use in IOT&E, and subsequently support a Full-Rate Production Review. As in the past, DOT&E specifies how many test articles will be used in IOT&E, and must render a supportive Beyond LRIP report directly to congress before programs can proceed with Full Rate Production.

Impact upon the Requirements Generation System:

The Requirements Generation System employs Chairman of the Joint Chiefs of Staff instructions and manuals for policy guidance regarding processes in their purview. The CJCSI 3170.01A of 10 August 1999 showed linkage to the Acquisition System with the following graphical representation of Joint Requirements Oversight Council meetings in support of Defense Acquisition Board decision reviews (Fig. 17.).

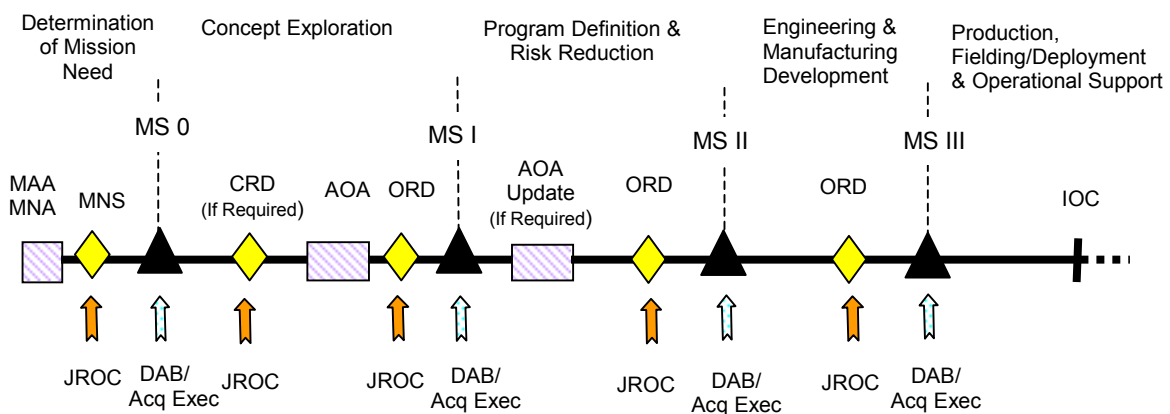

Fig. 17. Requirements Generation and Acquisition System Interface 3170.01A, August 1999

The next version of the CJCSI 3170.01B of 15 April 2001 displayed the new model (Fig. 18.) and allowed that there would be two models for JROC and Acquisition interfacing: “Programs planned in accordance with the 1999 version of the DOD 5000 series will be executed per their approved program documentation.”

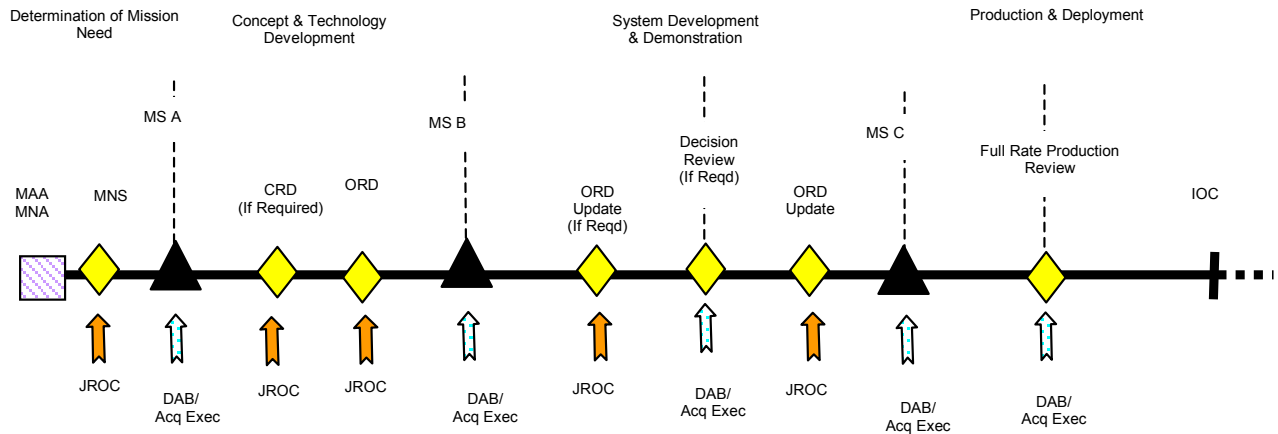

Fig. 18. Requirements Generation and Acquisition System Interface 3170.01B, April 2001

Issuance of the CJCSI 3170.01C on 24 June 03 simplifies their process, showing only three affirmations of requirements via JROC in support of the JCIDS and acquisition processes (and is in variance with Program Managers Toolkit showing JROCs in support of Milestone B, C, and FRP, Fig. 19.).

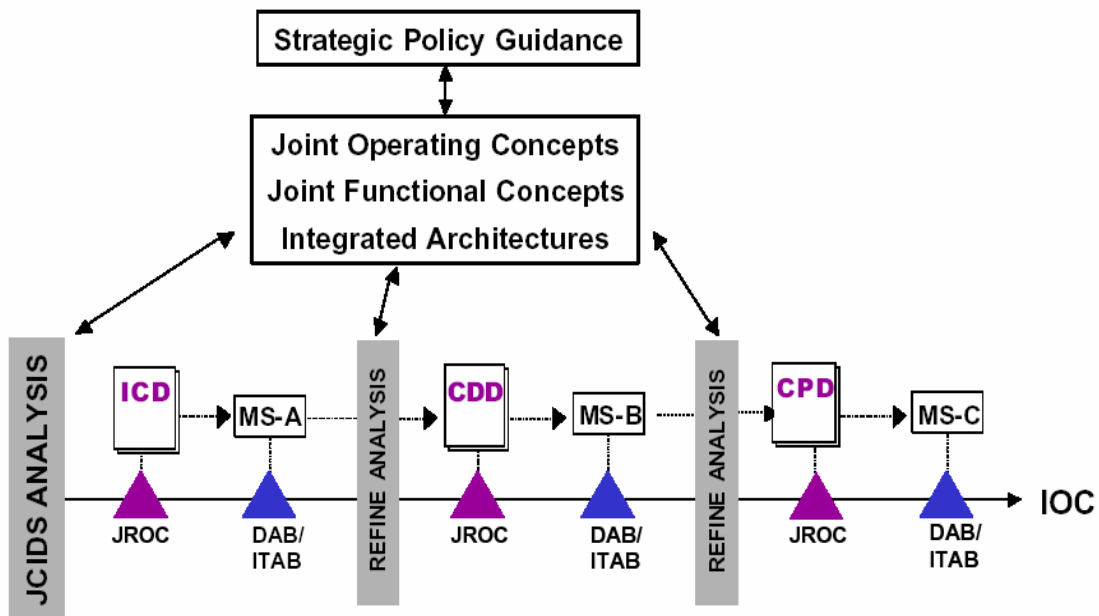

Fig. 19. Requirements Generation and Acquisition System Interface CJCSI 3170.01C, June 2003

What is very apparent in this new model for requirements generation is its illustration of newly established documents that drive the acquisition system, and where they will each emerge in the parallel processes. The ICD generally correlates to the long-established MNS. The CDD generally correlates to the long-established ORD. The CPD, however, is a new reflection of what will be the then-achievable requirements that the combined communities agree to produce. This is a new move toward requirements flexibility that reflects what developers have struggled with for some time: requirements become discovered and more fully understood as the system matures. Being locked into unattainable requirements has proven costly. Requirements have often been both difficult to attain and perhaps as difficult to change. The new CJCS instruction therefore provides for more flexibility in the requirements determining process.

Also obvious in the model is a top-down approach to requirements that is intrinsic in the accompanying written policy guidance. While well beyond the scope of this research effort, it must be pointed out that a significant step has been taken in this new policy to centralize control of the requirements process, in an effort to ensure not only consolidation and optimization of investment efforts that come from this process, but interoperability between systems and services as well.

On the whole, the Post-2000-era acquisition models prescribe a very new paradigm, and only time can inform us whether Deputy Secretary Wolfowitz's goals of program management flexibility and innovation have been achieved. No program has yet gone through the entire model, and none will for many years to come.

Centralized Control of Defense Acquisition Programs

The U.S. Constitution clearly established civilian control of the military and spells out the powers and responsibilities of Congress with regard to it. The 1947 National Security Act and subsequent amendments established civilian control of the military within a newly created Department of Defense, and there has since been an ongoing, competitive tension between military and civilian members over power and control even within this organization. The centralized authority of the Secretary of Defense and his staff was further strengthened in later amendments, particularly in the tenure of Robert McNamara (1961-68), renowned for his institution of PPBS, etc.⁷⁷

The Goldwater-Nichols Act of 1986 shifted some power to the combatant commanders in formulation of equipment requirements via the JROC, but also shifted military and civilian (mostly military) program manager personnel to the control of the civilian led service secretariats. It too led the way for a separate professionalized acquisition corps that would develop experienced and educated program managers to administer their programs efficiently and effectively.

Nevertheless, time spent “managing the bureaucracy” has remained an encumbrance to PMs. Back in 1988-89, military research fellows studying commercial practices at the Defense Systems Management College wrote about an imbalance of authority between PMs and the OSD staff.⁷⁸ Of eleven improvements they recommended to the acquisition process, number three on their list was, “Reduce the number and level of program decision milestones.” Showing the 1987 model, they recommended that only one of the then five reviews be conducted at OSD level: the review for advanced development. They quoted the 1986 Packard Commission’s conclusions, which said, “He (the PM) should be fully committed to abide by the

⁷⁷ Fox, J. Ronald, *The Defense Management Challenge: Weapons Acquisition*, Harvard Business School Press, 1988.

⁷⁸ Defense Systems Management College, *Using Commercial Practices in DoD Acquisition*, December 1989.

program's specified baseline and, so long as he does so, the Defense and Service Acquisition Executives should support his program and permit him to manage it. This arrangement would provide much needed program stability."⁷⁹

Going back even further to 1981, Defense Secretary Casper Weinberger and his Deputy Secretary Frank Carlucci had instituted thirty-two acquisition reforms that took aim at centralized control by the senior civilian advisors in the Pentagon. He streamlined the milestone decision review process at OSD level from four milestone reviews to only two. But as Fox points out, there are no sovereign powers in Washington, but many independent ones, capable of impeding initiatives of others.⁸⁰

Indeed the Defense Acquisition Board is a powerful decision making board when it convenes, but until it does, it is a diverse committee of disparate interests with powers of "no" among many individuals and powers of "yes" to none. Frequent reviews may lead to numerous program adjustments, much as is done now with resource shuffling with program funding. The time and effort spent in managing the bureaucracy, versus the program, is a major activity of PMs, and repeated adjustments are opposed to program stability.

Mentioned earlier was that contingency theory encourages senior leaders to find the best fit for their organization's structure to its environment, understanding that some situations might call for rigid bureaucratic structure while others might require a more flexible, organic one. The concept of control is also a cornerstone of cybernetics: the study of organizations, communications and control in complex systems. It focuses on looped feedback mechanisms, where the controller communicates to the controlled what is the desired future state, and the controlled communicates to the controller

⁷⁹ Packard Commission, *A Quest for Excellence*, Final Report to the President, 1986.

⁸⁰ Fox, J. Ronald, *The Defense Management Challenge: Weapons Acquisition*, Harvard Business School Press, 1988.

information with which to form perceptions for use in comparing states. The controller then communicates (directs) purposeful behavior.⁸¹

The fundamental need for communications constrains the options for control, making the communications architecture a critically important feature of the control system. It is often heard that with communications in today's information age warfare, we seek to "act within the enemy's decision cycle." For acquisition decision makers, the information architecture is the command and control hierarchy within our bureaucracy. And the decision cycle in the course of a program (shown in Fig. 14) still, after many years, reflects 180 days of typical preparation lead-time for a decision review.

Mises, Hayek and Kirzner, in their work described a "knowledge problem" with regard to centralized planning and control:

The knowledge problem stems from the fact that a planner, especially a central planner, may fail to achieve an attainable goal because of the inadequacies of the planner's knowledge. Central planners are usually unaware of their own ignorance concerning the facts relevant to their social plans. Because the central planner cannot know everything about the problem he is confronted with, his knowledge must take the form of what he thinks he knows about the dispersed bits of knowledge that can be obtained. He uses these bits of dispersed knowledge to implement his social plan, but he may be unaware of other bits of knowledge that could have been relevant to achieve an objective. It is highly unlikely that a central planner can always know where to find, or how to look for, all the necessary bits of dispersed information known in the economic system relevant to a problem at hand. This is most problematic since it makes it impossible for the central planner to be fully cognizant of the nature of, or of the amount of gaps in, his own knowledge. The tragedy of central planning toward industrial policy is that even the best-intentioned central planner is unaware of the knowledge problem, which is the ignorance of his own ignorance.⁸²

⁸¹ Ashby, W. R., *An Introduction to Cybernetics*, London: Chapman & Hall, 1960.

⁸² Kirzner, I. M., *The Meaning of Market Process: Essays in the Development of Modern Austrian Economics*, London: Routledge, (1992) and Cleveland, Paul A. and Price, Jared R., *The Independent Review*, A Journal of Political Economy, *The Failure of FAA Regulation*, Vol. 8, No. 1, Summer 2003.

Similarly, when Rand authors wrote about DoD decision making pertaining to training, equipping, manning, and operating the force, they suggested that decisions should be based upon senior leadership's desired outcomes. They also suggest that leaders consider hedging with more wagers versus single large bets – meaning use of more brains versus one. They acknowledge that with a decentralized management style comes dilution of responsibility and accountability, unless vigilance of execution is maintained. But they agree with other theorists that centralized decision making was consistent with the Cold War, and a style well-suited to the 1960s, but can be stifling and can restrict innovation.⁸³

Pinchot's *Intelligent Organization* does not call for decentralization to undermine bureaucracy, but to improve it. He advocates decentralization with horizontal interconnection (a network organization) between business units, to lessen the reliance upon going up the chain of command and down again for communication flow and decision. Rather than total autonomy for PMs, he supports self-management, from trust, with responsibility and accountability.⁸⁴ This thinking seems particularly appropriate to a professionalized bureaucracy such as the DoD acquisition workforce, with disciplined standards of training, education, and experience steadily progressing since implementation of the Defense Acquisition Workforce Improvement Act (DAWIA) in the early 1990s.

Ashby's Law of Requisite Variety, also mentioned earlier, basically asserts that PMs must be able to see, understand, and act with variety upon their environment to survive (my application). Morgan cautions that senior leaders must communicate strategy, resource flows, and timelines, and create a broad structure of accountability. If instead he is over controlling, he will negate any variety or innovative potential a

⁸³ Johnson, Stuart, Libicki, Martin C. and Treverton, Gregory F., *New Challenges New Tools for Defense Decisionmaking*, Rand 2003.

⁸⁴ Pinchot, Gifford and Elizabeth, *The End of Bureaucracy and the Rise of the Intelligent Organization*, Berrett-Koehler Publishers, San Francisco, 1993.

subordinate unit may possess – having to focus on internal rules and controls vice dealing with the local challenges being faced.⁸⁵

⁸⁵ Adapted from Morgan, Gareth, 1997, *Images of Organization*, Sage Publications.

Conclusions

Great strides have been made in acquisition of defense systems over the past two decades, the best proof of which might be from the performance of these systems in the Persian Gulf War, the Kosovo campaign, Operation Iraqi Freedom, and other operations. Still, there are always improvements to be made via revisions in policy and the implementation thereof. Likewise, there is a need on the part of implementers to consider not only what the current policy states, but what the secondary and tertiary effects of changes might be.

Acquisition models reflect explicit and even implicit aspects of acquisition policy. The author's research has not sought to thoroughly analyze all acquisition policy in the past sixteen years, but to provide something of a brief chronicle of what has transpired within the acquisition framework, and to suggest implications of the most recent models with regard to organizational theory. Also presented was some perspective from models phasing the activities of large and complex projects in non-DoD business areas.

As can be seen in these models, changes to the DoD acquisition system have been evolutionary, with an accelerated rate of change in the last three years. So too, has the DoD's external environment rapidly changed in these first years of the 21st Century, with more emphasis on combating global terrorism and homeland security. This amount of change in the environment and turbulence in the policy can easily lend to confusion in the field. Moreover, serious consideration must be given to DoD's internal organizational control strategy apposite to a new age in acquisition.

It is evident that the debate about centralized control and number of OSD-level reviews has been taking place for a long time. The current model increases the number and levels of reviews, and their placement with regard to program events indicate that we are moving toward an even more centralized approach to control of acquisition programs.

This is in contrast to the stated policy and what has been publicized about it:

The [new] policies achieve Wolfowitz's and Under Secretary of Defense for Acquisition, Technology and Logistics Edward C. "Pete" Aldridge's objectives by giving acquisition decision makers much greater authority to tailor program strategies to fit the needs of their program. Greater emphasis is now placed on evolutionary acquisition as the preferred strategy for rapidly acquiring advanced warfighting capability. Program managers are now given the flexibility to be creative and efficient in the way they apply policy to their programs. The policies are designed to release the power of innovation in every member of the acquisition, technology and logistics workforce.⁸⁶

But what is perhaps even more significant than this observation is that moving toward greater centralization of control at the higher levels may be a cause for serious concern, given predominant management theory cited herein. The mainstream of thought indicates that more efficiency and effectiveness might be gained from a different approach to an external environment of instability and uncertainty, whether from unclear threats and uncertain scenarios, or from complexities of technology and systems acquisition.

Centralization of control is a management issue to be dealt with – the challenge to avoid anarchy, with no guidelines or parameters, as well as excessive control. Might programs actually be lengthened by more cumbersome reviews? Whether fourteen reviews in eleven years are too many is a matter of conjecture and more debate. However, it is obvious that there are today more reviews than ever before, and these do have a requisite cost associated with their execution. We will likely continue the struggle to find the appropriate balance between centralized functions at OSD and autonomy for the management of programs in both explicit or implicit management policies and frameworks.

Likewise, the implications of delayed program initiation and shift of Initial Operational Test and Evaluation until after the start of production have yet to be

⁸⁶ United States Department of Defense, News Release No. 327-03, <http://www.defenselink.mil/news/releases.html>, May 14, 2003.

realized. A delay of advanced development almost certainly means more time to be spent on the earlier development processes. And loss of concurrency via the sequencing of LRIP and IOT&E similarly threatens to lengthen at least some programs that could have performed these activities simultaneously.

An obvious area for further research is on the subject of actual costs associated with senior level decision reviews. However, investigational opportunities might also include several questions pertaining to the application of evolutionary acquisition and its potential resultant impacts on Initial Operational Test and Evaluation, configuration management, “lot, model, & type diversity,” and associated supportability concerns. Lastly, Pinchot’s “horizontal interconnections” among business units may hold the key to ultimate effectiveness and efficiency within a large professional bureaucracy such as the DoD. A study of how the DoD might exploit its current capacity via increased horizontal communication might provide insight toward attaining the decentralized empowerment it advocates.

List of References

Adapted from Morgan, Gareth, 1997, *Images of Organization*, Sage Publications.

Ashby, W. R., *An Introduction to Cybernetics*, London: Chapman & Hall, 1960.

Assistant Secretary of the Army, Acquisition, Technology, and Logistics, *The New Defense Acquisition Policies and Army Positions*, December 2000.

Author's unpublished interview with an anonymous representative from a major program office going through a milestone review, Naval Postgraduate School, Monterey, California, February 19, 2003.

Author's unpublished results of student surveys taken during the course: MN4366 *Program Management and Leadership* as part of the Advanced Acquisition Program, Graduate School of Business and Public Policy, Naval Postgraduate School, Monterey, California, 2001-2003.

Blery, F. *Cost Growth and the Use of Competitive Acquisition Strategies*, *Journal of the National Estimating Society*, Vol. 6, No. 3, Fall 1985.

CJCSM 3170.01 Operation of the Joint Capabilities Integration and Development System, June 24, 2003.

Costa, Keith J., "5000.2 Changes Await Approval," *Inside The Pentagon*, January 16, 2003.

Defense Acquisition Framework, Defense Systems Management College, 2001.

Defense Acquisition Université, *DAU Faculty Brief Presentation*, November 2000.

Defense Acquisition Université, *Glossary – Defense Acquisition Acronyms and Terms*, 10th Edition, January 2001.

Defense Acquisition Université, Program Managers Toolkit, 13th edition (Ver. 1.0), June 2003.

Defense Systems Acquisition Management Process, Defense Systems Management College, January 1997.

Defense Systems Management College Press, *Acquisition Strategy Guide* (4th Edition), December 1999.

Defense Systems Management College, Using Commercial Practices in DoD Acquisition, December 1989.

Delbecq, André L., Van de Ven, Andrew and Gustafson, David, *Group Techniques for Program Planning*, 2nd edition, Greenbriar Press, Madison, Wisconsin, 1986.

Department of Defense 5000.2-R, *Mandatory Procedures for Major Defense Acquisition Programs and Major Automated Information Systems*, 1996.

Department of Defense Directive 5000.1, *Major and Non-Major Defense Acquisition Programs*, September 1, 1987.

DoD Directive 5000.1, "Defense Acquisition," February 23, 1991.

Ezzell, Carol, *The Price of Pills*, Scientific American, July 2003.

Forsberg, Kevin, Mooz, M. and Cotterham, H., *Visualizing Project Management*, 2nd Edition, Wiley, 2000.

Fox, J. Ronald, *The Defense Management Challenge: Weapons Acquisition*, Harvard Business School Press, 1988.

Gadeken, Owen C., "Project Managers as Leaders – Competencies of Top Performers," *RD&A*, January – February 1997.

Galbraith, J. R., *Designing Complex Organizations*, Reading, Massachusetts: Addison-Wesley, 1973.

GAO, "Best Practices – Capturing Design and Manufacturing Knowledge Early Improves Acquisition Outcomes," 02-701, July 2002.

GAO, "Better Management of Technology Development Can Improve Weapon System Outcomes," NSIAD-99-162, July 1999.

GAO, "Joint Strike Fighter Acquisition – Mature Technologies Needed to Reduce Risks," 02-39, October 2001.

GAO, "Successful Application to Weapon Acquisitions Requires Changes in DOD's Environment," NSIAD-98-56, February 1998.

Interim Defense Acquisition Guidebook, October 30, 2002 (Formerly the DoD 5000.2-R, Dated April 5, 2002).

International Council on Systems Engineering, <http://www.incose.org/whatis.html>, June 1999.

Johnson, Stuart, Libicki, Martin C. and Treverton, Gregory F., *New Challenges New Tools for Defense Decisionmaking*, Rand, 2003.

Kirzner, I. M., *The Meaning of Market Process: Essays in the Development of Modern Austrian Economics*, London: Routledge, (1992).

Kirzner, I. M., *The Meaning of Market Process: Essays in the Development of Modern Austrian Economics*, London: Routledge, (1992) and Cleveland, Paul A. and Price, Jared R., The Independent Review, A Journal of Political Economy, *The Failure of FAA Regulation*, Vol. 8, No. 1, Summer 2003.

Lindblom, C. E. (1959), The Science of Muddling Through, *Public Administration Review* 19 (Spring), (Reprinted in *Perspectives on Public Bureaucracy* (2nd ed.), pp. 132-150, by F. A. Kramer (Ed.), 1977, Cambridge, Massachusetts: Winthrop Publishers.

Morgan, Gareth, 1997, *Images of Organization*, Sage Publications.

Muench, Dean, *The Sybase Development Framework*, Sybase, California, 1994.

Office of the DoD Inspector General, *The Critical Design Review Process for Major Defense Acquisition Programs*, Audit Report Number 93-017, November 5, 1992.

Office of the Under Secretary of Defense (Acquisition and Technology) Washington, DC, 20301-3000 DoD Integrated Product and Process Development Handbook, August 1998.

Packard Commission, *A Quest for Excellence, Final Report to the President*, 1986.

Pinchot, Gifford and Elizabeth, *The End of Bureaucracy and the Rise of the Intelligent Organization*, Berrett-Koehler Publishers, San Francisco, 1993.

Pitette, Giles, "Progressive Acquisition and the RUP: Comparing and Combining Iterative Process for Acquisition and Software Development," *The Rational Edge*, November 2001.

Project Management Guidelines (Private BC Corporation), 1995, Wideman Comparative Glossary of Project Management Terms v3.1, 2002.

Project Management Institute, *A Guide to the Project Management Body of Knowledge (PMBOK® Guide)*, 2000 Edition, Pennsylvania, 2000.

Secretary of Defense Memorandum, *Defense Acquisition*, Attachment 1, *The Defense Acquisition System*, October 30, 2002 (Interim Guidance 5000.1, p. 6).

Secretary of Defense Memorandum, *Defense Acquisition*, Attachment 2, *Operation of the Defense Acquisition System*, October 30, 2002 (Interim Guidance 5000.2, p. 34).

Sylvester, Richard K. and Ferrara, Joseph A., *Conflict and Ambiguity Implementing Evolutionary Acquisition*, Acquisition Review Quarterly - Winter 2003.

United States Department of Defense, News Release No. 327-03, <http://www.defenselink.mil/news/releases.html>, May 14, 2003.

US Food and Drug Administration Center for Drug Evaluation and Research
<http://www.fda.gov/cder/rdmt/default.htm>, Approval Times for Priority and Standard NMEs - Calendar Years 1993-2002, (Updated through 12/31/2002, Posted 1/14/2003).

USD(A&T) Department of Defense Directive 5000.1, *Defense Acquisition*, March 15, 1996.

USD(A) Department of Defense Directive 5000.1, *The Defense Acquisition System*, February 23, 1991.

USD(A) Department of Defense Instruction 5000.2, *Defense Acquisition Management Policies and Procedures*, February 23, 1991.

USD(AT&L) Department of Defense Directive 5000.1, *The Defense Acquisition System*, May 12, 2003.

USD(AT&L) Department of Defense Directive 5000.1, *The Defense Acquisition System*. October 23, 2000.

USD(AT&L) Department of Defense Instruction 5000.2, *Operation of the Defense Acquisition System*, May 12, 2003.

USD(AT&L) Department of Defense Instruction 5000.2, *Operation of the Defense Acquisition System*, October 23, 2000.

Van Creveld, Martin, *Command in War*, Harvard University Press, 1985.

Western European Armaments Group *WEAG TA-13 Acquisition Programme, Guidance on the Use of Progressive Acquisition*, Version 2, November 2000.

Wideman, R. Max, *Progressive Acquisition and the RUP Part I: Defining the Problem and Common Terminology*, The Rational Edge, 2002.

Wideman, R. Max, *Software Development and Linearity Part 1*, ICFAI PRESS, Projects & Profits, Vancouver, BC, Canada, March 2003.

Wolfowitz, Paul, Memorandum for Director, Washington Headquarters Services *Cancellation of DoD 5000 Defense Acquisition Policy Documents*, October 30, 2002 (canceled DoDD 5000.1, DoDI 5000.2, and DoD 5000.2-R no attachments).

Initial Distribution List

1. Defense Technical Information Center 2
8725 John J. Kingman Rd., STE 0944
Ft. Belvoir, VA 22060-6218
2. Dudley Knox Library, Code 013 2
Naval Postgraduate School
Monterey, CA 93943-5100
3. Research Office, Code 09 1
Naval Postgraduate School
Monterey, CA 93943-5138
4. Douglas A. Brook 1
Dean, GSBPP
555 Dyer Road
Naval Postgraduate School
Monterey, CA 93943-5000
5. David Lamm 1
GSBPP
555 Dyer Road
Naval Postgraduate School
Monterey, CA 93943-5000
6. Jim Greene 1
GSBPP
555 Dyer Road
Naval Postgraduate School
Monterey, CA 93943-5000
7. Eric Jansen 1
Naval Postgraduate School
Monterey, CA 93943-5000
8. Keith Snider 1
GSBPP
555 Dyer Road
Naval Postgraduate School
Monterey, CA 93943-5000

9. Brad Naegle 1
GSBPP
555 Dyer Road
Naval Postgraduate School
Monterey, CA 93943-5000
10. Dave Matthews 1
GSBPP
555 Dyer Road
Naval Postgraduate School
Monterey, CA 93943-5000
11. Mike Boudreau 1
GSBPP
555 Dyer Road
Naval Postgraduate School
Monterey, CA 93943-5000
12. Bill Gates 1
GSBPP Associate Dean for Research
555 Dyer Road
Naval Postgraduate School
Monterey, CA 93943-5000
13. Dick Doyle 1
GSBPP
555 Dyer Road
Naval Postgraduate School
Monterey, CA 93943-5000
14. Karey Shaffer 1
GSBPP
555 Dyer Road
Naval Postgraduate School
Monterey, CA 93943-5000
15. John T. Dillard 1
Code BP/Dj
Naval Postgraduate School
Monterey, CA 93943-5000

