

1/30/04
CD

EM1438

Document And Report Documentation Page Submitted as edoc_1075487022

Report Documentation Page		<i>Form Approved</i> OMB No. 0704-0188	
<p>Public reporting burden for the collection of information is estimated to average 1 hour per response, including the time for reviewing instructions, searching existing data sources, gathering and maintaining the data needed, and completing and reviewing the collection of information. Send comments regarding this burden estimate or any other aspect of this collection of information, including suggestions for reducing this burden, to Washington Headquarters Services, Directorate for Information Operations and Reports, 1215 Jefferson Davis Highway, Suite 1204, Arlington VA 22202-4302. Respondents should be aware that notwithstanding any other provision of law, no person shall be subject to a penalty for failing to comply with a collection of information if it does not display a currently valid OMB control number.</p>			
1. REPORT DATE 10 MAR 2003	2. REPORT TYPE N/A	3. DATES COVERED -	
4. TITLE AND SUBTITLE MIMO Capacity of Radar as a Communications Channel		5a. CONTRACT NUMBER	
		5b. GRANT NUMBER	
		5c. PROGRAM ELEMENT NUMBER	
6. AUTHOR(S)		5d. PROJECT NUMBER	
		5e. TASK NUMBER	
		5f. WORK UNIT NUMBER	
7. PERFORMING ORGANIZATION NAME(S) AND ADDRESS(ES) Veridian Systems - Ann Arbor R&D Center		8. PERFORMING ORGANIZATION REPORT NUMBER	
9. SPONSORING/MONITORING AGENCY NAME(S) AND ADDRESS(ES)		10. SPONSOR/MONITOR'S ACRONYM(S)	
		11. SPONSOR/MONITOR'S REPORT NUMBER(S)	
12. DISTRIBUTION/AVAILABILITY STATEMENT Approved for public release, distribution unlimited			
13. SUPPLEMENTARY NOTES Also see: ADM001520, Adaptive Sensor and Array Processing Workshop , The original document contains color images.			
14. ABSTRACT			
15. SUBJECT TERMS			
16. SECURITY CLASSIFICATION OF:	17.	18.	19a. NAME OF RESPONSIBLE

a. REPORT unclassified	b. ABSTRACT unclassified	c. THIS PAGE unclassified	LIMITATION OF ABSTRACT UU	NUMBER OF PAGES 17	PERSON Patricia Mawby, EM 1438 PHONE:(703) 767-9038 EMAIL:pmawby@dtic.mil
----------------------------------	------------------------------------	-------------------------------------	---	--	---

Standard
 Form 298
 (Rev.
 8-98)
 Prescribed
 by ANSI
 Std
 Z39-18

pwd: cannot determine current directory!

MIMO Capacity of Radar as a Communications Channel

Patrick Bidigare
Veridian Systems - Ann Arbor R&D Center
Patrick.Bidigare@veridian.com

Adaptive Sensor and Array Processing Workshop
11 - 13 March 2003

Work funded under DARPA/AFRL Digital RF Tags contract
Program Manager: Dr. Tim Grayson

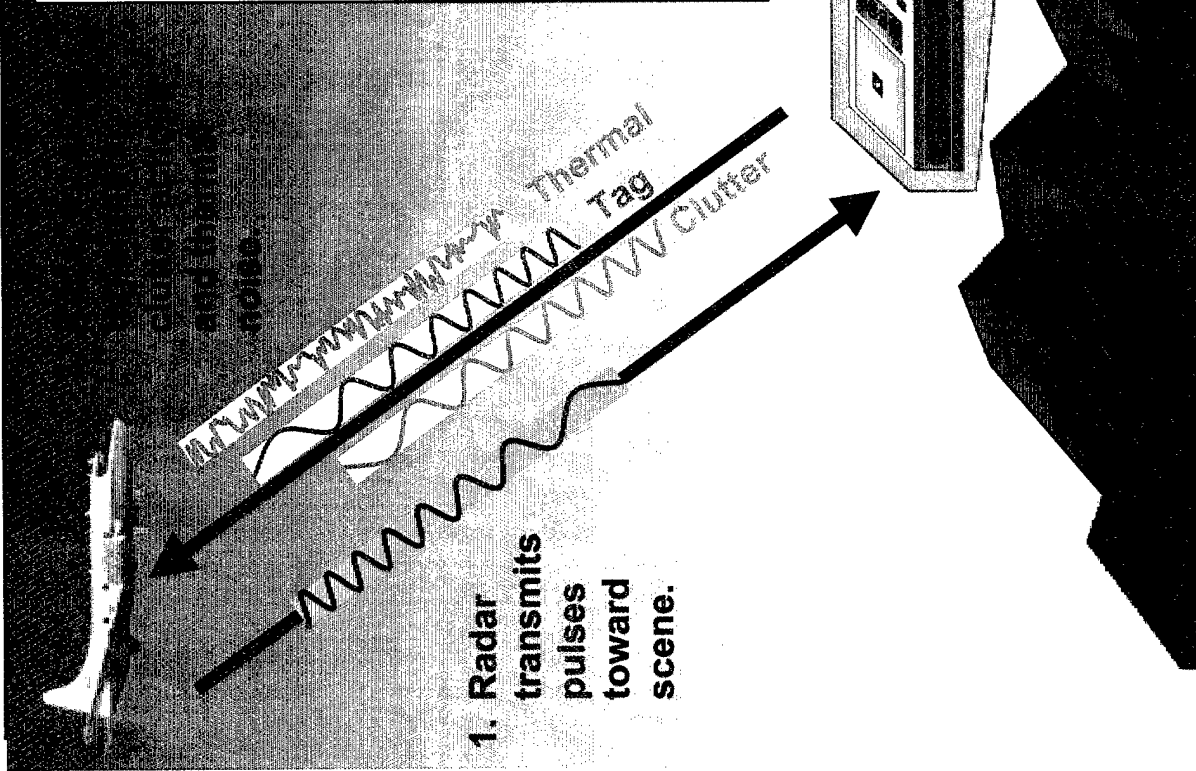

1. Radar transmits pulses toward scene.

2. Active transponder "RF tag" captures pulses, encodes information onto these and retransmits back to radar.

Example RF Tag Architecture

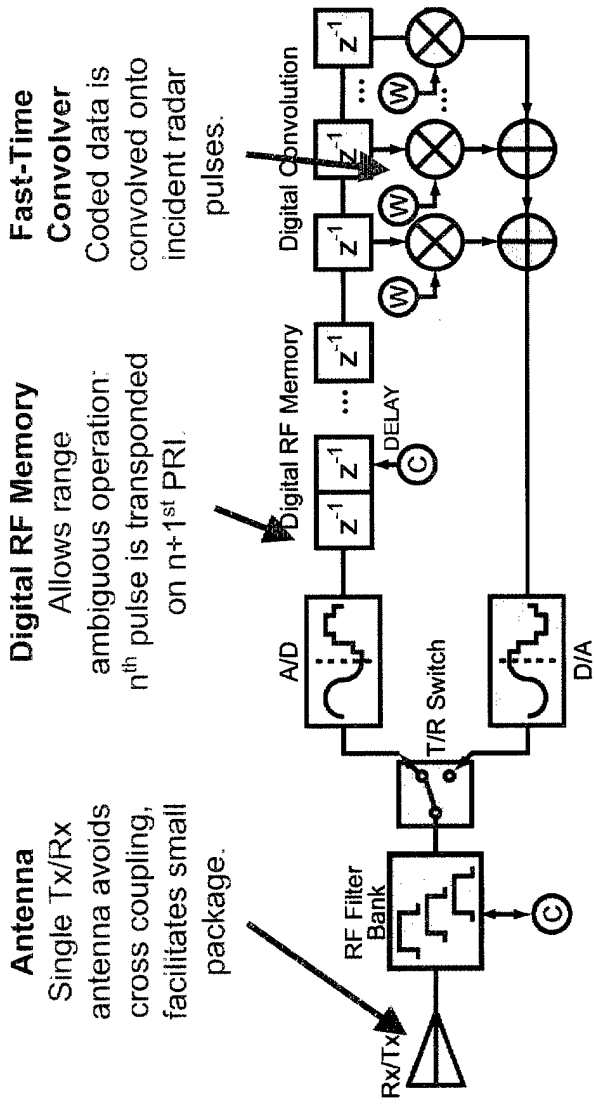

Antenna
Single Tx/Rx antenna avoids cross coupling, facilitates small package.

Digital RF Memory
Allows range ambiguous operation: n^{th} pulse is transponded on $n+1^{\text{st}}$ PRI.

Fast-Time Convolver
Coded data is convolved onto incident radar pulses.



GMTI STAP

- Space-time clutter correlation
- Adaptive signal processing

**RF TAGS
COMMS**

MIMO COMMS

- Channel capacity
- Space time coding.

Results Summary

- **ASAP 2002: Adaptive signal processing algorithm for suppressing clutter while preserving tag signals in multichannel radar systems.**
- **Asilomar 2002: Shannon capacity bounds + example curves for single channel radar systems.**
- **ASAP 2003: Shannon capacity bounds + example curves for multichannel radar systems.**

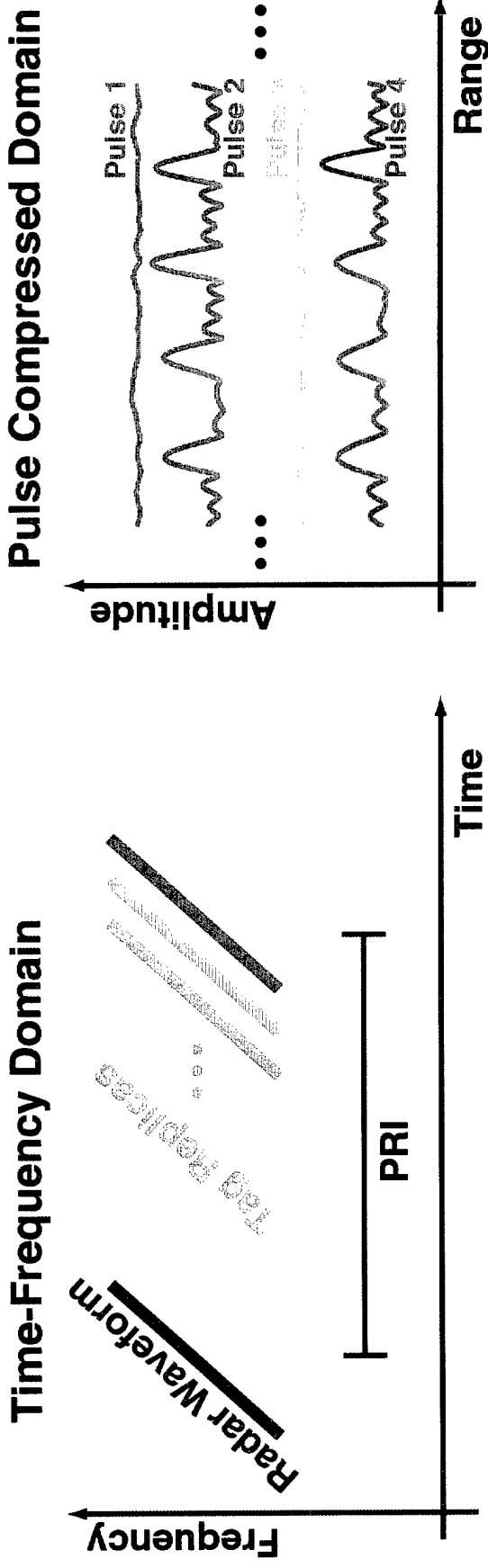

- Tag convolver produces a weighted sequence of time-delayed replicas of the radar waveform.
- Pulse compression causes each replica to compress in range.
- The impulse response peak values are determined by convolver tap weights.
- We consider *two* tag signal models:
 - Tag retransmits *all* received pulses.
 - Tag multiplexes single antenna to retransmit *every other* pulse.



All Pulse Model

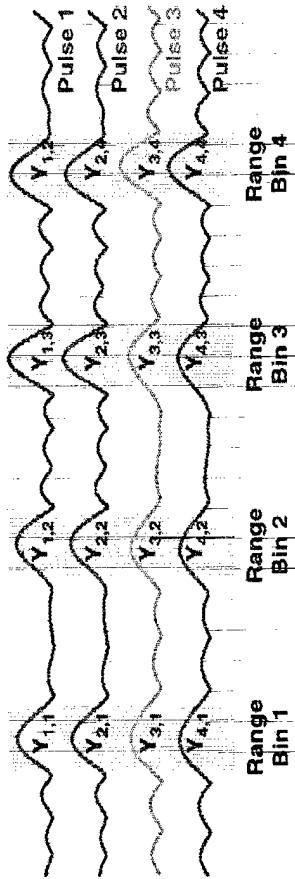

Every Other Pulse Model

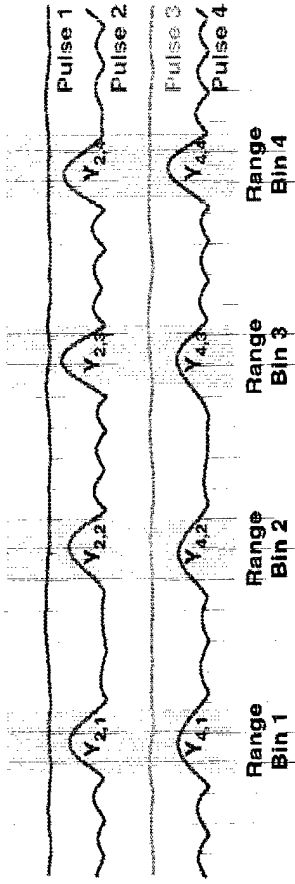

Channel Model

$$Y_{n,k} = X_{n,k} + Z_{n,k}$$

- $X_{n,k}$ - Input symbols n - Pulse number
- $Z_{n,k}$ - Noise samples k - Range bin index
- $Y_{n,k}$ - Output symbols N_{bins} - # Range bin channels

Noise Model

$$R_Z(n) = E[Z_{m,k} Z_{m+n,k}^*] \text{ - WSS Autocorrelation}$$

Clutter will be correlated between pulses.

- **We model the RF tag channel as a set of N_{bins} identical parallel discrete complex Gaussian channels corresponding to the tag signal bearing range bins.**
- **Each channel is contaminated with independent (range bin to range bin) additive WSS thermal and clutter noise.**



Conventional MIMO

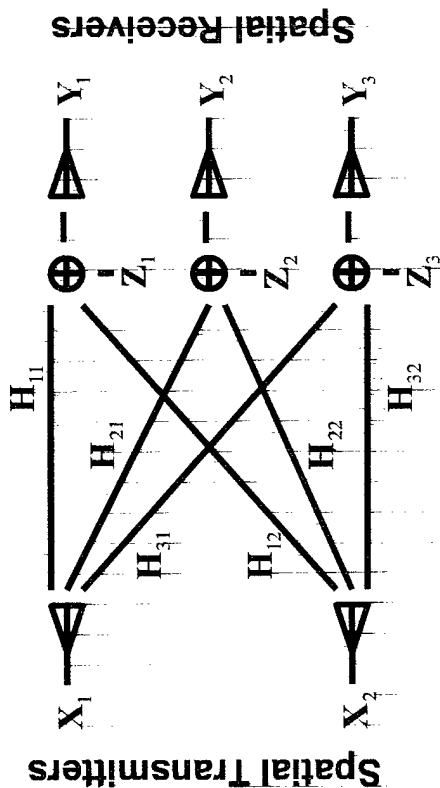

RF Tags

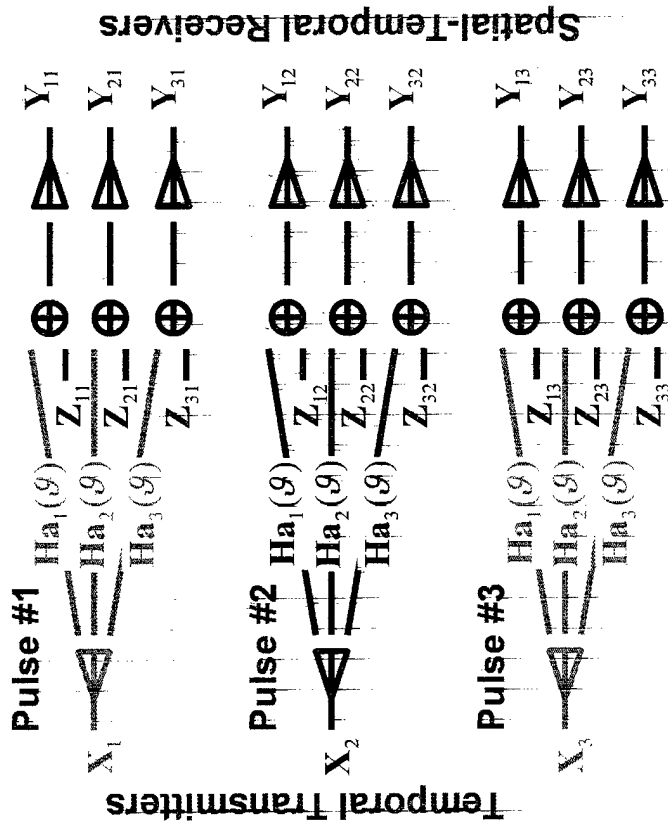

Conventional MIMO

- Arbitrarily sized.
- Arbitrary elements.
- Usually spatially white.
- Continuous

RF Tags

- More RX than TX.
- Kronecker product of identity matrix with steering vector.
- Highly colored between receivers and pulses.
- Finite # of range bins within each pulse.



MIMO Channel Equation

$$Y = HX + Z$$

$$H - N_{RY} \times N_{TX}$$

$$\text{rank}(H) = N_{TX}$$

Channel Diagram

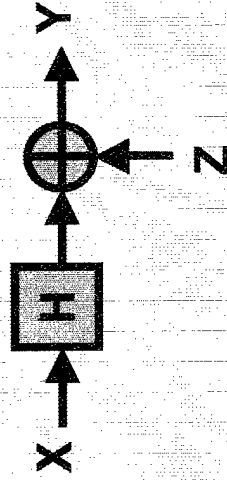

The MVUE of X given Y is:

$$W = (H^*R_Z^{-1}H)^{-1}H^*R_Z^{-1}Y$$

This is a sufficient statistic (receiver) for X, thus the cascaded channel has the same capacity:

$$I(X;Y) = I(X;W)$$

Cascaded Channel Diagram

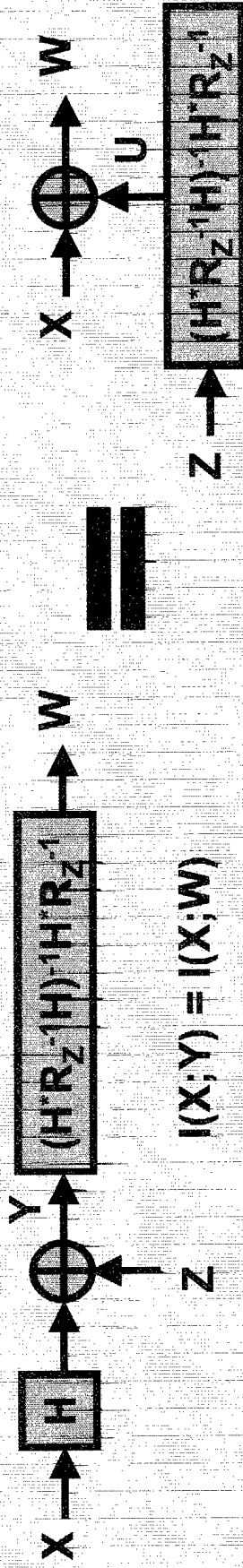

Conclusion: The injective MIMO channel has the same capacity as the bijective channel with identity channel matrix and noise process:

$$U = (H^*R_Z^{-1}H)^{-1}H^*R_Z^{-1}Z$$

*General MIMO Capacity: Bliss et. al. Environmental issues for MIMO capacity. IEEE Trans. on Signal Processing, 50(9):2129-2142, Sept. 2002

Spectral Efficiency Formulas

Informed Transmitter Spectral Efficiency

Transmitter knows noise correlation statistics.
Coded signal is spectrally optimized to maximize data rate.

$$C_{IT} = \sum_{i=1}^{N_{TX}} \log \left(\frac{(v - \lambda_i)^+ + \lambda_i}{\lambda_i} \right)$$

where v satisfies the energy constraint:

$$\frac{1}{N_{TX}} \sum_{i=1}^{N_{TX}} (v - \lambda_i)^+ = E$$

Notation

N_{TX} - Number of transmit channels.

E - Energy per transmission.

$\{\lambda_1, \dots, \lambda_{N_{TX}}\}$ - Eigenvalues of the equivalent bijective channel covariance

matrix $\mathbf{R}_U = (\mathbf{H}^* \mathbf{R}_Z^{-1} \mathbf{H})^{-1}$

Uninformed Transmitter Spectral Efficiency

Transmitter does not know correlation statistics. Optimal coded signal is spectrally white.

$$C_{UT} = \sum_{i=1}^{N_{TX}} \log \left(\frac{E + \lambda_i}{\lambda_i} \right)$$

RF Tags Capacity Roadmap:

- Define spectral efficiency for the RF tags channel.
- Formulate the RF Tags channel transfer matrix \mathbf{H} and energy constraint E .
- Determine the space-time interference covariance matrix \mathbf{R}_Z as a function of the radar parameters.



Conventional MIMO:

Continuous Time-Frequency Support

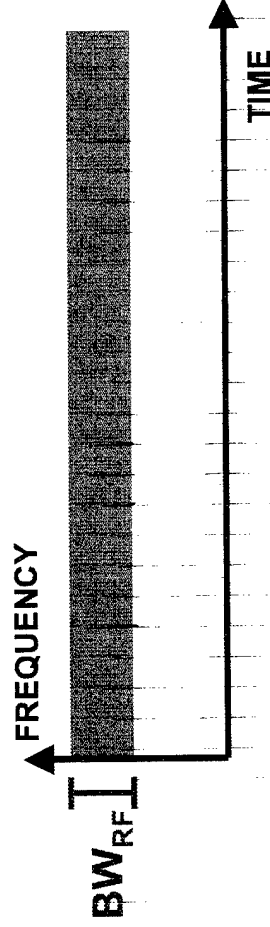

RF Tags:

Radar Time-Frequency Support

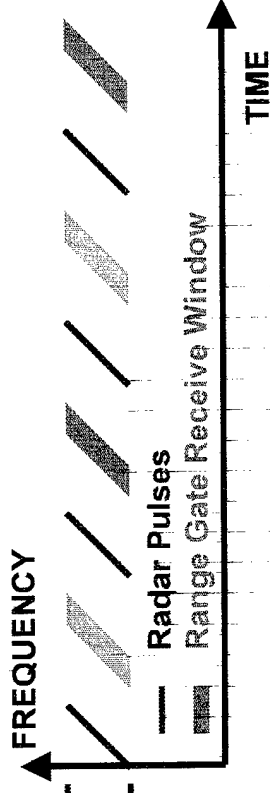

	Conventional MIMO	RF Tags
Time Frequency Support	RF band sampled directly at (or above) Nyquist rate. Full time frequency support available for communications.	Pulsed radar operation and front end processing allow only a small fraction of time frequency support to be utilized for communications.
Spectral Efficiency	Spectral efficiency is # bits per Nyquist sample.	Spectral efficiency is # bits per range bin per pulse.
Channel Capacity	Channel capacity is spectral efficiency times bandwidth.	Channel capacity is spectral efficiency times N_{bins} times PRF (or PRF/2).

RF Tags MIMO Channel

Energy Constraint & Transfer Matrix

Tag Energy

(Friis transmission equation)

Per Bin Tag Energy Pulse Width Radar Antenna Effective Area

$$N_{bins} \times E_{tag} = ERP_{tag} \times T_p \times \frac{1}{4\pi R^2} \times \frac{\lambda^2 G_{tag}^{Rx}}{4\pi}$$

Range Bins Used Tag Effective Radiated Power Propagation Loss to Radar

Channel Transfer Matrices

Multiple Receiver Radar

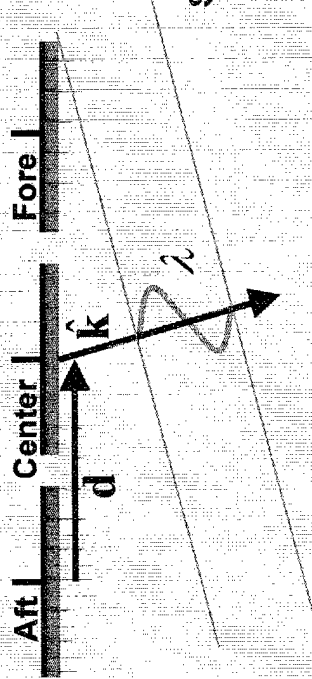

M = # Pulses

N = # Receivers

Transpond All Pulses

$$H_{AP} = \begin{bmatrix} a(\vartheta) & 0 & \Lambda \\ 0 & a(\vartheta) & \Lambda \\ M & M & O \end{bmatrix}$$

$MN \times M$

Spatial Frequency

$$\vartheta = \frac{\hat{\mathbf{k}} \cdot \mathbf{d}}{\lambda}$$

Spatial Steering Vector

$$\mathbf{a}(\vartheta) = \begin{bmatrix} 1 \\ e^{2\pi j \vartheta} \\ e^{4\pi j \vartheta} \end{bmatrix}$$

Transpond Every Other Pulse

$$H_{BOP} = \begin{bmatrix} 0 & 0 & \Lambda \\ a(\vartheta) & 0 & \Lambda \\ 0 & 0 & \Lambda \\ 0 & a(\vartheta) & \Lambda \\ M & M & O \end{bmatrix}$$

$MN \times \frac{M}{2}$

Clutter Model

- The clutter contribution to a range bin sample is a *coherent sum* of the returns from a large number of *independent* clutter patches.
- We treat the return from each clutter patch as a complex, zero mean random variable whose variance (energy) is given by the radar range equation:

Patch Energy	Pulse Width	Propagation Loss to Patch	Patch Area	Antenna Effective Area
Transmit Power	TX Antenna Gain	Clutter Reflectivity		Propagation Loss to Radar

$$E_{patch}(\theta) = P \times T_p \times G^T(\theta) \times \frac{1}{4\pi R^2} \times \sigma_0 \times R \Delta \theta \rho_{rg} \sin(\psi_{graze}) \times \frac{1}{4\pi R^2} \times \frac{\lambda^2 G^R(\theta)}{4\pi}$$

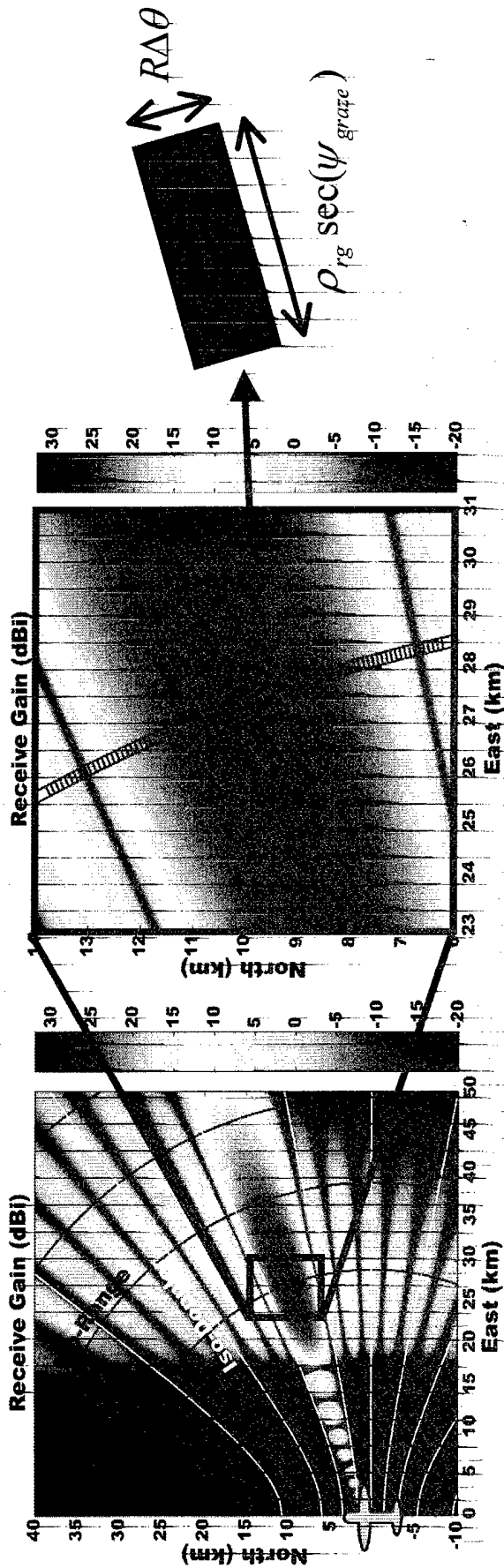

Clutter Correlation

The cross correlation between two pulses for a single clutter patch is

$$R_{patch}(\theta, \delta) = E_{patch}(\theta) \exp\left(-2\pi i \frac{2\Delta R(\theta, \delta)}{\lambda}\right)$$

Total clutter correlation between pulses as a function of displacement is

$$R_{clutter}(\delta) = \sum_{\theta} R_{patch}(\theta, \delta)$$

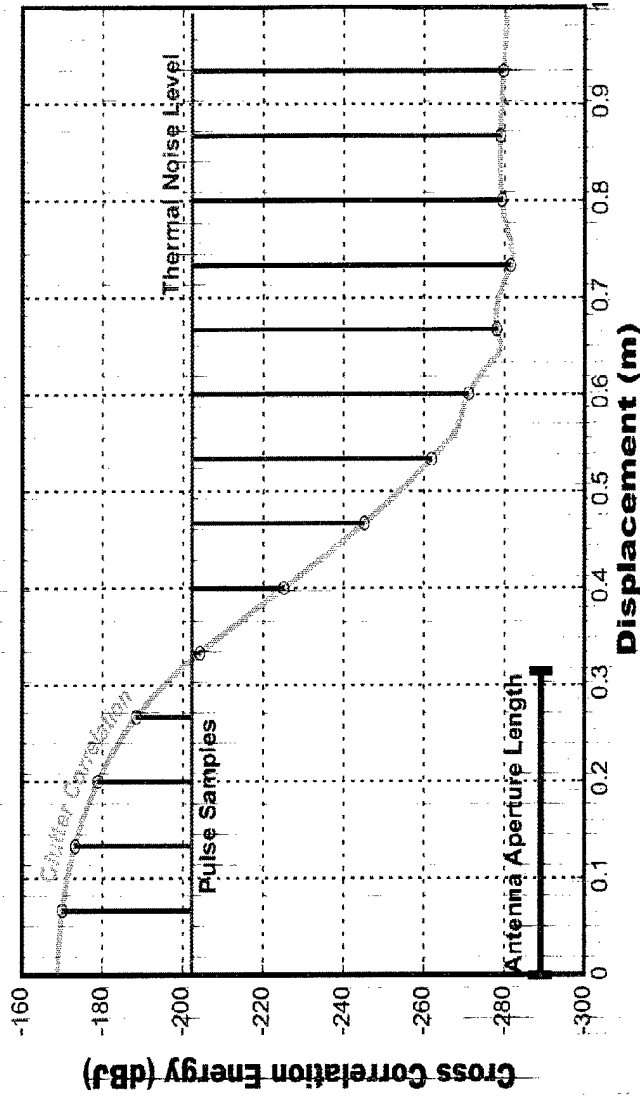
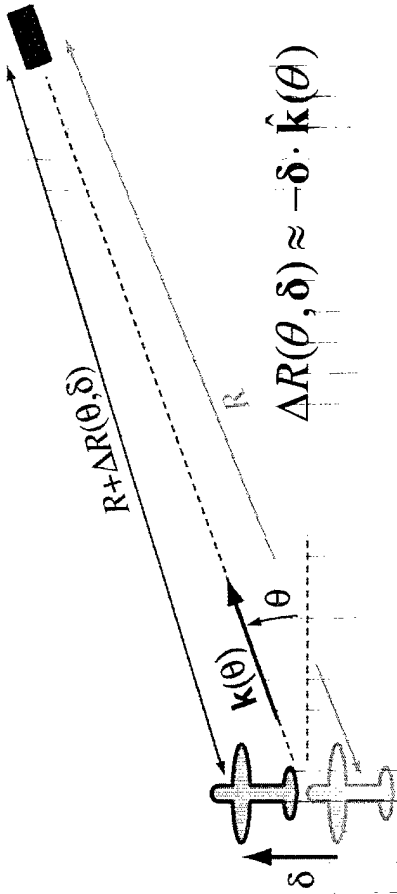



Interference Covariance Matrix

- Virtual Phase Centers

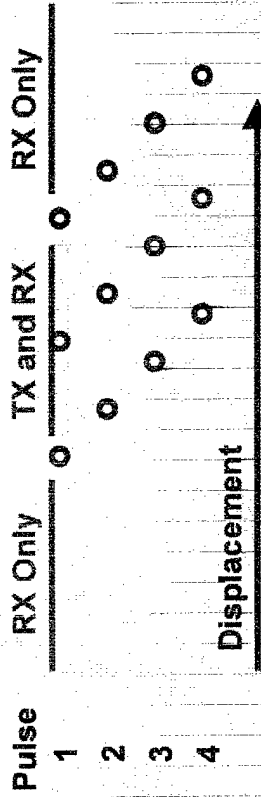

Clutter covariance depends only on the relative displacements of the receiver virtual phase centers.

$$\delta_{\Delta m, \Delta n} = \Delta m V_{AC} PRI + \Delta n \frac{d}{2}$$

$$[R_Z]_{(m_1, n_1), (m_2, n_2)} = R_{clutter}(\delta_{m_1 - m_2, n_1 - n_2}) + \delta(m_2 - m_1) \delta(n_2 - n_1) E_{thermal}$$

Thermal Energy Per Sample
(Boltzmann's equation)

Thermal Energy Temperature

$$E_{thermal} = k \times T \times F_n$$

Boltzmann's Constant Receiver Noise Figure

Simulation Parameters



Fixed Value
Nominal Value

Radar Parameters

Platform: Veridian DCS
 Transmit Power: $P_{\text{power}} = 3.5 \text{ kW}$
 Transmit/Receive Gain: $G_{\text{min}} = 29 \text{ dB}$
 Azimuth Beamwidth: $\beta_{az} = 5.25^\circ$
 Elevation Beamwidth: $\beta_{el} = 6.25^\circ$
 Wavelength: $\lambda = .03 \text{ m}$
 Pulse Width: $T = 45.5 \mu\text{s}$
 Noise Figure: $F_n = 2 \text{ dB}$
 Range Resolution: $\rho_r = .3 \text{ m}$
 PRF: $PRF = 2 \text{ KHz}$

Tag Parameters

Number of Taps: $N_{\text{bins}} = 200$
 Tag ERP: $ERP_{\text{tag}} = 0.4 \text{ W}$

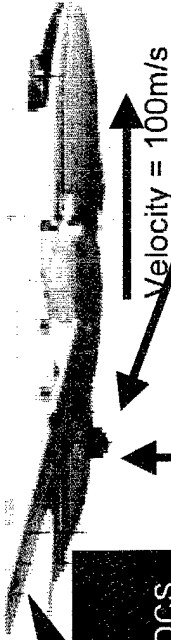

Altitude = 7.6 km

Velocity = 100 m/s

Range = 30 km

Clutter Parameters

Median CCSD: -15 dB

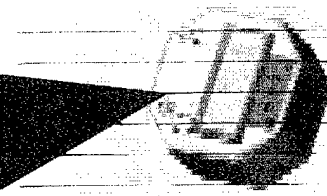

DCS Aperture Weighting

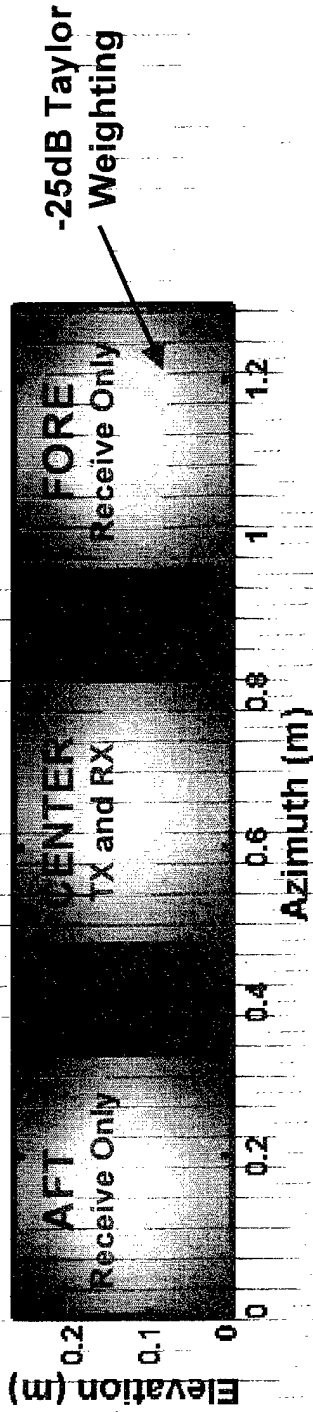



Capacities at Three Standoff Ranges

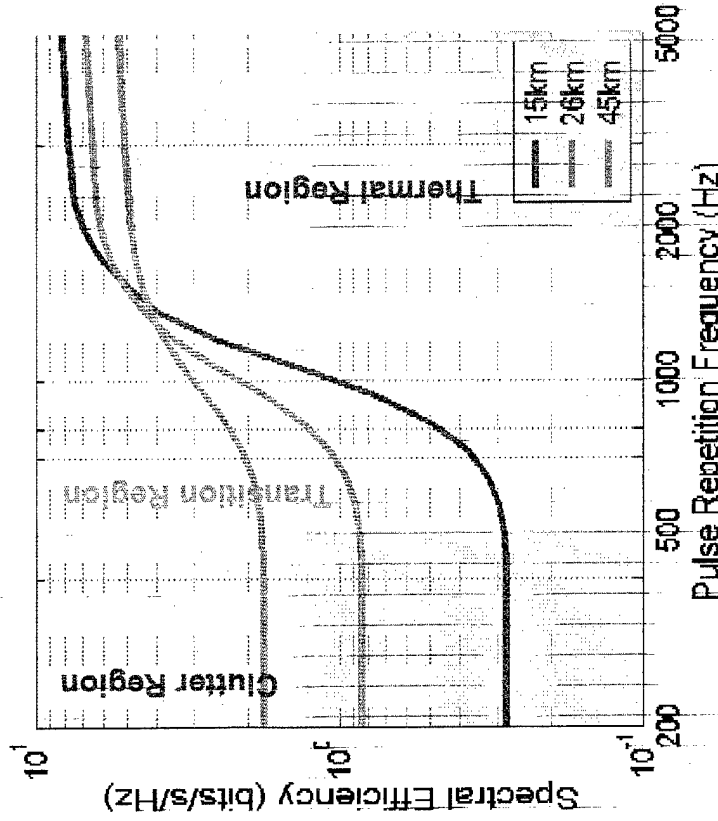
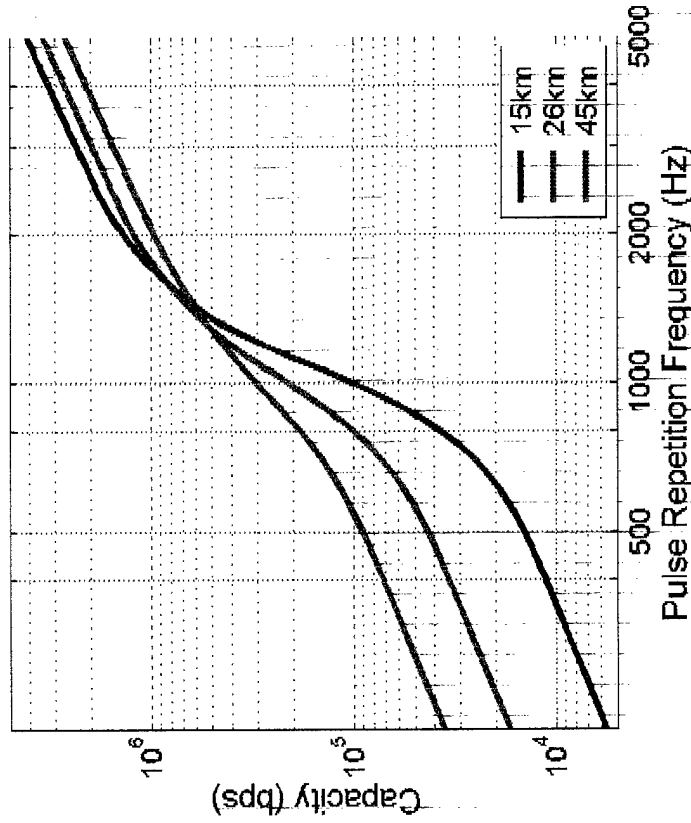

Model
UT-EOP
Res.
0.3 m

Single Receiver Observations

- Spectral efficiency is strongly influenced by PRF.
- The dominant source of residual interference (clutter vs. thermal) is determined by the radar PRF.
- In clutter dominated PRF region, capacity goes up with longer ranges.
- In thermal dominated PRF region, capacity goes down with longer ranges.

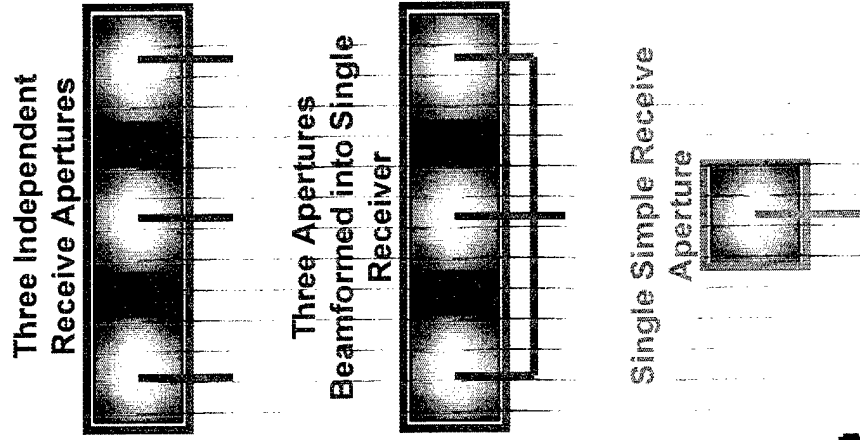
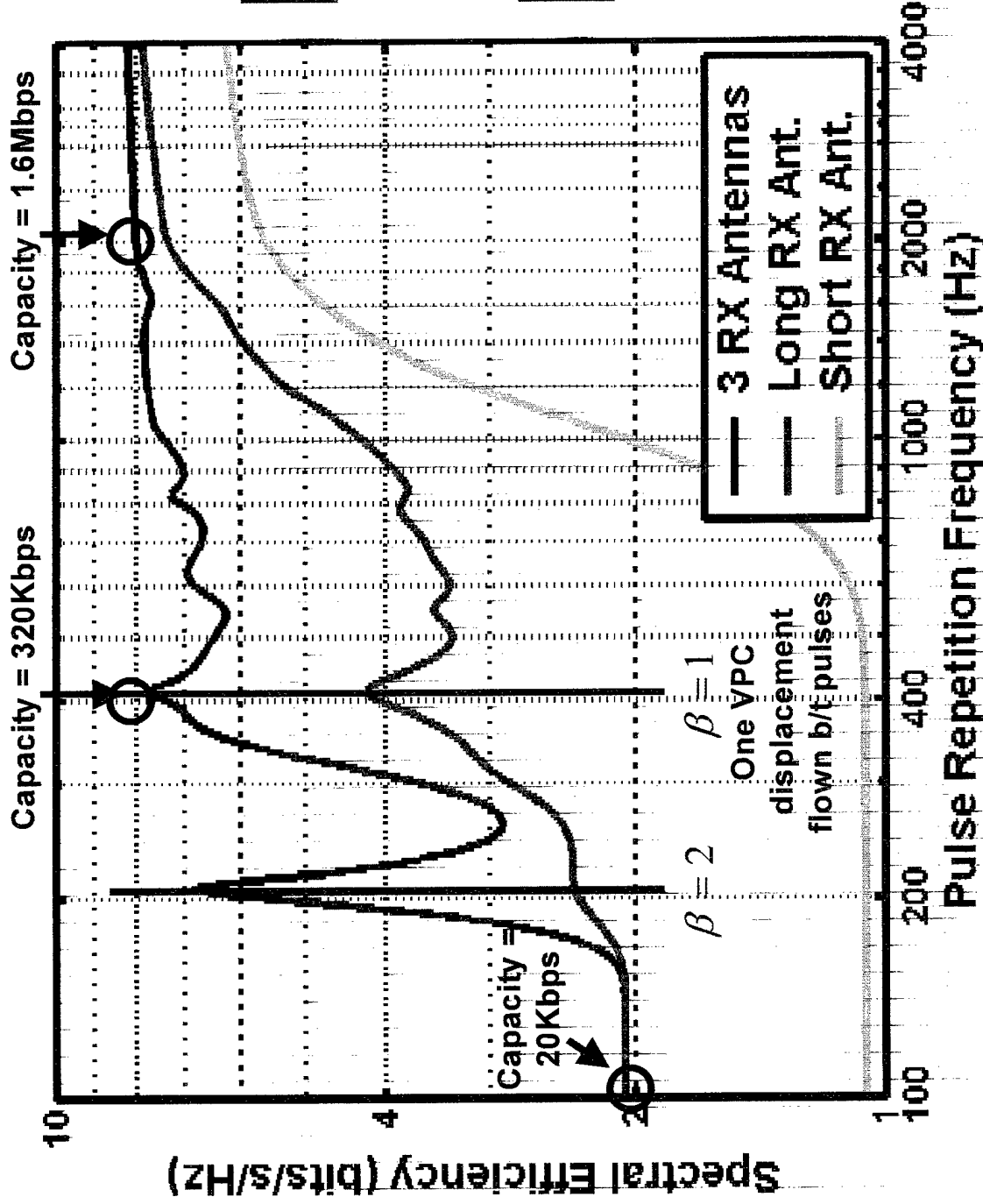

Summary

- RF tags combines elements of MIMO communications and GMTI STAP.
- Channel capacities of >1 Mbps are possible for representative radar and tag systems.
- A simple, general formula for the capacity of an injective MIMO channel was derived and used in calculating the channel capacity of a multiple receiver radar system.
- Multiple receive channel radars outperform single receive channel radars in medium PRF operation.
- High spectral efficiencies are possible even at low PRFs for a multiple receiver radar provided certain "DPCA-like" conditions are met.