

FRAGMENT-FIELD ANALYSIS TESTING SYSTEM

Richard Barnard and Peter Nebolsine*

Physical Sciences Inc.
20 New England Business Center
Andover, MA 01810

Abstract

Physical Sciences Inc. (PSI) developed for the USAF Air Armament Center (AAC), Eglin AFB an arena test explosive warhead fragment characterization system. PSI's FRagment-Field Analysis Testing (FRAT) system records a spatial impact location to an accuracy of approximately 1% of the screen area with a resolution time of 1 μ s. PSI's innovative approach detects impact locations by encoding an electrical signal that is location dependent. PSI's FRAT system provides substantial improvements over the current system, by better distinguishing between intermittent contacts of the same fragment and multiple fragments as well as recording simultaneous fragment impacts on the same impact switch screen. Spatially and temporally resolved fragment impacts can then be correlated with recovered fragment masses. The fragment mass and impact characterization data coupled with an existing computational model, produces range dependent representations of fragment velocity, momentum, and kinetic energy of warhead fragments. PSI's FRAT system also furnishes electronic interfaces with AAC's

Test Data Visualization System for enhanced data presentation.

Introduction

Warhead arena tests determine the characteristics of the fragment field from detonated warheads, following the standards and test methods outlined in the Joint Munitions Effectiveness Manual (JMEM).¹ The Vulnerability and Lethality Testing System (VALTS) at Eglin AFB has been used for decades to characterize fragment fields.² Approximately 100 large switch screens record the occurrence, spatial distribution, and time of discrete fragments. The current method uses 4 x 8 ft switch screens constructed of corrugated cardboard panels with flame sprayed aluminum electrodes on the front and aluminum foil electrodes on the back. After fragments pass through the screen, they bury themselves in large bundles of Celotex that are typically 6 ft thick. The fragments are later recovered, weighed, and correlated with holes in the switch screen. Table 1 identifies the system parameters common to arena testing.

Table 1. Test Parameters and FRAT System Specifications

Testing Parameters	
Total mass to fragmenting warhead, lb	1 to 2000 lb
Charge to mass ratio	0.2 to 0.3
Gurney constant $(2E)^{1/2}$, for explosives, km/s	1.9 to 2.6 prompt (brittle) to 3.0 terminal (ductile)
Distance to screens, ft	8 to 90
Blast wave pressure level at screens, psi	15 to 30
Average velocity of fragments, ft/s	2500 to 6000; 762 to 1820 m/s
Screen thickness, cm	0.4
Approximate contact time, μ s	5.5 to 13
Characteristic fragment size, cm	1.5
Average velocity of blast wave, fps	1000 to 2000
Percentage of screen area in holes	5 to 20
Number of collected fragments/screen	20 to 50
FRAT System Specifications	
Number of screens	96 (32 for delivered system)
Screen area	32ft ² , nominal
Spatial resolution	Nominally, 1%
Test data storage duration	43 ms, max
Temporal resolution/screen	1 mega-sample/s rate, 1 μ s

*Member AIAA

Report Documentation Page

*Form Approved
OMB No. 0704-0188*

Public reporting burden for the collection of information is estimated to average 1 hour per response, including the time for reviewing instructions, searching existing data sources, gathering and maintaining the data needed, and completing and reviewing the collection of information. Send comments regarding this burden estimate or any other aspect of this collection of information, including suggestions for reducing this burden, to Washington Headquarters Services, Directorate for Information Operations and Reports, 1215 Jefferson Davis Highway, Suite 1204, Arlington VA 22202-4302. Respondents should be aware that notwithstanding any other provision of law, no person shall be subject to a penalty for failing to comply with a collection of information if it does not display a currently valid OMB control number.

1. REPORT DATE 00 MAR 2001	2. REPORT TYPE N/A	3. DATES COVERED -			
4. TITLE AND SUBTITLE Fragment-Field Analysis Testing System2		5a. CONTRACT NUMBER			
		5b. GRANT NUMBER			
		5c. PROGRAM ELEMENT NUMBER			
6. AUTHOR(S)		5d. PROJECT NUMBER			
		5e. TASK NUMBER			
		5f. WORK UNIT NUMBER			
7. PERFORMING ORGANIZATION NAME(S) AND ADDRESS(ES) Physical Sciences Incorporated 20 New England Business Center Andover, MA 01810		8. PERFORMING ORGANIZATION REPORT NUMBER			
9. SPONSORING/MONITORING AGENCY NAME(S) AND ADDRESS(ES)		10. SPONSOR/MONITOR'S ACRONYM(S)			
		11. SPONSOR/MONITOR'S REPORT NUMBER(S)			
12. DISTRIBUTION/AVAILABILITY STATEMENT Approved for public release, distribution unlimited					
13. SUPPLEMENTARY NOTES See also ADN201408.					
14. ABSTRACT					
15. SUBJECT TERMS					
16. SECURITY CLASSIFICATION OF:			17. LIMITATION OF ABSTRACT UU	18. NUMBER OF PAGES 5	19a. NAME OF RESPONSIBLE PERSON
a. REPORT unclassified	b. ABSTRACT unclassified	c. THIS PAGE unclassified			

When a warhead fragment impacts the switch screen, it produces electrical contact between the front and rear sides, creating a short and generating a binary electrical signal. While VALTS provides valuable temporal data for each 32 ft² resolution area, there is currently no reliable method for correlating specific events detected with the switch screens and the collected fragments. The current switch screens provide gross spatial resolution (~32 ft²) and do not produce a high degree of impact time and impact location correlation when there are many impacts. In addition, VALTS cannot distinguish between intermittent fragment contacts and multiple fragments and is unable to detect overlapping or simultaneous impacts. PSI's FRAT system addresses these shortcomings.

FRAT System Design

PSI developed and demonstrated an approach that greatly improves the spatial resolution without increasing the number of data channels. PSI accomplished this effort under a Small Business Innovative Research (SBIR) contract with the U.S. Air Force. PSI's FRAT system yields a spatial impact point determination accuracy of approximately 0.38 ft² per 32 ft² screen and a resolution time of 1μs using a single coaxial data cable per screen. PSI's design provides for an encoding of the signal dependent on impact location by segregating the switch screen into 84 discretely encoded areas. A solution to minimize the confusion between intermittent contacts of a single fragment vs simultaneous impacts of multiple fragments is to use a large number of detection zones. However, to increase the linear spatial resolution by a modest factor of 10 would require approximately 10,000 channels. This would result in a dramatic increase in data recording capacity as well as a much more labor intensive and time consuming effort to lay 100 times as many cables, and check each for correct connections and continuity.

The FRAT system modifies Dahlgren style switch screens to associate with new data acquisition electronics. Each side of the Dahlgren screen is divided into resolution areas such that when a fragment impacts PSI's modified screens, electrical contact is made between the front and rear resolution areas. PSI's design measures a discrete voltage that is dependent on impact location. The basic arrangement is shown in Figure 1. A drawback to PSI's approach is that the impact screens take longer to fabricate and have more electrical connections that are vulnerable to fragments. However, the screen design only requires slight

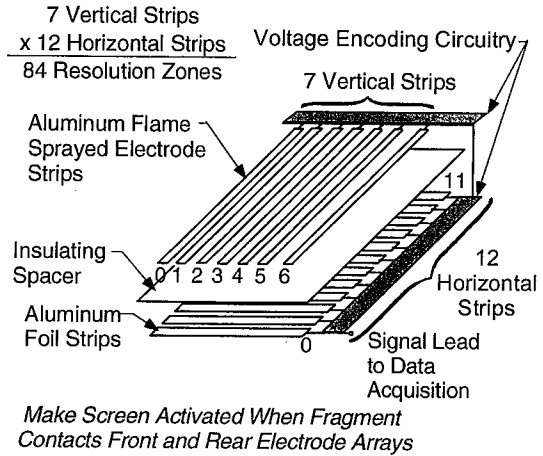

Figure 1. Schematic of PSI multiplexed switch screen.

modifications and the results provide dramatic improvements in data acquisition by providing a method to correlate specific fragments to specific impact times and increased spatial resolution over using traditional binary Dahlgren style screens.

PSI's innovative screen design enables the FRAT system to distinguish between intermittent contacts of one fragment or closely spaced impacts of multiple fragments, as well as record simultaneous impacts on one impact switch screen. Figures 2 and 3 illustrates temporal traces of various impact scenarios from a conventional binary style switch screen, and a FRAT impact screen. Because the FRAT system spatially encodes the impact locations, it is able to distinguish between these types of events providing a clear

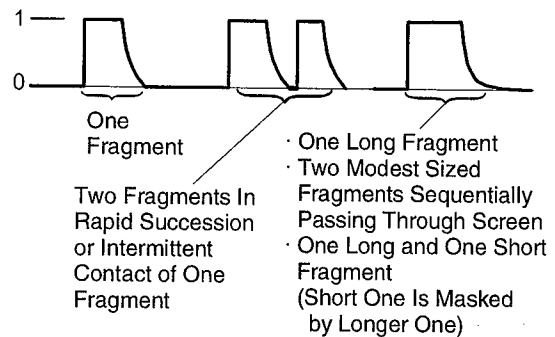

Figure 2. Conceptual data from binary switch screen showing nominal trace, two fragments in rapid succession, and a long fragment, two sequential fragments, or hidden fragment.

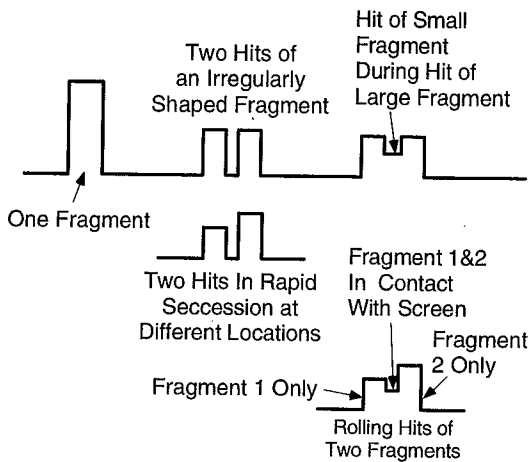

Figure 3. Conceptual data from FRAT system, showing the same cases as shown in Figure 2, identifying removal of key ambiguities.

advancement in capability over the binary switch screen approach.

PSI's architecture sends the voltages measured from each of four impact screens into an enclosure that conditions the signal and multiplexes four channels onto one coax cable. This configuration, illustrated in Figure 4 reduces the data acquisition and data storage requirements of the system. These enclosures are protected with EMI shielding gaskets with data interfaces to the impact screens and signal outputs to the data acquisition system. High-speed analog-to-digital converter (ADC) cards digitize and store data on board for each channel. An external clock frequency drives the digitization rate so that it is synchronous with the screen multiplexing. An automated data analysis

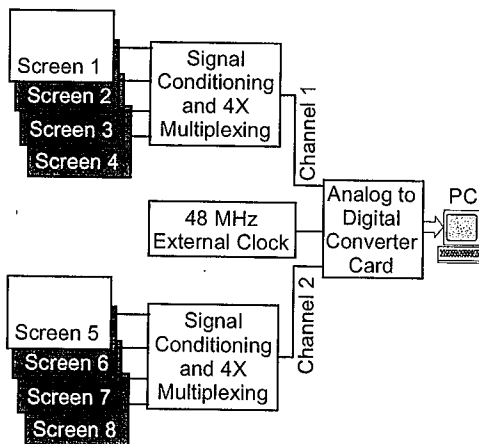

Figure 4. Design architecture for signal flow and processing of FRAT data.

software routine demultiplexes the data into individual signals for each impact screen, determines whether an impact has occurred, and then calculates the impact time, duration, location, and velocity (based on the distance from the warhead and the impact time from detonation). Figure 5 illustrates the graphical user interface control panel with sample data from a demonstration test that is discussed in the following section.

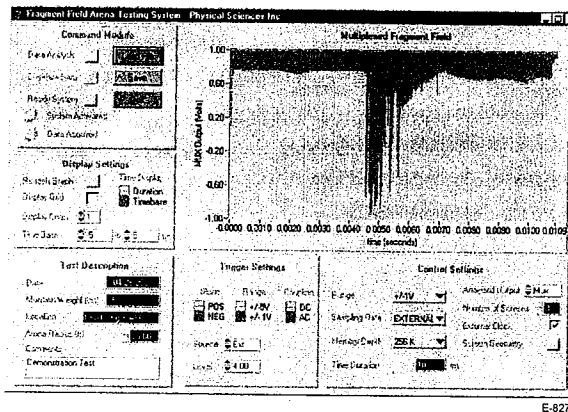

Figure 5. Graphical user interface control panel for FRAT System.

Demonstration Testing

In order to perform bench-top testing of the FRAT system, a simple collection of momentary mechanical switches were assembled. The switches were connected to one or more FRAT screens in such a way that when the momentary switches closed, it would be identical to fragments shorting the front and rear electrodes of a FRAT screen. Since the contact times of the momentary switches were not controlled, random fragment impacts were simulated. Figures 6 and 7 are examples that illustrate the changes in detected voltage

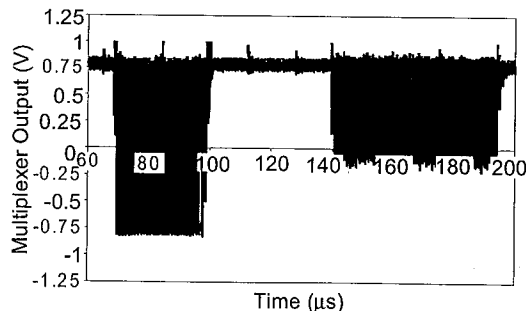

Figure 6. Multiplexed test data from four screens using a momentary switch test apparatus for two impacts on one screen in rapid succession.

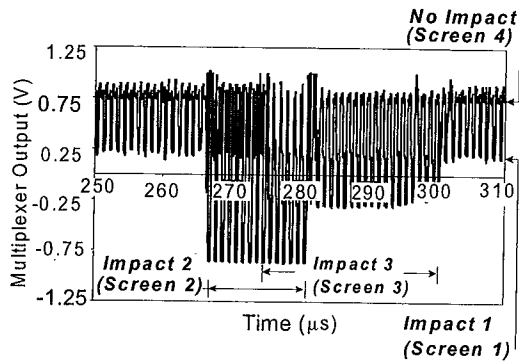

Figure 7. Near simultaneous impacts on multiple screens using momentary switch test apparatus.

level when electrical contact was made using this test apparatus. Subsequent system performance tests were performed with fragments launched from a shot gun and later pipe bomb tests.

PSI performed live warhead demonstration tests of its system at Eglin AFB. Figure 8 is an example of the recorded electrical signal caused by fragment impacts. Non-ideal performance is ascribed to poor electrical contact made by the fragments and the impact screen electrodes. In April 2000, the test consisted of approximately 8 lb of explosive material contained within a cylindrical pipe bomb case.³ The bomb was located approximately 5.75 feet above the ground and 20.1 feet from the radial geometry of the impact screen arena as specified by JMEM. Eight FRAT screens were used, each divided into 84 resolution areas and paired to a VALTS screen. This arena geometry produced a direct comparison of test data from the FRAT spatially resolved system and the VALTS spatially unresolved system. The FRAT data acquisition system was located in the underground bunker approximately 100 feet away from the arena and controlled remotely from the

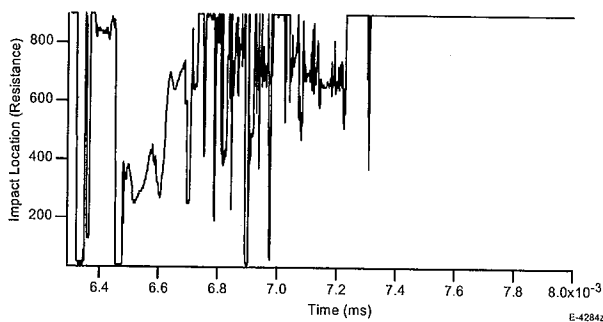

Figure 8. FRAT System live warhead test data from one impact screen with multiple fragment impacts.

control bunker (approximately 1500 ft from the underground bunker) using two RS-232 coax drivers and "PCAnywhere" software. Figure 9 illustrates the arena setup for the eight screen demonstration test.

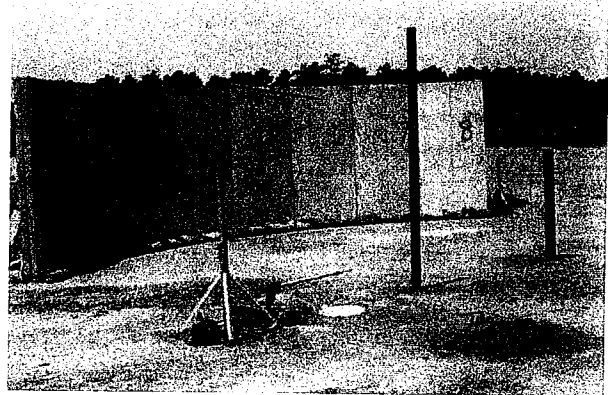

Figure 9. Test configuration for FRAT Demonstration Test #2.

The FRAT system accurately identified fragment impact locations to better than 5% accuracy of the 32 ft² screen area. With tens of fragment impacts on a 4 x 8 ft screen, the FRAT system is able to distinguish between intermittent contacts of the same fragment and multiple fragments, as well as distinguish nearly simultaneous fragment impacts on the same impact switch screen. However, no attempt was made to recover the fragments, so the total number of fragments and their actual impact locations are unknown. The FRAT system was able to detect approximately 70% of the fragment impacts that it electrically recorded, although it was unable to accurately determine impact locations of fragments with extremely brief electrical impact durations (< 3 μs). Of the recorded impacts, the FRAT system spatially matched 75% of the temporally correlated impacts to better than 5% accuracy of the 32 ft² screen area when compared to VALTS data.

The test configuration identified the specific improvements of the FRAT system over the current VALTS system in characterizing fragment fields. Since, the VALTS system is unable to detect simultaneous impacts on a single impact screen, the FRAT system was able to record approximately 50 to 70% more impacts. The FRAT system obtained 20 times better spatial resolution than is currently available with a full-size 32 ft² impact screen. PSI's architecture that includes a four-screen multiplexer also reduced the required number of data channels by a factor of four as compared to the VALTS system.

Summary

PSI developed and demonstrated an approach that makes significant advances compared to current techniques. The FRAT system provides much finer spatial resolution for the location of fragment impacts than VALTS. The FRAT system provides a spatial impact point determination accuracy of roughly 1% of the nominal 32 ft² impact switch screen area and a resolution time of 1 μ s. PSI's design accomplishes its spatial encoding for each fragment by measuring a discrete voltage that is dependent on impact location. The FRAT system is therefore able to distinguish between intermittent contacts of the same fragment and multiple fragments, as well as record simultaneous fragments on the same impact switch screen. These new enhanced capabilities are accomplished with modest changes to the AF AAC setup and testing procedures while reducing the number of data channels by a factor of four.

With spatially and temporally resolved fragment impacts, the Air Force can, in future tests, correlate electrically recorded impacts with recovered fragment masses. With this capability, the system allows for each fragment's electronically recorded contact time to be matched with the recovered fragments (mass and dimensions). Hence, for each pair of impact time and recovered fragment mass, a velocity can be determined for that individual fragment. The FRAT system coupled with the JMEM velocity slowdown computational model, provides a significantly enhanced capability to predict fragment velocity with range as the end product. The visualization of the results is enhanced with electronic interfaces with the Test Data Visualization System (TDVS) developed by Physitron.⁴

The delivered system to Eglin AFB has a 32-screen capacity with expansion potential to 96 screens. Future work might involve installing additional data acquisition capabilities and replicating the instrumentation enclosures up to full 96 screen capacity. Additional improvements to the system could include modifications or the redesign of the impact switch screens. The current switch screen design yields variable contact resistances when the fragment passes through the impact screen creating an ambiguous or unknown impact location. With further testing of the delivered system, improvements will be made to the automated data analysis system to accurately interpret FRAT fragment field data and minimize errors.

Acknowledgement

The authors would like to acknowledge the support of the USAF Air Armament Center via Contract Nos. F08635-96-C-0030 and F08635-97-C-0038 and the interest of its personnel directly involved in this project including Dr. William Dyess, George Williams, Ian Talbot, and Norman Gagnon. The help, guidance, and support provided by Capt. Christopher Manley and Phillip Lett, test directors for the two tests at C-80C, and the on-sit crew at C-80C, especially Rick Nicholson and Larry Elkins, is also acknowledged.

We also acknowledge our subcontractor's: H.P. White Laboratories, Street, MD for the hand grenade tests as well as Physitron, Huntsville, AL, for software to display FRAT data within their Test Data Visualization System delivered to C-80C.

Finally, we also recognize the individual and collective efforts of the PSI team, whose contributions were invaluable. The PSI team included Peter Nebolsine, Rick Barnard, Norm Humer, Mike Hinds, Jan Poley, Greg Lord, Dan Ferguson, Ed Lo, and Andy Burbo.

Acknowledgment of support and disclaimer: DFAR 252.235-7010 (May 1995): This material is based upon work supported by the Department of the Air Force under Contract No. F08635-97-C-0038. Any opinions, findings and conclusions or recommendations expressed in this material are those of the authors and do not necessarily reflect the views of the Department of the Air Force.

References

1. "Testing and Data Reduction Procedures for High-Explosive Munitions," Joint Munitions Effectiveness Manual (JMEM), USAF 61A1-3-7, Revision 2, 8 May 1990.
2. Shelley, S.O., "Vulnerability and Lethality Testing System (VALTS)," USAF Armament Development and Test Center, Eglin AFB, FL, ADTC-TR-72-127, AD909145, December 1972.
3. Barnard, R., Nebolsine, P., "Fragment-Field Arena Testing System. Quarterly Progress Report No. 11," Test Report prepared for Department of the Air Force, Eglin AFB, under Contract No. F08635-97-C-0038, PSI-1273, June 2000.
4. Keiper, D. and Price, M., "Test Data Visualization System (TDVS)," Final Report, PHY-99R017, Physitron, Inc., Huntsville, AL, 30 November 1999.