

Joint Service Chemical and Biological Defense Program

DISTRIBUTION STATEMENT A
Approved for Public Release
Distribution Unlimited

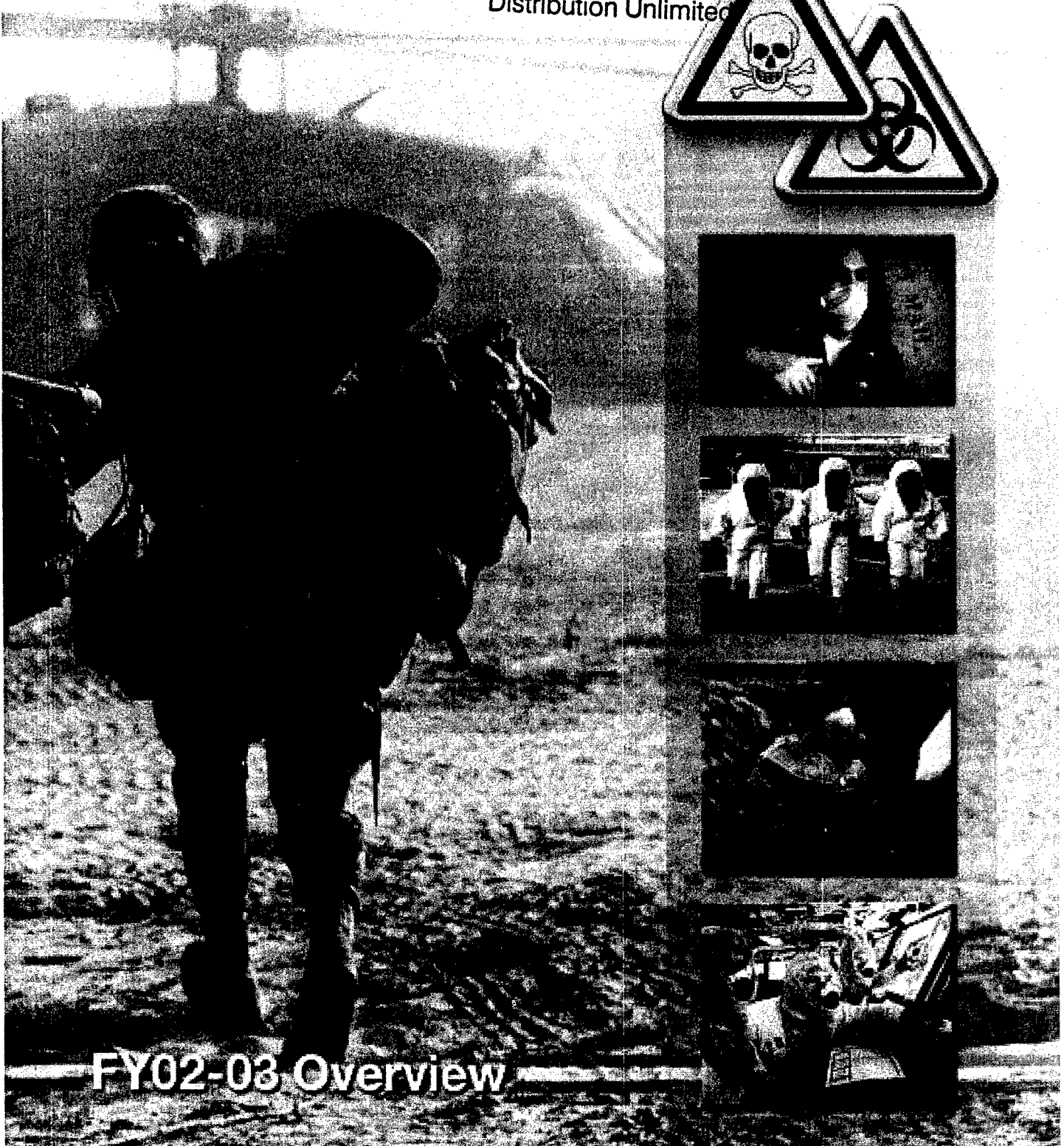

FY02-03 Overview





Through Public Law 103-160, Section 1703, Congress established a Joint Service Chemical and Biological Defense Program (CBDP). The mission of the CBDP is to provide world-class chemical and biological defense capabilities to allow military forces of the United States to survive and successfully complete their operational missions—in battlespace environments contaminated with chemical or biological warfare agents. Under the oversight of a single office within the Office of the Secretary of Defense, the Deputy Assistant to the Secretary of Defense for Chemical and Biological Defense, the individual Services, working within the framework of a Joint Service Agreement, have planned and supported a robust, coordinated program. This document provides an overview of our major focus area efforts, providing a summary of FY01 accomplishments and goals set for FY02 and beyond. An additional publication, the DoD Annual Report to Congress on the Chemical and Biological Defense Program, provides a more detailed look at programmatic accomplishments as well as the roadmap to the future.

Although U.S. forces enjoy superiority in many dimensions of the battlespace, the United States is likely to be faced with adversaries at home and abroad who possess a wide range of asymmetric capabilities, to include chemical and biological weapons, that challenge our forces' ability to fight and win. To counter the threat of chemical and biological warfare, the CBDP focuses on research, development, and acquisition programs that support the three tenets of chemical and biological defense, contamination avoidance (to include detection and identification) and NBC battle management (to include reconnaissance and early warning); force protection (to include individual protection, collective protection, and medical support); and decontamination.

Since September 11, 2001, the visibility and priority of the CBDP has significantly increased. This has required a transformation of the program to meet the global challenges of the 21st Century. This transformation involves the expansion of the scope of current efforts in order to support homeland security and combating terrorism initiatives of the President and the Department. The FY03 budget request provides funding for a number of new Homeland Security initiatives; including a Center for Biological Terrorism Research, a comprehensive program to build a National Biological Defense System for the Office of Homeland Security, a Joint Service Installation Protection Project, and continued equipping of the 32 WMD Civil Support Teams. Our primary objective remains support for the warfighter. Collectively, the past and future efforts of the CBDP will ensure that all U.S. men and women fighting on our homeland or abroad have the full dimensional protection required to succeed in the presence of chemical and biological warfare threats.

ANNA JOHNSON-WINEGAR, PH.D.

DEPUTY ASSISTANT TO THE SECRETARY OF DEFENSE
FOR CHEMICAL AND BIOLOGICAL DEFENSE

DISTRIBUTION STATEMENT A
Approved for Public Release
Distribution Unlimited

20040517 023

■ Threat	
Global Threat.....	2
Support to Joint Vision 2020	4
Integrated Approach to Counter the Threat	6
■ Contamination Avoidance	
Automatic Chemical and Agent Detector Alarm (ACADA).....	8
Artemis	10
Biological Integrated Detection System (BIDS).....	12
Improved Point Detection System (IPDS)	14
Joint Biological Point Detection System (JBPDS)	16
Joint Biological Standoff Detection System (JBSDS).....	18
Joint Chemical Agent Detector (JCAD).....	20
Joint Service Lightweight Nuclear, Biological, Chemical Reconnaissance System (JSLNBCRS).....	22
Joint Service Lightweight Standoff Chemical Agent Detector (JSLSCAD).....	24
NBC Reconnaissance System Modifications	26
■ Protection	
Chemical Biological Protective Shelter (CBPS/P3I).....	28
Chemically Protected Deployable Medical System (CP DEPMEDS)/Chemically Hardened Air Transportable Hospital (CHATH)	30
Collective Protection System (CPS) Backfit/ Shipboard Collective Protection Equipment (SCPE)	32
Joint Collective Protection Equipment (JCPE)	34
Joint Protective Aircrew Ensemble (JPACE)/ Joint Service Aircrew Mask (JSAM)	36
Joint Service General Purpose Mask (JSGPM)	38
Joint Service Lightweight Integrated Suit Technology (JSLIST/JSLIST P3I).....	40
Joint Transportable Collective Protection System (JTCOPS)	42
■ Medical	
Joint Biological Agent Identification and Diagnostic System (JBAIDS)	44
Medical Vaccines	46
Medical CB Products	48
Medical Pretreatments	50
Medical CB Therapeutics and Diagnostics	52
■ Decontamination	
Joint Service Fixed Site Decontamination (JSFXD)	54
Joint Service Sensitive Equipment Decontamination (JSSED).....	56
Modular Decontamination System (MDS)	58
Sorbent Decontamination	60
■ Battle Management	
Battle Management.....	62
Joint Effects Model (JEM).....	64
Joint Warning and Reporting Network (JWARN)	66
■ Homeland Defense	
Joint Service Installation Protection Program (JSIPP).....	68
Homeland Security/WMD-CSTs	70
■ Science and Technology	
Science & Technology	72
Advanced Concept Technology Demonstrations (ACTDs).....	74
■ Management	
CBDP Funding	76
■ CB Defense Resources	
Acronyms.....	78
NBC Defense on the Web	80

A Dangerous World...

- *War on Terrorism*
- *Proliferation of WMD Technology*
- *Dual Use Production Capabilities*



National Response...

- **International Agreements**
 - Chemical Weapons Convention (CWC)
 - Biological and Toxin Weapons Convention (BWC)
 - Missile Technology Control Regime (MTCR)
- **National Security Strategy**
 - Homeland Defense/Force Protection
 - Counterproliferation Support Program
 - Domestic Preparedness Program
 - Crisis Management
 - Consequence Management
 - Federal (Integrated Task Forces, Focused Investment Strategies)
 - State/Regional (Federal-State Coordination, State of Emergency Services)
 - Local (e.g., First Responders, Incident Command System)

...A Fully Integrated Program

(Intelligence, Operating Structures, Tools)



Elements of National Response

Strategic and Tactical Intelligence
 Battlefield Surveillance
 Passive Defense
 Proliferation Prevention
 Active Defense
 Counterforce
 Countering Paramilitary/Terrorist Threat

- Contamination Avoidance
- Decontamination
- Protection (Individual/Collective)
- Medical
- Modeling & Simulation

Focused Investments Directly Responsive to Operational Requirements

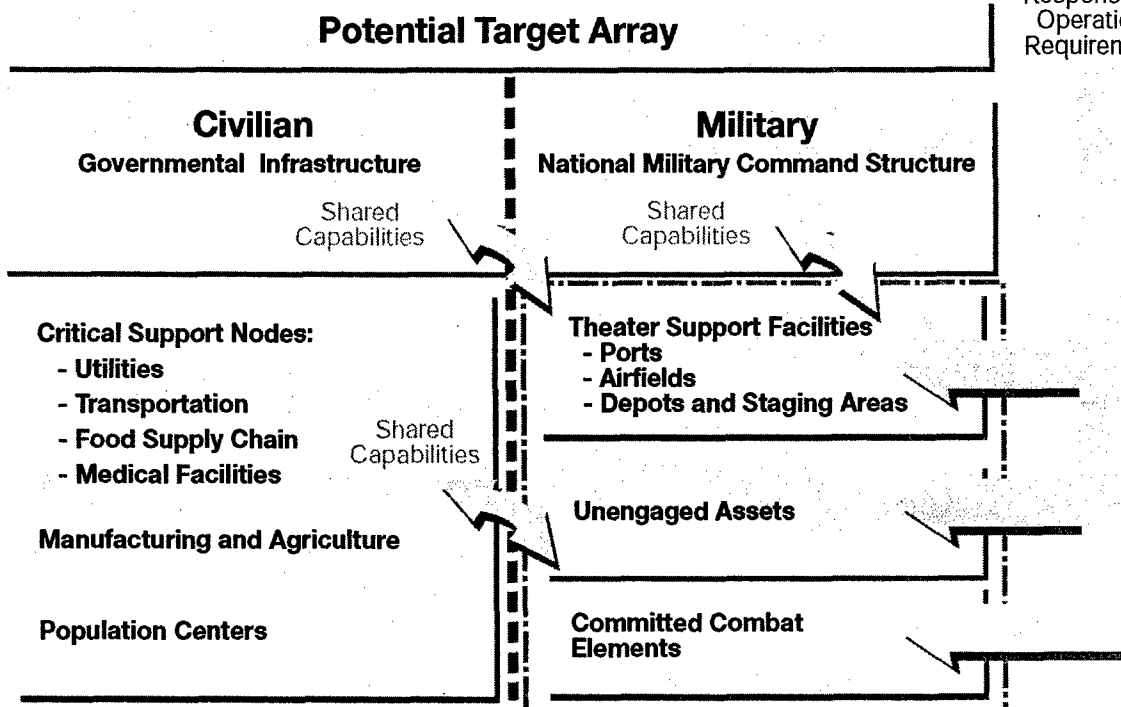

A Full Partner in Preparedness

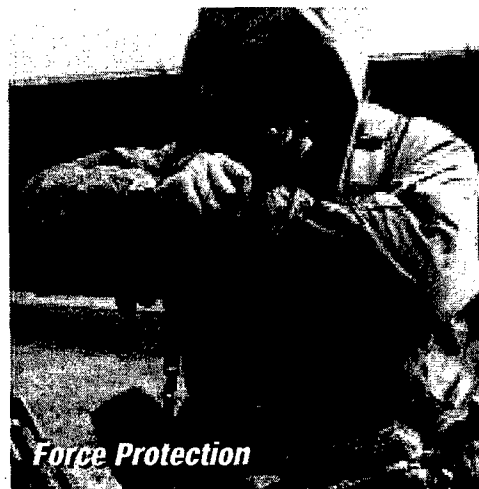

Dominant across the full spectrum of military operations – persuasive in peace, decisive in war, and preeminent in any form of conflict... These are the goals of Joint Vision 2020, the vision that guides the continuing transformation of America's Armed Forces.

Implementing the Vision

The focus of Joint Vision 2020 is full spectrum dominance, which is achieved through the interdependent application of dominant maneuver, precision engagement, focused logistics, and full dimensional protection. Attaining that goal requires a steady infusion of new technology, modernization, replacement of equipment, as well as the doctrine, training and leader development necessary to exploit and enhance the advantages of technology.

Dominant Maneuver

... the ability of joint forces to gain positional advantage with decisive speed and overwhelming operational tempo in the achievement of assigned military tasks.

Challenge: Adversaries may use chemical and biological weapons to restrict our areas of operation, negate our advantages in speed and operational tempo, and disrupt critical command and control functions.

Required Capabilities: U.S. forces must be able to "see" the otherwise invisible chemical and biological hazards, avoid contaminated areas when possible, and continue to operate at the highest possible operational tempo. Integrated sensor networks and battlespace management systems will allow operational tempo to be maximized while attempting to avoid contaminated areas. When unable to avoid contaminated areas, U.S. forces will employ individual and collective protection equipment, and medical pretreatments to continue operations at high levels of effectiveness. Combat power is restored as soon as possible by decontamination and medical treatment. The synergistic combination of avoidance, protection, and rapid restoration of combat power allows the Joint Force Commander — not the chemical and biological threat — to dictate the tempo of the conflict.



Precision Engagement

... the ability of joint forces to locate, monitor, discern, and track objectives or targets. The pivotal characteristic of precision engagement is the linking of sensors, delivery systems, and effects.

Challenge: Chemical and biological warfare can dramatically disrupt the real-time command, control, communications, intelligence, and execution linkage that is necessary to support precision engagement operations.

Required Capabilities: U.S. forces must be able to continue to operate all critical linkages of the precision engagement chain, at high levels of effectiveness and under CB threat conditions. Sensitive command and control equipment must remain operational during CB attacks and must survive the contamination and decontamination process. Maintaining air sortie generation rates is critical to providing surveillance, tracking and rapid engagement. The ability to sustain the precision engagement campaign will allow U.S. forces to deliver lethal and non-lethal effects throughout the full depth of the battlespace.

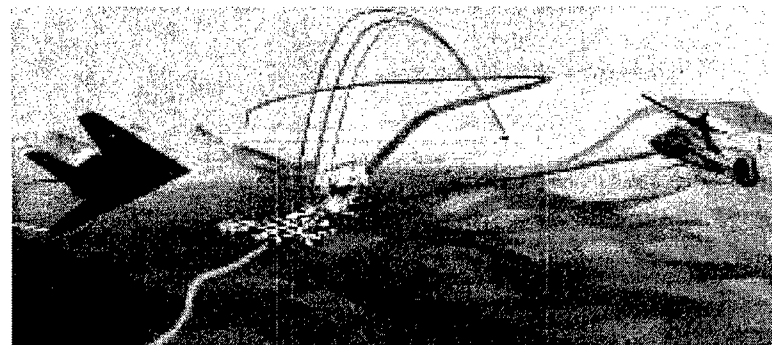

In future operations, U.S. forces will encounter sophisticated adversaries, who will adapt as our capabilities evolve. Future opponents will avoid our strengths and exploit our weaknesses. Adversaries will use asymmetric approaches, such as chemical and biological weapons, to attempt to deter, delay, or counter the application of U.S. military capabilities. These asymmetric approaches may be the most serious danger that the United States faces.

The Chemical and Biological Defense Program addresses the doctrine, training, and equipment support required to counter this threat. This ensures that our forces are ready to protect themselves and deliver victory for our Nation in the uncertain environment of the current and future battlefield.

Focused Logistics

... the ability to provide the joint force with the right personnel, equipment, and supplies in the right place, at the right time, and in the right quantity, across the full range of military operations.

Challenge: The joint logistics system will evolve from a supply-based process, with large, in-place stocks of materiel, to a distribution-based process with time-definite delivery requirements. In the past, the protection of the logistics system focused on the "supplies." With this change, the focus will shift to the protection of distribution systems and logistics command and control nodes.



Required Capabilities: As the "piles of supplies" disappear from the joint battlespace, the protection of the logistics system becomes critical to projecting and sustaining forces in anti-access and area-denial environments. Ports and airfields must sustain their throughput rates, while operating at high effectiveness under CB threat and recovering rapidly from CB attacks. Logistics operations must have the detection, protection, and decontamination resources to keep supplies flowing to the joint force. The protection of the logistics command and control capability will be critical.

Full Dimensional Protection

... the ability of the joint force to protect its personnel and other assets required to decisively execute assigned tasks.

Challenge: The history of chemical and biological warfare is one of surprise. U.S. forces must be prepared for the introduction of new threats and new agents. With smaller numbers of forces in the theater of operation, the degradation of performance associated with legacy protective equipment will no longer be acceptable. U.S. forces must be able to maintain an advantage in operational tempo under CB threat conditions.

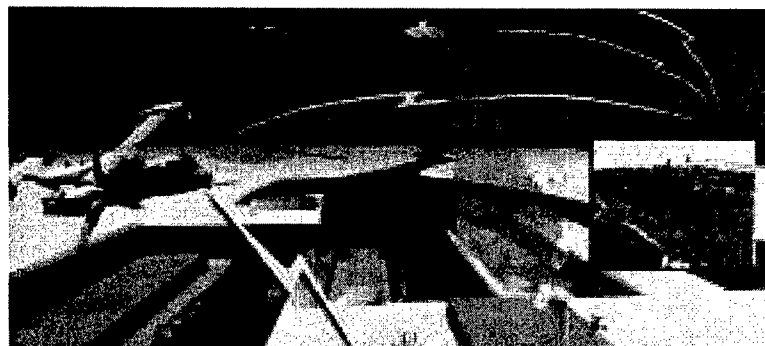

Required Capabilities: Detection, identification, medical, and protection capabilities must counter the evolving threat. Individual and collective protection equipment must allow individuals and crews to operate high-technology systems without significant degradation in performance. Real-time information, combining intelligence, operational, detector, and meteorological inputs, must be available to provide commanders with an "up-to-the-minute" picture of the CB battlespace. This will allow organizations to operate at maximum effectiveness, with an acceptable level of CB risk. This will also deny our adversaries the political, psychological, and military advantages of CB weapon use, and provide our Nation with a force that is truly dominant across the full spectrum of military operations.

The Chemical and Biological Defense Program (CBDP) invests in technologies, doctrine development, and realistic training to provide improved capabilities to the Joint force ensuring minimal adverse impact to operational tempo on the asymmetric battlefield. CB defense programs are categorized broadly under five commodity areas:

Contamination Avoidance

Concept: The earliest possible warning is fundamental in avoiding chemical and biological agent contamination. The goal of battlespace contamination avoidance is to provide a real-time capability to detect, identify, map, quantify, and avoid biological and/or chemical agents, including selected Toxic Industrial Chemicals/Materials (TICs/TIMs).

Focus: The CBDP pursues technologies incorporating and integrating standoff and early warning; reconnaissance; biological and chemical point detection; and information processing. The technology focus is on increased detection sensitivity, lower detection thresholds, specificity across the evolving spectrum of threat agents, reduced false alarm rates, and integration of NBC detectors into various mapping and communication networks to provide common warning and reporting to the joint force.

Protection (Individual/Collective)

Concept: If units are attacked or are forced to occupy or traverse CB contaminated environments, individual and collective protection systems provide the warfighter life-sustaining and continued operational capabilities. Individual protection equipment includes protective masks, suits, boots, and gloves. Collective protection equipment includes two general categories: stand-alone shelters and integrated systems that provide contamination-free, environmentally-controlled surroundings for personnel to perform their missions. Collective protection, i.e., overpressure, can be applied to mobile and fixed command posts, medical facilities, rest and relief shelters, buildings/fixed sites, vehicles, aircraft, and ships.

Focus: The CBDP is pursuing mask technologies that provide greater user comfort, reduce breathing resistance, and improve compatibility with combat weapon systems; and suit technologies that will result in lighter, less burdensome, but equally protective next generation suits for ground and aviation personnel. Also, the CBDP pursues technology advances that improve generic CB protective filters and fans, and advances that reduce weight, volume, cost, logistics, and manpower requirements.

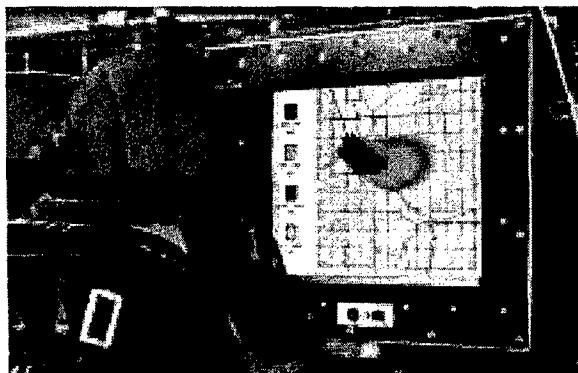

Medical

Concept: Efforts include development of medical materiel and equipment items necessary to provide an effective medical defense against chemical and biological agent threats facing U.S. forces on the battlefield.

Focus: Chemical defense efforts include development of pretreatments, therapeutic drugs, diagnostic equipment, and other life-support equipment for protection against chemical warfare agents and management of chemical warfare casualties. Biological defense efforts include development of vaccines, drugs, and diagnostic medical devices for protection against validated biological warfare agents to include bacteria, viruses, and toxins of biological origin.

Decontamination

Concept: In the event that contamination cannot be avoided, personnel and equipment must be decontaminated in order to reduce and/or eliminate hazards after chemical and biological agent employment. A family of decontaminants and applicators, equipment, and procedures are under development for decontaminating mission critical areas within large area ports, airfields, and other fixed sites, which may be targeted for persistent agent contamination. Decontamination systems provide the Joint Force a regeneration capability for units that become contaminated. Modular decontamination systems have been developed to provide decontamination units with the capability to tailor their equipment to support specific missions.

Focus: The CBDP is pursuing technology advances in sorbents, coatings, and physical removal, which will reduce logistics burden, manpower requirements, and lost operational capability associated with decontamination operations.

Battle Management

Concept: Battle Management efforts are focused on meeting emerging requirements in the CBDP to provide standardized CB analysis efforts across the Services. The goal is to generate valid Joint requirements, develop Verification, Validation, and Accreditation (VV&A) standards, develop policies and procedures for M&S standardization, develop tools to establish and maintain battlespace situational awareness, and create a virtual proving ground for CB testing.

Focus: The CBDP is pursuing technologies that provide for a standardized representation of the effects and environments associated with CB agent employment, reaching across the domains of analysis, training, and acquisition. The Battle Management effort will provide the CB community with models, suites, and systems that will accurately model release sources, atmospheric transport and dispersion, casualty predictions, unit degradation, defensive measures, and CB defense equipment.



Automatic Chemical Agent Detector and Alarm (ACADA)

Lead Service



- Automatic point detection and identification of nerve and blister agents
- Man-portable vapor alarm
- Enhanced capability over the currently fielded M8A1 detector

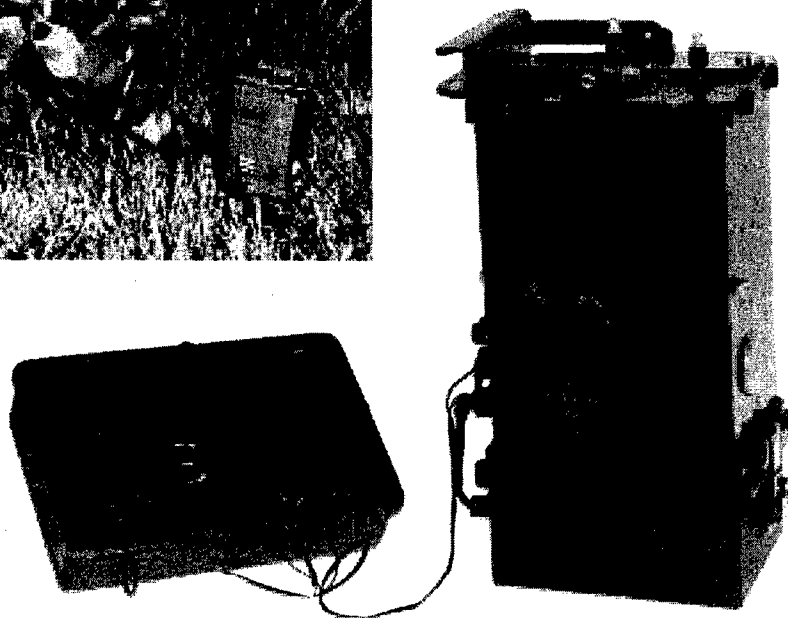

Contractors:

ACADA-M22
Graseby Dynamics, Ltd.
Orlando, FL 32801

Surface Sampler
SBCCOM
Edwards Hall, MD

Ship ACADA
STR, Inc.
Ft. Belvoir, MD

PSI
New Orleans, LA

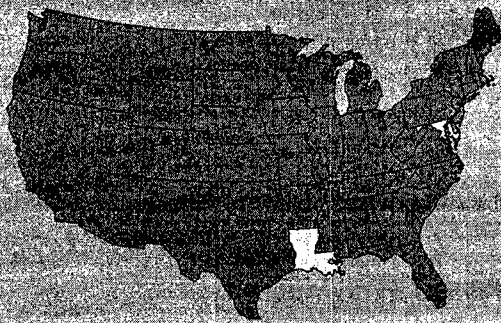

Artemis

Lead Service

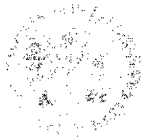

- Active standoff detection and identification of chemical agent vapors, aerosols and droplets
- Detailed contamination mapping and tracking of threat clouds
- Near real-time identification of chemical warfare agents
- Autonomous operation with warning and alarming functions that interface with the Joint Warning and Reporting Network (JWARN) as part of service C4I systems
- 360-degree coverage for a variety of platforms including selected naval vessels, ground vehicles, air platforms and fixed sites at ranges of 20 kilometers (km) or more

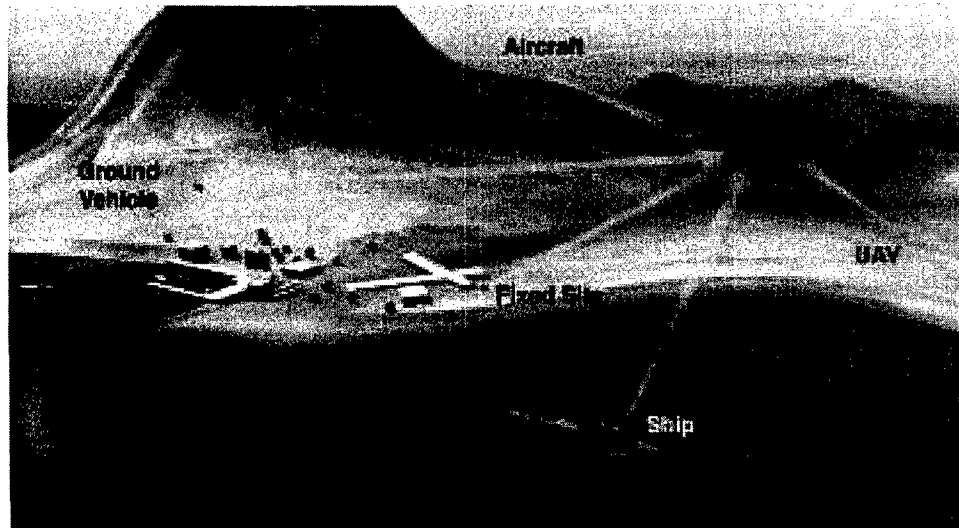

Contractors:

TBD



Program Description:

Using active Light Detection and Ranging (LIDAR) technology, the Artemis system will be a near real-time standoff detection system for chemical agent contamination monitoring and avoidance. The system will detect and identify chemical agent aerosols, vapors and provide detailed mapping and ranging information regarding agent threat clouds. Enhanced early warning from this active standoff system will allow the warfighter to avoid contaminated areas or don full protective equipment if avoidance is not possible, thus maximizing the warfighters ability to complete the mission.

FY01 Accomplishments:

- Completed Analysis of Alternatives (AoA) (including modeling and simulation) to validate technology alternatives. Completed independent Total Ownership Cost (TOC) analysis.
- Supported initiation of the Joint Service Integration Group (JSIG) Contamination Avoidance (CA) Mission Needs Analysis (MNA).
- Initiated development of program acquisition documentation.

FY02 Objectives:

- Prepare source documentation for Milestone (MS) B.
- Develop initial systems architecture and draft systems specification through a Joint Systems Engineering Integrated Product Team. Conduct risk analyses and develop risk mitigation plan.
- Conduct a supportability analysis as an integral part of the systems engineering process.
- Conduct initial Joint Training Planning Process Methodology and develop initial Joint System Training Plan. Develop acquisition logistics support plan for MS B.
- Establish test strategy and develop test methodology. Develop initial Test & Evaluation Master Plan (TEMP).
- Continue development of key components of an active emitter multi-wave LIDAR technology to develop a system architecture and to reduce overall programmatic risk by utilizing Component Advanced Development (CAD).
- Support Systems Engineering IPT through Simulation Based Acquisition (SBA) activities to reduce cost, schedule, and performance risks; increase the quality, military worth, and supportability of fielded systems, and reduce total ownership costs throughout the system life cycle.

FY03 Objectives:

- Complete source documentation for MS B.
- Initiate, design, build and integrate System Development and Demonstration Phase (SDD) prototypes for use in developmental testing.
- Initiate design documentation, development of Artemis system software. Initiate effort to develop interface between Artemis and Joint Warning and Reporting Network (JWARN).
- Develop detailed test support plan. Purchase additional test equipment to support range and chamber testing of a long range active LIDAR standoff detection system.
- Release formal RFP.

FY03 Acquisition Phase: System Development and Demonstration Phase

	FY01				FY02				FY03				FY04				FY05				FY06				FY07				FY08																																						
	1	2	3	4	1	2	3	4	1	2	3	4	1	2	3	4	1	2	3	4	1	2	3	4	1	2	3	4	1	2	3	4	1	2	3	4																															
Milestones																																																																			
AoA	■																																																																		
BLK I MS B Decision																																	◆																																		
BLK I Award Contract (Prototype)																																	◆																																		
BLK I MS C Decision																																																																◆			
Other Events																																																																			
Component Advanced Development	■																																																																		
BLK I Prototype Development																																	■																																		
BLK I Prototype Award Contract																																	●																																		
BLK I (DT I)																																	■																																		
BLK I (DT II)																																																																●			
Operational Assessment																																																																●			
BLK I Award LRIP Contract																																																																●			

Biological Integrated Detection System (BIDS)

Lead Service



- Semi-automated biological agent detection/identification suite mounted on a dedicated heavy High Mobility Multipurpose Wheeled Vehicle (HMMWV)
- Utilizes multi-complementary bio-detection technologies



Basis of Issue Highlights:

- 38 BIDS NDI systems 310th Chemical Co. (USAR)
- 3 BIDS NDI systems 100th Training Co. (USAR)
- 38 BIDS P3I systems 7th Chemical Co. (USA)
- 7 BIDS P3I systems U.S. Army Chemical School
- 38 BIDS P3I systems 13th Chemical Co. (USA)

Contractors:

Bodhi Scientific MILFORD, UK	Harris, Corp. ROCHESTER, NY
Bruker Analytical Systems BILMERE, MA	PEM NEE BROOK, MN
Environmental Technologies Group BALTIMORE, MD	TSI ST. PAUL, MN



Program Description:

The Biological Integrated Detection System (BIDS) is an early warning and identification capability in response to a large area (theater) Biological Warfare (BW) attack. The BIDS program was conducted in two phases. Phase I was the non-developmental item (NDI) BIDS. Phase II was the BIDS pre-planned product improvement (BIDS P3I), which provided technology insertion to upgrade from concurrent developmental efforts for the NDI core configuration, (four agent detection capability) to an eight agent detection capability. The system is a detection suite installed in a shelter that is mounted on a dedicated vehicle with generator and trailer power supply. The shelter may be removed from the vehicle for fixed site application. Other BIDS equipment includes collective protection, environmental control, and storage for supplies, Global Positioning System (GPS), meteorological systems and radios. The BIDS P3I system is equipped with a detection suite that includes a sampler, particle counter/sizer, biological detector and chemical/biological mass spectrometer.

FY01 Accomplishments:

- Procured P3I long lead items to support third BIDS Co (13th Chem).

FY02 Objectives:

- Procure long lead items to support upgrade of 310th Chem Co from BIDS NDI to P3I.
- Procure BIDS P3I detection systems to support 13th Chem Co activation.

FY03 Objectives:

- Integration and assembly of BIDS P3I.

FY03 Acquisition Phase Production, Fielding/Deployment and Operational Support

	FY01			FY02			FY03			FY04			FY05			FY06			FY07			FY08		
	1	2	3	4	1	2	3	4	1	2	3	4	1	2	3	4	1	2	3	4	1	2	3	4
Milestones																								
Other Events																								
BIDS P3I Production																								
BIDS P3I First Unit Equipped (13th Chem Co)																								
NDI Upgrade																								

Improved [Chemical Agent] Point Detection System (IPDS)

Lead Service



- Automatically detects and identifies nerve and blister chemical warfare agent vapor
- Provides real-time monitoring of ship's exterior air
- Reduces false alarms due to advanced design
- Expandable algorithm for new and novel agent detection

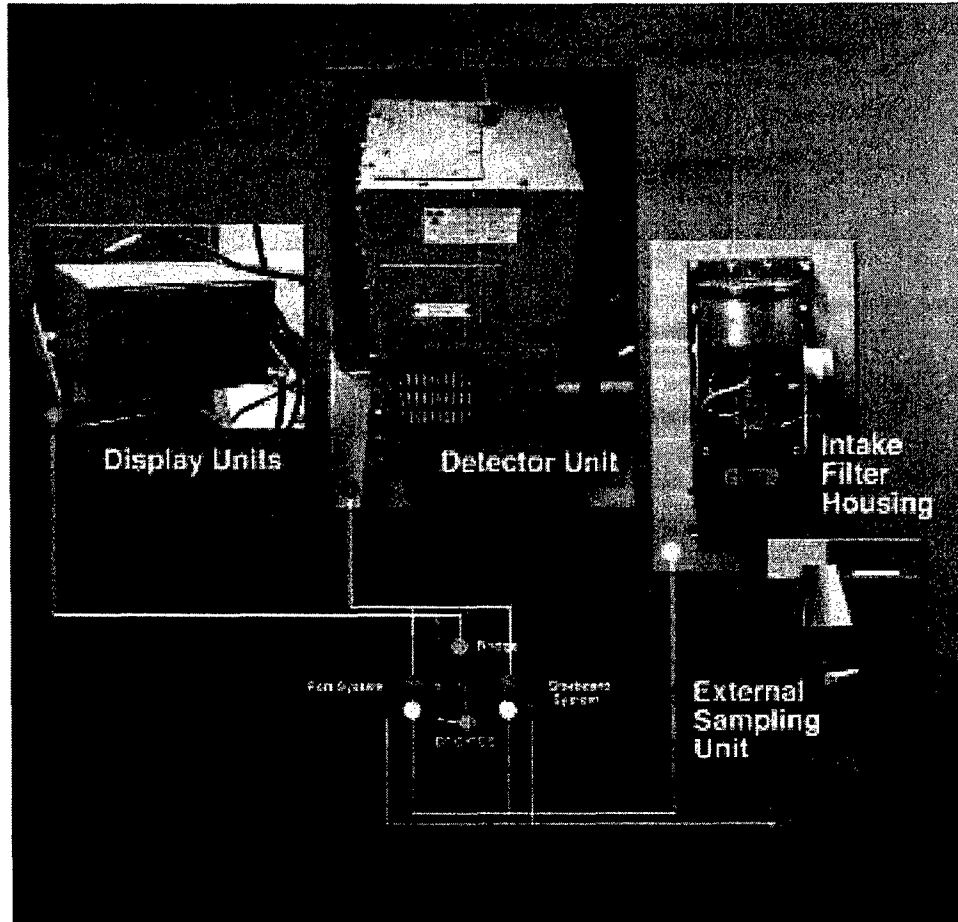

Contractors:

Powertronics Systems Inc.
NEW ORLEANS, LA



Program Description:

IPDS is intended to replace the MK 21 MOD 1 Chemical Agent Point Detection System (CAPDS). IPDS provides automatic point detection, classification and warning when there are chemical warfare vapors external to the ship. IPDS is an Ion Mobility Spectroscopy (IMS) based chemical point detection system with an algorithm library and embedded data processing that automatically detects and alarms to nerve and blister vapor at low concentrations while rejecting common shipboard interferents. When IPDS detects the presence of an agent, it automatically initiates an alarm for personnel to don individual protective equipment. The class of agent (G, V, or H) is immediately identified to aid in command and medical decision making. The IPDS consists of port and starboard external air sampling and detection units, a Control Display Unit (located in Damage Control Central) and a Remote Display Unit (located on the Bridge). IPDS is deployed as part of the Navy's Chemical/Biological (CB) detection suite aboard ships.

FY01 Accomplishments:

- Continued full-rate production.
- Awarded option to production contract.
- Continued installation of production systems on all ship classes (53 systems).
- Completed TOC reduction analysis and initiated implementation planning.
- Completed development of IPDS Interactive Electronic Technical Manual (IETM) and Interactive Course Ware (ICW).

FY02 Objectives:

- Continue installation of production systems on all ship classes (52 systems).

FY03 Objectives:

- Continue installation of production systems on all ship classes (52 systems).

FY03 Acquisition Phase Production, Fielding/Deployment and Operational Support

	FY01			FY02			FY03			FY04			FY05			FY06			FY07			FY08							
	1	2	3	4	1	2	3	4	1	2	3	4	1	2	3	4	1	2	3	4	1	2	3	4	1	2	3	4	
Milestones																													
Other Events																													
System Installation																													

Joint Biological Point Detection System (JBPDS)

Lead Service



- Provides common biological agent point detection capability for Service platforms
- Provides automated knowledge-based detection and identification
- Identifies biological agents in less than 15 minutes
- BLK I limited agent ID, BLK II full JORD requirement
- Provides a point detection capability to the Air Force and Marine Corps
- Replaces Navy Interim Biological Agent Detector (IBAD) and Army Biological Integrated Detection System (BIDS)

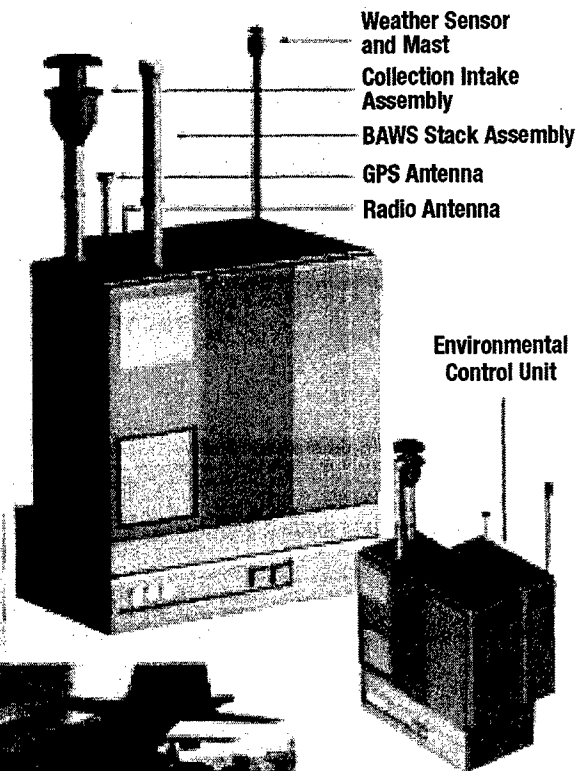

Contractors:

Battelle Memorial Institute
 Columbus, OH

Intellitec
 Ft. Lauderdale, FL



Program Description:

The Joint Biological Point Detection System (JBPDS) is a two block program and is the successor to the Army BIDS, Navy IBAD, and the Air Force service specific development programs. The JBPDS will meet multi-service requirements as outlined in the Joint Operational Requirements Document (JORD) and consist of complementary trigger, sampler, detector and identification technologies to rapidly and automatically detect and identify biological threat agents. The suite is capable of identifying BW agents in less than 15 minutes. The detection suite will be integrated into each Service's platform (e.g. BIDS, surface ships, LNBCRS) or air base and port to provide a common detection capability for joint interoperability and supportability. The JBPDS will increase the number of agents that can be identified by the BIDS and the IBADS; decrease detection and identification time; increase detection sensitivity; provide automated knowledge-based detection and identification; and provide a first time point detection capability to the Air Force and Marine Corps. JBPDS Block I will replace the IBADS beginning in FY03.

FY01 Accomplishments:

- Initiated modeling, design, fabrication, and test of next generation Biological Aerosol Warning System (BAWS) prototype.

Block I

- Conducted Operational Assessment II and supported Block I IOT&E planning required for a Milestone III decision.
- Conducted Risk Reduction and initiated Product Improvements on system suite and the Biological Aerosol Warning System (BAWS) detector design.

Block II

- Initiated Block II design studies to define performance specifications, identify potential design concepts, and reduce risk to the EMD program. Initiated preparations of the request for proposal for Block II EMD contract.

FY02 Objectives:

Block I

- Conduct Initial Army Operational Test and Evaluation (IOT&E) at the Dugway Proving Ground, Utah.
- Initiate planning for USAF, USMC, and Navy IOT&E.

Block II

- Initiate Biological Aerosol Warning System (BAWS) laser reliability test planning.

FY03 Objectives:

- Develop software and hardware advances to BAWS algorithms that will provide increased reliability and enhance the JBPDS Block II ability to discriminate background environment aerosol components, without sacrificing sensitivity and responsiveness to biological warfare attacks.
- Establish core and Joint service IPT's and initiate product improvements of Line Replaceable Units (LRUs), through design, procurement, fabrication, and critical item testing.

FY03 Acquisition Phase: System Development and Demonstration Phase/Production

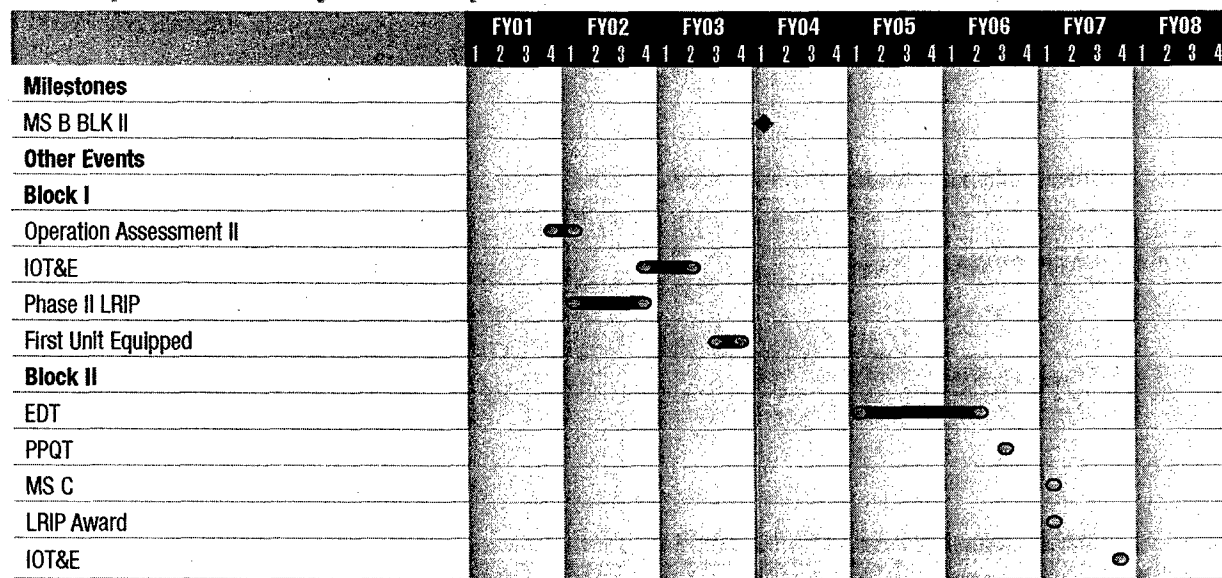

Joint Biological Standoff Detection System (JBSIDS)

Lead Service

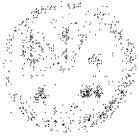

TBD

- Detect and track aerosol clouds out to 15km
- Discriminate biological particles from non-biological particles in aerosol clouds out to 3km
- Operate at fixed site or in stationary mode from mobile platforms
- Operate in conjunction with bio point detectors

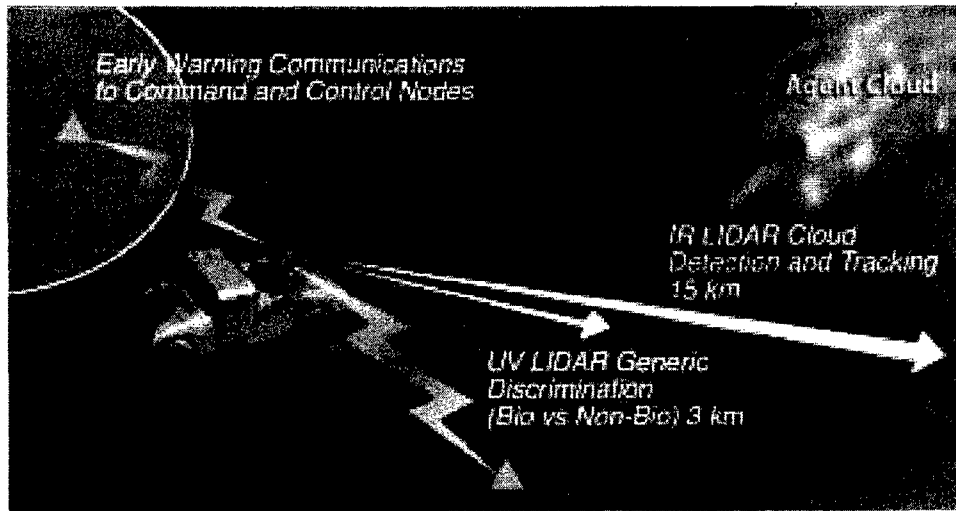

Contractors:

TBD

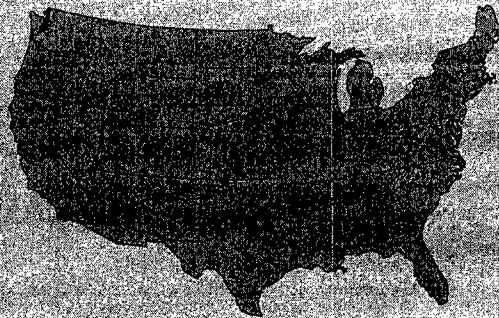

Program Description:

The JBSDS is the first joint standoff detection program. The JBSDS will be a standoff early warning biological detection system. The system will be capable of providing near real time detection of biological attacks/incidents and standoff early detection/warning of BW agents at fixed sites or when mounted on multiple platforms. It will be capable of providing standoff detection, ranging, tracking, discrimination (manmade vs. naturally occurring aerosol) and generic detection (bio vs. non-bio) of large area BW aerosol clouds for advanced warning, reporting and protection.

JBSDS will augment and integrate with existing biological detection systems to provide a biological detection network capable of detection and warning to limit the effects of biological agent hazards against U.S. forces at the tactical and operational level of war. JBSDS will have the flexibility to warn automatically or to allow for human intervention in the detection-to-alarm process. JBSDS will pass detection information and warnings through existing and planned communications networks. Commanders may integrate JBSDS outputs with information from intelligence, meteorological and oceanographic, radar, medical surveillance, local area operations, and other available assets to increase force protection, mitigate the consequence of biological hazards, and maximize combat effectiveness.

The JPO-BD will use an evolutionary acquisition strategy with block developments for JBSDS program supporting the time-phased JORD requirements. JBSDS Block I will provide an initial operationally useful and supportable capability in as short a time as possible. The JBSDS Block I will incorporate an accelerated development cycle relying on the modification of existing GOTS and COTS technologies. A rapid down-select of existing systems will lead to a competitive test fly-off for the selection of a single system to enter the government testing program. The JBSDS Block II development contract will be competitively awarded with emphasis on increasing sensitivity, range and reliability, while reducing life cycle costs, weight, power requirements and size. The system is to be utilized by all services, thus reducing acquisition life cycle costs. The program will fully leverage technologies identified and evaluated at the Joint Field Trials (JFTs) or Technology Readiness Evaluations (TRES), the Joint Biological Remote Early Warning System (JBREWS) Advanced Concept Technology Demonstration (ACTD), and the Long Range Biological Standoff Detection Systems (LR-BSDS) development efforts.

FY01 Accomplishments:

- Initiated system development and integration of lightweight early warning systems as potential candidates for the JBSDS.

FY02 Objectives:

- Continue system development and integration of the lightweight, early warning systems as potential candidates for the JBSDS.
- Initiate testing of the integrated, lightweight, early warning JBSDS system candidates.

FY03 Objectives:

- Initiate the system development of enhanced environmental and military hardening packages for lightweight early warning JBSDS candidate systems.
- Conduct developmental testing (DT) of JBSDS competing candidate systems.
- Initiate limited operational testing (OT) and assessment of JBSDS competing candidate systems.

FY03 Acquisition Phase: Concept and Technology Development

	FY01			FY02			FY03			FY04			FY05			FY06			FY07			FY08			
	1	2	3	4	1	2	3	4	1	2	3	4	1	2	3	4	1	2	3	4	1	2	3	4	
Milestones																									
BLK I Component Advanced Development (CAD)	—————																								
BLK I MS B																									
BLK I MS C																									
BLK II MS B																									
BLK II MS C																									
Other Events																									
BLK I FUE																									
BLK II LRIP																									

Joint Chemical Agent Detector (JCAD)

Lead Service

- Automatically detect, identify, and quantify chemical agents
- Lightweight and portable
- Interface with Joint Warning and Reporting Network (JWARN)
- Replace service unique chemical agent detectors

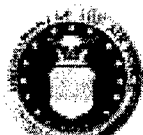

Pre-Concentrator:
Enables Lower
Level Detection

Detector Unit:
Employs Surface
Acoustic Wave
(SAW) Technology

Contractors:

BAE
Austin, TX

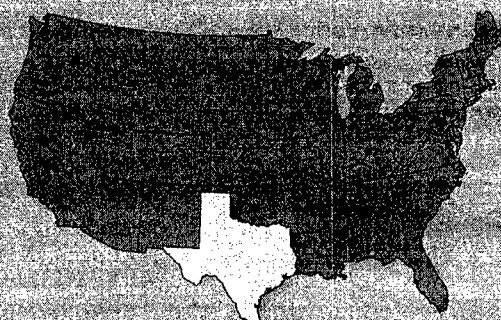

Program Description:

The JCAD program will develop a joint portable monitoring and small point chemical agent detector for aircraft, shipboard and individual warfighter applications. JCAD is a hand-held, pocket-sized detector capable of automatically detecting, identifying, and quantifying chemical agents onboard ships and aircraft. It provides monitoring and alarm capabilities to the warfighter. The device must be sufficiently sensitive to warn personnel before accumulation of an operationally significant dose, over the entire mission. The JCAD will be resistant to the severe interferents found in an operational environment. JCAD will replace the ACADA, CAM, ICAM and other legacy systems currently used by the individual services.

FY01 Accomplishments:

- Continued hardware and software development of 110 breadboard prototype units.
- Continued systems engineering and manufacturing development (EMD) for prototype units, and logistics planning.
- Continued integration of systems components.
- Initiated contractor engineering test and evaluation of breadboard prototype units.

FY02 Objectives:

- Complete hardware and software development on 296 contractor EMD prototype units.
- Continue systems engineering and logistics planning.
- Begin systems integration of JCAD system components and user platforms.
- Complete contractor validation test and evaluation. Begin development test (DT).

FY03 Objectives:

- Update developmental hardware and software based on contractor and government developmental testing.
- Continue JCAD systems engineering and logistics planning.
- Continue systems integration supporting developmental tests.
- Continue developmental testing and evaluation. Continue operational test planning and preparation.

FY03 Acquisition Phase: System Development and Demonstration

	FY01				FY02				FY03				FY04				FY05				FY06				FY07				FY08			
	1	2	3	4	1	2	3	4	1	2	3	4	1	2	3	4	1	2	3	4	1	2	3	4	1	2	3	4	1	2	3	4
Milestones																																
MS C																																
Other Events																																
EMD Prototype Fabrication Test	■																															
DT					■																											
Low Rate Initial Production (LRIP)/ Operational Test									■																							
Full Rate Production Decision													●																			

Joint Service Lightweight Nuclear, Biological, Chemical Reconnaissance System (JSLNBCRS)

Lead Service



- NBC detection and identification system
- Provides accurate and rapid NBC intelligence data by sampling, detecting, identifying, marking, and reporting the presence of NBC hazards within a unit's area of responsibility
- Consists of a Base Vehicle equipped with hand-held, portable and mounted, current and advanced NBC detection and identification equipment
- Equipped with a collective protection system, environmental control system, auxiliary power supply system, navigation system, meteorological data processing system, internal and external communication systems, and surface samplers
- Configured to allow full operation while deployed with the standard warning and reporting system and with vehicles now assigned to the receiving units

JSLNBCRS

- RADIATION DETECTOR
- STAND-OFF CHEMICAL AGENT DETECTOR
- CHEMICAL AGENT DETECTOR
- CHEMICAL VAPOR DETECTOR
- SURFACE CONTAMINATION SENSOR

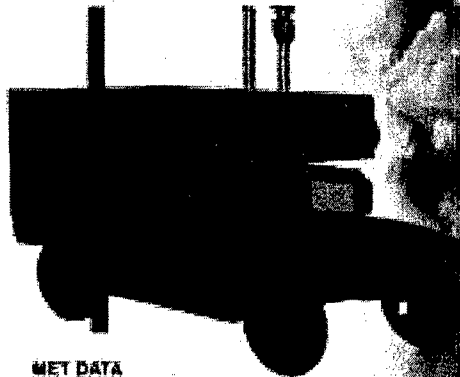

MET DATA
SAMPLING PROCEDURES
GPS

NETWORKED DETECTION

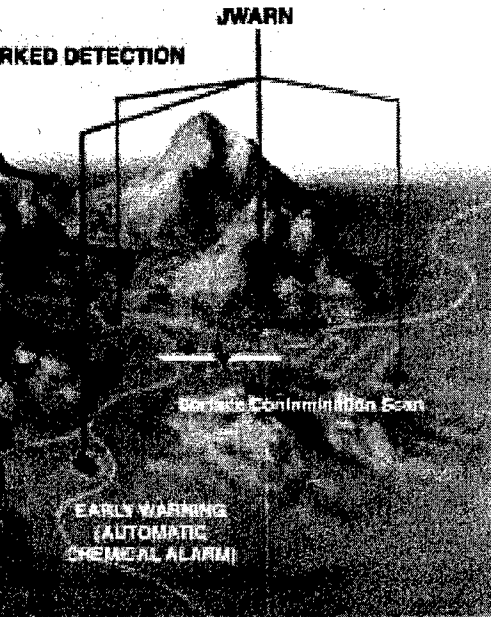

Surface Contamination Scan

EARLY WARNING
(AUTOMATIC
CHEMICAL ALARM)

Contractors:

TRW (Tactical Systems Division)
CHINA, CA



Program Description:

JSLNBCRS is a new lightweight NBC detection and identification system that will consist of a Base Vehicle (BV) equipped with current and advanced NBC detection and identification equipment. The JSLNBCRS will provide on-the-move reconnaissance and surveillance in support of combat, combat support, and combat service support forces. There will be two variants of the JSLNBCRS: the High Mobility Multi-Purpose Wheeled Vehicle (HMMWV) variant and the Light Armored Vehicle (LAV) variant.

FY01 Accomplishments:

- Built/integrated three M1113 HMMWV variants
- Completed Development Test (DT I) for three M1113 HMMWV variants.

FY02 Objectives:

- Continue software and hardware engineering development and integration of commercial off the shelf, government off the shelf software/hardware, and non-developmental item software/hardware products to the maximum extent possible for HMMWV variant.
- Conduct system test and evaluation (HMMWV DT II/Limited User Team) at Dugway and Yuma Proving Grounds.
- Conduct LAV variant design/fabrication.
- Initiate Toxic Industrial Chemical (TICs) and Toxic Industrial Materials (TIMs) software development for CBMS Block II transition to JSLNBCRS procurement.

FY03 Objectives:

- Start DT I for LAV variant.
- Complete development of TICs and TIMs software for CBMS Block II transition to JSLNBCRS procurement.
- Conduct DT III for LRIP HMMWV variants.
- Start IOT&E for LAVs and HMMWVs for full rate production/Milestone C.

FY03 Acquisition Phase: System Development and Demonstration

	FY01				FY02				FY03				FY04				FY05				FY06				FY07				FY08																																																																											
	1	2	3	4	1	2	3	4	1	2	3	4	1	2	3	4	1	2	3	4	1	2	3	4	1	2	3	4	1	2	3	4																																																																								
Milestones																																																																																																								
MS B			◆																																																																																																					
MS C (LRIP)																																	◆																																																																							
MS C (FRP)																																																																																																								
Other Events																																																																																																								
DT II/LUT HMMWV																																																																																																								
LRIP HMMWV																																																																																																								
LAV EDT																																																																																																								
DT I LAV																																																																																																								
IOT&E (Both Variants)																																																																																																								

Joint Service Lightweight Standoff Chemical Agent Detector

Lead Service



- Provides on-the-move automatic standoff chemical agent detection up to five kilometers in range
- Mounts on Service platform(s) to include selected naval vessels, aircraft, and fixed sites
- Replaces the M21 Remote Sensing Chemical Agent Alarm (RSCAAL)

Shipboard Configuration
(2 Units per Ship)

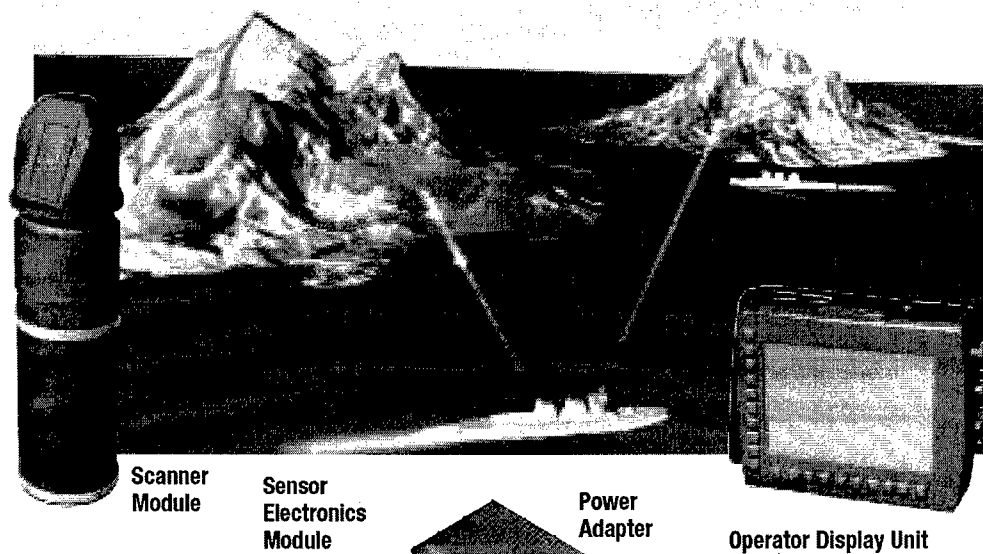

Vehicle Mounted JSLSCAD



Aircraft Mounted JSLSCAD

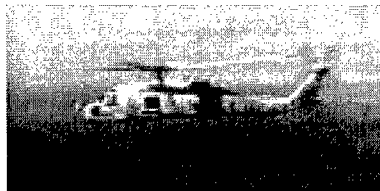

Ground Mount JSLSCAD

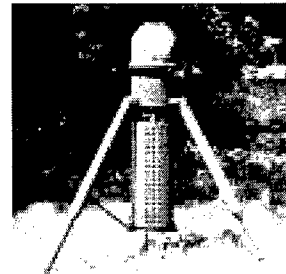

Contractors:

Intelletic
DI LANE, FL
Honeywell Technology Center
MINNAPOLIS, MN
OPTRA, Inc.
TOPSFIELD, MA
Recon/Optical, Inc.
BARRINGTON, IL

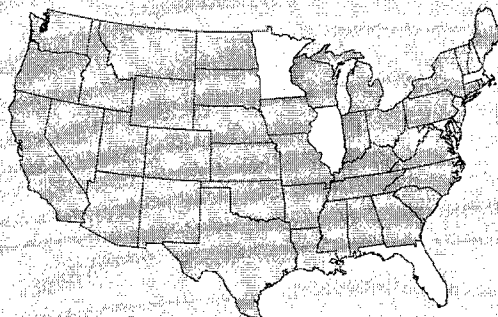

NBC Reconnaissance System Modifications

Lead Service



- High speed, high mobility armored carrier capable of performing NBC reconnaissance throughout the battlefield

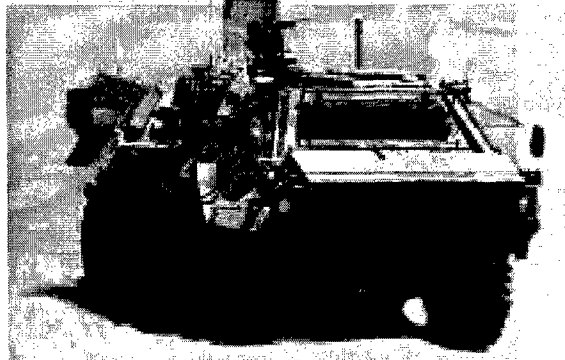

Contractors:

Block I

Anniston Army Depot
ANNISTON, AL

General Dynamics Land Systems Division
DETROIT, MI

Henschel Wehrtechnik
GERMANY

Bruker-Franzen
GERMANY

Block II - TBD

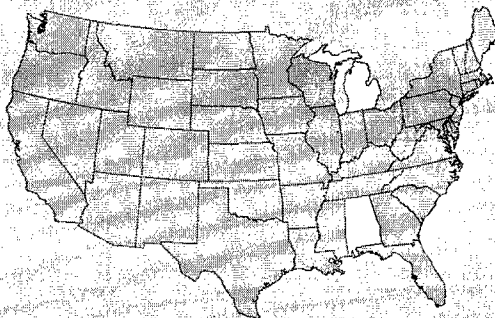

Chemical Biological Protective Shelter (CBPS/CBPS P3I)

Lead Service

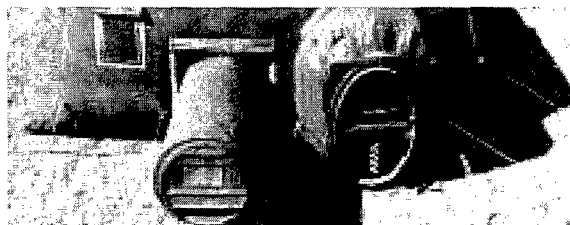

Contractors:

Chemfab Corporation
MERRIMACK, NH

Engineering Air Systems, Inc.
ST. LOUIS, MO (P3I II)

Federal Fabrics - Fibers, Inc.
NORTH CHELMSFORD, MA

Marion Composites
BRUNSWICK, VA

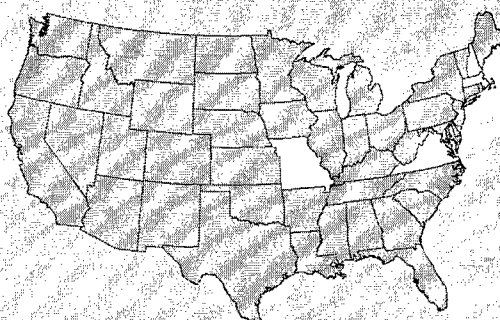

Program Description:

The CBPS is a new system designed to replace the M51 Collective Protection Shelter. It consists of a Lightweight Multi-purpose Shelter (LMS) mounted on a Expanded Capacity (ECV) High Mobility Multi-Purpose Wheeled Vehicle (HMMWV) variant and a 300 square foot airbeam supported soft shelter. The CBPS provides a contamination-free, environmentally-controlled working area for medical, combat service, and combat service support personnel to obtain relief from the continuous need to wear chemical-biological protective clothing for 72 hours of operation. All ancillary equipment required to provide protection, except the generator, is mounted within the shelter. Medical equipment and crew gear are transported inside of the LMS and by a towed High Mobility Trailer.

A CBPS Pre-Planned Product Improvement (P3I) will initiate in FY02. The P3I will result in improved operational suitability and reliability of the current version of CBPS for forward deployed light divisions only. A self-sustained Environmental Support System (ESS) will be developed that does not require the HMMWV engine for primary power. This ESS will reduce vehicle sustainment costs and improve system reliability. Further weight reductions will be incorporated to allow more medical equipment to be carried onboard the CBPS. The P3I also will develop versions of CBPS suitable for airdrop and use in heavy divisions. The self-sustained ESS and CBPS airbeam supported soft shelter will be integrated onto additional platforms suitable for those applications.

FY01 Accomplishments:

- Procured 10 CBPS and associated equipment.

FY02 Objectives:

- Procure 41 CBPS and associated equipment.
- Initiate CBPS P3I program.
- Develop CBPS P3I design concept for airborne and heavy versions.
- Develop a CBPS P3I ESS that will meet the requirements for CBPS-light, heavy, and airborne versions.
- Conduct initial performance and RAM testing for CBPS P3I ESS.

FY03 Objectives:

- Procure 27 CBPS and associated equipment.
- Finalize ESS design and test.

FY03 Acquisition Phase: Production – CBPS/System Development and Demonstration – CBPS P3I

	FY01				FY02				FY03				FY04				FY05				FY06				FY07				FY08			
	1	2	3	4	1	2	3	4	1	2	3	4	1	2	3	4	1	2	3	4	1	2	3	4	1	2	3	4	1	2	3	4
Milestones																																
CBPS P3I MS C																																
Other Events																																
Program Initiation																																
Production Integration																																
OT/DT																																
CBPS Production																																

Chemically Protected Deployable Medical System (CP DEPMEDS) Chemically Hardened Air Transportable Hospital (CHATH)

Lead Service



- Support a 72 hour mission to sustain medical operations in a CB contaminated environment.
- Provides environmental control to sustain internal temperatures between 60-90°F.
- Contains a supply airlock for hospital resupply and waste disposal.

CHATH

CP DEPMEDS

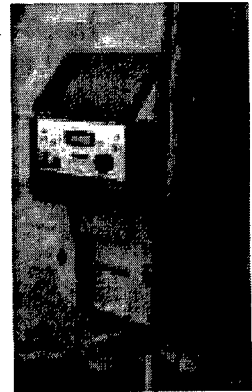
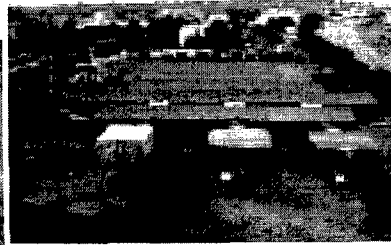

Pressure gauge with differential pressure alarms

CB hardened latrines

Patient Processing Unit (PPU)



Contractors:

SFA, Inc.
FREDERICK, MD
Production Products
FULTON, MO

KECO Industries
FLORENCE, KY

Pine Bluff Arsenal
PINE BLUFF, AR

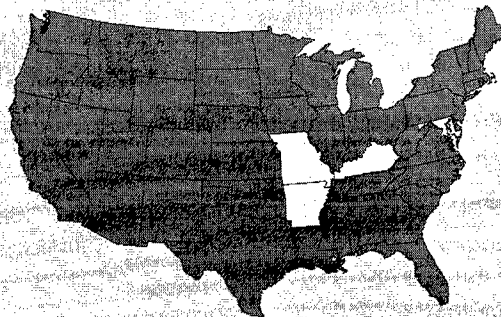

Program Description:

The CP DEPMEDS provides a capability that allows field combat support hospitals to be able to sustain medical operations in a CB environment. The program is a multi-service effort between the Army and Air Force. The CP DEPMEDS will provide a clean, toxic free, environmentally controlled patient treatment area maximizing the use of existing equipment to the Hospital Unit Base of fielded Deployable Medical Systems for the Army and to Air Transportable Hospitals for the Air Force. All services use field hospitals which are comprised of the same building block components. Hospitals vary in size and configuration between the services. All components are designed to integrate into fielded hospitals. Components will be packaged as a set to be provided to units in threat areas. Collective protection is provided through the addition of M28 Collective Protection Equipment (CPE), CB protected environmental control units and heaters, CB protected latrines and water distribution systems, low pressure alarms and other integration components necessary for a fully operational CB protected hospital facility.

FY01 Accomplishments:

- Procured eight CP DEPMEDS systems and integrated into field hospitals.

FY02 Objectives:

- Procure two CP DEPMEDS systems and integrate into field hospitals.

FY03 Objectives:

- Integrate components into field hospital.
- Procure cold weather augmentation kits.

FY03 Acquisition Phase: Production, Fielding/Deployment and Operational Support

	FY01				FY02				FY03				FY04				FY05				FY06				FY07				FY08							
	1	2	3	4	1	2	3	4	1	2	3	4	1	2	3	4	1	2	3	4	1	2	3	4	1	2	3	4	1	2	3	4	1	2	3	4
Milestones																																				
MS III																																				
Other Events																																				
IOT&E																																				
CP DEPMEDS Set Assembly																																				
First Unit Equipped																																				
Fielding/Integration																																				

Collective Protection System (CPS) Backfit/ Shipboard Collective Protection Equipment (SCPE)

Lead Service



- Provides ships with a contamination-free environment within specified zone boundaries
- Enables mission-essential operations and life-sustaining functions that can be performed during and after a CB attack
- Provides Pre-Planned Product Improvements (P3I) to the current shipboard Collective Protection System (CPS)/Selected Area Collection Protection System (SACPS) by decreasing logistics costs, extending filter life, reducing shipboard maintenance requirements, and providing energy-efficient fans

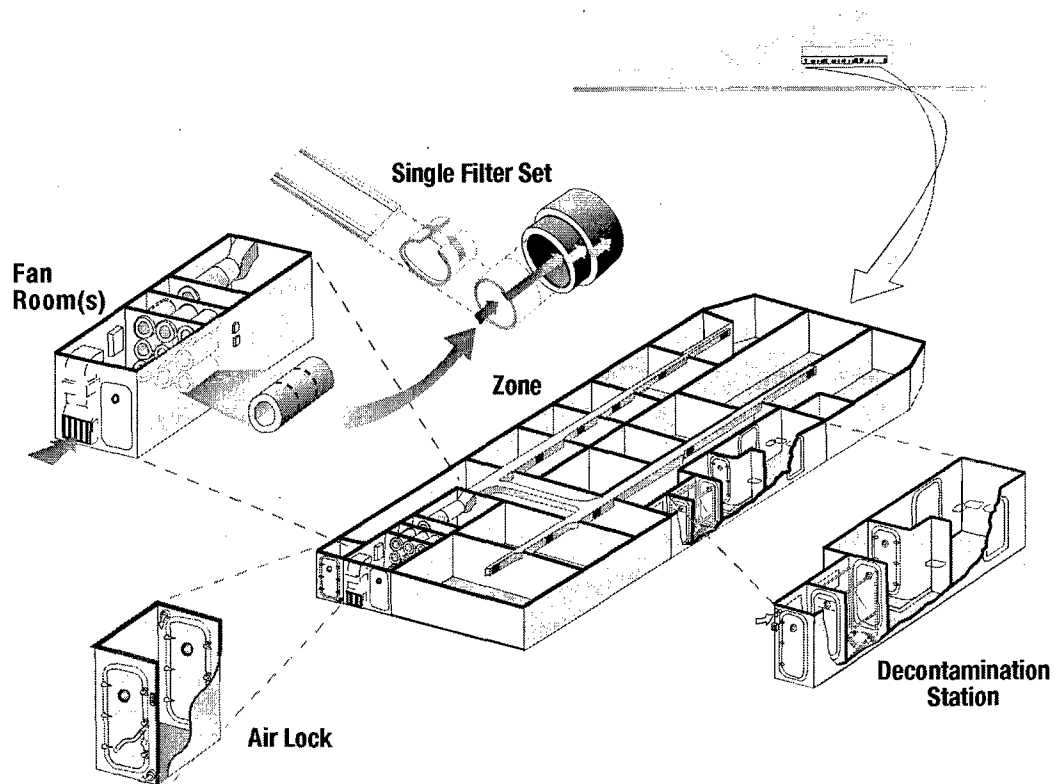

Contractors:

- American Fan Company
FAIRFIELD, OH
- Anderson Metal Industries, Inc.
FRANKLIN, PA
- New World Associates
FREDERICKSBURG, VA
- Various Planning Yards
Ship Repair Facility
SASEBO, JAPAN
- NSWCCD-SSES
PHILADELPHIA, PA
- SUPSHIP
SAN DIEGO, CA

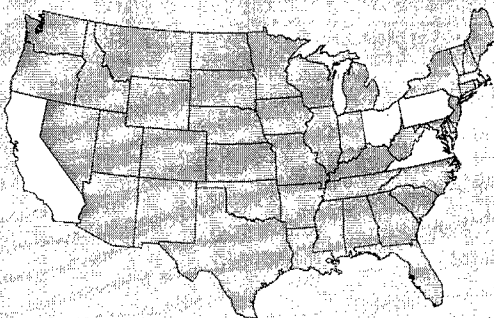

Joint Collective Protection Equipment (JCPE)

Lead Service

- Lightweight, easy to maintain
- Provides standardized, affordable collective protection equipment
- Interim capability

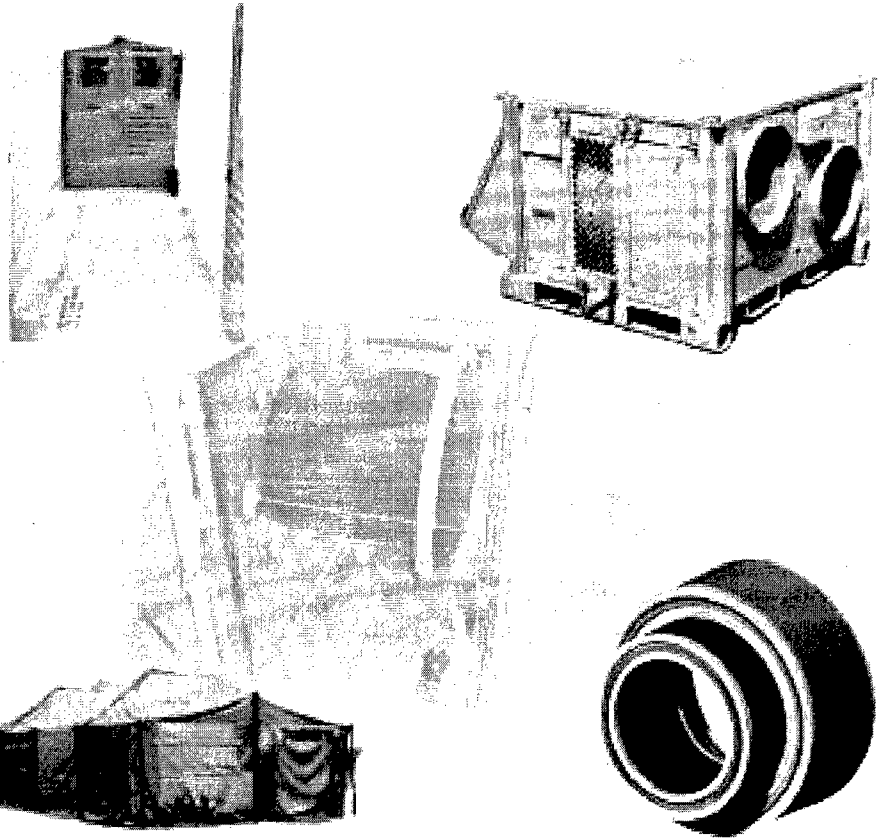

Contractors:

SBCCOM
Natick, MA
Eglin AFB
Destin, FL
Brooks AFB
San Antonio, TX

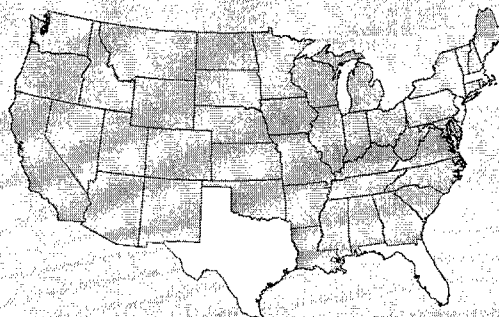

Program Description:

The JCPE program consolidates improvements to post-Milestone III/C collective protection programs into one cost-effective program for currently fielded fixed site, building, shipboard, portable shelter and vehicle collective protection systems.

It also provides proven solutions to deficiencies, needed improvements and cost saving standardization to currently fielded collective protection systems, by using the latest technologies in filtration, shelter materials and environmental controls to provide components that are affordable, lightweight and easy to operate and maintain.

FY01 Accomplishments:

- Completed development and testing of 20 improved 200 Cubic Feet per Minute (CFM) particulate filters to reduce logistics costs.
- Completed development of 100/200 CFM gas filter improvements to extend filter life and reduce manufacturing and logistics costs.
- Initiated development and testing of the Filter Fan Assembly (FFA) 400-100 and M93 Modular Collective Protection Equipment (MCPE) candidate motor blowers for CB shelter systems to improve efficiency, reliability, size and weight.

FY02 Objectives:

- Complete development and testing of 400-100 and M93 MCPE candidate motorblowers for CB shelter systems
- Complete development and testing of a modified ECU for EMEDS to allow rapid deployment of a reduced weight and size unit.
- Initiate development of a modified M28 liner for large capacity shelters.

FY03 Objectives:

- Complete development of 2000 CFM particulate filters to reduce logistics costs.
- Complete live agent testing of improved 100/200 CFM gas filters.
- Complete development and testing of ten improved 100/200CFM gas filters to provide TIC protection.
- Complete development of a modified M28 liner for large capacity shelters.

FY03 Acquisition Phase: System Development and Demonstration

	FY01				FY02				FY03				FY04				FY05				FY06				FY07				FY08							
	1	2	3	4	1	2	3	4	1	2	3	4	1	2	3	4	1	2	3	4	1	2	3	4	1	2	3	4	1	2	3	4	1	2	3	4
Milestones																																				
Other Events																																				
Develop and Test Packaging and Housing Improvements	█																																			
Develop and Test Improved 200 CFM Particulate Filter	█																																			
Develop and Test Pleatable Charcoal/ High Efficiency Particulate Arresting (HEPA) Bonded Filter	█				█																															
Develop and Test 2000 CFM Particulate Filters					█				█																											
Develop and Test Modified 100/200 CFM Gas Filters for TICs									█				█																							
Develop and Test Modified Impingement Filter for Ships									█				█																							

Joint Protective Aircrew Ensemble (JPAGE) Joint Service Aircrew Mask (JSAM)

Lead Service

- Increased chemical agent protection
- Increased service life
- Reduced thermal burden
- Coordinated program development



JPACE



JSAM



Contractors:

JPAGE:

Battelle Memorial Institute
COLUMBUS, OH

Creative Apparel Associates
BELLMONT, ME

Tennessee Apparel Corporation
TULLAHOPE, TN

JSAM:

Gentex
RANCHO CUCAGONO, CA

SAIC
ABINGDON, MD

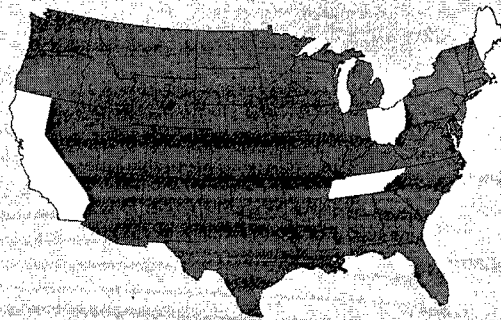

Program Description:

JPAGE: A Joint improved CB protective ensemble for aircrew to replace the Navy Mk1 undergarment, Army ABDU-BDO system, and Air Force CWU-66/P Overgarment. JPAGE will provide aviators with improvements in protection, reduced heat stress in CB environments, and extended wear and service life. This operational capability will support all Services.

JSAM: The JSAM will be a lightweight, CB protective mask which can be worn as CB protection for all aircrews. When integrated with anti-G protection, it will provide simultaneous CB and anti-G protection to aircrew in high performance aircraft. It will be compatible with existing CB ensembles, provide flame and thermal protection, reduce heat stress imposed by existing CB protective masks and the CB protective portion will be capable of being donned and doffed in flight. JSAM must also be compatible with existing aircrew life support equipment.

FY01 Accomplishments:

- JPAGE – Obtained candidate materials for DT IIA and initiate DT IIA material swatch testing for downselect.
- JPAGE – Continued development of patterns for use in fabrication.
- JPAGE – Initiated development of program, logistics, and technical documentation to support the development and fielding.
- JSAM – Fabricated 25 prototypes of each variant.
- JSAM – Continued risk reduction, system engineering, and Cost As an Independent Variant (CAIV) analysis studies.

FY02 Objectives:

- JPAGE – Complete DT IIA material swatch testing and downselect to the best six candidate materials.
- JPAGE – Fabricate 75 prototype ensembles of each of the six selected candidate materials for use in DT IIB.
- JPAGE – Initiate DT IIB testing on the six candidate materials to verify system level performance requirements have been met.
- JPAGE – Complete development of patterns for use in fabrication, and continue developing and updating program documentation.
- JPAGE – Complete initial development and qualification testing of prototypes.
- JSAM – Conduct system demonstration source selection and begin formulation of DT/Operational Testing (OT) test plans.

FY03 Objectives:

- JPAGE – Complete DT IIB testing and downselect to two candidates.
- JPAGE – Fabricate 350 prototype ensembles of each candidate for combined DT/OT.
- JPAGE – Initiate combined DT/OT system level testing and initial Operational Assessment (OA) to verify system level performance and assess operational suitability and durability.
- JSAM – Finalize system design and complete development.
- JSAM – Complete system validation, develop production processes and hard tooling to fabricate DT and OT units.
- JSAM – Initiate material buy and begin assembly of 466 DT units.

FY03 Acquisition Phase: System Development and Demonstration

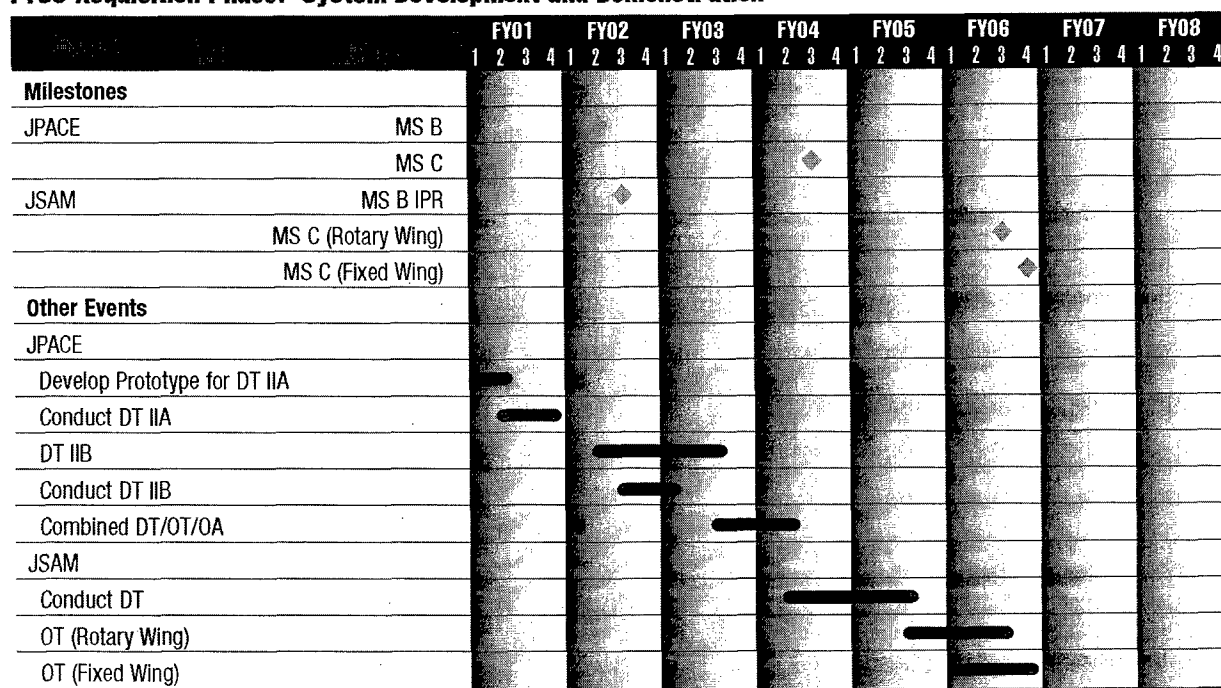

Joint Service General Purpose Mask (JSGPM)

Lead Service



- Improved protection from chemical and biological agents
- Improved field of view
- Lowered breathing resistance
- Reduced weight/bulk



Contractors:

Avon, Inc.
CADILLAC, MI

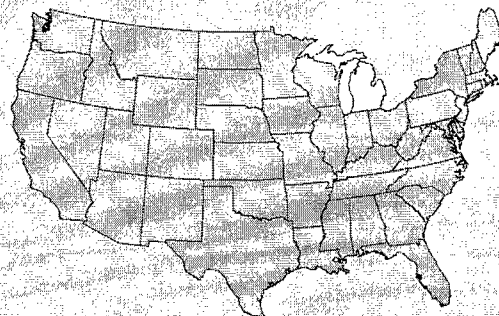

Program Description:

The JSGPM is a lightweight protective mask system (consisting of mask, carrier and accessories) incorporating state of the art technology to protect U.S. forces from anticipated threats. Mask components will be optimized to minimize performance degradation, as well as maximizing its ability to interface with future equipment and protective clothing, while providing an integrated NBC protective system. The JSGPM will reduce weight, bulk, and breathing resistance by as much as 50 percent over previously fielded masks. JSGPM will also improve vision coupling, communication effectiveness, and comfort/wearability. The mask will significantly reduce maintenance and life cycle costs. JSGPM will be priced low enough, that the potential exists for it to be classified as disposable after agent exposure. JSGPM will replace all M40 and M42 series masks as well as the MCU-2/P and MCU-2A/P.

FY01 Accomplishments:

- Continued Program Definition and Risk Reduction contract for mask design and 800 prototypes.
- Conducted Engineering Design Test (EDT) Planning. Testing ensured meeting Joint Service requirements for protection, communication, drinking, breathing resistance, and bulk/weight limitations.
- Continued sustainment study for logistics support.
- Initiated testing and evaluation of two commercially available escape masks.

FY02 Objectives:

- Complete Interim Progress Review and transition to the System Demonstration acquisition phase. These activities will include finalization of the Single Acquisition Management Plan (SAMP), Test and Evaluation Master Plan (TEMP), and the Manpower Personnel Integration (MANPRINT) Plan.
- Complete Program Definition and Risk Reduction contract for mask design and 800 prototypes.
- Conduct Engineering Design Test (EDT). Testing ensures meeting Joint Service requirements for protection, communication, drinking, breathing resistance and weight/bulk limitations.
- Continue sustainment study for logistics support.

FY03 Objectives:

- Initiate preparation of documentation for Milestone C decision.
- Prepare system support packages for PQT and IOT&E.
- Plan and prepare documentation for DT/OT.

FY03 Acquisition Phase: System Development and Demonstration

	FY01				FY02				FY03				FY04				FY05				FY06				FY07				FY08							
	1	2	3	4	1	2	3	4	1	2	3	4	1	2	3	4	1	2	3	4	1	2	3	4	1	2	3	4	1	2	3	4				
Milestones																																				
MS C																																				
Other Events																																				
TEMP Approval	████████████████████																																			
EDT																																				
IPR for Transition to System Demonstration									●																											
Conduct System Demonstration									████████████████████																											
DT													██████████																							
Prepare MS C documentation									████████████████████																											

Joint Service Lightweight Integrated Suit Technology (JSLIST)

Lead Service



- Increases chemical protection for Joint Services
- Reduces heat stress
- Improves fit (reduced bulkiness)
- Extends wear and launderability
- Replaces Battle Dress Overgarment (BDO), Chemical Protective Overgarment (CPO), and Saratoga (USMC Chemical Suit)



Contractors:

Creative Apparel
BELFAST, ME

Group Home Foundation
(NISH)
BELFAST, ME

NCED (NISH)
EL PASO, TX

Peckham Vocational
Industries (NISH)
LANSING, MI

Southeastern Kentucky
Rehabilitation Industries
(NISH)
CORNEL, KY

Tingley Rubber, Inc.
SOUTH PLAINS FIELD, NJ



Program Description:

The JSLIST ensemble includes:

- A single two-piece garment that provides protection from CB contaminants.
- Suitability for wear while performing all normal combat operations.
- A garment that is lighter and less bulky than previous protective garments; it also imposes less heat stress and reduces the psychological and physiological stress of the current garments.
- Compatibility with existing and future garments.
- Maximized garment commonality and minimized number of fielded garment types.

The JSLIST ensemble employs a single base garment design, but is configured to meet each service's requirements. The ensemble consists of four components: protective suit, protective overboots, protective gloves, and multipurpose protective socks.

The Chemical Protective Overgarment is a two-piece garment consisting of trousers and coat with an integrated hood and can be worn over undergarment or duty uniform. It provides liquid, vapor, and aerosol protection. Variants may include an Advanced Battledress Overgarment (45 day suit), a lightweight CB protective overgarment (seven day suit), or a vapor protective undergarment.

The Multipurpose Rain/Snow/Chemical/Biological Overboot (MULO) is designed to be worn with standard-issue combat or jungle boots while also serving as environmental footwear. It provides maximum foot protection in a CB environment, resists petroleum, oil, and lubricants (POL) and is flame resistant.

The JSLIST Block II Glove upgrade provides protection against liquid, vapor, and aerosol CB agents, is semi-permeable or selectively permeable to prevent excessive moisture buildup and improve user comfort. It is also flame resistant and its performance is not degraded by exposure to POL and field contaminants.

The Multipurpose Protective Sock (MPS) is designed to be worn over the standard issue sock to provide foot protection from CB agents when worn inside footwear.

FY01 Accomplishments:

JSLIST Second Source

- Conducted research and evaluation of second source material for JSLIST production.
- Initiated screening and testing on selected second source materials candidates.
- Evaluated and tested final selected material for second source for technology insertion to JSLIST.

Block I Glove Upgrade

- Started Operational Test (OT) and documentation transition to Block II glove program.

FY02 Objectives:

JSLIST Second Source

- Conduct live chemical agent swatch testing of source materials candidates.

Block II Glove Upgrade

- Start analysis to integrate Joint Service aviation and ground usage requirements and update acquisition strategy.
- Prepare RFP for acquisition of competitive materiel for source selection.
- Prepare program documentation for Interim Process Review (IPR).

FY03 Objectives:

Block II Glove Upgrade

- Conduct durability and chemical validation testing for ground and aviation missions.
- Complete acquisition of Block II Glove Upgrade candidates. Conduct air/ground Operational Test (OT) and complete Milestone C.

MPS

- Conduct air/ground Operational Test (OT) and complete Milestone C documentation.

FY03 Acquisition Phase: Production, Fielding/Deployment and Operational Support

	FY01				FY02				FY03				FY04				FY05				FY06				FY07				FY08			
	1	2	3	4	1	2	3	4	1	2	3	4	1	2	3	4	1	2	3	4	1	2	3	4	1	2	3	4	1	2	3	4
Milestones																																
Block I Glove MS C																																
Block II Glove MS C																																
MPS MS B																																
MPS MS C																																
Other Events																																
Block I Glove OT																																
Block II Glove conduct DT/OT																																
MPS DT/OT																																

Joint Transportable Collective Protection System (JTCOPS)

Lead Service



- Protection against chemical and biological agents, toxic industrial materials, and radiological particulate matter
- Use as stand-alone structure or within existing structures
- Ability to process personnel through a contamination control area to a contamination-free area

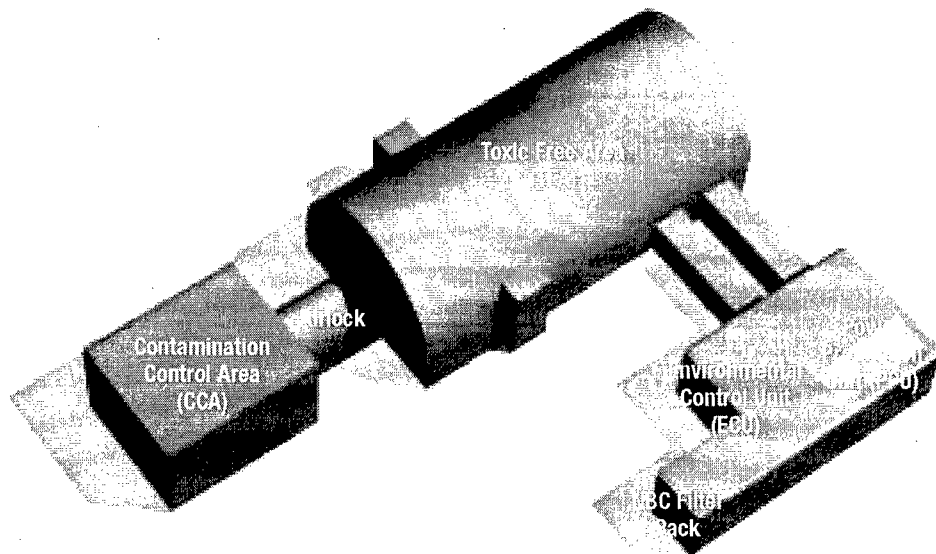

Contractors:

TBD

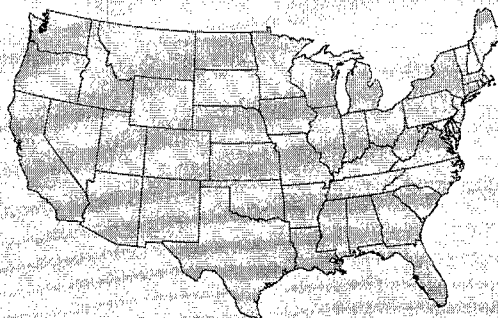

Program Description:

The JTCOPS will be a modular shelter system that will provide the ability to process contaminated personnel through a Contamination Control Area into a Toxic Free Area, and will be expandable to meet changing mission needs. It will allow collectively protected vehicles/vans to be connected for safe personnel ingress/egress. The system will include air filtration, environmental control, and power generation elements, and will be capable of using other available generator/power systems.

Block I will develop a new collective protection capability for existing shelters. A competitive contract will be awarded for the design and prototype fabrication phase, with options for Low Rate Initial Production (LRIP) and production. After successful completion of development testing and the Milestone B decision, the LRIP option will be exercised to produce systems for Operational Testing (OT). After completion of OT and the Milestone C decision, the production option of the contract will be exercised. Block II will develop a new, stand-alone collective protection shelter system.

FY01 Accomplishments:

- Revised the acquisition strategy to a block approach to align the program with the user priorities.
- Revised Milestone B documentation.

FY02 Objectives:

- No planned Program

FY03 Objectives:

- Conduct Milestone B Decision review for Block I.

FY03 Acquisition Phase: System Development and Demonstration

	FY01				FY02				FY03				FY04				FY05				FY06				FY07				FY08			
	1	2	3	4	1	2	3	4	1	2	3	4	1	2	3	4	1	2	3	4	1	2	3	4	1	2	3	4	1	2	3	4
Milestones																																
MS B Block I																																
MS C Block I																																
Other Events																																
Design and Fabricate Prototypes																																
DT Block I																																
OT Block I																																
LRIP																																

Joint Biological Agent Identification and Diagnostic System

Lead Service



- Identifies target biological agents and specifies the concentration of agent in submitted samples
- Capable of simultaneous identification of BW agents in clinical or environmental samples
- FDA approval process in progress for use as a diagnostic device



Contractors:

TBD

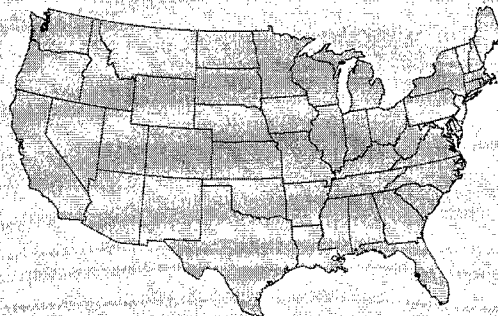

Program Description:

The Joint Biological Agent Identification and Diagnostic System (JBAIDS) is a reusable, portable, and modifiable biological organism identification and diagnostic system capable of reliable simultaneous identification of multiple biological warfare threat agents and other biological agents. JBAIDS will enhance force protection by providing commanders and medical personnel the capability to determine appropriate treatment, effective preventive measures, and prophylaxis in response to the presence of biological agents. JBAIDS will be configured to support reliable, fast, and specific identification of biological agents from a variety of clinical sources and preventive medicine samples. JBAIDS will be used in mobile and fixed site facilities as well as ground vehicles, aircraft and ships.

Block I is a rapid development effort to deliver a critical identification capability to the field in the shortest time possible. This is to be achieved by using Commercial Off The Shelf (COTS), Non-Developmental Items (NDI) or modified NDI items. Block II will build from the Block I system by focusing on automation of the sample processing, reduction in size and weight of the overall system, and adding the capability of identification of biological toxins. Block III will be a hand held device incorporating all of the features of the Block I and Block II systems.

FY01 Accomplishments:

- Continued research and development of concept technologies for JBAIDS.

FY02 Objectives:

- Initiate acquisition program for JBAIDS.
- Initiate design and production of reagents/assays critical for JBAIDS.
- Issue Pre-Solicitation Synopsis (PSS) to call for potential vendors.
- Conduct competitive testing of candidate technologies.
- Request for Proposals (RFP) from candidate vendors selected from competitive testing results.
- Milestone B decision.

FY03 Objectives:

- Contract Award
- Block I Critical Design Review (CDR)
- Production of 25 Block I test systems.
- Developmental and Operational Testing (DT/OA/OT) of Block I systems.
- Initiate Integrated Logistics Support (ILS) analysis development, technical drawing package requirements and technical manuals for Block II.
- Submission of materials for Food and Drug Administration (FDA) approval process for the hardware and assays for Block I.
- Determine system requirements for interfacing into a common Defense Medical Surveillance System (DMSS).

FY03 Acquisition Phase: System Development and Demonstration

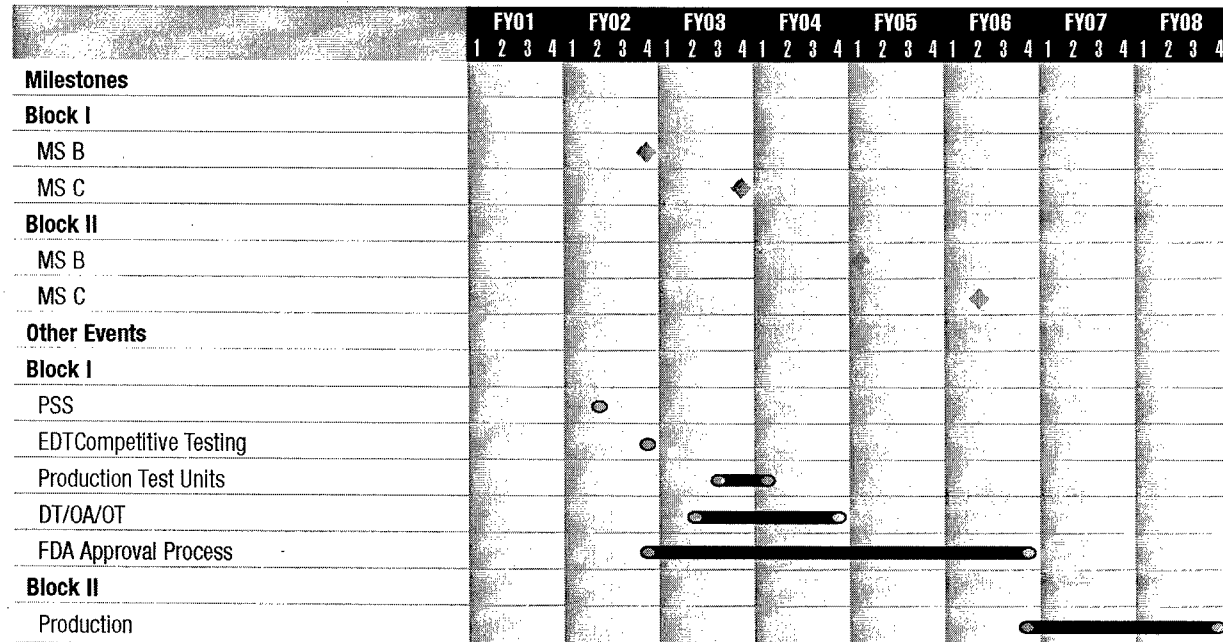

Medical Biological Defense Vaccines

Lead Service

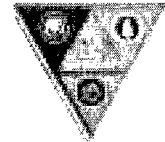
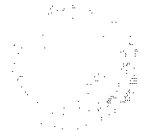

Joint Program Office for Biological Defense (JPO BD)



Joint Vaccine Acquisition Program (JVAP)



U.S. Army Medical Research and Materiel Command (USAMRMC)

Vaccines Currently Funded for Development

- Tularemia Vaccine
- Smallpox Vaccine
- Venezuelan Equine Encephalitis (VEE) Vaccine
- Recombinant Botulinum Vaccine
- Plague Vaccine
- Multivalent Eastern Equine Encephalitis (EEE)/ Western Equine Encephalitis (WEE)
- Ricin Vaccine
- Next Generation Anthrax Vaccine
- Staphylococcal Enterotoxin(s) (SE) Vaccine



Contractors:

DynPort Vaccine Company (DVC)
FREDERICK, MD

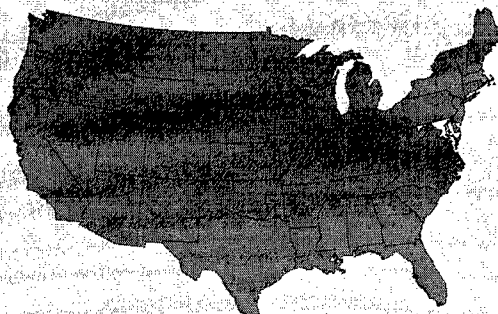

FY01 Accomplishments:

USAMRMC-Technology Base

- Tested VEE type 1E vaccine candidates for safety/efficacy in nonhuman primates (NHP).
- Determined immunogenic dose of live attenuated Brucella vaccine candidate in NHP.
- Compared efficacy of recombinant protective antigen (rPA) and licensed anthrax vaccine in animals and prepared technical data package supporting transition to advanced development.
- Prepared technical data package for recombinant plague vaccine.

JVAP-Advanced Development

- Conducted clinical trial to provide initial data demonstrating safety of vaccinia immune globulin (VIG).
- Prepared master and working seed banks for manufacture of Recombinant Botulinum (A, B) Vaccines.
- Completed pilot lot manufacture and conducted stability and formulation studies of VEE vaccine.

FY02 Objectives:

USAMRMC-Technology Base

- Test VEE type 3 and EEE vaccine candidates for efficacy in rodents and WEE and EEE vaccine candidates for safety/efficacy in NHP.
- Complete safety/efficacy testing in animal models of multiagent vaccine components.
- Perform preclinical animal studies with small-scale pilot lot of Brucella vaccine candidate.
- Evaluate intranasal/inhalation/transdermal application of recombinant protein vaccine formulations.

JVAP-Advanced Development

- Initiate clinical trial evaluating safety and efficacy of smallpox vaccine.
- Develop manufacturing capability for VIG.
- Initiate pilot lot manufacturing and stability testing of Tularemia and Recombinant Botulinum vaccines.
- Initiate technology transfer and process definition for a candidate recombinant Next Generation Anthrax Vaccine.

FY03 Objectives:

USAMRMC-Technology Base

- Test VEE type 3 vaccine candidates for efficacy in NHP and define surrogate markers of protection.
- Demonstrate effectiveness of Brucella vaccine candidate in NHP aerosol challenge model against pathogenic Brucellae spp.
- Demonstrate efficacy of recombinant protein vaccines in animal models using intranasal/inhalation and transdermal delivery methods.

JVAP-Advanced Development

- Acquire baseline stockpile quantities of both Smallpox vaccine and VIG.
- Initiate clinical trials to demonstrate safety of tularemia and recombinant Botulinum and Next Generation Anthrax vaccines.
- Manufacture and characterize master seed and working seed banks for plague vaccine.

FY03 Acquisition Phase: System Development and Demonstration

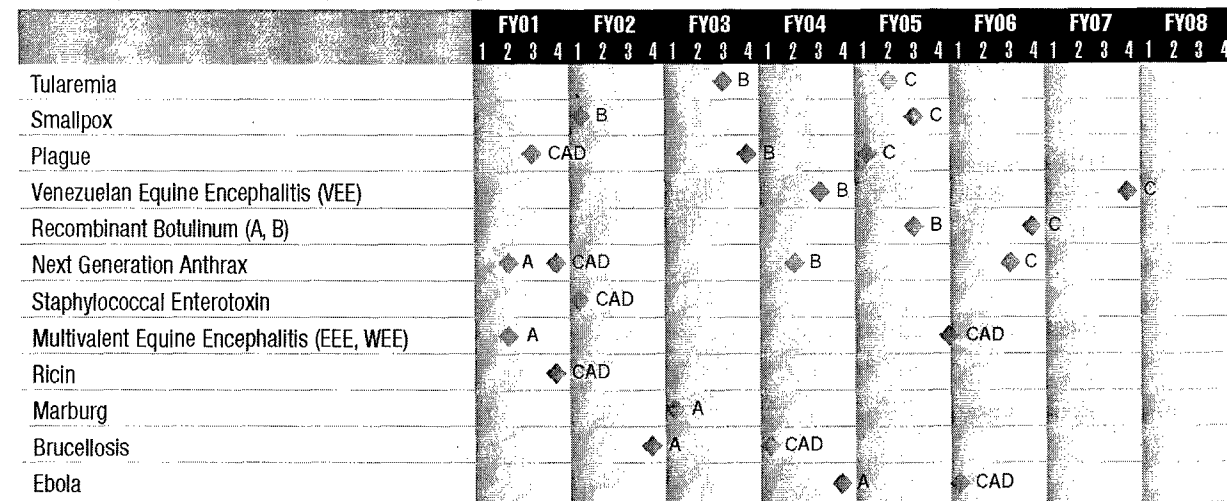

Medical GW/BW Information Products

Lead Service



Program Description:

The U.S. Army Medical Research Institute of Chemical Defense and the U.S. Army Medical Research Institute of Infectious Diseases are the world's premier sites for dissemination of information pertaining to the medical management of chemical or biological warfare agent casualties from military or terrorist activity. Regularly scheduled traditional on-site classroom training is supplemented by the use of textual and advanced distributed learning technologies. Viewing audiences include international and U.S. military personnel as well as domestic first responders. All products are available through [HTTP://CCG.APGEA.ARMY.MIL](http://CCG.APGEA.ARMY.MIL) and [HTTP://USAMRIID.ARMY.MIL](http://USAMRIID.ARMY.MIL).



Medical Management of Chemical/Biological Casualties (MCBC) Course

- Audience: physicians and nurses.
- Course taught by experienced personnel with working knowledge of threat.
- Broad dissemination of courses.

Field Management of Chemical/Biological Casualties (FCBC) Course

- Audience: medical and chemical noncommissioned officers, MSC, and Chemical Corps officers.
- Four to six in-house courses held per year.
- First echelon management of chemical/biological agent casualties.
- Course stresses planning, establishment, and management of a battalion aid station for both chemical and biological casualties to include decontamination site.



Satellite Courses

- Biological and Chemical Warfare and Terrorism: Medical Issues and Response
- Broad military, civilian, and international audience
- "Medical Response to Chemical Warfare and Terrorism"
- "Medical Response to Biological Warfare and Terrorism"

Contractors:

Camber Corporation
FREDERICK, MD

NMR
SILVERDALE PARK,
MD

SAIC
JOPPA, MD

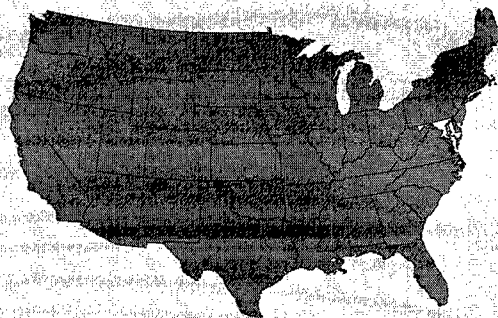

FY01 Accomplishments:

- Continued to provide education and consultation on medical issues of chemical/biological threat agents to military, federal, state, and local government, and civilian organizations through various distance learning modalities at reduced cost.
- Updated the Medical Management of Chemical and Biological Casualties Course Program of Instruction (POI), Terminal Learning Objectives (TLO), Individual Training Program (ITP), and Student Evaluation Plan (SEP).
- Developed an Interactive Multimedia Instruction (IMI) module for the Medical Management of Chemical Casualties Course (web and CD).
- Developed an Interactive Multimedia Equipment Catalog.
- Developed a Medical Management of Chemical and Biological Casualties Course Test Question Database.
- Continued to support various conferences, e.g., AMSUS, MEDIC-WMD2000, and NDMS.
- Continued live interactive satellite broadcast.
- Provided ongoing education, consultative services, and support to military quick response teams on the medical defense against CW/BW and terrorism.
- Published the fourth edition of the Medical Management of Biological Casualties Handbook.

FY02 Objectives:

- Continue to provide education and consultation on medical issues of chemical/biological threat agents to military, federal, state, and local government, and civilian organizations through various distance learning modalities at reduced cost.
- Update the FCBC Course POI, TLO, ITP, and SEP.
- Continue to support various conferences, e.g., AMSUS, MEDIC-WMD2000, NDMS, and Bioscience.
- Continue live interactive satellite broadcast.
- Provide technical information and references on DVD.
- Provide ongoing education, consultative services, and support to military quick response teams on the medical defense against CW/BW and terrorism.

FY03 Objectives:

- Continue to provide education and consultation on medical issues of chemical/biological threat agents to military, federal, state and local government and civilian organizations through various distance learning modalities at reduced cost.
- Continue to support various conferences, e.g., AMSUS, MEDIC-WMD 2000, NDMS and Bioscience.
- Provide technical information and references on DVD.
- Provide ongoing education, consultation services and support to military quick response teams on the medical defense against CW/BW and terrorism.
- Develop continuing education satellite products that explore advanced topics.
- Support DOD casualty management training objectives in response to enhanced demand post 911 events.
- Seek to incorporate instruction in management of radiological casualties into core curriculum.

Course Attendance (Registered Participants)

Information Products	Army	Navy	Air Force	Marines	Civilian	TOTAL
FY01 Actuals						
Medical Management of Chemical/Biological Casualties Course	590	158	74	2	60	884
Field Management of Chemical/Biological Casualties Course	210	36	6	0	4	286
Medical Management of Chemical/Biological Casualties Video Course	299	2	44	0	5	350
Subtotal without Satellite	1,099	196	124	2	99	1,520
Medical Response to Chemical Warfare and Terrorism 2000	1,225	282	483	32	2,188	4,210
FY01 TOTAL	2,324	478	607	34	2,287	5,730
FY02 Projected						
Medical Management of Chemical/Biological Casualties Course	594	204	86	0	190	1,074
Field Management of Chemical/Biological Casualties Course	228	94	2	0	82	406
Medical Management of Chemical/Biological Casualties Video Course	42	0	22	0	4	68
Subtotal without Satellite	864	298	110	0	276	1,548
BW, CW and Terrorism: Medical Issues and Response	1,000	1,200	800	20	6,200	9,220
FY02 TOTAL	1,864	1,498	910	20	6,476	10,768

Chemical Warfare (CW) Agent Pretreatments

Lead Service

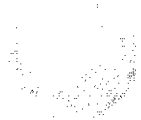

- The human butyrylcholinesterase enzyme has been mutated to spontaneously reactivate after its inhibition by nerve agents, thereby catalyzing the hydrolysis of nerve agents.
- This type of research employs the latest techniques in biotechnology, including enzymes tailored by site-directed mutagenesis.
- Skin Exposure Reduction Paste against Chemical Warfare Agents (SERPACWA)
 - CW agent skin pretreatment

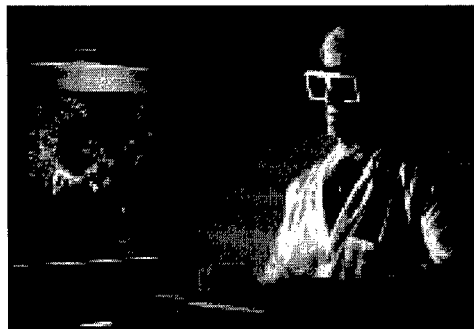

Contractors:

Battelle Memorial Institute
COLUMBUS, OH
McKesson Bioservices
ROCKVILLE, MD

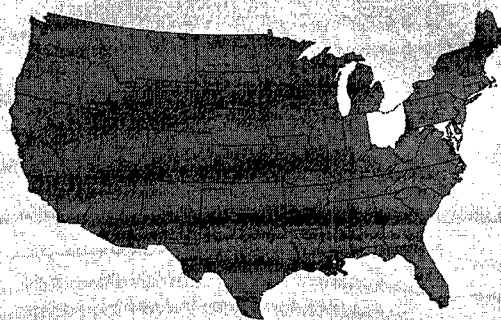

Program Description:

The medical chemical defense research efforts emphasize preventing chemical injuries by using pretreatments. Efforts are under way to design compounds that will "scavenge" and detoxify CW agents such as nerve agents or cyanide, and destroy the agent or physically remove it from the body. There is a similar effort to develop catalytically based protection for skin using a reactive compound mixed with a topically applied CW agent barrier cream.

Compounds or methods that show therapeutic promise are evaluated to demonstrate their safety, efficacy, and compatibility with established therapies and with other militarily relevant chemicals. Each drug that is a candidate CW agent pretreatment, treatment, protectant, or decontaminant is subjected to a battery of tests to transition to advanced development those that are the safest and most effective. Tests include behavioral studies that investigate whether these compounds interfere with the performance of military personnel.

FY01 Accomplishments:

- Tested best candidates of genetically engineered scavengers using advanced test systems, e.g., transgenic or knockout species.
- Demonstrated the efficacy of active Topical Skin Protectant (aTSP) candidate formulations using two animal species. Completed aTSP formulation studies and demonstrated efficacy against estimated battlefield levels of chemical warfare agents (CWAs).

FY02 Objectives:

- Select best bioscavenger candidate(s) for nerve agents based on comparison of performance in decision tree network and other differentiating studies and prepare Component Advanced Development (CAD) package. Set up non-human primate animal models to evaluate different scavengers for safety and efficacy with guidance from scientific steering committee. Examine human protein scavengers for autoimmune issues.
- Select the best candidate(s) aTSP formulation for transfer to development.

FY03 Objectives:

- Verify adequacy of transgenic animal model for large-scale production of enzyme scavenger material for clinical trials.

Schedule: Concept and Technology Demonstration

	FY01				FY02				FY03				FY04				FY05				FY06				FY07				FY08			
	1	2	3	4	1	2	3	4	1	2	3	4	1	2	3	4	1	2	3	4	1	2	3	4	1	2	3	4	1	2	3	4
Nerve agent scavenger pretreatment/therapy								◆ CAD																								
Active Topical Skin Protectant								◆ CAD																								

CB Agent Therapeutics and Diagnostics

Lead Service



Vesicant Research

- Confocal laser scanning microscopy and immunofluorescent techniques used to determine the effects of sulfur mustard (HD) following exposure



Common Diagnostic Systems

- A battery of nucleic acid-based detection systems
- Broad applications
- Sensitive and specific

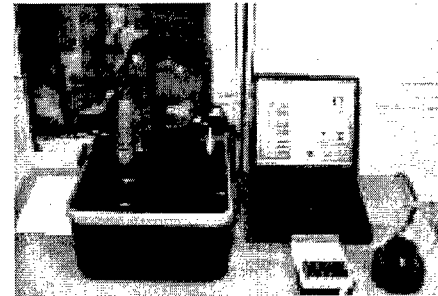

Field Cholinesterase Test Kit

- Self-contained, hardened
- Photometric analyzer
- Small sample size, serves up to 96 service members in one kit
- Results available in four minutes



Convulsant Antidote for Nerve Agent

- Consists of diazepam in an autoinjector
- Used as an adjunct therapy for nerve agent poisoning to control convulsions, protect against brain injury, and enhance survival

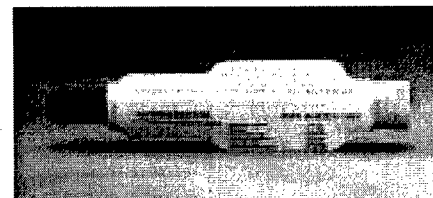

Contractors:

Battelle Memorial Institute
COLUMBUS, OH

Cepheid
SUNNYVALE, CA

Meridian Medical Technologies, Inc.
ST. LOUIS, MO

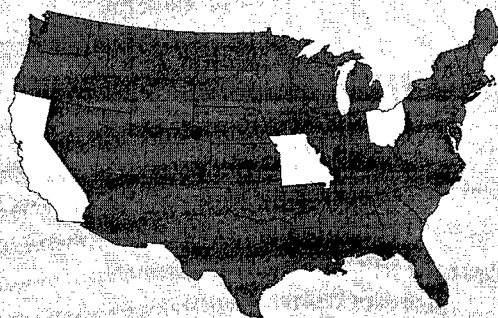

Joint Service Fixed Site Decontamination (JSFXD)

Lead Service

- Decontamination of fixed sites, ports of entry, airfields, logistics nodes and key command and control centers
- Family of decontaminants and applicators
- Nontoxic and noncorrosive
- No adverse effects on electronics after ("On-the-Move" Decon)

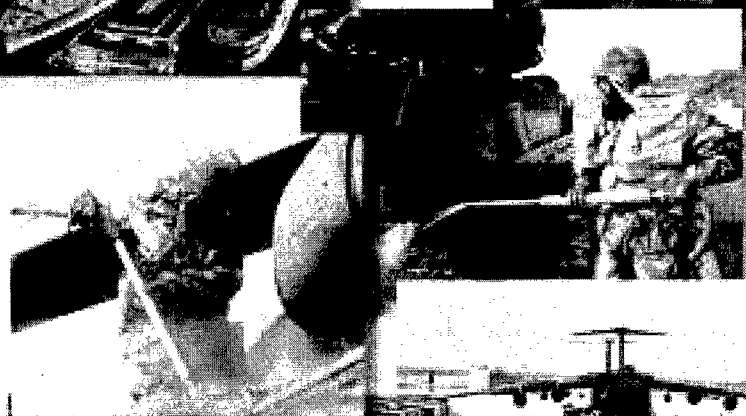

Contractors:

Battelle Memorial Institute
COLUMBUS, OH
Sverdrup
WOODBRIDGE, VA
USAMMDA
FT. DETRICK, MD

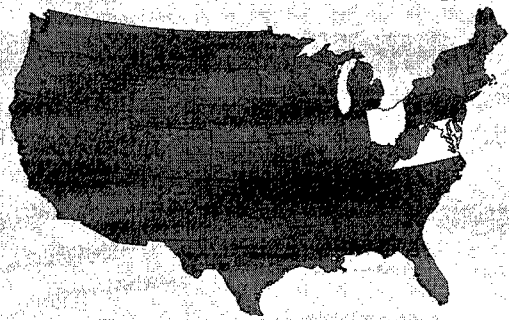

Joint Service Sensitive Equipment Decontamination (JSSED)

Lead Service



- Addresses Nonaqueous Equipment Decon System (NAEDS) requirements
- Consists of three distinct capability blocks:
 - Decon of small, sensitive equipment/items and components/parts
 - Decon of interior spaces of vehicles containing electronics and exterior of vehicles where the user cannot use DS2
 - Decon during operations (“On-the-Move” Decon)



Contractors:

TBD

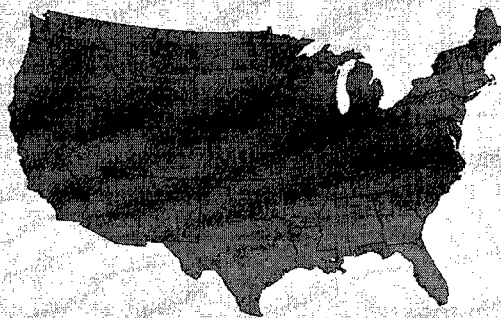

Program Description:

The JSSED system will fill an immediate need to decontaminate chemical and biological warfare agents from sensitive equipment, vehicle/aircraft interiors, and associated cargo, as defined in the draft Joint Service Operational Requirements Document (JSORD) for the JSSED. The JSSED will be a dual technology development program; one technology to decontaminate sensitive items/equipment and a second technology to decontaminate vehicle/aircraft interiors. The JSSED will utilize a three block approach to address individual key capabilities to reduce program risk and support production schedule. Block I will do sensitive equipment/items decontamination. Block II will do aircraft/vehicle interior decontamination. Block III will do aircraft/vehicle interior decontamination "on the move."

FY01 Accomplishments:

- Prepared and submitted Block I Milestone documentation, which included Test and Evaluation Master Plan, System Acquisition Master Plan, and Acquisition Program Baseline.

FY02 Objectives:

- Award Block I competitive contract to deliver three system models from each of two contractors and investigate design improvements to meet military requirements.
- Conduct assessments evaluating performance and procedures in a chemical environment. Conduct assessments of the effectiveness of interior building areas for use as a chemical rest and relief areas.

FY03 Objectives:

- Conduct Block I program Interim Progress Review (IPR) to finalize Block I technology and system design.
- Award contract to fabricate Block I developmental test systems which implement design improvements from the prior year competitive prototypes.
- Initiate pre-production Block I system test design.
- Prepare and submit Block II/III Milestone B documentation, which includes Test and Evaluation Master Plan, System Acquisition Master Plan, and Acquisition Program Baseline.
- Prepare Request for Proposal for Block II/III combined development effort.

FY03 Acquisition Phase: System Development and Demonstration

		FY01				FY02				FY03				FY04				FY05				FY06				FY07				FY08			
		1	2	3	4	1	2	3	4	1	2	3	4	1	2	3	4	1	2	3	4	1	2	3	4	1	2	3	4	1	2	3	4
Milestones																																	
Block I	MS B	◆																															
Block I MS C Type Classification																																	
Block II/III	MS B												◆																				
Other Events																																	
Prototype DT 1		■																															
Evaluate Candidate BLK I Prototypes						■	■																										
Downselect Block I Prototype										■																							

Modular Decontamination System (MDS)

Lead Service



- Limit the spread of NBC contamination on the battlefield
- Replaces the M17 Lightweight Decon System and the M12A1 Skid Mounted Decon Apparatus

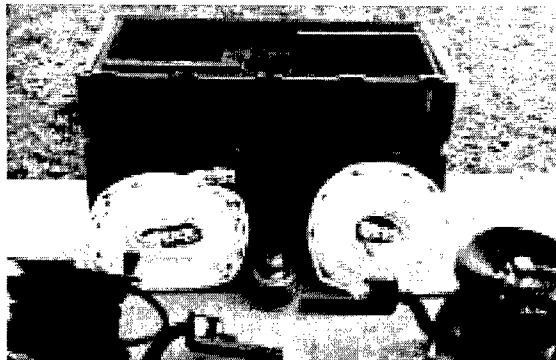
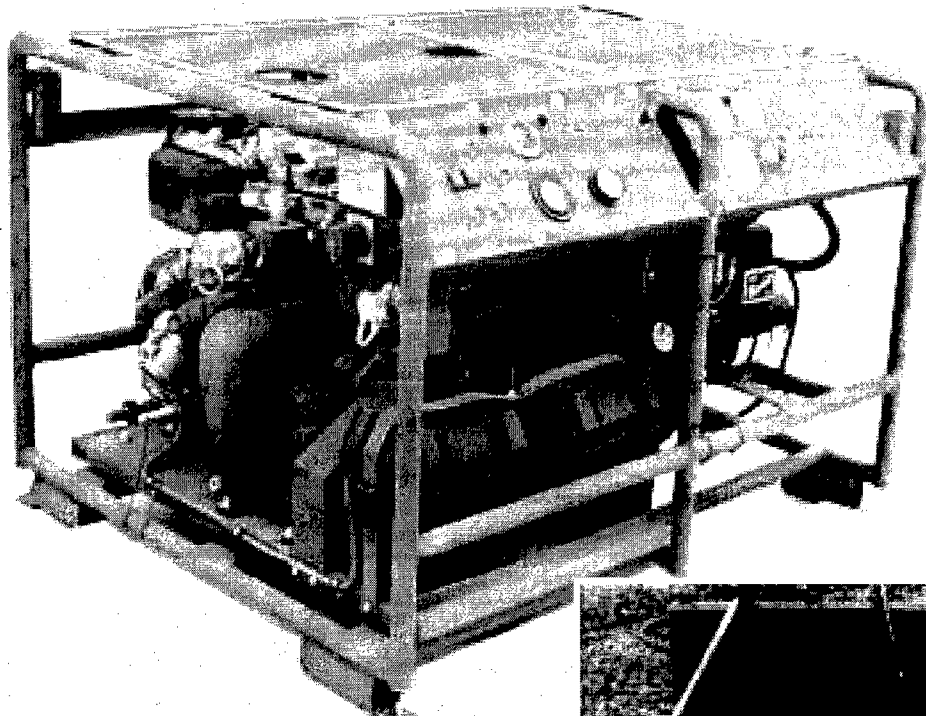

Contractors:

Centech Group, Inc.
Hugo, OK

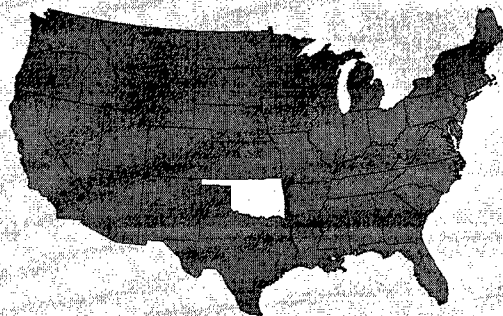

Sorbent Decontamination

Lead Service



- Noncorrosive, nonaqueous decontaminant
- Increased reactivity and capacity
- Reduced off-gassing and contact hazards
- Potential replacement for current DS2 decontaminant

Replacement for:

M-11 Spray Unit



M-13 Spray Unit

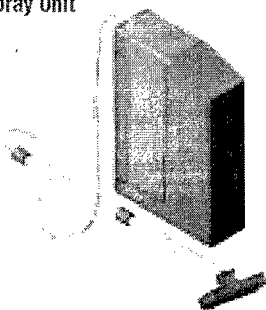

Highly Adsorptive, Reactive Powder

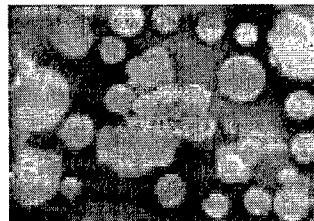

M24 Sorbent Decontamination System



Personal Wipedown Mitts (EDU Pocket-sized Packet)

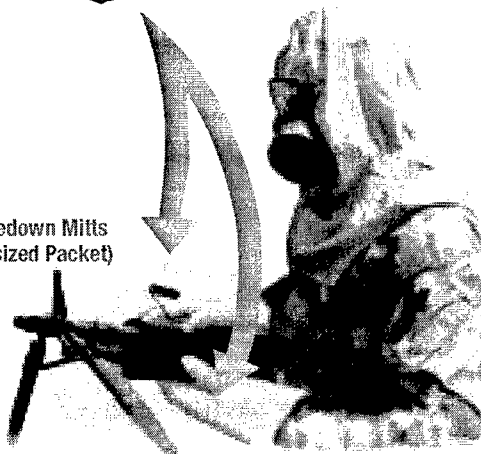

Contractors:

Guild Associates
DUBLIN, OHIO (R&D)

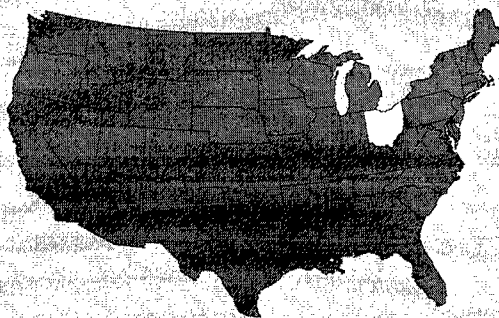

Program Description:

The SORBDECON program provides a reactive powder technology and a family of applicators for immediate decontamination. This program consists of two separate systems: personal wipedown and operator spraydown operations. Sorbent replaces the XE555 resin in the M295 Decontamination Kit for wipe down procedures. Sorbent and a dispenser system will replace M11's and M13's used for immediate decontamination, and associated Decontaminating Solution 2 (DS2) in operator spray down procedures. Sorbent is environmentally acceptable, noncorrosive, stable and useable over a wide temperature range, and can be safely carried and used by personnel. Sorbent will be used by personnel to decontaminate personal equipment, key areas of vehicles and crew-served weapons. It will also eliminate the transfer hazard and preserve Mission Oriented Protective Posture (MOPP) integrity.

FY01 Accomplishments:

- Completed baseline toxicity testing of sorbent material.
- Completed development and support of Milestone III decision documentation for operator's spray down system on equipment.
- Procure 30,000 M100 kits.

FY02 Objectives:

- Procure 141,000 M100 kits.

FY03 Objectives:

- Procure 130,300 M100 kits.

FY03 Acquisition Phase: Production, Fielding/Deployment and Operational Support

	FY01				FY02				FY03				FY04				FY05				FY06				FY07				FY08							
	1	2	3	4	1	2	3	4	1	2	3	4	1	2	3	4	1	2	3	4	1	2	3	4	1	2	3	4	1	2	3	4				
Milestones																																				
M100 MS III	◆																																			
Other Events																																				
M100																																				
Production/Deliveries	—																																			
Initial Operational Capability	●																																			
Skin Decon																																				
DT/OT	● ●																																			

Battle Management

Lead Service



The Modeling and Simulation Commodity Area was realigned with Command, Control, Communications, Computers and Information (C4I) related efforts from the Contamination Avoidance Commodity Area to create the Battle Management Commodity Area on 11 April 2002. The Battle Management Commodity Area is comprised of all Modeling and Simulation programs, the Joint Warning and Reporting Network (JWARN), the Embedded Common Technical Architecture (ECTA) program, and the S&T efforts of the Information Systems Technology Business Area. This realignment is a major step toward meeting the goals of seamless warfighter understanding of the operational environment and the options available to meet the NBC threat. Both the Joint Service Integration Group (JSIG) and the Joint Service Material Group (JSMG) have been working under the guidance of the Deputy Assistant to the Secretary of Defense for CB Defense ((DATSD)(CBD)) to address the rapidly growing need for integrated NBC information systems that take our emerging predictive M&S capabilities along with accredited data bases and interactive sensor networks and make them available through established operational C4I systems to all DoD community decision makers. The JSIG and JSMG work together in developing the "Vision" and the Chemical and Biological M&S Master Plan. The "System of Systems," as shown in the graphic on page 65, is derived from the Master Plan and depicts the interoperability and interdependability of the separate major thrusts. Though M&S is in the center of this graphic, critical connections to the operational warfighters and decision makers are shown clearly through the JWARN and C4I systems. This approach, based upon clearly defined operational requirements, will address the needs for nuclear, chemical and biological information systems in the areas of acquisition, analysis and training. Strict adherence to Test and Evaluation, Verification, Validation and Accreditation principles, standards, and directives will ensure that these efforts meet those requirements. Recent direction from the Deputy Secretary of Defense has delegated responsibility for accreditation of common use CB M&S to the DATSD(CBD).

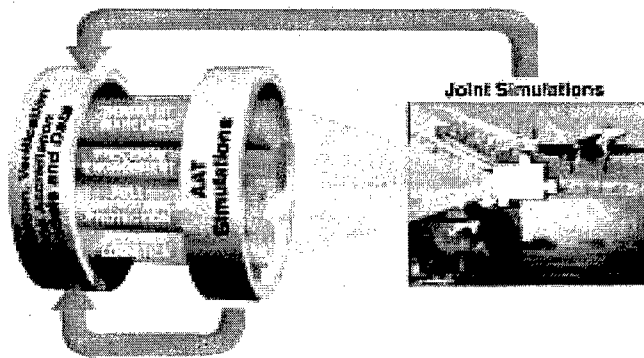

Analysis, Acquisition, Training

FY 01 Accomplishments:

- Completed the Draft Chemical and Biological Model and Simulation Master Plan.
- Initiated development of the Conceptual Model Mission Space for chemical and biological modeling and simulations.
- Developed Draft Operational Requirements Documents covering chemical and biological defense modeling and simulation development for acquisition, analysis and training.
- Successful Milestone A, Lead Service selection, and program start for the Joint Effects Model (JEM) acquisition program.
- Transitioned Simulation Training and Analysis For Fixed Sites (STAFFS) to Center for Army Analysis.
- Completed Vapor Liquid Solid Tracking (VLSTRACK) Version 3.1 development.

FY 02 Objectives:

- Prepare JEM Program to meet Milestone B in first quarter FY03.
- Milestone A, Lead Service selection and program start for the Joint Operational Effects Federation (JOEF) acquisition program.
- Milestone A and Lead Service selection for the Virtual Prototyping System and Training Simulation Capabilities acquisition programs.
- Complete Operational Requirements Documents for all three areas: Analysis, Acquisition, and Training.
- Initiate expanded Information Technologies Business Area to support the full spectrum of Information Systems requirements.
- Expand tech base program to address urban, high altitude, and meteorological interface methodologies.

FY 03 Objectives:

- Initiate Concept & Technology Development Phase of both Virtual Prototyping System and Training Simulation Capability Programs.
- Prepare JEM Block I for IV&V in FY04.
- Complete JOEF Concept & Technology Development Phase.

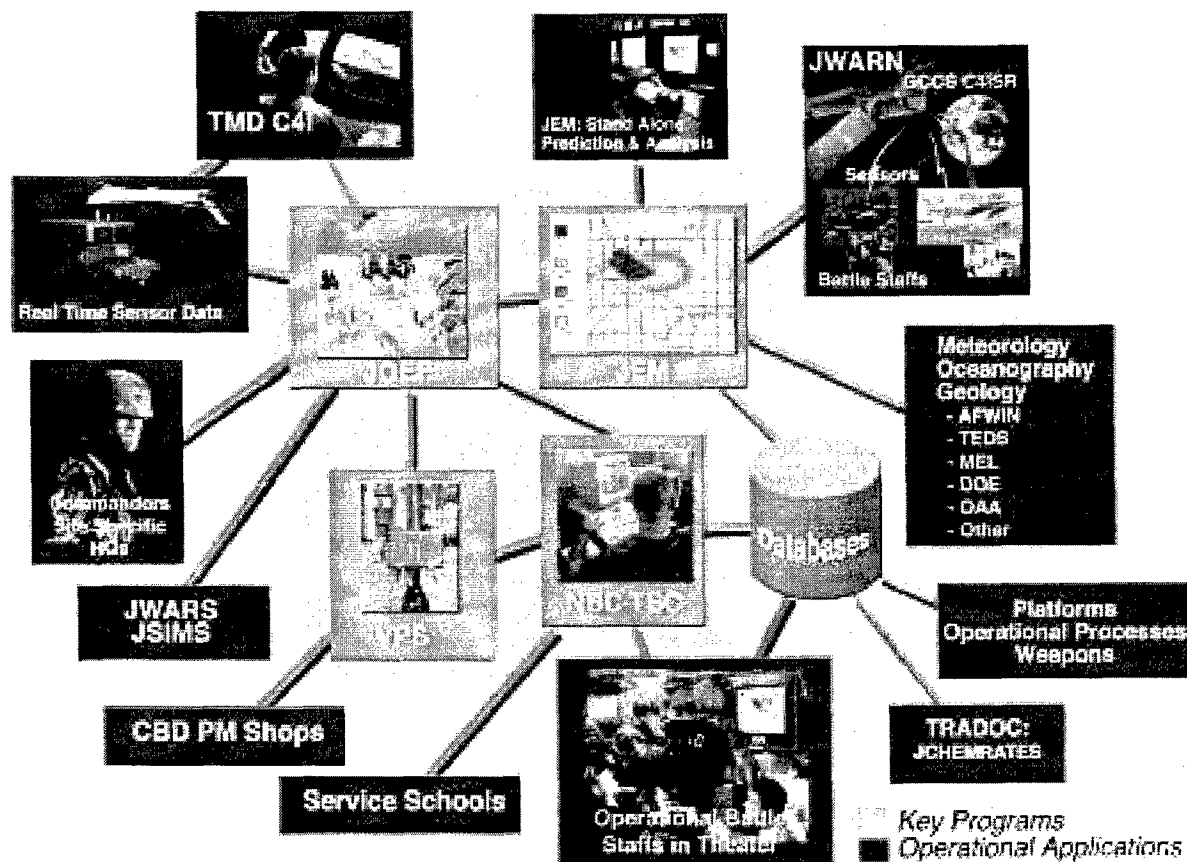

Joint Effects Model

Lead Service

- JEM will be capable of modeling hazards in a variety of scenarios including: counterforce, passive defense, accident and/or incidents, high altitude releases, urban NBC environments, building interiors and human performance degradation.
- JEM Block I will be capable of predicting hazard areas and weapons effects
- JEM Block I will be integrated on the Services' C2 systems and interface with JWARN

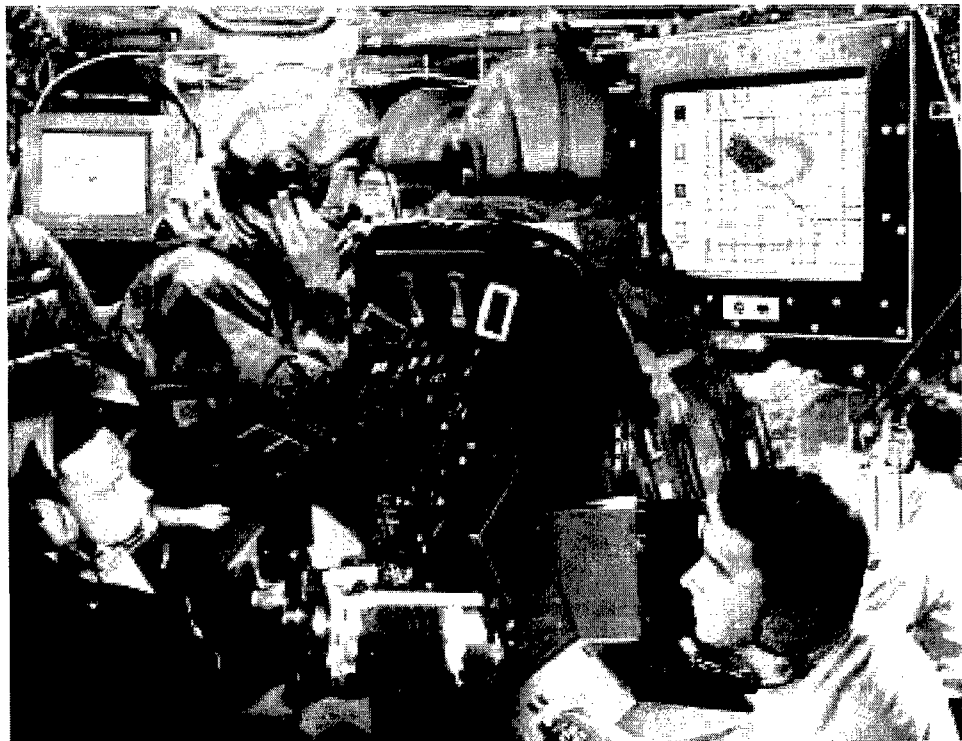

Contractors:

Northrop Grumman
Information Technology
SAN DIEGO, CA

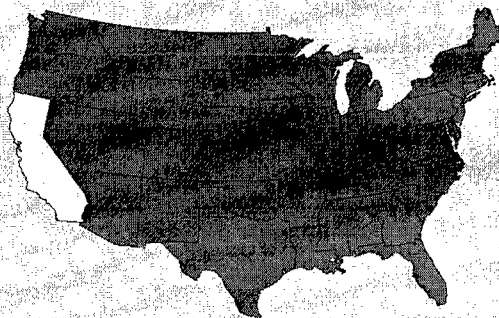

Program Description:

JEM will be the standard DoD accredited model for predicting NBC hazards associated with the release of contaminants into the environment. JEM will use an evolutionary acquisition approach and will be developed in three blocks.

Block I:

- Transition current Science & Technology efforts (VLSTRACK, HPAC, D2PUFF) to an acquisition program.
- Integrate a functional combination of the "best of the best" capabilities from VLSTRACK, HPAC, and D2PUFF models within an interoperable architecture and a user friendly interface.

Block II:

- Add the capabilities to model NBC effects associated with releases from high altitude missile intercepts and within urban environments.
- Include provisions for weather effects above 20 km and precipitation.
- Improve the transport and diffusion methodology.

Block III:

- Add the capabilities to model NBC effects associated with complex structures, building interiors, and human performance degradation
- Upon completion of the Block I Independent Model Analysis effort, credibility and performance requirements will be refined in an iterative process through a series of design reviews, using cost-effective graphical storyboarding prior to actual implementation of the algorithms and data harvested from the legacy Nuclear, Biological, and Chemical (NBC) models. A cost plus award/incentive fee contract will be used for model development.

FY01 Accomplishments:

- Achieved Milestone A.
- Initiated Model IPT to evaluate VLSTRACK, HPAC, and D2PUFF hazard prediction technologies.
- Initiated program planning.

FY02 Objectives:

- Complete Model IPT evaluation of VLSTRACK, HPAC, and D2PUFF.
- Award contract for development of engineering builds in support of the Block I effort.
- Initiate analysis of existing field test data associated with the hazard prediction models VLSTRACK, HPAC, and D2PUFF and identify data gaps.
- Develop Test and Evaluation Master Plan (TEMP) and validation, verification and accreditation plan.
- Initiate Independent Validation and Verification (IV&V) effort.
- Develop and refine Warfighter use cases.
- Continue technical data transition of HPAC, VLSTRACK, and D2PUFF models.

FY03 Objectives:

- Complete transition from tech base.
- Update MS B program documentation and conduct MS B decision.
- Continue to develop Test and Evaluation Master Plan (TEMP) and validation, verification and accreditation plan.
- Award contract for development of engineering builds (software only) in support of the Block I effort.

FY03 Acquisition Phase: System Development and Demonstration

	FY01				FY02				FY03				FY04				FY05				FY06				FY07				FY08			
	1	2	3	4	1	2	3	4	1	2	3	4	1	2	3	4	1	2	3	4	1	2	3	4	1	2	3	4	1	2	3	4
Milestones																																
BLK I MS A			◆																													
BLK I CAD Review							◆																									
BLK I MS B											◆																					
BLK I MS C												◆																				
Other Events																																
BLK I OT																○																
BLK I IOC																				○												

Joint Warning and Reporting Network (JWARN)

Lead Service

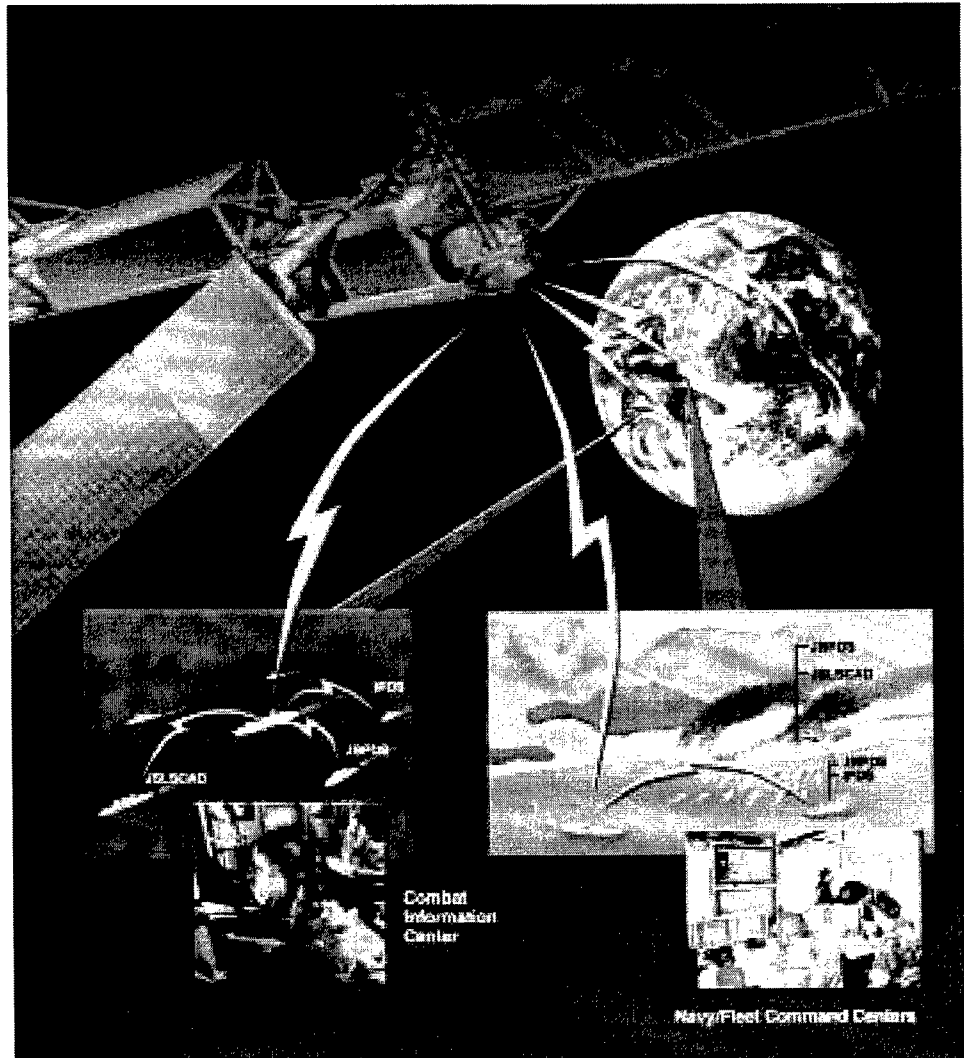
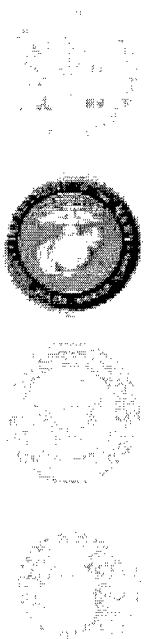

Contractors:

Block I:
Bruhn Newtech
Columbia, MD

Block II:
Sverdrup
Dulles, VA

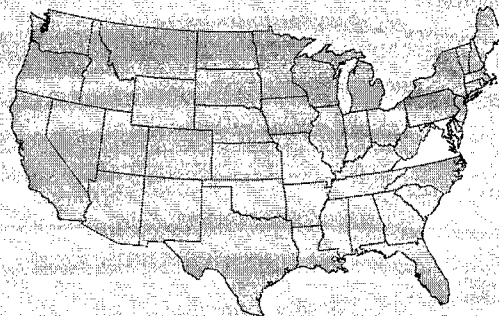

Program Description:

The JWARN will provide standard integration and analysis of NBC detection information with command, control, communications, computers, information and intelligence (C4I2) on the battlefield automating the NBC Warning and Reporting processes currently performed manually throughout the Services. The JWARN will collectively consist of commercial off the shelf (COTS) materiel and JWARN software for C4I2. JWARN is being developed for deployment with NBC detectors in the following battlefield applications: combat and armored vehicles, tactical vehicles, vans, shelters, shipboard application, area warning, semi-fixed and fixed sites. Block I was the initial acquisition and fielding of COTS and government off the shelf (GOTS) software to standardize NBC Warning and Reporting throughout the Armed Forces. Block II will integrate NBC legacy and future detector systems, NBC Warning and Reporting software modules, and NBC battlespace management modules in the Joint Services C4I systems. Block II will investigate new NBC Warning and Reporting software technologies and developmental NBC detectors/sensors. Block III will also investigate software changes to Service C4I systems.

FY01 Accomplishments:

- Prepared documentation for start of System Development and Demonstration (SDD) effort. Finalized Block II Software Development Plan.

FY02 Objectives:

- Start Block II integration of NBC legacy and future detector systems. Develop NBC warning and reporting modules and battlespace management modules for use by Joint Services C4I2 systems.
- Conduct Block II Modeling and Simulation for compatibility with the Joint Effects Model (JEM).
- Conduct Block II system DT II for Key Performance Parameters/Operational Assessment.
- Prepare integrated logistical support technical data.

FY03 Objectives:

- Continue Block II integration of NBC legacy and future detector systems and conduct DT I/Operational Assessment for full system requirements.
- Start to prepare documentation for Block II MS C.

FY03 Acquisition Phase: System Development and Demonstration

	FY01				FY02				FY03				FY04				FY05				FY06				FY07				FY08			
	1	2	3	4	1	2	3	4	1	2	3	4	1	2	3	4	1	2	3	4	1	2	3	4	1	2	3	4	1	2	3	4
Milestones																																
BLK II MS C																																
Other Events																																
SDD Contract Award																																
DT I/OT																																
DT II/Operational Assessment																																

Joint Service Installation Protection Program (JSIPP)

Lead Service



- Assess threat potential of classic, emerging and genetically engineered biological threats.
- Provide integrated Homeland Security capability to detect, mitigate and respond to biological related incidents.



Contractors:

TBD

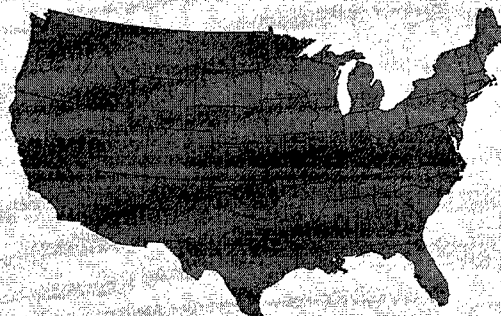

Mission/Description:

This program is designed to increase CB capabilities at DoD installations and will equip nine diverse DoD installations with Contamination Avoidance Equipment. It will also provide a defensive capability for identification of a Chemical, Biological, Radiological, Nuclear and high-yield Explosive (CBRNE) incident on a given installation. Protection of first responders while they perform their duties in or around a contaminated area, and an ability to decontaminate and medically manage casualties resulting from the incident are hallmarks of this program as well.

FY01 Accomplishments:

- N/A

FY02 Accomplishments:

- N/A

FY03 Accomplishments:

- Procure 9 sets of CB Emergency Response Equipment to augment the Joint Service Installation Protection Project.

FY03 Acquisition Phase: Production and Deployment

	FY01				FY02				FY03				FY04				FY05				FY06				FY07				FY08			
	1	2	3	4	1	2	3	4	1	2	3	4	1	2	3	4	1	2	3	4	1	2	3	4	1	2	3	4	1	2	3	4
Milestones																																
Other Events																																
Procure Protective Ensembles																																
Procure Chem/Rad/Bio Detection and Survey Equipment																																
Procure Patient Decontamination Materials and Equipment																																
Procure Medical Equipment and Pharmaceuticals																																
Procure C3 and Computer Equipment																																

Homeland Security/WMD-CSTs

Lead Service



- To provide an integrated Homeland Security capability to detect, mitigate and respond to biological related incidents.
- To assess the threat of potential classic, emerging and genetically engineered biological threats.
- Provides on site response elements to a WMD event at the state level
- Augments hospital, patient decontamination capabilities



Contractors:

TBD

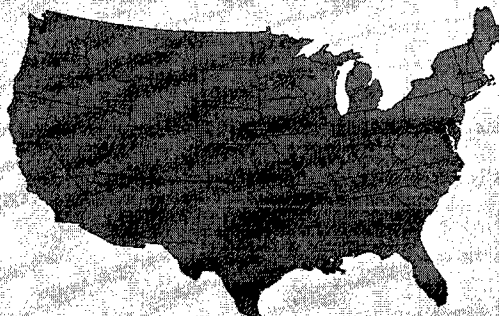

Lead Service



The Deputy Assistant to the Secretary of Defense for Chemical and Biological Defense (DATSD(CBD)) is the Office of the Secretary of Defense (OSD) office responsible for providing technical oversight of all service and defense agency science and technology base (S&T) programs and reviewing these programs through three key Department of Defense (DoD) S&T documents.

- The Joint Warfighting S&T Plan (JWSTP)
- The Defense Technology Area Plan (DTAP), and
- The Basic Research Plan (BRP)

Defense S&T Reliance, under the leadership of the Deputy Under Secretary of Defense for Science and Technology (DUSD (S&T)), provides the framework and assessment process to enable the DoD S&T community to work together to enhance the Department's S&T program. The S&T Reliance has participation of the Services and DoD Agencies, thereby strengthening cooperation and improving responsiveness to their warfighting and acquisition customers. Twelve technology area panels form the Defense S&T Reliance and are responsible for preparation of the Defense Technology Area Plan (DTAP). DTRA, CB Director chairs the DTAP Chemical/Biological Defense technical area panel and is responsible for Chapter 12 of the DTAP. The DTAP presents DoD objectives and the Applied Research (6.2) and Advanced Technology Development (6.3) investment strategy for technologies critical to DoD acquisition plans, service warfighter capabilities, and the Joint Warfighter S&T Plan. It also takes a horizontal perspective across the service and defense agency efforts, thereby charting the total DoD investment for a given technology. The DTAP documents the focus, content, and principal objectives of the overall DoD science and technology efforts. This plan provides a sound basis for acquisition decisions and is structured to respond to the DUSD(S&T) emphasis to mature technology for rapid transition to the operational forces.

The Joint Science and Technology Panel for CB Defense (JSTPCBD) is the principal organization under the Joint Service Materiel Group (JSMG) chartered to manage CB technology-based programs. The JSTPCBD follows Defense Planning Guidance in preparing the CB Defense Program S&T budget and programming efforts. Through this process the JSTPCBD generates a list of ranked proposals with recommended funding levels.

FY01 Accomplishments:

- Demonstrated agreement between model and experiment of imaging of biological clusters.
- Demonstrated new aerosol collector with substantially reduced power consumption and operable at low temperatures.
- Demonstrated automated sample processor systems for genetic and mass spectrometric detection of biological materials.
- Developed models for simulation of CB weapons effects on joint force operations.
- Completed water monitor breadboard design integrating chemical and biological contaminant detection capabilities.
- Demonstrated 16-pixel imaging passive infrared (IR) spectrometer in real-time operation at 100 Hz.
- Completed demonstration of sensitive equipment decontamination methodologies and transition to Joint Service Sensitive Equipment Decontamination (JSSED) Block I program.

FY02 Objectives:

- Demonstrate molecular imprinting technique for individual passive chemical agent detector.
- Demonstrate initial operational capability of the Simulation, Training, and Analysis for Fixed Sites (STAFFS) model for simulation of CBW effects on operations at Aerial Ports of Debarkation (APODs) and Sea Ports of Debarkation (SPODs).
- Demonstrate breadboard water monitor integrating chemical and biological detection capabilities.
- Complete assessment of utility of radar as CB event queuing technology.
- Develop approaches for Superior Decontamination Systems using advanced formulations.
- Complete miosis threshold studies for sarin over extended exposure durations and initiate multi-species animal studies for second-generation nerve agents.

FY03 Objectives:

- Conduct decontamination efficacy testing against an expanded test bed of agents.
- Complete development of Force Discrimination Assay.
- Continue exploration of new concepts for small, combined chemical and biological identifiers.
- Continue to measure quantitative performance of candidate aerosol collectors for advanced biological and chemical point detection technology.



Advanced Technology

What is an ACTD?

Advanced Concept Technology Demonstrations (ACTDs) are an integral element of reforming the acquisition process and accelerating the application of mature technologies to solve military problems. The ACTD process permits the early evaluation of mature advanced technology to meet the needs of the warfighter. Evaluations are accomplished by the warfighter to determine military utility before a commitment is made to proceed with formal acquisition. ACTDs also allow the warfighter to develop and refine operational concepts to take full advantage of new capabilities. ACTDs provide sustainment support for two years for the continued evaluation of the technology after which it can be transitioned into an appropriate phase of formal acquisition.

ACTDs are sponsored and executed jointly by a team composed of an operational user and a technology developer, with approval and oversight from the Deputy Under Secretary of Defense for Advanced Technology (DUSD(AT)). ACTDs are normally conducted under an Integrated Product Team (IPT) approach that considers the operational needs, training, supportability, and other related issues, as well as concerns of the acquisition community.

The sponsor is responsible for defining the mission and scenario, concept of operations, operational forces, and post-demonstration evaluation criteria.

The acquisition activity is responsible for day-to-day technical and program management. A range of conclusions can result from an ACTD from "don't acquire" to "procurement," or a mid-range solution that places the product into some mid-range posture within the acquisition cycle.

The ACTD concept has been used to good effect within the Joint CBD program, and its use continues today. Current CBD programs operating under the ACTD concept are described below.

Air Base/Port Biological Detection (Portal Shield)

- Objective:** To provide interim capability to detect, alarm/warn/dewarn, and presumptively identify BW attack.
Evaluate the military utility of sensor network, RF links, alarms, and assessment processes.
- Sponsor:** CINCPAC and CENTCOM
- ACTD Scenario:** BW attack on an airbase/port facility.
- Status:** ACTD completed in FY99, and transitioned into procurement as a result of Joint Chiefs of Staff (JCS) directed buy. Program procured 70 sensors in FY99 and 97 in FY01.



Chemical and Biological Individual Sampler (CBIS)

- Objective:** Improved detection and identification capabilities will provide greater awareness of immediate chemical exposure risk.
- More precise identification of both short- or long-term and low-level doses resulting in improved situational awareness, treatment and record keeping.
- Additional payoffs will include ability to perform realtime analysis of agents and toxic industrial materials (TIMs), communication of exposure information to command centers, and increased battlefield awareness and intelligence.
- Sponsor:** Joint Forces Command
- ACTD Scenario:** TBD
- Status:** The CBIS Phase I effort (COTS passive chemical sampling only) has been initiated with live agent testing of four COTS samplers and analysis of available portable analytical equipment.

Restoration of Operations at Fixed Sites (RestOps)

- Objective:** Integrate and demonstrate mature technologies and tools used to mitigate adverse effects and restore operations at a fixed site before, during, or after an attack of either CW or BW, in order to support operational war plans.
- Develop, improve, and integrate concepts of operations (CONOPS) and tactics, techniques, and procedures (TTPs) for executing RestOps contingencies at a fixed site.
- Capture lessons learned for incorporation into joint, multiservice, and service doctrinal publications.
- Evaluate the science and technologies available to support identification of potential improvements in current U.S. policy for CONUS and OCONUS RestOps scenarios.
- Sponsor:** PACOM
- ACTD Scenario:** Chemical or biological attack on an airfield.
- Status:** The Baseline Exercise was conducted at the demonstration site. Technology limited utility assessments were completed in FY01. The Preliminary Technology demonstration was recast into 4 smaller demonstration vignettes to be completed in FY02. Final technology demonstration to be conducted in FY03.

Contamination Avoidance at Seaports of Debarkation (CASPOD)

- Objective:** Demonstrate operational concepts and Tactics, Techniques, and Procedures to initiate and sustain Chem/Bio defense operations at Seaports of Debarkation.
- Identify and refine the force structure necessary to implement procedural and equipment requirements.
- Develop and demonstrate resident, pre-positioned, or rapidly transportable Chem-Bio defense equipment and materiel packages needed for employment at Seaports of Debarkation.
- Identify strategic operational improvements, shortfalls for CASPOD contingencies.
- Provide a forum, process, and structure for addressing and modifying U.S., coalition, and host nation policy issues.
- Sponsor:** CENTCOM
- ACTD Scenario:** Chemical or biological attack on a seaport.
- Status:** CASPOD was approved for execution as an FY02 new ACTD start on 20 February 2002. Baselining activities and initial technology selections to be completed in FY02. Limited utility assessments and the Preliminary Demonstration are planned for execution in FY03. Final demonstration is scheduled for FY04.

FY02 CBDP Funding Distribution (as a % of total funding)

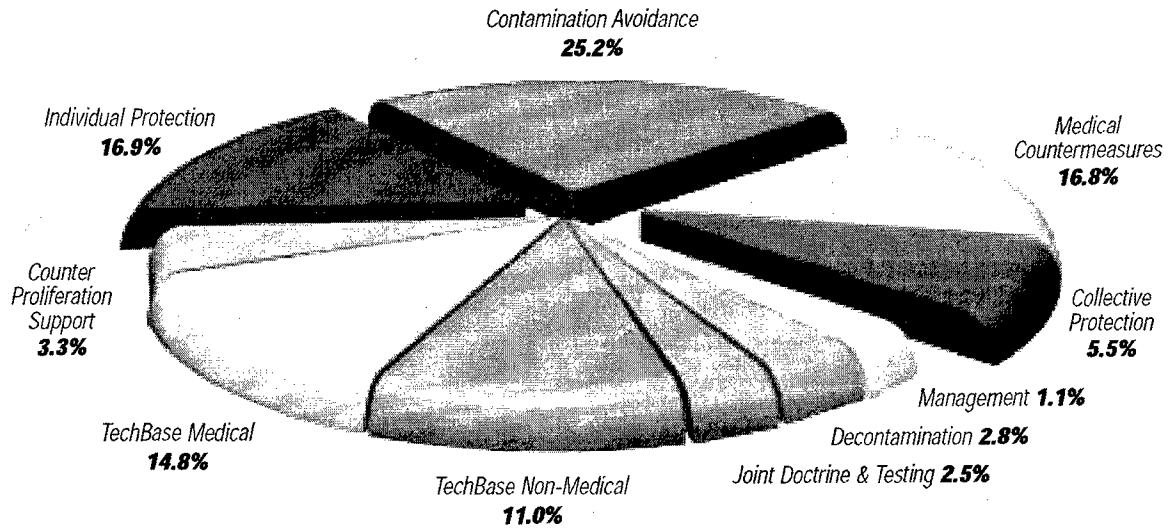

FY03 CBDP Funding Distribution (as a % of total funding)

President's Budget request not appropriated.

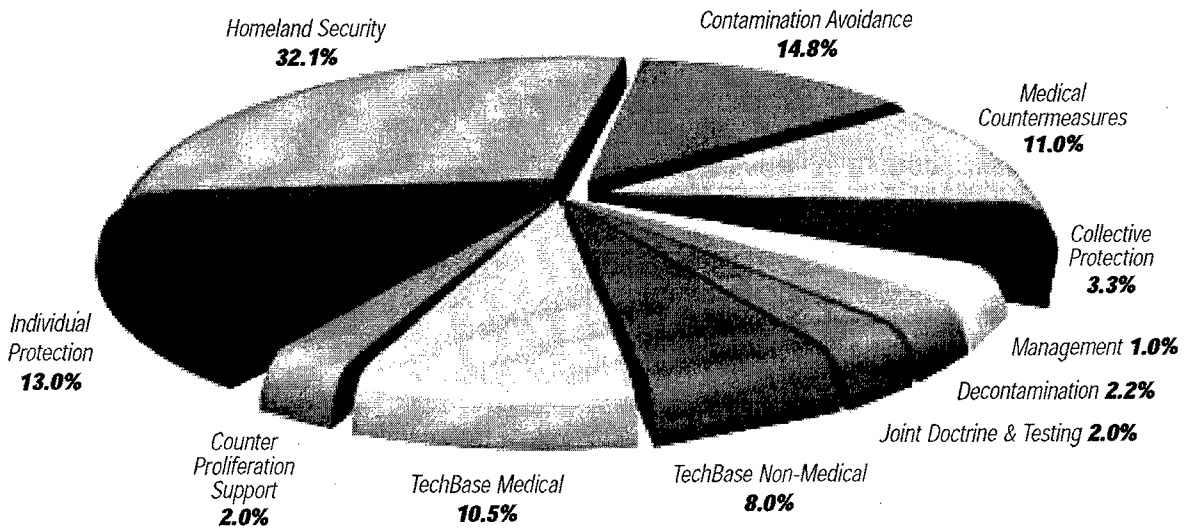

Joint Service Chemical and Biological Defense Program

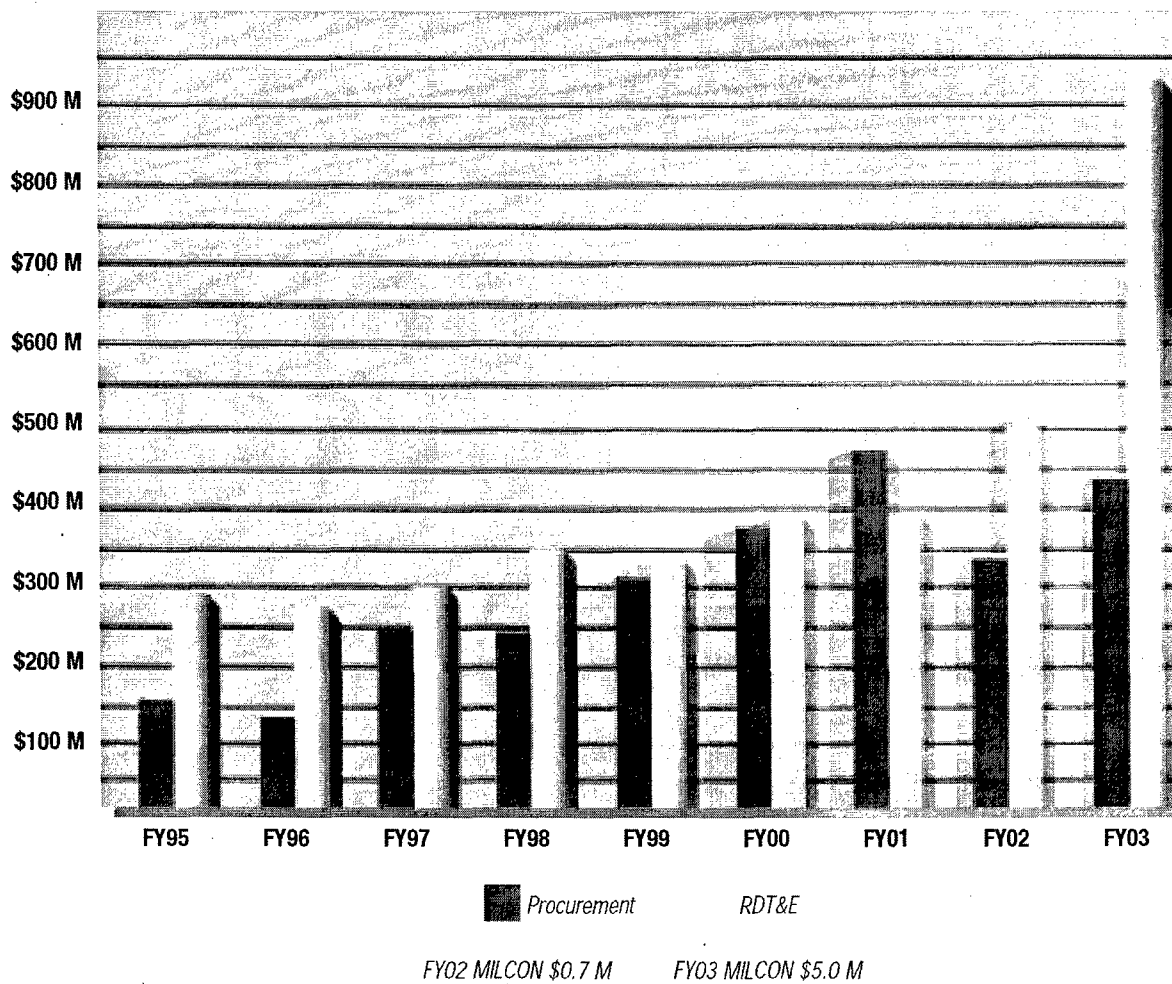

Data based on FY03 President's Budget

- AA** Abbreviate Analysis
AAN Army After Next
ACADA Automatic Chemical Agent Detector Alarm
ACAT Acquisition Category
ACPG Advanced Chemical Protective Garment
ACTD Advanced Concept Technology Demonstration
ADM Acquisition Decision Memorandum
ADVED Atmospheric Dispersion of Vapor and Evaporating Drops
AF/IL Assistant Chief of Staff (Installations and Logistics)
AF/LEO Civil Engineer (Operations)
AF/LEOR Civil Engineer (Operations, Readiness)
AFCESA Air Force Civil Engineer Support Agency (Air Staff Field Operating Agency)
AFOTEC Air Force Operational Test and Evaluation Command
AIROPs Air Operations
AIT Alteration Installation Team
ALSA Air Land Sea Application
AMC Army Materiel Command
ANBACIS Automated, Nuclear, Biological & Chemical Information System
APOD Aerial Port of Debarkation
APOE Aerial Port of Embarkation
AoA Analysis of Alternatives
AOR Area of Responsibility
APBA Acquisition Program Baseline Agreement
AS Acquisition Strategy
ASA(ALT) Assistant Secretary of the Army (Acquisition, Logistics, and Technology)
ASD(HA) Assistant Secretary of Defense (Health Affairs)
ASD(S&TR) Assistant Secretary of Defense (Strategy & Threat Reduction)
ASBREM Armed Services Biomedical Research Evaluation and Management Committee
BAA Broad Agency Announcement
BAWS Biological Agent Warning System
BDS Biological Detection System
BIDS Biological Integrated Detection System
BRP Basic Research Plan
BSDS Biological Standoff Detection System
BTN Below-the-Neck
BV Base Vehicle
BW Biological Warfare
BWC Biological Weapons Convention
C4I2 Command, Control, Communication, Computers, Information and Intelligence
C4ISR Command, Control, Communication, Computers, Intelligence, Surveillance and Reconnaissance
CAD Component Advanced Development
CAM Chemical Agent Monitor
CAM Commodity Area Manager
CAPDS Chemical Agent Point Detection System
CARDS Chemical Agent Remote Detection System
CAWG Capability Assessment Working Group
CB Chemical and Biological
CBD Chemical Biological Defense
CBDE Chemical and Biological Defense Equipment
CBDP Chemical Biological Defense Program
CBIRF Chemical/Biological Incident Response Force
CBMS Chemical, Biological Mass Spectrometer
CBPS Chemically & Biologically Protected Shelter
CBR Chemical, Biological, and Radiological
CBRD Chemical, Biological and Radiological Defense
CBRNE Chemical, Biological, Radiological, Nuclear and High-Yield Explosive
CBW Chemical and Biological Warfare
CCS Central Control Station
CDPU Central Data Processing Unit
CDR Critical Design Review
CDTF Chemical Defense Training Facility
CDU Control Display Unit
CE Concept Exploration
CENTCOM Central Command
CFD Computational Fluid Dynamics
C-HAG Chemical Hazard Assessment Guide
CHATH Chemically Hardened Air Transportable Hospital
CINC Commander in Chief
CINCPAC Commander in Chief, Pacific Command
CIS Commonwealth of Independent States
CLS Contractor Logistics Support
CNO Chief of Naval Operations
COIC Critical Operations, Issues and Criteria
CONOPs Concepts of Operations
COSAL Coordinated Shipboard Allowance List
COTS Commercial-off-the-Shelf
CP Collective Protection
CP DEPMEDS Chemically Protected Deployable Medical System
CPE Collective Protection Equipment
CPO Chemical Protection Overgarment
CPS Collective Protection System
CRADA Cooperative Research and Development Agreement
CW Chemical Warfare
CWC Chemical Weapons Convention
CWTNA Chemical Warfare Threat to Naval Aviation
DARPA Defense Advanced Research Projects Agency
DATSD(CBD) Deputy Assistant to the Secretary of Defense (Chemical Biological Defense)
DBCRA Defense Base Closure and Realignment Act
DCC Damage Control Central
DCSPRO U.S. Army Deputy Chief of Staff for Programs
DDR&E Director, Defense Research and Engineering
DDR Detailed Design Reviews
DEPSECDEF Deputy Secretary of Defense
DNA Deoxyribonucleic Acid
DoD Department of Defense
DP Decontamination Pumper
DPG Dugway Proving Ground
DPOS Disaster Preparedness Operations Specialist
DT Developmental Test
DT&E Developmental Test & Evaluation
DTAP Defense Technology Area Plan
DTRA Defense Threat Reduction Agency
DTRA, CB Defense Threat Reduction Agency, Chemical Biological Directorate
DU Detector Unit
DUBDS Deployable Unit Biological Detection System
DUSD(AT) Deputy Under Secretary of Defense for Advanced Technology
ECP Engineering Change Proposal
ECU Environmental Control Unit
EDM Engineering Development Model
EDT Engineering Design Test
EEE Eastern Equine Encephalitis
ELISA Enzyme-Linked Immunosorbent Assay
EMD Engineering & Manufacturing Development
EOD Explosive Ordnance Disposal
ECBC Edgewood Chemical and Biological Center
EUCCOM European Command
FAT First Article Test
FBI Federal Bureau of Investigation
FCA Functional Configuration Audit
FCT Foreign Competitive Test
FDA Food and Drug Administration
FDL Forward Deployable Lab
FEP Final Evaluation Period
FMP Fleet Modernization Process
FOC Full Operational Capability
FR Fire Resistant
FUE First Unit Equipped
FY Fiscal Year
GCCS Global Command and Control System
GFE Government Furnished Equipment
GOTS Government Off-the-Shelf
GPS Global Positioning System
HEPA High-Efficiency Particulate Air
HMMWV High Mobility Multipurpose Wheeled Vehicle
HPW High Pressure Washer
HTH High Test Hypochlorite
IBAD Interim Biological Agent Detector
IAV Interim Armored Vehicle
ICAM Improved Chemical Agent Monitor
ICPS Improved Collective Protection System
ICW Interactive Course Ware
IDC Independent Duty Corpsman
IJAG Ink-Jet Aerosol Generators
ILA Independent Logistic Support Plan
IMS Ion Mobility Spectrometry
IND Investigational New Drug
IOC Initial Operating Capability
IOT&E Initial Operational Test & Evaluation
IP Individual Protection
IPDS Improved (Chemical Agent) Point Detection System
IPE Individual Protection Equipment
IPR In-Progress/In-Process/Interim Program Review
IPS Integrated Program Summary
UPT Integrated Product Team
IS Interim Standardization
ISEA In-Service Engineering Agent
IT Integrated Test
JBAIDS Joint Biological Agent Identification and Diagnosis System
JBPDS Joint Biological Point Detection System
JBREWS Joint Biological Remote Early Warning System
JBUD Joint Biological Universal Detector
JCAD Joint Chemical Agent Detector
JCBUD Joint Chemical Biological Universal Detector
JCPIP Joint Collective Protection Improvement Program
JCS Joint Chiefs of Staff
JFT Joint Field Trial
JILSP Joint Integrated Logistic Support Plan
JNBCDB Joint Nuclear, Biological, Chemical Defense Board
JOEF Joint Operational Effects Federation
JORD Joint Operational Requirements Document
JPACE Joint Protective Aircrew Ensemble

- JPO-BD** Joint Program Office for Biological Defense
- JSA** Joint Service Agreement
- JSAM** Joint Service Aircrew Mask
- JSCBIS** Joint Service Chemical and Biological Information System
- JSSED** Joint Service Sensitive Equipment Decontamination
- JSFXD** Joint Service Fixed Site Decontamination
- JSGPM** Joint Service General Purpose Mask
- JSIG** Joint Service Integration Group
- JSIPP** Joint Service Installation Protection Project
- JSLIST** Joint Service Lightweight Integrated Suit Technology
- JSLNBCRS** Joint Service Lightweight Nuclear, Biological, Chemical Reconnaissance System
- JSLSCAD** Joint Service Lightweight Standoff Chemical Agent Detector
- JSMG** Joint Service Materiel Group
- JSTPCBD** Joint Service Technology Panel on Chemical and Biological Defense
- JTCG** Joint Technology Coordination Group
- JTCOPS** Joint Transportable Collective Protection Shelter
- JVAP** Joint Vaccine Acquisition Program
- JWARN** Joint Warning and Reporting Network
- JWCA** Joint Warfighting Capability Assessment
- JWSTP** Joint Warfighting S&T Plan
- LAV** Lightweight Armored Vehicle
- LCGE** Life Cycle Cost Estimate
- LIDAR** Light Detecting and Ranging
- LMS** Light Multipurpose Shelter
- LP** Limited Protection
- LR/SR** Long Range/Short Range
- LRIP** Low Rate Initial Production
- LSP** Logistics Support Plan
- LUT** Limited User Test
- LUTE** Limited User Test & Evaluation
- MAA** Mission Area Analysis
- MA** Multichambered Autoinjector
- MALS** Mobile Analytical Lab System
- MARS** Multi-warfare Assessment and Research System
- MBRR** Molecular Biologies Research Resource
- MCBC** Medical Management of Chemical/Biological Casualties
- MDS** Modular Decontamination System
- MEF** Marine Expeditionary Force
- MICAD** Multipurpose Integrated Chemical Agent Detector
- MicroPCM** Microencapsulated Phase Change Material
- MNS** Mission Needs Statement
- MOPP** Mission Oriented Protective Posture
- MOU** Memorandum of Understanding
- MPF** Maritime Prepositioning Force
- MRB** Milestone Review Board
- M&S** Modeling and Simulation
- MS** Milestone
- MSC** Medical Service Corps
- MTW** Major Theater War
- MULO** Multipurpose Overboot
- NATO** North American Treaty Organization
- NAVAIR** Systems Command
- NAVSEA** Naval Sea Systems Command
- NBC** Nuclear, Biological and Chemical
- NBCRS** Nuclear, Biological, Chemical Reconnaissance System
- NCB** Nuclear, Chemical and Biological
- NDA** New Drug Application
- NDI** Non-Development Item
- NMRI** Naval Medical Research Institute
- OA** Operational Assessment
- OCONUS** Outside Continental United States
- OIPT** Overarching Integrated Product Team
- ONR** Office of Naval Research
- OPCERT** Operational Certification
- OPEVAL** Operational Evaluation
- ORD** Operational Requirements Document
- OSD** Office of the Secretary of Defense
- OT** Operational Testing
- OT&E** Operational Test and Evaluation
- P3I** Pre-Planned Product Improvement
- PAC** Post Award conference
- PACOM** Pacific Command
- PADD** Passive Anti-Drown Device
- PATS** Protective Assessment Test System
- PC** Personal Computer
- PCR** Polymerase Chain Reaction
- PDA** Polydiacetylene
- PDR** Preliminary Design Review
- PDRR** Program Definition and Risk Reduction
- PE** Program Element
- PIP** Product Improvement Proposal/Program
- PLA/ELA** Product License Application/Establishment License Application
- POM** Program Objective Memorandum
- PPBE** Programming, Planning, Budgeting and Execution
- PPQT** Pre-Production Qualification Testing
- PPU** Patient Processing Unit
- PQT** Preliminary/Production Qualification Test
- PVT** Product Verification Test
- QDR** Quadrennial Defense Review
- RSCAAL** Remote Sensing Chemical Agent Alarm
- RDA** Research, Development, and Acquisition
- R&D** Research and Development
- R-DNA** Recombinant Deoxyribonucleic Acid
- RDTE** Research, Development, Testing and Evaluation
- RDU** Remote Display Unit
- RestOps** Restoration of Operations at Fixed Sites
- RF/SAT** Radio Frequency/Satellite
- RFPP** Request for Proposal
- ROC** Required Operational Capability
- RRT** Risk Reduction Test
- S&T** Science and Technology
- SACPS** Selected Are collective Protection System
- SAF/AQP** Assistant Secretary of the Air Force (Acquisition, Directorate of Global Power Programs)
- SAW** Surface Acoustic Wave
- SBA** Simulation Based Acquisition
- SBIR** Small Business Innovation Research
- SCAMP** Shipboard Chemical Agent Monitor Portable
- SDD** System Development and Demonstration
- SDPR** Software Development Program Review
- SDR** System Design Review
- SEB** Staphylococcal Enterotoxin B
- SECDEF** Secretary of Defense
- SHIPALT** Ship Alteration
- SID** Shipboard Installation Drawing
- SOCOM** Special Operations Command
- SOF** Special Operations Forces
- SOO** Statement of Objectives
- SOP** Standard Operating Procedures
- SOUTHCOM** Southern Command
- SPFC** Single Particle Fluorescence Cell
- SPOD** Sea Port of Debarkation
- SPOE** Sea Port of Embarkation
- SR-BSDS** Short Range Biological Standoff Detection System
- SRR** System Requirement Review
- SSEB** Source Selection Evaluation Board
- STA** System Threat Analysis
- STAR** System Threat Analysis Report
- SSN** Standard Study Number
- TAACOM** Tank-automotive & Armaments Command
- TACAIR** Tactical Aircraft
- TACWAR** Tactical Warfare
- TBD** To Be Determined
- TC** Type Classification
- TDP** Technical Data Package
- TECHEVAL** Technical Evaluation
- TEMP** Test and Evaluation Master Plan
- TICs** Toxic Industrial Chemicals
- TIMs** Toxic Industrial Materials
- TM** Technical Manual
- TOC** Tactical Operations Center
- TOR** Tentative Operational Requirement
- TPDD** Time-phased Deployment Data
- TQG** Tactical Quiet Generator
- TRADOC** Training and Doctrine Command
- TRR** Test Readiness Review
- TSP** Topical Skin Protectant
- TTCP** The Technical Cooperation Program
- TTP** Tactics, Techniques, & Procedures
- UAV** Unmanned Aerial Vehicle
- UCS** Unified Command Suite
- UJTL** Universal Joint Task Listing
- ULSS** User's Logistic Support Summary
- USA** United States Army
- USACMLS** U.S. Army Chemical School
- USAF** United States Air Force
- USAMRMC** U.S. Army Medical Research and Material Command
- USD(A&T)** Under Secretary of Defense for Acquisition and Technology
- USMC** United States Marine Corps
- USN** United States Navy
- USSOCOM** U.S. Special Operations Command
- VEE** Venezuelan Equine Encephalitis
- VIG** Vaccine Immune Globulin
- VLSTRACK** Vapor, Liquid, and Solid Tracking
- WEE** Western Equine Encephalitis
- WIPT** Working Integrated Product Team
- WMD** Weapons of Mass Destruction
- WMD-CST** Weapons of Mass Destruction-Civil Support Teams
- WWW** World Wide Web

Deputy Assistant to the Secretary of Defense for Chemical and Biological Defense (DATSD(CBD))

<http://www.acq.osd.mil/cp/welcome.html>

Home page of the DATSD(CBD). This site includes summary of activities of the Counterproliferation Support Program, the DoD Chemical and Biological Defense Program, and downloadable versions of reports.

Defense Threat Reduction Agency (DTRA)

<http://www.dtra.mil>

DTRA consolidates a variety of disparate, yet related, Defense Department functions to deal more effectively with threats posed by WMD.

U.S. Army Soldier and Biological Chemical Command (SBCCOM)

<http://www.sbccom.apgea.army.mil>

Home page of the U.S. Army Soldier and Biological Chemical Command.

Joint Service Materiel Group (JSMG)

<http://www.jsmg.apgea.army.mil>

The JSMG coordinates and integrates planning and programming of the nation's NBC Defense research, development, acquisition (RDA) and logistics programs pursuant to Defense Planning Guidance and the intent of the U.S. Congress.

Joint Service Integration Group (JSIG)

<http://www.wood.army.mil/jsig>

The home page for the JSIG. Provides detailed information about the JSIG, its mission and the NBC requirements process. It provides a link to the JSIG portal which contains a comprehensive list of Operational Requirement Documents (ORDs) and CB program references.

U.S. Army Chemical School (USACMLS)

<http://www.wood.army.mil/usacmls>

The USACMLS, located at Fort Leonard Wood, Missouri, is one of the most advanced and sophisticated military training centers in the world. It is also the Joint NBC Defense Training Center because the Army, Navy, Air Force, and Marines all conduct their NBC training at the USACMLS.

Joint Service Chemical Biological Information System (JSCBIS)

<http://jscbis.rdaisa.army.mil>

Provides financial and programmatic information for DoD's Chemical and Biological Defense Program. Requires user identification and password, which can be applied for through home page.

Navy Chemical and Biological Defense

<http://www.chembiodef.navy.mil>

Chief of Naval Operations NS6DC and the Commandant of the Marine Corps discuss the strategic direction for Naval Operations into the 21st century.

DefenseLink

<http://www.defenselink.mil>

The official home page of the Department of Defense. Includes numerous reports and links to DoD organizations.

Chemical and Biological Defense Information Analysis Center (CBIAC)

<http://www.cbiac.apgea.army.mil>

CBIAC serves as the DoD focal point for Chemical Warfare and Chemical Biological Defense (CW/CBD) technology. The CBIAC serves to collect, review, analyze, synthesize, appraise and summarize information pertaining to CW/CBD. It provides a searchable database for authorized users and links to many other CW/CBD sites.

Joint Program Office – Biological Defense (JPO-BD)

<http://www.jpobd.net>

The JPO-BD has management oversight responsibility for all DoD Biological Defense (BD) acquisition programs, including enhanced detection systems and BD medical products.

Anthrax Vaccine Immunization Program

<http://www.anthrax.osd.mil>

Home page for the DoD's anthrax immunization program. The page has links to the history and facts about the program.

The Army Medical Department Center and School

<http://www.armymedicine.army.mil/armymed>

Provides extensive information about the Army's Medical Department. Includes information on doctrine development and the use of medical NBC defense products.

Program Manager for Chemical Demilitarization

<http://www-pmcd.apgea.army.mil>

Provides information on the Chemical Stockpile Disposal Program, the Non-Stockpile Chemical Material Program, the Alternative Technologies Program, the Chemical Stockpile Emergency Preparedness Program, and the Cooperative Threat Reduction Office.

Technical Support Working Group (TSWG)

<http://www.tswg.gov>

Home page for the Technical Support Working Group.

United States Army Medical Research Institute of Chemical Defense (USAMRICD)

<http://chemdef.apgea.army.mil>

Home page for USAMRICD—the nation's lead laboratory for research to advance the medical prevention and treatment of chemical warfare casualties.

U.S. Army Medical Research and Materiel Command (USAMRMC)

<http://mmmc-www.army.mil>

Provides information on Medical Chemical Defense Overview, Nerve Agents, Cyanide, Skin Decontamination and Protection, Performance Effects of Protectant Drugs, and Chemical Casualty Management. Linked to U.S. Army Medical Research Institute of Infectious Diseases, location of much of the science and technology research efforts for medical biological defense.

United States Army Medical Research Institute of Infectious Diseases (USAMRIID)

<http://www.usamriid.army.mil>

Home page of the U.S. Army Medical Research Institute of Infectious Diseases, location of much of the science and technology research efforts for medical biological defense.

SBCCOM RDA Enterprise Edgewood Site

<http://www.sbccom.apgea.army.mil/RDA/index.html>

The Army's principal R&D center for chemical and biological defense technology, engineering and services.

Defense Advanced Research Projects Agency (DARPA)

<http://www.darpa.mil>

The home page of DARPA describes basic and applied research and development of projects being performed for DoD. Link to the Defense Sciences Office (DSO) provides a link to the Biological Warfare Defense (BWD) Program (<http://www.bwd.org>).

BLANK PAGE

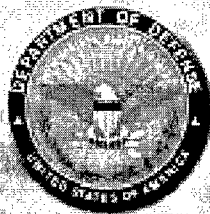

Requests for this document should be directed to:

Office of the Deputy Assistant to the Secretary of Defense
(Chemical Biological Defense)
3050 Defense Pentagon, Room 3C257
Washington, DC 20301-3050

