

---

**AZIMUTHALLY PROPAGATING MODES IN AN  
AXIALLY-TRUNCATED, CIRCULAR, COAXIAL  
WAVEGUIDE**

**Clifton C. Courtney**

**Voss Scientific  
418 Washington St SE  
Albuquerque, NM 87108**

**September 2003**

**Interim Report**

**APPROVED FOR PUBLIC RELEASE; DISTRIBUTION IS UNLIMITED.**



**AIR FORCE RESEARCH LABORATORY  
Directed Energy Directorate  
3550 Aberdeen Ave SE  
AIR FORCE MATERIEL COMMAND  
KIRTLAND AIR FORCE BASE, NM 87117-5776**

---

STINFO COPY

Using Government drawings, specifications, or other data included in this document for any purpose other than Government procurement does not in any way obligate the U.S. Government. The fact that the Government formulated or supplied the drawings, specifications, or other data, does not license the holder or any other person or corporation; or convey any rights or permission to manufacture, use, or sell any patented invention that may relate to them.

This report has been reviewed by the Public Affairs Office and is releasable to the National Technical Information Service (NTIS). At NTIS, it will be available to the general public, including foreign nationals.

If you change your address, wish to be removed from this mailing list, or your organization no longer employs the addressee, please notify AFRL/DEHE, 3550 Aberdeen Ave SE, Kirtland AFB, NM 87117-5776.

Do not return copies of this report unless contractual obligations or notice on a specific document requires its return.

This report has been approved for publication.

//signed//  
ANDREW D. GREENWOOD  
Project Manager

//signed//  
REBECCA N. SEEGER, Col, USAF  
Chief, High Power Microwave Division

//signed//  
L. BRUCE SIMPSON, SES  
Director, Directed Energy Directorate

<b>REPORT DOCUMENTATION PAGE</b>			<i>Form Approved</i> <i>OMB No. 0704-0188</i>		
Public reporting burden for this collection of information is estimated to average 1 hour per response, including the time for reviewing instructions, searching existing data sources, gathering and maintaining the data needed, and completing and reviewing this collection of information. Send comments regarding this burden estimate or any other aspect of this collection of information, including suggestions for reducing this burden to Department of Defense, Washington Headquarters Services, Directorate for Information Operations and Reports (0704-0188), 1215 Jefferson Davis Highway, Suite 1204, Arlington, VA 22202-4302. Respondents should be aware that notwithstanding any other provision of law, no person shall be subject to any penalty for failing to comply with a collection of information if it does not display a currently valid OMB control number. <b>PLEASE DO NOT RETURN YOUR FORM TO THE ABOVE ADDRESS.</b>					
<b>1. REPORT DATE (DD-MM-YYYY)</b> 18-09-2003		<b>2. REPORT TYPE</b> Interim		<b>3. DATES COVERED (From - To)</b> 01-08-2003 to 31-08-2003	
<b>4. TITLE AND SUBTITLE</b> Azimuthally Propagating Modes in an Axially-Truncated, Circular, Coaxial Waveguide			<b>5a. CONTRACT NUMBER</b> F29601-03-M-0101		
			<b>5b. GRANT NUMBER</b>		
<b>6. AUTHOR(S)</b> Clifton C. Courtney			<b>5c. PROGRAM ELEMENT NUMBER</b> 65502F		
			<b>5d. PROJECT NUMBER</b> 3005		
			<b>5e. TASK NUMBER</b> DP		
<b>7. PERFORMING ORGANIZATION NAME(S) AND ADDRESS(ES)</b> Voss Scientific 418 Washington St SE Albuquerque, NM 87108			<b>5f. WORK UNIT NUMBER</b> CE		
			<b>8. PERFORMING ORGANIZATION REPORT NUMBER</b>		
<b>9. SPONSORING / MONITORING AGENCY NAME(S) AND ADDRESS(ES)</b> AFRL/DEHE 3550 Aberdeen Ave SE Kirtland AFB, NM 87117-5776			<b>10. SPONSOR/MONITOR'S ACRONYM(S)</b>		
			<b>11. SPONSOR/MONITOR'S REPORT NUMBER(S)</b> AFRL-DE-TR-2003-1135		
<b>12. DISTRIBUTION / AVAILABILITY STATEMENT</b> Approved for public release; distribution is unlimited.					
<b>13. SUPPLEMENTARY NOTES</b>					
<b>14. ABSTRACT</b> In this note we derive and examine the modal properties of the Azimuthally Propagating, Truncated, Cylindrical, Coaxial Waveguide. This guide is defined by an inner and outer radii, and a width. We derive the governing equations for the electromagnetic fields of the TE <sub>z</sub> and TM <sub>z</sub> azimuthally propagating modes. First, the characteristic equations that define the propagation constants of each mode are derived; then, the electric and magnetic fields are explicitly expressed. With these results the mode impedances are formulated, and the impedance of the propagating mode in the transition section can be calculated. This value of the transition section's impedance can then be used to impedance match the transition section to the transmission line. Finally, as an example, a transmission line transition geometry is defined for which the electric and magnetic fields of the lowest order TE and TM modes are computed and graphed. An Appendix to this note briefly discusses the selection of the form of the vector potentials used to formulate the TE and TM modes.					
<b>15. SUBJECT TERMS</b> Electromagnetics; waveguide modes					
<b>16. SECURITY CLASSIFICATION OF:</b>			<b>17. LIMITATION OF ABSTRACT</b>	<b>18. NUMBER OF PAGES</b>	<b>19a. NAME OF RESPONSIBLE PERSON</b>
<b>a. REPORT</b> Unclassified	<b>b. ABSTRACT</b> Unclassified	<b>c. THIS PAGE</b> Unclassified			Andrew Greenwood
			Unlimited	26	<b>19b. TELEPHONE NUMBER (include area code)</b> 505-846-6642



## Contents

<a href="#">1. Introduction</a> .....	1
<a href="#">2. Geometry</a> .....	1
<a href="#">3. Wave Equation</a> .....	1
<a href="#">4. Boundary Conditions</a> .....	4
<a href="#">5. Solution of the Separated Wave Equation</a> .....	4
<a href="#">6. <math>TE_z</math> and <math>TM_z</math> Field Components</a> .....	5
<a href="#">6.1 <math>TM_z</math> Field Components</a> .....	5
<a href="#">6.2 <math>TE_z</math> Field Components</a> .....	5
<a href="#">7. Solution of the Separated Wave Equation Subject to the Boundary Conditions of the Generalized Geometry</a> .....	6
<a href="#">7.1 <math>TM_z</math> Field Components</a> .....	7
<a href="#">7.2 <math>TE_z</math> Field Components</a> .....	9
<a href="#">8. Waveguide Impedance</a> .....	12
<a href="#">9. Example</a> .....	12
<a href="#">10. Conclusion</a> .....	17
<a href="#">APPENDIX A- About the Wave Equation in Cylindrical Coordinates</a> .....	19

## List of Figures

<a href="#">Figure 1.</a>	<a href="#">The geometry of the double baffled cylindrical coaxial waveguide.</a>	2
<a href="#">Figure 2.</a>	<a href="#">The geometry of the azimuthally propagating, truncated, cylindrical coaxial waveguide.</a>	3
<a href="#">Figure 3.</a>	<a href="#">The values of <math>q</math> for the <math>TEz_{11}</math> mode as a function of frequency for an <i>Azimuthally Propagating, Truncated, Cylindrical, Coaxial Waveguide</i>.</a>	13
<a href="#">Figure 4.</a>	<a href="#">The characteristic equation of the <math>TEz_{11}</math> mode for an <i>Azimuthally Propagating, Truncated, Cylindrical, Coaxial Waveguide</i>.</a>	14
<a href="#">Figure 5.</a>	<a href="#">The electromagnetic field distribution of the various field components in an <i>Azimuthally Propagating, Truncated, Cylindrical, Coaxial Waveguide</i>.</a>	15
<a href="#">Figure 6.</a>	<a href="#">The value of the <math>E_r</math> component of the electric field of the <math>TEz_{11}</math> mode as a function of azimuthal position.</a>	16
<a href="#">Figure 7.</a>	<a href="#">The electric field distribution of the various field components in an <i>Azimuthally Propagating, Truncated, Cylindrical, Coaxial Waveguide</i>.</a>	16
<a href="#">Figure 8.</a>	<a href="#">The electromagnetic field distribution of the various field components for the <math>TMz_{11}</math> mode.</a>	17

## 1. Introduction

The double-baffled, coaxial waveguide transmission line, shown in Figure 1, is defined by inner and outer radii, and an arc length. In conventional applications, the propagating modes are assumed in the  $z$ -direction. The TE $_z$  and TM $_z$  modes of this geometry, propagation constants, and guide wavelengths were studied in detail in [Ref. 1]. In this memo, the waveguide is truncated in the  $z$ -direction, and propagation is assumed in the azimuthal direction. Shown in Figure 2, the *Azimuthally Propagating, Truncated, Cylindrical, Coaxial Waveguide* is defined by inner and outer radii, and a depth  $a$  in the  $z$ -dimension. We are interested in solving for the azimuthally, or  $\phi$ -directed, propagating modes. First, the characteristic equations that define the cut off frequencies of each mode are derived, then the electric fields are explicitly expressed. Finally, an example geometry is defined for which the lowest TE and TM mode cutoff frequencies are computed and graphs of the normalized field components are presented.

## 2. Geometry

The geometry of the azimuthally propagating, truncated, coaxial waveguide transmission line is shown in Figure 2. The transmission line is defined by inner ( $r_1$ ) and outer radii ( $r_2$ ), and a depth  $a$  in the  $z$ -dimension. Propagation is assumed in the azimuthal direction.

## 3. Wave Equation

The natural coordinate system for the *Azimuthally Propagating, Truncated, Cylindrical, Coaxial Waveguide* is the cylindrical coordinate system. The scalar wave equation in cylindrical coordinates is

$$\frac{1}{r} \frac{\partial}{\partial r} \left( r \frac{\partial \mathbf{y}(\mathbf{r}, \mathbf{j}, z)}{\partial r} \right) + \frac{1}{r^2} \frac{\partial^2 \mathbf{y}(\mathbf{r}, \mathbf{j}, z)}{\partial \mathbf{j}^2} + \frac{\partial^2 \mathbf{y}(\mathbf{r}, \mathbf{j}, z)}{\partial z^2} + k^2 \mathbf{y}(\mathbf{r}, \mathbf{j}, z) = 0 \quad (1)$$

Using the standard separation of variables technique the wave equation can be written as

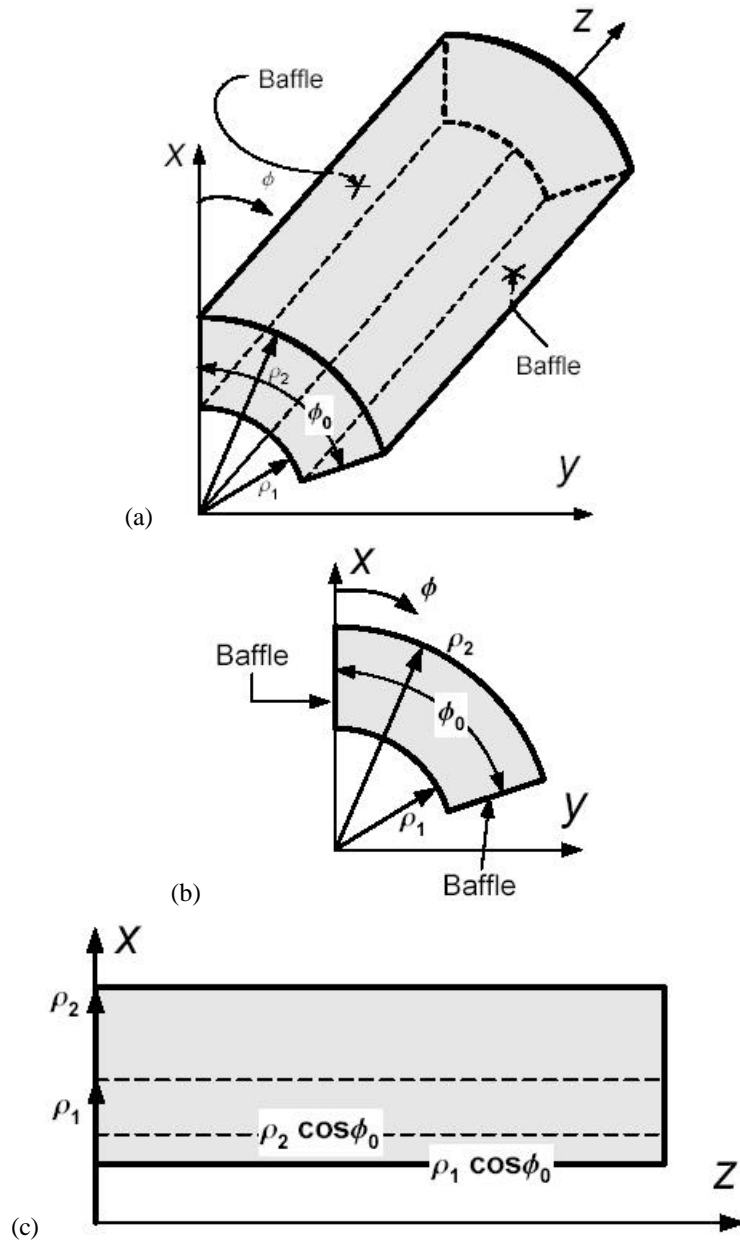

**Figure 1.** The geometry of the double baffled cylindrical coaxial waveguide: (a) 3-D perspective drawing; (b) plane view of the xy-plane; and (c) plane view of the xz-plane.

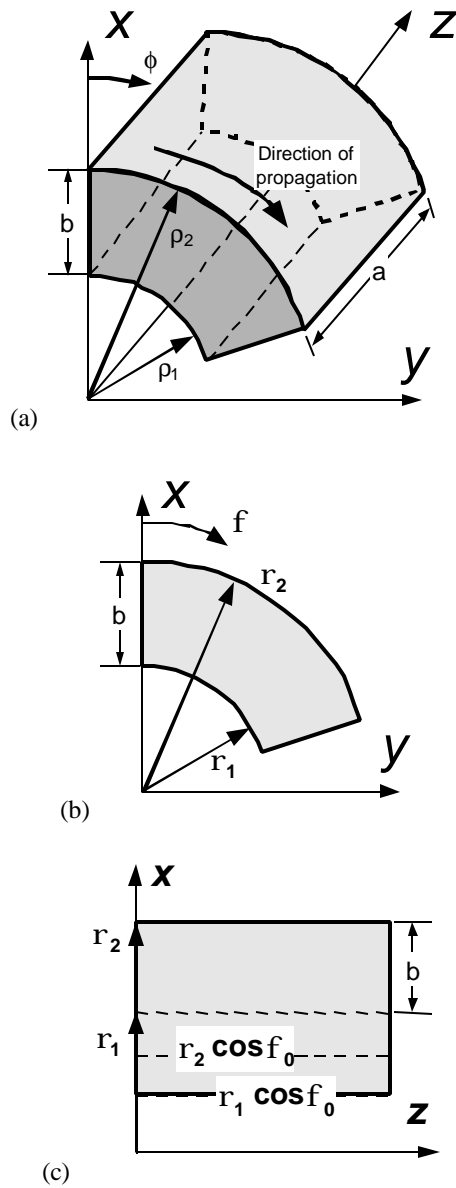

**Figure 2.** The geometry of the azimuthally propagating, truncated, cylindrical coaxial waveguide: (a) 3-D perspective drawing; (b) plane view of the  $xy$ -plane; and (c) plane view of the  $xz$ -plane.

$$\mathbf{r} \frac{d}{d\mathbf{r}} \left( \mathbf{r} \frac{dR(\mathbf{r})}{d\mathbf{r}} \right) + \left[ (k_r \mathbf{r})^2 - q^2 \right] R(\mathbf{r}) = 0 \quad (2a)$$

$$\frac{d^2}{d\mathbf{j}^2} \Phi(\mathbf{j}) + q^2 \Phi(\mathbf{j}) = 0 \quad (2b)$$

$$\frac{d^2}{dz^2} Z(z) + n^2 Z(z) = 0 \quad (2c)$$

where:  $\mathbf{y}(\mathbf{r}, \mathbf{j}, z) = R(\mathbf{r}) \Phi(\mathbf{j}) Z(z)$ , the  $q$  are dimensionless propagation constants, and  $k_r^2 + n^2 = k^2$ .

#### 4. Boundary Conditions

The boundary conditions on the electric field for the geometry are:

$$E_r = 0 \text{ for } z = 0, \text{ and } z = a \quad (3a)$$

$$E_j = 0 \text{ for } \mathbf{r} = \mathbf{r}_1, \mathbf{r} = \mathbf{r}_2, z = 0, \text{ and } z = a \quad (3b)$$

$$E_z = 0 \text{ for } \mathbf{r} = \mathbf{r}_1 \text{ and } \mathbf{r} = \mathbf{r}_2. \quad (3c)$$

#### 5. Solution of the Separated Wave Equation

The  $\Phi(\mathbf{j})$  and  $Z(z)$  equations are harmonic equations with harmonic functions as solutions; these will be denoted  $h(q\mathbf{j})$  and  $h(nz)$ .

The equation in  $R(\mathbf{r})$  is a Bessel equation, and has Bessel function solutions:

$J_q(k_r \mathbf{r}) =$  the Bessel function of the first kind of order  $q$

$N_q(k_r \mathbf{r}) =$  the Bessel function of the second kind of order  $q$

$H_q^{(1)}(k_r \mathbf{r}) =$  the Hankel function of the first kind of order  $q$

$H_q^{(2)}(k_r \mathbf{r}) =$  the Hankel function of the second kind of order  $q$

Let the function  $B_q(k_r \mathbf{r})$  represent the linearly independent combination of two of the above.

Then, the general solution to the scalar Helmholtz wave equation is:

$$\mathbf{y} = B_q(k_r \mathbf{r}) h(q\mathbf{j}) h(nz) \quad (4)$$

## 6. TE<sub>z</sub> and TM<sub>z</sub> Field Components

The electric and magnetic field components can be written in terms of fields that are TE<sub>z</sub> and TM<sub>z</sub>. See Appendix I.

### 6.1 TM<sub>z</sub> Field Components

The TM<sub>z</sub> field components are found by letting  $\mathbf{A} = \mathbf{u}_z \mathbf{y}$ , where  $\mathbf{A}$  = the magnetic vector potential, and  $\mathbf{u}_z$  = unit vector in the z-direction. Then

$$\mathbf{E} = -j\omega\mathbf{A} + \frac{1}{j\omega\epsilon} \nabla(\nabla \cdot \mathbf{A}), \quad (5a)$$

$$\text{and } \mathbf{H} = \frac{1}{m} \nabla \times \mathbf{A}. \quad (5b)$$

Since

$$\nabla(\nabla \cdot \mathbf{A}) = \nabla(\nabla \cdot \mathbf{u}_z \mathbf{y}) = \mathbf{u}_r \frac{\partial}{\partial r} \left[ \frac{\partial \mathbf{y}}{\partial z} \right] + \mathbf{u}_j \frac{1}{r} \frac{\partial}{\partial j} \left[ \frac{\partial \mathbf{y}}{\partial z} \right] + \mathbf{u}_z \frac{\partial}{\partial z} \left[ \frac{\partial \mathbf{y}}{\partial z} \right],$$

and

$$\nabla \times \mathbf{A} = \nabla \times \mathbf{u}_z \mathbf{y} = \mathbf{u}_r \frac{1}{r} \frac{\partial \mathbf{y}}{\partial j} - \mathbf{u}_j \frac{\partial \mathbf{y}}{\partial r},$$

then expanded in cylindrical coordinates the components of the above equations become:

$$E_r = \frac{1}{j\omega\epsilon} \frac{\partial^2 \mathbf{y}}{\partial z \partial r} \quad (6a) \qquad H_r = \frac{1}{m} \frac{1}{r} \frac{\partial \mathbf{y}}{\partial j} \quad (6d)$$

$$E_j = \frac{1}{j\omega\epsilon} \frac{1}{r^2} \frac{\partial^2 \mathbf{y}}{\partial j^2} \quad (6b) \qquad H_j = -\frac{1}{m} \frac{\partial \mathbf{y}}{\partial r} \quad (6e)$$

$$E_z = -j\omega \mathbf{y} + \frac{1}{j\omega\epsilon} \frac{\partial^2 \mathbf{y}}{\partial z^2} \quad (6c) \qquad H_z = 0 \quad (6f)$$

### 6.2 TE<sub>z</sub> Field Components

The TE<sub>z</sub> field components are found by letting  $\mathbf{F} = \mathbf{u}_z \mathbf{y}$ , where  $\mathbf{F}$  = the electric vector potential, and  $\mathbf{u}_z$  = unit vector in the z-direction. Then

$$\mathbf{E} = -\frac{1}{\mathbf{e}} \nabla \times \mathbf{F}, \quad (7a)$$

$$\text{and } \mathbf{H} = -j\omega\mathbf{F} + \frac{1}{j\omega\mathbf{m}\mathbf{e}} \nabla(\nabla \cdot \mathbf{F}). \quad (7b)$$

Since

$$\nabla(\nabla \cdot \mathbf{F}) = \nabla(\nabla \cdot \mathbf{u}_z \mathbf{y}) = \mathbf{u}_r \frac{\partial}{\partial r} \left[ \frac{\partial \mathbf{y}}{\partial z} \right] + \mathbf{u}_j \frac{1}{r} \frac{\partial}{\partial j} \left[ \frac{\partial \mathbf{y}}{\partial z} \right] + \mathbf{u}_z \frac{\partial}{\partial z} \left[ \frac{\partial \mathbf{y}}{\partial z} \right],$$

and

$$\nabla \times \mathbf{F} = \nabla \times \mathbf{u}_z \mathbf{y} = \mathbf{u}_r \frac{1}{r} \frac{\partial \mathbf{y}}{\partial j} - \mathbf{u}_j \frac{\partial \mathbf{y}}{\partial r},$$

when the above equations are expanded in cylindrical coordinates, the components become:

$$E_r = -\frac{1}{\mathbf{e}} \frac{1}{r} \frac{\partial \mathbf{y}}{\partial j} \quad (8a)$$

$$H_r = -j \frac{1}{\omega\mathbf{m}\mathbf{e}} \frac{\partial^2 \mathbf{y}}{\partial z \partial r} \quad (8d)$$

$$E_j = \frac{1}{\mathbf{e}} \frac{\partial \mathbf{y}}{\partial r} \quad (8b)$$

$$H_j = -j \frac{1}{\omega\mathbf{m}\mathbf{e}} \frac{1}{r} \frac{\partial^2 \mathbf{y}}{\partial j \partial z} \quad (8e)$$

$$E_z = 0 \quad (8c)$$

$$H_z = -j\omega\mathbf{y} - j \frac{1}{\omega\mathbf{m}\mathbf{e}} \frac{\partial^2 \mathbf{y}}{\partial z^2} \quad (8f)$$

## 7. Solution of the Separated Wave Equation Subject to the Boundary Conditions of the Generalized Geometry

Propagating waves in the  $\phi$ -direction in the truncated coaxial waveguide give rise to harmonic functions

$$h(qj) = e^{-jqj} \quad (9)$$

and, for  $h(nz)$

$$h(nz) = a_n \sin(nz) + b_n \cos(nz) \quad (10)$$

The scalar wave function is then

$$\mathbf{y} = B_q(k_r \mathbf{r}) e^{-jqj} h(nz) \quad (11)$$

subject to the boundary conditions. The solutions for the  $\text{TE}_z$  and  $\text{TM}_z$  modes in the guide are as follows.

## 7.1 $TM_z$ Field Components

The  $TM_z$  electric and magnetic field components in terms of the general wave function are

$$E_r = \frac{1}{j\omega\epsilon} \frac{\partial^2}{\partial z \partial \mathbf{r}} \{B_q(k_r, \mathbf{r}) e^{-jqz} h(nz)\} = \frac{nk_r}{j\omega\epsilon} B_q'(k_r, \mathbf{r}) e^{-jqz} h'(nz) \quad (12a)$$

$$E_j = \frac{1}{j\omega\epsilon} \frac{1}{r^2} \frac{\partial^2}{\partial j^2} \{B_q(k_r, \mathbf{r}) e^{-jqz} h(nz)\} = \frac{(-jq)^2}{j\omega\epsilon} \frac{1}{r^2} B_q(k_r, \mathbf{r}) e^{-jqz} h(nz) \quad (12b)$$

$$E_z = \left\{ -j\omega + \frac{1}{j\omega\epsilon} \frac{\partial^2}{\partial z^2} \right\} B_q(k_r, \mathbf{r}) e^{-jqz} h(nz) = -j\omega \left( 1 + \frac{n^2}{k_0^2} \right) B_q(k_r, \mathbf{r}) e^{-jqz} h''(nz) \quad (12c)$$

$$H_r = -jq \frac{1}{m} B_q(k_r, \mathbf{r}) e^{-jqz} h(nz) \quad (12d)$$

$$H_j = -\frac{1}{m} \frac{\partial y}{\partial \mathbf{r}} = -\frac{k_r}{m} B_q'(k_r, \mathbf{r}) e^{-jqz} h(nz) \quad (12e)$$

$$H_z = 0 \quad (12f)$$

Note that  $B_q'(k_r, \mathbf{r}) = \frac{d}{d(k_r, \mathbf{r})} B_q(k_r, \mathbf{r})$ . Since

$$E_j = 0 \text{ for } \mathbf{r} = \mathbf{r}_1, \mathbf{r} = \mathbf{r}_2, z=0, \text{ and } z=a$$

then

$$h(nz)|_{z=0,a} = (a_n \sin(nz) + b_n \cos(nz))|_{z=0,a} = 0$$

is satisfied if:

$$a_n = 1, b_n = 0, n = \frac{m\mathbf{p}}{a}, \text{ and } m = 0, 1, 2, K. \quad (13)$$

Note, then, that the cutoff frequencies are defined in the same way as the cutoff frequencies of standard rectangular guide, i.e., the cutoff frequencies of the TM modes of the azimuthally propagating, truncated, cylindrical, coaxial waveguide.

The boundary conditions are also satisfied if

$$B_q(k_r, \mathbf{r})|_{r=r_1, r_2} = 0$$

Let

$$B_q(k_r, \mathbf{r}) = a_q J_q(k_r, \mathbf{r}) + b_q N_q(k_r, \mathbf{r}), \text{ then } a_q J_q(k_r, \mathbf{r}) + b_q N_q(k_r, \mathbf{r})|_{r=r_1, r_2} = 0.$$

And,

$$a_q J_q(k_r \mathbf{r}_1) + b_q N_q(k_r \mathbf{r}_1) = 0$$

$$a_q J_q(k_r \mathbf{r}_2) + b_q N_q(k_r \mathbf{r}_2) = 0$$

Solving the first equation for

$$a_q : \quad a_q = b_q \frac{N_q(k_r \mathbf{r}_1)}{J_q(k_r \mathbf{r}_1)} \quad (14)$$

Substitution into the second equation yields:

$$a_q J_q(k_r \mathbf{r}_2) + b_q N_q(k_r \mathbf{r}_2) = -b_q \frac{N_q(k_r \mathbf{r}_1)}{J_q(k_r \mathbf{r}_1)} J_q(k_r \mathbf{r}_2) + a_q N_q(k_r \mathbf{r}_2) = 0$$

Or,

$$b_q \left( N_q(k_r \mathbf{r}_2) - \frac{N_q(k_r \mathbf{r}_1)}{J_q(k_r \mathbf{r}_1)} J_q(k_r \mathbf{r}_2) \right) = 0$$

For specific values of  $k_r$ ,  $\mathbf{r}_1$  and  $\mathbf{r}_2$ , the values of  $q$  that solve

$$\frac{N_q(k_r \mathbf{r}_2)}{J_q(k_r \mathbf{r}_2)} = \frac{N_q(k_r \mathbf{r}_1)}{J_q(k_r \mathbf{r}_1)} \quad (15)$$

are the sought after mode numbers that are true for any non-zero value of  $b_q$ . Hence,

$$b_q = 1 \text{ and } a_q = -\frac{N_q(k_r \mathbf{r}_1)}{J_q(k_r \mathbf{r}_1)}.$$

Finally, the scalar wave function for the  $\text{TM}_z$  modes is:

$$\mathbf{y} = \left[ N_q(k_r \mathbf{r}) - \frac{N_q(k_r \mathbf{r}_1)}{J_q(k_r \mathbf{r}_1)} J_q(k_r \mathbf{r}) \right] e^{-jz} \sin(nz), \text{ for } n = \frac{m\mathbf{p}}{a}, m = 1, 2, 3, \mathbf{K}, \text{ and } k_r^2 + n^2 = k^2.$$

Note that just a single solution for  $q$  is possible [Ref. 4]. The  $\text{TM}_z$  field components are then found explicitly as:

$$E_r = \frac{nk_r}{j\omega\epsilon} \left[ N'_q(k_r \mathbf{r}) - \frac{N_q(k_r \mathbf{r}_1)}{J_q(k_r \mathbf{r}_1)} J'_q(k_r \mathbf{r}) \right] \cos(nz) e^{-jqz} \quad (16a)$$

$$E_j = -\frac{q^2}{j\omega\epsilon} \frac{1}{r^2} \left[ N_q(k_r \mathbf{r}) - \frac{N_q(k_r \mathbf{r}_1)}{J_q(k_r \mathbf{r}_1)} J_q(k_r \mathbf{r}) \right] \sin(nz) e^{-jqz} \quad (16b)$$

$$E_z = j\omega \left( 1 + \frac{n^2}{k_0^2} \right) \left[ N_q(k_r \mathbf{r}) - \frac{N_q(k_r \mathbf{r}_1)}{J_q(k_r \mathbf{r}_1)} J_q(k_r \mathbf{r}) \right] \sin(nz) e^{-jqz} \quad (16c)$$

$$H_r = -jq \frac{1}{m} \frac{1}{r} \left[ N_q(k_r \mathbf{r}) - \frac{N_q(k_r \mathbf{r}_1)}{J_q(k_r \mathbf{r}_1)} J_q(k_r \mathbf{r}) \right] \sin(nz) e^{-jqz} \quad (16d)$$

$$H_j = -\frac{k_r}{m} \left[ N'_q(k_r \mathbf{r}) - \frac{N_q(k_r \mathbf{r}_1)}{J_q(k_r \mathbf{r}_1)} J'_q(k_r \mathbf{r}) \right] \sin(nz) e^{-jqz} \quad (16e)$$

$$H_z = 0 \quad (16f)$$

## 7.2 $TE_z$ Field Components

The  $TE_z$  electric and magnetic field components in terms of the general wave function are:

$$E_r = j \frac{q}{\epsilon} \frac{1}{r} B_q(k_r \mathbf{r}) e^{-jqz} h(nz) \quad (17a)$$

$$E_j = \frac{k_r}{\epsilon} B'_q(k_r \mathbf{r}) e^{-jqz} h(nz) \quad (17b)$$

$$E_z = 0 \quad (17c)$$

$$H_r = -j \frac{nk_r}{\omega\mu} B'_q(k_r \mathbf{r}) e^{-jqz} h'(nz) \quad (17d)$$

$$H_j = -\frac{nq}{\omega\mu} \frac{1}{r} B_q(k_r \mathbf{r}) e^{-jqz} h'(nz) \quad (17e)$$

$$H_z = -j\omega \left( 1 + \frac{n^2}{k_0^2} \right) B_q(k_r \mathbf{r}) e^{-jqz} h'(nz) \quad (17f)$$

Since

$$E_r = 0 \text{ for } z=0, \text{ and } z=a.$$

then

$$h(nz) \Big|_{z=0,a} = a_n \sin(nz) + b_n \cos(nz) \Big|_{z=0,a}$$

is satisfied if:

$$a_n = 1, b_n = 0, n = \frac{m\mathbf{p}}{a}, \text{ and } m = 1, 2, 3, \dots \quad (18)$$

From the boundary condition on the  $E_j$  component, the general Bessel function,  $B_q(k_r \mathbf{r})$ , also satisfies the boundary conditions if

$$\frac{d}{d(k_r \mathbf{r})} [B_q(k_r \mathbf{r})] |_{r=r_1, r_2} = 0$$

Let

$$B_q(k_r \mathbf{r}) = a_q J_q(k_r \mathbf{r}) + b_q N_q(k_r \mathbf{r}),$$

then

$$\frac{d}{d(k_r \mathbf{r})} \{ [a_q J_q(k_r \mathbf{r}) + b_q N_q(k_r \mathbf{r})] \} |_{r=r_1, r_2} = 0, \text{ or}$$

$$[a_q J'_q(k_r \mathbf{r}) + b_q N'_q(k_r \mathbf{r})] |_{r=r_1, r_2} = 0$$

Substituting for the boundaries  $\mathbf{r} = \mathbf{r}_1$  and  $\mathbf{r} = \mathbf{r}_2$  give the equations:

$$a_q J'_q(k_r \mathbf{r}_1) + b_q N'_q(k_r \mathbf{r}_1) = 0$$

and

$$a_q J'_q(k_r \mathbf{r}_2) + b_q N'_q(k_r \mathbf{r}_2) = 0.$$

Solving the first equation above for

$$a_q : \quad a_q = -b_q \frac{N'_q(k_r \mathbf{r}_1)}{J'_q(k_r \mathbf{r}_1)} \quad (19)$$

Substitution into the second equation yields:

$$-b_q \frac{N'_q(k_r \mathbf{r}_1)}{J'_q(k_r \mathbf{r}_1)} J'_q(k_r \mathbf{r}_2) + b_q N'_q(k_r \mathbf{r}_2) = 0$$

Or,

$$b_q \left[ \frac{N'_q(k_r \mathbf{r}_1)}{J'_q(k_r \mathbf{r}_1)} J'_q(k_r \mathbf{r}_2) - N'_q(k_r \mathbf{r}_2) \right] = 0$$

For specific values of  $k_r$ ,  $\mathbf{r}_1$  and  $\mathbf{r}_2$ , the values of  $q$  that solve

$$N'_q(k_r \mathbf{r}_1) J'_q(k_r \mathbf{r}_2) = N'_q(k_r \mathbf{r}_2) J'_q(k_r \mathbf{r}_1) \quad (20)$$

are the sought after mode numbers that are true for any non-zero value of  $b_q$ . Hence,

$$b_q = 1 \text{ and } a_q = -b_q \frac{N'_q(k_r \mathbf{r}_1)}{J'_q(k_r \mathbf{r}_1)}$$

solves the boundary condition for  $\mathbf{r} = \mathbf{r}_1$ , and the value of  $k_r$  that satisfies Eqn. 20 solves the boundary condition for  $\mathbf{r} = \mathbf{r}_2$ .

Finally, the scalar wave function for the TE<sub>z</sub> modes is:

$$B_q(k_r \mathbf{r}) = N_q(k_r \mathbf{r}) - J_q(k_r \mathbf{r}) \frac{N'_q(k_r \mathbf{r}_1)}{J'_q(k_r \mathbf{r}_1)}$$

$$\mathbf{y} = \left[ N_q(k_r \mathbf{r}) - J_q(k_r \mathbf{r}) \frac{N'_q(k_r \mathbf{r}_1)}{J'_q(k_r \mathbf{r}_1)} \right] \sin(nz) e^{-jqj}, \text{ for } n = \frac{m\mathbf{p}}{a}, m = 0, 1, 2, \dots, \text{ and } k_r^2 + n^2 = k^2.$$

Note that again, just a single solution for  $q$  is possible [Ref. 4]. The TE<sub>z</sub> field components are then found explicitly as:

$$E_r = j \frac{q}{\mathbf{e}} \frac{1}{\mathbf{r}} \left[ N_q(k_r \mathbf{r}) - J_q(k_r \mathbf{r}) \frac{N'_q(k_r \mathbf{r}_1)}{J'_q(k_r \mathbf{r}_1)} \right] \sin(nz) e^{-jqj} \quad (21a)$$

$$E_j = \frac{k_r}{\mathbf{e}} \left[ N'_q(k_r \mathbf{r}) - J'_q(k_r \mathbf{r}) \frac{N'_q(k_r \mathbf{r}_1)}{J'_q(k_r \mathbf{r}_1)} \right] \sin(nz) e^{-jqj} \quad (21b)$$

$$E_z = 0 \quad (21c)$$

$$H_r = -j \frac{nk_r}{\mathbf{w}\mathbf{m}\mathbf{e}} \left[ N'_q(k_r \mathbf{r}) - J'_q(k_r \mathbf{r}) \frac{N'_q(k_r \mathbf{r}_1)}{J'_q(k_r \mathbf{r}_1)} \right] \cos(nz) e^{-jqj} \quad (21d)$$

$$H_j = -\frac{nq}{\mathbf{w}\mathbf{m}\mathbf{e}} \frac{1}{\mathbf{r}} \left[ N_q(k_r \mathbf{r}) - J_q(k_r \mathbf{r}) \frac{N'_q(k_r \mathbf{r}_1)}{J'_q(k_r \mathbf{r}_1)} \right] \cos(nz) e^{-jqj} \quad (21e)$$

$$H_z = j\mathbf{w} \left( 1 + \frac{n^2}{k_0^2} \right) \left[ N_q(k_r \mathbf{r}) - J_q(k_r \mathbf{r}) \frac{N'_q(k_r \mathbf{r}_1)}{J'_q(k_r \mathbf{r}_1)} \right] \sin(nz) e^{-jqj} \quad (21f)$$

## 8. Waveguide Impedance

The characteristic wave impedances for the *Azimuthally Propagating, Truncated, Cylindrical, Coaxial Waveguide* are defined in terms of the dominant field components for the TE and TM modes. The wave impedance for the TE mode is given by

$$Z^{TE} = E_r / H_z; \quad (22a)$$

while wave impedance for the TM mode is given by

$$Z^{TM} = E_z / H_r. \quad (22b)$$

## 9. Example

Determine the fundamental mode and that mode's cutoff frequency of the *Azimuthally Propagating, Truncated, Cylindrical, Coaxial Waveguide* defined by the parameters:  $r_1 = 5in = 0.127 m$ ,  $r_2 = 6in = 0.1524 m$  and  $a = 6.5$  inches. Plot the distributions of all field components at  $f = 1.3$  GHz, determine the guide wavelength in the propagating direction.

The fundamental mode is the  $TE_{z_{11}}$  mode ( $m=1$  and  $q=1$ ). The cutoff frequency is determined by the standard rectangular guide cutoff frequency

$$f_c = \frac{c_0}{2a},$$

where  $c_0$  = speed of light and  $a$  = broad wall dimension. For this case:  $f_c = 2.998 \times 10^8 / (2 \times 0.1651) = 0.9079$  GHz. Shown in Figure 3 is a plot of the numerically determined values of  $q$  as a function of frequency for the  $TE_{z_{11}}$  mode.

To compute the field distributions of the  $TE_{z_{11}}$  mode at  $f = 1.3$  GHz, the value of  $q$  must first be determined. Shown in Figure 4 is a graph of the characteristic equation of the  $TE_{z_{11}}$  mode for an *Azimuthally Propagating, Truncated, Cylindrical, Coaxial Waveguide* defined by the parameters:  $r_1 = 5in = 0.127 m$ ,  $r_2 = 6in = 0.1524 m$  and  $a = 6.5$  inches. The point at which the curve crosses zero defines the required value of  $q$ , in this case  $q = 2.72$ .

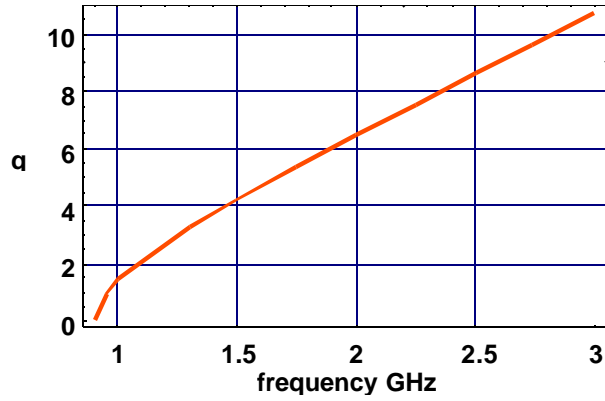
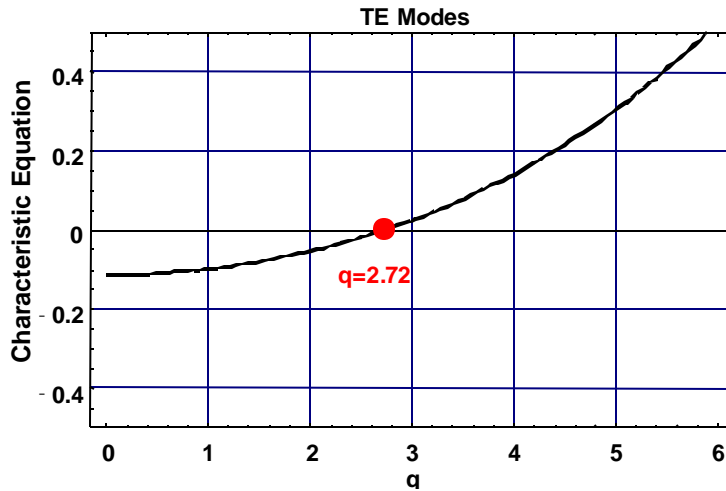

**Figure 3.** The values of  $q$  for the  $TE_{z_{11}}$  mode as a function of frequency for an *Azimuthally Propagating, Truncated, Cylindrical, Coaxial Waveguide* defined by the parameters:  $r_1 = 5in = 0.127 m$ ,  $r_2 = 6in = 0.1524 m$  and  $a = 6.5$  inches.

The field components can now be determined using Equations 21. Shown in Figure 5 are the normalized electromagnetic field distributions of the various field components for the  $TE_{z_{11}}$  mode. One notes that  $E_r$  and  $H_z$  are the dominate field components (as expected), since they closely resemble the fundamental mode field distributions in standard rectangular guide. The guide wavelength can be determined numerically by plotting the real component of the phasor  $E_r$  component of the electric field of the  $TE_{z_{11}}$  mode as a function of azimuthal position as shown in Figure 6. The guide wavelength is found to be

$$\mathbf{l}_g = \frac{\mathbf{r}_1 + \mathbf{r}_2}{2} \times \mathbf{j} = \frac{5+6}{2} \times \frac{132}{180} \times \mathbf{p} = 12.67 \text{ inches}$$

which is just bigger than the free space wavelength at  $f = 1.3$  GHz of 9.08 inches, but less than the rectangular guide wavelength of  $\mathbf{l}_g^{rectangular} = 12.687$  inches. The TE mode impedance can be calculated as  $Z^{TE} = E_r / H_z$ , and in this case is found to be  $Z^{TE} = 181 \Omega$ .



**Figure 4.** The characteristic equation of the TE<sub>z11</sub> mode for an *Azimuthally Propagating, Truncated, Cylindrical, Coaxial Waveguide* defined by the parameters:  $r_1 = 5\text{ in} = 0.127\text{ m}$ ,  $r_2 = 6\text{ in} = 0.1524\text{ m}$  and  $a = 6.5\text{ inches}$ .

As the frequency increases, additional propagating modes become possible. For example, at  $f = 2\text{ GHz}$ , the TE<sub>z21</sub> mode will propagate. The value of  $q = 2.9515$  is found numerically, and the electric field components are shown in Figure 7.

As the frequency further increases, the first TM mode can propagate. For example, at  $f = 2.2\text{ GHz}$ , the TM<sub>z11</sub> mode will propagate. Note that the cutoff frequencies for the TM modes are not defined by the standard simple rectangular waveguide relations (as was found for the TE modes). Rather, they are determined through Bessel function relations that are solved numerically. The value of  $q = 2.998$  is found numerically, and the electric and magnetic field components are shown in Figure 8. The TM mode impedance can be calculated as  $Z^{TM} = E_z / H_r$ , and in this case is found to be  $Z^{TM} = 1140\ \Omega$ .

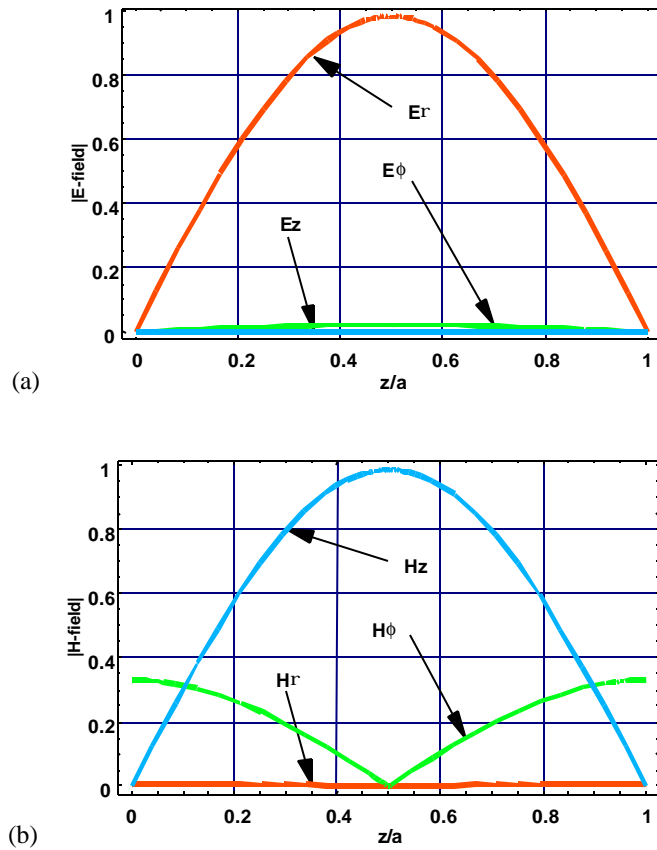

**Figure 5.** The electromagnetic field distribution of the various field components in an *Azimuthally Propagating, Truncated, Cylindrical, Coaxial Waveguide* defined by the parameters:  $r_1 = 5\text{ in} = 0.127\text{ m}$ ,  $r_2 = 6\text{ in} = 0.1524\text{ m}$  and  $a = 6.5$  inches for the TE<sub>z</sub>11 mode: (a) normalized electric field; and (b) normalized magnetic field.

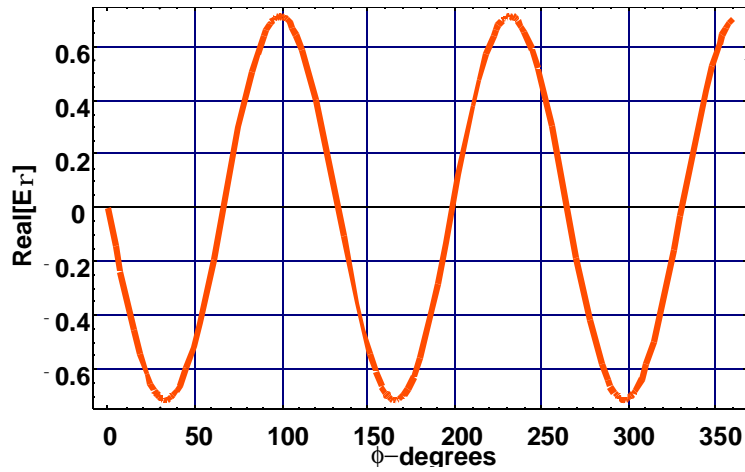

Figure 6. The value of the  $E_r$  component of the electric field of the  $TEz_{11}$  mode as a function of azimuthal position.

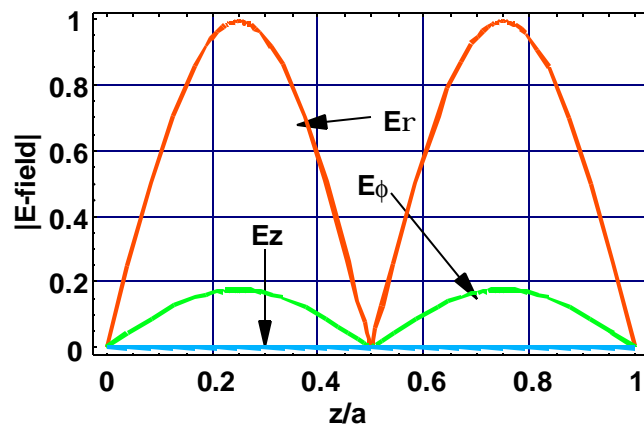
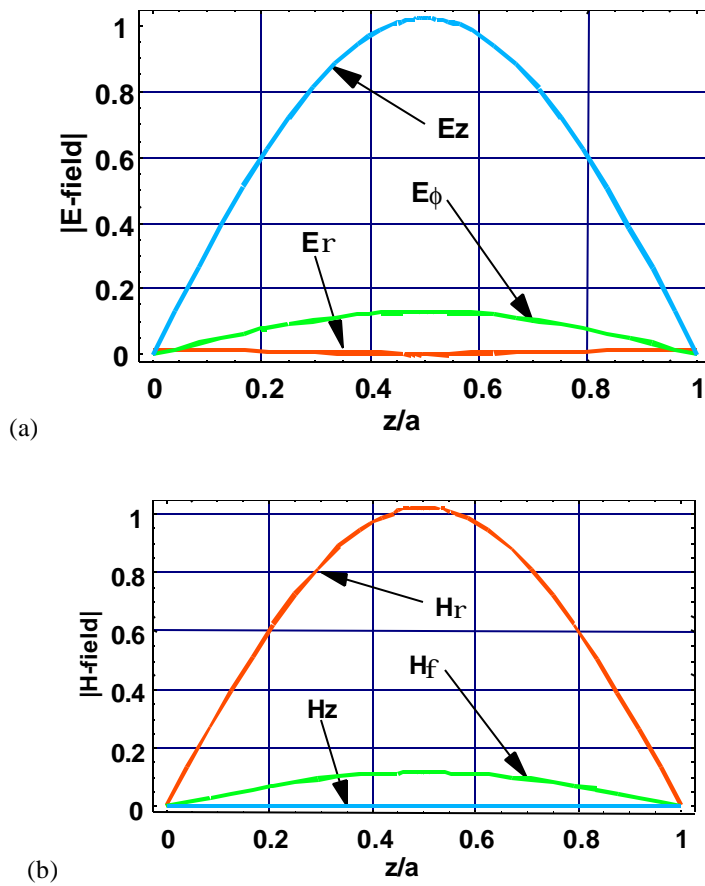

Figure 7. The electric field distribution of the various field components in an *Azimuthally Propagating, Truncated, Cylindrical, Coaxial Waveguide* defined by the parameters:  $r_1 = 5in = 0.127\ m$ ,  $r_2 = 6in = 0.1524\ m$  and  $a = 6.5$  inches for the  $TEz_{21}$  mode.



**Figure 8.** The electromagnetic field distribution of the various field components for the  $TMz_{11}$  mode: (a) normalized electric field; and (b) normalized magnetic field.

## 10. Conclusion

This report derives the cut off frequencies and fields of azimuthally propagating modes in a truncated, cylindrical waveguide. Waveguide impedances are also derived, and example computations are shown. The results are useful for designing antenna and transmission structures conformal to curved and cylindrical surfaces.

## REFERENCES

1. "Modes of a double baffled, cylindrical, coaxial waveguide," C. Courtney, et al, submitted for publication as an AFRL SSN memo, September 2003.
2. Time Harmonic Electromagnetic Fields, R. Harrington, pg. 199, McGraw-Hill, NY, 1961.
3. Waveguide Handbook, ed. N. Marcuwitz, MIT Radiation Laboratory Series, vol. 10, pp. 333 – 335.
4. Encyclopedia of Physics, ed. S. Flugge, pg. 366, Springer-Verlag, Berlin, 1958.
5. "Propagation in curved and twisted waveguides of rectangular cross-section," L. Lewin, Proceedings of the Institute of Electrical Engineers, Part B 102, pp 75 – 80, 1055.

## APPENDIX A- About the Wave Equation in Cylindrical Coordinates<sup>1</sup>

The natural coordinate system for the *Azimuthally Propagating, Truncated, Cylindrical, Coaxial Waveguide* is the cylindrical coordinate system. And one might be tempted to propose solutions that  $TE_\phi$  and  $TM_\phi$ . This would not be wise.

The VECTOR wave equation is

$$(\nabla^2 + k_0^2)\Psi = 0 \quad (A1)$$

where the vector operator  $\nabla^2(\cdot) = \nabla(\nabla \cdot (\cdot)) - \nabla \times \nabla(\cdot)$ . Now this equation reduces to the scalar wave equation for Cartesian coordinates, since the unit vectors are constants. This is not so in cylindrical coordinates, except for the unit vector in the  $z$ -direction. When written out, Equation No. 1 becomes

$$\left( \nabla^2 \Psi_r - \frac{1}{r^2} \Psi_r - \frac{2}{r^2} \frac{\partial}{\partial j} \Psi_j \right) \mathbf{u}_r + \left( \nabla^2 \Psi_j - \frac{1}{r^2} \Psi_j + \frac{2}{r^2} \frac{\partial}{\partial j} \Psi_r \right) \mathbf{u}_j + (\nabla^2 \Psi_z) \mathbf{u}_z + k_0^2 \Psi = 0 \quad (A2)$$

Separating this into its components yields three equations

$$\nabla^2 \Psi_r - \frac{1}{r^2} \Psi_r - \frac{2}{r^2} \frac{\partial}{\partial j} \Psi_j + k_0^2 \Psi_r = 0 \quad (A3a)$$

$$\nabla^2 \Psi_j - \frac{1}{r^2} \Psi_j + \frac{2}{r^2} \frac{\partial}{\partial j} \Psi_r + k_0^2 \Psi_j = 0 \quad (A3b)$$

$$\nabla^2 \Psi_z + k_0^2 \Psi_z = 0 \quad (A3c)$$

Only Equation 3c is a scalar wave equation. In forming the solutions for the potentials, it is important that we propose solutions that are  $TE_z$  and  $TM_z$ , so that solutions to the scalar wave equation can be postulated.

---

<sup>1</sup> From Prof. Chalmers Butler's ECE 831 class notes, Clemson University, 1988.

DISTRIBUTION LIST

DTIC/OCP

8725 John J. Kingman Rd, Suite 0944

Ft Belvoir, VA 22060-6218 1 cy

AFRL/VSIL

Kirtland AFB, NM 87117-5776 2 cys

AFRL/VSIH

Kirtland AFB, NM 87117-5776 1 cy

AFRL/DEHP/Dr. Thomas Spencer

Kirtland AFB, NM 97117-5776 1cy

Official Record Copy

AFRL/DEHE/Dr. Andrew Greenwood 2 cys