



**AIR FORCE HANDBOOK 10-222, Volume 12
1 September 1999**

**GUIDE TO BARE BASE
MECHANICAL SYSTEMS, PART I**



DEPARTMENT OF THE AIR FORCE

Report Documentation Page

Form Approved
OMB No. 0704-0188

Public reporting burden for the collection of information is estimated to average 1 hour per response, including the time for reviewing instructions, searching existing data sources, gathering and maintaining the data needed, and completing and reviewing the collection of information. Send comments regarding this burden estimate or any other aspect of this collection of information, including suggestions for reducing this burden, to Washington Headquarters Services, Directorate for Information Operations and Reports, 1215 Jefferson Davis Highway, Suite 1204, Arlington VA 22202-4302. Respondents should be aware that notwithstanding any other provision of law, no person shall be subject to a penalty for failing to comply with a collection of information if it does not display a currently valid OMB control number.

1. REPORT DATE 01 SEP 1999		2. REPORT TYPE N/A		3. DATES COVERED -	
4. TITLE AND SUBTITLE Guide To Bare Base Mechanical Systems Part I - Air Force Handbook 10-222, Volume 12				5a. CONTRACT NUMBER	
				5b. GRANT NUMBER	
				5c. PROGRAM ELEMENT NUMBER	
6. AUTHOR(S)				5d. PROJECT NUMBER	
				5e. TASK NUMBER	
				5f. WORK UNIT NUMBER	
7. PERFORMING ORGANIZATION NAME(S) AND ADDRESS(ES) Secretary Of The Air Force Washington, DC				8. PERFORMING ORGANIZATION REPORT NUMBER	
9. SPONSORING/MONITORING AGENCY NAME(S) AND ADDRESS(ES)				10. SPONSOR/MONITOR'S ACRONYM(S)	
				11. SPONSOR/MONITOR'S REPORT NUMBER(S)	
12. DISTRIBUTION/AVAILABILITY STATEMENT Approved for public release, distribution unlimited					
13. SUPPLEMENTARY NOTES					
14. ABSTRACT					
15. SUBJECT TERMS					
16. SECURITY CLASSIFICATION OF:			17. LIMITATION OF ABSTRACT UU	18. NUMBER OF PAGES 72	19a. NAME OF RESPONSIBLE PERSON
a. REPORT unclassified	b. ABSTRACT unclassified	c. THIS PAGE unclassified			

BY ORDER OF THE AIR FORCE HANDBOOK 10-222, VOLUME 12
SECRETARY OF THE AIR FORCE 1 SEPTEMBER 1999



OPERATIONS
GUIDE TO BARE BASE MECHANICAL SYSTEMS
PART I

NOTICE: This publication is available digitally on the SAF/AAD WWW site at: <http://afpubs.hq.af.mil>. If you lack access, contact your Publishing Distribution Office (PDO).

OPR: HQ AFCESA/CEXR (Major Gregory A. Cummings)
Certified by: HQ AFCESA/CEX (Colonel Bruce F. Mc Connell)
Pages 71/Distribution: F and X

This handbook is designed to assist you in setting up and operating the mechanical systems commonly encountered during bare base operations. Specifically, the M-80 boiler, Preway heater, environmental control unit, 150 cubic foot refrigeration unit, 1200 cubic foot refrigeration unit, and mobile water chiller will be discussed. This handbook addresses, as appropriate, site selection and layout; major components; set up, operation and shutdown of the various systems. When coupled with information contained in the applicable technical orders and AFPAM 10-219, Vol. 5, Bare Base Conceptual Planning Guide, and instruction received at Silver Flag training sites, personnel should be capable of effectively setting up and operating the equipment under contingency conditions. Information in this handbook assumes the reader has basic familiarity with bare base-related mechanical systems. If this is not the case, consult the technical orders and attend Silver Flag training.

	Page
INTRODUCTION.....	5
M-80 BOILER.....	7
PREWAY HEATER	25
ENVIRONMENTAL CONTROL UNIT	34

150 CUBIC FOOT REFRIGERATION UNIT	42
1200 CUBIC FOOT REFRIGERATION UNIT	56
MOBILE WATER CHILLER.....	61

Figures

1. M-80 Boiler.....	7
2. Drum Fill Adapter Assembly and Flexible Hoses	8
3. Water Pump and Suction Line	9
4. Water Vessel.....	9
5. Burner Assembly	10
6. Blower Assembly	11
7. Control Box Assembly	11
8. Sight Glass Assembly	12
9. Transformer and Ignition Cables.....	12
10. M-80 Heater Water Hose Connections	14
11. Elbow, Smoke Stack and Guard Assembly	14
12. Drum Fill Adapter in Fuel Container.....	15
13. Fuel Line Connections.....	16
14. Electrical Connections	16
15. Load Limit Switch	17
16. Manual Fuel Valve.....	17
17. Reset Button on Flame Safeguard Control	18
18. Water Pump Primer Coupling.....	19
19. Fuel Pressure Gauge.....	21
20. Water Temperature Gauge	22
21. Fuel Line Stowage Position	24
22. Preway Heater.....	25
23. Siphon Assembly	26
24. Control Valve.....	27
25. Stove Pipe Components	27
26. Stove Pipe Assembly	29
27. Siphon Assembly Placement.....	30
28. Position of Siphon Assembly During Fuel Can Change Out	32

29.	A/E32C-39 Environmental Control Unit	34
30.	Flexible Duct Connection.....	36
31.	Control Panel.....	37
32.	Electrical Connection Receptacle.....	38
33.	Manually-Operated Damper.....	39
34.	Duct Storage Racks	40
35.	150 Cubic Foot Refrigeration Box.....	42
36.	Mechanical Refrigeration Equipment.....	43
37.	Control Panel.....	44
38.	Temperature and Pressure Gauges	45
39.	Condenser Coil	45
40.	Condenser Fan.....	46
41.	Evaporator Coil.....	46
42.	Evaporator Fan	47
43.	Fan Motor.....	47
44.	Receiver Tank.....	48
45.	Compressor.....	48
46.	Condenser Section Gasket Seal.....	50
47.	Valve Locations	51
48.	Defrost Cycle Timer	52
49.	Cable Routing.....	53
50.	1200 Cubic Foot Refrigeration Box.....	57
51.	Floor Screed Sections	57
52.	Floor, Wall, and Ceiling Locking Mechanisms	58
53.	Wall and Corner Panels	59
54.	Ceiling Panels	60
55.	Mobile Water Chiller.....	61
56.	Support Kit Items	62
57.	Chiller Hose Connections Points	64
58.	Hose Connections	64
59.	Quick-Disconnect Fuel Fitting	65
60.	START RUN Water Control.....	67
61.	Toggle Switch, Choke, Pneumatic Timer Switch, and Starter Button ..	68
62.	12 VOLT INPUT FOR STARTING Connection	70

Tables

1.	M-80 Pre-Op Inspections	20
2.	Water Heater Operational Checks.....	22
3.	Pre-Operational Checks for the 150 CF Refrigeration Unit	54
4.	Operational Checks for the 150 CF Refrigeration Unit.....	54
5.	Water Chiller Pre-Operational Checks.....	66
6.	Operational Checks for the Water Chiller.....	70

INTRODUCTION

GUIDE TO BARE BASE MECHANICAL SYSTEMS

PURPOSE OF BOOKLET

This handbook addresses the procedures used to set up and operate the M-80 boiler, Preway heater, environmental control unit, 150 cubic foot refrigeration unit, 1200 cubic foot refrigeration unit, and the mobile water chiller. It is meant to be used by civil engineering heating, ventilation and air conditioning (HVAC) personnel in performing their beddown and sustainment mission taskings under contingency conditions. Users of this booklet are assumed to have a basic knowledge of bare base assets and their function---readers without this fundamental knowledge should review the below listed technical orders; AFPAM 10-219, Volume 5, Bare Base Conceptual Planning Guide; AFH 10-222, Volume 1, Guide to Bare Base Development; and AFH 10-222, Volume 2, Guide to Bare Base Assets.

TO 40P1-6-2-1, Bath Unit

TM 5-4520-235-13, Preway 70,000 BTU Space Oil-Fired Tent Heater

TO 35E9-163-1, Air Conditioner, Type A/E 32C-39

TO 35E9-274-1/-4, 1200 CF Refer

TM 5-4110-240-13 & P, 150 CF Refer

TM 10-4130-239-14, Small Mobile Water Chiller

TM 5-4110-239-14, Refrigeration Unit, 5000 BTU/HR

This handbook is designed to augment, not replace, the system's technical orders. This booklet will not address the details of operator or organizational maintenance and repair of the various equipment items. Refer to the appropriate technical orders for warnings, cautions, and maintenance and troubleshooting information.



M-80 BOILER

Characteristics

The M-80 boiler (figure 1) is used to supply hot water to bare base facilities, such as shower/shave units, kitchens and hospitals. This water heater is a self-contained, liquid fuel-fired boiler. It will operate on commercial fuel oil, diesel or gasoline consuming about five gallons an hour. The water supply for the boiler can be from a natural source such as a lake or river or from the bare base water distribution system. The heater also requires a 208-volt, three-phase power supply to operate its blower, fuel pump and supporting water pump. Controls on the heater permit water temperature to be maintained between 160° F and 210°. You will need a forklift to position the unit since in its crated configuration it weighs approximately 1065 pounds. Even after the boiler is unpacked, it alone weighs almost 500 pounds. The heater has several major subassemblies and supporting equipment items.

Figure 1. M-80 Boiler.



Fuel System. Fuel is commonly provided in 55-gallon drums (5-gallon jerry cans also can be used) and fed to the heater through a drum fill adapter assembly and flexible hose assemblies (figure 2).

Figure 2. Drum Fill Adapter Assembly and Flexible Hoses.



Water Pump and Suction Line (figure 3). A 20 gpm, electrically driven pump is provided to pump water from a source such as a lake or river or from an onion tank to the heater. A 25-foot, 1-inch inside diameter hose with a strainer assembly on one end attaches to the intake side of the pump and serves as the suction line from the water source. The pump is connected to the water heater using a 6-foot, 1 ½-inch inside diameter hose.

Power Cable Assembly. The power cable assembly consists of two cables that extend from the power source (3kW generator or power distribution panel) to the heater. The short cable connects to the power source while the longer cable connects to the short cable, the water pump, and the heater itself.

Water Vessel (figure 4). The water vessel is basically the container holding the water being heated. It holds approximately 24 gallons.

Figure 3. Water Pump and Suction Line.



Figure 4. Water Vessel.



Burner Assembly (figure 5). The burner assembly contains the electrodes that are energized to ignite the fuel mixture for heating the water. It also includes a sight glass, fuel feeder nozzle, and UV scanner.

Figure 5. Burner Assembly.



Blower Assembly (figure 6). The blower assembly provides and controls airflow to the burner. Amount of air is controlled by a manually moveable shutter on the blower.

Control Box Assembly (figure 7). The control box assembly contains a majority of the electrical contacts, relays, switches and control components for the heater.

Sight Glass Assembly (figure 8). Two sight glasses are on the M-80 heater. One is used to visually check combustion in the combustion chamber; the other to check firing of the electrodes.

Transformer and Ignition Cables (figure 9). The ignition cables connect the transformer to the electrodes. The transformer provides the voltage needed to fire the electrodes.

Figure 6. Blower Assembly.



Figure 7. Control Box Assembly.



Figure 8. Sight Glass Assembly.

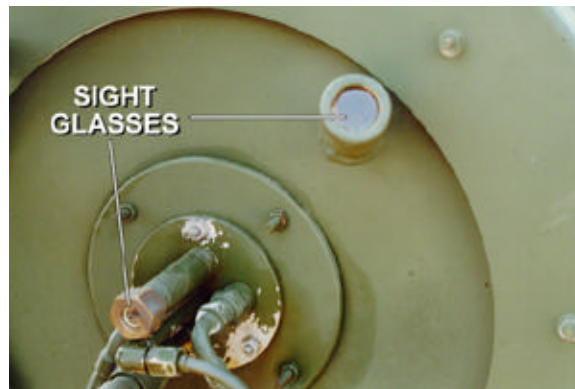
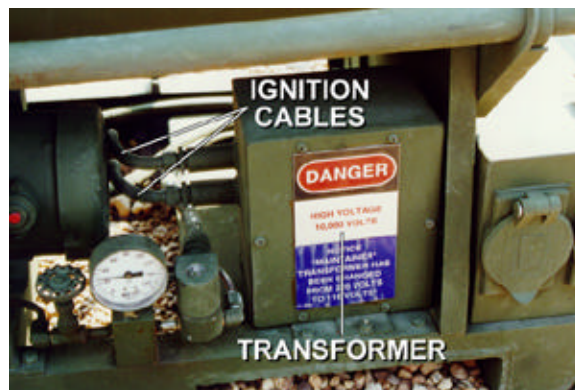

Figure 9. Transformer and Ignition Cables.



M-80 Set Up

Location of the heater unit is basically restricted by the length of the hoses used to move the water. If a stream or river is being used, the water pump should be placed within 20 feet of the source and not more than 15 feet above it. The more likely scenario is that you will be operating with a bare base water system and you'll be taking water from an onion tank placed near the heater unit. **Attempt to locate the heater away from avenues of pedestrian traffic** and far enough away from its supported facility to permit ready access for operation, maintenance and refueling. Ensure drainage flows away from the heater. The procedures to be described relate to the technical order for the boiler. There are other pumps and hoses of differing sizes and lengths in the Harvest Falcon sets that can be used to support the boiler so you do have some additional flexibility. Steps to take to set up the heater are as follows:

Connect strainer to the male end of the 25-foot suction hose and connect other end of the hose to the water pump intake connection. Ensure the water pump is within 20 feet of the source.

Place strainer end of suction hose into the water source. Keep strainer off the bottom of the source using an expedient method (float, tie to a piling, etc.)—see AFPAM 10-219, Volume 3, Chapter 7, for several examples.

Position water heater within 5 feet of the water pump and connect the two using the 6-foot hose section (figure 10).

Connect the female end of one 7 ½ foot, one-inch diameter hose to the hot water outlet fitting on the heater (figure 10). Connect the other end of the hose to the hot fitting of the appropriate mixing valve (different mixing valves exist in the Harvest Falcon package).

Connect the male end of a 7 ½ foot, one inch diameter hose to the water pump outlet (figure 10). Connect the other end of the hose to the cold fitting on the mixing valve.

Attach elbow, smoke stack and guard assembly on the heater (figure 11).

Figure 10. M-80 Heater Water Hose Connections.



Figure 11. Elbow, Smoke Stack and Guard Assembly.



Place fuel container about 5 feet from the heater. Screw drum fill adapter into the top of the fuel container (figure 12). Devise a fuel spill containment system around your fuel storage container(s) and make sure a fire extinguisher is handy.

Figure 12. Drum Fill Adapter in Fuel Container.



Connect fuel line from pump filter to the suction fitting on the adapter. Connect second fuel line from pump to the return fitting on the adapter (figure 13).

Connect electrical cable assemblies to the water pump, heater and power source (figure 14). Ensure the source is 208 volt, 3-phase, 60 cycle.

Quickly turn the switch on the water pump junction box on and off and note rotation of the motor. Motor must turn in the same direction as the arrow on the pump housing. If the rotation is incorrect or the motor just hums, have an electrician reverse leads in the junction box (a three-phase motor must have the phases properly connected to operate and run in the proper direction).

Make sure water heater load limit switch (figure 15) is turned off.

Make sure manual fuel valve (figure 16) is closed.

Figure 13. Fuel Line Connections.



Figure 14. Electrical Connections.



Figure 15. Load Limit Switch.

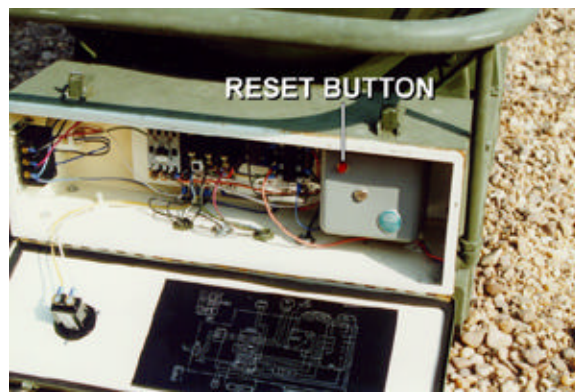

Figure 16. Manual Fuel Valve.



Press the reset button on the flame safeguard control (figure 17) inside the control box assembly.

Figure 17. Reset Button on Flame Safeguard Control.



Open the blower shutter on the blower assembly about half way.

Open the fuel pump primer plug and fill the fuel pump with fuel.

Ensure water heater drain cock is closed.

Prime the water pump by filling the coupling on top of the pump with water (figure 18). Ensure plug is placed back into coupling. Close the valve on the top of the pump that allows water to go to the mixing valve.

Open the faucet on the top of the water vessel and turn on the pump. Allow vessel to fill until water comes out of the faucet, then close the faucet and turn the pump off.

Figure 18. Water Pump Primer Coupling.



Quickly turn the load limit switch (figure 15) on and off and note the rotation of the blower and fuel pump motor. If it is not rotating in the same direction as the arrow on top of the fuel pump, have an electrician reverse the leads on the control box power input plug (a three-phase motor must have the phases properly connected to operate and run in the proper direction).

Start Up and Operation

Prior to any start up activity there are several inspections of system components you should make. These are summarized in table 1. If problems are found during these checks and inspections, repairs should be made before attempting to operate the heater.

Table 1. M-80 Pre-Op Inspections

Check power cable for damage and cracks
Check strainer for obstructions
Inspect water pump motor for obstructions
Check smoke stack for damage and tight fit
Check condition of glass in the sight glass assemblies
Inspect condition of ignition cables
Check condition of fuel pressure gauge
Check fuel shutoff valve for leaks and operation
Inspect condition of fuel lines
Check condition of mixing valve
Check rotation of blower motor

Follow the steps listed below to start up and operate the heater unit:

Ensure water pump and fuel pump are primed and the water vessel is full.

Open the manual fuel valve and turn load limit switch on. Fuel pressure gauge (figure 19) should read 100 psi.

View ignition spark through burner assembly sight glass.

Wait seven seconds and view combustion through the combustion chamber sight glass.

If combustion does not occur after an additional 12 second wait, the buzzer alarm will sound and the ignition spark will shut down. Wait two minutes after the buzzer sounds and then press the reset button on the flame safeguard control. If combustion still does not occur, refer to your technical order for troubleshooting actions.

If necessary, slowly open the air shutter on the blower assembly until exhaust gasses are transparent and smokeless.

Figure 19. Fuel Pressure Gauge.



Ensure the water pump is on and the water pump valve is open. The valve on the top of the water vessel controlling hot water flow (water heater outlet valve) to the mixer valve should be closed.

Wait until the temperature gauge (figure 20) shows 160 degrees Fahrenheit and open the water heater outlet valve.

Open a valve at a dispensing point (shower, sink, etc). Adjust mixing valve temperature control to desired water temperature.

During operation of the heater several continual system checks should be made. They are listed in table 2.

Figure 20. Water Temperature Gauge.**Table 2. Water Heater Operational Checks.**

Check exhaust gasses for clearness. Adjust air shutter as necessary
Check temperature gauge, keep temperature between 160°F and 190°F
Check fuel pressure gauge, maintain 90 psi to 100 psi
Inspect fuel lines for leaks or damages
Check mixing valve for leaks and temperature gauge problems

Shutdown

Turn off the fuel valve, load limit switch and water pump.

If the heater is not going to be used for several days or more, also accomplish the following:

Remove the fuel feed hose from the fuel drum adapter and place the end of the hose into a quart container.

Fill the quart container with diesel fuel.

Turn on the load limit switch and operate the unit until the quart container is almost empty. Then close the fuel valve and let the heater operate until the combustion flame goes out.

Turn off the load limit switch.

Reconstitution

Perform shutdown procedures above.

Disconnect power cable from water heater and water pump.

Retrieve suction line from the water source and disconnect the strainer.

Disconnect and drain all water hoses, and water vessel.

Close fuel valve and disconnect fuel lines from the fuel drum fill adapter.

Stow fuel lines on the holder under the water vessel (figure 21).

Disconnect and remove smoke stack and drum fill adapter. Drain lines.

Thoroughly clean and dry all items then pack them in their appropriate shipping boxes.

Figure 21. Fuel Line Stowage Position.



PREWAY HEATER

Characteristics

The Preway heater (figure 22) has been in the Air Force contingency asset inventory for over 25 years attesting to its dependability and functionality. It can be used with either the current TEMPER tents or the older general purpose tents. **The heater operates on diesel fuel only; use of any other types of fuel risks a severe fire and explosive hazard.** There are several models of the Preway heater; the majority are nominally rated at 70,000 British thermal units (BTUs). Primary components include the following:

Fuel System. Diesel fuel is supplied to a control valve from a 5-gallon Jerry can hung on the side of the heater unit. A siphon assembly (figure 23) is used to flow the fuel from the can to the control valve.

Figure 22. Preway Heater.



Figure 23. Siphon Assembly.

Combustion Chamber. The combustion chamber consists of a metal drum surrounded by a perforated metal guard and is mounted on a metal base.

Control Valve. The control valve (figure 24) is manually adjusted to regulate fuel flow thereby raising or lowering the intensity of the flame in the heater.

Stove Pipe Components (figure 25). A draft regulator, rain cap, elbow and several pipe sections are included with the heater to allow venting of exhaust gas and smoke through the roof section of tents.

Figure 24. Control Valve.



Figure 25. Stove Pipe Components.



Heater Set Up

To ensure proper fuel combustion, the heater must be installed so that airflow to it is unimpeded. **It must be placed on a non-combustible stove board that extends beyond all sides of the heater and fuel can.** Locally manufactured metal trays are often used. These stove boards must also be able to contain 5 gallons of fuel in case a fuel can ruptures or leaks severely. **Maintain a separation distance of three feet between the heater and all combustible materials.** If a shield made of metal or similar non-combustible material is used, separation distance can be lessened. The shield must be two inches from any combustible material, six inches from the heater and extend beyond the rear and sides of the fuel can. For typical tent operations, the three-foot separation distance should not cause problems. **The lower portion of the stovepipe must be kept 18 inches away from combustible materials.** If the stovepipe is protected by sheet metal placed at least one inch from the surface to be protected and extending the length of the pipe and 12 inches beyond it on all sides, clearance may be reduced to 9 inches. For overall safety purposes, it is wise to have a fire extinguisher readily available. Follow the steps below for installing the heater for its most common application, heating the TEMPER tent:

While the tent is in the partially erect position (see Volume 6 of this publication series for TEMPER tent erection procedures), assemble two sections of pipe and the rain cap and insert the assembly through the stack hole in the roof of the tent. The pipe should extend about 18 inches above the tent roof. If a tent fly is being used, the pipe should extend 18 inches above that.

Place the heater on the stove board and locate it under the roof stove pipe vent in such a way that only minor movement of the heater will be necessary when the full stove pipe is assembled.

Fit the elbow onto the heater flue collar and bolt in place. Center the elbow opening under the roof vent opening.

Fit one length of stovepipe on the elbow and install the draft regulator tee on this pipe. The draft regulator should face a doorway of the tent if at all possible. **Under no circumstances should the regulator face the heater itself.**

Assemble the remaining sections of pipe and connect them between the draft regulator tee and the sections already in place in the tent roof section. See figure 26 for a picture of the finished stovepipe installation.

Figure 26. Stove Pipe Assembly.



Place a level across the top grille of the heater from front to rear and side to side. Adjust leveling bolts on the bottom of the heater until the heater is level in both directions.

Place a pocket level across the top of the fuel control valve from front to rear and side to side. Bend the valve bracket until valve is level.

Start Up and Operation

Check fuel can and fuel lines. Fix leaks if any are present. **Smell the contents of the fuel can to ensure that only diesel fuel is being used.** Wipe off the bottom of the fuel can so dirt doesn't fall onto the control valve.

Hang fuel can on hook on the left side of the unit.

Remove the fuel can cap and insert the small tube of the siphon assembly into the siphon tube and the siphon barrel into the fuel can (figure 27). Fit the cap of the siphon assembly into the fuel can opening.

Figure 27. Siphon Assembly Placement.



Prime the siphon by moving the siphon assembly up and down rapidly several times. Strokes should be 4 to 6 inches long.

Set the reset lever on the fuel control valve (figure 24) in the down position (some models require reset lever to be up—see the technical order for your unit). It's smart to check the valve itself; often lever settings are shown on the valve.

Turn the control knob (figure 24) to setting 6 (older units may be marked LOW and HIGH, set the knob on HIGH).

Open the burner door to visually check whether fuel has entered the burner well. Reset control knob to the 1 (LOW) position. Reprime if fuel has not come into the burner within two minutes.

Light a crumpled piece of paper and drop it into the burner well. When the fuel ignites, close and latch the heater door. Let the heater operate 15 minutes before regulating the flame. You can monitor the flame through the peephole in the heater door.

Increase heat output by turning the fuel control knob counterclockwise. Turn knob one position at a time until desired flame height is obtained. **Allow 10 minutes between each movement of the control knob.** If burner is not hot enough when the control knob is increased, the flame will be red and smoky and a roaring, vibrating noise will be heard. Turn the knob back down to setting 1 (LOW) and start the process again making sure the 10-minute warm up periods are observed.

To decrease heat output, turn control knob clockwise to desired flame height. Do not turn the knob below setting 1 (LOW) or the flame may go out. Experience has shown that setting 4 produces the most efficient operation. **Stay away from setting 1 if possible, sooting increases dramatically at this level.** Also, refrain from using setting 6, much of the heat will be lost through the stovepipe. Once the heater is in operation, remind people to use it properly. **Do not attempt to heat food or dry clothing on the heater.**

Fuel Can Change Out

Fuel cans can be changed without the heater going out. This eliminates the need to wait until the heater cools before re-lighting it. To do this, however, requires that you not let the can in use become empty before change out.

Turn control valve knob to setting 1 (LOW).

Lift siphon assembly out of the in-use fuel can and rest the pump cylinder end (barrel end) in the drain tray (figure 28).

Remove used fuel can.

Smell contents of new fuel can to ensure diesel fuel is present, wipe off the bottom of the can and hang it on the hook on the side of the heater.

Place siphon assembly into new fuel can and reprime.

Figure 28. Position of Siphon Assembly During Fuel Can Change Out.

Shutdown

Turn control valve knob to setting 1 (LOW).

Set reset lever to up position to stop fuel flow (check the technical order for your unit, some models have levers that operate differently).

Allow flame to burn out.

Reconstitution

Shutdown heater and allow it to cool.

Remove siphon assembly from heater and fuel can, drain and allow to dry. If available, clean out assembly with compressed air. Be sure to clean the little filter screen in the barrel end of the assembly.

Remove fuel can from heater.

Disassemble entire stovepipe and clean all items with a brush to remove soot. If a brush is not available, try using sand, silica or similar material as an expedient cleaning abrasive.

Remove burner parts from combustion chamber and remove soot with brush.

Clean inside of combustion chamber with a brush. If available, use a vacuum to remove soot.

Drain control valve and clean the strainer filter in the control valve.

Package components in appropriate shipping/storage containers.



ENVIRONMENTAL CONTROL UNIT

Characteristics

The A/E32C-39 environmental control unit (ECU)(figure 29) is the primary air conditioning and heating unit supporting the Harvest Falcon mobility packages. In a Harvest Falcon deployment package supporting just one squadron of aircraft there will be over 230 of these units available. They can be connected to the three most common facility types in the Falcon system—TEMPER tents, general purpose shelters and expandable shelter containers.

Figure 29. A/E32C-39 Environmental Control Unit.



The ECU is intended for use in air conditioning, heating, dehumidifying, filtering and ventilating. The air conditioning operates on the typical vapor-compression principle rated at about 4 ½ tons. The heating portion of the system relies on six electrical heating elements rated at 9.6 kW. The units are connected to facilities using flexible ducting that comes with each ECU. The unit is often described as having four distinct sides. The front of the unit

houses the evaporator compartment and contains the openings to which the ductwork is connected. The rear of the unit contains the condenser compartment. Airflow for the condenser enters at the rear of the unit and exits through the top. The operator controls are located on the right side of the unit. The manufacturer's nameplate is mounted on the left side of the unit. You will need a forklift to move and place the unit since it weighs over 900 pounds. Its footprint is approximately four feet by six feet and it requires 208v, 3-phase electrical power.

ECU Installation

The ECU should be placed in a relatively flat area measuring at least four feet by eight feet. There should be no more than five inches height difference between any of the corners. **Do not place the unit in such a manner that the condenser fan exhaust coming from the top of the unit is obstructed.** The ECU should be positioned approximately six to seven feet from the facility it is to be connected to. The front of the unit should face the facility. **Ensure you also have at least two feet of clearance at the rear of the ECU so that airflow to the condenser is not hindered.** When possible, place the unit on 2 x 4 wood strips or a wood frame to keep the unit's metal frame from sitting in condensate. Connect the ECU to a facility as follows:

Remove the flexible ducts from their storage location in the rear of the ECU.

Remove the covers from the duct adapter flanges on the front of the unit. Store covers in the condenser compartment.

Check the lengths of the two duct pieces. The seven-foot duct is the inlet duct. The nine-foot section is the discharge duct.

Clamp the inlet duct to the lower adapter flange on the unit and the lower hole on the wall section of the facility.

Clamp the discharge duct to the upper adapter flange (figure 30) on the unit and the upper hole on the wall section of the facility. For the TEMPER tent ensure the discharge duct is connected to the tent air distribution plenum.

Figure 30. Flexible Duct Connection.



Remove the plastic plugs from the condensate drain outlets on both sides of the unit. These drains are located in the fork lift opening toward the evaporator end (front) of the ECU. Collect and secure all the plugs so that they will be available for use when the camp is broken down. If engineer forces change before camp closure, ensure the plugs are given to the replacing team.

Insert barbed hose connection fittings into the drain holes and attach drain hoses.

Remove power cable from its storage location in the door on the left side of the ECU.

Open control panel (figure 31) on right side of the unit and set mode selector switch to OFF-RESET.

Connect one end of the power cable to the receptacle on the right side of the unit (figure 32). Connect the other end of the cable to a power distribution panel supplying 208 volt, 3-phase power (have an electrician do this task). Some ECUs, however, are hard wired; therefore, you may find that connection to the unit electrical receptacle is unnecessary. Closely observe fan rotation during initial start-up. If the fan runs backwards, have an electrician reverse two of the power leads.

Figure 31. Control Panel.



Caution, do not operate the ECU for at least five hours after power is first supplied. Time is required for the crankcase heater to vaporize refrigerant condensed in the compressor crankcase oil. (If the outside temperature is above 100 degrees Fahrenheit, you may not have to wait the five hours. In hot weather the liquid refrigerant should boil off enough to operate the condenser without having to wait.)

Figure 32. Electrical Connection Receptacle.**Operation**

To ventilate a facility only, turn the mode selector switch to the VENT position.

For cooling or heating turn the mode selector switch to AUTO. Adjust the temperature selector control toward INCREASE or DECREASE as desired. Caution user personnel not to force the temperature selector past its stop. This breaks the switch. If the unit is not heating or cooling properly, troubleshoot the unit.

Do not operate the air conditioner in the AUTO mode when the outside temperature is below 50° Fahrenheit. Instead, use the VENT mode and admit outside makeup air. A manually operated damper (figure 33) at the front of the unit can be opened to add fresh air to the airflow.

Figure 33. Manually-Operated Damper.



To check whether the unit is cooling normally run the ECU in the AUTO mode with temperature control on full DECREASE. After 15 minutes use a thermometer to check the temperature differential between the discharge and inlet ducts. If incoming air is 15° plus/minus 3° cooler than the return air, the unit is working properly.

To check whether the unit is heating normally run the ECU in the AUTO mode with temperature control on full INCREASE. After 15 minutes use a thermometer to check the temperature differential between the discharge and inlet ducts. If incoming air is 13° plus/minus 3° warmer than the return air, the unit is working properly.

Shutdown and Reconstitution

Move mode selector switch to the OFF-RESET position.

Disconnect power cable from power distribution panel.

Disconnect power cable from the ECU.

Detach ducts from the facility and the ECU.

Open the evaporator section access door of the unit and dry out any collected condensate.

Perform the checklist inspections called for in maintenance section of the ECU technical order. Also clean the air filter and lubricate panel door hinges.

Clean exterior of unit using a cloth and cleaning solvent.

Remove, drain and dry condensate hoses. Also remove the hose connection fittings and replace the plastic protective plugs in the condensate drain holes.

Compress and secure ducts on the duct racks (figure 34) and secure duct racks inside the condenser section.

Figure 34. Duct Storage Racks.

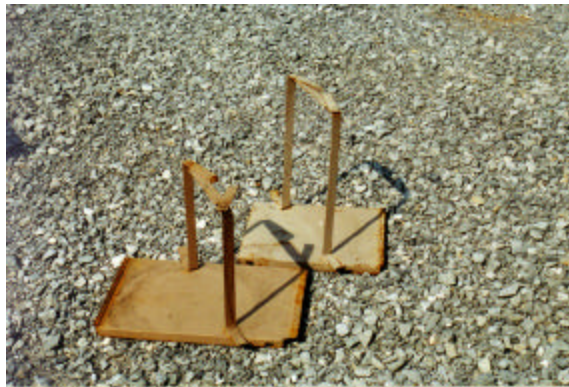

Coil up power cable and store it back in the condenser compartment access door.

Coil up condensate hoses and stow them in the condenser compartment.

Place flange covers back on the front flange adapters and seal with tape. Cover the condenser intake and outlet grilles with waterproof paper and tape. Ensure all access doors are securely closed.



150 CUBIC FOOT REFRIGERATION UNIT

Characteristics

The 150 cubic foot refrigeration unit consists of two major components—the box (figure 35) and the mechanical refrigeration equipment (figure 36). Sometimes the box and mechanical unit will be shipped already assembled. Other times the mechanical unit will be crated separately or secured inside the refrigerator box. In such cases you will have to install the equipment on the box on-site.

Figure 35. 150 Cubic Foot Refrigeration Box.



The refrigeration box has sheet metal walls, ceiling and floor filled with insulating foam. It has integral lifting rings that permit movement by crane and forklift openings in its skid base enabling movement by forklift. **Do not attempt to move the unit by lifting from the front or back.** If the unit slips on the forks, damage could be done to the door or mechanical unit. The box

weighs about 800 pounds and has a footprint of 6 feet, 6 inches by 7 feet, 4 inches. It's 6 ½-feet high. A thermometer that displays the inside box temperature is mounted on the exterior of the box adjacent to the door. Lighting inside the box is provided by a vapor-proof incandescent light. A 125-volt electrical service is required to power the interior light. This incoming power line is connected to a receptacle located to the upper left of the door. The switch for the light is mounted on a wall inside the box. Floor grating is also provided to permit ventilation of items kept in the freezer.

Figure 36. Mechanical Refrigeration Equipment.



The refrigeration unit which mounts in an opening in the back of the refrigeration box automatically maintains the inside temperature of the box between 0°F and 35°F. The unit weighs almost 750 pounds; therefore, a forklift is normally used to ease the unit into position on the refrigeration box. A 208-volt, three phase power supply is required to run the refrigeration unit; no pre-made cable is included, you will have to hard wire the unit once it is in place. The unit uses eight pounds of R-12 refrigerant as a normal charge. Its cooling capacity is rated at 5000 BTU/hr at 0°F and 7500 BTU/hr at 35°F. The unit also contains a timer and temperature sensor which control an automatic defrost feature. You may find differing models of the unit in the

field; however, their operating principles are similar. Major components of the refrigeration unit include:

Control Panel. The control panel, located on the left side of the unit (figure 37), contains an on/off switch, temperature control switch, hour meter and indicator lights for “defrost cycle” and “power on.” On the right front side of the unit are gauges (figure 38) for monitoring temperature of the inlet side of the evaporator and pressure on the suction and discharge sides of the compressor.

Figure 37. Control Panel.



Condenser Coil. The condenser coil (figure 39) serves as a heat exchanger removing heat from the compressed refrigerant vapor as it moves through the coil. The heat is transferred to outside air which is drawn in and moved over the coil by the condenser fan (figure 40).

Evaporator Coil. The evaporator coil (figure 41) removes heat from the freezer box internal air by transferring it to the refrigerant. The air is drawn in and over the evaporator coil by the evaporator fan (figure 42).

Fan Motor. The fan motor (figure 43) drives both the condenser and evaporator fans.

Figure 38. Temperature and Pressure Gauges.



Figure 39. Condenser Coil.

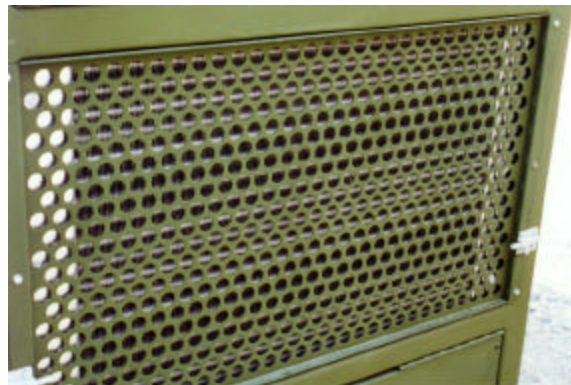

Figure 40. Condenser Fan.

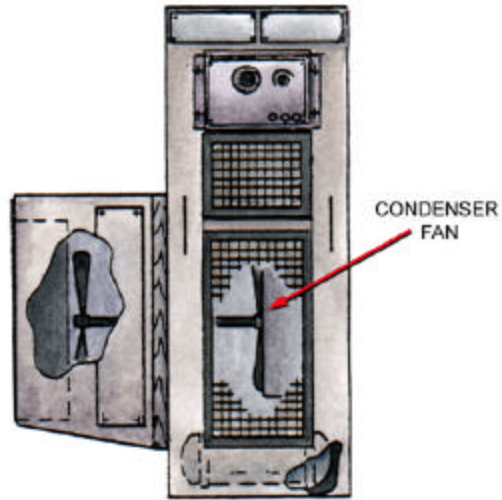

Figure 41. Evaporator Coil.



Figure 42. Evaporator Fan.

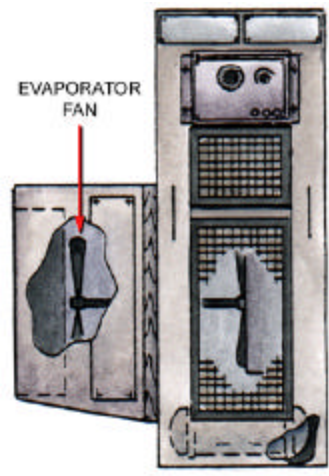
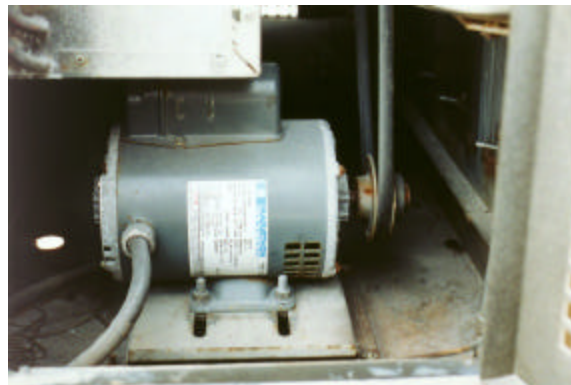
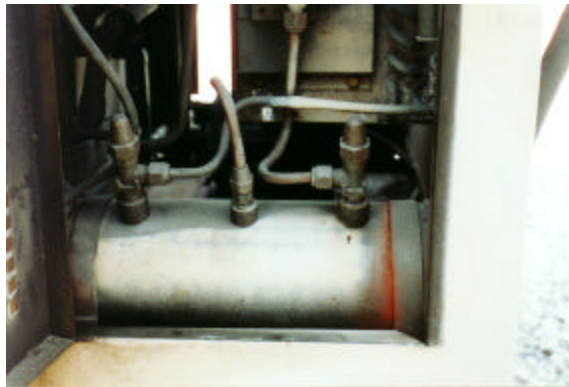

Figure 43. Fan Motor.



Receiver Tank. The receiver tank (figure 44) collects and stores liquid refrigerant.

Figure 44. Receiver Tank.

Compressor. The compressor (figure 45) compresses the refrigerant gas and pumps it through the system. It is driven by a second motor in the refrigeration unit.

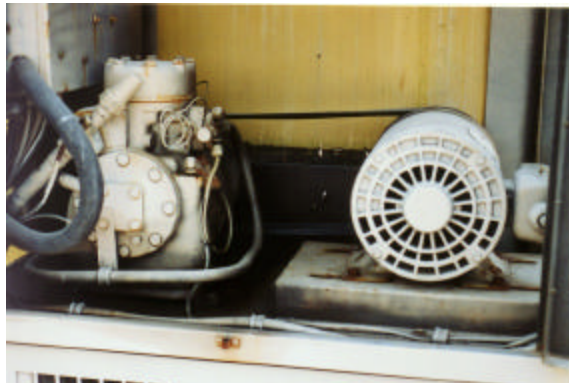
Figure 45. Compressor.

150 Cubic Foot Refrigeration Unit Set Up and Pre-Operation Preparation

The refrigeration box must be placed on a flat, level surface. A paved area or concrete pad is preferred but firm ground may also be used providing it can support footprint pressures of 250 psi. Shaded areas are desirable such as tree cover, open sheds or even camouflage netting. Shading improves the efficiency of the unit. Also critical is the need to provide open air space around the mechanical unit once it is installed in the box. **A minimum of 3 feet of clear space is required in the front of and to both sides of the condenser portion of the refrigeration unit.** Do not locate the box in an area subject to smoke or blowing dirt if at all possible. These contaminants can foul the air intake area of the condenser. Lastly, remember you must have a 208 volt, three-phase, power source nearby--avoid long power cable runs and the associated voltage drop. Once you have checked the refrigeration box for serviceability and sited it in a suitable location, install the refrigeration unit in the box as follows:

Remove the refrigeration unit from its shipping box and inspect it for any shipping damage. Pay close attention to the condition of the gasket seal (figure 46) on the back of the condenser section.

Check the wall surface around the panel opening in the back of the refrigeration box to ensure there are no irregularities.

Carefully guide the evaporator section of the refrigeration unit into the opening. If available, use a forklift for this task.

Slide the unit back until the gasket seal is uniformly in contact with the wall surface. This may take some adjustment but stick with it—a uniform seal is necessary for proper freezer operation.

From the inside of the unit slide the mounting bolts through the holes in the box wall and metal frame of the refrigeration unit.

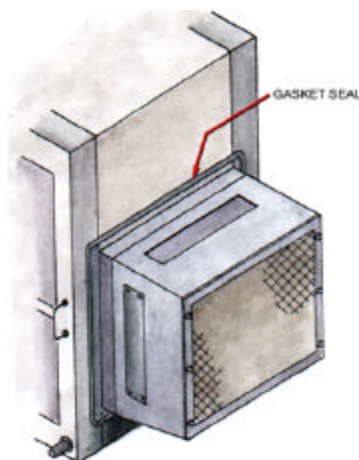
Figure 46. Condenser Section Gasket Seal.

Uniformly tighten the nuts on all four mounting bolts by turning each nut a few times in rotation around the metal frame. Tighten the nuts until you have maximum compression of the gasket seal.

With the refrigeration unit now installed in the refrigeration box, there are several additional steps that must be accomplished prior to allowing the unit to be placed into full operation. These include setting valves and the defrost timer, adjusting belts and connecting power.

Fully open the receiver inlet valve (figure 47) and tag the valve "This Valve is Open."

Fully open the receiver outlet valve (figure 47) and tag the valve "This Valve is Open."

Fully open the hot gas shut off valve (figure 47) and tag the valve "This Valve is Open."

Figure 47. Valve Locations.

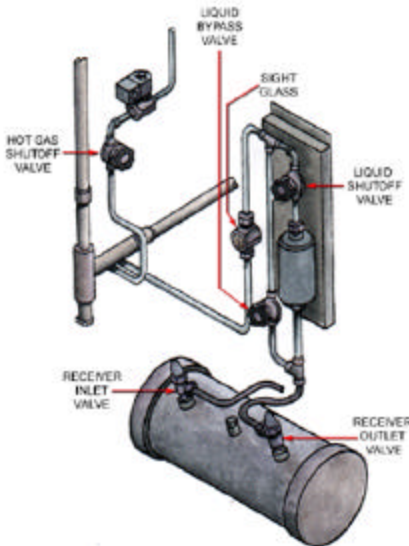

Fully open the liquid shutoff (drier service) valve (figure 47) and tag the valve “This Valve is Open.”

Fully close the liquid bypass (drier bypass) valve (figure 47) and tag the valve “This Valve is Closed.”

Backseat and crack the compressor suction service valve (located on the compressor) and tag the valve “This Valve is Backseated and Cracked.”

Backseat and crack the compressor discharge service valve (located on the compressor) and tag the valve “This Valve is Backseated and Cracked.”

Remove the front panel of the control box and set the defrost cycle timer (figure 48) to the desired time for the cycle to occur. You will resecure the front panel after power hook up is completed

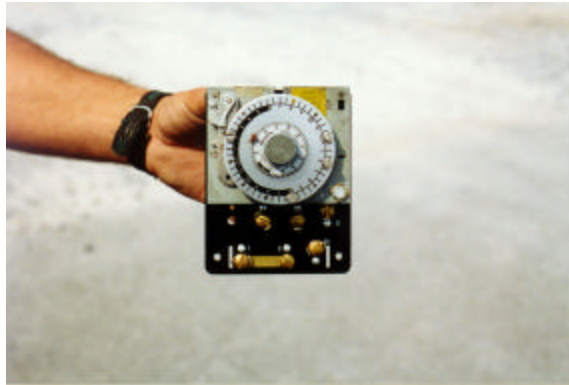
Figure 48. Defrost Cycle Timer.

Loosen the fan motor mounting bolts and slide motor so as to take up slack on the belt. Belt deflection should be $\frac{1}{2}$ inch midway between the pulleys. Tighten motor mounting bolts once proper deflection limit is met.

Set the belt tension on the compressor belts in the same manner as that used for the fan belt. Deflection remains at $\frac{1}{2}$ inch midway between the pulleys.

Obtain appropriate length of power cable. Normally you will be connecting into a power distribution panel from the Harvest Falcon or Harvest Eagle electrical distribution system. Therefore, a cannon plug-type connection will have to be on one end of the cable. The other end of the cable will be hard wired to the unit itself.

Route the end of the cable through the top of the condenser section frame and then into the control box (figure 49).

Connect the ground wire to the ground post and the three power leads to the fuse block connections. Secure control box panel cover.

Figure 49. Cable Routing.



Turn on power at the power distribution panel. Turn unit on and check rotation of motors. If motors are not turning clockwise, turn off power, reopen the control box and reverse two of the power leads (a three-phase motor must have the phases properly connected to operate and run in the proper direction).

Connect a second power cable between the power distribution panel and the receptacle on the front of the refrigeration box. This is a single phase, 125volt line.

Set the thermostat on the control box front panel to the desired temperature.

Operation

To operate the refrigeration unit, place the REFRIGERATOR ON-OFF switch on the control box to the ON position. The unit will start, stop and defrost automatically while maintaining the desired temperature as set on the thermostat. Prior to turning on the unit, however, make one last inspection of

the system. Table 3 lists those items that should be checked. Once the unit is operating, perform the checks listed in table 4.

Table 3. Pre-Operational Checks for the 150 CF Refrigeration Unit.

Verify receiver inlet valve is open and tagged
Verify receiver outlet valve is open and tagged
Verify hot gas shut off valve is open and tagged
Verify liquid shut off valve is open and tagged
Verify compressor suction valve is backseated, cracked and tagged
Verify compressor discharge valve is backseated, cracked and tagged
Verify liquid bypass valve is closed and tagged
Check panels, doors and screens for damage or missing parts
Inspect wiring for damage and loose connections
Inspect fan blades for damage
Check belts for fraying and proper deflection
Check bearings and pulleys for obvious damage
Inspect unit housing and seals for damage
Check condenser and evaporator coils for obstructions
Check tubing, valves and fittings for damage
Inspect compressor for damage and loose mountings
Check lights and switches for operability
Check electric motors for loose mountings

Table 4. Operational Checks for the 150 CF Refrigeration Unit.

Monitor fans for evidence of excessive vibration
Observe oil level in the compressor (sight glass is located on the compressor)
Monitor lights for proper functioning during operation
Check refrigerant sight glass (figure 47) for signs of moisture and low charge

Shutdown and Reconstitution

To shutdown the unit, turn the REFRIGERATOR ON-OFF switch on the control box to the OFF position.

Empty the refrigeration box completely.

Pump down the refrigeration unit—see technical order for details.

Shut off power and disconnect cable from the control box and facility distribution panel.

Loosen the compressor and fan drive belts.

Clean and dry the refrigeration unit. Touch-up paint any exposed surfaces.

Unbolt the unit from the refrigeration box wall and remove unit, if required.

Crate refrigeration unit.

Install closure plug assembly in the back wall of the refrigeration box.

Wash and dry the interior and exterior of the box.

Ensure the vapor proof internal light is secure.

Close box door and secure with padlock; attach keys to padlock.



1200 CUBIC FOOT REFRIGERATION UNIT

Characteristics

The 1200 CF refrigeration box (figure 50) is a prefabricated walk-in unit. It consists of sections of insulated floor, wall and ceiling panels that are assembled on site. The interior and exterior surfaces are embossed aluminum. The box has interior lighting and some units have a temperature gauge indicating inside temperature mounted on the doorframe. Wooden floor grating is also included. Similar to the 150 CF box, the supporting mechanical unit slides into a panel of the box and is clamped in place. Mechanical units may differ in rated size (this particular box normally uses a 10,000 BTU unit) but their operation is basically identical. Once the refrigeration box and mechanical unit are assembled, start the unit and let it run for about three hours to allow the inside temperature to stabilize. Once the inside temperature has stabilized at about 40 degrees Fahrenheit, loading of products can take place. The panel sections are heavy; plan on having a crew size of about six people to safely assemble the box.

Assembly of the 1200 Cubic Foot Refrigeration Box

The prefabricated refrigeration box is assembled as follows:

Open the shipping crate containing the box panels. Remove and stack panels in piles of like items. Panels are numbered and marked as to their type. Check the enclosed assembly drawings for layout and assembly details; sometimes you will find instructions illustrated on the back of the refrigeration box door.

Figure 50. 1200 Cubic Foot Refrigeration Box.



Lay out floor panels (normally called screeds) (figure 51) according to the layout drawing. **Be sure the site you have selected is level or you will likely encounter difficulties during the assembly process.**

Figure 51. Floor Screed Section.



Secure floor screeds together using the built-in locking mechanisms (figure 52) and apply a sealer between all the screed joints. For short-term operations (say less than 30 days), duct tape will work; for longer term operations, use a silicon sealer.

Figure 52. Floor, Wall and Ceiling Locking Mechanisms.



Set one of the vertical corner panels (figure 53) in place on the floor screeds. Be sure the number of the corner panel matches the number shown on the assembly drawings.

Place one of the vertical wall panels (figure 53) adjacent to the corner panel and fasten the two panels together. Turning the locking mechanisms one-quarter turn clockwise does this. Do not turn the locking mechanisms any further; you will tighten them further later when you fully lock all the panels together.

Continue connecting wall and corner panels together until the entire box is built.

Figure 53. Wall and Corner Panels.



Adjust the panels so they are properly positioned around the perimeter of the floor screeds. Starting at the wall panel with the door opening, fasten all the vertical panels to the floor and lock in place by turning the locking mechanisms an additional one quarter of a turn. Also fully lock all the vertical sections themselves together at this time.

If included, hang the rain shield over the refrigeration box door area.

Set all ceiling panels in place on top of the wall sections (figure 54) and lock them together.

Align the ceiling with the box walls and lock the ceiling into place.

Seal all interior and exterior joints with tape or silicon sealer as appropriate. Insert plug buttons into each locking mechanism wrench hole.

Hang refrigerator door on the hinges on the door panel.

Place the wooden grates on the floor of the unit.

Figure 54. Ceiling Panels.



MOBILE WATER CHILLER

Characteristics

The mobile water chiller (figure 55) is used to provide chilled water to personnel normally working at remote locations throughout the base. It is usually attached to a 400-gallon water trailer for mobility purposes, but can also support small stationary fabric tanks. The chiller is capable of cooling 120°F intake water down to about 60°F at a rate of 40-gallons per hour. The refrigeration system and water pump are driven by an air-cooled, gasoline-powered engine. The engine can be started using a 12-volt power source or manually started using a pull rope. Weighing 315 pounds, the chiller is 34 inches long, 26 inches wide and 24 inches high. The refrigeration system on the unit requires 3.75 pounds of R-12 refrigerant for a full charge.

Figure 55. Mobile Water Chiller.



Two kits come with the water chiller—a mounting kit and a support kit. The mounting kit provides the necessary hardware to attach the chiller to a water trailer and supplies a small number of various fittings. The support kit (figure 56) includes a muffler, fuel line, dispensing nozzle, strainer assembly, starter rope and lengths of tubing. The mobile water chiller has several major components and three major subsystems

Water System. The water system basically consists of a storage container (e.g. water buffalo), connecting hoses, pump, heat exchanger and two valves—the blending valve and the start-run valve. The chiller's evaporator acts as the interface between the water system and the refrigerant system. The pump draws water from the storage tank, circulates it through the evaporator where it is cooled, through the heat exchanger to cool the engine fuel, and finally to the dispensing nozzle or back to the storage tank depending upon whether dispensing or recirculating is being accomplished.

Figure 56. Support Kit Items.



Refrigerant System. The major parts of the refrigerant system include the compressor, condenser coil, condenser fan and evaporator. The compressed R-12 refrigerant passes through the condenser where it is liquefied. Heat from this process is dissipated by the condenser fan blowing over the condenser coil. The liquid refrigerant then passes through the evaporator where it picks up heat from the water in the water system and then flows back to the compressor.

Power System. The power system is basically an internal combustion engine. The engine is controlled by pressure and temperature switches that will shut down the operation of the engine if water fails to flow or is cooled sufficiently, or pressure problems develop in the refrigerant system.

Water Chiller Set Up

Set up of the mobile water chiller is a relatively straightforward process. Perform the following steps:

Open the top door of the chiller and attach the exhaust pipe to the engine exhaust port.

Remove shipping plugs from water line connections marked COOL RECIRCULATE, COOL DISPENSE and WARM IN (figure 57). Make sure there are no dirt particles or foreign objects in the openings.

Install three of the hoses from the support kit to the openings on the chiller (figure 58). Connect the free end of the WARM IN hose to the strainer assembly. The arrow on the strainer assembly should point toward the chiller; this arrow denotes the direction of flow. Connect one end of the fourth hose to the other end of the strainer assembly and the other end of the fourth hose to the water source.

Figure 57. Chiller Hose Connections Points.

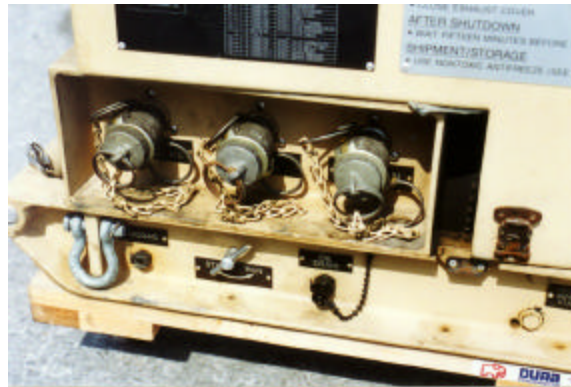

Figure 58. Hose Connections.



Route the free end of the COOL RECIRCULATE hose back to the water source.

Attach the dispensing nozzle to the free end of the COOL DISPENSE hose (figure 58).

Screw can adapter and fuel hose into the fuel supply can. When using a water trailer as the storage tank, 5-gallon jerry cans are commonly used for fuel containers. Connect the other end of the fuel hose to the quick-disconnect fuel fitting on the chiller (figure 59). Field experience has indicated the chiller will operate 6-8 hours on a tank of fuel.

Figure 59. Quick-Disconnect Fuel Fitting.



Operation

Operation of the chiller is not difficult; however, there are some basic checks that need to be made prior to using the unit. See Table 5. Also before using the chiller for the first time or after repairs have been made, the chiller must be purged with disinfectant to get rid of impurities.

Table 5. Water Chiller Pre-Operational Checks.

Check housing for damage and cleanliness
Check to ensure choke control moves properly
Ensure muffler is securely attached to the gasoline engine
Check fan for damage and tightness
Inspect hoses for leaks
Check oil in gasoline engine
Ensure START RUN water control switch works properly
Check for cracks and broken welds in skids
Inspect trailer mounting hardware for tightness
Check fuel line for leaks and damage
Check fuel level in gasoline engine
Check potable water supply level

Disinfecting.

To purge the system perform the following steps:

Fill two 5-gallon pails with water. Add 0.1 ounce of calcium hypochlorite powder to each pail and stir each with a wooden paddle until the powder is completely dissolved.

Disconnect WARM IN hose from the strainer assembly and place it in one of the pails of disinfectant solution.

Remove COOL RECIRCULATE hose from water source connection and place it in an empty 5-gallon pail (waste container).

Start the water chiller (see starting instructions below).

With engine running, and water flowing from the COOL RECIRCULATE hose, place the START RUN water control (figure 60) in RUN position.

Figure 60. START RUN Water Control.



Run the chlorine solution through the water system until depleted. Open the nozzle on the dispensing hose periodically and dispense the chlorine solution until both pails of chlorine solution are empty.

Hold the toggle switch (figure 61) in the STOP position until engine stops.

Remove the WARM IN hose from the pail and reconnect it to the strainer assembly.

Start engine once again and flush the system with potable water discharging water from the COOL DISPENSE hose into a waste container.

Reconnect the COOL RECIRCULATE hose to the water source connection.

Figure 61. Toggle Switch, Choke, Pneumatic Timer Switch, and Starter Button.

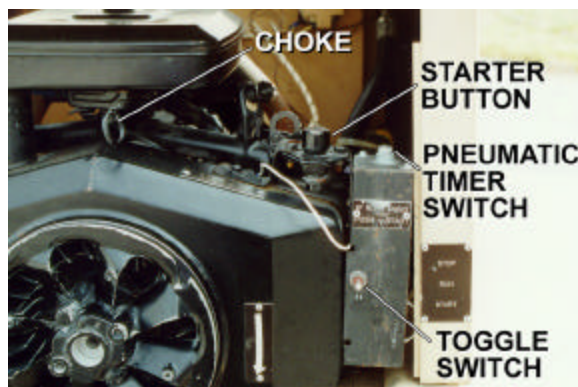

Startup.

Once the chiller has been disinfected, start up for normal operations can be accomplished. Perform the following steps:

Place START RUN water control in START position.

Open end door and pull out choke (figure 61) on gasoline engine. Once engine is running steadily choke can be pushed back in.

Pump bulb in fuel line until pressure is felt.

Wrap starter rope around flywheel pulley. Push pneumatic timer switch (figure 61) and pull rope to start the engine.

The chiller can also be started using a 12-volt power source. Plug the power source cable into the 12 VOLT INPUT FOR STARTING connection (figure 62).

Hold the toggle switch (figure 61) in the START position and push the starter button (figure 61) to start engine.

Open dispenser nozzle. When there are few or no air bubbles in the water coming from the hose, place the START RUN water control in the RUN position.

If the 12-volt source was used, disconnect the power cable once the engine has started.

Chiller will operate until water in the storage tank is sufficiently cooled or tank is emptied. When either of these conditions are reached, the chiller will automatically shut down.

Figure 62. 12 VOLT INPUT FOR STARTING Connection.

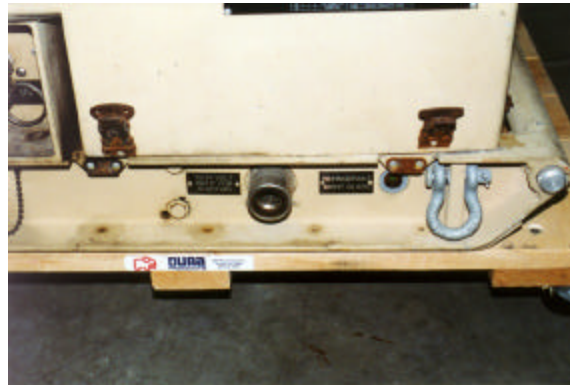

Once the chiller is operating there are several items that should be monitored. These are highlighted in table 6.

Table 6. Operational Checks for the Water Chiller.

Check grilles for dirt and debris
Monitor muffler for tightness and exhaust leaks
Inspect hoses for leaks and chafing
Check sight glass (next to power connection) for clear, bubble-free refrigerant
Monitor fuel level
Monitor water supply level

Shutdown and Reconstitution

Shutdown of the chiller is accomplished by holding the toggle switch in the STOP position until the engine stops. The START RUN water control is then placed in the START position.

To reconstitute the unit perform the above shutdown procedures plus the following steps:

Spray the kit bags with insecticide prior to storing components.

Allow the muffler to cool, disconnect it from the chiller and put it in the support kit bag.

Close and latch the top and side doors.

Disconnect fuel hose from water chiller and fuel supply container. Drain the hose and place in kit bag after it is dry.

Disconnect and drain all water hoses. Place hoses in kit bag when dry.

Drain and dry strainer assembly and nozzle. Place in kit bag when dry.

Install shipping plugs in hose connection points on chiller.

JOHN W. HANDY, Lt General, USAF
DCS/Installations & Logistics

