

## Applications to Gas Turbines – Health Monitoring

**Mehran Mehregany**

Department of Electrical Engineering and Computer Science  
Case Western Reserve University  
Cleveland, Ohio 44106  
USA

Tel: 216 368 0755

E-mail: [mxm31@cwru.edu](mailto:mxm31@cwru.edu)

### **ABSTRACT**

*The gas-turbine engine has been the focus of intense research since the first Whittle design in 1937. Although it has evolved into a very efficient source of power many areas remain open for advances. Many such advances however require instrumentation for monitoring and controlling transient phenomena. In particular, instrumentation needs are for distributed phenomena across the system, subsystems, components, ... , which require spatially fine resolution at the local points. Microelectromechanical systems (MEMS) is a natural enabling technology to meet these instrumentation challenges. MEMS enable the development of smart systems by augmenting the computational ability of microelectronics with the perception and control capabilities of microsensors and microactuators.*

*The lecture will provide a review of instrumentation needs in gas turbine engine development where MEMS technology has been, is being, or is envisioned to be pursued. In the context of these pursuits, the specific MEMS research and development will be highlighted. The instrumentation (e.g., sensors, actuators, and control circuits) for the gas turbine applications must operate in high temperature environments compared to more pedestrian applications (i.e., in addition to many other harsh environment factors in a gas turbine engine). SiC MEMS technology holds great promise for applications which are characterized by presence of harsh environments (e.g., high temperatures, large number of vibrational cycles, erosive flows, and corrosive media). The lecture will introduce and review the state of SiC MEMS technology in the context of gas turbine engine instrumentation needs.*

### **BIOGRAPHY**

Mehran Mehregany received his B.S. in Electrical Engineering from the University of Missouri in 1984, and his M.S. and Ph.D. in Electrical Engineering from Massachusetts Institute of Technology in 1986 and 1990, respectively. From 1986 to 1990, he was a consultant to the Robotic Systems Research Department at AT&T Bell Laboratories, where he was a key contributor to ground-breaking research in microelectromechanical systems (MEMS). In 1990, he joined the Department of Electrical Engineering and Applied Physics at Case Western Reserve University as an Assistant Professor. He was awarded the Nord Assistant Professorship in 1991, was promoted to Associate Professor with tenure in July 1994, and was promoted to Full Professor in July 1997. He held the George S. Dively Professor of Engineering Endowed Chair from January 1998 until July 2000, when he was appointed the BFGoodrich Professor of Engineering

*Paper presented at the RTO AVT Lecture Series on “MEMS Aerospace Applications”, held in Montreal, Canada, 3-4 October 2002; Ankara, Turkey, 24-25 February 2003; Brussels, Belgium, 27-28 February 2003; Monterey, CA, USA, 3-4 March 2003, and published in RTO-EN-AVT-105.*

# Report Documentation Page

*Form Approved  
OMB No. 0704-0188*

Public reporting burden for the collection of information is estimated to average 1 hour per response, including the time for reviewing instructions, searching existing data sources, gathering and maintaining the data needed, and completing and reviewing the collection of information. Send comments regarding this burden estimate or any other aspect of this collection of information, including suggestions for reducing this burden, to Washington Headquarters Services, Directorate for Information Operations and Reports, 1215 Jefferson Davis Highway, Suite 1204, Arlington VA 22202-4302. Respondents should be aware that notwithstanding any other provision of law, no person shall be subject to a penalty for failing to comply with a collection of information if it does not display a currently valid OMB control number.

1. REPORT DATE <b>00 FEB 2004</b>	2. REPORT TYPE <b>N/A</b>	3. DATES COVERED <b>-</b>	
4. TITLE AND SUBTITLE <b>Applications to Gas Turbines Health Monitoring</b>		5a. CONTRACT NUMBER	
		5b. GRANT NUMBER	
		5c. PROGRAM ELEMENT NUMBER	
6. AUTHOR(S)		5d. PROJECT NUMBER	
		5e. TASK NUMBER	
		5f. WORK UNIT NUMBER	
7. PERFORMING ORGANIZATION NAME(S) AND ADDRESS(ES) <b>Department of Electrical Engineering and Computer Science Case Western Reserve University Cleveland, Ohio 44106 USA</b>		8. PERFORMING ORGANIZATION REPORT NUMBER	
9. SPONSORING/MONITORING AGENCY NAME(S) AND ADDRESS(ES)		10. SPONSOR/MONITOR'S ACRONYM(S)	
		11. SPONSOR/MONITOR'S REPORT NUMBER(S)	
12. DISTRIBUTION/AVAILABILITY STATEMENT <b>Approved for public release, distribution unlimited</b>			
13. SUPPLEMENTARY NOTES <b>See also ADM001658., The original document contains color images.</b>			
14. ABSTRACT			
15. SUBJECT TERMS			
16. SECURITY CLASSIFICATION OF:			17. LIMITATION OF ABSTRACT
a. REPORT <b>unclassified</b>	b. ABSTRACT <b>unclassified</b>	c. THIS PAGE <b>unclassified</b>	
			<b>SAR</b>
			<b>50</b>
			19a. NAME OF RESPONSIBLE PERSON

## **Applications to Gas Turbines – Health Monitoring**

---

Innovation. He served as the Director of the MEMS Research Center at CWRU from July 1995 until July 2000. Professor Mehregany is well known for his research in the area of MEMS, and his work has been widely covered by domestic and foreign media. He has over 200 publications describing his work, holds 12 U.S. patents, and is the recipient of a number of awards/honors. He served as the Editor-in-Chief of the Journal of Micromechanics and Microengineering from January 1996 to December 1997, and is Assistant-to-the-President of the Transducers Research Foundation. His research interests include silicon and silicon carbide MEMS, micromachining and microfabrication technologies, materials and modeling issues related to MEMS and IC technologies, and MEMS packaging.

Mehran Mehregany is the Founder and served as the President (July 1993 to March 1999) of Advanced Micromachines Incorporated (Cleveland, Ohio), a company in the MEMS area. Advanced Micromachines Incorporated was acquired by The BFGoodrich Corporation in March 1999. He founded NineSigma, Inc., an information technology company, in February 2000 and served as its CEO (June 2000 to January 2001) and CTO (January 2001 to August 2001), during which period he successfully completed initial rounds of private financing and grew the company to 15 employees. He co-founded FiberLead, Inc., an optical telecommunications company, in September 2000 and served as its CEO until September 2001, during which period he successfully completed the early stage round of venture capital financing and grew the company to 5 employees.



# Applications to Gas Turbines – Health Monitoring

**Mehran Mehregany**

*BFGoodrich Professor of Engineering Innovation*

*Dept. of Electrical Engineering*

*Case Western Reserve University*

*Cleveland, OH 44106*

**This slide has been deliberately left blank**

---

**Diapositive intentionnellement blanche**

# Aerospace Systems

**BFG systems, components and services help virtually every aircraft made travel the globe safely and reliably, and are helping us explore new frontiers in space.**

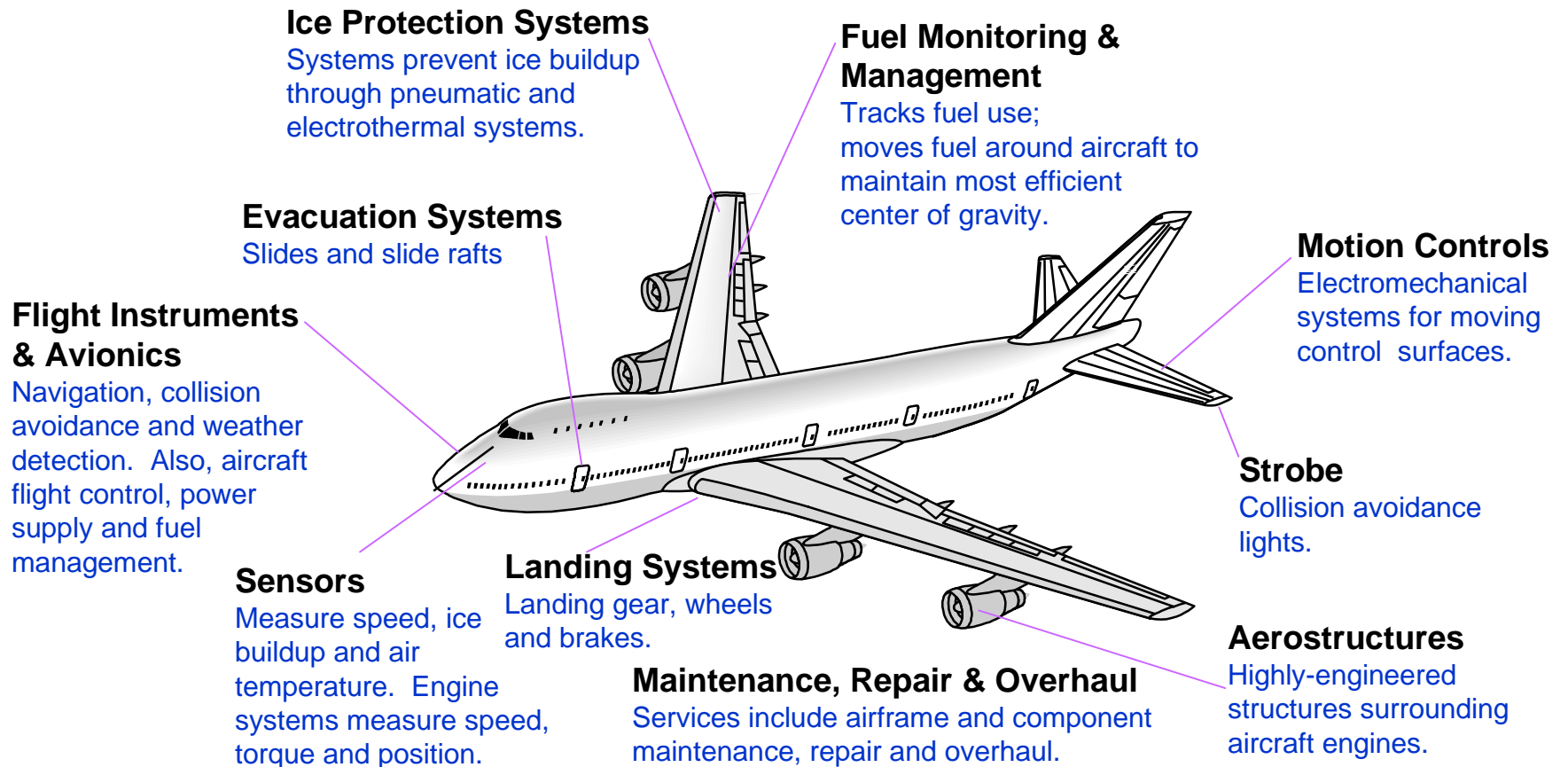



## Notes for Slide 2

The next big technology for Sensors is clearly MEMS.  
Automotive, Telecom, and Medical industries are already significant users - \$3B market for MEMS in '98.  
Projection for 2002 is \$6B.

Aerospace has begun to embrace MEMS  
Allied (Inertial), Honeywell (pressure & guidance) and several others.  
However, no incumbent has established a strong position.  
Each has quite narrow capability.

MEMS in Large Volumes are far cheaper per device than conventional  
But trend is to use many MORE sensors per vehicle, engine, appliance to provide "SMART" (higher value) end product.

# Applications to Gas Turbines



- High-temperature devices for gas turbine, as well as internal combustion and space propulsion, engines
  - in-situ pressure, flow, vibration, strain, crack detection, ... sensors
  - gas sensors for hydrocarbons and Nox
  - active fuel control

# Why SiC for MEMS?



*Material properties that make it well suited for harsh environment applications.*

- High Melting Temp.*    High Temp Transducer Elements
  - »» *High temp sensor diaphragms and resonators*
- Large Band Gap*    High Temperature Electronics
  - »» *Sensors for smart engines*
  - »» *On-chip signal conditioning*
- Low Wear and High Hardness*    Enhanced Durability/Operation
  - »» *Coated mechanical contacts*
  - »» *Microfabricated bearings*
- Chemically Inert*    Stable in harsh environments
  - »» *Valves/pumps for corrosives*
  - »» *Flow sensors for acids*

# Fuel Atomizers

## Motivation

- Achieve precise geometries using micromachining technology
- Reduce cost through batch fabrication

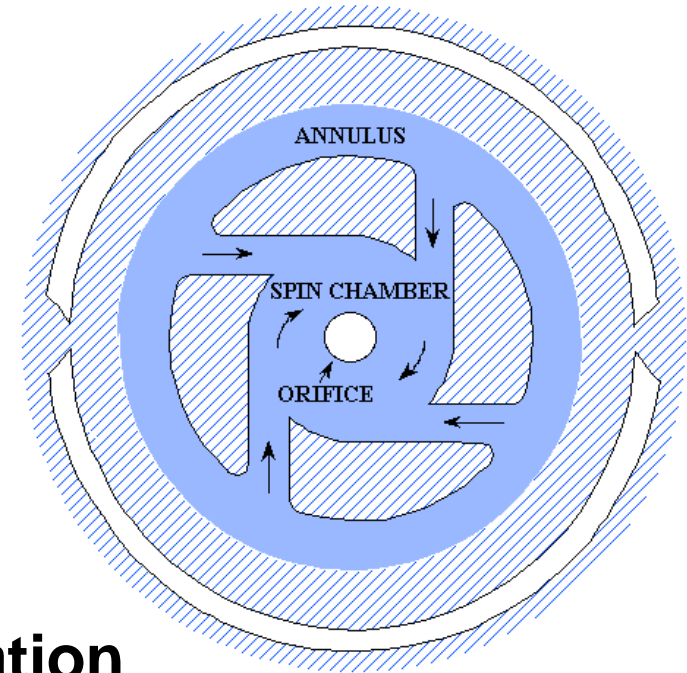
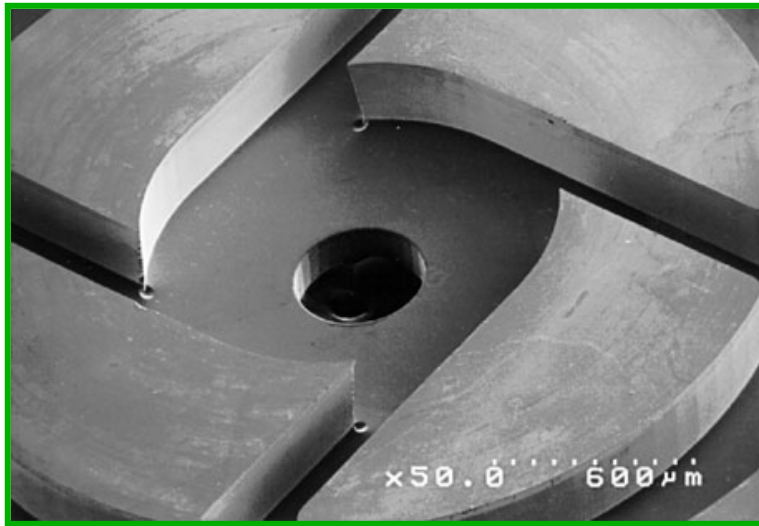

## Operation

- Fuel enters the spin chamber through tangential slots
- Fuel swirls in the spin chamber and exits through the orifice in a hollow conical spray
- Swirling produces sprays with wider spray angles as compared to plain orifice atomizers

# Motivation

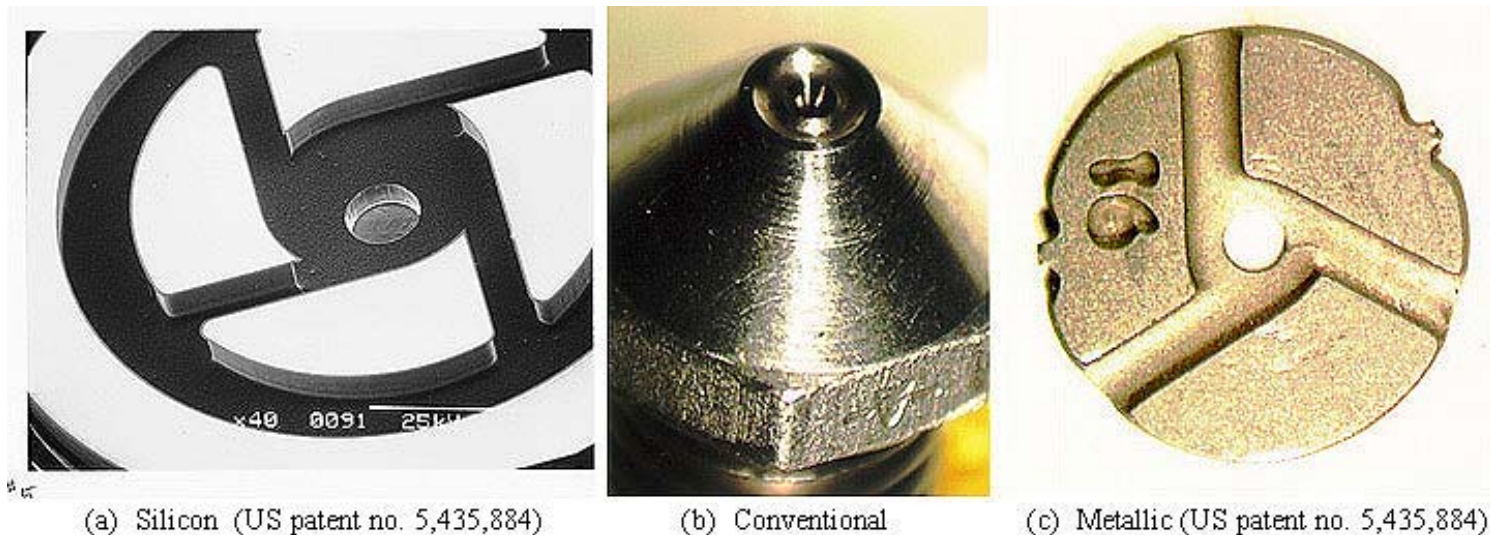

- Conventional, metallic, and silicon atomizers of approximately the same flow capacity are compared
- Silicon atomizer produces much smaller droplets at lower pressures and maintains an acceptable angle over a wide range of fuel injection pressures
- An erosion test shows the silicon atomizer to lack the erosion resistance of a conventional atomizer

# Silicon not Acceptable!

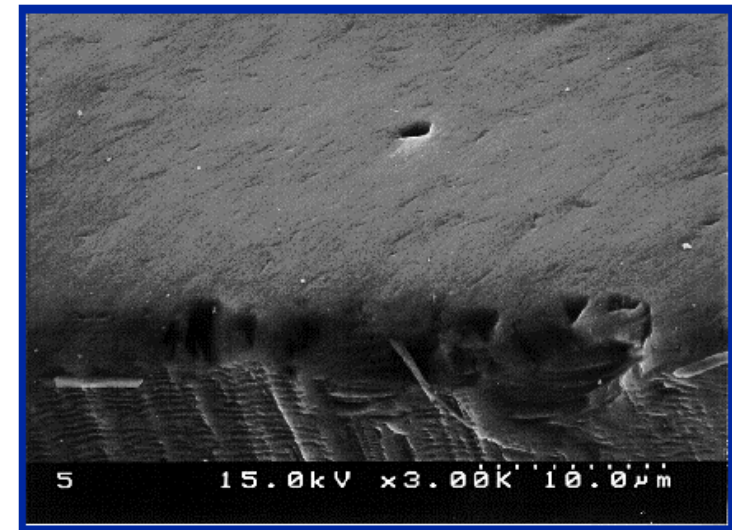
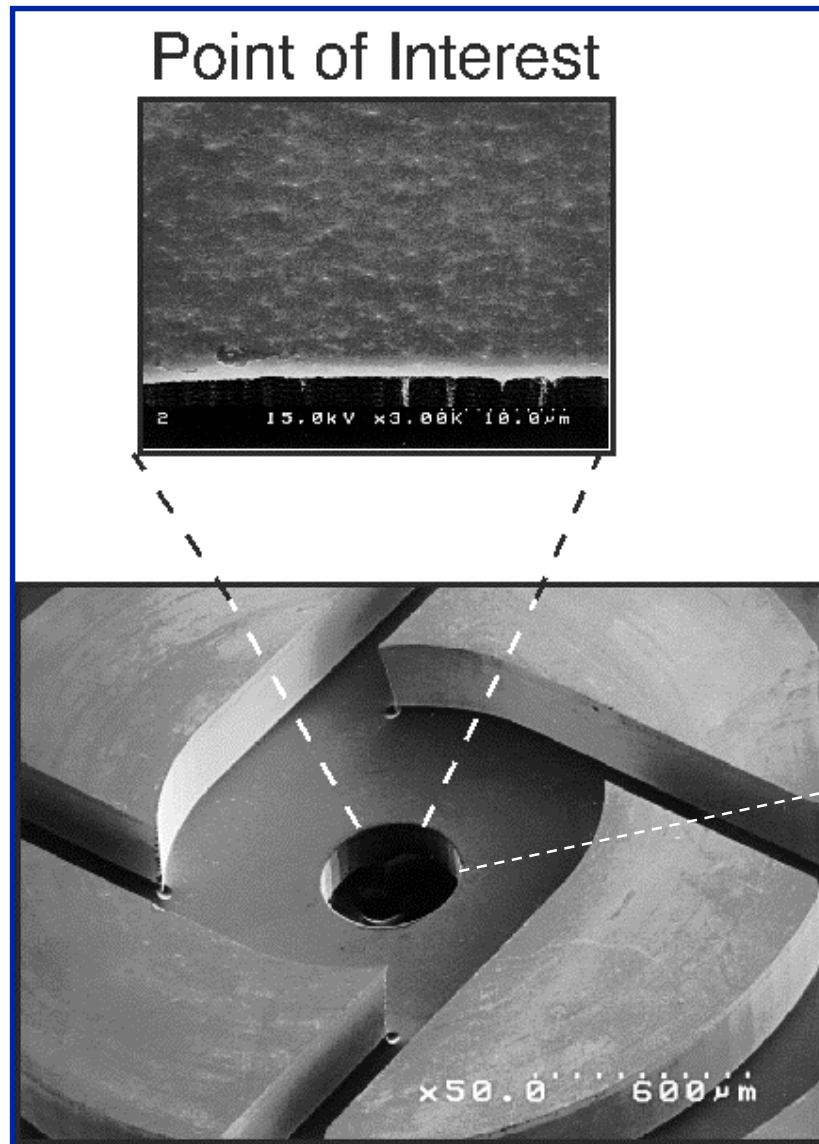

**SEM photo of edge after erosion**

**Point of highest wear occurs at the edge of the exit orifice. The rest of the swirl chamber floor is largely unaffected.**

# Protective Coatings?



- **Conventional Thin-film Coatings**

- Silicon nitride, silicon dioxide, and DLC were tested as coating materials to improve erosion resistance.
- Some improvement was observed over uncoated atomizers, but the coatings were still subject to erosion.

- **Silicon Carbide Thin-film Coating**

- Coatings were impervious to the erosion test in both single-crystal and polycrystalline form.
- Concern remained regarding the temperature limitations of the underlying Si substrate, as well as possible coating delamination due to thermal cycling.

# SiC and Ni Atomizers



- **Silicon Carbide**

- High temperature
- High wear resistance
- Chemically inert

- **Nickel**

- High temperature
- Used in aerospace applications

# Fabrication - Ni

- Atomizers were fabricated using the LIGAMUMPs process offered by MCNC.
- Devices were fabricated in two halves
  - **First half of the device contained the exit orifice**
  - **Second half of the device contained the annulus, swirl chamber and inlet slots**
- Ni was electroplated in PMMA molds to a thickness of 200  $\mu\text{m}$

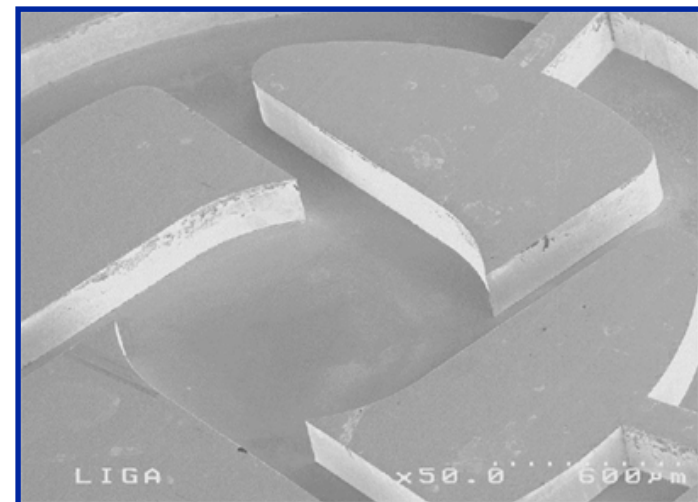
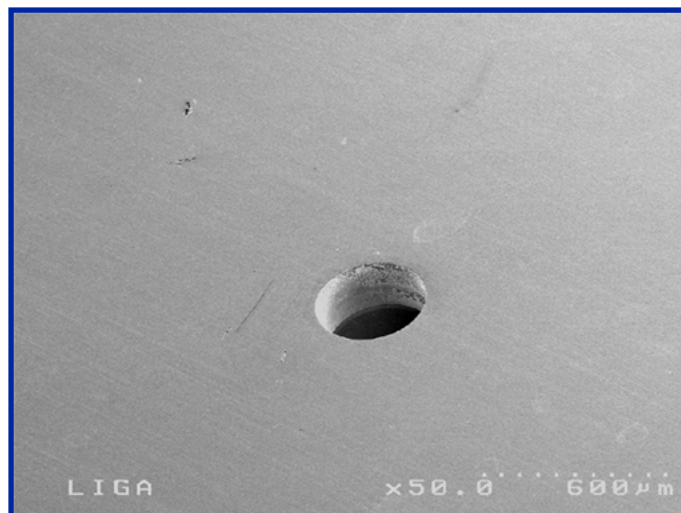

# Fabrication - SiC

- Atomizers were fabricated using a novel molding process
- Molds were fabricated out of a 500  $\mu\text{m}$ -thick silicon substrate using deep reactive ion etching (DRIE)

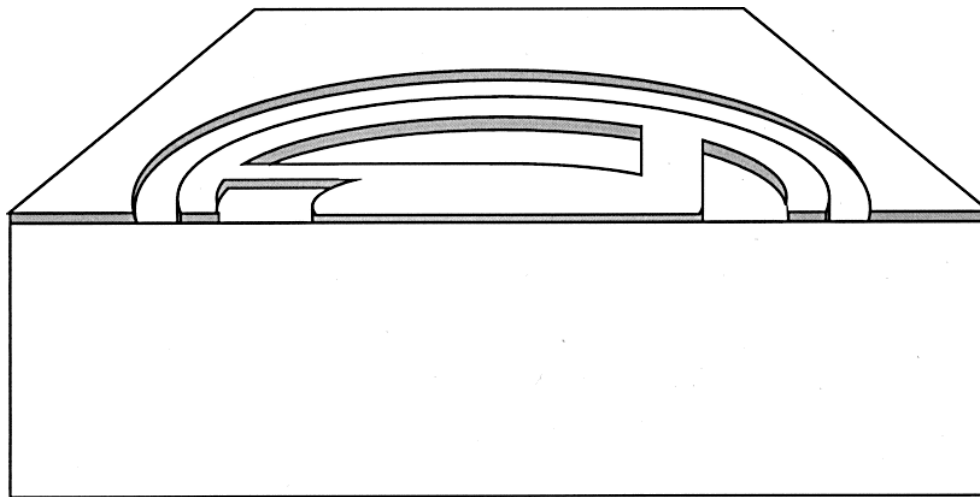

**Step 1: Grow 1.5  $\mu\text{m}$ -thick oxide and pattern**

# Fabrication - SiC

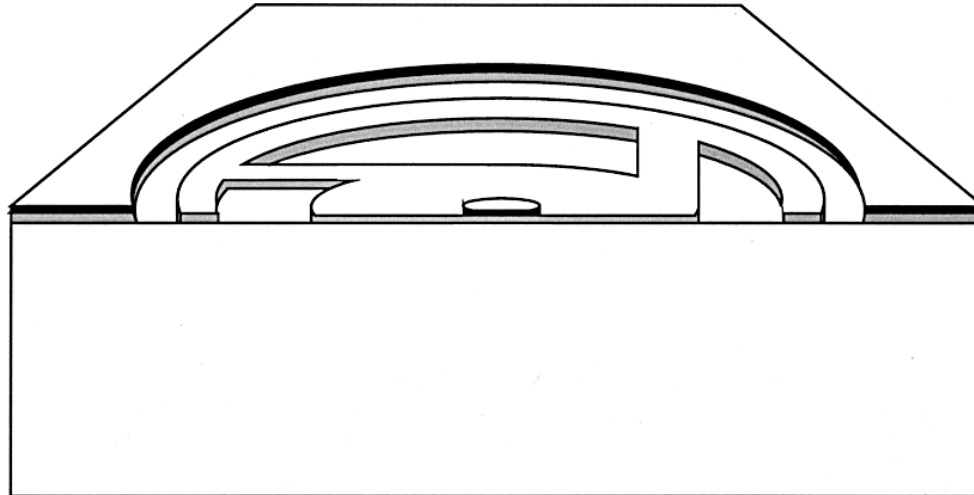

**Step 2: Spin on thick resist and pattern**

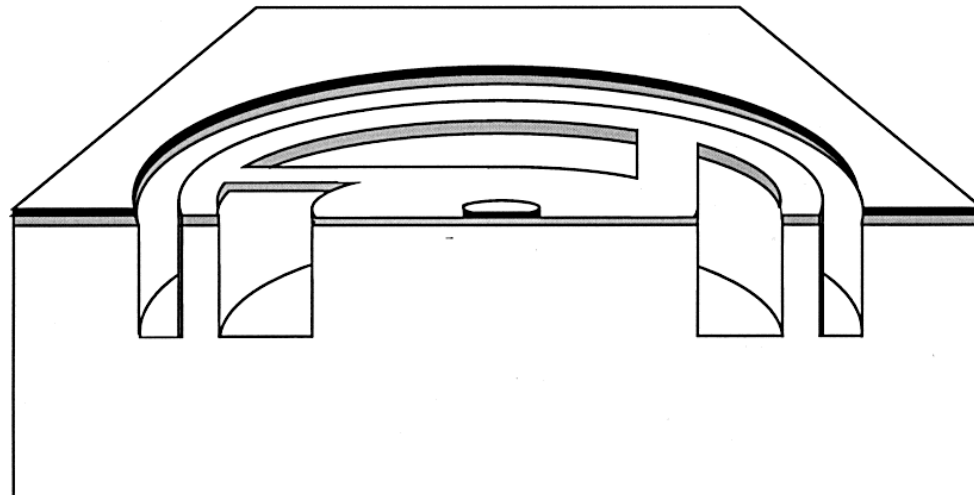

**Step 3: Perform first 275  $\mu\text{m}$  DRIE etch**

# Fabrication - SiC

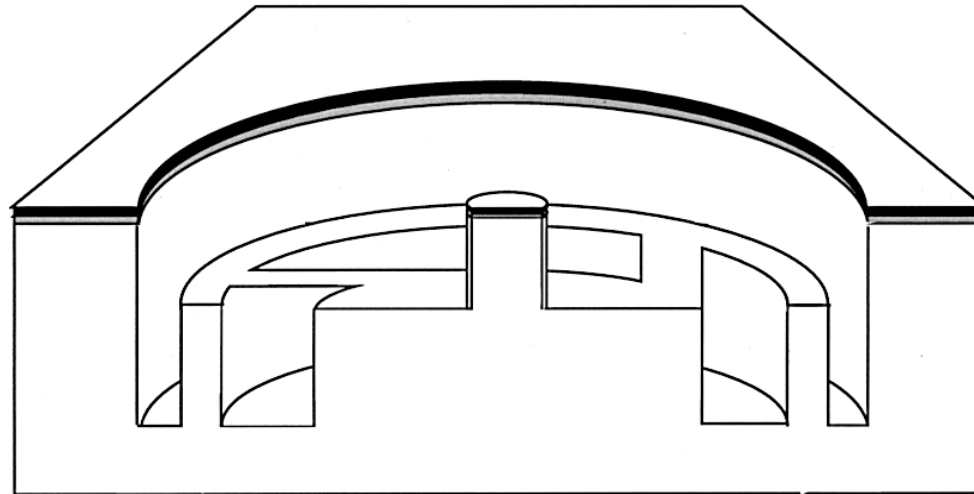

**Step 4: Remove oxide and DRIE etch for an additional 125  $\mu\text{m}$**

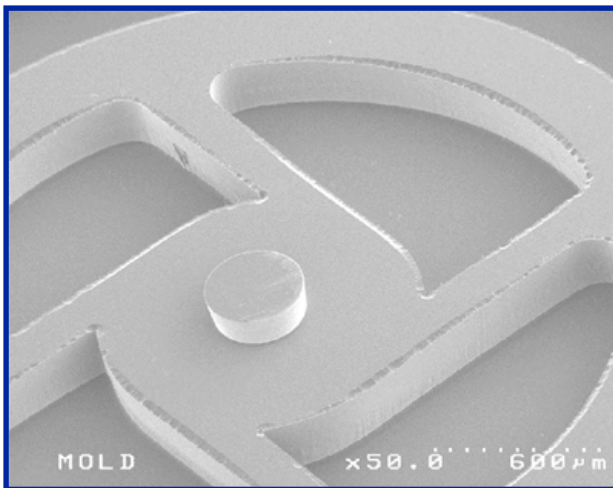

- At this stage, the mold is complete and ready for filling with SiC
- The mold etching can be optimized to deliver precision to the most critical components

# Fabrication - SiC

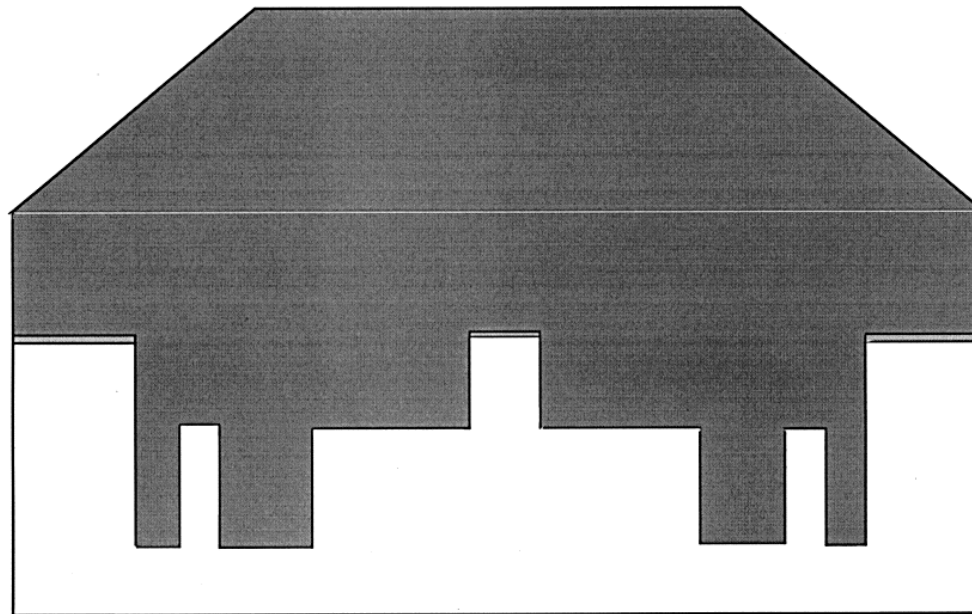

## Step 5: Remove resist and deposit 400 $\mu\text{m}$ of SiC

- Deposition of SiC occurs in a high-rate CVD reactor using methyltrichlorosilane (MTS) at 1200C
- Deposition occurs in both the mold and the field areas and the SiC must be removed from the field before release

# Fabrication - SiC

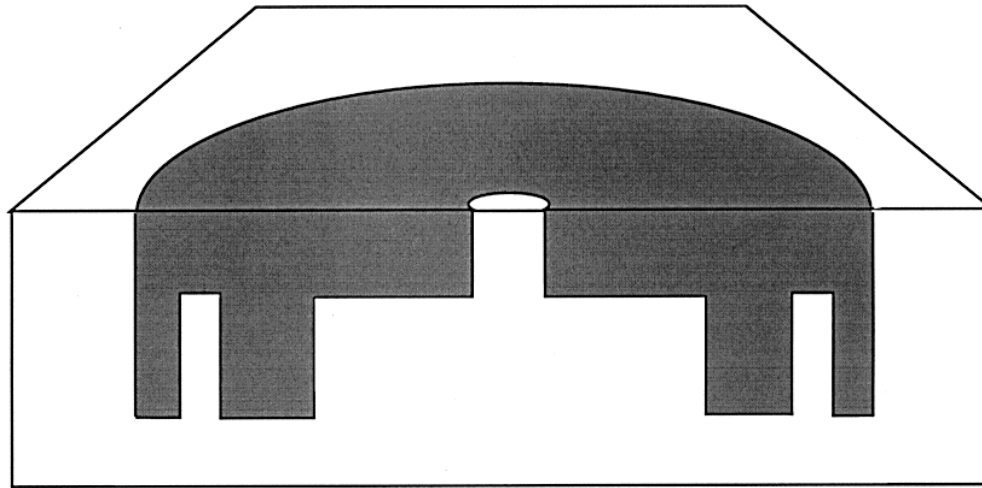

## Step 6: Lap and polish excess SiC and release

- Lapping of excess SiC is performed using a 15  $\mu\text{m}$  polycrystalline diamond suspension, and the final polishing step is performed using a 1  $\mu\text{m}$  polycrystalline diamond suspension.
- Mold is dissolved in KOH, releasing the SiC atomizer

# Fabrication Results - SiC

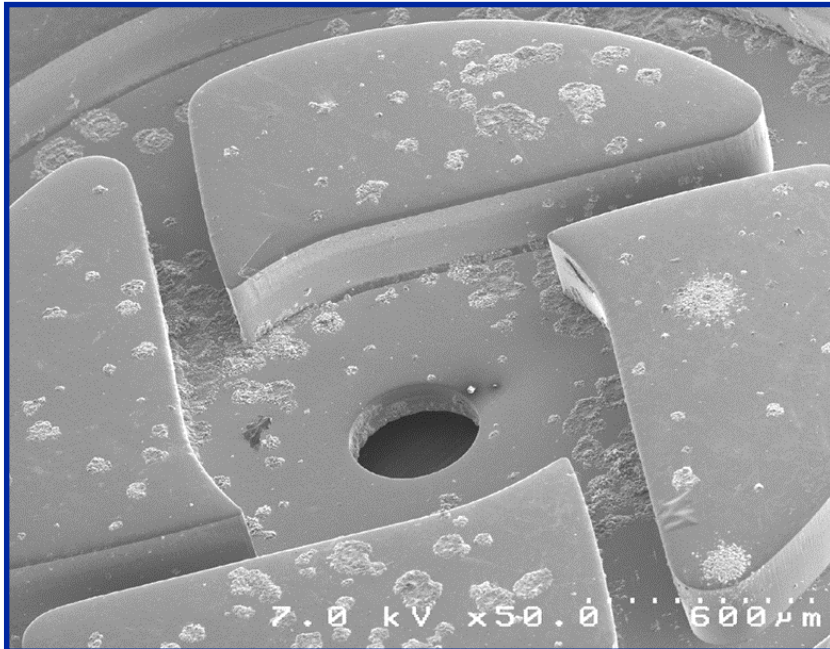

- Irregular surface morphology was noticed after release from the mold
- Energy dispersive spectroscopy (EDS) was performed to determine if this was due to contamination in the deposition step

- It has been observed that depositing SiC on a Si substrate sometimes leads to void formation on the substrate
- The SiC protrusions are in the areas where this type of substrate pitting has occurred

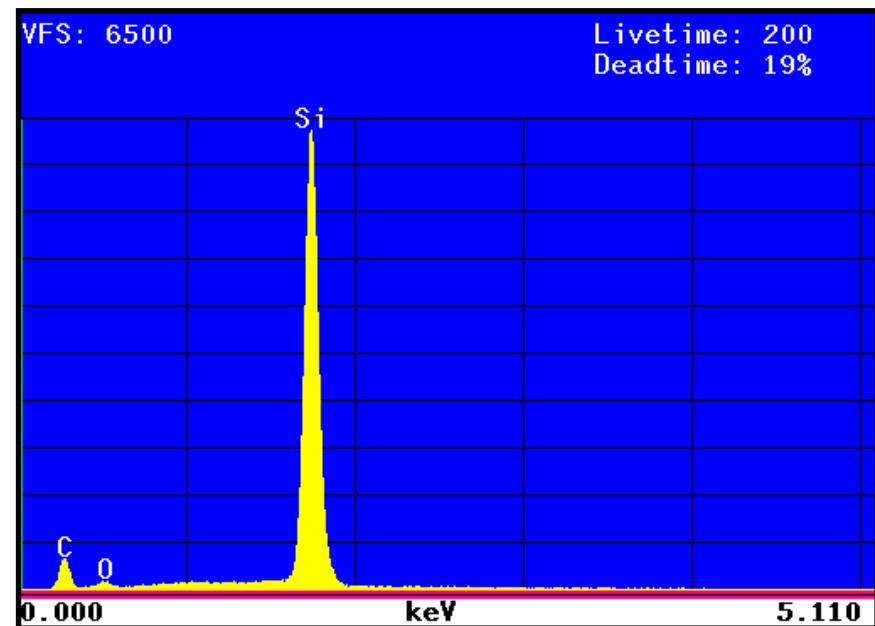

# Performance Test

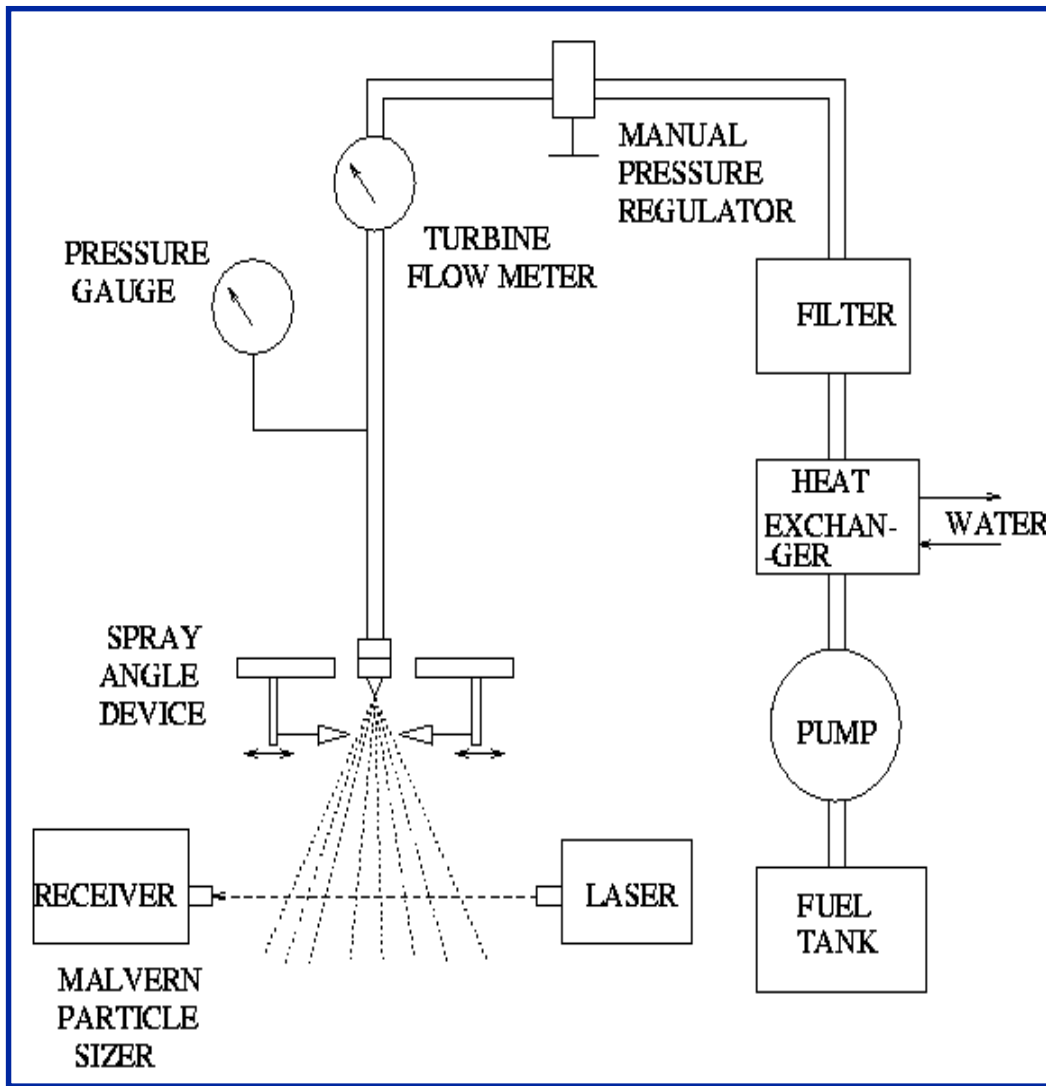

Following parameters were measured:

- Fuel flow in lbs/hr (PPH) using a turbine flow meter.
- Spray angle in degrees.

# Performance Test Results



- **SiC Atomizers**

- Average flow rate was 9 PPH at 100 psi with no adverse effect from the irregular surface morphology.
- Devices were able to consistently spray at pressures in excess of 350 psi despite having swirl chamber floor thicknesses of 60-75  $\mu\text{m}$ . Silicon micromachined atomizers have typical floor thicknesses of 125  $\mu\text{m}$  and a maximum spray pressure of 200 psi.

- **Ni Atomizers**

- Average flow rate was 7 PPH at 100 psi with spray angles comparable to a silicon atomizer.
- Lower flow rate attributed to longer exit orifice (200  $\mu\text{m}$ ), which was a restriction imposed by the MCNC thick LIGA process.

# Erosion Test

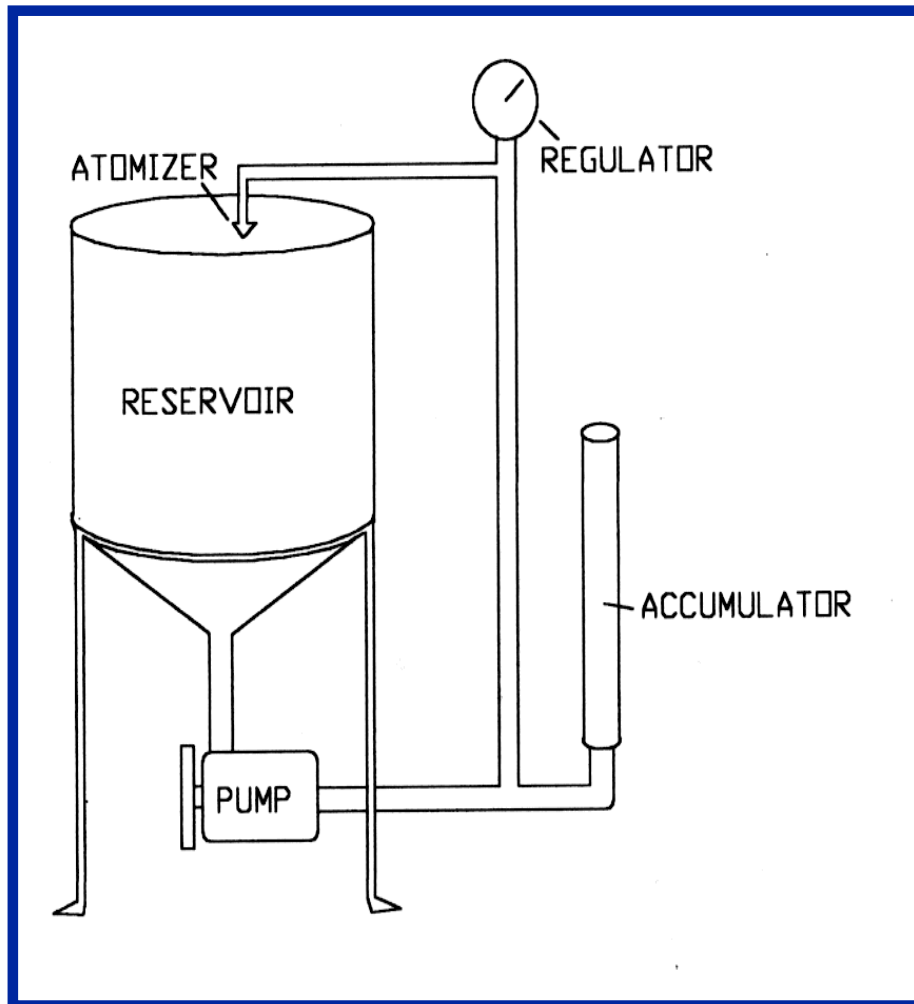

## TEST CONDITIONS

- Mil-C-7024D Type II test fluid
- 4.5 hrs duration
- 150 psi

## ABRASIVE INGREDIENTS/10 gl. FUEL

- |                                  |         |
|----------------------------------|---------|
| - Red Iron Oxide (0-5 $\mu$ m)   | 4.4 g   |
| - Red Iron Oxide (5-10 $\mu$ m)  | 0.24 g  |
| - Black Iron Oxide (0-5 $\mu$ m) | 0.24 g  |
| - Arizona Road Dust (fine)       | 1.28 g  |
| - Salt                           | 0.002 g |
| - Water                          | 0.002 g |

# Erosion Test Results - Ni

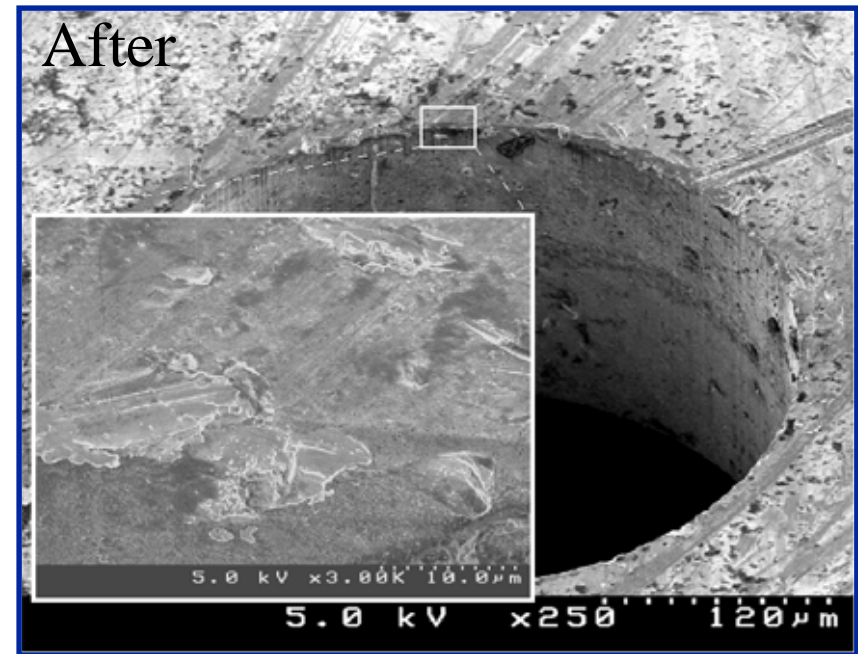
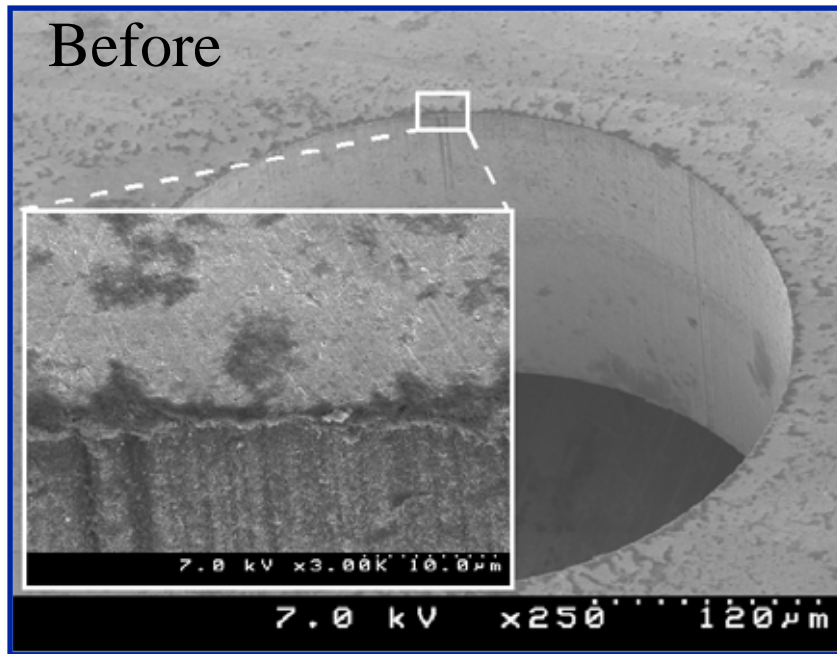

- Evidence of heavy gouging of the Ni as a function of the erosion tests at the exit orifice edge
- Evidence of flaking and gouging of the Ni on the swirl chamber floor

# Erosion Test Results - SiC

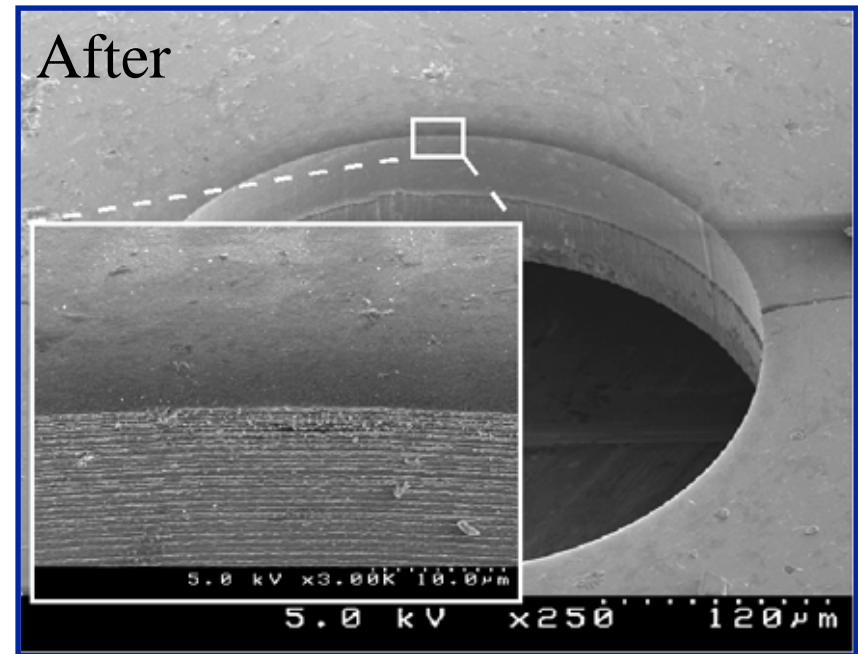
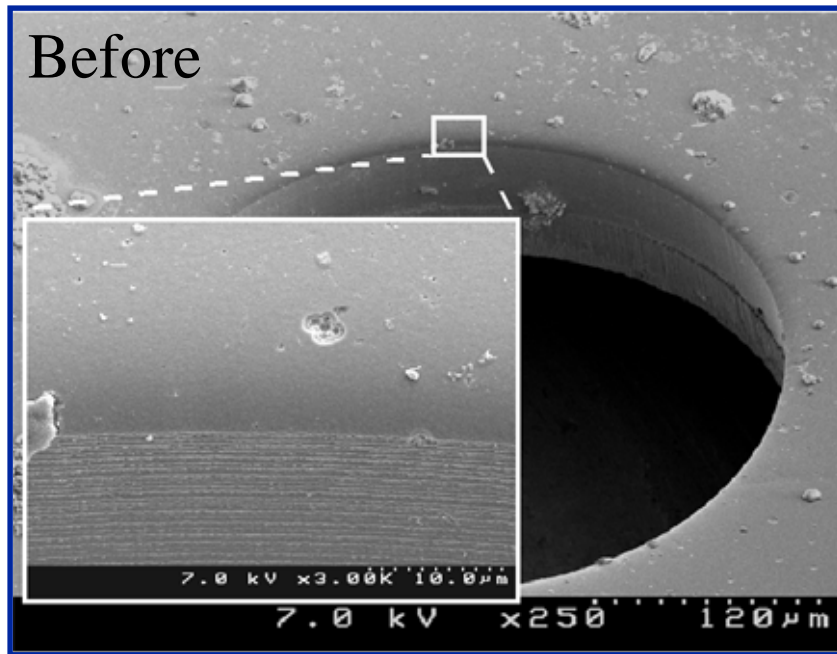

- Negligible morphology change as a function of the erosion tests at the exit orifice edge
- Some evidence of asperity smoothing

# Improving SiC Atomizer Morphology - 1

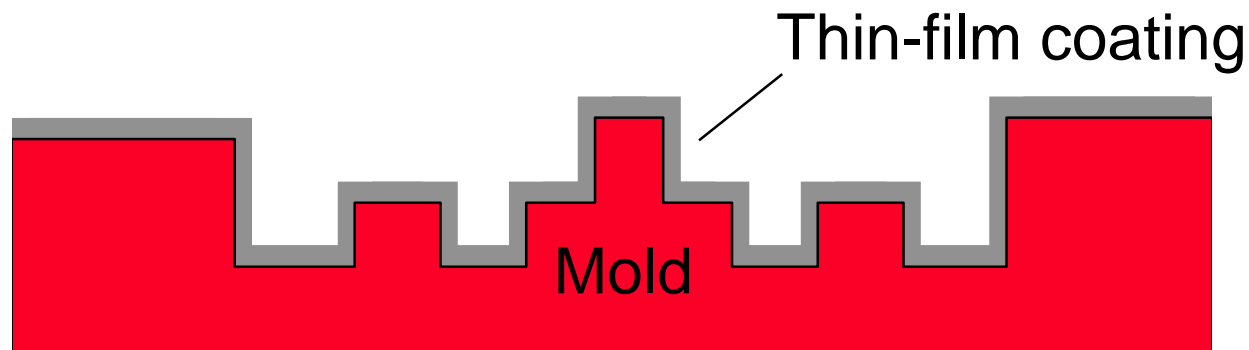

- To extend the application of the molding process to other components, a method was developed to reduce irregularities in the SiC atomizer surface morphology
- Using our unique deposition recipe, we deposited a void free ( $2 \text{ voids/cm}^2$ ) SiC film to circumvent the problem of void formation at the SiC-Si interface

# Improving SiC Atomizer Morphology - 2

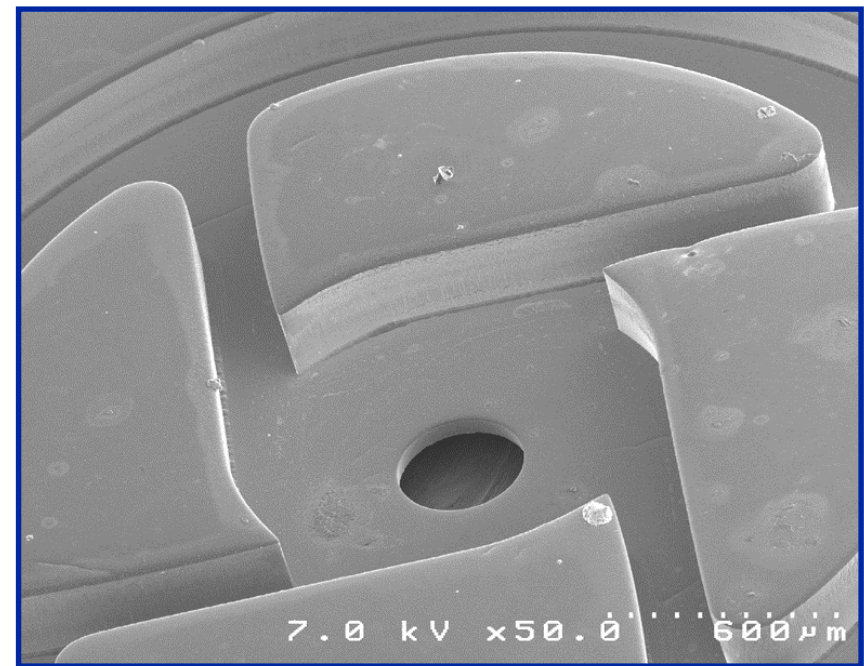
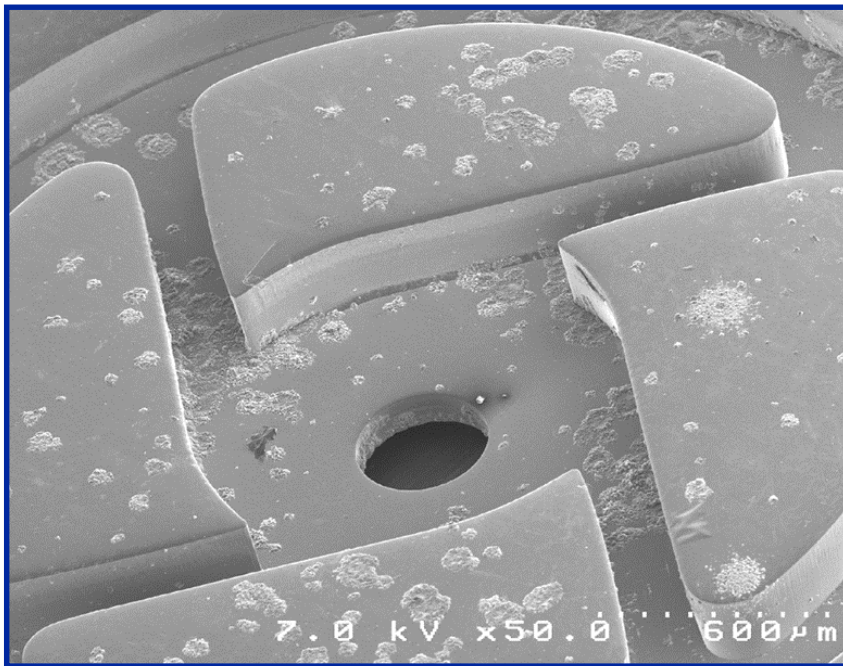

- Thin film(0.5  $\mu\text{m}$ ) of single-crystal 3C-SiC was deposited on the mold prior to high-rate deposition to buffer the substrate against pitting
- Surface irregularities were drastically reduced on all devices

# Surface Micromachining



***Mechanical microstructures are fabricated on the surface of the wafer***

**Structural layers:** material layers that form the final microstructures

**Sacrificial layers:** material layers that separate the structural layers and are removed in the final stage of fabrication

**Release:** the step of dissolving the sacrificial layers

# Surface Micromachining — 2

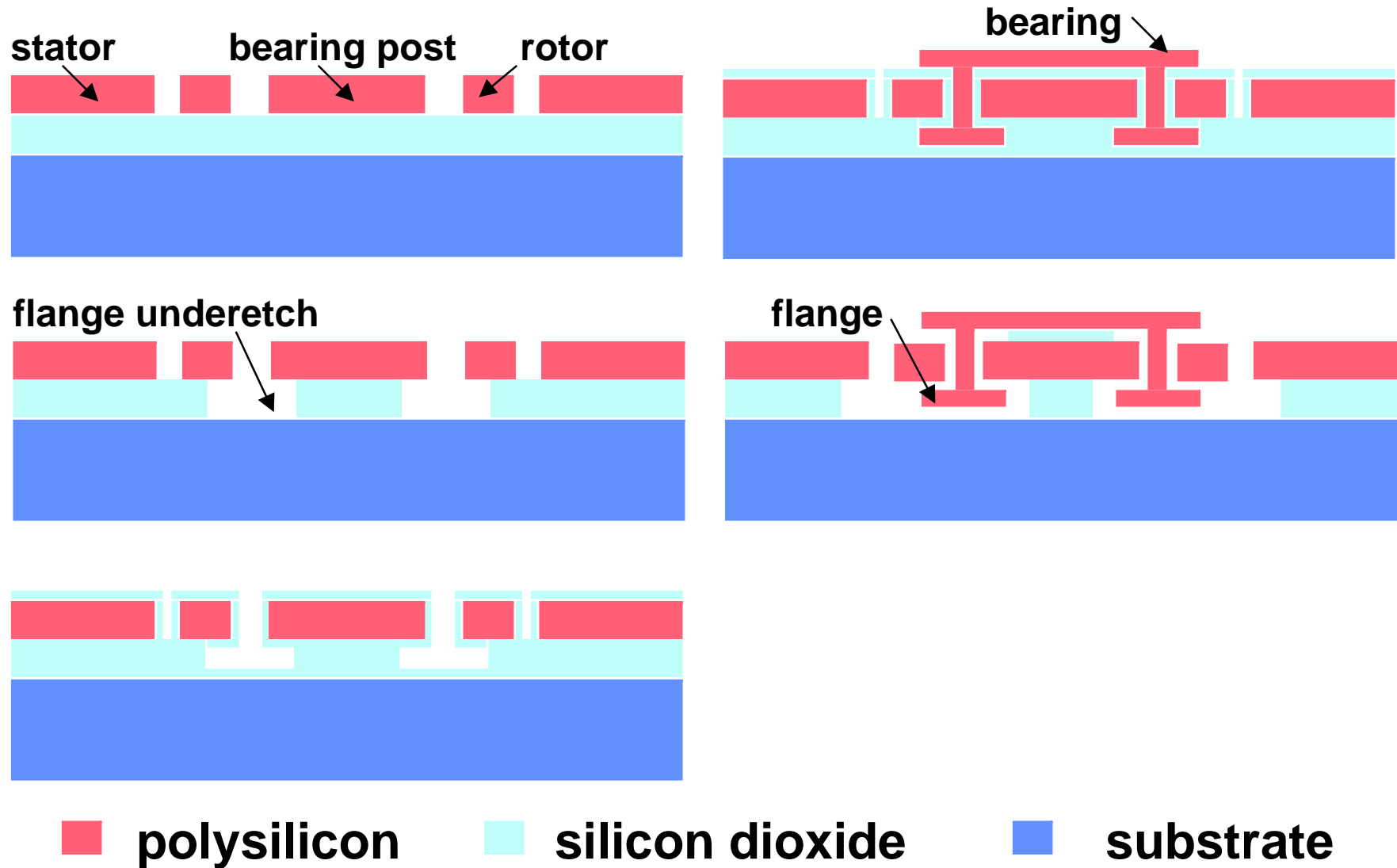

# Multilevel SiC Surface Micromachining - 1



## Schematic of a micromotor fabrication process



1. Oxide and poly deposition

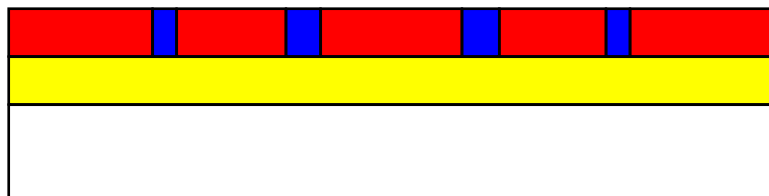

2. Rotor/stator fabrication

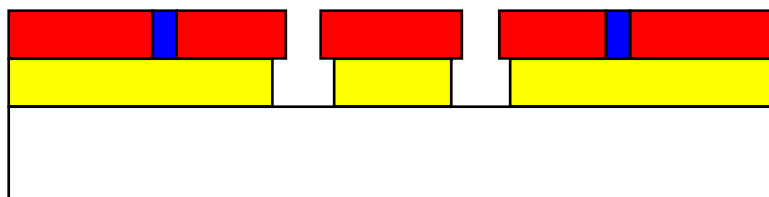

3. Flange mold fabrication

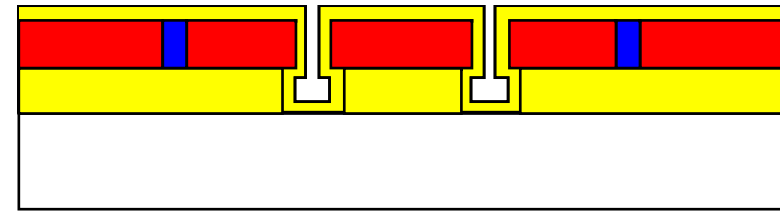

4. Bearing clearance oxide

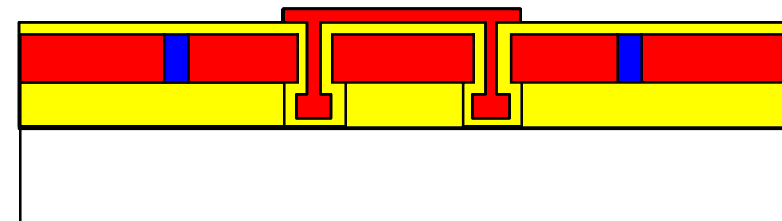

5. Bearing fabrication

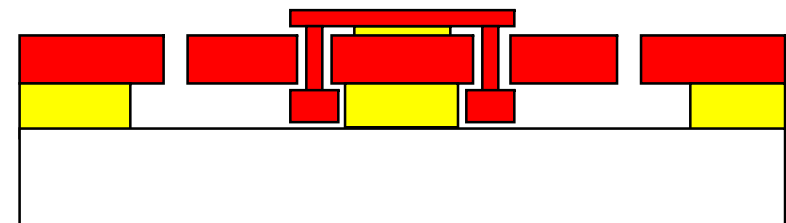

6. Release of mold and rotor



# Multilevel SiC Surface Micromachining - 2



We have recently completed the fabrication of a SiC micromotor. Room temperature testing is currently underway, and high temperature testing will follow shortly.

**SEM micrographs of a SiC micromotor**

**Rotor/stator thickness: 3  $\mu\text{m}$   
Rotor diameter: 150  $\mu\text{m}$**

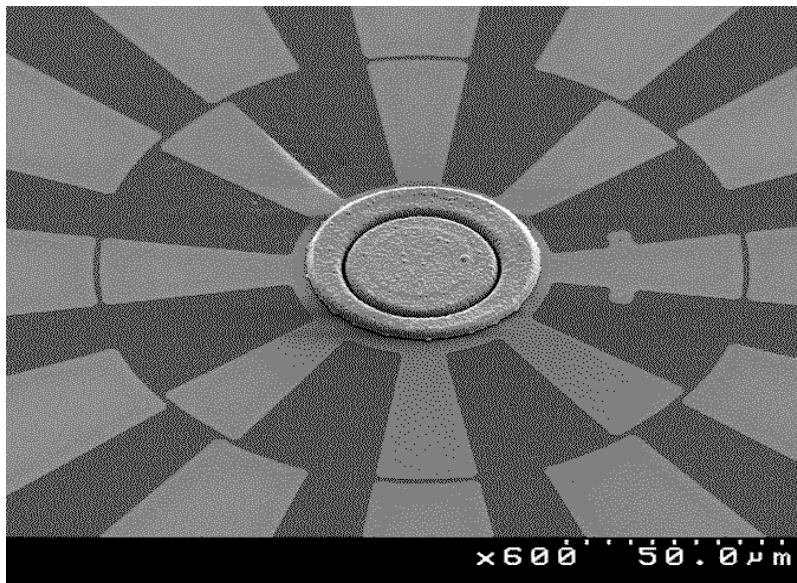

Before release

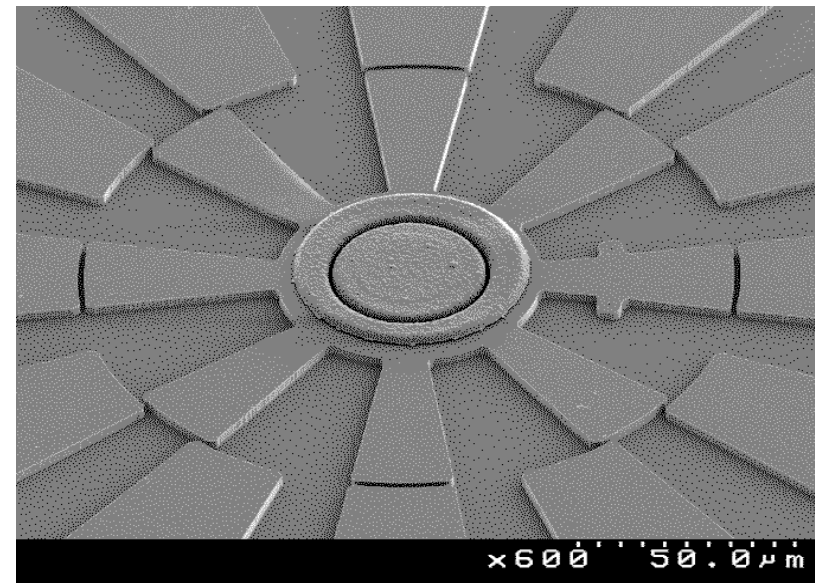

After release

# Controlling Microstructure



XTEM of poly-SiC on as-deposited polysilicon

**SiC/As-deposited Polysilicon**

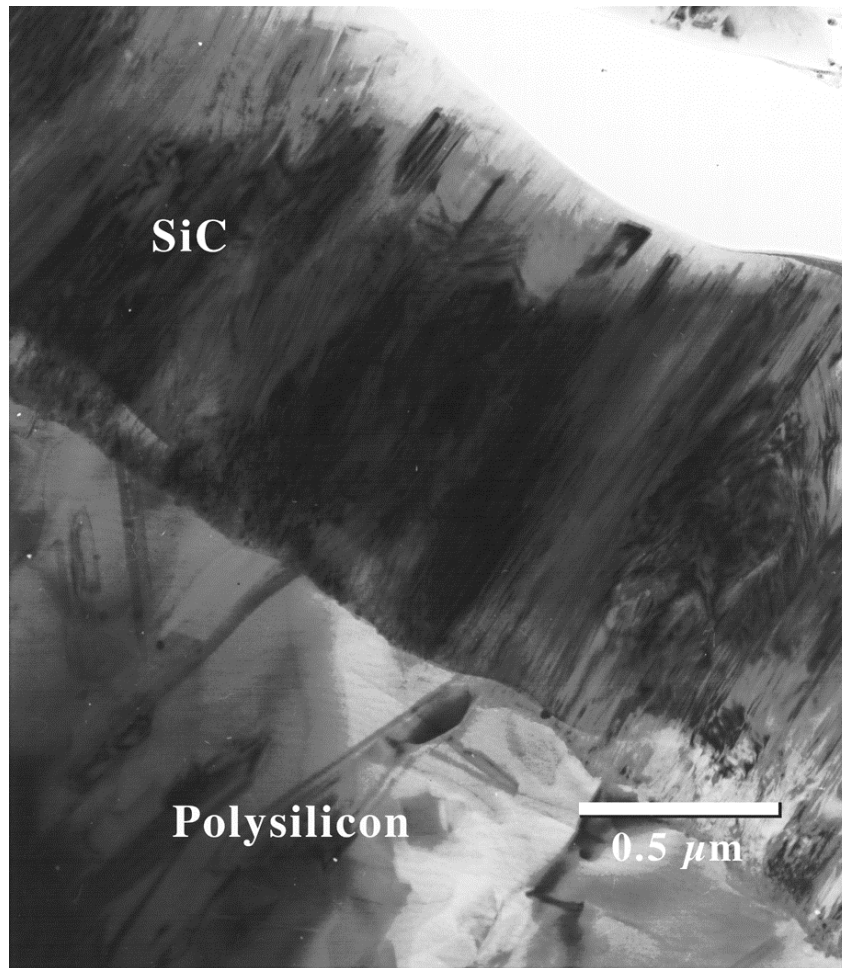

**As-deposited Polysilicon**

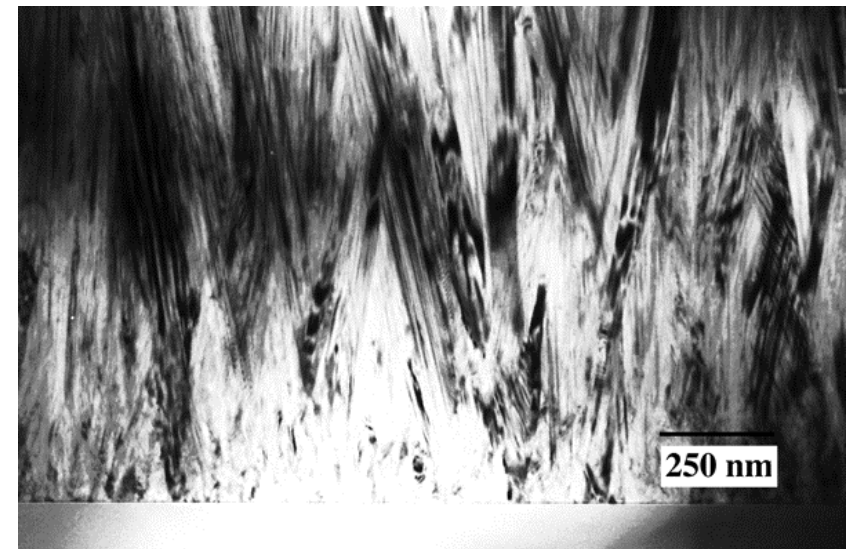

- Post-SiC growth polysilicon microstructure different from SiC
- SiC texture similar to as-deposited polysilicon

# Controlling Microstructure – 2

XTEM of poly-SiC on annealed polysilicon

SiC/Annealed Polysilicon

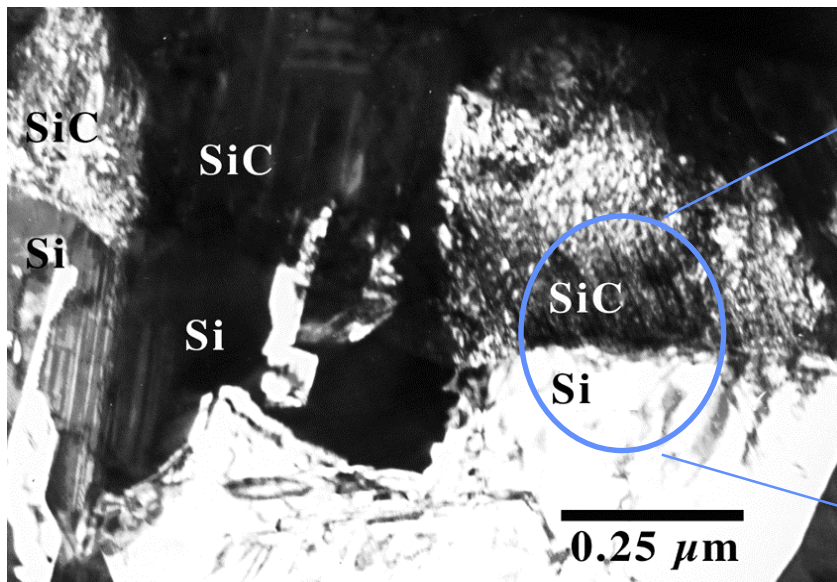

SAD Pattern

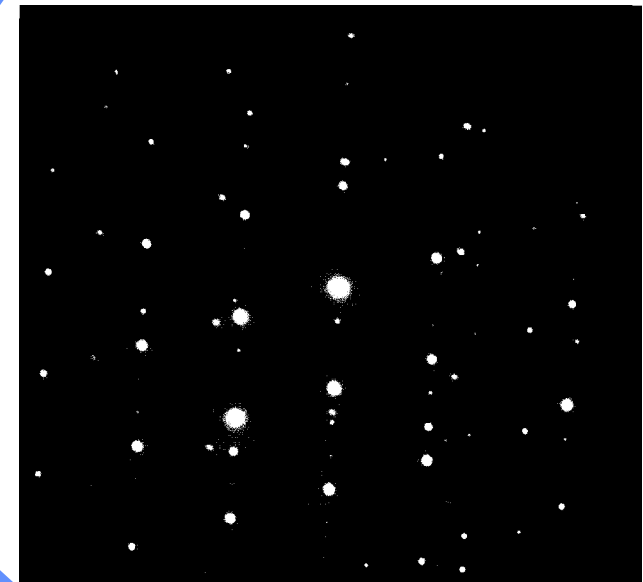

- No significant change in polysilicon microstructure.
- SiC grain boundaries align with underlying polysilicon.
- Texture and grain size of polysilicon translated to SiC.

Grain-to-grain epitaxy

# Structure/Property Relations



- PolySiC grown on **as-deposited** polysilicon:
  - film thickness: 1.9  $\mu\text{m}$
  - number of diaphragms tested: 3
  - biaxial Young's modulus:  $351 \pm 6$  GPa
  - residual stress:  $330 \pm 6$  MPa (tensile)
- PolySiC grown on **annealed** polysilicon
  - film thickness: 2.5  $\mu\text{m}$
  - number of diaphragms tested: 3
  - biaxial Young's modulus:  $533 \pm 20$  GPa
  - residual stress:  $296 \pm 30$  MPa (tensile)

JMR, Feb. 1998, p. 406

- The grain microstructure of polySiC grown on **annealed** polysilicon is:
  - non-columnar
  - randomly-oriented
- The grain structure of polySiC on grown on **as-deposited** polysilicon is:
  - columnar
  - highly textured

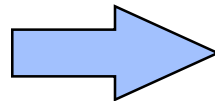

unidirectional slip along  
parallel grain boundaries



**lower Young's modulus**

# Multilevel Surface Micromachining - 3



## Environmental testing of SiC micromotors

### Wobble Micromotor tested:

- 150  $\mu\text{m}$ -diameter rotor
- 2  $\mu\text{m}$  rotor/stator gap

### Procedure:

- Flow gas at 5 psi for 5min
- Operate motor for 1min before collecting data
- Operate motors for at least 5 turns at each voltage

### Results:

- Suggested relationship between motor performance and humidity
- Similar behavior in  $\text{N}_2$ , Ar, and  $\text{O}_2$
- Operation not affected by  $\text{O}_2$

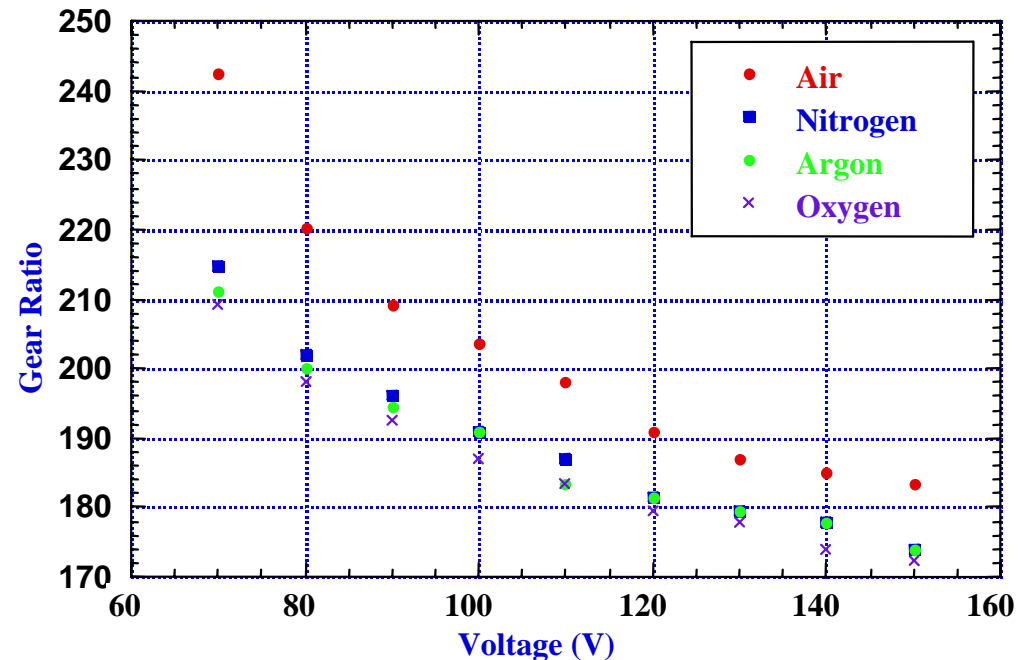

Gear ratio versus excitation voltage

# Poly-SiC Surface Micromachining - 4



## High temperature testing of SiC micromotors

### Setup:

- Ar flow to reduce oxidation
- Excitation of 1100 rpm at 150V
- Ceramic substrate with gold pattern for ground plane
- Variac for temperature control
- Ramp Temperature at  $0.1^{\circ}\text{C}/\text{min}$

### Results:

- Motor was operated every  $25^{\circ}\text{C}$
- Smooth operation up to  $490^{\circ}\text{C}$
- Rotation stopped at  $504^{\circ}\text{C}$
- Rotation stoppage due to electrical breakdown of  $\text{SiO}_2$ .

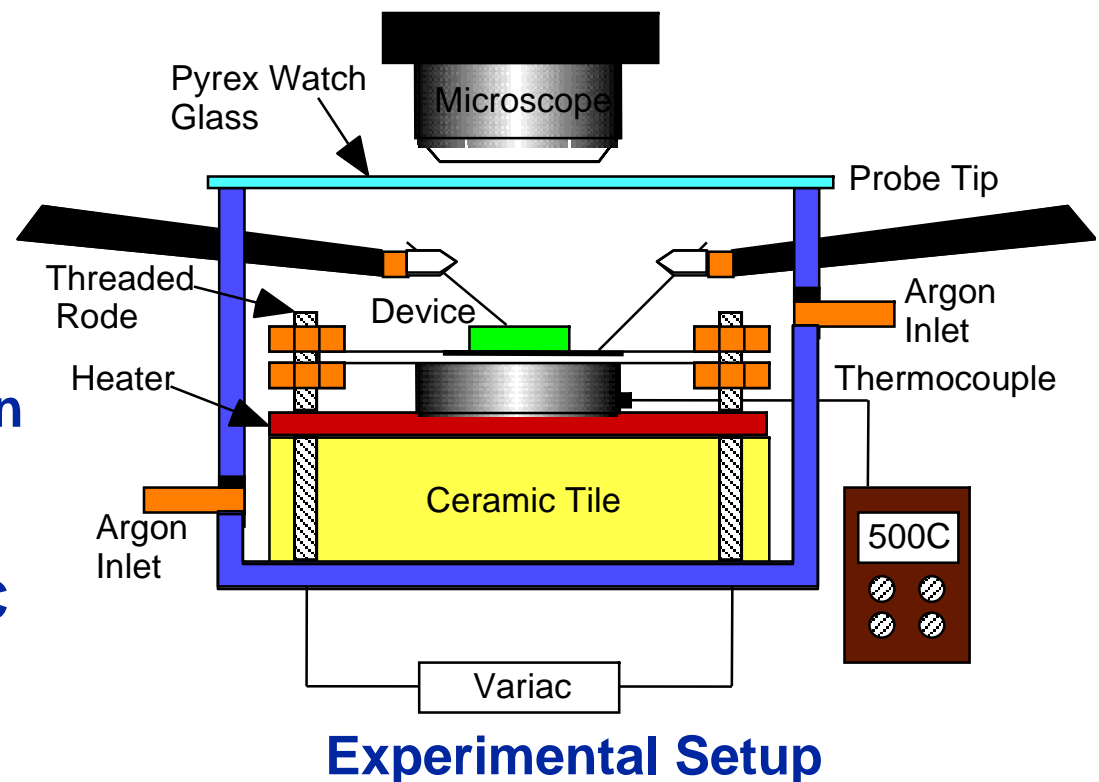

# Multi-User Silicon Carbide (MuSiC) Process

- Objective  
a process for surface micromachined SiC MEMS devices on large area wafers.
- Features
  - Based on the MCNC MUMPs process and design rules.
  - Provides great design flexibility with the capability of supporting a multitude of designs on the same wafer
  - Minimal user involvement in the fabrication processes

Table 1. Comparison of MUMPs, SUMMiT, and MuSiC Processes

Process Name	MUMPs	SUMMiT	MuSiC
Source	MCNC	Sandia Nat. Lab.	CWRU
Structural Material	Polysilicon	Polysilicon	SiC
No. of Structural layers	3	4	4
Surface Planarity	Non-planar	Partially-Planar	Planar
No. of Masks	8	11	8
Cost (\$/cm <sup>2</sup> )	193	460	*
Die Area	1x1 cm <sup>2</sup>	0.466x0.466 cm <sup>2</sup>	1x1 cm <sup>2</sup>
No. of dies delivered	15	100	*
Minimum Turn Around Time	8-10 weeks	12-16 weeks	*

\*— to be determined

# MuSiC Development Run Die Arrangement



# MuSiC Development Run

## Die Arrangement



- 48 dies (1 x1 cm<sup>2</sup> each) on a 4"- dia. wafer
- Devices
  - Acceleration and vibration sensors
  - Lateral resonators and filters
  - Structures for mechanical property measurements
  - Mirror-based, flip-up optical devices
  - Capacitive pressure sensors and shear stress sensors
  - Electrical characterization structures
  - Micromotors
  - Flow sensors

# MuSiC Process Using Micromolding - 1



■ Nickel ■ Nitride ■ SiC ■ Poly ■ Oxide



1. A 5000 Å-thick SiC film (SiC-0) is deposited on the first patterned oxide layer.



2. SiC-0 is mechanically polished down to the first oxide surface.

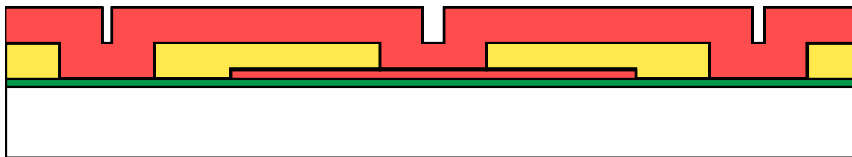

3. A 2 μm-thick SiC film (SiC-1) is deposited after the second oxide layer deposition and patterning.



4. SiC-1 is mechanically polished down to the second oxide surface.

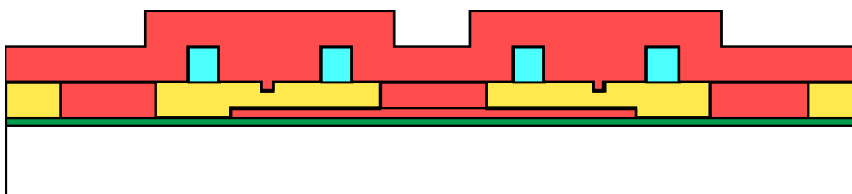

5. After the polysilicon molding layer (poly-1) deposition and patterning, a 2 μm-thick SiC film (SiC-2) is deposited .

# MuSiC Process Using Micromolding - 2

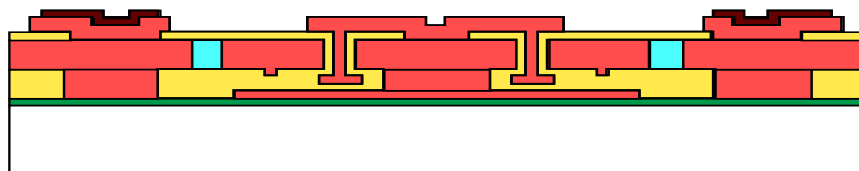
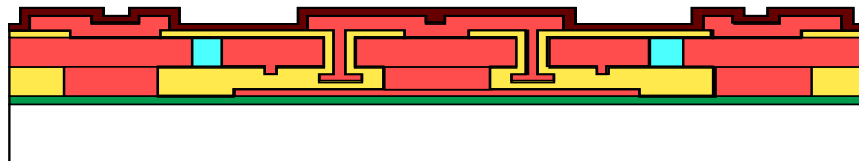
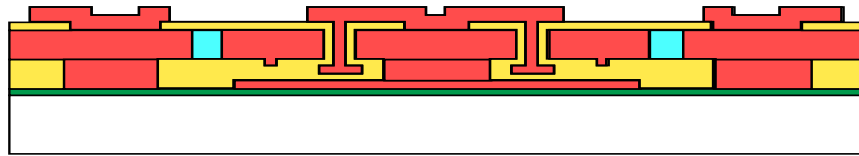
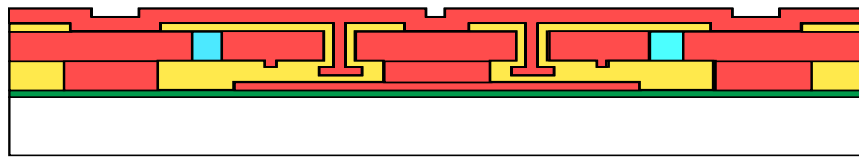

6. SiC-2 is polished down to the polysilicon molding layer surface.

7. Part of both molding poly-1 and the second oxide layers is etched. A 7500 Å of the third oxide is deposited, followed by deposition of 1.5 μm-thick SiC film (SiC-3).

8. SiC-3 is etched using RIE.

9. A 7500 Å-thick nickel is deposited.

10. Nickel layer is patterned, and devices are waiting for release and testing.

## SEM of a SiC lateral resonator fabricated by MuSiC process

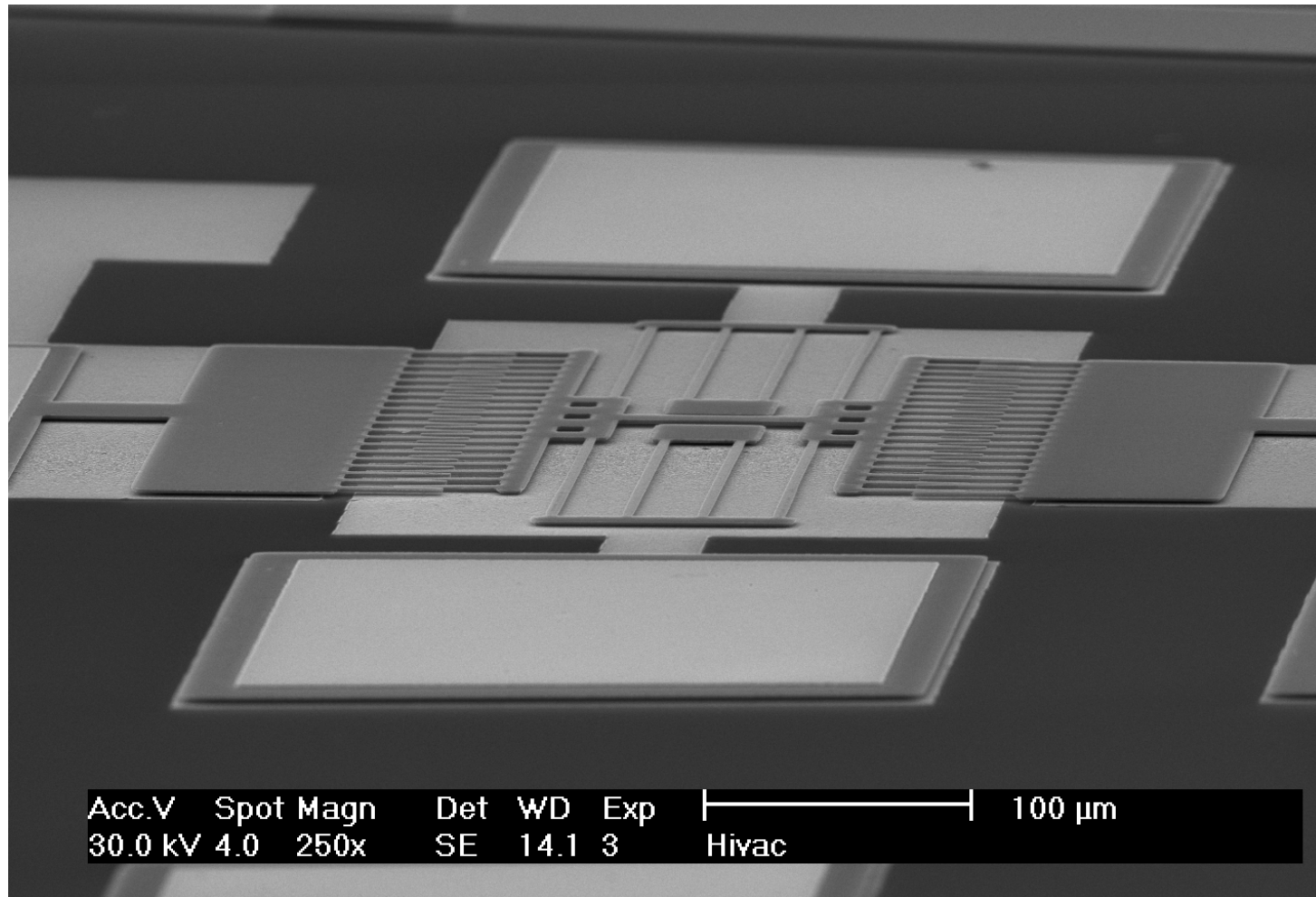

# SEM of a micromachined SiC vertical accelerometer

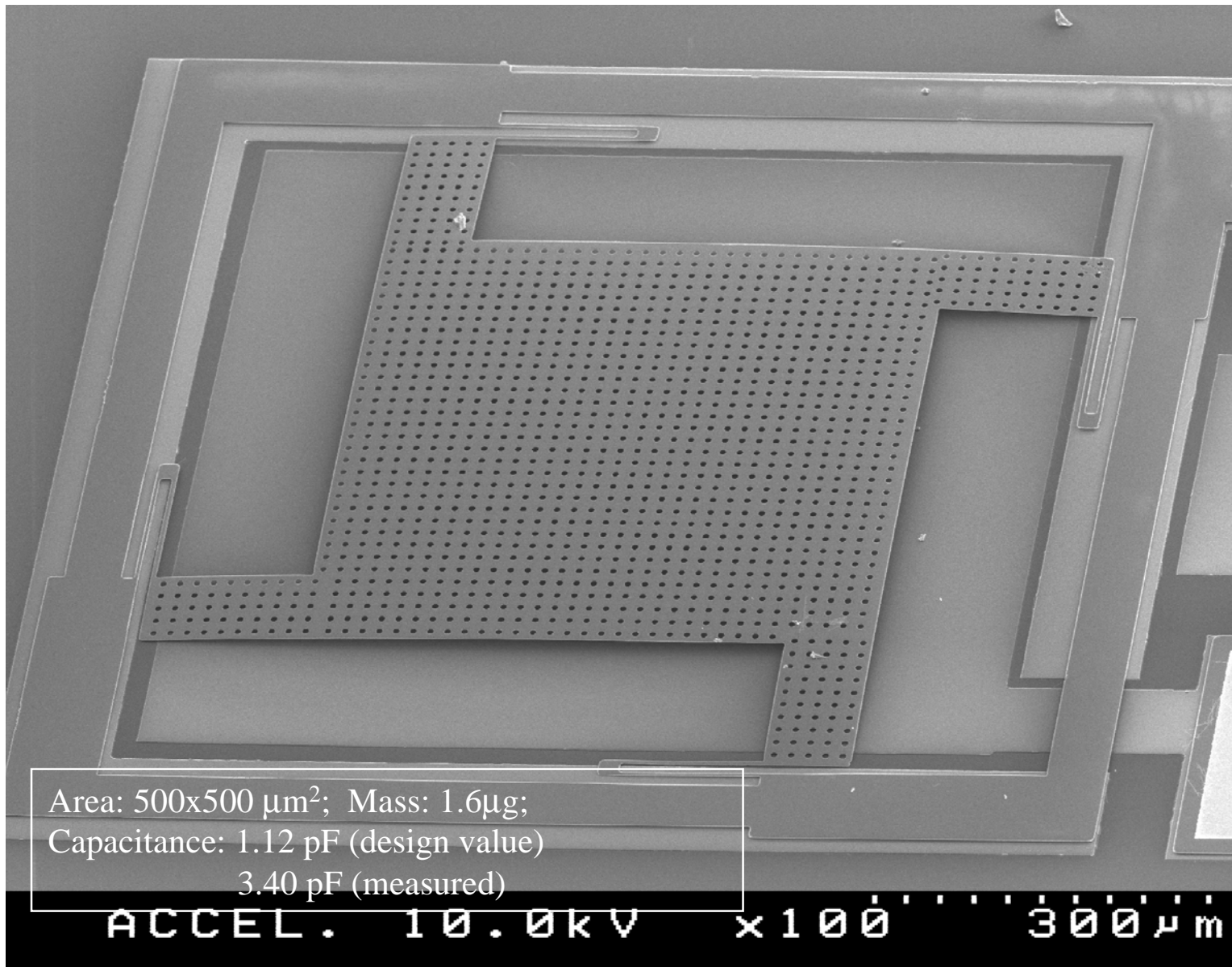

# SEM of a micromachined SiC lateral accelerometer

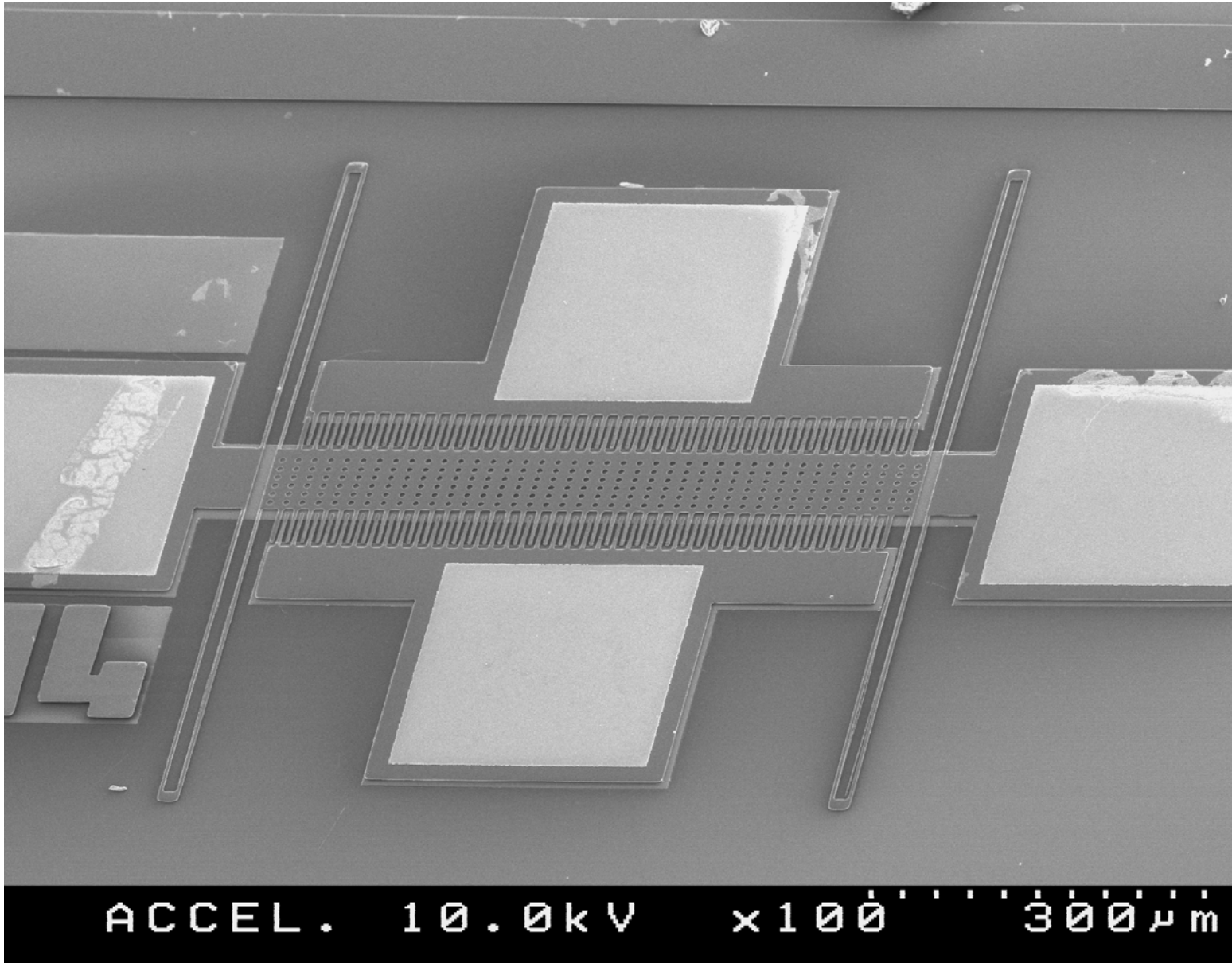

# Integrated MEMS for $>300\text{C}$



Move Si integrated MEMS concepts onto SiC for 300C operation and above

Surface  $\mu$ machining!

Fabricate electronics first and then MEMS since junctions will not diffuse in SiC!

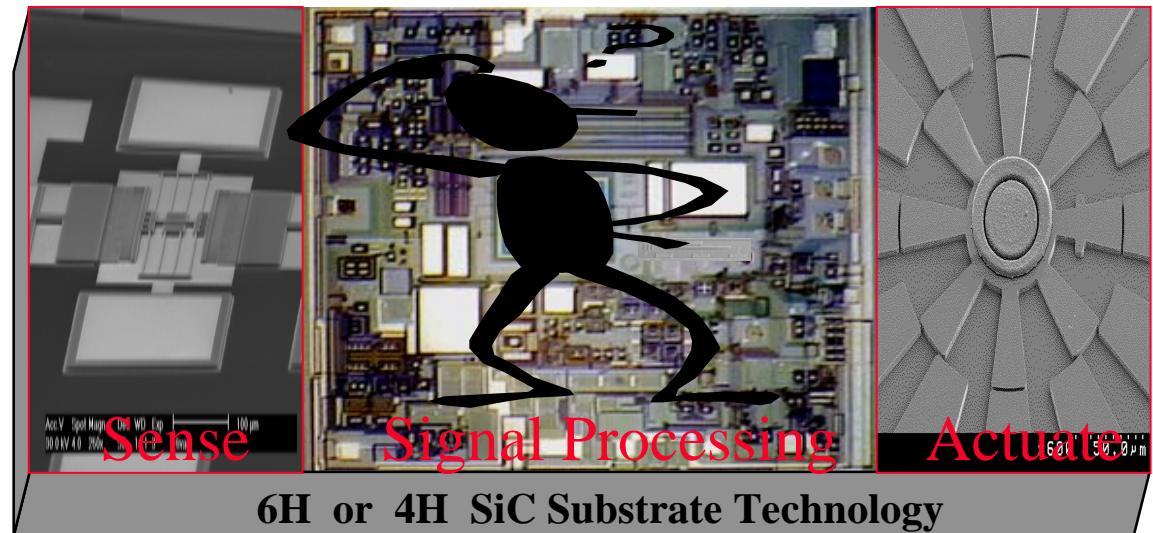

- 3-layer Poly-SiC surface micromachining with  $2\ \mu\text{m}$  feature size
  - sensors, actuators, mechanisms, and on-chip resonator
- Electronics on 6H or 4H SiC
  - signal conditioning, processing, and RF electronics



# MEMS to NEMS in 3C-SiC



## Nanoscale Doubly-Clamped Beams in 3C-SiC

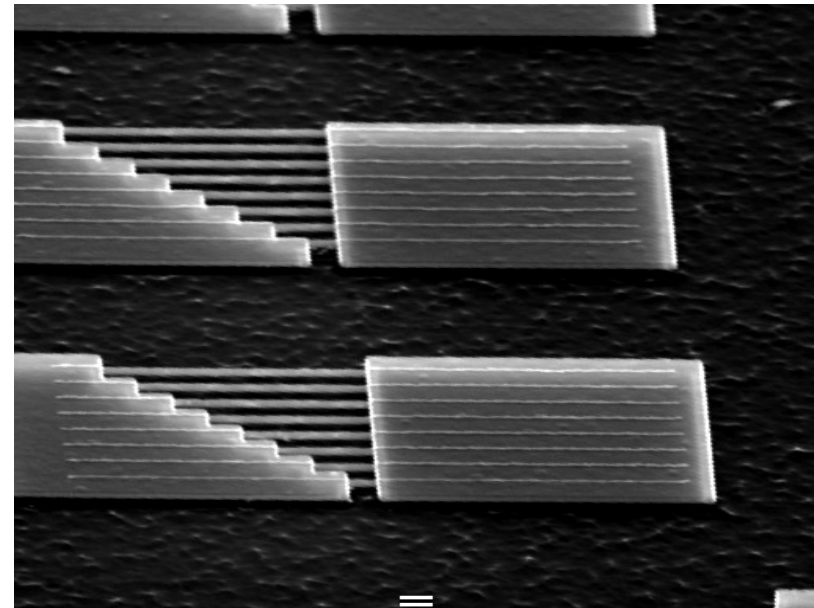
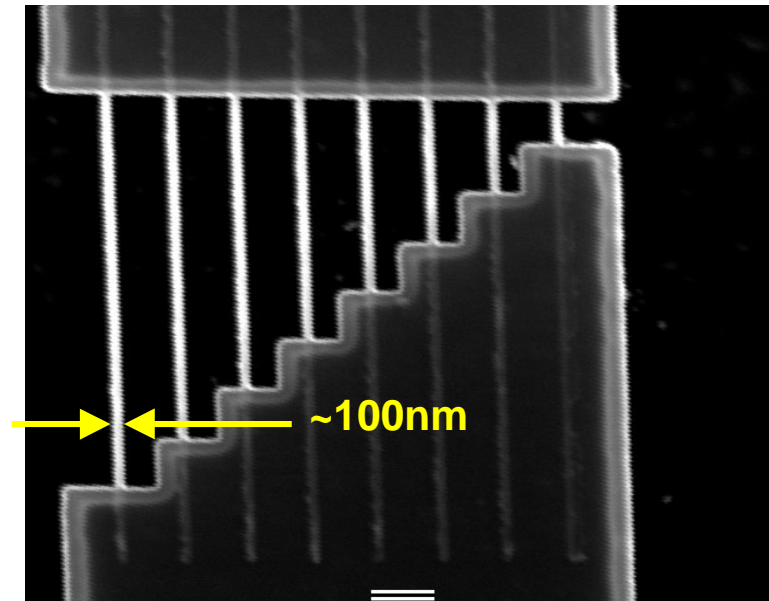

A series of fixed width, but varying length doubly clamped 3C-SiC NEMS beams are shown. Two electron beam lithography steps are performed to avoid the proximity effect. The 1st step defines narrow beams while the second one defines the larger support structures. 3C-SiC is one of the first materials to be used in both MEMS and NEMS applications. Its high Young's modulus makes SiC very attractive for UHV communications applications.



# MEMS to NEMS in 3C-SiC



## Nanoscale Doubly-Clamped Beams in 3C-SiC

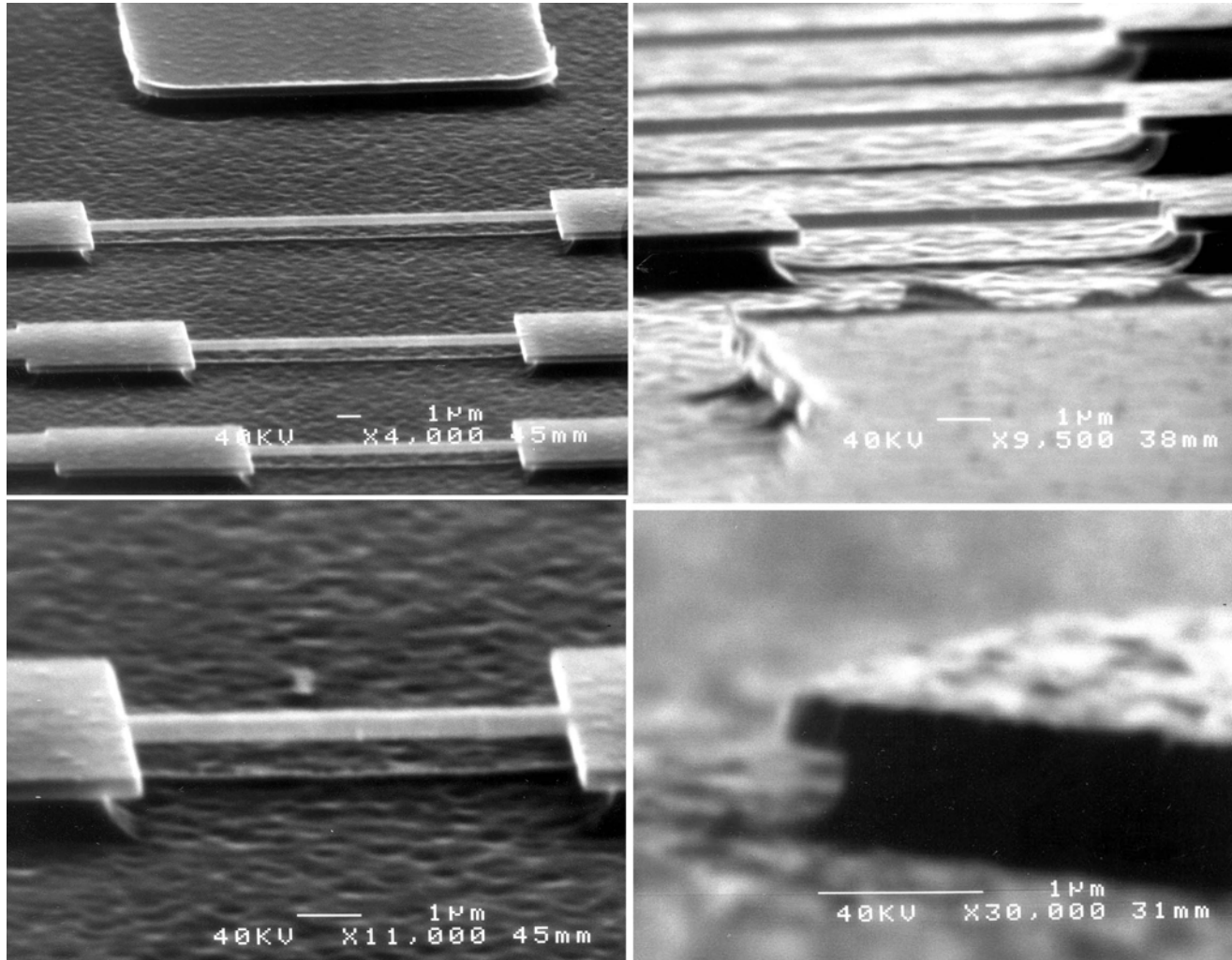

# MEMS versus IC's



**MEMS leverages existing commercial semiconductor manufacturing infrastructure**

## MEMS packaging

- application-specific
- highly customized
- expensive

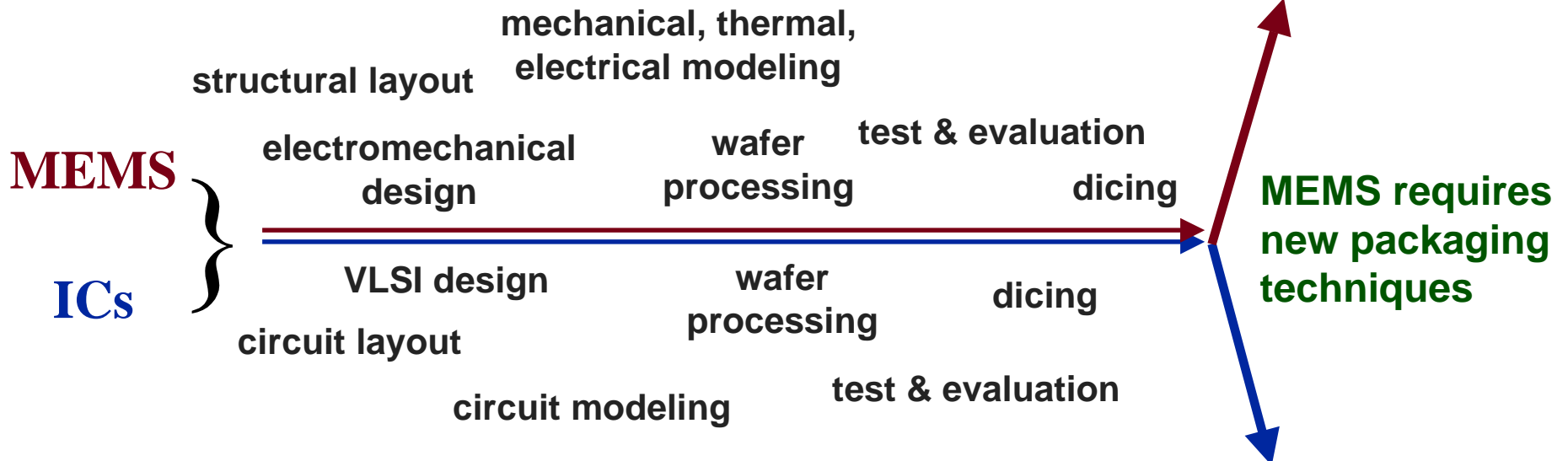

**MEMS requires new packaging techniques**

## IC packaging

- generic
- established standards
- low cost