



NATO ARW
Kiev, Ukraine, 7-13 September 2003



AF Research Laboratory / Materials and Manufacturing Directorate

Metals, Ceramics, and NDE Division

Development of Super-high Strength Aluminum Alloys for Cryogenic Applications

O.N. Senkov,
R.B. Bhat, S. Senkova, J. Tatalovich

UES, Inc., Dayton, OH

D.B. Miracle

AFRL/MLLM, Wright-Patterson AFB, OH

AFRL Contract F04611-02-C-0014
(Dr. Jeigh Shelley, Project Manager)

Report Documentation Page

Form Approved
OMB No. 0704-0188

Public reporting burden for the collection of information is estimated to average 1 hour per response, including the time for reviewing instructions, searching existing data sources, gathering and maintaining the data needed, and completing and reviewing the collection of information. Send comments regarding this burden estimate or any other aspect of this collection of information, including suggestions for reducing this burden, to Washington Headquarters Services, Directorate for Information Operations and Reports, 1215 Jefferson Davis Highway, Suite 1204, Arlington VA 22202-4302. Respondents should be aware that notwithstanding any other provision of law, no person shall be subject to a penalty for failing to comply with a collection of information if it does not display a currently valid OMB control number.

1. REPORT DATE 18 MAR 2004	2. REPORT TYPE N/A	3. DATES COVERED -	
4. TITLE AND SUBTITLE Development of Super-high Strength Aluminum Alloys for Cryogenic Applications		5a. CONTRACT NUMBER	
		5b. GRANT NUMBER	
		5c. PROGRAM ELEMENT NUMBER	
6. AUTHOR(S)		5d. PROJECT NUMBER	
		5e. TASK NUMBER	
		5f. WORK UNIT NUMBER	
7. PERFORMING ORGANIZATION NAME(S) AND ADDRESS(ES) UES, Inc., Dayton, OH; AFRL/MLLM, Wright-Patterson AFB, OH		8. PERFORMING ORGANIZATION REPORT NUMBER	
9. SPONSORING/MONITORING AGENCY NAME(S) AND ADDRESS(ES)		10. SPONSOR/MONITOR'S ACRONYM(S)	
		11. SPONSOR/MONITOR'S REPORT NUMBER(S)	
12. DISTRIBUTION/AVAILABILITY STATEMENT Approved for public release, distribution unlimited			
13. SUPPLEMENTARY NOTES See also ADM001672., The original document contains color images.			
14. ABSTRACT			
15. SUBJECT TERMS			
16. SECURITY CLASSIFICATION OF:			17. LIMITATION OF ABSTRACT
a. REPORT unclassified	b. ABSTRACT unclassified	c. THIS PAGE unclassified	UU
			18. NUMBER OF PAGES 24
			19a. NAME OF RESPONSIBLE PERSON



Background



AF Research Laboratory / Materials and Manufacturing Directorate

Metals, Ceramics, and NDE Division

- Few years ago, the Integrated High Payoff Rocket Propulsion Technology (IHPRPT) program has started in the USA that is focused on developing measurable, affordable and goal directed aerospace technologies.
- The IHPRIPT goal is to double space and missile propulsion capability while significantly decreasing manufacturing and maintenance costs by 2010.
- In particular, it is expected to improve thrust to weight of cryogenic liquid rocket engines by 100%.

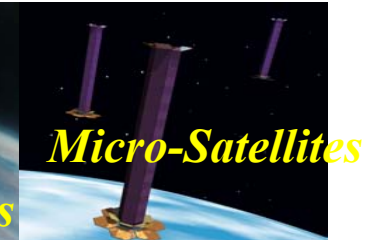



Space Shuttle Main Engine



AF Research Laboratory / Materials and Manufacturing Directorate

Metals, Ceramics, and NDE Division



Propellants: LOX/H₂
Thrust: 2160 kN
Weight: 3350 kg

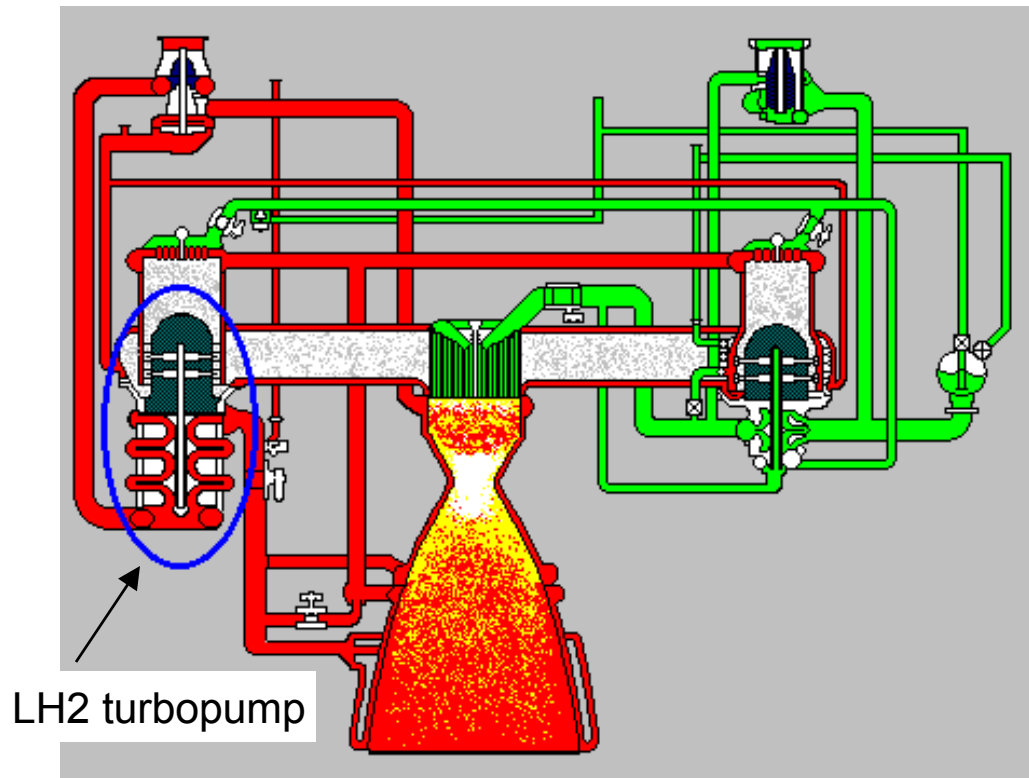



Background



- LH₂ three stage turbopump consists of three Ti-5Al-2.5Sn ELI impellers.
- Maximum tip speed of impellers required to produce maximum fuel pressure in the combustion chamber and maximum thrust is limited by specific strength.

Alpha titanium alloy Ti-5Al-2.5Sn ELI has excellent properties at cryogenic temperatures; however it is (a) expensive and (b) prone to hydrogen embrittlement.

Aluminum alloys are (a) much less expensive, (b) ~ 1.6 times lighter, (c) much less sensitive to hydrogen environment.

It would be beneficial to use an Al alloy instead of the Ti alloy.

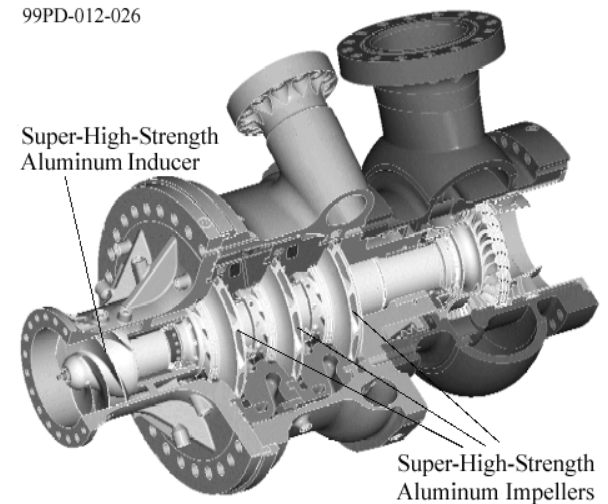

IPD Fuel Turbopump
(Courtesy of Rocketdyne)



Property Requirements



AF Research Laboratory / Materials and Manufacturing Directorate

Metals, Ceramics, and NDE Division

Properties of Ti-5Al-2.5Sn ELI alloy (density = 4.6 g/cm³)

- ◆ 25°C (RT): YS=760 MPa; UTS=840 MPa; EI=15%
- ◆ -196°C (LN₂): YS=1100 MPa; UTS=1260 MPa; EI=15%
- ◆ -253°C (LH₂): YS=1260 MPa; UTS=1420 MPa; EI=13%

Al alloy (density = 2.8 g/cm³) to achieve similar specific strengths must have:

- ◆ 25°C (RT): YS=463 MPa; UTS=511 MPa (SS=182 kN m/kg)
- ◆ -196°C (LN₂): YS=670 MPa; UTS=767 MPa (SS=274 kN m/kg)
- ◆ -253°C (LH₂): YS=767 MPa; UTS=864 MPa (SS=308 kN m/kg)

Customer requirements for advanced Al alloy:

UTS ≥ 620 MPa at 25°C, ≥ 800 MPa at -196°C, ≥ 900 MPa at -253°C
EI ≥ 7%



Commercial Aluminum Alloys



AF Research Laboratory / Materials and Manufacturing Directorate

Metals, Ceramics, and NDE Division

Mechanical properties of commercial aluminum alloys at -253°C (-423°F)

Material	2024	5083	5456	6061	7075	X7106	356
YS, MPa	428-635	173-566	324-428	331-380	538-676	449-511	228-282
UTS MPa	621-725	497-669	497-587	449-538	697-759	600-669	324-393
EL (%)	13-23	10-40	6-17	20-32	6-15	14-25	2-9

- ☹ Required properties ($YS \geq 770 \text{ MPa}$, $UTS \geq 900 \text{ MPa}$) cannot be achieved
None of the currently available commercial Al alloys can provide specific strength equivalent to that of the Ti alloy



Goals



AF Research Laboratory / Materials and Manufacturing Directorate

Metals, Ceramics, and NDE Division

➔ Identify and develop aluminum based alloy for cryogenic rocket engine applications instead of currently used Ti-5Al-2.5Sn ELI alloy and other alloys

Parts

Impellers

Pump Housing

Ducts and pipes

Processing

Forging

Casting

Extrusion

99PD-012-026

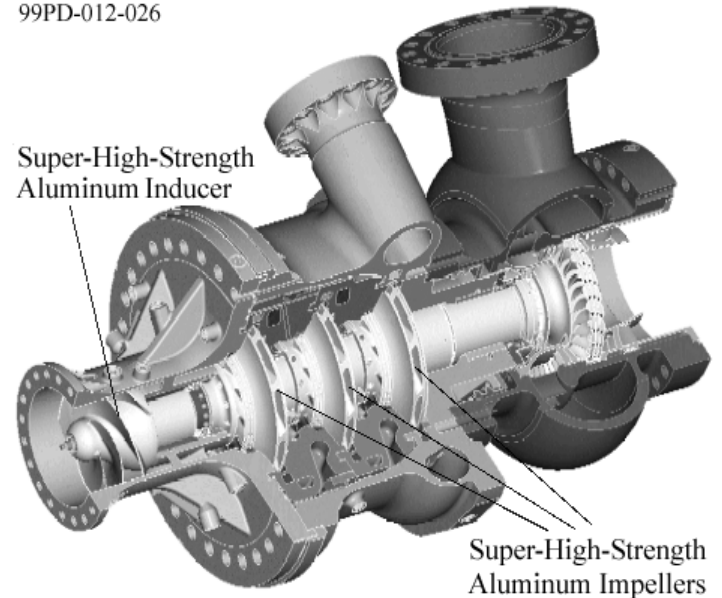

IPD Fuel Turbopump
(Courtesy of Rocketdyne)



Developmental Al Alloys



AF Research Laboratory / Materials and Manufacturing Directorate

Metals, Ceramics, and NDE Division

Novel non-equilibrium processes

- **Rapidly solidified Al alloys**
- **Mechanically alloyed**
- **Amorphous, nanocrystalline, quasi-crystalline**
 - ☺ Advantages
 - ✓ Novel compositions and phases
 - ✓ Required properties may be achieved
 - ☹ Disadvantages
 - ✓ Expensive in development
 - ✓ Expensive in production
 - ✓ Desired properties can be lost during high-temperature processing



Recent Developments



AF Research Laboratory / Materials and Manufacturing Directorate

Metals, Ceramics, and NDE Division

Nanophase Aluminum

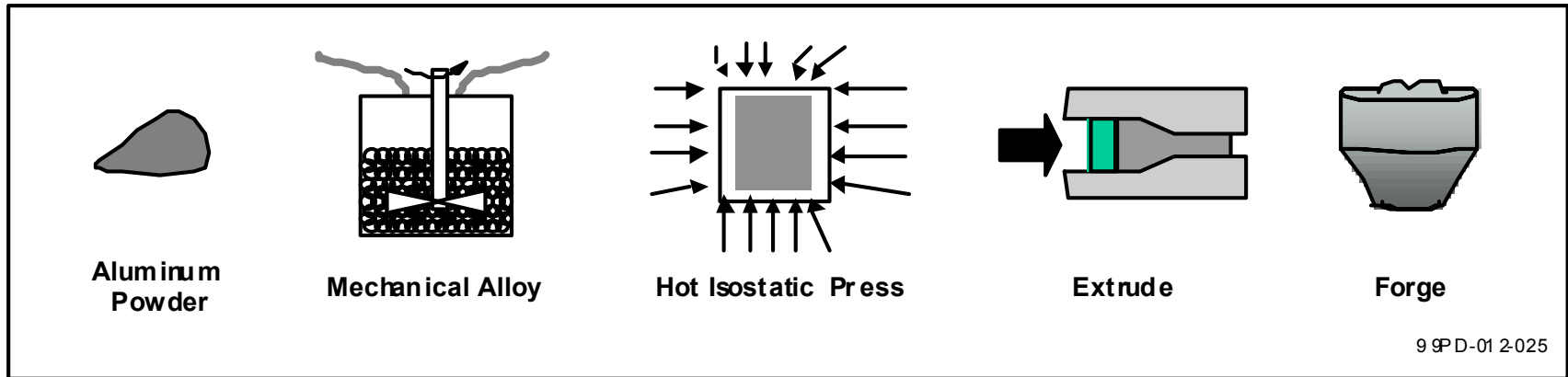

Schematic of fabrication of nanophase aluminum alloys

Property levels of Al-7.5%Mg at LN₂:

YS=518 MPa (75.0 ksi), UTS=659 MPa (95.5 ksi), and El=4.9%

Dual Use Sci.&Technology Program (RPP, RSC, AFRL/WPAFB) started in 2000 to develop a second generation, higher strength NA alloy



Our Approach



AF Research Laboratory / Materials and Manufacturing Directorate

Metals, Ceramics, and NDE Division

- ▶ Use conventional practice of casting, hot working, and heat treatment
- ▶ Try to achieve required properties through modifications of alloy composition and processing parameters of a 7XXX alloy.
- ▶ Modify the alloy composition to increase the volume fractions of precipitates (η' , Zn_2Mg) and dispersoids ($L1_2$, Al_3Sc , etc.)
- ▶ Modify processing parameters to achieve required combination of strength and ductility by optimizing the number density of the precipitates and dispersoids and refining grain size
 - ▶ Main dispersoid formers are Sc and Zr; they also may improve both strength and ductility of Al alloys
 - Sc and Zr are precipitation-strengtheners, grain refiners, and recrystallization inhibitors for Al alloys.
 - Sc also improves stress corrosion resistance of Al alloys.
 - ▶ Cryogenic properties of 7XXX alloys modified with Sc and Zr have not been reported yet.



Experimental



- Compositions of alloys investigated (in wt.%)

- 7-12 Zn; 2.3-3.3 Mg; 1.2-2.5 Cu; 0.10-0.20 Zr; 0-0.5 Sc; up to 1.0 others; balance Al
- Alloys with $\geq 8\%$ Zn showed very high strength, but almost zero ductility at cryogenic temperatures

- Compositions of the alloys presented in this report

Alloy #	Zn	Mg	Cu	Zr	Sc	Other	Al
SSA000	7.14	2.30	1.61	0.17	0	0.8	Bal.
SSA018	7.17	2.20	1.58	0.18	0.18	0.8	Bal.

- 75-mm diameter alloy billets were produced by DC casting
- Homogenization at 460°C up to 48 hours
- Extrusion at 400°C and 450°C with 16:1 extrusion ratio
- Forging at 400°C and 450°C with compression strain of 80%
- Heat treatment
- Tensile properties at 23°C and -196°C



Results



AF Research Laboratory / Materials and Manufacturing Directorate

Metals, Ceramics, and NDE Division

Photo-macrographs of transverse cross-sections of continuously DC cast billets of SSA alloys.

0% Sc

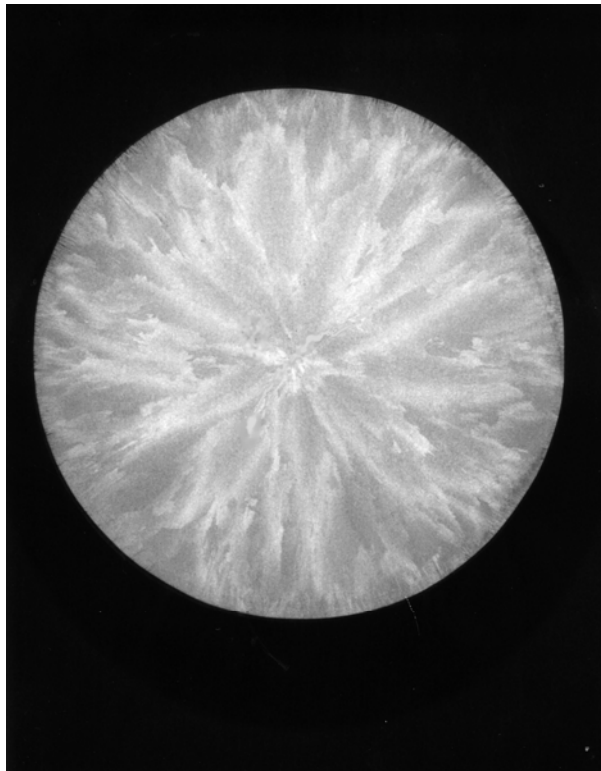

0.18% Sc

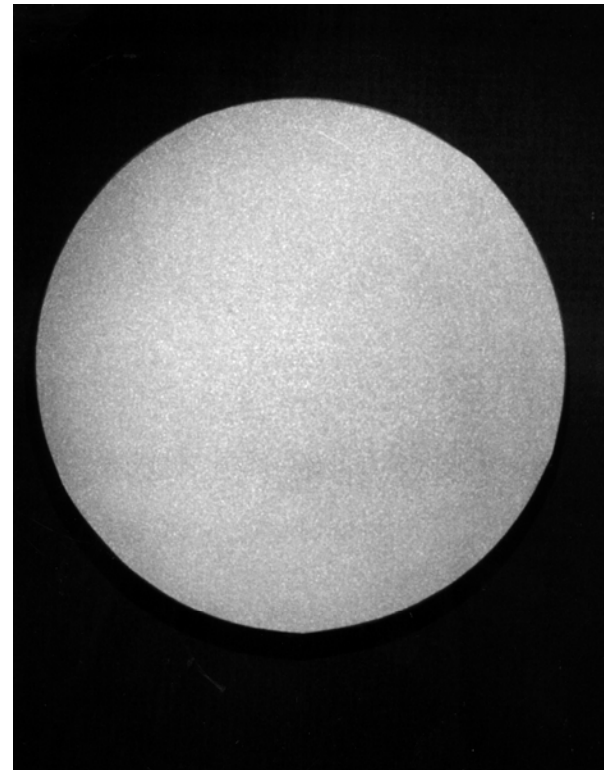



Results



SEM photomicrographs of of SSA cast alloys

SSA000

SSA018

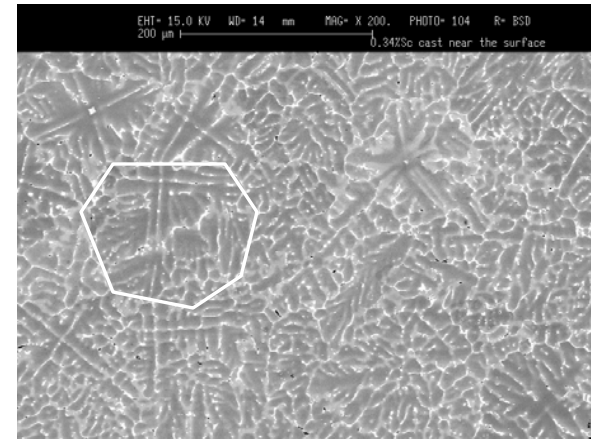
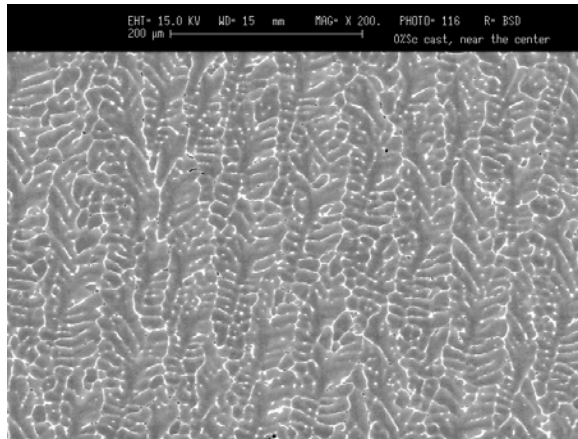

Longitudinal cross-sections

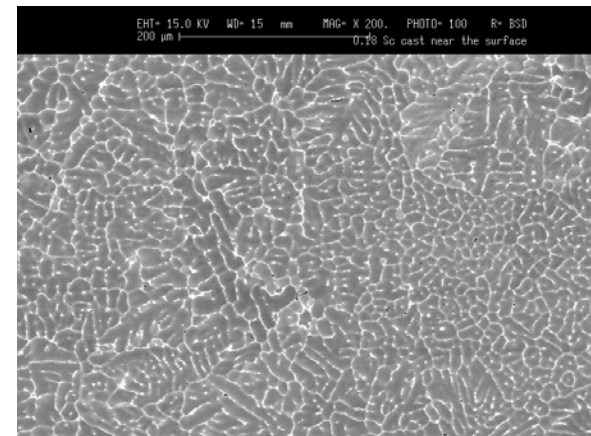
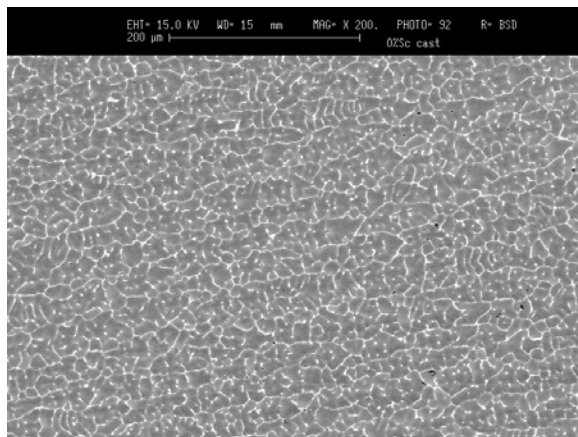

Transverse cross-sections



Properties of cast alloys



AF Research Laboratory / Materials and Manufacturing Directorate

Metals, Ceramics, and NDE Division

Room temperature tensile properties of DC cast billets

0%Sc

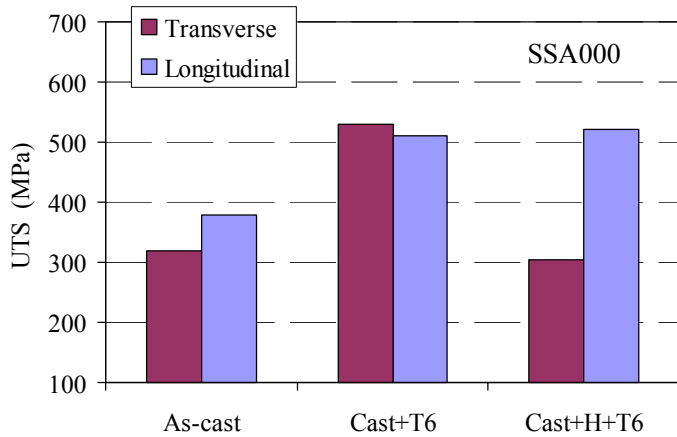

0.18%Sc

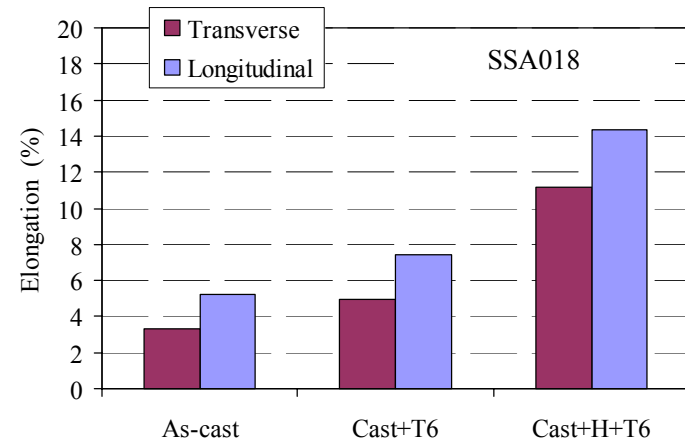
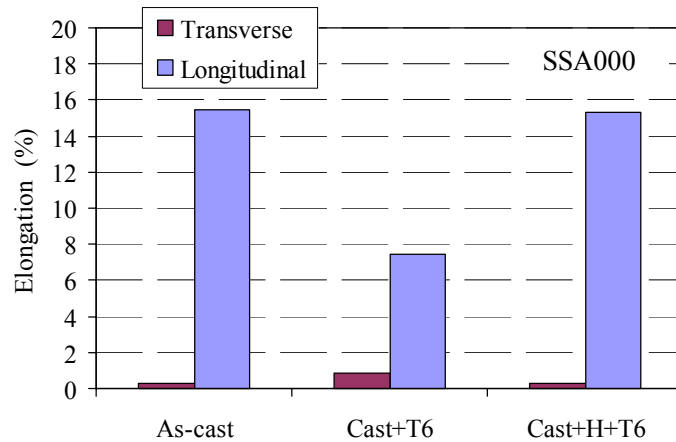
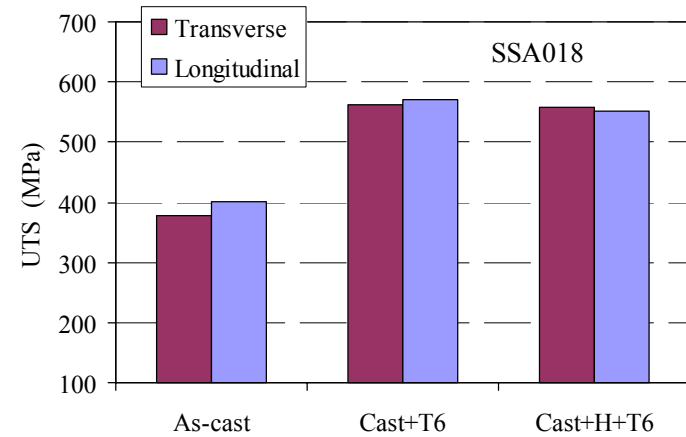



Properties of cast alloys



Cryogenic (-196°C) tensile properties of DC cast billets

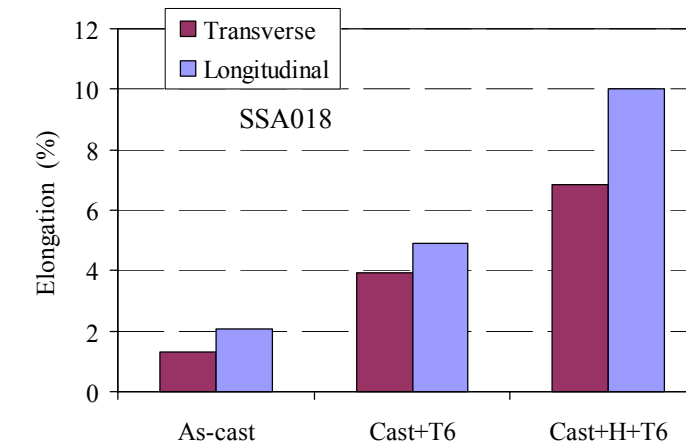
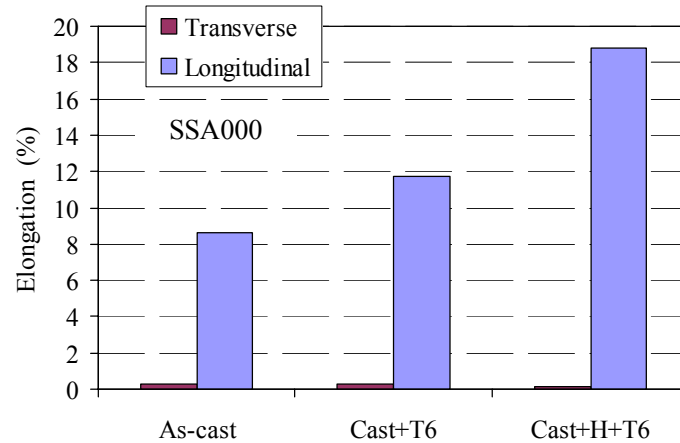
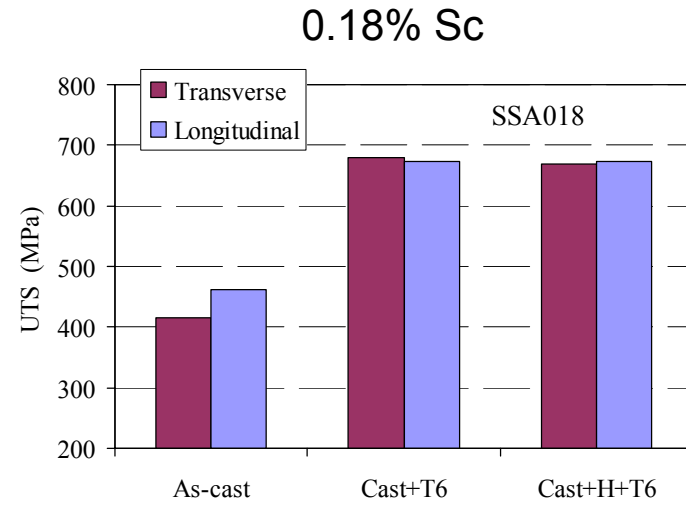
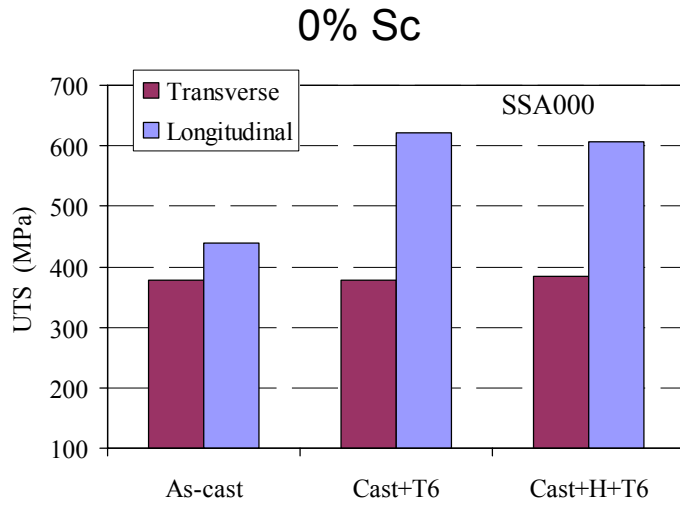



Extrusion



Microstructure of extruded and heat treated specimens

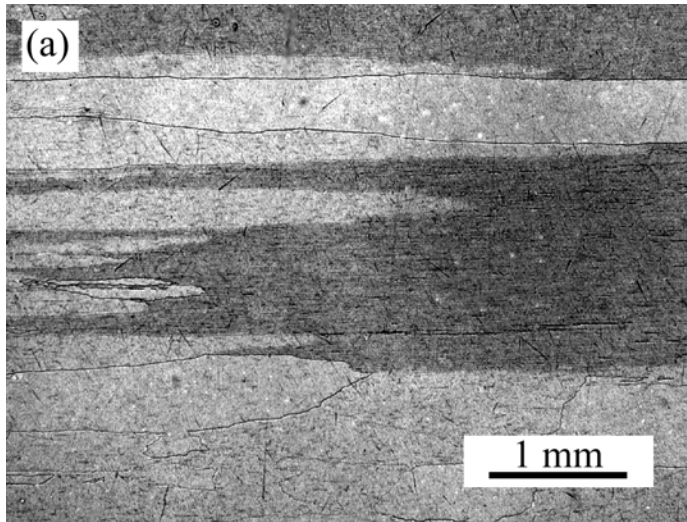

0% Sc

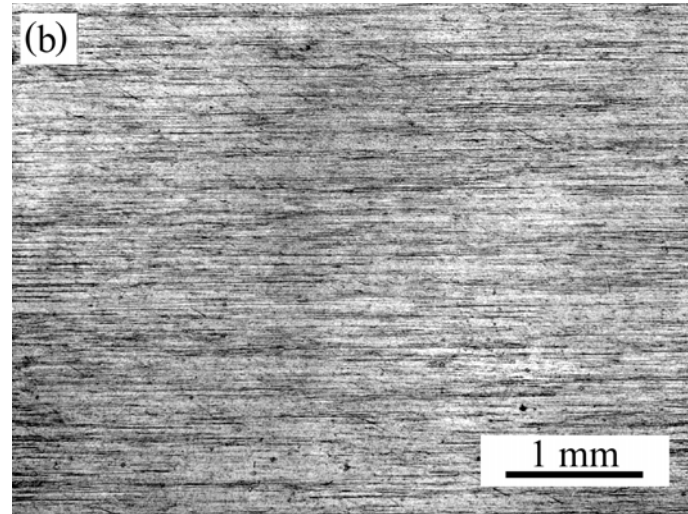

0.18% Sc



Extrusion



AF Research Laboratory / Materials and Manufacturing Directorate

Metals, Ceramics, and NDE Division

TEM microstructure of aged specimens

120C for 19 h

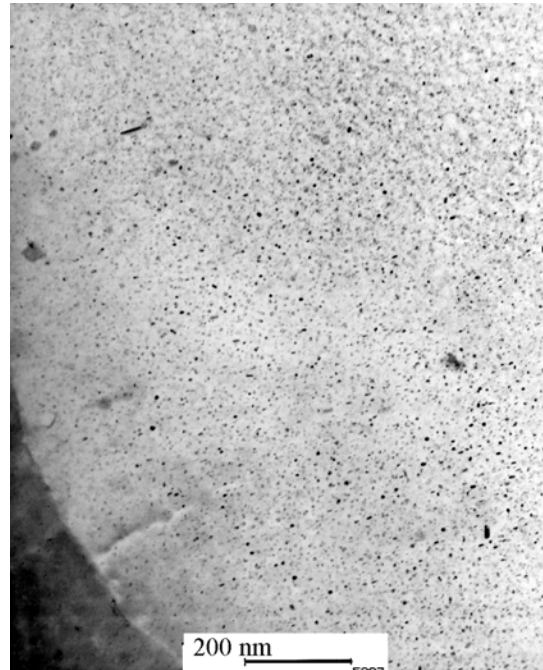

0.18%Sc

$d = 5-20 \text{ nm}$

$n = 10^{22}-10^{23} \text{ m}^{-3}$



Microstructure



AF Research Laboratory / Materials and Manufacturing Directorate

Metals, Ceramics, and NDE Division

Precipitations in a solution annealed and aged SSA018 alloy

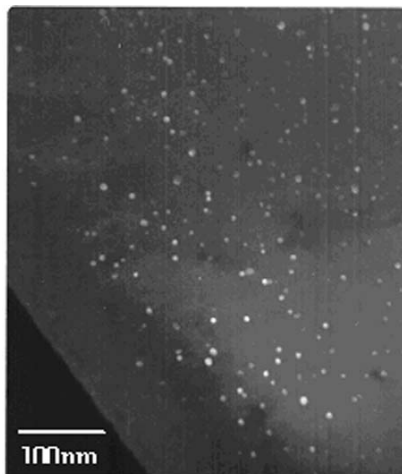

Solution annealed and water quenched
(L₁₂ coherent particles)

M. Mills, Ohio State U.

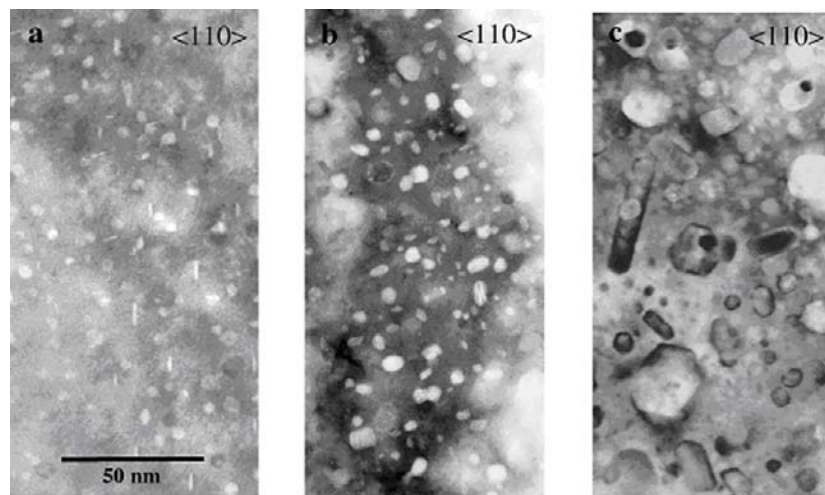
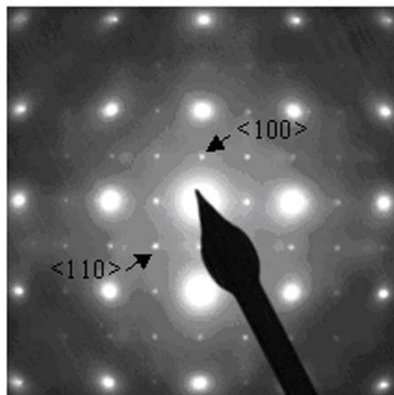

Bright field TEM images for the 0.18%Sc
alloy after aging for 1, 24 and 48 hours
(η MgZn₂ particles)



Extrusion



Tensile properties of extruded alloys

(Extrusion at 400°C, 16:1)

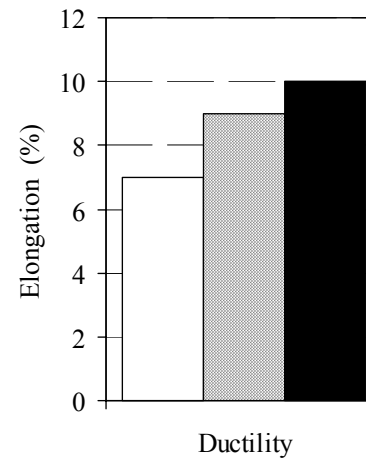
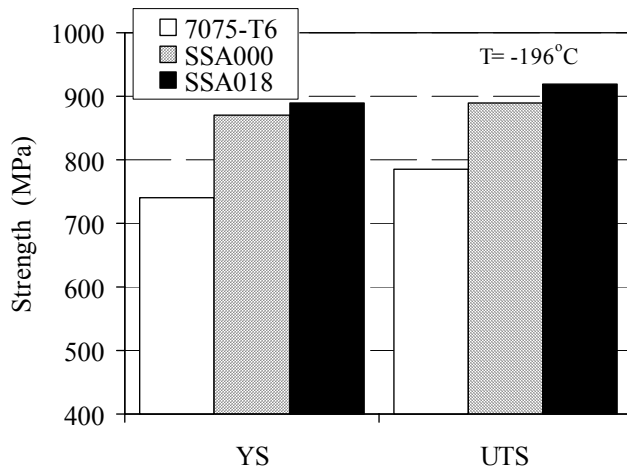
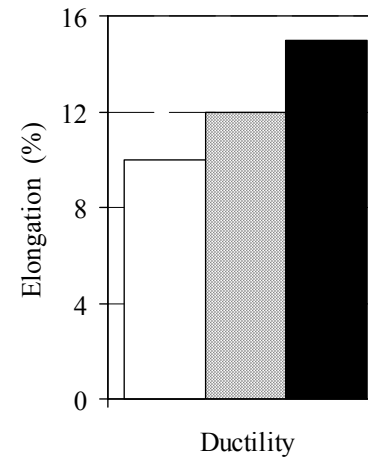
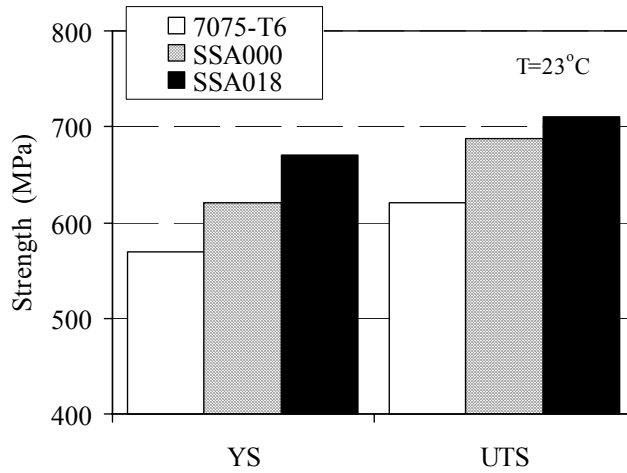



Forging



SSA018

Microstructure of forging



164 mm diameter
28 mm height

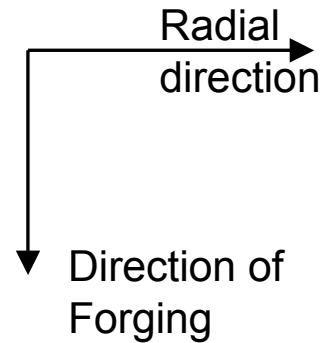
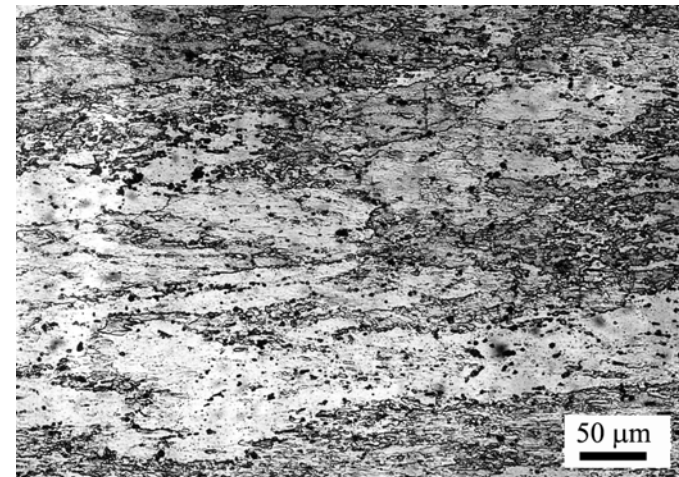
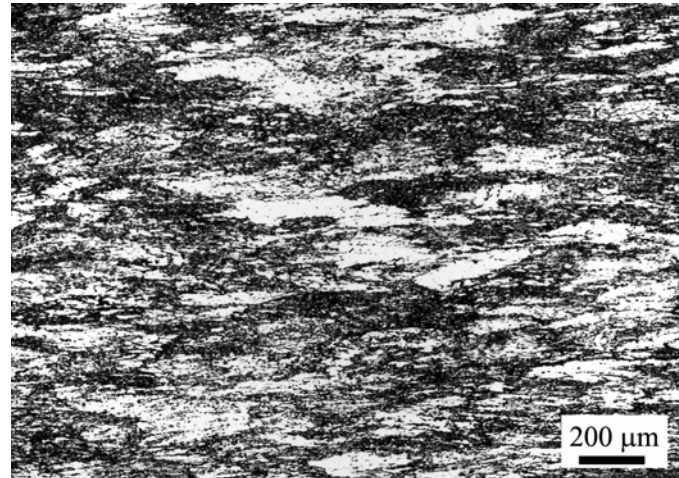



Forging



Tensile properties of forging

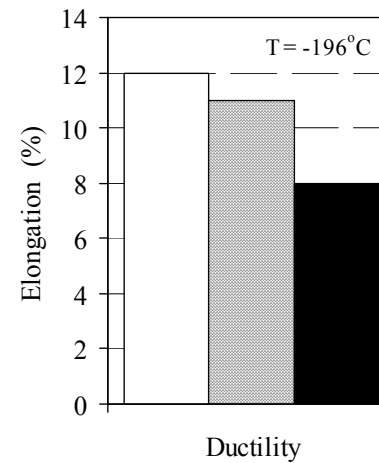
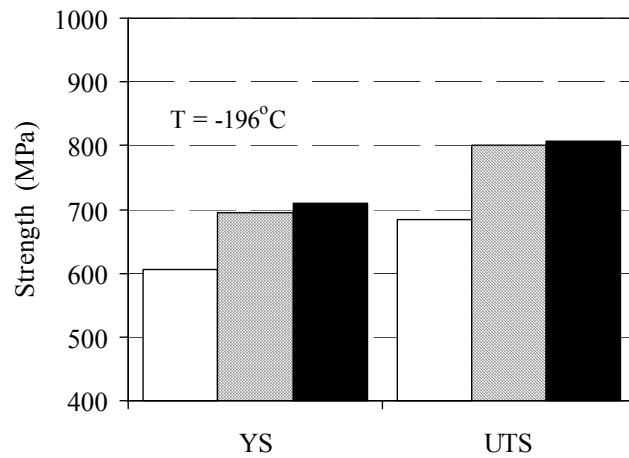
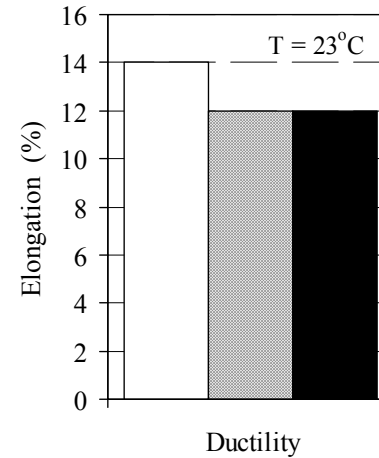
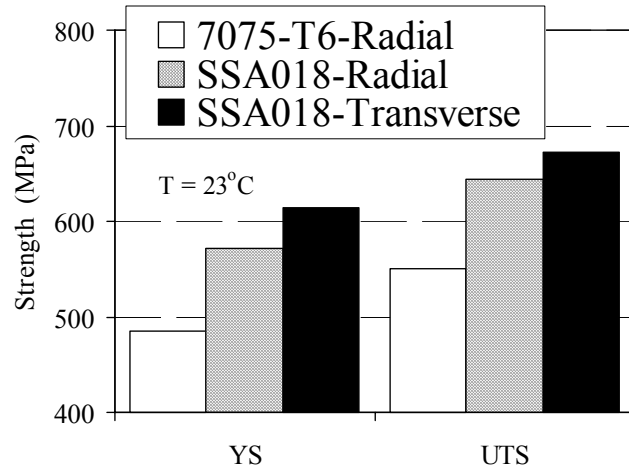



Cryogenic tensile properties (summary)



AF Research Laboratory / Materials and Manufacturing Directorate

Metals, Ceramics, and NDE Division

Cryogenic properties of SSA018 alloy
in cast, extruded and forged conditions after T6 temper

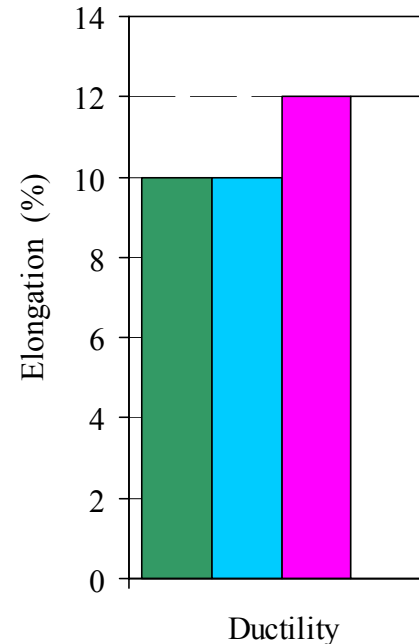
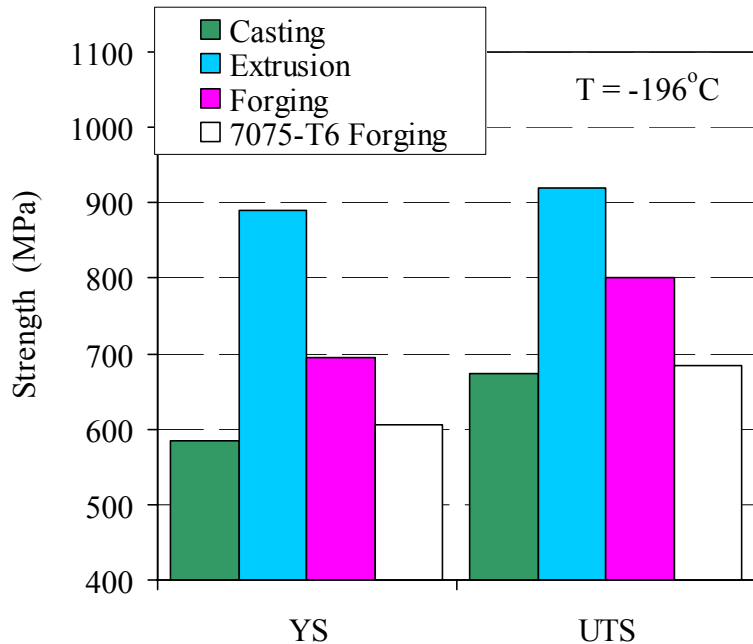



Conclusion



- Super-high strength cast and wrought Al alloys have been developed. The alloys belong to 7XXX series and contain increased amounts of dispersoid-forming (grain-refining) elements (Zr, Sc, Ti, Cr, Mn, etc.)
- The grain-refining elements refine microstructure of casting and retard recrystallization and grain growth during homogenization, hot working and solution treatment.
- The T6 tempered SSA018 alloy shows superior tensile strength at room and cryogenic temperatures, both in cast, extruded and forged conditions.
- High strength is a combined effect of fine η precipitates, dispersoids, solid solution elements, and fine grains.



Acknowledgements



AF Research Laboratory / Materials and Manufacturing Directorate

Metals, Ceramics, and NDE Division

- **Bob Wagstaff, Brent Bischoff**, Wagstaff Inc., Spokane, WA – DC casting
- **Joh Brown, Doug Barker**, MPL, AFRL/WPAFB (UES) – forging and extrusion
- **William Houston, Mike Scott**, UES Inc., - everyday technical support
- **Mike Mills**, Ohio State University – help with HR TEM
- **Daniel Miracle, Kevin Kendig**, AFRL/MLLMD; **Jonathan Spowart, Madan Mendiratta**, UES, Inc. – useful discussions
- **Raul Perez and Clif Bampton**, Boeing-Rocketdyne; **Yury Milman**, IPMS – sharing with ideas and results of their developments